

# **Win-Test Wiki**

# Table of Contents

<b><u>Main Page</u></b> .....	<b>1</b>
<u>Namespaces</u> .....	2
<u>Variants</u> .....	2
<u>Views</u> .....	2
<u>More</u> .....	2
<b><u>Preface</u></b> .....	<b>3</b>
<u>Mailing list</u> .....	3
<u>Namespaces</u> .....	3
<u>Variants</u> .....	3
<u>Views</u> .....	3
<u>More</u> .....	3
<b><u>Installation</u></b> .....	<b>4</b>
<u>Download the software</u> .....	4
<u>Install the software</u> .....	4
<u>Registering the software</u> .....	4
<u>Namespaces</u> .....	5
<u>Variants</u> .....	5
<u>Views</u> .....	5
<u>More</u> .....	5
<b><u>Configuration</u></b> .....	<b>6</b>
<u>One-time configuration</u> .....	6
<u>Pre-contest configuration</u> .....	6
<u>Namespaces</u> .....	6
<u>Variants</u> .....	6
<u>Views</u> .....	7
<u>More</u> .....	7
<b><u>Menus</u></b> .....	<b>8</b>
<u>Contents</u> .....	8
<u>File</u> .....	8
<u>Edit</u> .....	8
<u>Operating</u> .....	9
<u>Commands</u> .....	9
<u>Messages</u> .....	9
<u>Tools</u> .....	10
<u>Windows</u> .....	10
<u>Options</u> .....	10
<u>Help</u> .....	11
<u>Namespaces</u> .....	11
<u>Variants</u> .....	11
<u>Views</u> .....	11
<u>More</u> .....	11

# Table of Contents

<b>Menu:File new.....</b>	<b>12</b>
<u>Contents</u> .....	12
<u>New</u> .....	12
<u>Contest Configuration</u> .....	15
<u>Station Parameters</u> .....	16
<u>Contest Parameters</u> .....	16
<u>Network Parameters</u> .....	17
<u>Open</u> .....	17
<u>Corrupted Files</u> .....	19
<u>Import</u> .....	19
<u>Export</u> .....	20
<u>Merge Logs</u> .....	20
<u>Clean log</u> .....	22
<u>Cleaning</u> .....	22
<u>Time Shift</u> .....	23
<u>Resolving 10-Minute-Rule Violations</u> .....	23
<u>Quit</u> .....	23
<u>Namespaces</u> .....	23
<u>Variants</u> .....	23
<u>Views</u> .....	23
<u>More</u> .....	24
<b>Menu:File open.....</b>	<b>25</b>
<u>Contents</u> .....	25
<u>New</u> .....	25
<u>Open</u> .....	25
<u>Close</u> .....	25
<u>Create Log Files</u> .....	25
<u>Backup contest</u> .....	26
<u>Archive</u> .....	26
<u>Update database</u> .....	26
<u>Explore</u> .....	27
<u>Most Recently Used</u> .....	27
<u>Quit</u> .....	27
<u>Namespaces</u> .....	28
<u>Variants</u> .....	28
<u>Views</u> .....	28
<u>More</u> .....	28
<b>Menu:Edit.....</b>	<b>29</b>
<u>Contents</u> .....	29
<u>Restore QSO</u> .....	29
<u>Initialize QSO</u> .....	29
<u>Edit Date, Time, Freq. and Op. of QSO</u> .....	29
<u>Edit serial number</u> .....	30
<u>Delete QSO</u> .....	30
<u>Delete all QSO</u> .....	31
<u>Goto QSO</u> .....	31

# Table of Contents

## **Menu:Edit**

<u>Goto Callsign</u> .....	32
<u>Apply exchange to every QSO with</u> .....	32
<u>Move in my log only</u> .....	32
<u>Namespaces</u> .....	33
<u>Variants</u> .....	33
<u>Views</u> .....	33
<u>More</u> .....	33

## **Menu:Operating**.....34

<u>Contents</u> .....	34
<u>Listen to the primary radio</u> .....	34
<u>Listen to the secondary radio/headphone toggle</u> .....	34
<u>Listen to the secondary radio during transmit/headphone latch</u> .....	34
<u>Listen both radio/headphone split</u> .....	34
<u>Revert to automatic control</u> .....	35
<u>Technique</u> .....	35
<u>Modify the scenarios</u> .....	35
<u>Shift binds to the secondary radio</u> .....	36
<u>Caps Lock binds to the secondary radio</u> .....	36
<u>The second footswitch binds to the secondary radio</u> .....	36
<u>Namespaces</u> .....	36
<u>Variants</u> .....	36
<u>Views</u> .....	36
<u>More</u> .....	36

## **Menu:Commands**.....38

<u>Contents</u> .....	38
<u>QSY</u> .....	38
<u>One band down</u> .....	38
<u>One band up</u> .....	39
<u>Keyboard mode</u> .....	39
<u>CW Speed</u> .....	39
<u>CW Weight</u> .....	40
<u>Carrier</u> .....	40
<u>Split frequency</u> .....	40
<u>QSY frequency</u> .....	41
<u>QSY back to run frequency</u> .....	41
<u>Swap the frequency on both radios</u> .....	41
<u>Take a sked</u> .....	42
<u>Pass a station</u> .....	42
<u>Operator Login</u> .....	43
<u>Copy-paste the previous QSO</u> .....	44
<u>Receive OTC</u> .....	44
<u>Transmit OTC</u> .....	45
<u>Turn Antenna to Logged Call (Short Path)</u> .....	46
<u>Turn Antenna to Logged Call (Long Path)</u> .....	46
<u>DX-Cluster</u> .....	46

# Table of Contents

## **Menu:Commands**

<u>Spot...</u>	47
<u>Propagation forecast</u>	47
<u>Insert into BandMap</u>	49
<u>Active Radio</u>	49
<u>Station Type</u>	49
<u>CW/RTTY Messages</u>	50
<u>Remote commands...</u>	51
<u>Namespaces</u>	51
<u>Variants</u>	51
<u>Views</u>	51
<u>More</u>	52

## **Menu:Messages**.....53

<u>Contents</u>	53
<u>Send a Gab...</u>	53
<u>Reply to the last private gab...</u>	54
<u>Write a note regarding this QSO</u>	54
<u>Namespaces</u>	54
<u>Variants</u>	54
<u>Views</u>	54
<u>More</u>	54

## **Menu:Tools**.....55

<u>Contents</u>	55
<u>Automatic CQ repeat</u>	55
<u>Intelligent Quick QSL...</u>	56
<u>Redefine keyboard keys</u>	58
<u>Remapping [*] and [+] when using Notebook or Mini keyboard</u>	59
<u>Data entry</u>	60
<u>Exchange guessing</u>	60
<u>Callsign check</u>	61
<u>Priority</u>	61
<u>Enable ESM</u>	61
<u>Disable CW cut numbers translation</u>	62
<u>Remap Slash to /P</u>	62
<u>Enable Run/S&amp;P switching</u>	62
<u>Switch keyboard</u>	63
<u>Countdown timer</u>	63
<u>Scripts Manager</u>	64
<u>Introduction</u>	65
<u># Notation</u>	65
<u>Calling Scripts via Text Command</u>	66
<u>Automatically Executed Scripts</u>	66
<u>Synchronous vs. asynchronous - the #@ Notation</u>	66
<u>Tips for Programming</u>	67
<u>Basic Examples</u>	67
<u>Load a target file</u>	68

# Table of Contents

## **Menu:Tools**

<u>Export a target file</u> .....	68
<u>Check log</u> .....	70
<u>Time shifting</u> .....	73
<u>Correcting OP over a QSO range</u> .....	74
<u>Download Files through the Network</u> .....	75
<u>Namespaces</u> .....	75
<u>Variants</u> .....	75
<u>Views</u> .....	75
<u>More</u> .....	75

## **Menu:Windows.....76**

<u>Contents</u> .....	76
<u>Log Entry (Main window)</u> .....	77
<u>Worked Gridsquares</u> .....	79
<u>Worked Zones</u> .....	82
<u>Worked DXCC</u> .....	83
<u>Check Callsign</u> .....	84
<u>Check Multipliers</u> .....	84
<u>Search for Worked Multipliers or Partial QTH Locators</u> .....	85
<u>Check Partial</u> .....	87
<u>Check N + 1</u> .....	89
<u>Partner</u> .....	90
<u>Status</u> .....	93
<u>Skeds</u> .....	95
<u>Solar Activity</u> .....	96
<u>OSY Wizard</u> .....	97
<u>Extra Information</u> .....	98
<u>XDT Files</u> .....	98
<u>Directives</u> .....	99
<u>Summary</u> .....	100
<u>Live Score</u> .....	100
<u>Rate</u> .....	101
<u>Graphs</u> .....	102
<u>Text Information</u> .....	102
<u>Context Menu</u> .....	103
<u>Statistics</u> .....	103
<u>Gah</u> .....	107
<u>World Map</u> .....	108
<u>Radio 1, Radio 2 (Band Maps)</u> .....	111
<u>Band Maps Context menu</u> .....	113
<u>Secondary Radio</u> .....	122
<u>RTTY (radio1, radio2)</u> .....	122
<u>Rotators</u> .....	123
<u>DX-Cluster Monitor</u> .....	124
<u>DX-Cluster Announcements</u> .....	125
<u>NCDXF/IBP Beacons</u> .....	128
<u>Clock</u> .....	128

# Table of Contents

## **Menu:Windows**

<u>Contest Recorder</u> .....	129
<u>SSB bargraph</u> .....	130
<u>Close all Windows</u> .....	131
<u>Namespaces</u> .....	131
<u>Variants</u> .....	131
<u>Views</u> .....	131
<u>More</u> .....	131

## **Menu:Options.....132**

<u>Contents</u> .....	132
<u>Load contest at startup</u> .....	133
<u>Automatic backup</u> .....	134
<u>Disable log synchronization on network</u> .....	135
<u>CW</u> .....	135
<u>No sound</u> .....	137
<u>Initial Speed</u> .....	137
<u>Modify standard messages</u> .....	137
<u>Modify additional messages</u> .....	139
<u>Modify WAE messages</u> .....	140
<u>Custom variables</u> .....	141
<u>Serial number</u> .....	142
<u>Correction</u> .....	143
<u>Shortened spaces (CT spaces)</u> .....	143
<u>Auto sending</u> .....	143
<u>Remap keys in keyboard mode</u> .....	144
<u>Work dupes</u> .....	144
<u>Speed bursts</u> .....	144
<u>RTTY</u> .....	144
<u>Modify standard messages</u> .....	145
<u>Modify additional messages</u> .....	146
<u>Modify WAE messages</u> .....	147
<u>Custom variables</u> .....	148
<u>Configure interfaces</u> .....	148
<u>Serial Ports</u> .....	150
<u>Transceivers</u> .....	151
<u>Printer Ports</u> .....	151
<u>CW</u> .....	152
<u>Local Network</u> .....	152
<u>Network Protocol Advanced Settings</u> .....	152
<u>Voice Keyer</u> .....	154
<u>WinKey configuration</u> .....	154
<u>EZMaster configuration</u> .....	155
<u>CW Keyer</u> .....	156
<u>Radio set-up</u> .....	156
<u>Packet-Radio TNC</u> .....	156
<u>Antenna configuration according to RX/TX</u> .....	156
<u>MK/MKII/MK2R/u2R configuration</u> .....	158

# Table of Contents

## **Menu:Options**

<u>OTRSP configuration</u> .....	159
<u>RTTY configuration</u> .....	160
<u>Frequency Offsets</u> .....	161
<u>MP3 Configuration</u> .....	162
<u>Script Editor Configuration</u> .....	163
<u>Log</u> .....	164
<u>Fonts</u> .....	166
<u>Headers</u> .....	166
<u>Hide OSO numbers</u> .....	166
<u>Align Exchanges</u> .....	166
<u>Stay in field when moving up and down in the log</u> .....	166
<u>Block Cursor</u> .....	166
<u>Colors</u> .....	166
<u>New Contest Files Properties</u> .....	166
<u>DXpedition Info Field</u> .....	167
<u>Spot Warnings</u> .....	168
<u>DX Cluster</u> .....	168
<u>DX Cluster window shortcuts</u> .....	168
<u>Start/stop wtDxTelnet automatically</u> .....	168
<u>HamCAP</u> .....	169
<u>WAEDC</u> .....	172
<u>Data files</u> .....	173
<u>Country files</u> .....	174
<u>Master file</u> .....	174
<u>Exchanges Database</u> .....	175
<u>Default extra data files</u> .....	175
<u>Markers files</u> .....	176
<u>Segments files</u> .....	176
<u>Bandplans</u> .....	177
<u>Windows</u> .....	178
<u>Toolbar</u> .....	179
<u>Language</u> .....	179
<u>Namespaces</u> .....	180
<u>Variants</u> .....	180
<u>Views</u> .....	180
<u>More</u> .....	180

## **Menu:Help**.....181

<u>Contents</u> .....	181
<u>Register software</u> .....	181
<u>Use online documentation</u> .....	181
<u>Reference manual</u> .....	182
<u>Display text command tips for menu items</u> .....	182
<u>Win-Test Home Page</u> .....	182
<u>Documentation Wiki Home Page</u> .....	182
<u>About</u> .....	182
<u>Namespaces</u> .....	183



# Table of Contents

## **Menu:Help**

<u>Variants</u> .....	183
<u>Views</u> .....	183
<u>More</u> .....	183

## **SO2R/Advanced SO2R**.....**184**

<u>Contents</u> .....	184
<u>Using 'advanced SO2R' Mode</u> .....	184
<u>Required Hardware</u> .....	184
<u>Understanding basic concepts</u> .....	184
<u>Moments of a OSQ</u> .....	184
<u>Setting up scenarios</u> .....	185
<u>Some typical Variables used in Scenario Settings</u> .....	187
<u>See also</u> .....	187
<u>External sources</u> .....	187
<u>Namespaces</u> .....	187
<u>Variants</u> .....	187
<u>Views</u> .....	188
<u>More</u> .....	188

## **SO2R/Advanced SO2R**.....**189**

<u>Contents</u> .....	189
<u>Using 'advanced SO2R' Mode</u> .....	189
<u>Required Hardware</u> .....	189
<u>Understanding basic concepts</u> .....	189
<u>Moments of a OSQ</u> .....	189
<u>Setting up scenarios</u> .....	190
<u>Some typical Variables used in Scenario Settings</u> .....	192
<u>See also</u> .....	192
<u>External sources</u> .....	192
<u>Namespaces</u> .....	192
<u>Variants</u> .....	192
<u>Views</u> .....	193
<u>More</u> .....	193

## **API**.....**194**

<u>Contents</u> .....	194
<u>List of Win-Test API Functions</u> .....	194
<u>Win-Test API Variables</u> .....	202
<u>Win-Test API Constants</u> .....	203
<u>Advanced Programming Examples</u> .....	207
<u>Namespaces</u> .....	213
<u>Variants</u> .....	213
<u>Views</u> .....	213
<u>More</u> .....	214

# Table of Contents

<b><u>API</u></b> .....	<b>215</b>
<u>Contents</u> .....	215
<u>List of Win-Test API Functions</u> .....	215
<u>Win-Test API Variables</u> .....	223
<u>Win-Test API Constants</u> .....	224
<u>Advanced Programming Examples</u> .....	228
<u>Namespaces</u> .....	234
<u>Variants</u> .....	234
<u>Views</u> .....	234
<u>More</u> .....	235
<b><u>SO1R/Band Map</u></b> .....	<b>236</b>
<u>Band Map</u> .....	236
<u>See also</u> .....	236
<u>Namespaces</u> .....	236
<u>Variants</u> .....	236
<u>Views</u> .....	236
<u>More</u> .....	237
<b><u>SO1R/Band Map</u></b> .....	<b>238</b>
<u>Band Map</u> .....	238
<u>See also</u> .....	238
<u>Namespaces</u> .....	238
<u>Variants</u> .....	238
<u>Views</u> .....	238
<u>More</u> .....	239
<b><u>BestPractice10</u></b> .....	<b>240</b>
<u>Contents</u> .....	240
<u>Setting up the ICOM IC-7851 + microKeyer MK III</u> .....	240
<u>ICOM IC-7581</u> .....	240
<u>microHAM MKII</u> .....	241
<u>microHAM USB Device Router</u> .....	241
<u>MMTTY</u> .....	249
<u>Win-Test</u> .....	255
<u>Namespaces</u> .....	257
<u>Variants</u> .....	257
<u>Views</u> .....	257
<u>More</u> .....	257
<b><u>BestPractice10</u></b> .....	<b>258</b>
<u>Contents</u> .....	258
<u>Setting up the ICOM IC-7851 + microKeyer MK III</u> .....	258
<u>ICOM IC-7581</u> .....	258
<u>microHAM MKII</u> .....	259
<u>microHAM USB Device Router</u> .....	259
<u>MMTTY</u> .....	267
<u>Win-Test</u> .....	273

# Table of Contents

<b><u>BestPractice10</u></b>	
<u>Namespaces</u>	275
<u>Variants</u>	275
<u>Views</u>	275
<u>More</u>	275
<b><u>BestPractice1</u></b>	<b>276</b>
<u>Contents</u>	276
<u>Getting ready for a RTTY Contest</u>	276
<u>Kenwood TS-850 settings</u>	276
<u>Yaesu FT-1000MP settings</u>	276
<u>MMTTY settings for FT-1000MP</u>	277
<u>microHAM USB Interface II</u>	277
<u>mircoHAM USB Device Router</u>	278
<u>MMTTY</u>	280
<u>Win-Test</u>	285
<u>See also</u>	286
<u>Namespaces</u>	286
<u>Variants</u>	286
<u>Views</u>	286
<u>More</u>	286
<b><u>Best Practice</u></b>	<b>287</b>
<u>Namespaces</u>	287
<u>Variants</u>	287
<u>Views</u>	287
<u>More</u>	287
<b><u>BestPractice1</u></b>	<b>288</b>
<u>Contents</u>	288
<u>Getting ready for a RTTY Contest</u>	288
<u>Kenwood TS-850 settings</u>	288
<u>Yaesu FT-1000MP settings</u>	288
<u>MMTTY settings for FT-1000MP</u>	289
<u>microHAM USB Interface II</u>	289
<u>mircoHAM USB Device Router</u>	290
<u>MMTTY</u>	292
<u>Win-Test</u>	297
<u>See also</u>	298
<u>Namespaces</u>	298
<u>Variants</u>	298
<u>Views</u>	298
<u>More</u>	298
<b><u>BestPractice2</u></b>	<b>299</b>
<u>Contents</u>	299
<u>Setting up an Icom IC-736 with the microHAM USB Interface II</u>	299
<u>Icom IC-736 settings</u>	299

# Table of Contents

<b><u>BestPractice2</u></b>	
<u>microHAM USB Interface II</u>	299
<u>mircoHAM USB Device Router</u>	299
<u>Win-Test</u>	300
<u>See also</u>	300
<u>Namespaces</u>	300
<u>Variants</u>	300
<u>Views</u>	300
<u>More</u>	300
<b><u>BestPractice2</u></b>	<b>302</b>
<u>Contents</u>	302
<u>Setting up an Icom IC-736 with the microHAM USB Interface II</u>	302
<u>Icom IC-736 settings</u>	302
<u>microHAM USB Interface II</u>	302
<u>mircoHAM USB Device Router</u>	302
<u>Win-Test</u>	303
<u>See also</u>	303
<u>Namespaces</u>	303
<u>Variants</u>	303
<u>Views</u>	303
<u>More</u>	303
<b><u>BestPractice3</u></b>	<b>305</b>
<u>Contents</u>	305
<u>Setting up an Icom IC-275H with the microHAM USB Interface IC</u>	305
<u>Icom IC-275 settings</u>	305
<u>microHAM USB Interface IC</u>	305
<u>mircoHAM USB Device Router</u>	306
<u>Win-Test</u>	307
<u>See also</u>	308
<u>Namespaces</u>	309
<u>Variants</u>	309
<u>Views</u>	309
<u>More</u>	309
<b><u>BestPractice3</u></b>	<b>310</b>
<u>Contents</u>	310
<u>Setting up an Icom IC-275H with the microHAM USB Interface IC</u>	310
<u>Icom IC-275 settings</u>	310
<u>microHAM USB Interface IC</u>	310
<u>mircoHAM USB Device Router</u>	311
<u>Win-Test</u>	312
<u>See also</u>	313
<u>Namespaces</u>	314
<u>Variants</u>	314
<u>Views</u>	314
<u>More</u>	314

# Table of Contents

<b><u>BestPractice4</u></b> .....	<b>315</b>
<u>Contents</u> .....	315
<u>Setting up an Kenwood TS-850S with the microHAM microKeyer</u> .....	315
<u>Kenwood TS-850 settings</u> .....	315
<u>microHAM micro Keyer</u> .....	315
<u>microHAM USB Device Router</u> .....	316
<u>MMTTY</u> .....	323
<u>Win-Test</u> .....	329
<u>Namespaces</u> .....	331
<u>Variants</u> .....	331
<u>Views</u> .....	331
<u>More</u> .....	331
<b><u>BestPractice4</u></b> .....	<b>332</b>
<u>Contents</u> .....	332
<u>Setting up an Kenwood TS-850S with the microHAM microKeyer</u> .....	332
<u>Kenwood TS-850 settings</u> .....	332
<u>microHAM micro Keyer</u> .....	332
<u>microHAM USB Device Router</u> .....	333
<u>MMTTY</u> .....	340
<u>Win-Test</u> .....	346
<u>Namespaces</u> .....	348
<u>Variants</u> .....	348
<u>Views</u> .....	348
<u>More</u> .....	348
<b><u>BestPractice5</u></b> .....	<b>349</b>
<u>Contents</u> .....	349
<u>Setting up a Kenwood TS-850S with the microHAM microKeyer II</u> .....	349
<u>Kenwood TS-850 settings</u> .....	349
<u>microHAM MKII</u> .....	349
<u>microHAM USB Device Router</u> .....	350
<u>MMTTY</u> .....	358
<u>Win-Test</u> .....	364
<u>Namespaces</u> .....	366
<u>Variants</u> .....	366
<u>Views</u> .....	366
<u>More</u> .....	366
<b><u>BestPractice5</u></b> .....	<b>367</b>
<u>Contents</u> .....	367
<u>Setting up a Kenwood TS-850S with the microHAM microKeyer II</u> .....	367
<u>Kenwood TS-850 settings</u> .....	367
<u>microHAM MKII</u> .....	367
<u>microHAM USB Device Router</u> .....	368
<u>MMTTY</u> .....	376
<u>Win-Test</u> .....	382
<u>Namespaces</u> .....	384

# Table of Contents

<b><u>BestPractice5</u></b>	
<u>Variants</u>	384
<u>Views</u>	384
<u>More</u>	384
<b><u>BestPractice6</u></b>	<b>385</b>
<u>Contents</u>	385
<u>Setting up a Yaesu FT-1000D with the microHAM microKeyer II</u>	385
<u>Yaesu FT-1000D</u>	385
<u>microHAM MKII</u>	385
<u>microHAM USB Device Router</u>	386
<u>MMTTY</u>	393
<u>Win-Test</u>	399
<u>Namespaces</u>	401
<u>Variants</u>	401
<u>Views</u>	401
<u>More</u>	401
<b><u>BestPractice6</u></b>	<b>402</b>
<u>Contents</u>	402
<u>Setting up a Yaesu FT-1000D with the microHAM microKeyer II</u>	402
<u>Yaesu FT-1000D</u>	402
<u>microHAM MKII</u>	402
<u>microHAM USB Device Router</u>	403
<u>MMTTY</u>	410
<u>Win-Test</u>	416
<u>Namespaces</u>	418
<u>Variants</u>	418
<u>Views</u>	418
<u>More</u>	418
<b><u>BestPractice7</u></b>	<b>419</b>
<u>Contents</u>	419
<u>Setting up the Yaesu FTDX-101</u>	419
<u>Yaesu FTDX-101</u>	424
<u>MMTTY Setup</u>	424
<u>MMTTY Test</u>	431
<u>Win-Test</u>	431
<u>Namespaces</u>	433
<u>Variants</u>	433
<u>Views</u>	433
<u>More</u>	433
<b><u>BestPractice7</u></b>	<b>434</b>
<u>Contents</u>	434
<u>Setting up the Yaesu FTDX-101</u>	434
<u>Yaesu FTDX-101</u>	439
<u>MMTTY Setup</u>	439

# Table of Contents

<b><u>BestPractice7</u></b>	
<u>MMTTY Test</u>	446
<u>Win-Test</u>	446
<u>Namespaces</u>	448
<u>Variants</u>	448
<u>Views</u>	448
<u>More</u>	448
<b><u>BestPractice8</u></b>	<b>449</b>
<u>Contents</u>	449
<u>Setting up the ICOM IC-7410 + microKeyer MKII</u>	449
<u>ICOM IC-7410</u>	449
<u>microHAM MKII</u>	450
<u>microHAM USB Device Router</u>	450
<u>MMTTY</u>	458
<u>Win-Test</u>	464
<u>Namespaces</u>	466
<u>Variants</u>	466
<u>Views</u>	466
<u>More</u>	466
<b><u>BestPractice8</u></b>	<b>467</b>
<u>Contents</u>	467
<u>Setting up the ICOM IC-7410 + microKeyer MKII</u>	467
<u>ICOM IC-7410</u>	467
<u>microHAM MKII</u>	468
<u>microHAM USB Device Router</u>	468
<u>MMTTY</u>	476
<u>Win-Test</u>	482
<u>Namespaces</u>	484
<u>Variants</u>	484
<u>Views</u>	484
<u>More</u>	484
<b><u>BestPractice9</u></b>	<b>485</b>
<u>Setting up the KX3 for CW Operation</u>	485
<u>Namespaces</u>	485
<u>Variants</u>	485
<u>Views</u>	485
<u>More</u>	485
<b><u>BestPractice9</u></b>	<b>486</b>
<u>Setting up the KX3 for CW Operation</u>	486
<u>Namespaces</u>	486
<u>Variants</u>	486
<u>Views</u>	486
<u>More</u>	486

# Table of Contents

<b><u>Best Practice</u></b> .....	<b>487</b>
<u>Namespaces</u> .....	487
<u>Variants</u> .....	487
<u>Views</u> .....	487
<u>More</u> .....	487
<b><u>SO2R/Caps Lock bind to the secondary radio</u></b> .....	<b>488</b>
<u>Namespaces</u> .....	488
<u>Variants</u> .....	488
<u>Views</u> .....	488
<u>More</u> .....	488
<b><u>SO2R/Caps Lock bind to the secondary radio</u></b> .....	<b>489</b>
<u>Namespaces</u> .....	489
<u>Variants</u> .....	489
<u>Views</u> .....	489
<u>More</u> .....	489
<b><u>Index of /pdf/daily</u></b> .....	<b>490</b>
<b><u>Index of /pdf/downloads</u></b> .....	<b>492</b>
<b><u>Index of /pdf</u></b> .....	<b>493</b>
<b><u>Index of /pdf/daily</u></b> .....	<b>494</b>
<b><u>Index of /pdf/downloads</u></b> .....	<b>496</b>
<b><u>Index of /pdf</u></b> .....	<b>497</b>
<b><u>Check Partial and Np1 Files</u></b> .....	<b>498</b>
<u>Contents</u> .....	498
<u>Check Partial and N+1 Files</u> .....	498
<u>Location</u> .....	499
<u>Naming Convention</u> .....	500
<u>Search order</u> .....	500
<u>Files names list</u> .....	501
<u>Namespaces</u> .....	502
<u>Variants</u> .....	503
<u>Views</u> .....	503
<u>More</u> .....	503
<b><u>Check Partial and Np1 Files</u></b> .....	<b>504</b>
<u>Contents</u> .....	504
<u>Check Partial and N+1 Files</u> .....	504
<u>Location</u> .....	505
<u>Naming Convention</u> .....	506
<u>Search order</u> .....	506



# Table of Contents

## **Check Partial and Np1 Files**

<u>Files names list</u> .....	507
<u>Namespaces</u> .....	508
<u>Variants</u> .....	509
<u>Views</u> .....	509
<u>More</u> .....	509

## **Multi-op/Clearing all logs before the start.....510**

<u>Saving the Practice Log</u> .....	510
<u>Using the Remote Commands dialog to clear the log on all networked machines</u> .....	510
<u>See also</u> .....	511
<u>Namespaces</u> .....	511
<u>Variants</u> .....	511
<u>Views</u> .....	511
<u>More</u> .....	511

## **Multi-op/Clearing all logs before the start.....512**

<u>Saving the Practice Log</u> .....	512
<u>Using the Remote Commands dialog to clear the log on all networked machines</u> .....	512
<u>See also</u> .....	513
<u>Namespaces</u> .....	513
<u>Variants</u> .....	513
<u>Views</u> .....	513
<u>More</u> .....	513

## **SO1R/Cluster.....514**

<u>Contents</u> .....	514
<u>Use of Cluster Spots</u> .....	514
<u>New Multipliers</u> .....	514
<u>New Stations</u> .....	514
<u>Orientation</u> .....	514
<u>Namespaces</u> .....	515
<u>Variants</u> .....	515
<u>Views</u> .....	515
<u>More</u> .....	515

## **SO1R/Cluster.....516**

<u>Contents</u> .....	516
<u>Use of Cluster Spots</u> .....	516
<u>New Multipliers</u> .....	516
<u>New Stations</u> .....	516
<u>Orientation</u> .....	516
<u>Namespaces</u> .....	517
<u>Variants</u> .....	517
<u>Views</u> .....	517
<u>More</u> .....	517

# Table of Contents

<b><u>Index of /pdf/daily</u></b> .....	<b>518</b>
<b><u>Index of /pdf/downloads</u></b> .....	<b>520</b>
<b><u>Index of /pdf</u></b> .....	<b>521</b>
<b><u>Index of /pdf/downloads</u></b> .....	<b>522</b>
<b><u>Index of /pdf</u></b> .....	<b>523</b>
<b><u>Index of /pdf/daily</u></b> .....	<b>524</b>
<b><u>Index of /pdf/daily</u></b> .....	<b>526</b>
<b><u>Index of /pdf/downloads</u></b> .....	<b>528</b>
<b><u>Index of /pdf</u></b> .....	<b>529</b>
<b><u>Index of /pdf/daily</u></b> .....	<b>530</b>
<b><u>Index of /pdf/downloads</u></b> .....	<b>532</b>
<b><u>Index of /pdf</u></b> .....	<b>533</b>
<b><u>Configuration</u></b> .....	<b>534</b>
<u>One-time configuration</u> .....	534
<u>Pre-contest configuration</u> .....	534
<u>Namespaces</u> .....	534
<u>Variants</u> .....	534
<u>Views</u> .....	535
<u>More</u> .....	535
<b><u>Contest specific behaviour</u></b> .....	<b>536</b>
<u>Namespaces</u> .....	537
<u>Variants</u> .....	537
<u>Views</u> .....	537
<u>More</u> .....	537
<b><u>Contest specific behaviour</u></b> .....	<b>538</b>
<u>Namespaces</u> .....	539
<u>Variants</u> .....	539
<u>Views</u> .....	539
<u>More</u> .....	539
<b><u>Creating</u></b> .....	<b>540</b>
<u>Contents</u> .....	540
<u>Creating</u> .....	540
<u>Cabrillo</u> .....	541

# Table of Contents

## **Creating**

<u>Reg1Test</u> .....	542
<u>ADIF</u> .....	543
<u>LogSearch</u> .....	543
<u>Text and CSV Files</u> .....	544
<u>Namespaces</u> .....	545
<u>Variants</u> .....	545
<u>Views</u> .....	545
<u>More</u> .....	545

## **Creating.....546**

<u>Contents</u> .....	546
<u>Creating</u> .....	546
<u>Cabrillo</u> .....	547
<u>Reg1Test</u> .....	548
<u>ADIF</u> .....	549
<u>LogSearch</u> .....	549
<u>Text and CSV Files</u> .....	550
<u>Namespaces</u> .....	551
<u>Variants</u> .....	551
<u>Views</u> .....	551
<u>More</u> .....	551

## **Index of /pdf/daily.....552**

## **Index of /pdf/downloads.....554**

## **Index of /pdf.....555**

## **Index of /pdf.....556**

## **Index of /pdf/daily.....557**

## **Index of /pdf/downloads.....559**

## **SO1R/CW Voice Keyer.....560**

<u>Contents</u> .....	560
<u>SO1R/CW and Voice Keyer</u> .....	560
<u>Automated CW Keying</u> .....	560
<u>Voice Keyer</u> .....	561
<u>RTTY Keying</u> .....	562
<u>The Autorepeat Function</u> .....	563
<u>Namespaces</u> .....	563
<u>Variants</u> .....	563
<u>Views</u> .....	563
<u>More</u> .....	563

# Table of Contents

<b><u>SO1R/CW Voice Keyer</u></b> .....	<b>564</b>
<u>Contents</u> .....	564
<u>SO1R/CW and Voice Keyer</u> .....	564
<u>Automated CW Keying</u> .....	564
<u>Voice Keyer</u> .....	565
<u>RTTY Keying</u> .....	566
<u>The Autorepeat Function</u> .....	567
<u>Namespaces</u> .....	567
<u>Variants</u> .....	567
<u>Views</u> .....	567
<u>More</u> .....	567
<b><u>Index of /pdf/daily</u></b> .....	<b>568</b>
<b><u>Database Files</u></b> .....	<b>570</b>
<u>Contents</u> .....	570
<u>Country Files/Mult Files</u> .....	570
<u>Mult Equivalence Files</u> .....	571
<u>Exchange Databases</u> .....	571
<u>Installing a Database file</u> .....	572
<u>Downloading</u> .....	572
<u>Installing</u> .....	572
<u>Updating</u> .....	572
<u>Exchange Guessing</u> .....	573
<u>Setting up Exchange Guessing in Win-Test</u> .....	573
<u>Exchange Guessing in VHF/UHF/SHF Contests</u> .....	576
<u>A note about Exchange Guessing</u> .....	576
<u>Brewing your own Database file</u> .....	576
<u>See also</u> .....	577
<u>Namespaces</u> .....	578
<u>Variants</u> .....	578
<u>Views</u> .....	578
<u>More</u> .....	578
<b><u>Database Files</u></b> .....	<b>579</b>
<u>Contents</u> .....	579
<u>Country Files/Mult Files</u> .....	579
<u>Mult Equivalence Files</u> .....	580
<u>Exchange Databases</u> .....	580
<u>Installing a Database file</u> .....	581
<u>Downloading</u> .....	581
<u>Installing</u> .....	581
<u>Updating</u> .....	581
<u>Exchange Guessing</u> .....	582
<u>Setting up Exchange Guessing in Win-Test</u> .....	582
<u>Exchange Guessing in VHF/UHF/SHF Contests</u> .....	585
<u>A note about Exchange Guessing</u> .....	585
<u>Brewing your own Database file</u> .....	585

# Table of Contents

<b><u>Database Files</u></b>	
<u>See also</u> .....	586
<u>Namespaces</u> .....	587
<u>Variants</u> .....	587
<u>Views</u> .....	587
<u>More</u> .....	587
<b><u>Multi-op/Deleting QSO</u></b> .....	<b>588</b>
<u>Deleting a QSO mid-contest in a multi-op situation</u> .....	588
<u>Namespaces</u> .....	588
<u>Variants</u> .....	588
<u>Views</u> .....	588
<u>More</u> .....	588
<b><u>Main Page</u></b> .....	<b>589</b>
<u>Namespaces</u> .....	590
<u>Variants</u> .....	590
<u>Views</u> .....	590
<u>More</u> .....	590
<b><u>Main Page</u></b> .....	<b>591</b>
<u>Namespaces</u> .....	592
<u>Variants</u> .....	592
<u>Views</u> .....	592
<u>More</u> .....	592
<b><u>Index of /pdf/downloads</u></b> .....	<b>593</b>
<b><u>DVK CW RTTY Messaging</u></b> .....	<b>594</b>
<u>Contents</u> .....	594
<u>Configuring CW/RTTY messages</u> .....	594
<u>Additional CW/RTTY messages</u> .....	595
<u>Variables for use with CW/RTTY messages</u> .....	595
<u>Saving/Loading from *.msg file</u> .....	596
<u>Advanced SO2R specifics</u> .....	596
<u>RTTY Message Tips</u> .....	597
<u>Configuring the Win-Test DVK messages</u> .....	598
<u>Text commands related to the DVK functionality</u> .....	599
<u>Recording your messages in a separate application</u> .....	599
<u>Using the microHAM DVK</u> .....	599
<u>See Also</u> .....	604
<u>Namespaces</u> .....	604
<u>Variants</u> .....	604
<u>Views</u> .....	604
<u>More</u> .....	604

# Table of Contents

<b><u>DVK CW RTTY Messaging</u></b> .....	<b>605</b>
<u>Contents</u> .....	605
<u>Configuring CW/RTTY messages</u> .....	605
<u>Additional CW/RTTY messages</u> .....	606
<u>Variables for use with CW/RTTY messages</u> .....	606
<u>Saving/Loading from *.smmsg file</u> .....	607
<u>Advanced SO2R specifics</u> .....	607
<u>RTTY Message Tips</u> .....	608
<u>Configuring the Win-Test DVK messages</u> .....	609
<u>Text commands related to the DVK functionality</u> .....	610
<u>Recording your messages in a separate application</u> .....	610
<u>Using the microHAM DVK</u> .....	610
<u>See Also</u> .....	615
<u>Namespaces</u> .....	615
<u>Variants</u> .....	615
<u>Views</u> .....	615
<u>More</u> .....	615
<b><u>DX Cluster</u></b> .....	<b>616</b>
<u>Namespaces</u> .....	616
<u>Variants</u> .....	616
<u>Views</u> .....	616
<u>More</u> .....	616
<b><u>DX Cluster</u></b> .....	<b>617</b>
<u>Namespaces</u> .....	617
<u>Variants</u> .....	617
<u>Views</u> .....	617
<u>More</u> .....	617
<b><u>DXpedition</u></b> .....	<b>618</b>
<u>Using Win-Test on a DXpedition</u> .....	618
<u>Namespaces</u> .....	618
<u>Variants</u> .....	619
<u>Views</u> .....	619
<u>More</u> .....	619
<b><u>DXpedition</u></b> .....	<b>620</b>
<u>Using Win-Test on a DXpedition</u> .....	620
<u>Namespaces</u> .....	620
<u>Variants</u> .....	621
<u>Views</u> .....	621
<u>More</u> .....	621
<b><u>Multi-op/Issues/Editing serials</u></b> .....	<b>622</b>
<u>Overcoming out-of-sync scenarios</u> .....	622
<u>Editing serial numbers</u> .....	622
<u>Preventing crashes mid-contest</u> .....	622

# Table of Contents

## **Multi-op/Issues/Editing serials**

<u>Namespaces</u> .....	623
<u>Variants</u> .....	623
<u>Views</u> .....	623
<u>More</u> .....	623

## **Extracting log Information.....624**

<u>Log Breakdown</u> .....	624
<u>Namespaces</u> .....	626
<u>Variants</u> .....	626
<u>Views</u> .....	626
<u>More</u> .....	626

## **Extracting log Information.....627**

<u>Log Breakdown</u> .....	627
<u>Namespaces</u> .....	629
<u>Variants</u> .....	629
<u>Views</u> .....	629
<u>More</u> .....	629

## **SO2R/EZMaster.....630**

<u>Contents</u> .....	630
<u>Setting up the EZMaster for use with Win-Test</u> .....	630
<u>Setting up the technique</u> .....	630
<u>Setting up the [Shift] key for secondary radio</u> .....	630
<u>Setting up the [Caps Lock] key for secondary radio</u> .....	630
<u>Setting the SO2R Control box</u> .....	630
<u>See also</u> .....	630
<u>External sources</u> .....	631
<u>Namespaces</u> .....	631
<u>Variants</u> .....	631
<u>Views</u> .....	631
<u>More</u> .....	631

## **SO2R/EZMaster.....632**

<u>Contents</u> .....	632
<u>Setting up the EZMaster for use with Win-Test</u> .....	632
<u>Setting up the technique</u> .....	632
<u>Setting up the [Shift] key for secondary radio</u> .....	632
<u>Setting up the [Caps Lock] key for secondary radio</u> .....	632
<u>Setting the SO2R Control box</u> .....	632
<u>See also</u> .....	632
<u>External sources</u> .....	633
<u>Namespaces</u> .....	633
<u>Variants</u> .....	633
<u>Views</u> .....	633
<u>More</u> .....	633

# Table of Contents

<b><u>FAQ:DX Cluster and wtDxTelnet</u></b> .....	<b>634</b>
<u>Contents</u> .....	634
<u>Why don't I see any packet spots in Win-Test?</u> .....	634
<u>Why do I see lots of cluster traffic in the Alt-O window, but only a few spots in the band map?</u> .....	634
<u>How can I connect to other DX Clusters?</u> .....	635
<u>Why do I see many duplicate packet spots in Win-Test?</u> .....	635
<u>Can I make wtDxTelnet start automatically when I start Win-Test?</u> .....	635
<u>Can I connect to more than one cluster or to both CW Skimmer and a cluster?</u> .....	635
<u>Can I make multiple copies of wtDxTelnet start automatically and connect to different clusters?</u> .....	636
<u>Namespaces</u> .....	636
<u>Variants</u> .....	636
<u>Views</u> .....	636
<u>More</u> .....	636
<b><u>FAQ:DX Cluster and wtDxTelnet</u></b> .....	<b>637</b>
<u>Contents</u> .....	637
<u>Why don't I see any packet spots in Win-Test?</u> .....	637
<u>Why do I see lots of cluster traffic in the Alt-O window, but only a few spots in the band map?</u> .....	637
<u>How can I connect to other DX Clusters?</u> .....	638
<u>Why do I see many duplicate packet spots in Win-Test?</u> .....	638
<u>Can I make wtDxTelnet start automatically when I start Win-Test?</u> .....	638
<u>Can I connect to more than one cluster or to both CW Skimmer and a cluster?</u> .....	638
<u>Can I make multiple copies of wtDxTelnet start automatically and connect to different clusters?</u> .....	639
<u>Namespaces</u> .....	639
<u>Variants</u> .....	639
<u>Views</u> .....	639
<u>More</u> .....	639
<b><u>FAQ:Licensing</u></b> .....	<b>640</b>
<u>Contents</u> .....	640
<u>I bought Win-Test on the web with my PayPal account since several days, but I haven't received any CD-ROM ! What's wrong ?</u> .....	640
<u>I bought Win-Test on the web with my PayPal account since several days, but I haven't received my registration key ! What's wrong ?</u> .....	640
<u>I received your automatic email, but my registration key is not in ! What's wrong ?</u> .....	641
<u>I went to your registration page but the form requires a computer code. I totally dismantled my computer and I can't find it. Where is it located ?</u> .....	641
<u>I am hosting a multi-op station with several machines. Do I need to buy a licence for each of them ?</u> .....	641
<u>I personally own a Win-Test licence. Can I install Win-Test using my identifiers on the computer of my local radio club ?</u> .....	641
<u>I personally own a Win-Test licence. Can I install Win-Test using my identifiers on the computer brought by my mates who come home for a multi-op effort ?</u> .....	641
<u>I have registered the Win-Test licence to my personal call. Can I use it with a different callsign, like a vanity one?</u> .....	641
<u>My local radio-club owns a Win-Test licence. As a member of this club, can I use its identifiers to install and register Win-Test on my own computer?</u> .....	642
<u>I have registered Win-Test on my desktop computer. Can I register it on my notebook (or my</u>	



# Table of Contents

## **FAQ:Licensing**

<u>other computer), and if so, how to do it?</u> .....	642
<u>I just upgraded to Win-Test V3. But my license is gone?</u> .....	642
<u>Can I have a registered WT2 and a registered WT3 in the same installation directory?</u> .....	642
<u>I asked a question directly to the author and I did not have an answer !</u> .....	642
<u>Where can I read the archives of this mailing list you do not stop talking about ?</u> .....	642
<u>See also</u> .....	642
<u>Namespaces</u> .....	643
<u>Variants</u> .....	643
<u>Views</u> .....	643
<u>More</u> .....	643

## **FAQ:Networking**.....644

<u>Contents</u> .....	644
<u>What is the Win-Test network protocol?</u> .....	644
<u>In a networked environment, can we mix different versions of Win-Test?</u> .....	644
<u>UDP error opening socket #10013 and #10038 Errors</u> .....	644
<u>See also</u> .....	645
<u>Namespaces</u> .....	645
<u>Variants</u> .....	645
<u>Views</u> .....	645
<u>More</u> .....	645

## **FAQ:Problems Registering and Running**.....646

<u>Contents</u> .....	646
<u>How do I download, install, register and configure Win-Test on a new computer?</u> .....	646
<u>I selected Help   Register Software, but don't see my Computer Code</u> .....	646
<u>When I attempt to download Win-Test 4 the web site asks for a login and password. What should I use?</u> .....	646
<u>I requested a new registration key but I never received an email with the key</u> .....	647
<u>Win-Test always starts in "Demo" mode</u> .....	648
<u>My virus scanner reports that Win-Test is a virus!</u> .....	648
<u>Namespaces</u> .....	648
<u>Variants</u> .....	649
<u>Views</u> .....	649
<u>More</u> .....	649

## **FAQ:Problems Registering and Running**.....650

<u>Contents</u> .....	650
<u>How do I download, install, register and configure Win-Test on a new computer?</u> .....	650
<u>I selected Help   Register Software, but don't see my Computer Code</u> .....	650
<u>When I attempt to download Win-Test 4 the web site asks for a login and password. What should I use?</u> .....	650
<u>I requested a new registration key but I never received an email with the key</u> .....	651
<u>Win-Test always starts in "Demo" mode</u> .....	652
<u>My virus scanner reports that Win-Test is a virus!</u> .....	652
<u>Namespaces</u> .....	652
<u>Variants</u> .....	653

# Table of Contents

<b><u>FAQ:Problems Registering and Running</u></b>	
<u>Views</u> .....	653
<u>More</u> .....	653
<b><u>FAQ:Rotator Control and wtRotators</u></b> .....	<b>654</b>
<u>How do I control my rotators with Win-Test?</u> .....	654
<u>Can I make wtRotators start automatically when I start Win-Test?</u> .....	654
<u>How do I control a Green Heron RT-21 control box with wtRotators?</u> .....	654
<u>Namespaces</u> .....	655
<u>Variants</u> .....	655
<u>Views</u> .....	655
<u>More</u> .....	655
<b><u>FAQ:Rotator Control and wtRotators</u></b> .....	<b>656</b>
<u>How do I control my rotators with Win-Test?</u> .....	656
<u>Can I make wtRotators start automatically when I start Win-Test?</u> .....	656
<u>How do I control a Green Heron RT-21 control box with wtRotators?</u> .....	656
<u>Namespaces</u> .....	657
<u>Variants</u> .....	657
<u>Views</u> .....	657
<u>More</u> .....	657
<b><u>File:20200208 221352.gif</u></b> .....	<b>658</b>
<u>File history</u> .....	659
<u>File usage</u> .....	659
<u>Metadata</u> .....	659
<u>Namespaces</u> .....	659
<u>Variants</u> .....	659
<u>Views</u> .....	659
<u>More</u> .....	660
<b><u>File:20200208 221352.gif</u></b> .....	<b>661</b>
<u>File history</u> .....	662
<u>File usage</u> .....	662
<u>Metadata</u> .....	662
<u>Namespaces</u> .....	662
<u>Variants</u> .....	662
<u>Views</u> .....	662
<u>More</u> .....	663
<b><u>File:20200210 105102.gif</u></b> .....	<b>664</b>
<u>File history</u> .....	665
<u>File usage</u> .....	665
<u>Metadata</u> .....	665
<u>Namespaces</u> .....	665
<u>Variants</u> .....	666
<u>Views</u> .....	666
<u>More</u> .....	666

# Table of Contents

<b><u>File:20200210_105102.gif</u></b> .....	<b>667</b>
<u>File history</u> .....	668
<u>File usage</u> .....	668
<u>Metadata</u> .....	668
<u>Namespaces</u> .....	668
<u>Variants</u> .....	669
<u>Views</u> .....	669
<u>More</u> .....	669
<b><u>File:ActivateExchangeGuessing.gif</u></b> .....	<b>670</b>
<u>File history</u> .....	670
<u>File usage</u> .....	670
<u>Namespaces</u> .....	670
<u>Variants</u> .....	670
<u>Views</u> .....	671
<u>More</u> .....	671
<b><u>File:ActivateExchangeGuessing.gif</u></b> .....	<b>672</b>
<u>File history</u> .....	672
<u>File usage</u> .....	672
<u>Namespaces</u> .....	672
<u>Variants</u> .....	672
<u>Views</u> .....	673
<u>More</u> .....	673
<b><u>File:ARRLSweepstakesContestConfiguration.gif</u></b> .....	<b>674</b>
<u>File history</u> .....	675
<u>File usage</u> .....	675
<u>Namespaces</u> .....	675
<u>Variants</u> .....	675
<u>Views</u> .....	675
<u>More</u> .....	675
<b><u>File:ARRLSweepstakesCWMsgsConfiguration.gif</u></b> .....	<b>676</b>
<u>File history</u> .....	676
<u>File usage</u> .....	676
<u>Namespaces</u> .....	677
<u>Variants</u> .....	677
<u>Views</u> .....	677
<u>More</u> .....	677
<b><u>File:ARRLSweepstakesLogOptions.gif</u></b> .....	<b>678</b>
<u>File history</u> .....	679
<u>File usage</u> .....	679
<u>Namespaces</u> .....	679
<u>Variants</u> .....	679
<u>Views</u> .....	679
<u>More</u> .....	679

# Table of Contents

<b><u>File:ARRLSweepstakesLogOptions.gif</u></b> .....	<b>681</b>
<u>File history</u> .....	682
<u>File usage</u> .....	682
<u>Namespaces</u> .....	682
<u>Variants</u> .....	682
<u>Views</u> .....	682
<u>More</u> .....	682
<b><u>File:ARRLSweepstakesSectionList.gif</u></b> .....	<b>684</b>
<u>File history</u> .....	684
<u>File usage</u> .....	684
<u>Namespaces</u> .....	685
<u>Variants</u> .....	685
<u>Views</u> .....	685
<u>More</u> .....	685
<b><u>File:ARRLSweepstakesSectionList.gif</u></b> .....	<b>686</b>
<u>File history</u> .....	686
<u>File usage</u> .....	686
<u>Namespaces</u> .....	687
<u>Variants</u> .....	687
<u>Views</u> .....	687
<u>More</u> .....	687
<b><u>File:AutomaticBackup.PNG</u></b> .....	<b>688</b>
<u>File history</u> .....	688
<u>File usage</u> .....	688
<u>Namespaces</u> .....	689
<u>Variants</u> .....	689
<u>Views</u> .....	689
<u>More</u> .....	689
<b><u>File:AutomaticBackup.PNG</u></b> .....	<b>690</b>
<u>File history</u> .....	690
<u>File usage</u> .....	690
<u>Namespaces</u> .....	691
<u>Variants</u> .....	691
<u>Views</u> .....	691
<u>More</u> .....	691
<b><u>File:BandmapExcGuessEnable.gif</u></b> .....	<b>692</b>
<u>File history</u> .....	692
<u>File usage</u> .....	692
<u>Namespaces</u> .....	693
<u>Variants</u> .....	693
<u>Views</u> .....	693
<u>More</u> .....	693

# Table of Contents

<b><u>File:BandmapExcGuessEnable.gif</u></b> .....	<b>694</b>
<u>File history</u> .....	694
<u>File usage</u> .....	694
<u>Namespaces</u> .....	695
<u>Variants</u> .....	695
<u>Views</u> .....	695
<u>More</u> .....	695
<b><u>File:BandMapMarkerSegment.gif</u></b> .....	<b>696</b>
<u>File history</u> .....	697
<u>File usage</u> .....	697
<u>Namespaces</u> .....	697
<u>Variants</u> .....	697
<u>Views</u> .....	697
<u>More</u> .....	697
<b><u>File:BandMapMarkerSegment.gif</u></b> .....	<b>698</b>
<u>File history</u> .....	699
<u>File usage</u> .....	699
<u>Namespaces</u> .....	699
<u>Variants</u> .....	699
<u>Views</u> .....	699
<u>More</u> .....	699
<b><u>File:BandMapProperties.gif</u></b> .....	<b>700</b>
<u>File history</u> .....	701
<u>File usage</u> .....	701
<u>Namespaces</u> .....	701
<u>Variants</u> .....	701
<u>Views</u> .....	701
<u>More</u> .....	701
<b><u>File:BandMapProperties.gif</u></b> .....	<b>703</b>
<u>File history</u> .....	704
<u>File usage</u> .....	704
<u>Namespaces</u> .....	704
<u>Variants</u> .....	704
<u>Views</u> .....	704
<u>More</u> .....	704
<b><u>File:Bandplans.gif</u></b> .....	<b>706</b>
<u>File history</u> .....	707
<u>File usage</u> .....	707
<u>Namespaces</u> .....	707
<u>Variants</u> .....	707
<u>Views</u> .....	707
<u>More</u> .....	707

# Table of Contents

<b><u>File:Bandplans.gif</u></b> .....	<b>708</b>
<u>File history</u> .....	709
<u>File usage</u> .....	709
<u>Namespaces</u> .....	709
<u>Variants</u> .....	709
<u>Views</u> .....	709
<u>More</u> .....	709
<b><u>File:BestPractice42.gif</u></b> .....	<b>710</b>
<u>File history</u> .....	711
<u>File usage</u> .....	711
<u>Namespaces</u> .....	711
<u>Variants</u> .....	711
<u>Views</u> .....	711
<u>More</u> .....	711
<b><u>File:BestPractice42.gif</u></b> .....	<b>713</b>
<u>File history</u> .....	714
<u>File usage</u> .....	714
<u>Namespaces</u> .....	714
<u>Variants</u> .....	714
<u>Views</u> .....	714
<u>More</u> .....	714
<b><u>File:BestPractice71.gif</u></b> .....	<b>716</b>
<u>File history</u> .....	717
<u>File usage</u> .....	717
<u>Metadata</u> .....	717
<u>Namespaces</u> .....	717
<u>Variants</u> .....	717
<u>Views</u> .....	717
<u>More</u> .....	718
<b><u>File:BestPractice71.gif</u></b> .....	<b>719</b>
<u>File history</u> .....	720
<u>File usage</u> .....	720
<u>Metadata</u> .....	720
<u>Namespaces</u> .....	720
<u>Variants</u> .....	720
<u>Views</u> .....	720
<u>More</u> .....	721
<b><u>File:BestPractice82.gif</u></b> .....	<b>722</b>
<u>File history</u> .....	723
<u>File usage</u> .....	723
<u>Metadata</u> .....	723
<u>Namespaces</u> .....	723
<u>Variants</u> .....	723

# Table of Contents

<b><u>File:BestPractice82.gif</u></b>	
<u>Views</u> .....	723
<u>More</u> .....	724
<b><u>File:BestPractice82.gif</u></b> .....	<b>725</b>
<u>File history</u> .....	726
<u>File usage</u> .....	726
<u>Metadata</u> .....	726
<u>Namespaces</u> .....	726
<u>Variants</u> .....	726
<u>Views</u> .....	726
<u>More</u> .....	727
<b><u>File:CallsignPatternRed.PNG</u></b> .....	<b>728</b>
<u>File history</u> .....	728
<u>File usage</u> .....	728
<u>Namespaces</u> .....	728
<u>Variants</u> .....	728
<u>Views</u> .....	728
<u>More</u> .....	729
<b><u>File:CallsignPatternRed.PNG</u></b> .....	<b>730</b>
<u>File history</u> .....	730
<u>File usage</u> .....	730
<u>Namespaces</u> .....	730
<u>Variants</u> .....	730
<u>Views</u> .....	730
<u>More</u> .....	731
<b><u>File:CallsignPatternYellow.PNG</u></b> .....	<b>732</b>
<u>File history</u> .....	732
<u>File usage</u> .....	732
<u>Namespaces</u> .....	732
<u>Variants</u> .....	732
<u>Views</u> .....	732
<u>More</u> .....	733
<b><u>File:CallsignPatternYellow.PNG</u></b> .....	<b>734</b>
<u>File history</u> .....	734
<u>File usage</u> .....	734
<u>Namespaces</u> .....	734
<u>Variants</u> .....	734
<u>Views</u> .....	734
<u>More</u> .....	735
<b><u>File:carrier.gif</u></b> .....	<b>736</b>
<u>File history</u> .....	736
<u>File usage</u> .....	736

# Table of Contents

<b><u>File:carrier.gif</u></b>	
<u>Metadata</u> .....	736
<u>Namespaces</u> .....	737
<u>Variants</u> .....	737
<u>Views</u> .....	737
<u>More</u> .....	737
<b><u>File:carrier.gif</u>.....</b>	<b>738</b>
<u>File history</u> .....	738
<u>File usage</u> .....	738
<u>Metadata</u> .....	738
<u>Namespaces</u> .....	739
<u>Variants</u> .....	739
<u>Views</u> .....	739
<u>More</u> .....	739
<b><u>File:Checked report.gif</u>.....</b>	<b>740</b>
<u>File history</u> .....	740
<u>File usage</u> .....	740
<u>Metadata</u> .....	741
<u>Namespaces</u> .....	741
<u>Variants</u> .....	741
<u>Views</u> .....	741
<u>More</u> .....	741
<b><u>File:Checked report.gif</u>.....</b>	<b>742</b>
<u>File history</u> .....	742
<u>File usage</u> .....	742
<u>Metadata</u> .....	743
<u>Namespaces</u> .....	743
<u>Variants</u> .....	743
<u>Views</u> .....	743
<u>More</u> .....	743
<b><u>File:CheckPartialContextMenu.gif</u>.....</b>	<b>744</b>
<u>File history</u> .....	744
<u>File usage</u> .....	744
<u>Namespaces</u> .....	744
<u>Variants</u> .....	745
<u>Views</u> .....	745
<u>More</u> .....	745
<b><u>File:CheckPartialContextMenu.gif</u>.....</b>	<b>746</b>
<u>File history</u> .....	746
<u>File usage</u> .....	746
<u>Namespaces</u> .....	746
<u>Variants</u> .....	747
<u>Views</u> .....	747



# Table of Contents

<b><u>File:CheckPartialContextMenu.gif</u></b>	
<u>More</u> .....	747
<b><u>File:Check Partial Files List.PNG</u></b> .....	<b>748</b>
<u>File history</u> .....	748
<u>File usage</u> .....	748
<u>Namespaces</u> .....	748
<u>Variants</u> .....	749
<u>Views</u> .....	749
<u>More</u> .....	749
<b><u>File:Check Partial Files List.PNG</u></b> .....	<b>750</b>
<u>File history</u> .....	750
<u>File usage</u> .....	750
<u>Namespaces</u> .....	750
<u>Variants</u> .....	751
<u>Views</u> .....	751
<u>More</u> .....	751
<b><u>File:CheckPartialUsedFilesList.gif</u></b> .....	<b>752</b>
<u>File history</u> .....	752
<u>File usage</u> .....	752
<u>Namespaces</u> .....	752
<u>Variants</u> .....	752
<u>Views</u> .....	753
<u>More</u> .....	753
<b><u>File:CheckPartialUsedFilesList.PNG</u></b> .....	<b>754</b>
<u>File history</u> .....	754
<u>File usage</u> .....	754
<u>Namespaces</u> .....	754
<u>Variants</u> .....	755
<u>Views</u> .....	755
<u>More</u> .....	755
<b><u>File:CheckPartialUsedFilesList.PNG</u></b> .....	<b>756</b>
<u>File history</u> .....	756
<u>File usage</u> .....	756
<u>Namespaces</u> .....	756
<u>Variants</u> .....	757
<u>Views</u> .....	757
<u>More</u> .....	757
<b><u>File:CheckPartialUsedFilesList.gif</u></b> .....	<b>758</b>
<u>File history</u> .....	758
<u>File usage</u> .....	758
<u>Namespaces</u> .....	758
<u>Variants</u> .....	758

# Table of Contents

<b><u>File:CheckPartialUsedFilesList.gif</u></b>	
<u>Views</u> .....	759
<u>More</u> .....	759
<b><u>File:clocks.gif</u></b> .....	<b>760</b>
<u>File history</u> .....	760
<u>File usage</u> .....	760
<u>Namespaces</u> .....	760
<u>Variants</u> .....	760
<u>Views</u> .....	760
<u>More</u> .....	761
<b><u>File:clocks.gif</u></b> .....	<b>762</b>
<u>File history</u> .....	762
<u>File usage</u> .....	762
<u>Namespaces</u> .....	762
<u>Variants</u> .....	762
<u>Views</u> .....	762
<u>More</u> .....	763
<b><u>File:com1-properties.gif</u></b> .....	<b>764</b>
<u>File history</u> .....	764
<u>File usage</u> .....	764
<u>Namespaces</u> .....	764
<u>Variants</u> .....	765
<u>Views</u> .....	765
<u>More</u> .....	765
<b><u>File:com1-properties.gif</u></b> .....	<b>766</b>
<u>File history</u> .....	766
<u>File usage</u> .....	766
<u>Namespaces</u> .....	766
<u>Variants</u> .....	767
<u>Views</u> .....	767
<u>More</u> .....	767
<b><u>File:com6-properties.gif</u></b> .....	<b>768</b>
<u>File history</u> .....	768
<u>File usage</u> .....	768
<u>Metadata</u> .....	768
<u>Namespaces</u> .....	769
<u>Variants</u> .....	769
<u>Views</u> .....	769
<u>More</u> .....	769
<b><u>File:com6-properties.gif</u></b> .....	<b>770</b>
<u>File history</u> .....	770
<u>File usage</u> .....	770

# Table of Contents

<b><u>File:com6-properties.gif</u></b>	
<u>Metadata</u> .....	770
<u>Namespaces</u> .....	771
<u>Variants</u> .....	771
<u>Views</u> .....	771
<u>More</u> .....	771
<b><u>File:COM Port CW PTT Circuit.gif</u></b> .....	<b>772</b>
<u>File history</u> .....	772
<u>File usage</u> .....	772
<u>Metadata</u> .....	773
<u>Namespaces</u> .....	773
<u>Variants</u> .....	773
<u>Views</u> .....	773
<u>More</u> .....	773
<b><u>File:COM Port CW PTT Circuit.gif</u></b> .....	<b>774</b>
<u>File history</u> .....	774
<u>File usage</u> .....	774
<u>Metadata</u> .....	775
<u>Namespaces</u> .....	775
<u>Variants</u> .....	775
<u>Views</u> .....	775
<u>More</u> .....	775
<b><u>File:Config TNC.jpg</u></b> .....	<b>776</b>
<u>File history</u> .....	776
<u>File usage</u> .....	776
<u>Namespaces</u> .....	776
<u>Variants</u> .....	777
<u>Views</u> .....	777
<u>More</u> .....	777
<b><u>File:Config TNC.jpg</u></b> .....	<b>778</b>
<u>File history</u> .....	778
<u>File usage</u> .....	778
<u>Namespaces</u> .....	778
<u>Variants</u> .....	779
<u>Views</u> .....	779
<u>More</u> .....	779
<b><u>File:Configure-interfaces.gif</u></b> .....	<b>780</b>
<u>File history</u> .....	781
<u>File usage</u> .....	781
<u>Namespaces</u> .....	781
<u>Variants</u> .....	781
<u>Views</u> .....	781
<u>More</u> .....	781

# Table of Contents

<b><u>File:Configure-interfaces.gif</u></b> .....	<b>782</b>
<u>File history</u> .....	783
<u>File usage</u> .....	783
<u>Namespaces</u> .....	783
<u>Variants</u> .....	783
<u>Views</u> .....	783
<u>More</u> .....	783
<b><u>File:Contest configuration.gif</u></b> .....	<b>784</b>
<u>File history</u> .....	785
<u>File usage</u> .....	785
<u>Namespaces</u> .....	785
<u>Variants</u> .....	785
<u>Views</u> .....	786
<u>More</u> .....	786
<b><u>File:ContestRecorder.PNG</u></b> .....	<b>787</b>
<u>File history</u> .....	788
<u>File usage</u> .....	788
<u>Metadata</u> .....	788
<u>Namespaces</u> .....	788
<u>Variants</u> .....	788
<u>Views</u> .....	788
<u>More</u> .....	789
<b><u>File:ContestRecorderExtractOSO.PNG</u></b> .....	<b>790</b>
<u>File history</u> .....	790
<u>File usage</u> .....	790
<u>Metadata</u> .....	790
<u>Namespaces</u> .....	791
<u>Variants</u> .....	791
<u>Views</u> .....	791
<u>More</u> .....	791
<b><u>File:ContestRecorderExtractOSO.PNG</u></b> .....	<b>792</b>
<u>File history</u> .....	792
<u>File usage</u> .....	792
<u>Metadata</u> .....	792
<u>Namespaces</u> .....	793
<u>Variants</u> .....	793
<u>Views</u> .....	793
<u>More</u> .....	793
<b><u>File:ContestRecorder.PNG</u></b> .....	<b>794</b>
<u>File history</u> .....	795
<u>File usage</u> .....	795
<u>Metadata</u> .....	795
<u>Namespaces</u> .....	795

# Table of Contents

<b><u>File:ContestRecorder.PNG</u></b>	
<u>Variants</u> .....	795
<u>Views</u> .....	795
<u>More</u> .....	796
<b><u>File:Copyastext.PNG</u></b> .....	<b>797</b>
<u>File history</u> .....	798
<u>File usage</u> .....	798
<u>Namespaces</u> .....	798
<u>Variants</u> .....	798
<u>Views</u> .....	798
<u>More</u> .....	798
<b><u>File:Copyastext.PNG</u></b> .....	<b>799</b>
<u>File history</u> .....	800
<u>File usage</u> .....	800
<u>Namespaces</u> .....	800
<u>Variants</u> .....	800
<u>Views</u> .....	800
<u>More</u> .....	800
<b><u>File:Creating.gif</u></b> .....	<b>801</b>
<u>File history</u> .....	801
<u>File usage</u> .....	801
<u>Namespaces</u> .....	801
<u>Variants</u> .....	802
<u>Views</u> .....	802
<u>More</u> .....	802
<b><u>File:CreatingAdifOptions.gif</u></b> .....	<b>803</b>
<u>File history</u> .....	803
<u>File usage</u> .....	803
<u>Namespaces</u> .....	803
<u>Variants</u> .....	803
<u>Views</u> .....	803
<u>More</u> .....	804
<b><u>File:CreatingAdifOptions.gif</u></b> .....	<b>805</b>
<u>File history</u> .....	805
<u>File usage</u> .....	805
<u>Namespaces</u> .....	805
<u>Variants</u> .....	805
<u>Views</u> .....	805
<u>More</u> .....	806
<b><u>File:CreatingCabrilloOptions.gif</u></b> .....	<b>807</b>
<u>File history</u> .....	807
<u>File usage</u> .....	807

# Table of Contents

<b><u>File:CreatingCabrilloOptions.gif</u></b>	
<u>Namespaces</u> .....	807
<u>Variants</u> .....	808
<u>Views</u> .....	808
<u>More</u> .....	808
<b><u>File:CreatingCabrilloOptions.gif</u></b> .....	<b>809</b>
<u>File history</u> .....	809
<u>File usage</u> .....	809
<u>Namespaces</u> .....	809
<u>Variants</u> .....	810
<u>Views</u> .....	810
<u>More</u> .....	810
<b><u>File:CreatingCSVFileOptions.gif</u></b> .....	<b>811</b>
<u>File history</u> .....	811
<u>File usage</u> .....	811
<u>Namespaces</u> .....	812
<u>Variants</u> .....	812
<u>Views</u> .....	812
<u>More</u> .....	812
<b><u>File:CreatingCSVFileOptions.gif</u></b> .....	<b>813</b>
<u>File history</u> .....	813
<u>File usage</u> .....	813
<u>Namespaces</u> .....	814
<u>Variants</u> .....	814
<u>Views</u> .....	814
<u>More</u> .....	814
<b><u>File:Creating.gif</u></b> .....	<b>815</b>
<u>File history</u> .....	815
<u>File usage</u> .....	815
<u>Namespaces</u> .....	815
<u>Variants</u> .....	816
<u>Views</u> .....	816
<u>More</u> .....	816
<b><u>File:CreatingLogsearchFileOptions.PNG</u></b> .....	<b>817</b>
<u>File history</u> .....	817
<u>File usage</u> .....	817
<u>Namespaces</u> .....	817
<u>Variants</u> .....	818
<u>Views</u> .....	818
<u>More</u> .....	818

# Table of Contents

<b><u>File:CreatingLogsearchFileOptions.PNG</u></b> .....	<b>819</b>
<u>File history</u> .....	819
<u>File usage</u> .....	819
<u>Namespaces</u> .....	819
<u>Variants</u> .....	820
<u>Views</u> .....	820
<u>More</u> .....	820
<b><u>File:CreatingReg1Test.gif</u></b> .....	<b>821</b>
<u>File history</u> .....	821
<u>File usage</u> .....	821
<u>Namespaces</u> .....	822
<u>Variants</u> .....	822
<u>Views</u> .....	822
<u>More</u> .....	822
<b><u>File:CreatingReg1Test.gif</u></b> .....	<b>823</b>
<u>File history</u> .....	823
<u>File usage</u> .....	823
<u>Namespaces</u> .....	824
<u>Variants</u> .....	824
<u>Views</u> .....	824
<u>More</u> .....	824
<b><u>File:CreatingTextFileOptions.gif</u></b> .....	<b>825</b>
<u>File history</u> .....	825
<u>File usage</u> .....	825
<u>Namespaces</u> .....	826
<u>Variants</u> .....	826
<u>Views</u> .....	826
<u>More</u> .....	826
<b><u>File:CreatingTextFileOptions.gif</u></b> .....	<b>827</b>
<u>File history</u> .....	827
<u>File usage</u> .....	827
<u>Namespaces</u> .....	828
<u>Variants</u> .....	828
<u>Views</u> .....	828
<u>More</u> .....	828
<b><u>File:cw-additional-messages.gif</u></b> .....	<b>829</b>
<u>File history</u> .....	830
<u>File usage</u> .....	830
<u>Metadata</u> .....	830
<u>Namespaces</u> .....	830
<u>Variants</u> .....	831
<u>Views</u> .....	831
<u>More</u> .....	831

# Table of Contents

<b><u>File:cw-additional-messages.gif</u></b> .....	<b>832</b>
<u>File history</u> .....	833
<u>File usage</u> .....	833
<u>Metadata</u> .....	833
<u>Namespaces</u> .....	833
<u>Variants</u> .....	834
<u>Views</u> .....	834
<u>More</u> .....	834
<b><u>File:CWSerialNumberAbbreviation.PNG</u></b> .....	<b>835</b>
<u>File history</u> .....	836
<u>File usage</u> .....	836
<u>Metadata</u> .....	836
<u>Namespaces</u> .....	837
<u>Variants</u> .....	837
<u>Views</u> .....	837
<u>More</u> .....	837
<b><u>File:CWSerialNumberAbbreviation.PNG</u></b> .....	<b>838</b>
<u>File history</u> .....	839
<u>File usage</u> .....	839
<u>Metadata</u> .....	839
<u>Namespaces</u> .....	840
<u>Variants</u> .....	840
<u>Views</u> .....	840
<u>More</u> .....	840
<b><u>File:CWSerialNumberCustomTable.PNG</u></b> .....	<b>841</b>
<u>File history</u> .....	841
<u>File usage</u> .....	841
<u>Namespaces</u> .....	842
<u>Variants</u> .....	842
<u>Views</u> .....	842
<u>More</u> .....	842
<b><u>File:CWSerialNumberCustomTable.PNG</u></b> .....	<b>843</b>
<u>File history</u> .....	843
<u>File usage</u> .....	843
<u>Namespaces</u> .....	844
<u>Variants</u> .....	844
<u>Views</u> .....	844
<u>More</u> .....	844
<b><u>File:cwspeed.gif</u></b> .....	<b>845</b>
<u>File history</u> .....	845
<u>File usage</u> .....	845
<u>Namespaces</u> .....	845
<u>Variants</u> .....	845



# Table of Contents

<b><u>File:cwspeed.gif</u></b>	
<u>Views</u> .....	845
<u>More</u> .....	845
<b><u>File:cwspeed.gif</u></b> .....	<b>847</b>
<u>File history</u> .....	847
<u>File usage</u> .....	847
<u>Namespaces</u> .....	847
<u>Variants</u> .....	847
<u>Views</u> .....	847
<u>More</u> .....	847
<b><u>File:CwStandardMessages.gif</u></b> .....	<b>849</b>
<u>File history</u> .....	849
<u>File usage</u> .....	849
<u>Metadata</u> .....	850
<u>Namespaces</u> .....	850
<u>Variants</u> .....	850
<u>Views</u> .....	850
<u>More</u> .....	850
<b><u>File:CwStandardMessages.gif</u></b> .....	<b>851</b>
<u>File history</u> .....	851
<u>File usage</u> .....	851
<u>Metadata</u> .....	852
<u>Namespaces</u> .....	852
<u>Variants</u> .....	852
<u>Views</u> .....	852
<u>More</u> .....	852
<b><u>File:CwStandardMessagesOptions.gif</u></b> .....	<b>853</b>
<u>File history</u> .....	853
<u>File usage</u> .....	853
<u>Namespaces</u> .....	854
<u>Variants</u> .....	854
<u>Views</u> .....	854
<u>More</u> .....	854
<b><u>File:CwStandardMessagesOptions.gif</u></b> .....	<b>855</b>
<u>File history</u> .....	855
<u>File usage</u> .....	855
<u>Namespaces</u> .....	856
<u>Variants</u> .....	856
<u>Views</u> .....	856
<u>More</u> .....	856

# Table of Contents

<b><u>File:cwweight.gif</u></b> .....	<b>857</b>
<u>File history</u> .....	857
<u>File usage</u> .....	857
<u>Namespaces</u> .....	857
<u>Variants</u> .....	857
<u>Views</u> .....	857
<u>More</u> .....	857
<b><u>File:cwweight.gif</u></b> .....	<b>859</b>
<u>File history</u> .....	859
<u>File usage</u> .....	859
<u>Namespaces</u> .....	859
<u>Variants</u> .....	859
<u>Views</u> .....	859
<u>More</u> .....	859
<b><u>File:DataFilesExtra.gif</u></b> .....	<b>861</b>
<u>File history</u> .....	861
<u>File usage</u> .....	861
<u>Namespaces</u> .....	861
<u>Variants</u> .....	861
<u>Views</u> .....	862
<u>More</u> .....	862
<b><u>File:DataFilesExtra.gif</u></b> .....	<b>863</b>
<u>File history</u> .....	863
<u>File usage</u> .....	863
<u>Namespaces</u> .....	863
<u>Variants</u> .....	863
<u>Views</u> .....	864
<u>More</u> .....	864
<b><u>File:DataFilesMarkers.gif</u></b> .....	<b>865</b>
<u>File history</u> .....	865
<u>File usage</u> .....	865
<u>Namespaces</u> .....	865
<u>Variants</u> .....	865
<u>Views</u> .....	866
<u>More</u> .....	866
<b><u>File:DataFilesMarkers.gif</u></b> .....	<b>867</b>
<u>File history</u> .....	867
<u>File usage</u> .....	867
<u>Namespaces</u> .....	867
<u>Variants</u> .....	867
<u>Views</u> .....	868
<u>More</u> .....	868

# Table of Contents

<b><u>File:DataFilesSegment.gif</u></b> .....	<b>869</b>
<u>File history</u> .....	869
<u>File usage</u> .....	869
<u>Namespaces</u> .....	869
<u>Variants</u> .....	869
<u>Views</u> .....	870
<u>More</u> .....	870
<b><u>File:DataFilesSegment.gif</u></b> .....	<b>871</b>
<u>File history</u> .....	871
<u>File usage</u> .....	871
<u>Namespaces</u> .....	871
<u>Variants</u> .....	871
<u>Views</u> .....	872
<u>More</u> .....	872
<b><u>File:DefaultOpenChildWindows.gif</u></b> .....	<b>873</b>
<u>File history</u> .....	873
<u>File usage</u> .....	873
<u>Namespaces</u> .....	874
<u>Variants</u> .....	874
<u>Views</u> .....	874
<u>More</u> .....	874
<b><u>File:DefaultOpenChildWindows.gif</u></b> .....	<b>875</b>
<u>File history</u> .....	875
<u>File usage</u> .....	875
<u>Namespaces</u> .....	876
<u>Variants</u> .....	876
<u>Views</u> .....	876
<u>More</u> .....	876
<b><u>File&gt;DeleteAllQSO.gif</u></b> .....	<b>877</b>
<u>File history</u> .....	877
<u>File usage</u> .....	877
<u>Namespaces</u> .....	877
<u>Variants</u> .....	877
<u>Views</u> .....	878
<u>More</u> .....	878
<b><u>File&gt;DeleteAllQSO.gif</u></b> .....	<b>879</b>
<u>File history</u> .....	879
<u>File usage</u> .....	879
<u>Namespaces</u> .....	879
<u>Variants</u> .....	879
<u>Views</u> .....	880
<u>More</u> .....	880

# Table of Contents

<b><u>File:DeleteAOSO.gif</u></b> .....	<b>881</b>
<u>File history</u> .....	881
<u>File usage</u> .....	881
<u>Namespaces</u> .....	881
<u>Variants</u> .....	881
<u>Views</u> .....	881
<u>More</u> .....	882
<b><u>File:DeleteAOSO.gif</u></b> .....	<b>883</b>
<u>File history</u> .....	883
<u>File usage</u> .....	883
<u>Namespaces</u> .....	883
<u>Variants</u> .....	883
<u>Views</u> .....	883
<u>More</u> .....	884
<b><u>File:Detailed.PNG</u></b> .....	<b>885</b>
<u>File history</u> .....	886
<u>File usage</u> .....	886
<u>Namespaces</u> .....	886
<u>Variants</u> .....	886
<u>Views</u> .....	886
<u>More</u> .....	886
<b><u>File:Detailed.PNG</u></b> .....	<b>887</b>
<u>File history</u> .....	888
<u>File usage</u> .....	888
<u>Namespaces</u> .....	888
<u>Variants</u> .....	888
<u>Views</u> .....	888
<u>More</u> .....	888
<b><u>File:DeviceMgrYaesu-FTDX-101.gif</u></b> .....	<b>889</b>
<u>File history</u> .....	889
<u>File usage</u> .....	889
<u>Namespaces</u> .....	889
<u>Variants</u> .....	889
<u>Views</u> .....	889
<u>More</u> .....	890
<b><u>File:DeviceMgrYaesu-FTDX-101.gif</u></b> .....	<b>891</b>
<u>File history</u> .....	891
<u>File usage</u> .....	891
<u>Namespaces</u> .....	891
<u>Variants</u> .....	891
<u>Views</u> .....	891
<u>More</u> .....	892

# Table of Contents

<b><u>File:DistinctCallsignsReport.PNG</u></b> .....	<b>893</b>
<u>File history</u> .....	893
<u>File usage</u> .....	893
<u>Metadata</u> .....	894
<u>Namespaces</u> .....	894
<u>Variants</u> .....	894
<u>Views</u> .....	894
<u>More</u> .....	894
<b><u>File:DistinctCallsignsReport.PNG</u></b> .....	<b>895</b>
<u>File history</u> .....	895
<u>File usage</u> .....	895
<u>Metadata</u> .....	896
<u>Namespaces</u> .....	896
<u>Variants</u> .....	896
<u>Views</u> .....	896
<u>More</u> .....	896
<b><u>File:dl4ner-contest-specific.gif</u></b> .....	<b>897</b>
<u>File history</u> .....	898
<u>File usage</u> .....	898
<u>Namespaces</u> .....	898
<u>Variants</u> .....	898
<u>Views</u> .....	898
<u>More</u> .....	898
<b><u>File:dl4ner-contest-specific.gif</u></b> .....	<b>899</b>
<u>File history</u> .....	900
<u>File usage</u> .....	900
<u>Namespaces</u> .....	900
<u>Variants</u> .....	900
<u>Views</u> .....	900
<u>More</u> .....	900
<b><u>File:dx-cluster.gif</u></b> .....	<b>901</b>
<u>File history</u> .....	901
<u>File usage</u> .....	901
<u>Namespaces</u> .....	901
<u>Variants</u> .....	901
<u>Views</u> .....	901
<u>More</u> .....	901
<b><u>File:DxCluster.gif</u></b> .....	<b>903</b>
<u>File history</u> .....	903
<u>File usage</u> .....	903
<u>Namespaces</u> .....	903
<u>Variants</u> .....	903
<u>Views</u> .....	903

# Table of Contents

<b><u>File:DxCluster.gif</u></b>	
<u>More</u> .....	904
<b><u>File:DXClusterAnnouncementsBands.PNG</u></b> .....	<b>905</b>
<u>File history</u> .....	906
<u>File usage</u> .....	906
<u>Metadata</u> .....	906
<u>Namespaces</u> .....	907
<u>Variants</u> .....	907
<u>Views</u> .....	907
<u>More</u> .....	907
<b><u>File:DXClusterAnnouncementsBands.PNG</u></b> .....	<b>908</b>
<u>File history</u> .....	909
<u>File usage</u> .....	909
<u>Metadata</u> .....	909
<u>Namespaces</u> .....	910
<u>Variants</u> .....	910
<u>Views</u> .....	910
<u>More</u> .....	910
<b><u>File:DXClusterAnnouncementsDisplayOptions.PNG</u></b> .....	<b>911</b>
<u>File history</u> .....	911
<u>File usage</u> .....	912
<u>Metadata</u> .....	912
<u>Namespaces</u> .....	912
<u>Variants</u> .....	912
<u>Views</u> .....	912
<u>More</u> .....	912
<b><u>File:DXClusterAnnouncementsDisplayOptions.PNG</u></b> .....	<b>914</b>
<u>File history</u> .....	914
<u>File usage</u> .....	915
<u>Metadata</u> .....	915
<u>Namespaces</u> .....	915
<u>Variants</u> .....	915
<u>Views</u> .....	915
<u>More</u> .....	915
<b><u>File:DXClusterAnnouncementsSpotQuality.PNG</u></b> .....	<b>917</b>
<u>File history</u> .....	917
<u>File usage</u> .....	917
<u>Metadata</u> .....	917
<u>Namespaces</u> .....	918
<u>Variants</u> .....	918
<u>Views</u> .....	918
<u>More</u> .....	918

# Table of Contents

<b><u>File:DXClusterAnnouncementsSpotQuality.PNG</u></b> .....	<b>919</b>
<u>File history</u> .....	919
<u>File usage</u> .....	919
<u>Metadata</u> .....	919
<u>Namespaces</u> .....	920
<u>Variants</u> .....	920
<u>Views</u> .....	920
<u>More</u> .....	920
<b><u>File:dx-cluster.gif</u></b> .....	<b>921</b>
<u>File history</u> .....	921
<u>File usage</u> .....	921
<u>Namespaces</u> .....	921
<u>Variants</u> .....	921
<u>Views</u> .....	921
<u>More</u> .....	921
<b><u>File:DxCluster.gif</u></b> .....	<b>923</b>
<u>File history</u> .....	923
<u>File usage</u> .....	923
<u>Namespaces</u> .....	923
<u>Variants</u> .....	923
<u>Views</u> .....	923
<u>More</u> .....	924
<b><u>File:DxClusterMacros.gif</u></b> .....	<b>925</b>
<u>File history</u> .....	925
<u>File usage</u> .....	925
<u>Namespaces</u> .....	925
<u>Variants</u> .....	926
<u>Views</u> .....	926
<u>More</u> .....	926
<b><u>File:DxClusterMacros.gif</u></b> .....	<b>927</b>
<u>File history</u> .....	927
<u>File usage</u> .....	927
<u>Namespaces</u> .....	927
<u>Variants</u> .....	928
<u>Views</u> .....	928
<u>More</u> .....	928
<b><u>File:DxClusterShortcuts.gif</u></b> .....	<b>929</b>
<u>File history</u> .....	929
<u>File usage</u> .....	929
<u>Namespaces</u> .....	929
<u>Variants</u> .....	929
<u>Views</u> .....	929
<u>More</u> .....	930

# Table of Contents

<b><u>File:DxClusterShortcuts.gif</u></b> .....	<b>931</b>
<u>File history</u> .....	931
<u>File usage</u> .....	931
<u>Namespaces</u> .....	931
<u>Variants</u> .....	931
<u>Views</u> .....	931
<u>More</u> .....	932
<b><u>File:dx-cluster-syntax.gif</u></b> .....	<b>933</b>
<u>File history</u> .....	934
<u>File usage</u> .....	934
<u>Namespaces</u> .....	934
<u>Variants</u> .....	934
<u>Views</u> .....	934
<u>More</u> .....	934
<b><u>File:dx-cluster-syntax.gif</u></b> .....	<b>935</b>
<u>File history</u> .....	936
<u>File usage</u> .....	936
<u>Namespaces</u> .....	936
<u>Variants</u> .....	936
<u>Views</u> .....	936
<u>More</u> .....	936
<b><u>File:DXDoublerJumpersForWin-Test.gif</u></b> .....	<b>937</b>
<u>File history</u> .....	938
<u>File usage</u> .....	938
<u>Namespaces</u> .....	938
<u>Variants</u> .....	938
<u>Views</u> .....	938
<u>More</u> .....	938
<b><u>File:DXDoublerJumpersForWin-Test.gif</u></b> .....	<b>939</b>
<u>File history</u> .....	940
<u>File usage</u> .....	940
<u>Namespaces</u> .....	940
<u>Variants</u> .....	940
<u>Views</u> .....	940
<u>More</u> .....	940
<b><u>File:DxPeditonInfoField.gif</u></b> .....	<b>941</b>
<u>File history</u> .....	941
<u>File usage</u> .....	941
<u>Namespaces</u> .....	941
<u>Variants</u> .....	941
<u>Views</u> .....	941
<u>More</u> .....	942



# Table of Contents

<b><u>File:DxPeditonInfoField.gif</u></b> .....	<b>943</b>
<u>File history</u> .....	943
<u>File usage</u> .....	943
<u>Namespaces</u> .....	943
<u>Variants</u> .....	943
<u>Views</u> .....	943
<u>More</u> .....	944
<b><u>File:DxPeditonOptions.gif</u></b> .....	<b>945</b>
<u>File history</u> .....	945
<u>File usage</u> .....	945
<u>Namespaces</u> .....	945
<u>Variants</u> .....	945
<u>Views</u> .....	945
<u>More</u> .....	946
<b><u>File:DxPeditonOptions.gif</u></b> .....	<b>947</b>
<u>File history</u> .....	947
<u>File usage</u> .....	947
<u>Namespaces</u> .....	947
<u>Variants</u> .....	947
<u>Views</u> .....	947
<u>More</u> .....	948
<b><u>File:EditApplyExchangeToEveryOSO.gif</u></b> .....	<b>949</b>
<u>File history</u> .....	949
<u>File usage</u> .....	949
<u>Metadata</u> .....	949
<u>Namespaces</u> .....	950
<u>Variants</u> .....	950
<u>Views</u> .....	950
<u>More</u> .....	950
<b><u>File:EditApplyExchangeToEveryOSO.gif</u></b> .....	<b>951</b>
<u>File history</u> .....	951
<u>File usage</u> .....	951
<u>Metadata</u> .....	951
<u>Namespaces</u> .....	952
<u>Variants</u> .....	952
<u>Views</u> .....	952
<u>More</u> .....	952
<b><u>File:EditDateTimeFrequency.gif</u></b> .....	<b>953</b>
<u>File history</u> .....	953
<u>File usage</u> .....	953
<u>Namespaces</u> .....	953
<u>Variants</u> .....	954
<u>Views</u> .....	954

# Table of Contents

<b><u>File:EditDateTimeFrequency.gif</u></b>	
<u>More</u> .....	954
<b><u>File:EditDateTimeFrequency.gif</u></b> .....	<b>955</b>
<u>File history</u> .....	955
<u>File usage</u> .....	955
<u>Namespaces</u> .....	955
<u>Variants</u> .....	956
<u>Views</u> .....	956
<u>More</u> .....	956
<b><u>File:editserial.gif</u></b> .....	<b>957</b>
<u>File history</u> .....	957
<u>File usage</u> .....	957
<u>Namespaces</u> .....	957
<u>Variants</u> .....	957
<u>Views</u> .....	957
<u>More</u> .....	958
<b><u>File:EditSerial.gif</u></b> .....	<b>959</b>
<u>File history</u> .....	959
<u>File usage</u> .....	959
<u>Namespaces</u> .....	959
<u>Variants</u> .....	959
<u>Views</u> .....	959
<u>More</u> .....	960
<b><u>File:EditSerial.gif</u></b> .....	<b>961</b>
<u>File history</u> .....	961
<u>File usage</u> .....	961
<u>Namespaces</u> .....	961
<u>Variants</u> .....	961
<u>Views</u> .....	961
<u>More</u> .....	962
<b><u>File:editserial.gif</u></b> .....	<b>963</b>
<u>File history</u> .....	963
<u>File usage</u> .....	963
<u>Namespaces</u> .....	963
<u>Variants</u> .....	963
<u>Views</u> .....	963
<u>More</u> .....	964
<b><u>File:EnableDVKinmicroHAM.gif</u></b> .....	<b>965</b>
<u>File history</u> .....	966
<u>File usage</u> .....	966
<u>Namespaces</u> .....	966
<u>Variants</u> .....	966

# Table of Contents

<b><u>File:EnableDVKinmicroHAM.gif</u></b>	
<u>Views</u> .....	966
<u>More</u> .....	966
<b><u>File:EnableDVKinmicroHAM.gif</u></b> .....	<b>967</b>
<u>File history</u> .....	968
<u>File usage</u> .....	968
<u>Namespaces</u> .....	968
<u>Variants</u> .....	968
<u>Views</u> .....	968
<u>More</u> .....	968
<b><u>File:ExchangeGuessingBandmap.gif</u></b> .....	<b>969</b>
<u>File history</u> .....	970
<u>File usage</u> .....	970
<u>Namespaces</u> .....	970
<u>Variants</u> .....	970
<u>Views</u> .....	970
<u>More</u> .....	970
<b><u>File:ExchangeGuessingBandmap.gif</u></b> .....	<b>971</b>
<u>File history</u> .....	972
<u>File usage</u> .....	972
<u>Namespaces</u> .....	972
<u>Variants</u> .....	972
<u>Views</u> .....	972
<u>More</u> .....	972
<b><u>File:ExportFileTo.gif</u></b> .....	<b>973</b>
<u>File history</u> .....	973
<u>File usage</u> .....	973
<u>Namespaces</u> .....	973
<u>Variants</u> .....	974
<u>Views</u> .....	974
<u>More</u> .....	974
<b><u>File:ExportFileTo.gif</u></b> .....	<b>975</b>
<u>File history</u> .....	975
<u>File usage</u> .....	975
<u>Namespaces</u> .....	975
<u>Variants</u> .....	976
<u>Views</u> .....	976
<u>More</u> .....	976
<b><u>File:Ezmaster.PNG</u></b> .....	<b>977</b>
<u>File history</u> .....	978
<u>File usage</u> .....	978
<u>Namespaces</u> .....	978

# Table of Contents

<b><u>File:Ezmaster.PNG</u></b>	
<u>Variants</u> .....	978
<u>Views</u> .....	978
<u>More</u> .....	978
<b><u>File:Ezmaster.PNG</u></b> .....	<b>979</b>
<u>File history</u> .....	980
<u>File usage</u> .....	980
<u>Namespaces</u> .....	980
<u>Variants</u> .....	980
<u>Views</u> .....	980
<u>More</u> .....	980
<b><u>File:FileCleanLog.PNG</u></b> .....	<b>981</b>
<u>File history</u> .....	981
<u>File usage</u> .....	982
<u>Metadata</u> .....	982
<u>Namespaces</u> .....	982
<u>Variants</u> .....	982
<u>Views</u> .....	982
<u>More</u> .....	982
<b><u>File:FileCleanLog.PNG</u></b> .....	<b>983</b>
<u>File history</u> .....	983
<u>File usage</u> .....	984
<u>Metadata</u> .....	984
<u>Namespaces</u> .....	984
<u>Variants</u> .....	984
<u>Views</u> .....	984
<u>More</u> .....	984
<b><u>File:FileCleanLogOptions.PNG</u></b> .....	<b>985</b>
<u>File history</u> .....	985
<u>File usage</u> .....	985
<u>Metadata</u> .....	985
<u>Namespaces</u> .....	986
<u>Variants</u> .....	986
<u>Views</u> .....	986
<u>More</u> .....	986
<b><u>File:FileCleanLogOptions.PNG</u></b> .....	<b>987</b>
<u>File history</u> .....	987
<u>File usage</u> .....	987
<u>Metadata</u> .....	987
<u>Namespaces</u> .....	988
<u>Variants</u> .....	988
<u>Views</u> .....	988
<u>More</u> .....	988

# Table of Contents

<b><u>File:file-create-logfiles.gif</u></b> .....	<b>989</b>
<u>File history</u> .....	990
<u>File usage</u> .....	990
<u>Namespaces</u> .....	990
<u>Variants</u> .....	990
<u>Views</u> .....	990
<u>More</u> .....	990
<b><u>File:FileCreateLogFiles.PNG</u></b> .....	<b>991</b>
<u>File history</u> .....	992
<u>File usage</u> .....	992
<u>Namespaces</u> .....	992
<u>Variants</u> .....	992
<u>Views</u> .....	992
<u>More</u> .....	992
<b><u>File:file-create-logfiles.gif</u></b> .....	<b>993</b>
<u>File history</u> .....	994
<u>File usage</u> .....	994
<u>Namespaces</u> .....	994
<u>Variants</u> .....	994
<u>Views</u> .....	994
<u>More</u> .....	994
<b><u>File:FileCreateLogFiles.PNG</u></b> .....	<b>995</b>
<u>File history</u> .....	996
<u>File usage</u> .....	996
<u>Namespaces</u> .....	996
<u>Variants</u> .....	996
<u>Views</u> .....	996
<u>More</u> .....	996
<b><u>File:FileExplore.PNG</u></b> .....	<b>997</b>
<u>File history</u> .....	998
<u>File usage</u> .....	998
<u>Namespaces</u> .....	998
<u>Variants</u> .....	998
<u>Views</u> .....	998
<u>More</u> .....	998
<b><u>File:FileExplore.PNG</u></b> .....	<b>1000</b>
<u>File history</u> .....	1001
<u>File usage</u> .....	1001
<u>Namespaces</u> .....	1001
<u>Variants</u> .....	1001
<u>Views</u> .....	1001
<u>More</u> .....	1001

# Table of Contents

<b><u>File:file-import-cabrillo.gif</u></b> .....	<b>1003</b>
<u>File history</u> .....	1003
<u>File usage</u> .....	1003
<u>Namespaces</u> .....	1003
<u>Variants</u> .....	1004
<u>Views</u> .....	1004
<u>More</u> .....	1004
<b><u>File:file-import-cabrillo.gif</u></b> .....	<b>1005</b>
<u>File history</u> .....	1005
<u>File usage</u> .....	1005
<u>Namespaces</u> .....	1005
<u>Variants</u> .....	1006
<u>Views</u> .....	1006
<u>More</u> .....	1006
<b><u>File:file-import-editest.gif</u></b> .....	<b>1007</b>
<u>File history</u> .....	1007
<u>File usage</u> .....	1007
<u>Namespaces</u> .....	1007
<u>Variants</u> .....	1008
<u>Views</u> .....	1008
<u>More</u> .....	1008
<b><u>File:file-import-editest.gif</u></b> .....	<b>1009</b>
<u>File history</u> .....	1009
<u>File usage</u> .....	1009
<u>Namespaces</u> .....	1009
<u>Variants</u> .....	1010
<u>Views</u> .....	1010
<u>More</u> .....	1010
<b><u>File:FileMRU.PNG</u></b> .....	<b>1011</b>
<u>File history</u> .....	1011
<u>File usage</u> .....	1011
<u>Namespaces</u> .....	1011
<u>Variants</u> .....	1011
<u>Views</u> .....	1011
<u>More</u> .....	1012
<b><u>File:FileMRU.PNG</u></b> .....	<b>1013</b>
<u>File history</u> .....	1013
<u>File usage</u> .....	1013
<u>Namespaces</u> .....	1013
<u>Variants</u> .....	1013
<u>Views</u> .....	1013
<u>More</u> .....	1014

# Table of Contents

<b><u>File:FileNew.gif</u></b> .....	<b>1015</b>
<u>File history</u> .....	1015
<u>File usage</u> .....	1015
<u>Namespaces</u> .....	1016
<u>Variants</u> .....	1016
<u>Views</u> .....	1016
<u>More</u> .....	1016
<b><u>File:FileNew.gif</u></b> .....	<b>1017</b>
<u>File history</u> .....	1017
<u>File usage</u> .....	1017
<u>Namespaces</u> .....	1018
<u>Variants</u> .....	1018
<u>Views</u> .....	1018
<u>More</u> .....	1018
<b><u>File:FileOpen.gif</u></b> .....	<b>1019</b>
<u>File history</u> .....	1020
<u>File usage</u> .....	1020
<u>Namespaces</u> .....	1020
<u>Variants</u> .....	1020
<u>Views</u> .....	1020
<u>More</u> .....	1020
<b><u>File:FileOpen.gif</u></b> .....	<b>1021</b>
<u>File history</u> .....	1022
<u>File usage</u> .....	1022
<u>Namespaces</u> .....	1022
<u>Variants</u> .....	1022
<u>Views</u> .....	1022
<u>More</u> .....	1022
<b><u>File:FloatingWindows.gif</u></b> .....	<b>1023</b>
<u>File history</u> .....	1024
<u>File usage</u> .....	1024
<u>Namespaces</u> .....	1024
<u>Variants</u> .....	1024
<u>Views</u> .....	1024
<u>More</u> .....	1024
<b><u>File:FloatingWindows.gif</u></b> .....	<b>1025</b>
<u>File history</u> .....	1026
<u>File usage</u> .....	1026
<u>Namespaces</u> .....	1026
<u>Variants</u> .....	1026
<u>Views</u> .....	1026
<u>More</u> .....	1026

# Table of Contents

<b><u>File:FT101DX CW-Setting Menu.gif</u></b> .....	<b>1027</b>
<u>File history</u> .....	1028
<u>File usage</u> .....	1028
<u>Metadata</u> .....	1028
<u>Namespaces</u> .....	1028
<u>Variants</u> .....	1028
<u>Views</u> .....	1028
<u>More</u> .....	1028
<b><u>File:FT101DX CW-Setting Menu.gif</u></b> .....	<b>1030</b>
<u>File history</u> .....	1031
<u>File usage</u> .....	1031
<u>Metadata</u> .....	1031
<u>Namespaces</u> .....	1031
<u>Variants</u> .....	1031
<u>Views</u> .....	1031
<u>More</u> .....	1031
<b><u>File:FT101DX General Menu.gif</u></b> .....	<b>1033</b>
<u>File history</u> .....	1034
<u>File usage</u> .....	1034
<u>Metadata</u> .....	1034
<u>Namespaces</u> .....	1034
<u>Variants</u> .....	1034
<u>Views</u> .....	1034
<u>More</u> .....	1034
<b><u>File:FT101DX General Menu.gif</u></b> .....	<b>1036</b>
<u>File history</u> .....	1037
<u>File usage</u> .....	1037
<u>Metadata</u> .....	1037
<u>Namespaces</u> .....	1037
<u>Variants</u> .....	1037
<u>Views</u> .....	1037
<u>More</u> .....	1037
<b><u>File:GabSend.gif</u></b> .....	<b>1039</b>
<u>File history</u> .....	1039
<u>File usage</u> .....	1039
<u>Namespaces</u> .....	1039
<u>Variants</u> .....	1039
<u>Views</u> .....	1039
<u>More</u> .....	1040
<b><u>File:GabSend.gif</u></b> .....	<b>1041</b>
<u>File history</u> .....	1041
<u>File usage</u> .....	1041
<u>Namespaces</u> .....	1041



# Table of Contents

<b><u>File:GabSend.gif</u></b>	
<u>Variants</u> .....	1041
<u>Views</u> .....	1041
<u>More</u> .....	1042
<b><u>File:gab-sending.gif</u></b> .....	<b>1043</b>
<u>File history</u> .....	1043
<u>File usage</u> .....	1043
<u>Namespaces</u> .....	1043
<u>Variants</u> .....	1043
<u>Views</u> .....	1043
<u>More</u> .....	1043
<b><u>File:gab-sending.gif</u></b> .....	<b>1045</b>
<u>File history</u> .....	1045
<u>File usage</u> .....	1045
<u>Namespaces</u> .....	1045
<u>Variants</u> .....	1045
<u>Views</u> .....	1045
<u>More</u> .....	1045
<b><u>File:gab-window.gif</u></b> .....	<b>1047</b>
<u>File history</u> .....	1047
<u>File usage</u> .....	1047
<u>Namespaces</u> .....	1047
<u>Variants</u> .....	1047
<u>Views</u> .....	1047
<u>More</u> .....	1048
<b><u>File:gab-window.gif</u></b> .....	<b>1049</b>
<u>File history</u> .....	1049
<u>File usage</u> .....	1049
<u>Namespaces</u> .....	1049
<u>Variants</u> .....	1049
<u>Views</u> .....	1049
<u>More</u> .....	1050
<b><u>File:GabWindowNoSyncClearLogNowSync.gif</u></b> .....	<b>1051</b>
<u>File history</u> .....	1051
<u>File usage</u> .....	1051
<u>Namespaces</u> .....	1051
<u>Variants</u> .....	1051
<u>Views</u> .....	1051
<u>More</u> .....	1052
<b><u>File:GabWindowNoSyncClearLogNowSync.gif</u></b> .....	<b>1053</b>
<u>File history</u> .....	1053
<u>File usage</u> .....	1053

# Table of Contents

<b><u>File:GabWindowNoSyncClearLogNowSync.gif</u></b>	
<u>Namespaces</u> .....	1053
<u>Variants</u> .....	1053
<u>Views</u> .....	1053
<u>More</u> .....	1054
<b><u>File:gotoCallsign.gif</u></b> .....	<b>1055</b>
<u>File history</u> .....	1055
<u>File usage</u> .....	1055
<u>Metadata</u> .....	1055
<u>Namespaces</u> .....	1056
<u>Variants</u> .....	1056
<u>Views</u> .....	1056
<u>More</u> .....	1056
<b><u>File:gotoCallsign.gif</u></b> .....	<b>1057</b>
<u>File history</u> .....	1057
<u>File usage</u> .....	1057
<u>Metadata</u> .....	1057
<u>Namespaces</u> .....	1058
<u>Variants</u> .....	1058
<u>Views</u> .....	1058
<u>More</u> .....	1058
<b><u>File:gotoOSO.gif</u></b> .....	<b>1059</b>
<u>File history</u> .....	1059
<u>File usage</u> .....	1059
<u>Namespaces</u> .....	1059
<u>Variants</u> .....	1059
<u>Views</u> .....	1059
<u>More</u> .....	1059
<b><u>File:gotoOSO.gif</u></b> .....	<b>1061</b>
<u>File history</u> .....	1061
<u>File usage</u> .....	1061
<u>Namespaces</u> .....	1061
<u>Variants</u> .....	1061
<u>Views</u> .....	1061
<u>More</u> .....	1061
<b><u>File:GridSquareMapPopUp.PNG</u></b> .....	<b>1063</b>
<u>File history</u> .....	1064
<u>File usage</u> .....	1064
<u>Namespaces</u> .....	1064
<u>Variants</u> .....	1064
<u>Views</u> .....	1064
<u>More</u> .....	1064

# Table of Contents

<b><u>File:GridSquareMapPopUp.PNG</u></b> .....	<b>1066</b>
<u>File history</u> .....	1067
<u>File usage</u> .....	1067
<u>Namespaces</u> .....	1067
<u>Variants</u> .....	1067
<u>Views</u> .....	1067
<u>More</u> .....	1067
<b><u>File:GridSquareMapProperties.PNG</u></b> .....	<b>1069</b>
<u>File history</u> .....	1070
<u>File usage</u> .....	1070
<u>Namespaces</u> .....	1070
<u>Variants</u> .....	1070
<u>Views</u> .....	1070
<u>More</u> .....	1070
<b><u>File:GridSquareMapProperties.PNG</u></b> .....	<b>1072</b>
<u>File history</u> .....	1073
<u>File usage</u> .....	1073
<u>Namespaces</u> .....	1073
<u>Variants</u> .....	1073
<u>Views</u> .....	1073
<u>More</u> .....	1073
<b><u>File:HamCapAnt.gif</u></b> .....	<b>1075</b>
<u>File history</u> .....	1075
<u>File usage</u> .....	1075
<u>Namespaces</u> .....	1076
<u>Variants</u> .....	1076
<u>Views</u> .....	1076
<u>More</u> .....	1076
<b><u>File:HamCapAnt.gif</u></b> .....	<b>1077</b>
<u>File history</u> .....	1077
<u>File usage</u> .....	1077
<u>Namespaces</u> .....	1078
<u>Variants</u> .....	1078
<u>Views</u> .....	1078
<u>More</u> .....	1078
<b><u>File:HamCapChart.gif</u></b> .....	<b>1079</b>
<u>File history</u> .....	1079
<u>File usage</u> .....	1079
<u>Namespaces</u> .....	1080
<u>Variants</u> .....	1080
<u>Views</u> .....	1080
<u>More</u> .....	1080

# Table of Contents

<b><u>File:HamCapChart.gif</u></b> .....	<b>1081</b>
<u>File history</u> .....	1081
<u>File usage</u> .....	1081
<u>Namespaces</u> .....	1082
<u>Variants</u> .....	1082
<u>Views</u> .....	1082
<u>More</u> .....	1082
<b><u>File:HamCapForeground.gif</u></b> .....	<b>1083</b>
<u>File history</u> .....	1084
<u>File usage</u> .....	1084
<u>Namespaces</u> .....	1084
<u>Variants</u> .....	1084
<u>Views</u> .....	1084
<u>More</u> .....	1084
<b><u>File:HamCapForeground.gif</u></b> .....	<b>1086</b>
<u>File history</u> .....	1087
<u>File usage</u> .....	1087
<u>Namespaces</u> .....	1087
<u>Variants</u> .....	1087
<u>Views</u> .....	1087
<u>More</u> .....	1087
<b><u>File:HamCapMap.gif</u></b> .....	<b>1089</b>
<u>File history</u> .....	1089
<u>File usage</u> .....	1089
<u>Namespaces</u> .....	1090
<u>Variants</u> .....	1090
<u>Views</u> .....	1090
<u>More</u> .....	1090
<b><u>File:HamCapMap.gif</u></b> .....	<b>1091</b>
<u>File history</u> .....	1091
<u>File usage</u> .....	1091
<u>Namespaces</u> .....	1092
<u>Variants</u> .....	1092
<u>Views</u> .....	1092
<u>More</u> .....	1092
<b><u>File:HamCapParams.gif</u></b> .....	<b>1093</b>
<u>File history</u> .....	1093
<u>File usage</u> .....	1093
<u>Namespaces</u> .....	1094
<u>Variants</u> .....	1094
<u>Views</u> .....	1094
<u>More</u> .....	1094

# Table of Contents

<b><u>File:HamCapParams.gif</u></b> .....	<b>1095</b>
<u>File history</u> .....	1095
<u>File usage</u> .....	1095
<u>Namespaces</u> .....	1096
<u>Variants</u> .....	1096
<u>Views</u> .....	1096
<u>More</u> .....	1096
<b><u>File:HamCAPprediction.gif</u></b> .....	<b>1097</b>
<u>File history</u> .....	1097
<u>File usage</u> .....	1098
<u>Namespaces</u> .....	1098
<u>Variants</u> .....	1098
<u>Views</u> .....	1098
<u>More</u> .....	1098
<b><u>File:HamCAPprediction.gif</u></b> .....	<b>1099</b>
<u>File history</u> .....	1099
<u>File usage</u> .....	1100
<u>Namespaces</u> .....	1100
<u>Variants</u> .....	1100
<u>Views</u> .....	1100
<u>More</u> .....	1100
<b><u>File:HamCapSetting.gif</u></b> .....	<b>1101</b>
<u>File history</u> .....	1101
<u>File usage</u> .....	1101
<u>Namespaces</u> .....	1102
<u>Variants</u> .....	1102
<u>Views</u> .....	1102
<u>More</u> .....	1102
<b><u>File:HamCapSetting.gif</u></b> .....	<b>1103</b>
<u>File history</u> .....	1103
<u>File usage</u> .....	1103
<u>Namespaces</u> .....	1104
<u>Variants</u> .....	1104
<u>Views</u> .....	1104
<u>More</u> .....	1104
<b><u>File:HelpAbout.PNG</u></b> .....	<b>1105</b>
<u>File history</u> .....	1105
<u>File usage</u> .....	1105
<u>Namespaces</u> .....	1105
<u>Variants</u> .....	1105
<u>Views</u> .....	1105
<u>More</u> .....	1106

# Table of Contents

<b><u>File:HelpAbout.PNG</u></b> .....	<b>1107</b>
<u>File history</u> .....	1107
<u>File usage</u> .....	1107
<u>Namespaces</u> .....	1107
<u>Variants</u> .....	1107
<u>Views</u> .....	1107
<u>More</u> .....	1108
<b><u>File:HelpRegisterSoftware.gif</u></b> .....	<b>1109</b>
<u>File history</u> .....	1109
<u>File usage</u> .....	1109
<u>Namespaces</u> .....	1109
<u>Variants</u> .....	1109
<u>Views</u> .....	1109
<u>More</u> .....	1110
<b><u>File:HelpRegisterSoftware.gif</u></b> .....	<b>1111</b>
<u>File history</u> .....	1111
<u>File usage</u> .....	1111
<u>Namespaces</u> .....	1111
<u>Variants</u> .....	1111
<u>Views</u> .....	1111
<u>More</u> .....	1112
<b><u>File:IC-275HSetupComProperties.PNG</u></b> .....	<b>1113</b>
<u>File history</u> .....	1113
<u>File usage</u> .....	1113
<u>Namespaces</u> .....	1113
<u>Variants</u> .....	1114
<u>Views</u> .....	1114
<u>More</u> .....	1114
<b><u>File:IC-275HSetupComProperties.PNG</u></b> .....	<b>1115</b>
<u>File history</u> .....	1115
<u>File usage</u> .....	1115
<u>Namespaces</u> .....	1115
<u>Variants</u> .....	1116
<u>Views</u> .....	1116
<u>More</u> .....	1116
<b><u>File:IC-275HSetupProperties.PNG</u></b> .....	<b>1117</b>
<u>File history</u> .....	1118
<u>File usage</u> .....	1118
<u>Namespaces</u> .....	1118
<u>Variants</u> .....	1118
<u>Views</u> .....	1118
<u>More</u> .....	1118

# Table of Contents

<b><u>File:IC-275HSetupProperties.PNG</u></b> .....	<b>1119</b>
<u>File history</u> .....	1120
<u>File usage</u> .....	1120
<u>Namespaces</u> .....	1120
<u>Variants</u> .....	1120
<u>Views</u> .....	1120
<u>More</u> .....	1120
<b><u>File:IconsBar.gif</u></b> .....	<b>1121</b>
<u>File history</u> .....	1121
<u>File usage</u> .....	1121
<u>Namespaces</u> .....	1121
<u>Variants</u> .....	1121
<u>Views</u> .....	1121
<u>More</u> .....	1122
<b><u>File:IconsBar.gif</u></b> .....	<b>1123</b>
<u>File history</u> .....	1123
<u>File usage</u> .....	1123
<u>Namespaces</u> .....	1123
<u>Variants</u> .....	1123
<u>Views</u> .....	1123
<u>More</u> .....	1124
<b><u>File:Interfaces.gif</u></b> .....	<b>1125</b>
<u>File history</u> .....	1126
<u>File usage</u> .....	1126
<u>Metadata</u> .....	1126
<u>Namespaces</u> .....	1126
<u>Variants</u> .....	1127
<u>Views</u> .....	1127
<u>More</u> .....	1127
<b><u>File:Interfaces.gif</u></b> .....	<b>1128</b>
<u>File history</u> .....	1129
<u>File usage</u> .....	1129
<u>Metadata</u> .....	1129
<u>Namespaces</u> .....	1129
<u>Variants</u> .....	1130
<u>Views</u> .....	1130
<u>More</u> .....	1130
<b><u>File:keyboardmode.gif</u></b> .....	<b>1131</b>
<u>File history</u> .....	1131
<u>File usage</u> .....	1131
<u>Namespaces</u> .....	1131
<u>Variants</u> .....	1131
<u>Views</u> .....	1132

# Table of Contents

<b><u>File:keyboardmode.gif</u></b>	
<u>More</u> .....	1132
<b><u>File:keyboardmode.gif</u></b> .....	<b>1133</b>
<u>File history</u> .....	1133
<u>File usage</u> .....	1133
<u>Namespaces</u> .....	1133
<u>Variants</u> .....	1133
<u>Views</u> .....	1134
<u>More</u> .....	1134
<b><u>File:LineInPopUp.gif</u></b> .....	<b>1135</b>
<u>File history</u> .....	1136
<u>File usage</u> .....	1136
<u>Namespaces</u> .....	1136
<u>Variants</u> .....	1136
<u>Views</u> .....	1136
<u>More</u> .....	1136
<b><u>File:LineInPopUp.gif</u></b> .....	<b>1137</b>
<u>File history</u> .....	1138
<u>File usage</u> .....	1138
<u>Namespaces</u> .....	1138
<u>Variants</u> .....	1138
<u>Views</u> .....	1138
<u>More</u> .....	1138
<b><u>File:LiveScoreBroadcasting.gif</u></b> .....	<b>1139</b>
<u>File history</u> .....	1139
<u>File usage</u> .....	1139
<u>Namespaces</u> .....	1140
<u>Variants</u> .....	1140
<u>Views</u> .....	1140
<u>More</u> .....	1140
<b><u>File:LiveScoreBroadcasting.gif</u></b> .....	<b>1141</b>
<u>File history</u> .....	1141
<u>File usage</u> .....	1141
<u>Namespaces</u> .....	1142
<u>Variants</u> .....	1142
<u>Views</u> .....	1142
<u>More</u> .....	1142
<b><u>File:LogEntryWindow.PNG</u></b> .....	<b>1143</b>
<u>File history</u> .....	1143
<u>File usage</u> .....	1143
<u>Namespaces</u> .....	1144
<u>Variants</u> .....	1144



# Table of Contents

<b><u>File:LogEntryWindow.PNG</u></b>	
<u>Views</u> .....	1144
<u>More</u> .....	1144
<b><u>File:LogEntryWindow.PNG.....</u></b>	<b>1145</b>
<u>File history</u> .....	1145
<u>File usage</u> .....	1145
<u>Namespaces</u> .....	1146
<u>Variants</u> .....	1146
<u>Views</u> .....	1146
<u>More</u> .....	1146
<b><u>File:LogFontSize.PNG.....</u></b>	<b>1147</b>
<u>File history</u> .....	1147
<u>File usage</u> .....	1147
<u>Metadata</u> .....	1148
<u>Namespaces</u> .....	1148
<u>Variants</u> .....	1148
<u>Views</u> .....	1148
<u>More</u> .....	1148
<b><u>File:LogFontSize.PNG.....</u></b>	<b>1149</b>
<u>File history</u> .....	1149
<u>File usage</u> .....	1149
<u>Metadata</u> .....	1150
<u>Namespaces</u> .....	1150
<u>Variants</u> .....	1150
<u>Views</u> .....	1150
<u>More</u> .....	1150
<b><u>File:log-qtinfo.gif.....</u></b>	<b>1151</b>
<u>File history</u> .....	1151
<u>File usage</u> .....	1151
<u>Namespaces</u> .....	1152
<u>Variants</u> .....	1152
<u>Views</u> .....	1152
<u>More</u> .....	1152
<b><u>File:log-qtinfo.gif.....</u></b>	<b>1153</b>
<u>File history</u> .....	1153
<u>File usage</u> .....	1153
<u>Namespaces</u> .....	1154
<u>Variants</u> .....	1154
<u>Views</u> .....	1154
<u>More</u> .....	1154

# Table of Contents

<b><u>File:LogSpecificExtraDataFiles.gif</u></b> .....	<b>1155</b>
<u>File history</u> .....	1155
<u>File usage</u> .....	1155
<u>Namespaces</u> .....	1155
<u>Variants</u> .....	1155
<u>Views</u> .....	1156
<u>More</u> .....	1156
<b><u>File:LogSpecificExtraDataFiles.gif</u></b> .....	<b>1157</b>
<u>File history</u> .....	1157
<u>File usage</u> .....	1157
<u>Namespaces</u> .....	1157
<u>Variants</u> .....	1157
<u>Views</u> .....	1158
<u>More</u> .....	1158
<b><u>File:lpt1-properties.gif</u></b> .....	<b>1159</b>
<u>File history</u> .....	1159
<u>File usage</u> .....	1160
<u>Namespaces</u> .....	1160
<u>Variants</u> .....	1160
<u>Views</u> .....	1160
<u>More</u> .....	1160
<b><u>File:LPT1Properties.gif</u></b> .....	<b>1161</b>
<u>File history</u> .....	1161
<u>File usage</u> .....	1162
<u>Namespaces</u> .....	1162
<u>Variants</u> .....	1162
<u>Views</u> .....	1162
<u>More</u> .....	1162
<b><u>File:lpt1-properties.gif</u></b> .....	<b>1163</b>
<u>File history</u> .....	1163
<u>File usage</u> .....	1164
<u>Namespaces</u> .....	1164
<u>Variants</u> .....	1164
<u>Views</u> .....	1164
<u>More</u> .....	1164
<b><u>File:LPT1Properties.gif</u></b> .....	<b>1165</b>
<u>File history</u> .....	1165
<u>File usage</u> .....	1166
<u>Namespaces</u> .....	1166
<u>Variants</u> .....	1166
<u>Views</u> .....	1166
<u>More</u> .....	1166

# Table of Contents

<b><u>File:LPTPinsMapping.gif</u></b> .....	<b>1167</b>
<u>File history</u> .....	1168
<u>File usage</u> .....	1168
<u>Metadata</u> .....	1168
<u>Namespaces</u> .....	1168
<u>Variants</u> .....	1168
<u>Views</u> .....	1168
<u>More</u> .....	1169
<b><u>File:LPTPinsMapping.gif</u></b> .....	<b>1170</b>
<u>File history</u> .....	1171
<u>File usage</u> .....	1171
<u>Metadata</u> .....	1171
<u>Namespaces</u> .....	1171
<u>Variants</u> .....	1171
<u>Views</u> .....	1171
<u>More</u> .....	1172
<b><u>File:LPTSettingsForDXDoublers.gif</u></b> .....	<b>1173</b>
<u>File history</u> .....	1173
<u>File usage</u> .....	1174
<u>Namespaces</u> .....	1174
<u>Variants</u> .....	1174
<u>Views</u> .....	1174
<u>More</u> .....	1174
<b><u>File:LPTSettingsForDXDoublers.gif</u></b> .....	<b>1175</b>
<u>File history</u> .....	1175
<u>File usage</u> .....	1176
<u>Namespaces</u> .....	1176
<u>Variants</u> .....	1176
<u>Views</u> .....	1176
<u>More</u> .....	1176
<b><u>File:MergeFileSelect.PNG</u></b> .....	<b>1177</b>
<u>File history</u> .....	1177
<u>File usage</u> .....	1177
<u>Namespaces</u> .....	1178
<u>Variants</u> .....	1178
<u>Views</u> .....	1178
<u>More</u> .....	1178
<b><u>File:MergeFileSelect.PNG</u></b> .....	<b>1179</b>
<u>File history</u> .....	1179
<u>File usage</u> .....	1179
<u>Namespaces</u> .....	1180
<u>Variants</u> .....	1180
<u>Views</u> .....	1180

# Table of Contents

<b><u>File:MergeFileSelect.PNG</u></b>	
<u>More</u> .....	1180
<b><u>File:MergeFileStart.gif</u></b> .....	<b>1181</b>
<u>File history</u> .....	1181
<u>File usage</u> .....	1181
<u>Namespaces</u> .....	1181
<u>Variants</u> .....	1182
<u>Views</u> .....	1182
<u>More</u> .....	1182
<b><u>File:MergeFileStart.gif</u></b> .....	<b>1183</b>
<u>File history</u> .....	1183
<u>File usage</u> .....	1183
<u>Namespaces</u> .....	1183
<u>Variants</u> .....	1184
<u>Views</u> .....	1184
<u>More</u> .....	1184
<b><u>File:MergeUnableDifferentRules.gif</u></b> .....	<b>1185</b>
<u>File history</u> .....	1185
<u>File usage</u> .....	1185
<u>Namespaces</u> .....	1185
<u>Variants</u> .....	1185
<u>Views</u> .....	1185
<u>More</u> .....	1186
<b><u>File:MergeUnableDifferentRules.gif</u></b> .....	<b>1187</b>
<u>File history</u> .....	1187
<u>File usage</u> .....	1187
<u>Namespaces</u> .....	1187
<u>Variants</u> .....	1187
<u>Views</u> .....	1187
<u>More</u> .....	1188
<b><u>File:MicohamUsbInterfaceIC.PNG</u></b> .....	<b>1189</b>
<u>File history</u> .....	1190
<u>File usage</u> .....	1190
<u>Namespaces</u> .....	1190
<u>Variants</u> .....	1190
<u>Views</u> .....	1190
<u>More</u> .....	1190
<b><u>File:MicohamUsbInterfaceIC.PNG</u></b> .....	<b>1191</b>
<u>File history</u> .....	1192
<u>File usage</u> .....	1192
<u>Namespaces</u> .....	1192
<u>Variants</u> .....	1192

# Table of Contents

<b><u>File:MicrohamUsbInterfaceIC.PNG</u></b>	
<u>Views</u> .....	1192
<u>More</u> .....	1192
<b><u>File:MicrohamDeviceRouter.gif</u></b> .....	<b>1193</b>
<u>File history</u> .....	1194
<u>File usage</u> .....	1194
<u>Namespaces</u> .....	1194
<u>Variants</u> .....	1194
<u>Views</u> .....	1194
<u>More</u> .....	1194
<b><u>File:MicrohamDeviceRouter.gif</u></b> .....	<b>1195</b>
<u>File history</u> .....	1196
<u>File usage</u> .....	1196
<u>Namespaces</u> .....	1196
<u>Variants</u> .....	1196
<u>Views</u> .....	1196
<u>More</u> .....	1196
<b><u>File:MicrohamDeviceRouterMicrokeyer1.gif</u></b> .....	<b>1197</b>
<u>File history</u> .....	1198
<u>File usage</u> .....	1198
<u>Namespaces</u> .....	1198
<u>Variants</u> .....	1198
<u>Views</u> .....	1198
<u>More</u> .....	1198
<b><u>File:MicrohamDeviceRouterMicrokeyer1.gif</u></b> .....	<b>1199</b>
<u>File history</u> .....	1200
<u>File usage</u> .....	1200
<u>Namespaces</u> .....	1200
<u>Variants</u> .....	1200
<u>Views</u> .....	1200
<u>More</u> .....	1200
<b><u>File:MicrohamDeviceRouterMicrokeyer2.gif</u></b> .....	<b>1201</b>
<u>File history</u> .....	1202
<u>File usage</u> .....	1202
<u>Namespaces</u> .....	1202
<u>Variants</u> .....	1202
<u>Views</u> .....	1202
<u>More</u> .....	1202
<b><u>File:MicrohamDeviceRouterMicrokeyer2-FT1000D.gif</u></b> .....	<b>1203</b>
<u>File history</u> .....	1204
<u>File usage</u> .....	1204
<u>Metadata</u> .....	1204

# Table of Contents

<b><u>File:MicrohamDeviceRouterMicrokeyer2-FT1000D.gif</u></b>	
<u>Namespaces</u> .....	1204
<u>Variants</u> .....	1204
<u>Views</u> .....	1204
<u>More</u> .....	1205
<b><u>File:MicrohamDeviceRouterMicrokeyer2-FT1000D.gif</u></b> .....	<b>1206</b>
<u>File history</u> .....	1207
<u>File usage</u> .....	1207
<u>Metadata</u> .....	1207
<u>Namespaces</u> .....	1207
<u>Variants</u> .....	1207
<u>Views</u> .....	1207
<u>More</u> .....	1208
<b><u>File:MicrohamDeviceRouterMicrokeyer2.gif</u></b> .....	<b>1209</b>
<u>File history</u> .....	1210
<u>File usage</u> .....	1210
<u>Namespaces</u> .....	1210
<u>Variants</u> .....	1210
<u>Views</u> .....	1210
<u>More</u> .....	1210
<b><u>File:MicrohamDeviceRouterMicrokeyer2-IC-7410.gif</u></b> .....	<b>1211</b>
<u>File history</u> .....	1212
<u>File usage</u> .....	1212
<u>Metadata</u> .....	1212
<u>Namespaces</u> .....	1212
<u>Variants</u> .....	1212
<u>Views</u> .....	1212
<u>More</u> .....	1213
<b><u>File:MicrohamDeviceRouterMicrokeyer2-IC-7410.gif</u></b> .....	<b>1214</b>
<u>File history</u> .....	1215
<u>File usage</u> .....	1215
<u>Metadata</u> .....	1215
<u>Namespaces</u> .....	1215
<u>Variants</u> .....	1215
<u>Views</u> .....	1215
<u>More</u> .....	1216
<b><u>File:MicrohamDeviceRouterMicrokeyer3.gif</u></b> .....	<b>1217</b>
<u>File history</u> .....	1218
<u>File usage</u> .....	1218
<u>Namespaces</u> .....	1218
<u>Variants</u> .....	1218
<u>Views</u> .....	1218
<u>More</u> .....	1218

# Table of Contents

<b><u>File:MicrohamDeviceRouterMicrokeyer3.gif</u></b> .....	<b>1219</b>
<u>File history</u> .....	1220
<u>File usage</u> .....	1220
<u>Namespaces</u> .....	1220
<u>Variants</u> .....	1220
<u>Views</u> .....	1220
<u>More</u> .....	1220
<b><u>File:MicrohamDeviceRouterMicrokeyer4.gif</u></b> .....	<b>1221</b>
<u>File history</u> .....	1222
<u>File usage</u> .....	1222
<u>Namespaces</u> .....	1222
<u>Variants</u> .....	1222
<u>Views</u> .....	1222
<u>More</u> .....	1222
<b><u>File:MicrohamDeviceRouterMicrokeyer4.gif</u></b> .....	<b>1224</b>
<u>File history</u> .....	1225
<u>File usage</u> .....	1225
<u>Namespaces</u> .....	1225
<u>Variants</u> .....	1225
<u>Views</u> .....	1225
<u>More</u> .....	1225
<b><u>File:MicrohamDeviceRouterMicrokeyer5.gif</u></b> .....	<b>1227</b>
<u>File history</u> .....	1228
<u>File usage</u> .....	1228
<u>Namespaces</u> .....	1228
<u>Variants</u> .....	1228
<u>Views</u> .....	1228
<u>More</u> .....	1228
<b><u>File:MicrohamDeviceRouterMicrokeyer5.gif</u></b> .....	<b>1230</b>
<u>File history</u> .....	1231
<u>File usage</u> .....	1231
<u>Namespaces</u> .....	1231
<u>Variants</u> .....	1231
<u>Views</u> .....	1231
<u>More</u> .....	1231
<b><u>File:MicrohamDeviceRouterMicrokeyer6.gif</u></b> .....	<b>1233</b>
<u>File history</u> .....	1234
<u>File usage</u> .....	1234
<u>Namespaces</u> .....	1234
<u>Variants</u> .....	1234
<u>Views</u> .....	1234
<u>More</u> .....	1234

# Table of Contents

<b><u>File:MicrohamDeviceRouterMicrokeyer6.gif</u></b> .....	<b>1236</b>
<u>File history</u> .....	1237
<u>File usage</u> .....	1237
<u>Namespaces</u> .....	1237
<u>Variants</u> .....	1237
<u>Views</u> .....	1237
<u>More</u> .....	1237
<b><u>File:MicrohamDeviceRouterMKII1.gif</u></b> .....	<b>1239</b>
<u>File history</u> .....	1240
<u>File usage</u> .....	1240
<u>Namespaces</u> .....	1240
<u>Variants</u> .....	1240
<u>Views</u> .....	1240
<u>More</u> .....	1240
<b><u>File:MicrohamDeviceRouterMKIII-FT1000D.gif</u></b> .....	<b>1241</b>
<u>File history</u> .....	1242
<u>File usage</u> .....	1242
<u>Metadata</u> .....	1242
<u>Namespaces</u> .....	1242
<u>Variants</u> .....	1242
<u>Views</u> .....	1242
<u>More</u> .....	1242
<b><u>File:MicrohamDeviceRouterMKIII-FT1000D.gif</u></b> .....	<b>1244</b>
<u>File history</u> .....	1245
<u>File usage</u> .....	1245
<u>Metadata</u> .....	1245
<u>Namespaces</u> .....	1245
<u>Variants</u> .....	1245
<u>Views</u> .....	1245
<u>More</u> .....	1245
<b><u>File:MicrohamDeviceRouterMKIII1.gif</u></b> .....	<b>1247</b>
<u>File history</u> .....	1248
<u>File usage</u> .....	1248
<u>Namespaces</u> .....	1248
<u>Variants</u> .....	1248
<u>Views</u> .....	1248
<u>More</u> .....	1248
<b><u>File:MicrohamDeviceRouterMKIII1-IC-7410.gif</u></b> .....	<b>1249</b>
<u>File history</u> .....	1250
<u>File usage</u> .....	1250
<u>Metadata</u> .....	1250
<u>Namespaces</u> .....	1250
<u>Variants</u> .....	1250



# Table of Contents

<b><u>File:MicrohamDeviceRouterMKII1-IC-7410.gif</u></b>	
<u>Views</u> .....	1250
<u>More</u> .....	1250
<b><u>File:MicrohamDeviceRouterMKII1-IC-7410.gif</u></b> .....	<b>1252</b>
<u>File history</u> .....	1253
<u>File usage</u> .....	1253
<u>Metadata</u> .....	1253
<u>Namespaces</u> .....	1253
<u>Variants</u> .....	1253
<u>Views</u> .....	1253
<u>More</u> .....	1253
<b><u>File:MicrohamDeviceRouterMKII3.gif</u></b> .....	<b>1255</b>
<u>File history</u> .....	1256
<u>File usage</u> .....	1256
<u>Namespaces</u> .....	1256
<u>Variants</u> .....	1256
<u>Views</u> .....	1256
<u>More</u> .....	1256
<b><u>File:MicrohamDeviceRouterMKII3.gif</u></b> .....	<b>1257</b>
<u>File history</u> .....	1258
<u>File usage</u> .....	1258
<u>Namespaces</u> .....	1258
<u>Variants</u> .....	1258
<u>Views</u> .....	1258
<u>More</u> .....	1258
<b><u>File:MicrohamDeviceRouterMKII5.gif</u></b> .....	<b>1259</b>
<u>File history</u> .....	1260
<u>File usage</u> .....	1260
<u>Namespaces</u> .....	1260
<u>Variants</u> .....	1260
<u>Views</u> .....	1260
<u>More</u> .....	1260
<b><u>File:MicrohamDeviceRouterMKII5.gif</u></b> .....	<b>1261</b>
<u>File history</u> .....	1262
<u>File usage</u> .....	1262
<u>Namespaces</u> .....	1262
<u>Variants</u> .....	1262
<u>Views</u> .....	1262
<u>More</u> .....	1262
<b><u>File:MicrohamDeviceRouterMKII6.gif</u></b> .....	<b>1263</b>
<u>File history</u> .....	1264
<u>File usage</u> .....	1264

# Table of Contents

<b><u>File:MicrohamDeviceRouterMKII6.gif</u></b>	
<u>Namespaces</u> .....	1264
<u>Variants</u> .....	1264
<u>Views</u> .....	1264
<u>More</u> .....	1264
<b><u>File:MicrohamDeviceRouterMKII6.gif</u></b> .....	<b>1265</b>
<u>File history</u> .....	1266
<u>File usage</u> .....	1266
<u>Namespaces</u> .....	1266
<u>Variants</u> .....	1266
<u>Views</u> .....	1266
<u>More</u> .....	1266
<b><u>File:MicrohamDeviceRouterMKII7.gif</u></b> .....	<b>1267</b>
<u>File history</u> .....	1268
<u>File usage</u> .....	1268
<u>Namespaces</u> .....	1268
<u>Variants</u> .....	1268
<u>Views</u> .....	1268
<u>More</u> .....	1268
<b><u>File:MicrohamDeviceRouterMKII7.gif</u></b> .....	<b>1269</b>
<u>File history</u> .....	1270
<u>File usage</u> .....	1270
<u>Namespaces</u> .....	1270
<u>Variants</u> .....	1270
<u>Views</u> .....	1270
<u>More</u> .....	1270
<b><u>File:MicrohamUsbInterfaceIC.PNG</u></b> .....	<b>1271</b>
<u>File history</u> .....	1272
<u>File usage</u> .....	1272
<u>Namespaces</u> .....	1272
<u>Variants</u> .....	1272
<u>Views</u> .....	1272
<u>More</u> .....	1272
<b><u>File:MicrohamUsbInterfaceIC.PNG</u></b> .....	<b>1274</b>
<u>File history</u> .....	1275
<u>File usage</u> .....	1275
<u>Namespaces</u> .....	1275
<u>Variants</u> .....	1275
<u>Views</u> .....	1275
<u>More</u> .....	1275

# Table of Contents

<b><u>File:MK2Rsetup1.jpg</u></b> .....	<b>1277</b>
<u>File history</u> .....	1278
<u>File usage</u> .....	1278
<u>Namespaces</u> .....	1278
<u>Variants</u> .....	1278
<u>Views</u> .....	1278
<u>More</u> .....	1278
<b><u>File:MK2Rsetup14.jpg</u></b> .....	<b>1280</b>
<u>File history</u> .....	1281
<u>File usage</u> .....	1281
<u>Namespaces</u> .....	1281
<u>Variants</u> .....	1281
<u>Views</u> .....	1281
<u>More</u> .....	1281
<b><u>File:MK2Rsetup14.jpg</u></b> .....	<b>1283</b>
<u>File history</u> .....	1284
<u>File usage</u> .....	1284
<u>Namespaces</u> .....	1284
<u>Variants</u> .....	1284
<u>Views</u> .....	1284
<u>More</u> .....	1284
<b><u>File:MK2Rsetup15.jpg</u></b> .....	<b>1286</b>
<u>File history</u> .....	1286
<u>File usage</u> .....	1287
<u>Namespaces</u> .....	1287
<u>Variants</u> .....	1287
<u>Views</u> .....	1287
<u>More</u> .....	1287
<b><u>File:MK2Rsetup15.jpg</u></b> .....	<b>1288</b>
<u>File history</u> .....	1288
<u>File usage</u> .....	1289
<u>Namespaces</u> .....	1289
<u>Variants</u> .....	1289
<u>Views</u> .....	1289
<u>More</u> .....	1289
<b><u>File:MK2Rsetup1.jpg</u></b> .....	<b>1290</b>
<u>File history</u> .....	1291
<u>File usage</u> .....	1291
<u>Namespaces</u> .....	1291
<u>Variants</u> .....	1291
<u>Views</u> .....	1291
<u>More</u> .....	1291

# Table of Contents

<b><u>File:MK2R Slide10.JPG</u></b> .....	<b>1293</b>
<u>File history</u> .....	1294
<u>File usage</u> .....	1294
<u>Namespaces</u> .....	1294
<u>Variants</u> .....	1294
<u>Views</u> .....	1294
<u>More</u> .....	1294
<b><u>File:MK2R Slide10.JPG</u></b> .....	<b>1295</b>
<u>File history</u> .....	1296
<u>File usage</u> .....	1296
<u>Namespaces</u> .....	1296
<u>Variants</u> .....	1296
<u>Views</u> .....	1296
<u>More</u> .....	1296
<b><u>File:MK2R Slide11.JPG</u></b> .....	<b>1297</b>
<u>File history</u> .....	1298
<u>File usage</u> .....	1298
<u>Namespaces</u> .....	1298
<u>Variants</u> .....	1298
<u>Views</u> .....	1298
<u>More</u> .....	1298
<b><u>File:MK2R Slide11.JPG</u></b> .....	<b>1299</b>
<u>File history</u> .....	1300
<u>File usage</u> .....	1300
<u>Namespaces</u> .....	1300
<u>Variants</u> .....	1300
<u>Views</u> .....	1300
<u>More</u> .....	1300
<b><u>File:MK2R Slide12.JPG</u></b> .....	<b>1301</b>
<u>File history</u> .....	1302
<u>File usage</u> .....	1302
<u>Namespaces</u> .....	1302
<u>Variants</u> .....	1302
<u>Views</u> .....	1302
<u>More</u> .....	1302
<b><u>File:MK2R Slide12.JPG</u></b> .....	<b>1303</b>
<u>File history</u> .....	1304
<u>File usage</u> .....	1304
<u>Namespaces</u> .....	1304
<u>Variants</u> .....	1304
<u>Views</u> .....	1304
<u>More</u> .....	1304

# Table of Contents

<b><u>File:MK2R Slide13.JPG</u></b> .....	<b>1305</b>
<u>File history</u> .....	1306
<u>File usage</u> .....	1306
<u>Namespaces</u> .....	1306
<u>Variants</u> .....	1306
<u>Views</u> .....	1306
<u>More</u> .....	1306
<b><u>File:MK2R Slide13.JPG</u></b> .....	<b>1307</b>
<u>File history</u> .....	1308
<u>File usage</u> .....	1308
<u>Namespaces</u> .....	1308
<u>Variants</u> .....	1308
<u>Views</u> .....	1308
<u>More</u> .....	1308
<b><u>File:MK2R Slide1.JPG</u></b> .....	<b>1309</b>
<u>File history</u> .....	1310
<u>File usage</u> .....	1310
<u>Namespaces</u> .....	1310
<u>Variants</u> .....	1310
<u>Views</u> .....	1310
<u>More</u> .....	1310
<b><u>File:MK2R Slide1.JPG</u></b> .....	<b>1311</b>
<u>File history</u> .....	1312
<u>File usage</u> .....	1312
<u>Namespaces</u> .....	1312
<u>Variants</u> .....	1312
<u>Views</u> .....	1312
<u>More</u> .....	1312
<b><u>File:MK2R Slide2.JPG</u></b> .....	<b>1313</b>
<u>File history</u> .....	1314
<u>File usage</u> .....	1314
<u>Namespaces</u> .....	1314
<u>Variants</u> .....	1314
<u>Views</u> .....	1314
<u>More</u> .....	1314
<b><u>File:MK2R Slide2.JPG</u></b> .....	<b>1315</b>
<u>File history</u> .....	1316
<u>File usage</u> .....	1316
<u>Namespaces</u> .....	1316
<u>Variants</u> .....	1316
<u>Views</u> .....	1316
<u>More</u> .....	1316

# Table of Contents

<b><u>File:MK2R Slide3.JPG</u></b> .....	<b>1317</b>
<u>File history</u> .....	1318
<u>File usage</u> .....	1318
<u>Namespaces</u> .....	1318
<u>Variants</u> .....	1318
<u>Views</u> .....	1318
<u>More</u> .....	1318
<b><u>File:MK2R Slide3.JPG</u></b> .....	<b>1319</b>
<u>File history</u> .....	1320
<u>File usage</u> .....	1320
<u>Namespaces</u> .....	1320
<u>Variants</u> .....	1320
<u>Views</u> .....	1320
<u>More</u> .....	1320
<b><u>File:MK2R Slide4.JPG</u></b> .....	<b>1321</b>
<u>File history</u> .....	1322
<u>File usage</u> .....	1322
<u>Namespaces</u> .....	1322
<u>Variants</u> .....	1322
<u>Views</u> .....	1322
<u>More</u> .....	1322
<b><u>File:MK2R Slide4.JPG</u></b> .....	<b>1323</b>
<u>File history</u> .....	1324
<u>File usage</u> .....	1324
<u>Namespaces</u> .....	1324
<u>Variants</u> .....	1324
<u>Views</u> .....	1324
<u>More</u> .....	1324
<b><u>File:MK2R Slide5.JPG</u></b> .....	<b>1325</b>
<u>File history</u> .....	1326
<u>File usage</u> .....	1326
<u>Namespaces</u> .....	1326
<u>Variants</u> .....	1326
<u>Views</u> .....	1326
<u>More</u> .....	1326
<b><u>File:MK2R Slide5.JPG</u></b> .....	<b>1327</b>
<u>File history</u> .....	1328
<u>File usage</u> .....	1328
<u>Namespaces</u> .....	1328
<u>Variants</u> .....	1328
<u>Views</u> .....	1328
<u>More</u> .....	1328

# Table of Contents

<b><u>File:MK2R Slide6.JPG</u></b> .....	<b>1329</b>
<u>File history</u> .....	1330
<u>File usage</u> .....	1330
<u>Namespaces</u> .....	1330
<u>Variants</u> .....	1330
<u>Views</u> .....	1330
<u>More</u> .....	1330
<b><u>File:MK2R Slide6.JPG</u></b> .....	<b>1331</b>
<u>File history</u> .....	1332
<u>File usage</u> .....	1332
<u>Namespaces</u> .....	1332
<u>Variants</u> .....	1332
<u>Views</u> .....	1332
<u>More</u> .....	1332
<b><u>File:MK2R Slide7.JPG</u></b> .....	<b>1333</b>
<u>File history</u> .....	1334
<u>File usage</u> .....	1334
<u>Namespaces</u> .....	1334
<u>Variants</u> .....	1334
<u>Views</u> .....	1334
<u>More</u> .....	1334
<b><u>File:MK2R Slide7.JPG</u></b> .....	<b>1335</b>
<u>File history</u> .....	1336
<u>File usage</u> .....	1336
<u>Namespaces</u> .....	1336
<u>Variants</u> .....	1336
<u>Views</u> .....	1336
<u>More</u> .....	1336
<b><u>File:MK2R Slide8.JPG</u></b> .....	<b>1337</b>
<u>File history</u> .....	1338
<u>File usage</u> .....	1338
<u>Namespaces</u> .....	1338
<u>Variants</u> .....	1338
<u>Views</u> .....	1338
<u>More</u> .....	1338
<b><u>File:MK2R Slide8.JPG</u></b> .....	<b>1339</b>
<u>File history</u> .....	1340
<u>File usage</u> .....	1340
<u>Namespaces</u> .....	1340
<u>Variants</u> .....	1340
<u>Views</u> .....	1340
<u>More</u> .....	1340

# Table of Contents

<b><u>File:MK2R Slide9.JPG</u></b> .....	<b>1341</b>
<u>File history</u> .....	1342
<u>File usage</u> .....	1342
<u>Namespaces</u> .....	1342
<u>Variants</u> .....	1342
<u>Views</u> .....	1342
<u>More</u> .....	1342
<b><u>File:MK2R Slide9.JPG</u></b> .....	<b>1343</b>
<u>File history</u> .....	1344
<u>File usage</u> .....	1344
<u>Namespaces</u> .....	1344
<u>Variants</u> .....	1344
<u>Views</u> .....	1344
<u>More</u> .....	1344
<b><u>File:MK MKII MK2R.PNG</u></b> .....	<b>1345</b>
<u>File history</u> .....	1346
<u>File usage</u> .....	1346
<u>Namespaces</u> .....	1346
<u>Variants</u> .....	1346
<u>Views</u> .....	1346
<u>More</u> .....	1346
<b><u>File:MK MKII MK2R.PNG</u></b> .....	<b>1348</b>
<u>File history</u> .....	1349
<u>File usage</u> .....	1349
<u>Namespaces</u> .....	1349
<u>Variants</u> .....	1349
<u>Views</u> .....	1349
<u>More</u> .....	1349
<b><u>File:MmttyAfcAtcPIISetup.gif</u></b> .....	<b>1351</b>
<u>File history</u> .....	1352
<u>File usage</u> .....	1352
<u>Namespaces</u> .....	1352
<u>Variants</u> .....	1352
<u>Views</u> .....	1352
<u>More</u> .....	1352
<b><u>File:MmttyAfcAtcPIISetup.gif</u></b> .....	<b>1354</b>
<u>File history</u> .....	1355
<u>File usage</u> .....	1355
<u>Namespaces</u> .....	1355
<u>Variants</u> .....	1355
<u>Views</u> .....	1355
<u>More</u> .....	1355



# Table of Contents

<b><u>File:MmttyDemodulatorSetup.gif</u></b> .....	<b>1357</b>
<u>File history</u> .....	1358
<u>File usage</u> .....	1358
<u>Namespaces</u> .....	1358
<u>Variants</u> .....	1358
<u>Views</u> .....	1358
<u>More</u> .....	1358
<b><u>File:MmttyDemodulatorSetup.gif</u></b> .....	<b>1360</b>
<u>File history</u> .....	1361
<u>File usage</u> .....	1361
<u>Namespaces</u> .....	1361
<u>Variants</u> .....	1361
<u>Views</u> .....	1361
<u>More</u> .....	1361
<b><u>File:MmttyMiscSetup.gif</u></b> .....	<b>1363</b>
<u>File history</u> .....	1364
<u>File usage</u> .....	1364
<u>Namespaces</u> .....	1364
<u>Variants</u> .....	1364
<u>Views</u> .....	1364
<u>More</u> .....	1364
<b><u>File:MmttyMiscSetup-FSK.gif</u></b> .....	<b>1365</b>
<u>File history</u> .....	1366
<u>File usage</u> .....	1366
<u>Namespaces</u> .....	1366
<u>Variants</u> .....	1366
<u>Views</u> .....	1366
<u>More</u> .....	1366
<b><u>File:MmttyMiscSetup-FSK.gif</u></b> .....	<b>1367</b>
<u>File history</u> .....	1368
<u>File usage</u> .....	1368
<u>Namespaces</u> .....	1368
<u>Variants</u> .....	1368
<u>Views</u> .....	1368
<u>More</u> .....	1368
<b><u>File:MmttyMiscSetup.gif</u></b> .....	<b>1369</b>
<u>File history</u> .....	1370
<u>File usage</u> .....	1370
<u>Namespaces</u> .....	1370
<u>Variants</u> .....	1370
<u>Views</u> .....	1370
<u>More</u> .....	1370

# Table of Contents

<b><u>File:MMTTY PTT Port.gif</u></b> .....	<b>1371</b>
<u>File history</u> .....	1372
<u>File usage</u> .....	1372
<u>Metadata</u> .....	1372
<u>Namespaces</u> .....	1372
<u>Variants</u> .....	1372
<u>Views</u> .....	1372
<u>More</u> .....	1373
<b><u>File:MMTTY PTT Port.gif</u></b> .....	<b>1374</b>
<u>File history</u> .....	1375
<u>File usage</u> .....	1375
<u>Metadata</u> .....	1375
<u>Namespaces</u> .....	1375
<u>Variants</u> .....	1375
<u>Views</u> .....	1375
<u>More</u> .....	1376
<b><u>File:MMTTY Radio Command Port.gif</u></b> .....	<b>1377</b>
<u>File history</u> .....	1378
<u>File usage</u> .....	1378
<u>Metadata</u> .....	1378
<u>Namespaces</u> .....	1378
<u>Variants</u> .....	1378
<u>Views</u> .....	1378
<u>More</u> .....	1379
<b><u>File:MMTTY Radio Command Port.gif</u></b> .....	<b>1380</b>
<u>File history</u> .....	1381
<u>File usage</u> .....	1381
<u>Metadata</u> .....	1381
<u>Namespaces</u> .....	1381
<u>Variants</u> .....	1381
<u>Views</u> .....	1381
<u>More</u> .....	1382
<b><u>File:MmttySoudCardSetup.gif</u></b> .....	<b>1383</b>
<u>File history</u> .....	1384
<u>File usage</u> .....	1384
<u>Namespaces</u> .....	1384
<u>Variants</u> .....	1384
<u>Views</u> .....	1384
<u>More</u> .....	1384
<b><u>File:MmttySoudCardSetup.gif</u></b> .....	<b>1385</b>
<u>File history</u> .....	1386
<u>File usage</u> .....	1386
<u>Namespaces</u> .....	1386

# Table of Contents

<b><u>File:MmttySoudCardSetup.gif</u></b>	
<u>Variants</u> .....	1386
<u>Views</u> .....	1386
<u>More</u> .....	1386
<b><u>File:MmttyTxSetup.gif</u></b> .....	<b>1387</b>
<u>File history</u> .....	1388
<u>File usage</u> .....	1388
<u>Namespaces</u> .....	1388
<u>Variants</u> .....	1388
<u>Views</u> .....	1388
<u>More</u> .....	1388
<b><u>File:MmttyTxSetup COM8.gif</u></b> .....	<b>1389</b>
<u>File history</u> .....	1390
<u>File usage</u> .....	1390
<u>Namespaces</u> .....	1390
<u>Variants</u> .....	1390
<u>Views</u> .....	1390
<u>More</u> .....	1390
<b><u>File:MmttyTxSetup COM8.gif</u></b> .....	<b>1391</b>
<u>File history</u> .....	1392
<u>File usage</u> .....	1392
<u>Namespaces</u> .....	1392
<u>Variants</u> .....	1392
<u>Views</u> .....	1392
<u>More</u> .....	1392
<b><u>File:MmttyTxSetup-EXTFSK-1.gif</u></b> .....	<b>1393</b>
<u>File history</u> .....	1394
<u>File usage</u> .....	1394
<u>Namespaces</u> .....	1394
<u>Variants</u> .....	1394
<u>Views</u> .....	1394
<u>More</u> .....	1394
<b><u>File:MmttyTxSetup-EXTFSK-1.gif</u></b> .....	<b>1395</b>
<u>File history</u> .....	1396
<u>File usage</u> .....	1396
<u>Namespaces</u> .....	1396
<u>Variants</u> .....	1396
<u>Views</u> .....	1396
<u>More</u> .....	1396
<b><u>File:MmttyTxSetup-EXTFSK-2.gif</u></b> .....	<b>1397</b>
<u>File history</u> .....	1397
<u>File usage</u> .....	1398

# Table of Contents

<b><u>File:MmttyTxSetup-EXTFSK-2.gif</u></b>	
<u>Metadata</u> .....	1398
<u>Namespaces</u> .....	1398
<u>Variants</u> .....	1398
<u>Views</u> .....	1398
<u>More</u> .....	1398
<b><u>File:MmttyTxSetup-EXTFSK-2.gif</u></b> .....	<b>1399</b>
<u>File history</u> .....	1399
<u>File usage</u> .....	1400
<u>Metadata</u> .....	1400
<u>Namespaces</u> .....	1400
<u>Variants</u> .....	1400
<u>Views</u> .....	1400
<u>More</u> .....	1400
<b><u>File:MmttyTxSetup.gif</u></b> .....	<b>1401</b>
<u>File history</u> .....	1402
<u>File usage</u> .....	1402
<u>Namespaces</u> .....	1402
<u>Variants</u> .....	1402
<u>Views</u> .....	1402
<u>More</u> .....	1402
<b><u>File:MMTTY-USB-Port-Option.gif</u></b> .....	<b>1403</b>
<u>File history</u> .....	1403
<u>File usage</u> .....	1403
<u>Namespaces</u> .....	1404
<u>Variants</u> .....	1404
<u>Views</u> .....	1404
<u>More</u> .....	1404
<b><u>File:MMTTY-USB-Port-Option.gif</u></b> .....	<b>1405</b>
<u>File history</u> .....	1405
<u>File usage</u> .....	1405
<u>Namespaces</u> .....	1406
<u>Variants</u> .....	1406
<u>Views</u> .....	1406
<u>More</u> .....	1406
<b><u>File:MmttyXyScope.gif</u></b> .....	<b>1407</b>
<u>File history</u> .....	1407
<u>File usage</u> .....	1407
<u>Metadata</u> .....	1408
<u>Namespaces</u> .....	1408
<u>Variants</u> .....	1408
<u>Views</u> .....	1408
<u>More</u> .....	1408

# Table of Contents

<b><u>File:MmttyXyScope.gif</u></b> .....	<b>1409</b>
<u>File history</u> .....	1409
<u>File usage</u> .....	1409
<u>Metadata</u> .....	1410
<u>Namespaces</u> .....	1410
<u>Variants</u> .....	1410
<u>Views</u> .....	1410
<u>More</u> .....	1410
<b><u>File:MmttyXyScopeOnly.gif</u></b> .....	<b>1411</b>
<u>File history</u> .....	1411
<u>File usage</u> .....	1411
<u>Namespaces</u> .....	1411
<u>Variants</u> .....	1411
<u>Views</u> .....	1412
<u>More</u> .....	1412
<b><u>File:MmttyXyScopeOnly.gif</u></b> .....	<b>1413</b>
<u>File history</u> .....	1413
<u>File usage</u> .....	1413
<u>Namespaces</u> .....	1413
<u>Variants</u> .....	1413
<u>Views</u> .....	1414
<u>More</u> .....	1414
<b><u>File:NA Sprint Messages.PNG</u></b> .....	<b>1415</b>
<u>File history</u> .....	1415
<u>File usage</u> .....	1416
<u>Metadata</u> .....	1416
<u>Namespaces</u> .....	1416
<u>Variants</u> .....	1416
<u>Views</u> .....	1416
<u>More</u> .....	1416
<b><u>File:NA Sprint Messages.PNG</u></b> .....	<b>1417</b>
<u>File history</u> .....	1417
<u>File usage</u> .....	1418
<u>Metadata</u> .....	1418
<u>Namespaces</u> .....	1418
<u>Variants</u> .....	1418
<u>Views</u> .....	1418
<u>More</u> .....	1418
<b><u>File:Networking multiop.gif</u></b> .....	<b>1419</b>
<u>File history</u> .....	1420
<u>File usage</u> .....	1420
<u>Namespaces</u> .....	1420
<u>Variants</u> .....	1420

# Table of Contents

<b><u>File:Networking multiop.gif</u></b>	
<u>Views</u> .....	1420
<u>More</u> .....	1420
<b><u>File:Networking multiop.gif</u></b> .....	<b>1421</b>
<u>File history</u> .....	1422
<u>File usage</u> .....	1422
<u>Namespaces</u> .....	1422
<u>Variants</u> .....	1422
<u>Views</u> .....	1422
<u>More</u> .....	1422
<b><u>File:NetworkProtocolAdvancedSettings.gif</u></b> .....	<b>1423</b>
<u>File history</u> .....	1424
<u>File usage</u> .....	1424
<u>Metadata</u> .....	1424
<u>Namespaces</u> .....	1425
<u>Variants</u> .....	1425
<u>Views</u> .....	1425
<u>More</u> .....	1425
<b><u>File:NetworkProtocolAdvancedSettings.gif</u></b> .....	<b>1426</b>
<u>File history</u> .....	1427
<u>File usage</u> .....	1427
<u>Metadata</u> .....	1427
<u>Namespaces</u> .....	1428
<u>Variants</u> .....	1428
<u>Views</u> .....	1428
<u>More</u> .....	1428
<b><u>File:Network singleop.gif</u></b> .....	<b>1429</b>
<u>File history</u> .....	1429
<u>File usage</u> .....	1429
<u>Namespaces</u> .....	1429
<u>Variants</u> .....	1430
<u>Views</u> .....	1430
<u>More</u> .....	1430
<b><u>File:Network singleop.gif</u></b> .....	<b>1431</b>
<u>File history</u> .....	1431
<u>File usage</u> .....	1431
<u>Namespaces</u> .....	1431
<u>Variants</u> .....	1432
<u>Views</u> .....	1432
<u>More</u> .....	1432

# Table of Contents

<b><u>File:network_singleop.gif</u></b> .....	<b>1433</b>
<u>File history</u> .....	1433
<u>File usage</u> .....	1433
<u>Namespaces</u> .....	1433
<u>Variants</u> .....	1434
<u>Views</u> .....	1434
<u>More</u> .....	1434
<b><u>File:network_singleop.gif</u></b> .....	<b>1435</b>
<u>File history</u> .....	1435
<u>File usage</u> .....	1435
<u>Namespaces</u> .....	1435
<u>Variants</u> .....	1436
<u>Views</u> .....	1436
<u>More</u> .....	1436
<b><u>File:NewContestFileProperties.gif</u></b> .....	<b>1437</b>
<u>File history</u> .....	1438
<u>File usage</u> .....	1438
<u>Namespaces</u> .....	1438
<u>Variants</u> .....	1438
<u>Views</u> .....	1438
<u>More</u> .....	1438
<b><u>File:NewContestFileProperties.gif</u></b> .....	<b>1440</b>
<u>File history</u> .....	1441
<u>File usage</u> .....	1441
<u>Namespaces</u> .....	1441
<u>Variants</u> .....	1441
<u>Views</u> .....	1441
<u>More</u> .....	1441
<b><u>File:OperatorLogin1.PNG</u></b> .....	<b>1443</b>
<u>File history</u> .....	1443
<u>File usage</u> .....	1443
<u>Namespaces</u> .....	1443
<u>Variants</u> .....	1443
<u>Views</u> .....	1443
<u>More</u> .....	1444
<b><u>File:OperatorLogin1.PNG</u></b> .....	<b>1445</b>
<u>File history</u> .....	1445
<u>File usage</u> .....	1445
<u>Namespaces</u> .....	1445
<u>Variants</u> .....	1445
<u>Views</u> .....	1445
<u>More</u> .....	1446

# Table of Contents

<b><u>File:OperatorLogin2.PNG</u></b> .....	<b>1447</b>
<u>File history</u> .....	1447
<u>File usage</u> .....	1447
<u>Namespaces</u> .....	1447
<u>Variants</u> .....	1447
<u>Views</u> .....	1447
<u>More</u> .....	1448
<b><u>File:OperatorLogin2.PNG</u></b> .....	<b>1449</b>
<u>File history</u> .....	1449
<u>File usage</u> .....	1449
<u>Namespaces</u> .....	1449
<u>Variants</u> .....	1449
<u>Views</u> .....	1449
<u>More</u> .....	1450
<b><u>File:OptionsCwAutosending.gif</u></b> .....	<b>1451</b>
<u>File history</u> .....	1451
<u>File usage</u> .....	1451
<u>Namespaces</u> .....	1451
<u>Variants</u> .....	1452
<u>Views</u> .....	1452
<u>More</u> .....	1452
<b><u>File:OptionsCwAutoSending.gif</u></b> .....	<b>1453</b>
<u>File history</u> .....	1453
<u>File usage</u> .....	1453
<u>Namespaces</u> .....	1454
<u>Variants</u> .....	1454
<u>Views</u> .....	1454
<u>More</u> .....	1454
<b><u>File:OptionsCwAutosending.gif</u></b> .....	<b>1455</b>
<u>File history</u> .....	1455
<u>File usage</u> .....	1455
<u>Namespaces</u> .....	1455
<u>Variants</u> .....	1456
<u>Views</u> .....	1456
<u>More</u> .....	1456
<b><u>File:OptionsCwAutoSending.gif</u></b> .....	<b>1457</b>
<u>File history</u> .....	1457
<u>File usage</u> .....	1457
<u>Namespaces</u> .....	1458
<u>Variants</u> .....	1458
<u>Views</u> .....	1458
<u>More</u> .....	1458



# Table of Contents

<b><u>File:OptionsCWCUSTOMVariables.PNG</u></b> .....	<b>1459</b>
<u>File history</u> .....	1459
<u>File usage</u> .....	1460
<u>Namespaces</u> .....	1460
<u>Variants</u> .....	1460
<u>Views</u> .....	1460
<u>More</u> .....	1460
<b><u>File:OptionsCWCUSTOMVariables.PNG</u></b> .....	<b>1461</b>
<u>File history</u> .....	1461
<u>File usage</u> .....	1462
<u>Namespaces</u> .....	1462
<u>Variants</u> .....	1462
<u>Views</u> .....	1462
<u>More</u> .....	1462
<b><u>File:OptionsDataFileExchangeDB.gif</u></b> .....	<b>1463</b>
<u>File history</u> .....	1463
<u>File usage</u> .....	1463
<u>Metadata</u> .....	1463
<u>Namespaces</u> .....	1464
<u>Variants</u> .....	1464
<u>Views</u> .....	1464
<u>More</u> .....	1464
<b><u>File:OptionsDataFileExchangeDB.gif</u></b> .....	<b>1465</b>
<u>File history</u> .....	1465
<u>File usage</u> .....	1465
<u>Metadata</u> .....	1465
<u>Namespaces</u> .....	1466
<u>Variants</u> .....	1466
<u>Views</u> .....	1466
<u>More</u> .....	1466
<b><u>File:OptionsDataFileMasterfile.gif</u></b> .....	<b>1467</b>
<u>File history</u> .....	1467
<u>File usage</u> .....	1467
<u>Metadata</u> .....	1467
<u>Namespaces</u> .....	1468
<u>Variants</u> .....	1468
<u>Views</u> .....	1468
<u>More</u> .....	1468
<b><u>File:OptionsDataFileMasterfile.gif</u></b> .....	<b>1469</b>
<u>File history</u> .....	1469
<u>File usage</u> .....	1469
<u>Metadata</u> .....	1469
<u>Namespaces</u> .....	1470

# Table of Contents

<b><u>File:OptionsDataFileMasterfile.gif</u></b>	
<u>Variants</u> .....	1470
<u>Views</u> .....	1470
<u>More</u> .....	1470
<b><u>File:OptionsDataFiles.gif</u></b> .....	<b>1471</b>
<u>File history</u> .....	1472
<u>File usage</u> .....	1472
<u>Metadata</u> .....	1472
<u>Namespaces</u> .....	1472
<u>Variants</u> .....	1472
<u>Views</u> .....	1473
<u>More</u> .....	1473
<b><u>File:OptionsDataFiles.gif</u></b> .....	<b>1474</b>
<u>File history</u> .....	1475
<u>File usage</u> .....	1475
<u>Metadata</u> .....	1475
<u>Namespaces</u> .....	1475
<u>Variants</u> .....	1475
<u>Views</u> .....	1476
<u>More</u> .....	1476
<b><u>File:OptionsDxClusterSyntax.gif</u></b> .....	<b>1477</b>
<u>File history</u> .....	1477
<u>File usage</u> .....	1477
<u>Namespaces</u> .....	1477
<u>Variants</u> .....	1477
<u>Views</u> .....	1477
<u>More</u> .....	1478
<b><u>File:OptionsDxClusterSyntax.gif</u></b> .....	<b>1479</b>
<u>File history</u> .....	1479
<u>File usage</u> .....	1479
<u>Namespaces</u> .....	1479
<u>Variants</u> .....	1479
<u>Views</u> .....	1479
<u>More</u> .....	1480
<b><u>File:OptionsFrequencyOffsets.gif</u></b> .....	<b>1481</b>
<u>File history</u> .....	1481
<u>File usage</u> .....	1481
<u>Namespaces</u> .....	1482
<u>Variants</u> .....	1482
<u>Views</u> .....	1482
<u>More</u> .....	1482

# Table of Contents

<b><u>File:OptionsFrequencyOffsets.gif</u></b> .....	<b>1483</b>
<u>File history</u> .....	1483
<u>File usage</u> .....	1483
<u>Namespaces</u> .....	1484
<u>Variants</u> .....	1484
<u>Views</u> .....	1484
<u>More</u> .....	1484
<b><u>File:OptionsHamCapBackground.gif</u></b> .....	<b>1485</b>
<u>File history</u> .....	1485
<u>File usage</u> .....	1486
<u>Namespaces</u> .....	1486
<u>Variants</u> .....	1486
<u>Views</u> .....	1486
<u>More</u> .....	1486
<b><u>File:OptionsHamCapBackground.gif</u></b> .....	<b>1487</b>
<u>File history</u> .....	1487
<u>File usage</u> .....	1488
<u>Namespaces</u> .....	1488
<u>Variants</u> .....	1488
<u>Views</u> .....	1488
<u>More</u> .....	1488
<b><u>File:OptionsHamCapSolar.gif</u></b> .....	<b>1489</b>
<u>File history</u> .....	1490
<u>File usage</u> .....	1490
<u>Namespaces</u> .....	1490
<u>Variants</u> .....	1490
<u>Views</u> .....	1490
<u>More</u> .....	1490
<b><u>File:OptionsHamCapSolar.gif</u></b> .....	<b>1491</b>
<u>File history</u> .....	1492
<u>File usage</u> .....	1492
<u>Namespaces</u> .....	1492
<u>Variants</u> .....	1492
<u>Views</u> .....	1492
<u>More</u> .....	1492
<b><u>File:OptionsHamCapTab.gif</u></b> .....	<b>1493</b>
<u>File history</u> .....	1494
<u>File usage</u> .....	1494
<u>Namespaces</u> .....	1494
<u>Variants</u> .....	1494
<u>Views</u> .....	1494
<u>More</u> .....	1494

# Table of Contents

<b><u>File:OptionsHamCapTab.gif</u></b> .....	<b>1495</b>
<u>File history</u> .....	1496
<u>File usage</u> .....	1496
<u>Namespaces</u> .....	1496
<u>Variants</u> .....	1496
<u>Views</u> .....	1496
<u>More</u> .....	1496
<b><u>File:OptionsLanguageSelection.PNG</u></b> .....	<b>1497</b>
<u>File history</u> .....	1497
<u>File usage</u> .....	1497
<u>Namespaces</u> .....	1498
<u>Variants</u> .....	1498
<u>Views</u> .....	1498
<u>More</u> .....	1498
<b><u>File:OptionsLanguageSelection.PNG</u></b> .....	<b>1499</b>
<u>File history</u> .....	1499
<u>File usage</u> .....	1499
<u>Namespaces</u> .....	1500
<u>Variants</u> .....	1500
<u>Views</u> .....	1500
<u>More</u> .....	1500
<b><u>File:OptionsLog.PNG</u></b> .....	<b>1501</b>
<u>File history</u> .....	1502
<u>File usage</u> .....	1502
<u>Metadata</u> .....	1502
<u>Namespaces</u> .....	1503
<u>Variants</u> .....	1503
<u>Views</u> .....	1503
<u>More</u> .....	1503
<b><u>File:OptionsLog.PNG</u></b> .....	<b>1504</b>
<u>File history</u> .....	1505
<u>File usage</u> .....	1505
<u>Metadata</u> .....	1505
<u>Namespaces</u> .....	1506
<u>Variants</u> .....	1506
<u>Views</u> .....	1506
<u>More</u> .....	1506
<b><u>File:OptionsLogNewContestFileProperties.PNG</u></b> .....	<b>1507</b>
<u>File history</u> .....	1507
<u>File usage</u> .....	1507
<u>Namespaces</u> .....	1508
<u>Variants</u> .....	1508
<u>Views</u> .....	1508

# Table of Contents

<b><u>File:OptionsLogNewContestFileProperties.PNG</u></b>	
<u>More</u> .....	1508
<b><u>File:OptionsLogNewContestFileProperties.PNG</u></b> .....	<b>1509</b>
<u>File history</u> .....	1509
<u>File usage</u> .....	1509
<u>Namespaces</u> .....	1510
<u>Variants</u> .....	1510
<u>Views</u> .....	1510
<u>More</u> .....	1510
<b><u>File:OptionsMP3Configuration.PNG</u></b> .....	<b>1511</b>
<u>File history</u> .....	1512
<u>File usage</u> .....	1512
<u>Metadata</u> .....	1512
<u>Namespaces</u> .....	1512
<u>Variants</u> .....	1512
<u>Views</u> .....	1513
<u>More</u> .....	1513
<b><u>File:OptionsRttyAdditionalMessages.PNG</u></b> .....	<b>1514</b>
<u>File history</u> .....	1514
<u>File usage</u> .....	1514
<u>Namespaces</u> .....	1515
<u>Variants</u> .....	1515
<u>Views</u> .....	1515
<u>More</u> .....	1515
<b><u>File:OptionsRttyAdditionalMessages.PNG</u></b> .....	<b>1516</b>
<u>File history</u> .....	1516
<u>File usage</u> .....	1516
<u>Namespaces</u> .....	1517
<u>Variants</u> .....	1517
<u>Views</u> .....	1517
<u>More</u> .....	1517
<b><u>File:OptionsRttyConfiguration.PNG</u></b> .....	<b>1518</b>
<u>File history</u> .....	1519
<u>File usage</u> .....	1519
<u>Namespaces</u> .....	1519
<u>Variants</u> .....	1519
<u>Views</u> .....	1519
<u>More</u> .....	1519
<b><u>File:OptionsRttyStandardMessages.PNG</u></b> .....	<b>1521</b>
<u>File history</u> .....	1521
<u>File usage</u> .....	1521
<u>Namespaces</u> .....	1522

# Table of Contents

<b><u>File:OptionsRttyStandardMessages.PNG</u></b>	
<u>Variants</u> .....	1522
<u>Views</u> .....	1522
<u>More</u> .....	1522
<b><u>File:OptionsRttyStandardMessages.PNG.....</u></b>	<b>1523</b>
<u>File history</u> .....	1523
<u>File usage</u> .....	1523
<u>Namespaces</u> .....	1524
<u>Variants</u> .....	1524
<u>Views</u> .....	1524
<u>More</u> .....	1524
<b><u>File:OptionsScriptEditorConfiguration.PNG.....</u></b>	<b>1525</b>
<u>File history</u> .....	1525
<u>File usage</u> .....	1525
<u>Namespaces</u> .....	1526
<u>Variants</u> .....	1526
<u>Views</u> .....	1526
<u>More</u> .....	1526
<b><u>File:OptionsStartStopWtDxTelnet.gif.....</u></b>	<b>1527</b>
<u>File history</u> .....	1527
<u>File usage</u> .....	1527
<u>Namespaces</u> .....	1527
<u>Variants</u> .....	1527
<u>Views</u> .....	1527
<u>More</u> .....	1528
<b><u>File:OptionsStartStopWtDxTelnet.gif.....</u></b>	<b>1529</b>
<u>File history</u> .....	1529
<u>File usage</u> .....	1529
<u>Namespaces</u> .....	1529
<u>Variants</u> .....	1529
<u>Views</u> .....	1529
<u>More</u> .....	1530
<b><u>File:OptionsWindowsMenu.gif.....</u></b>	<b>1531</b>
<u>File history</u> .....	1531
<u>File usage</u> .....	1531
<u>Namespaces</u> .....	1531
<u>Variants</u> .....	1531
<u>Views</u> .....	1531
<u>More</u> .....	1532
<b><u>File:OptionsWindowsMenu.gif.....</u></b>	<b>1533</b>
<u>File history</u> .....	1533
<u>File usage</u> .....	1533

# Table of Contents

<b><u>File:OptionsWindowsMenu.gif</u></b>	
<u>Namespaces</u> .....	1533
<u>Variants</u> .....	1533
<u>Views</u> .....	1533
<u>More</u> .....	1534
<b><u>File:OTSRP.PNG</u></b> .....	<b>1535</b>
<u>File history</u> .....	1536
<u>File usage</u> .....	1536
<u>Namespaces</u> .....	1536
<u>Variants</u> .....	1536
<u>Views</u> .....	1536
<u>More</u> .....	1536
<b><u>File:OTSRP.PNG</u></b> .....	<b>1537</b>
<u>File history</u> .....	1538
<u>File usage</u> .....	1538
<u>Namespaces</u> .....	1538
<u>Variants</u> .....	1538
<u>Views</u> .....	1538
<u>More</u> .....	1538
<b><u>File:PartnerWindow.gif</u></b> .....	<b>1539</b>
<u>File history</u> .....	1539
<u>File usage</u> .....	1539
<u>Namespaces</u> .....	1540
<u>Variants</u> .....	1540
<u>Views</u> .....	1540
<u>More</u> .....	1540
<b><u>File:PartnerWindow.gif</u></b> .....	<b>1541</b>
<u>File history</u> .....	1541
<u>File usage</u> .....	1541
<u>Namespaces</u> .....	1542
<u>Variants</u> .....	1542
<u>Views</u> .....	1542
<u>More</u> .....	1542
<b><u>File:passtation.gif</u></b> .....	<b>1543</b>
<u>File history</u> .....	1543
<u>File usage</u> .....	1543
<u>Namespaces</u> .....	1543
<u>Variants</u> .....	1543
<u>Views</u> .....	1544
<u>More</u> .....	1544

# Table of Contents

<b><u>File:passtation.gif</u></b> .....	<b>1545</b>
<u>File history</u> .....	1545
<u>File usage</u> .....	1545
<u>Namespaces</u> .....	1545
<u>Variants</u> .....	1545
<u>Views</u> .....	1546
<u>More</u> .....	1546
<b><u>File:PassStation.gif</u></b> .....	<b>1547</b>
<u>File history</u> .....	1547
<u>File usage</u> .....	1547
<u>Namespaces</u> .....	1547
<u>Variants</u> .....	1548
<u>Views</u> .....	1548
<u>More</u> .....	1548
<b><u>File:PassStation.gif</u></b> .....	<b>1549</b>
<u>File history</u> .....	1549
<u>File usage</u> .....	1549
<u>Namespaces</u> .....	1549
<u>Variants</u> .....	1550
<u>Views</u> .....	1550
<u>More</u> .....	1550
<b><u>File:Port95NT.exe Properties.gif</u></b> .....	<b>1551</b>
<u>File history</u> .....	1552
<u>File usage</u> .....	1552
<u>Metadata</u> .....	1552
<u>Namespaces</u> .....	1552
<u>Variants</u> .....	1552
<u>Views</u> .....	1552
<u>More</u> .....	1553
<b><u>File:Port95NT.exe Properties.gif</u></b> .....	<b>1554</b>
<u>File history</u> .....	1555
<u>File usage</u> .....	1555
<u>Metadata</u> .....	1555
<u>Namespaces</u> .....	1555
<u>Variants</u> .....	1555
<u>Views</u> .....	1555
<u>More</u> .....	1556
<b><u>File:Qsy10minrun.gif</u></b> .....	<b>1557</b>
<u>File history</u> .....	1557
<u>File usage</u> .....	1557
<u>Namespaces</u> .....	1558
<u>Variants</u> .....	1558
<u>Views</u> .....	1558



# Table of Contents

<b><u>File:Qsy10minrun.gif</u></b>	
<u>More</u> .....	1558
<b><u>File:Qsy10minrun.gif</u></b> .....	<b>1559</b>
<u>File history</u> .....	1559
<u>File usage</u> .....	1559
<u>Namespaces</u> .....	1560
<u>Variants</u> .....	1560
<u>Views</u> .....	1560
<u>More</u> .....	1560
<b><u>File:qsyfrequency.gif</u></b> .....	<b>1561</b>
<u>File history</u> .....	1561
<u>File usage</u> .....	1561
<u>Namespaces</u> .....	1561
<u>Variants</u> .....	1561
<u>Views</u> .....	1561
<u>More</u> .....	1561
<b><u>File:qsyfrequency.gif</u></b> .....	<b>1563</b>
<u>File history</u> .....	1563
<u>File usage</u> .....	1563
<u>Namespaces</u> .....	1563
<u>Variants</u> .....	1563
<u>Views</u> .....	1563
<u>More</u> .....	1563
<b><u>File:qtc-bandmap1.gif</u></b> .....	<b>1565</b>
<u>File history</u> .....	1565
<u>File usage</u> .....	1565
<u>Namespaces</u> .....	1566
<u>Variants</u> .....	1566
<u>Views</u> .....	1566
<u>More</u> .....	1566
<b><u>File:qtc-bandmap1.gif</u></b> .....	<b>1567</b>
<u>File history</u> .....	1567
<u>File usage</u> .....	1567
<u>Namespaces</u> .....	1568
<u>Variants</u> .....	1568
<u>Views</u> .....	1568
<u>More</u> .....	1568
<b><u>File:qtc-bandmap2.gif</u></b> .....	<b>1569</b>
<u>File history</u> .....	1569
<u>File usage</u> .....	1569
<u>Namespaces</u> .....	1570
<u>Variants</u> .....	1570

# Table of Contents

<b><u>File:qtc-bandmap2.gif</u></b>	
<u>Views</u> .....	1570
<u>More</u> .....	1570
<b><u>File:qtc-bandmap2.gif</u></b> .....	<b>1571</b>
<u>File history</u> .....	1571
<u>File usage</u> .....	1571
<u>Namespaces</u> .....	1572
<u>Variants</u> .....	1572
<u>Views</u> .....	1572
<u>More</u> .....	1572
<b><u>File:qtc-rx.gif</u></b> .....	<b>1573</b>
<u>File history</u> .....	1574
<u>File usage</u> .....	1574
<u>Namespaces</u> .....	1574
<u>Variants</u> .....	1574
<u>Views</u> .....	1574
<u>More</u> .....	1574
<b><u>File:OtcRx.gif</u></b> .....	<b>1575</b>
<u>File history</u> .....	1576
<u>File usage</u> .....	1576
<u>Metadata</u> .....	1576
<u>Namespaces</u> .....	1576
<u>Variants</u> .....	1576
<u>Views</u> .....	1576
<u>More</u> .....	1577
<b><u>File:qtc-rx.gif</u></b> .....	<b>1578</b>
<u>File history</u> .....	1579
<u>File usage</u> .....	1579
<u>Namespaces</u> .....	1579
<u>Variants</u> .....	1579
<u>Views</u> .....	1579
<u>More</u> .....	1579
<b><u>File:OtcRx.gif</u></b> .....	<b>1580</b>
<u>File history</u> .....	1581
<u>File usage</u> .....	1581
<u>Metadata</u> .....	1581
<u>Namespaces</u> .....	1581
<u>Variants</u> .....	1581
<u>Views</u> .....	1581
<u>More</u> .....	1582

# Table of Contents

<b><u>File:qtc-tx-1.gif</u></b> .....	<b>1583</b>
<u>File history</u> .....	1583
<u>File usage</u> .....	1583
<u>Namespaces</u> .....	1583
<u>Variants</u> .....	1583
<u>Views</u> .....	1584
<u>More</u> .....	1584
<b><u>File:qtc-tx-1.gif</u></b> .....	<b>1585</b>
<u>File history</u> .....	1585
<u>File usage</u> .....	1585
<u>Namespaces</u> .....	1585
<u>Variants</u> .....	1585
<u>Views</u> .....	1586
<u>More</u> .....	1586
<b><u>File:qtc-tx-2.gif</u></b> .....	<b>1587</b>
<u>File history</u> .....	1587
<u>File usage</u> .....	1588
<u>Namespaces</u> .....	1588
<u>Variants</u> .....	1588
<u>Views</u> .....	1588
<u>More</u> .....	1588
<b><u>File:qtc-tx-2.gif</u></b> .....	<b>1589</b>
<u>File history</u> .....	1590
<u>File usage</u> .....	1590
<u>Metadata</u> .....	1590
<u>Namespaces</u> .....	1590
<u>Variants</u> .....	1590
<u>Views</u> .....	1590
<u>More</u> .....	1590
<b><u>File:qtc-tx-2.gif</u></b> .....	<b>1592</b>
<u>File history</u> .....	1593
<u>File usage</u> .....	1593
<u>Metadata</u> .....	1593
<u>Namespaces</u> .....	1593
<u>Variants</u> .....	1593
<u>Views</u> .....	1593
<u>More</u> .....	1593
<b><u>File:qtc-tx-2.gif</u></b> .....	<b>1595</b>
<u>File history</u> .....	1595
<u>File usage</u> .....	1596
<u>Namespaces</u> .....	1596
<u>Variants</u> .....	1596
<u>Views</u> .....	1596

# Table of Contents

<b><u>File:qtc-tx-2.gif</u></b>	
<u>More</u> .....	1596
<b><u>File:RecordStop.gif</u></b> .....	<b>1597</b>
<u>File history</u> .....	1597
<u>File usage</u> .....	1597
<u>Namespaces</u> .....	1597
<u>Variants</u> .....	1597
<u>Views</u> .....	1597
<u>More</u> .....	1598
<b><u>File:RecordStop.gif</u></b> .....	<b>1599</b>
<u>File history</u> .....	1599
<u>File usage</u> .....	1599
<u>Namespaces</u> .....	1599
<u>Variants</u> .....	1599
<u>Views</u> .....	1599
<u>More</u> .....	1600
<b><u>File:RemoteCommandDialog.gif</u></b> .....	<b>1601</b>
<u>File history</u> .....	1601
<u>File usage</u> .....	1601
<u>Namespaces</u> .....	1602
<u>Variants</u> .....	1602
<u>Views</u> .....	1602
<u>More</u> .....	1602
<b><u>File:RemoteCommandDialog.gif</u></b> .....	<b>1603</b>
<u>File history</u> .....	1603
<u>File usage</u> .....	1603
<u>Namespaces</u> .....	1604
<u>Variants</u> .....	1604
<u>Views</u> .....	1604
<u>More</u> .....	1604
<b><u>File:Rtty config rightclick.gif</u></b> .....	<b>1605</b>
<u>File history</u> .....	1606
<u>File usage</u> .....	1606
<u>Namespaces</u> .....	1606
<u>Variants</u> .....	1606
<u>Views</u> .....	1606
<u>More</u> .....	1606
<b><u>File:Rtty config rightclick.gif</u></b> .....	<b>1607</b>
<u>File history</u> .....	1608
<u>File usage</u> .....	1608
<u>Namespaces</u> .....	1608
<u>Variants</u> .....	1608

# Table of Contents

<b><u>File:Rtty config rightclick.gif</u></b>	
<u>Views</u> .....	1608
<u>More</u> .....	1608
<b><u>File:Rtty macros.gif</u></b> .....	<b>1609</b>
<u>File history</u> .....	1609
<u>File usage</u> .....	1609
<u>Namespaces</u> .....	1609
<u>Variants</u> .....	1609
<u>Views</u> .....	1609
<u>More</u> .....	1610
<b><u>File:Rtty macros.gif</u></b> .....	<b>1611</b>
<u>File history</u> .....	1611
<u>File usage</u> .....	1611
<u>Namespaces</u> .....	1611
<u>Variants</u> .....	1611
<u>Views</u> .....	1611
<u>More</u> .....	1612
<b><u>File:RttyMessagingTypical.PNG</u></b> .....	<b>1613</b>
<u>File history</u> .....	1613
<u>File usage</u> .....	1613
<u>Namespaces</u> .....	1614
<u>Variants</u> .....	1614
<u>Views</u> .....	1614
<u>More</u> .....	1614
<b><u>File:RttyMessagingTypical.PNG</u></b> .....	<b>1615</b>
<u>File history</u> .....	1615
<u>File usage</u> .....	1615
<u>Namespaces</u> .....	1616
<u>Variants</u> .....	1616
<u>Views</u> .....	1616
<u>More</u> .....	1616
<b><u>File:Rtty mmtty.gif</u></b> .....	<b>1617</b>
<u>File history</u> .....	1617
<u>File usage</u> .....	1617
<u>Namespaces</u> .....	1617
<u>Variants</u> .....	1618
<u>Views</u> .....	1618
<u>More</u> .....	1618
<b><u>File:Rtty mmtty.gif</u></b> .....	<b>1619</b>
<u>File history</u> .....	1619
<u>File usage</u> .....	1619
<u>Namespaces</u> .....	1619

# Table of Contents

<b><u>File:Rtty mmtty.gif</u></b>	
<u>Variants</u> .....	1620
<u>Views</u> .....	1620
<u>More</u> .....	1620
<b><u>File:RttyStandardMessagesOptions.PNG</u></b> .....	<b>1621</b>
<u>File history</u> .....	1621
<u>File usage</u> .....	1621
<u>Namespaces</u> .....	1622
<u>Variants</u> .....	1622
<u>Views</u> .....	1622
<u>More</u> .....	1622
<b><u>File:RttyStandardMessagesOptions.PNG</u></b> .....	<b>1623</b>
<u>File history</u> .....	1623
<u>File usage</u> .....	1623
<u>Namespaces</u> .....	1624
<u>Variants</u> .....	1624
<u>Views</u> .....	1624
<u>More</u> .....	1624
<b><u>File:RttyWindow.PNG</u></b> .....	<b>1625</b>
<u>File history</u> .....	1625
<u>File usage</u> .....	1625
<u>Namespaces</u> .....	1625
<u>Variants</u> .....	1626
<u>Views</u> .....	1626
<u>More</u> .....	1626
<b><u>File:RttyWindowContextMenu.gif</u></b> .....	<b>1627</b>
<u>File history</u> .....	1627
<u>File usage</u> .....	1627
<u>Metadata</u> .....	1627
<u>Namespaces</u> .....	1628
<u>Variants</u> .....	1628
<u>Views</u> .....	1628
<u>More</u> .....	1628
<b><u>File:RttyWindowContextMenu.gif</u></b> .....	<b>1629</b>
<u>File history</u> .....	1629
<u>File usage</u> .....	1629
<u>Metadata</u> .....	1629
<u>Namespaces</u> .....	1630
<u>Variants</u> .....	1630
<u>Views</u> .....	1630
<u>More</u> .....	1630

# Table of Contents

<b><u>File:RttyWindow.PNG</u></b> .....	<b>1631</b>
<u>File history</u> .....	1631
<u>File usage</u> .....	1631
<u>Namespaces</u> .....	1631
<u>Variants</u> .....	1632
<u>Views</u> .....	1632
<u>More</u> .....	1632
<b><u>File:Scenarios.PNG</u></b> .....	<b>1633</b>
<u>File history</u> .....	1634
<u>File usage</u> .....	1634
<u>Namespaces</u> .....	1634
<u>Variants</u> .....	1634
<u>Views</u> .....	1634
<u>More</u> .....	1634
<b><u>File:Scenarios.PNG</u></b> .....	<b>1635</b>
<u>File history</u> .....	1636
<u>File usage</u> .....	1636
<u>Namespaces</u> .....	1636
<u>Variants</u> .....	1636
<u>Views</u> .....	1636
<u>More</u> .....	1636
<b><u>File:Schema InterfaceCW.gif</u></b> .....	<b>1637</b>
<u>File history</u> .....	1638
<u>File usage</u> .....	1638
<u>Namespaces</u> .....	1638
<u>Variants</u> .....	1638
<u>Views</u> .....	1638
<u>More</u> .....	1638
<b><u>File:Schema InterfaceCW.gif</u></b> .....	<b>1640</b>
<u>File history</u> .....	1641
<u>File usage</u> .....	1641
<u>Namespaces</u> .....	1641
<u>Variants</u> .....	1641
<u>Views</u> .....	1641
<u>More</u> .....	1641
<b><u>File:Schema InterfaceDVK.gif</u></b> .....	<b>1643</b>
<u>File history</u> .....	1644
<u>File usage</u> .....	1644
<u>Namespaces</u> .....	1644
<u>Variants</u> .....	1644
<u>Views</u> .....	1644
<u>More</u> .....	1644

# Table of Contents

<b><u>File:Schema InterfaceDVK.gif</u></b> .....	<b>1645</b>
<u>File history</u> .....	1646
<u>File usage</u> .....	1646
<u>Namespaces</u> .....	1646
<u>Variants</u> .....	1646
<u>Views</u> .....	1646
<u>More</u> .....	1646
<b><u>File:Schema Interface SoundCard.gif</u></b> .....	<b>1647</b>
<u>File history</u> .....	1647
<u>File usage</u> .....	1647
<u>Namespaces</u> .....	1648
<u>Variants</u> .....	1648
<u>Views</u> .....	1648
<u>More</u> .....	1648
<b><u>File:Schema Interface SoundCard.gif</u></b> .....	<b>1649</b>
<u>File history</u> .....	1649
<u>File usage</u> .....	1649
<u>Namespaces</u> .....	1650
<u>Variants</u> .....	1650
<u>Views</u> .....	1650
<u>More</u> .....	1650
<b><u>File:SearchForPossibleBadExchanges.PNG</u></b> .....	<b>1651</b>
<u>File history</u> .....	1651
<u>File usage</u> .....	1651
<u>Namespaces</u> .....	1652
<u>Variants</u> .....	1652
<u>Views</u> .....	1652
<u>More</u> .....	1652
<b><u>File:SearchForPossibleBadExchanges.PNG</u></b> .....	<b>1653</b>
<u>File history</u> .....	1653
<u>File usage</u> .....	1653
<u>Namespaces</u> .....	1654
<u>Variants</u> .....	1654
<u>Views</u> .....	1654
<u>More</u> .....	1654
<b><u>File:SearchForPossibleBadExchangesReport.PNG</u></b> .....	<b>1655</b>
<u>File history</u> .....	1655
<u>File usage</u> .....	1655
<u>Namespaces</u> .....	1655
<u>Variants</u> .....	1656
<u>Views</u> .....	1656
<u>More</u> .....	1656



# Table of Contents

<b><u>File:SearchForPossibleBadExchangesReport.PNG</u></b> .....	<b>1657</b>
<u>File history</u> .....	1657
<u>File usage</u> .....	1657
<u>Namespaces</u> .....	1657
<u>Variants</u> .....	1658
<u>Views</u> .....	1658
<u>More</u> .....	1658
<b><u>File:SecondaryRadioRunSandP.gif</u></b> .....	<b>1659</b>
<u>File history</u> .....	1659
<u>File usage</u> .....	1659
<u>Namespaces</u> .....	1659
<u>Variants</u> .....	1660
<u>Views</u> .....	1660
<u>More</u> .....	1660
<b><u>File:SecondaryRadioRunSandP.gif</u></b> .....	<b>1661</b>
<u>File history</u> .....	1661
<u>File usage</u> .....	1661
<u>Namespaces</u> .....	1661
<u>Variants</u> .....	1662
<u>Views</u> .....	1662
<u>More</u> .....	1662
<b><u>File:secondary window.PNG</u></b> .....	<b>1663</b>
<u>File history</u> .....	1663
<u>File usage</u> .....	1663
<u>Namespaces</u> .....	1664
<u>Variants</u> .....	1664
<u>Views</u> .....	1664
<u>More</u> .....	1664
<b><u>File:secondary window.PNG</u></b> .....	<b>1665</b>
<u>File history</u> .....	1665
<u>File usage</u> .....	1665
<u>Namespaces</u> .....	1666
<u>Variants</u> .....	1666
<u>Views</u> .....	1666
<u>More</u> .....	1666
<b><u>File:SetupConfigureMKControl.gif</u></b> .....	<b>1667</b>
<u>File history</u> .....	1668
<u>File usage</u> .....	1668
<u>Namespaces</u> .....	1668
<u>Variants</u> .....	1668
<u>Views</u> .....	1668
<u>More</u> .....	1668

# Table of Contents

<b><u>File:SetupConfigureMKControl.gif</u></b> .....	<b>1669</b>
<u>File history</u> .....	1670
<u>File usage</u> .....	1670
<u>Namespaces</u> .....	1670
<u>Variants</u> .....	1670
<u>Views</u> .....	1670
<u>More</u> .....	1670
<b><u>File:SigmaTelAudioDialog1.gif</u></b> .....	<b>1671</b>
<u>File history</u> .....	1672
<u>File usage</u> .....	1672
<u>Namespaces</u> .....	1672
<u>Variants</u> .....	1672
<u>Views</u> .....	1672
<u>More</u> .....	1672
<b><u>File:SigmaTelAudioDialog1.gif</u></b> .....	<b>1674</b>
<u>File history</u> .....	1675
<u>File usage</u> .....	1675
<u>Namespaces</u> .....	1675
<u>Variants</u> .....	1675
<u>Views</u> .....	1675
<u>More</u> .....	1675
<b><u>File:SigmaTelAudioDialog2.gif</u></b> .....	<b>1677</b>
<u>File history</u> .....	1677
<u>File usage</u> .....	1677
<u>Namespaces</u> .....	1678
<u>Variants</u> .....	1678
<u>Views</u> .....	1678
<u>More</u> .....	1678
<b><u>File:SigmaTelAudioDialog2.gif</u></b> .....	<b>1679</b>
<u>File history</u> .....	1679
<u>File usage</u> .....	1679
<u>Namespaces</u> .....	1680
<u>Variants</u> .....	1680
<u>Views</u> .....	1680
<u>More</u> .....	1680
<b><u>File:SkedsWindow.gif</u></b> .....	<b>1681</b>
<u>File history</u> .....	1682
<u>File usage</u> .....	1682
<u>Namespaces</u> .....	1682
<u>Variants</u> .....	1682
<u>Views</u> .....	1682
<u>More</u> .....	1682

# Table of Contents

<b><u>File:SkedsWindow.gif</u></b> .....	<b>1684</b>
<u>File history</u> .....	1685
<u>File usage</u> .....	1685
<u>Namespaces</u> .....	1685
<u>Variants</u> .....	1685
<u>Views</u> .....	1685
<u>More</u> .....	1685
<b><u>File:SkedsWindow simple.gif</u></b> .....	<b>1687</b>
<u>File history</u> .....	1687
<u>File usage</u> .....	1687
<u>Namespaces</u> .....	1687
<u>Variants</u> .....	1687
<u>Views</u> .....	1687
<u>More</u> .....	1688
<b><u>File:SkedsWindow simple.gif</u></b> .....	<b>1689</b>
<u>File history</u> .....	1689
<u>File usage</u> .....	1689
<u>Namespaces</u> .....	1689
<u>Variants</u> .....	1689
<u>Views</u> .....	1689
<u>More</u> .....	1690
<b><u>File:SoundcardInterface.gif</u></b> .....	<b>1691</b>
<u>File history</u> .....	1692
<u>File usage</u> .....	1692
<u>Namespaces</u> .....	1692
<u>Variants</u> .....	1692
<u>Views</u> .....	1692
<u>More</u> .....	1692
<b><u>File:SoundcardInterface.gif</u></b> .....	<b>1693</b>
<u>File history</u> .....	1694
<u>File usage</u> .....	1694
<u>Namespaces</u> .....	1694
<u>Variants</u> .....	1694
<u>Views</u> .....	1694
<u>More</u> .....	1694
<b><u>File:split.gif</u></b> .....	<b>1695</b>
<u>File history</u> .....	1695
<u>File usage</u> .....	1695
<u>Namespaces</u> .....	1695
<u>Variants</u> .....	1695
<u>Views</u> .....	1695
<u>More</u> .....	1695

# Table of Contents

<b><u>File:split.gif</u></b> .....	<b>1697</b>
<u>File history</u> .....	1697
<u>File usage</u> .....	1697
<u>Namespaces</u> .....	1697
<u>Variants</u> .....	1697
<u>Views</u> .....	1697
<u>More</u> .....	1697
<b><u>File:spotastation.gif</u></b> .....	<b>1699</b>
<u>File history</u> .....	1699
<u>File usage</u> .....	1699
<u>Namespaces</u> .....	1699
<u>Variants</u> .....	1699
<u>Views</u> .....	1699
<u>More</u> .....	1699
<b><u>File:spotastation.gif</u></b> .....	<b>1701</b>
<u>File history</u> .....	1701
<u>File usage</u> .....	1701
<u>Namespaces</u> .....	1701
<u>Variants</u> .....	1701
<u>Views</u> .....	1701
<u>More</u> .....	1701
<b><u>File:StatisticsContinents.PNG</u></b> .....	<b>1703</b>
<u>File history</u> .....	1704
<u>File usage</u> .....	1704
<u>Namespaces</u> .....	1704
<u>Variants</u> .....	1704
<u>Views</u> .....	1704
<u>More</u> .....	1704
<b><u>File:StatisticsContinents.PNG</u></b> .....	<b>1705</b>
<u>File history</u> .....	1706
<u>File usage</u> .....	1706
<u>Namespaces</u> .....	1706
<u>Variants</u> .....	1706
<u>Views</u> .....	1706
<u>More</u> .....	1706
<b><u>File:StatisticsHourlyOSOTargets.PNG</u></b> .....	<b>1707</b>
<u>File history</u> .....	1708
<u>File usage</u> .....	1708
<u>Namespaces</u> .....	1708
<u>Variants</u> .....	1708
<u>Views</u> .....	1708
<u>More</u> .....	1708

# Table of Contents

<b><u>File:StatisticsHourlyOSOTargets.PNG</u></b> .....	<b>1709</b>
<u>File history</u> .....	1710
<u>File usage</u> .....	1710
<u>Namespaces</u> .....	1710
<u>Variants</u> .....	1710
<u>Views</u> .....	1710
<u>More</u> .....	1710
<b><u>File:StatisticsPopUpMenu.PNG</u></b> .....	<b>1711</b>
<u>File history</u> .....	1711
<u>File usage</u> .....	1712
<u>Namespaces</u> .....	1712
<u>Variants</u> .....	1712
<u>Views</u> .....	1712
<u>More</u> .....	1712
<b><u>File:StatisticsPopUpMenuDisplayedData.PNG</u></b> .....	<b>1713</b>
<u>File history</u> .....	1713
<u>File usage</u> .....	1714
<u>Namespaces</u> .....	1714
<u>Variants</u> .....	1714
<u>Views</u> .....	1714
<u>More</u> .....	1714
<b><u>File:StatisticsPopUpMenuDisplayedData.PNG</u></b> .....	<b>1715</b>
<u>File history</u> .....	1715
<u>File usage</u> .....	1716
<u>Namespaces</u> .....	1716
<u>Variants</u> .....	1716
<u>Views</u> .....	1716
<u>More</u> .....	1716
<b><u>File:StatisticsPopUpMenu.PNG</u></b> .....	<b>1717</b>
<u>File history</u> .....	1717
<u>File usage</u> .....	1718
<u>Namespaces</u> .....	1718
<u>Variants</u> .....	1718
<u>Views</u> .....	1718
<u>More</u> .....	1718
<b><u>File:StatusWindow.gif</u></b> .....	<b>1719</b>
<u>File history</u> .....	1719
<u>File usage</u> .....	1719
<u>Namespaces</u> .....	1719
<u>Variants</u> .....	1719
<u>Views</u> .....	1720
<u>More</u> .....	1720

# Table of Contents

<b><u>File:StatusWindow.gif</u></b> .....	<b>1721</b>
<u>File history</u> .....	1721
<u>File usage</u> .....	1721
<u>Namespaces</u> .....	1721
<u>Variants</u> .....	1721
<u>Views</u> .....	1722
<u>More</u> .....	1722
<b><u>File:StatusWindow.PNG</u></b> .....	<b>1723</b>
<u>File history</u> .....	1723
<u>File usage</u> .....	1724
<u>Metadata</u> .....	1724
<u>Namespaces</u> .....	1724
<u>Variants</u> .....	1724
<u>Views</u> .....	1724
<u>More</u> .....	1724
<b><u>File:StatusWindow.PNG</u></b> .....	<b>1725</b>
<u>File history</u> .....	1725
<u>File usage</u> .....	1726
<u>Metadata</u> .....	1726
<u>Namespaces</u> .....	1726
<u>Variants</u> .....	1726
<u>Views</u> .....	1726
<u>More</u> .....	1726
<b><u>File:StatuWndMenu.gif</u></b> .....	<b>1727</b>
<u>File history</u> .....	1727
<u>File usage</u> .....	1727
<u>Namespaces</u> .....	1727
<u>Variants</u> .....	1728
<u>Views</u> .....	1728
<u>More</u> .....	1728
<b><u>File:StatuWndMenu.gif</u></b> .....	<b>1729</b>
<u>File history</u> .....	1729
<u>File usage</u> .....	1729
<u>Namespaces</u> .....	1729
<u>Variants</u> .....	1730
<u>Views</u> .....	1730
<u>More</u> .....	1730
<b><u>File:takesked.gif</u></b> .....	<b>1731</b>
<u>File history</u> .....	1731
<u>File usage</u> .....	1731
<u>Namespaces</u> .....	1731
<u>Variants</u> .....	1731
<u>Views</u> .....	1731

# Table of Contents

<b><u>File:takesked.gif</u></b>	
<u>More</u> .....	1732
<b><u>File:takesked.gif</u></b> .....	<b>1733</b>
<u>File history</u> .....	1733
<u>File usage</u> .....	1733
<u>Namespaces</u> .....	1733
<u>Variants</u> .....	1733
<u>Views</u> .....	1733
<u>More</u> .....	1734
<b><u>File:Targets.PNG</u></b> .....	<b>1735</b>
<u>File history</u> .....	1736
<u>File usage</u> .....	1736
<u>Namespaces</u> .....	1736
<u>Variants</u> .....	1736
<u>Views</u> .....	1736
<u>More</u> .....	1736
<b><u>File:Targets.PNG</u></b> .....	<b>1737</b>
<u>File history</u> .....	1738
<u>File usage</u> .....	1738
<u>Namespaces</u> .....	1738
<u>Variants</u> .....	1738
<u>Views</u> .....	1738
<u>More</u> .....	1738
<b><u>File:TimeShifting.gif</u></b> .....	<b>1739</b>
<u>File history</u> .....	1739
<u>File usage</u> .....	1739
<u>Namespaces</u> .....	1740
<u>Variants</u> .....	1740
<u>Views</u> .....	1740
<u>More</u> .....	1740
<b><u>File:TimeShifting.gif</u></b> .....	<b>1741</b>
<u>File history</u> .....	1741
<u>File usage</u> .....	1741
<u>Namespaces</u> .....	1742
<u>Variants</u> .....	1742
<u>Views</u> .....	1742
<u>More</u> .....	1742
<b><u>File:ToolsAutoCO.gif</u></b> .....	<b>1743</b>
<u>File history</u> .....	1744
<u>File usage</u> .....	1744
<u>Namespaces</u> .....	1744
<u>Variants</u> .....	1745

# Table of Contents

<b><u>File:ToolsAutoCO.gif</u></b>	
<u>Views</u> .....	1745
<u>More</u> .....	1745
<b><u>File:ToolsAutoCO.gif</u></b> .....	<b>1746</b>
<u>File history</u> .....	1747
<u>File usage</u> .....	1747
<u>Namespaces</u> .....	1747
<u>Variants</u> .....	1748
<u>Views</u> .....	1748
<u>More</u> .....	1748
<b><u>File:ToolsCheckLog.PNG</u></b> .....	<b>1749</b>
<u>File history</u> .....	1749
<u>File usage</u> .....	1749
<u>Namespaces</u> .....	1749
<u>Variants</u> .....	1750
<u>Views</u> .....	1750
<u>More</u> .....	1750
<b><u>File:ToolsCheckLog.PNG</u></b> .....	<b>1751</b>
<u>File history</u> .....	1751
<u>File usage</u> .....	1751
<u>Namespaces</u> .....	1751
<u>Variants</u> .....	1752
<u>Views</u> .....	1752
<u>More</u> .....	1752
<b><u>File:ToolsCheckLog-M2.PNG</u></b> .....	<b>1753</b>
<u>File history</u> .....	1753
<u>File usage</u> .....	1753
<u>Namespaces</u> .....	1753
<u>Variants</u> .....	1754
<u>Views</u> .....	1754
<u>More</u> .....	1754
<b><u>File:ToolsCheckLog-M2.PNG</u></b> .....	<b>1755</b>
<u>File history</u> .....	1755
<u>File usage</u> .....	1755
<u>Namespaces</u> .....	1755
<u>Variants</u> .....	1756
<u>Views</u> .....	1756
<u>More</u> .....	1756
<b><u>File:ToolsCheckLog-SO.PNG</u></b> .....	<b>1757</b>
<u>File history</u> .....	1757
<u>File usage</u> .....	1757
<u>Namespaces</u> .....	1757



# Table of Contents

<b><u>File:ToolsCheckLog-SO.PNG</u></b>	
<u>Variants</u> .....	1758
<u>Views</u> .....	1758
<u>More</u> .....	1758
<b><u>File:ToolsCheckLog-SO.PNG</u></b> .....	<b>1759</b>
<u>File history</u> .....	1759
<u>File usage</u> .....	1759
<u>Namespaces</u> .....	1759
<u>Variants</u> .....	1760
<u>Views</u> .....	1760
<u>More</u> .....	1760
<b><u>File:ToolsCorrectingOp.PNG</u></b> .....	<b>1761</b>
<u>File history</u> .....	1762
<u>File usage</u> .....	1762
<u>Namespaces</u> .....	1762
<u>Variants</u> .....	1762
<u>Views</u> .....	1762
<u>More</u> .....	1762
<b><u>File:ToolsCorrectingOp.PNG</u></b> .....	<b>1763</b>
<u>File history</u> .....	1764
<u>File usage</u> .....	1764
<u>Namespaces</u> .....	1764
<u>Variants</u> .....	1764
<u>Views</u> .....	1764
<u>More</u> .....	1764
<b><u>File:ToolsCountdownTimer1.PNG</u></b> .....	<b>1765</b>
<u>File history</u> .....	1765
<u>File usage</u> .....	1765
<u>Metadata</u> .....	1765
<u>Namespaces</u> .....	1766
<u>Variants</u> .....	1766
<u>Views</u> .....	1766
<u>More</u> .....	1766
<b><u>File:ToolsCountdownTimer1.PNG</u></b> .....	<b>1767</b>
<u>File history</u> .....	1767
<u>File usage</u> .....	1767
<u>Metadata</u> .....	1767
<u>Namespaces</u> .....	1768
<u>Variants</u> .....	1768
<u>Views</u> .....	1768
<u>More</u> .....	1768

# Table of Contents

<b><u>File:ToolsCountdownTimer2.PNG</u></b> .....	<b>1769</b>
<u>File history</u> .....	1769
<u>File usage</u> .....	1769
<u>Metadata</u> .....	1769
<u>Namespaces</u> .....	1770
<u>Variants</u> .....	1770
<u>Views</u> .....	1770
<u>More</u> .....	1770
<b><u>File:ToolsCountdownTimer2.PNG</u></b> .....	<b>1771</b>
<u>File history</u> .....	1771
<u>File usage</u> .....	1771
<u>Metadata</u> .....	1771
<u>Namespaces</u> .....	1772
<u>Variants</u> .....	1772
<u>Views</u> .....	1772
<u>More</u> .....	1772
<b><u>File:ToolsDataEntrySwitchKeyboard.PNG</u></b> .....	<b>1773</b>
<u>File history</u> .....	1773
<u>File usage</u> .....	1773
<u>Namespaces</u> .....	1773
<u>Variants</u> .....	1773
<u>Views</u> .....	1773
<u>More</u> .....	1774
<b><u>File:ToolsDataEntrySwitchKeyboard.PNG</u></b> .....	<b>1775</b>
<u>File history</u> .....	1775
<u>File usage</u> .....	1775
<u>Namespaces</u> .....	1775
<u>Variants</u> .....	1775
<u>Views</u> .....	1775
<u>More</u> .....	1776
<b><u>File:ToolsDownloadFiles.PNG</u></b> .....	<b>1777</b>
<u>File history</u> .....	1777
<u>File usage</u> .....	1777
<u>Namespaces</u> .....	1777
<u>Variants</u> .....	1778
<u>Views</u> .....	1778
<u>More</u> .....	1778
<b><u>File:ToolsDownloadFiles.PNG</u></b> .....	<b>1779</b>
<u>File history</u> .....	1779
<u>File usage</u> .....	1779
<u>Namespaces</u> .....	1779
<u>Variants</u> .....	1780
<u>Views</u> .....	1780

# Table of Contents

<b><u>File:ToolsDownloadFiles.PNG</u></b>	
<u>More</u> .....	1780
<b><u>File:ToolsEnableSPSwitching.gif</u></b> .....	<b>1781</b>
<u>File history</u> .....	1781
<u>File usage</u> .....	1781
<u>Namespaces</u> .....	1781
<u>Variants</u> .....	1782
<u>Views</u> .....	1782
<u>More</u> .....	1782
<b><u>File:ToolsEnableSPSwitching.gif</u></b> .....	<b>1783</b>
<u>File history</u> .....	1783
<u>File usage</u> .....	1783
<u>Namespaces</u> .....	1783
<u>Variants</u> .....	1784
<u>Views</u> .....	1784
<u>More</u> .....	1784
<b><u>File:ToolsExportObjectiveFile.gif</u></b> .....	<b>1785</b>
<u>File history</u> .....	1785
<u>File usage</u> .....	1785
<u>Namespaces</u> .....	1786
<u>Variants</u> .....	1786
<u>Views</u> .....	1786
<u>More</u> .....	1786
<b><u>File:ToolsExportObjectiveFile.gif</u></b> .....	<b>1787</b>
<u>File history</u> .....	1787
<u>File usage</u> .....	1787
<u>Namespaces</u> .....	1788
<u>Variants</u> .....	1788
<u>Views</u> .....	1788
<u>More</u> .....	1788
<b><u>File:ToolsIntelligentQuickOSL.gif</u></b> .....	<b>1789</b>
<u>File history</u> .....	1790
<u>File usage</u> .....	1790
<u>Namespaces</u> .....	1790
<u>Variants</u> .....	1790
<u>Views</u> .....	1790
<u>More</u> .....	1790
<b><u>File:ToolsIntelligentQuickOSL.gif</u></b> .....	<b>1791</b>
<u>File history</u> .....	1792
<u>File usage</u> .....	1792
<u>Namespaces</u> .....	1792
<u>Variants</u> .....	1792

# Table of Contents

<b><u>File:ToolsIntelligentQuickOSL.gif</u></b>	
<u>Views</u> .....	1792
<u>More</u> .....	1792
<b><u>File:ToolsRedefineKeyboard.gif</u></b> .....	<b>1793</b>
<u>File history</u> .....	1793
<u>File usage</u> .....	1793
<u>Namespaces</u> .....	1794
<u>Variants</u> .....	1794
<u>Views</u> .....	1794
<u>More</u> .....	1794
<b><u>File:ToolsRedefineKeyboard2.gif</u></b> .....	<b>1795</b>
<u>File history</u> .....	1795
<u>File usage</u> .....	1795
<u>Namespaces</u> .....	1795
<u>Variants</u> .....	1796
<u>Views</u> .....	1796
<u>More</u> .....	1796
<b><u>File:ToolsRedefineKeyboard2.gif</u></b> .....	<b>1797</b>
<u>File history</u> .....	1797
<u>File usage</u> .....	1797
<u>Namespaces</u> .....	1797
<u>Variants</u> .....	1798
<u>Views</u> .....	1798
<u>More</u> .....	1798
<b><u>File:ToolsRedefineKeyboard.gif</u></b> .....	<b>1799</b>
<u>File history</u> .....	1799
<u>File usage</u> .....	1799
<u>Namespaces</u> .....	1800
<u>Variants</u> .....	1800
<u>Views</u> .....	1800
<u>More</u> .....	1800
<b><u>File:ToolsScriptManager.PNG</u></b> .....	<b>1801</b>
<u>File history</u> .....	1801
<u>File usage</u> .....	1802
<u>Metadata</u> .....	1802
<u>Namespaces</u> .....	1802
<u>Variants</u> .....	1802
<u>Views</u> .....	1802
<u>More</u> .....	1802
<b><u>File:ToolsScriptManager.PNG</u></b> .....	<b>1803</b>
<u>File history</u> .....	1803
<u>File usage</u> .....	1804

# Table of Contents

<b><u>File:ToolsScriptManager.PNG</u></b>	
<u>Metadata</u> .....	1804
<u>Namespaces</u> .....	1804
<u>Variants</u> .....	1804
<u>Views</u> .....	1804
<u>More</u> .....	1804
<b><u>File:Total.PNG</u>.....</b>	<b>1805</b>
<u>File history</u> .....	1806
<u>File usage</u> .....	1806
<u>Namespaces</u> .....	1806
<u>Variants</u> .....	1806
<u>Views</u> .....	1806
<u>More</u> .....	1806
<b><u>File:Total.PNG</u>.....</b>	<b>1807</b>
<u>File history</u> .....	1808
<u>File usage</u> .....	1808
<u>Namespaces</u> .....	1808
<u>Variants</u> .....	1808
<u>Views</u> .....	1808
<u>More</u> .....	1808
<b><u>File:TryFixFile.gif</u>.....</b>	<b>1809</b>
<u>File history</u> .....	1809
<u>File usage</u> .....	1809
<u>Namespaces</u> .....	1809
<u>Variants</u> .....	1809
<u>Views</u> .....	1810
<u>More</u> .....	1810
<b><u>File:TryFixFile.gif</u>.....</b>	<b>1811</b>
<u>File history</u> .....	1811
<u>File usage</u> .....	1811
<u>Namespaces</u> .....	1811
<u>Variants</u> .....	1811
<u>Views</u> .....	1812
<u>More</u> .....	1812
<b><u>File:Uniques report.gif</u>.....</b>	<b>1813</b>
<u>File history</u> .....	1814
<u>File usage</u> .....	1814
<u>Metadata</u> .....	1814
<u>Namespaces</u> .....	1814
<u>Variants</u> .....	1814
<u>Views</u> .....	1814
<u>More</u> .....	1815

# Table of Contents

<b><u>File:Uniques report.gif</u></b> .....	<b>1816</b>
<u>File history</u> .....	1817
<u>File usage</u> .....	1817
<u>Metadata</u> .....	1817
<u>Namespaces</u> .....	1817
<u>Variants</u> .....	1817
<u>Views</u> .....	1817
<u>More</u> .....	1818
<b><u>File:urouterSetupMKControl.gif</u></b> .....	<b>1819</b>
<u>File history</u> .....	1820
<u>File usage</u> .....	1820
<u>Metadata</u> .....	1820
<u>Namespaces</u> .....	1820
<u>Variants</u> .....	1820
<u>Views</u> .....	1820
<u>More</u> .....	1820
<b><u>File:urouterSetupMKControl.gif</u></b> .....	<b>1822</b>
<u>File history</u> .....	1823
<u>File usage</u> .....	1823
<u>Metadata</u> .....	1823
<u>Namespaces</u> .....	1823
<u>Variants</u> .....	1823
<u>Views</u> .....	1823
<u>More</u> .....	1823
<b><u>File:Usbic.gif</u></b> .....	<b>1825</b>
<u>File history</u> .....	1825
<u>File usage</u> .....	1825
<u>Namespaces</u> .....	1826
<u>Variants</u> .....	1826
<u>Views</u> .....	1826
<u>More</u> .....	1826
<b><u>File:Usbic.gif</u></b> .....	<b>1827</b>
<u>File history</u> .....	1827
<u>File usage</u> .....	1827
<u>Namespaces</u> .....	1828
<u>Variants</u> .....	1828
<u>Views</u> .....	1828
<u>More</u> .....	1828
<b><u>File:UsedFilesList.PNG</u></b> .....	<b>1829</b>
<u>File history</u> .....	1829
<u>File usage</u> .....	1829
<u>Namespaces</u> .....	1829
<u>Variants</u> .....	1830

# Table of Contents

<b><u>File:UsedFilesList.PNG</u></b>	
<u>Views</u> .....	1830
<u>More</u> .....	1830
<b><u>File:UsedFilesList.PNG</u></b> .....	<b>1831</b>
<u>File history</u> .....	1831
<u>File usage</u> .....	1831
<u>Namespaces</u> .....	1831
<u>Variants</u> .....	1832
<u>Views</u> .....	1832
<u>More</u> .....	1832
<b><u>File:VOICESettingsmicroHAM.gif</u></b> .....	<b>1833</b>
<u>File history</u> .....	1834
<u>File usage</u> .....	1834
<u>Metadata</u> .....	1834
<u>Namespaces</u> .....	1834
<u>Variants</u> .....	1834
<u>Views</u> .....	1834
<u>More</u> .....	1834
<b><u>File:VOICESettingsmicroHAM.gif</u></b> .....	<b>1836</b>
<u>File history</u> .....	1837
<u>File usage</u> .....	1837
<u>Metadata</u> .....	1837
<u>Namespaces</u> .....	1837
<u>Variants</u> .....	1837
<u>Views</u> .....	1837
<u>More</u> .....	1837
<b><u>File:WAEDCadditional-qtcinfo.gif</u></b> .....	<b>1839</b>
<u>File history</u> .....	1840
<u>File usage</u> .....	1840
<u>Namespaces</u> .....	1840
<u>Variants</u> .....	1840
<u>Views</u> .....	1840
<u>More</u> .....	1840
<b><u>File:WAEDCadditional-qtcinfo.gif</u></b> .....	<b>1841</b>
<u>File history</u> .....	1842
<u>File usage</u> .....	1842
<u>Namespaces</u> .....	1842
<u>Variants</u> .....	1842
<u>Views</u> .....	1842
<u>More</u> .....	1842

# Table of Contents

<b><u>File:WAEDC-radiopotentialqtc.gif</u></b> .....	<b>1843</b>
<u>File history</u> .....	1844
<u>File usage</u> .....	1844
<u>Namespaces</u> .....	1844
<u>Variants</u> .....	1844
<u>Views</u> .....	1844
<u>More</u> .....	1844
<b><u>File:WAEDC-radiopotentialqtc.gif</u></b> .....	<b>1845</b>
<u>File history</u> .....	1846
<u>File usage</u> .....	1846
<u>Namespaces</u> .....	1846
<u>Variants</u> .....	1846
<u>Views</u> .....	1846
<u>More</u> .....	1846
<b><u>File:WaeMessagesRx.gif</u></b> .....	<b>1847</b>
<u>File history</u> .....	1847
<u>File usage</u> .....	1847
<u>Namespaces</u> .....	1848
<u>Variants</u> .....	1848
<u>Views</u> .....	1848
<u>More</u> .....	1848
<b><u>File:WaeMessagesRx.gif</u></b> .....	<b>1849</b>
<u>File history</u> .....	1849
<u>File usage</u> .....	1849
<u>Namespaces</u> .....	1850
<u>Variants</u> .....	1850
<u>Views</u> .....	1850
<u>More</u> .....	1850
<b><u>File:WaeMessagesTx.gif</u></b> .....	<b>1851</b>
<u>File history</u> .....	1851
<u>File usage</u> .....	1851
<u>Namespaces</u> .....	1852
<u>Variants</u> .....	1852
<u>Views</u> .....	1852
<u>More</u> .....	1852
<b><u>File:WaeMessagesTx.gif</u></b> .....	<b>1853</b>
<u>File history</u> .....	1853
<u>File usage</u> .....	1853
<u>Namespaces</u> .....	1854
<u>Variants</u> .....	1854
<u>Views</u> .....	1854
<u>More</u> .....	1854



# Table of Contents

<b><u>File:WindowsBandMapContextMenu.PNG</u></b> .....	<b>1855</b>
<u>File history</u> .....	1856
<u>File usage</u> .....	1856
<u>Metadata</u> .....	1856
<u>Namespaces</u> .....	1856
<u>Variants</u> .....	1856
<u>Views</u> .....	1857
<u>More</u> .....	1857
<b><u>File:WindowsBandMapContextMenu.PNG</u></b> .....	<b>1858</b>
<u>File history</u> .....	1859
<u>File usage</u> .....	1859
<u>Metadata</u> .....	1859
<u>Namespaces</u> .....	1859
<u>Variants</u> .....	1859
<u>Views</u> .....	1860
<u>More</u> .....	1860
<b><u>File:WindowsBandMapCqCursor.gif</u></b> .....	<b>1861</b>
<u>File history</u> .....	1861
<u>File usage</u> .....	1861
<u>Namespaces</u> .....	1861
<u>Variants</u> .....	1862
<u>Views</u> .....	1862
<u>More</u> .....	1862
<b><u>File:WindowsBandMapCqCursor.gif</u></b> .....	<b>1863</b>
<u>File history</u> .....	1863
<u>File usage</u> .....	1863
<u>Namespaces</u> .....	1863
<u>Variants</u> .....	1864
<u>Views</u> .....	1864
<u>More</u> .....	1864
<b><u>File:WindowsBandMapListViewContextMenuDisplay.gif</u></b> .....	<b>1865</b>
<u>File history</u> .....	1866
<u>File usage</u> .....	1866
<u>Metadata</u> .....	1866
<u>Namespaces</u> .....	1866
<u>Variants</u> .....	1867
<u>Views</u> .....	1867
<u>More</u> .....	1867
<b><u>File:WindowsBandMapListViewContextMenuDisplay.gif</u></b> .....	<b>1868</b>
<u>File history</u> .....	1869
<u>File usage</u> .....	1869
<u>Metadata</u> .....	1869
<u>Namespaces</u> .....	1869

# Table of Contents

<b><u>File:WindowsBandMapListViewContextMenuDisplay.gif</u></b>	
<u>Variants</u> .....	1870
<u>Views</u> .....	1870
<u>More</u> .....	1870
<b><u>File:WindowsBandMapListViewContextMenuSort.gif</u></b> .....	<b>1871</b>
<u>File history</u> .....	1872
<u>File usage</u> .....	1872
<u>Metadata</u> .....	1872
<u>Namespaces</u> .....	1872
<u>Variants</u> .....	1873
<u>Views</u> .....	1873
<u>More</u> .....	1873
<b><u>File:WindowsBandMapListViewContextMenuSort.gif</u></b> .....	<b>1874</b>
<u>File history</u> .....	1875
<u>File usage</u> .....	1875
<u>Metadata</u> .....	1875
<u>Namespaces</u> .....	1875
<u>Variants</u> .....	1876
<u>Views</u> .....	1876
<u>More</u> .....	1876
<b><u>File:WindowsBandmapMarker.gif</u></b> .....	<b>1877</b>
<u>File history</u> .....	1877
<u>File usage</u> .....	1878
<u>Namespaces</u> .....	1878
<u>Variants</u> .....	1878
<u>Views</u> .....	1878
<u>More</u> .....	1878
<b><u>File:WindowsBandmapMarker.gif</u></b> .....	<b>1879</b>
<u>File history</u> .....	1879
<u>File usage</u> .....	1880
<u>Namespaces</u> .....	1880
<u>Variants</u> .....	1880
<u>Views</u> .....	1880
<u>More</u> .....	1880
<b><u>File:WindowsBandmapSegments.gif</u></b> .....	<b>1881</b>
<u>File history</u> .....	1882
<u>File usage</u> .....	1882
<u>Namespaces</u> .....	1882
<u>Variants</u> .....	1882
<u>Views</u> .....	1882
<u>More</u> .....	1882

# Table of Contents

<b><u>File:WindowsBandmapSegments.gif</u></b> .....	<b>1884</b>
<u>File history</u> .....	1885
<u>File usage</u> .....	1885
<u>Namespaces</u> .....	1885
<u>Variants</u> .....	1885
<u>Views</u> .....	1885
<u>More</u> .....	1885
<b><u>File:WindowsCheckCallsign.gif</u></b> .....	<b>1887</b>
<u>File history</u> .....	1887
<u>File usage</u> .....	1887
<u>Namespaces</u> .....	1887
<u>Variants</u> .....	1888
<u>Views</u> .....	1888
<u>More</u> .....	1888
<b><u>File:WindowsCheckCallsign.gif</u></b> .....	<b>1889</b>
<u>File history</u> .....	1889
<u>File usage</u> .....	1889
<u>Namespaces</u> .....	1889
<u>Variants</u> .....	1890
<u>Views</u> .....	1890
<u>More</u> .....	1890
<b><u>File:WindowsCheckCountry.PNG</u></b> .....	<b>1891</b>
<u>File history</u> .....	1891
<u>File usage</u> .....	1891
<u>Namespaces</u> .....	1892
<u>Variants</u> .....	1892
<u>Views</u> .....	1892
<u>More</u> .....	1892
<b><u>File:WindowsCheckCountry.PNG</u></b> .....	<b>1893</b>
<u>File history</u> .....	1893
<u>File usage</u> .....	1893
<u>Namespaces</u> .....	1894
<u>Variants</u> .....	1894
<u>Views</u> .....	1894
<u>More</u> .....	1894
<b><u>File:WindowsCheckMult1.gif</u></b> .....	<b>1895</b>
<u>File history</u> .....	1895
<u>File usage</u> .....	1895
<u>Namespaces</u> .....	1895
<u>Variants</u> .....	1895
<u>Views</u> .....	1895
<u>More</u> .....	1896

# Table of Contents

<b><u>File:WindowsCheckMult1.gif</u></b> .....	<b>1897</b>
<u>File history</u> .....	1897
<u>File usage</u> .....	1897
<u>Namespaces</u> .....	1897
<u>Variants</u> .....	1897
<u>Views</u> .....	1897
<u>More</u> .....	1898
<b><u>File:WindowsCheckMult2.gif</u></b> .....	<b>1899</b>
<u>File history</u> .....	1899
<u>File usage</u> .....	1899
<u>Namespaces</u> .....	1899
<u>Variants</u> .....	1899
<u>Views</u> .....	1900
<u>More</u> .....	1900
<b><u>File:WindowsCheckMult2.gif</u></b> .....	<b>1901</b>
<u>File history</u> .....	1901
<u>File usage</u> .....	1901
<u>Namespaces</u> .....	1901
<u>Variants</u> .....	1901
<u>Views</u> .....	1902
<u>More</u> .....	1902
<b><u>File:WindowsCheckMult3.gif</u></b> .....	<b>1903</b>
<u>File history</u> .....	1903
<u>File usage</u> .....	1903
<u>Namespaces</u> .....	1903
<u>Variants</u> .....	1903
<u>Views</u> .....	1904
<u>More</u> .....	1904
<b><u>File:WindowsCheckMult3.gif</u></b> .....	<b>1905</b>
<u>File history</u> .....	1905
<u>File usage</u> .....	1905
<u>Namespaces</u> .....	1905
<u>Variants</u> .....	1905
<u>Views</u> .....	1906
<u>More</u> .....	1906
<b><u>File:WindowsCheckPartial.gif</u></b> .....	<b>1907</b>
<u>File history</u> .....	1907
<u>File usage</u> .....	1907
<u>Namespaces</u> .....	1907
<u>Variants</u> .....	1907
<u>Views</u> .....	1907
<u>More</u> .....	1908

# Table of Contents

<b><u>File:WindowsCheckPartial.gif</u></b> .....	<b>1909</b>
<u>File history</u> .....	1909
<u>File usage</u> .....	1909
<u>Namespaces</u> .....	1909
<u>Variants</u> .....	1909
<u>Views</u> .....	1909
<u>More</u> .....	1910
<b><u>File:WindowsCheckPartialOptions.gif</u></b> .....	<b>1911</b>
<u>File history</u> .....	1911
<u>File usage</u> .....	1912
<u>Namespaces</u> .....	1912
<u>Variants</u> .....	1912
<u>Views</u> .....	1912
<u>More</u> .....	1912
<b><u>File:WindowsCheckPartialOptions.gif</u></b> .....	<b>1913</b>
<u>File history</u> .....	1913
<u>File usage</u> .....	1914
<u>Namespaces</u> .....	1914
<u>Variants</u> .....	1914
<u>Views</u> .....	1914
<u>More</u> .....	1914
<b><u>File:WindowsCheckPartialOTHLocator.PNG</u></b> .....	<b>1915</b>
<u>File history</u> .....	1916
<u>File usage</u> .....	1916
<u>Namespaces</u> .....	1916
<u>Variants</u> .....	1916
<u>Views</u> .....	1916
<u>More</u> .....	1916
<b><u>File:WindowsCheckPartialOTHLocator.PNG</u></b> .....	<b>1917</b>
<u>File history</u> .....	1918
<u>File usage</u> .....	1918
<u>Namespaces</u> .....	1918
<u>Variants</u> .....	1918
<u>Views</u> .....	1918
<u>More</u> .....	1918
<b><u>File:WindowsCheckPartialResult.gif</u></b> .....	<b>1919</b>
<u>File history</u> .....	1919
<u>File usage</u> .....	1919
<u>Namespaces</u> .....	1919
<u>Variants</u> .....	1920
<u>Views</u> .....	1920
<u>More</u> .....	1920

# Table of Contents

<b><u>File:WindowsCheckPartialResult.gif</u></b> .....	<b>1921</b>
<u>File history</u> .....	1921
<u>File usage</u> .....	1921
<u>Namespaces</u> .....	1921
<u>Variants</u> .....	1922
<u>Views</u> .....	1922
<u>More</u> .....	1922
<b><u>File:WindowsCheckPartialShiftF10.gif</u></b> .....	<b>1923</b>
<u>File history</u> .....	1923
<u>File usage</u> .....	1923
<u>Namespaces</u> .....	1923
<u>Variants</u> .....	1923
<u>Views</u> .....	1923
<u>More</u> .....	1924
<b><u>File:WindowsCheckPartialShiftF10.gif</u></b> .....	<b>1925</b>
<u>File history</u> .....	1925
<u>File usage</u> .....	1925
<u>Namespaces</u> .....	1925
<u>Variants</u> .....	1925
<u>Views</u> .....	1925
<u>More</u> .....	1926
<b><u>File:WindowsDxClusterAnn.gif</u></b> .....	<b>1927</b>
<u>File history</u> .....	1927
<u>File usage</u> .....	1927
<u>Metadata</u> .....	1927
<u>Namespaces</u> .....	1928
<u>Variants</u> .....	1928
<u>Views</u> .....	1928
<u>More</u> .....	1928
<b><u>File:WindowsDxClusterAnn.gif</u></b> .....	<b>1929</b>
<u>File history</u> .....	1929
<u>File usage</u> .....	1929
<u>Metadata</u> .....	1929
<u>Namespaces</u> .....	1930
<u>Variants</u> .....	1930
<u>Views</u> .....	1930
<u>More</u> .....	1930
<b><u>File:WindowsExtraDataFiles.gif</u></b> .....	<b>1931</b>
<u>File history</u> .....	1931
<u>File usage</u> .....	1931
<u>Namespaces</u> .....	1931
<u>Variants</u> .....	1931
<u>Views</u> .....	1931

# Table of Contents

<b><u>File:WindowsExtraDataFiles.gif</u></b>	
<u>More</u> .....	1931
<b><u>File:WindowsExtraDataFiles.gif</u></b> .....	<b>1933</b>
<u>File history</u> .....	1933
<u>File usage</u> .....	1933
<u>Namespaces</u> .....	1933
<u>Variants</u> .....	1933
<u>Views</u> .....	1933
<u>More</u> .....	1933
<b><u>File:WindowsGab.gif</u></b> .....	<b>1935</b>
<u>File history</u> .....	1935
<u>File usage</u> .....	1935
<u>Namespaces</u> .....	1936
<u>Variants</u> .....	1936
<u>Views</u> .....	1936
<u>More</u> .....	1936
<b><u>File:WindowsGab.gif</u></b> .....	<b>1937</b>
<u>File history</u> .....	1937
<u>File usage</u> .....	1937
<u>Namespaces</u> .....	1938
<u>Variants</u> .....	1938
<u>Views</u> .....	1938
<u>More</u> .....	1938
<b><u>File:WindowsGridSquareMap1.gif</u></b> .....	<b>1939</b>
<u>File history</u> .....	1939
<u>File usage</u> .....	1939
<u>Namespaces</u> .....	1940
<u>Variants</u> .....	1940
<u>Views</u> .....	1940
<u>More</u> .....	1940
<b><u>File:WindowsGridSquareMap1.gif</u></b> .....	<b>1941</b>
<u>File history</u> .....	1941
<u>File usage</u> .....	1941
<u>Namespaces</u> .....	1942
<u>Variants</u> .....	1942
<u>Views</u> .....	1942
<u>More</u> .....	1942
<b><u>File:Windows IP settings.gif</u></b> .....	<b>1943</b>
<u>File history</u> .....	1943
<u>File usage</u> .....	1943
<u>Namespaces</u> .....	1944
<u>Variants</u> .....	1944

# Table of Contents

<b><u>File:Windows IP settings.gif</u></b>	
<u>Views</u> .....	1944
<u>More</u> .....	1944
<b><u>File:Windows IP settings.gif</u></b> .....	<b>1945</b>
<u>File history</u> .....	1945
<u>File usage</u> .....	1945
<u>Namespaces</u> .....	1946
<u>Variants</u> .....	1946
<u>Views</u> .....	1946
<u>More</u> .....	1946
<b><u>File:WindowsMap.gif</u></b> .....	<b>1947</b>
<u>File history</u> .....	1947
<u>File usage</u> .....	1947
<u>Namespaces</u> .....	1948
<u>Variants</u> .....	1948
<u>Views</u> .....	1948
<u>More</u> .....	1948
<b><u>File:WindowsMap.gif</u></b> .....	<b>1949</b>
<u>File history</u> .....	1949
<u>File usage</u> .....	1949
<u>Namespaces</u> .....	1950
<u>Variants</u> .....	1950
<u>Views</u> .....	1950
<u>More</u> .....	1950
<b><u>File:WindowsMult.gif</u></b> .....	<b>1951</b>
<u>File history</u> .....	1952
<u>File usage</u> .....	1952
<u>Namespaces</u> .....	1952
<u>Variants</u> .....	1952
<u>Views</u> .....	1952
<u>More</u> .....	1952
<b><u>File:WindowsMult.gif</u></b> .....	<b>1953</b>
<u>File history</u> .....	1954
<u>File usage</u> .....	1954
<u>Namespaces</u> .....	1954
<u>Variants</u> .....	1954
<u>Views</u> .....	1954
<u>More</u> .....	1954
<b><u>File:WindowsNcdxfIbpBeacons.gif</u></b> .....	<b>1955</b>
<u>File history</u> .....	1955
<u>File usage</u> .....	1955
<u>Metadata</u> .....	1955



# Table of Contents

<b><u>File:WindowsNcdxfIbpBeacons.gif</u></b>	
<u>Namespaces</u> .....	1956
<u>Variants</u> .....	1956
<u>Views</u> .....	1956
<u>More</u> .....	1956
<b><u>File:WindowsNcdxfIbpBeacons.gif</u></b> .....	<b>1957</b>
<u>File history</u> .....	1957
<u>File usage</u> .....	1957
<u>Metadata</u> .....	1957
<u>Namespaces</u> .....	1958
<u>Variants</u> .....	1958
<u>Views</u> .....	1958
<u>More</u> .....	1958
<b><u>File:WindowsNp1 1.gif</u></b> .....	<b>1959</b>
<u>File history</u> .....	1959
<u>File usage</u> .....	1959
<u>Namespaces</u> .....	1959
<u>Variants</u> .....	1959
<u>Views</u> .....	1959
<u>More</u> .....	1960
<b><u>File:WindowsNp1 1.gif</u></b> .....	<b>1961</b>
<u>File history</u> .....	1961
<u>File usage</u> .....	1961
<u>Namespaces</u> .....	1961
<u>Variants</u> .....	1961
<u>Views</u> .....	1961
<u>More</u> .....	1962
<b><u>File:WindowsNp1 2.gif</u></b> .....	<b>1963</b>
<u>File history</u> .....	1963
<u>File usage</u> .....	1963
<u>Namespaces</u> .....	1963
<u>Variants</u> .....	1963
<u>Views</u> .....	1963
<u>More</u> .....	1964
<b><u>File:WindowsNp1 2.gif</u></b> .....	<b>1965</b>
<u>File history</u> .....	1965
<u>File usage</u> .....	1965
<u>Namespaces</u> .....	1965
<u>Variants</u> .....	1965
<u>Views</u> .....	1965
<u>More</u> .....	1966

# Table of Contents

<b><u>File:WindowsNp1 3.gif</u></b> .....	<b>1967</b>
<u>File history</u> .....	1967
<u>File usage</u> .....	1967
<u>Namespaces</u> .....	1968
<u>Variants</u> .....	1968
<u>Views</u> .....	1968
<u>More</u> .....	1968
<b><u>File:WindowsNp1 3.gif</u></b> .....	<b>1969</b>
<u>File history</u> .....	1969
<u>File usage</u> .....	1969
<u>Namespaces</u> .....	1970
<u>Variants</u> .....	1970
<u>Views</u> .....	1970
<u>More</u> .....	1970
<b><u>File:WindowsPacket.gif</u></b> .....	<b>1971</b>
<u>File history</u> .....	1971
<u>File usage</u> .....	1971
<u>Namespaces</u> .....	1972
<u>Variants</u> .....	1972
<u>Views</u> .....	1972
<u>More</u> .....	1972
<b><u>File:WindowsPacket.gif</u></b> .....	<b>1973</b>
<u>File history</u> .....	1973
<u>File usage</u> .....	1973
<u>Namespaces</u> .....	1974
<u>Variants</u> .....	1974
<u>Views</u> .....	1974
<u>More</u> .....	1974
<b><u>File:WindowsPartnerWindowProperties.PNG</u></b> .....	<b>1975</b>
<u>File history</u> .....	1975
<u>File usage</u> .....	1976
<u>Metadata</u> .....	1976
<u>Namespaces</u> .....	1976
<u>Variants</u> .....	1976
<u>Views</u> .....	1976
<u>More</u> .....	1976
<b><u>File:WindowsPartnerWindowProperties.PNG</u></b> .....	<b>1977</b>
<u>File history</u> .....	1977
<u>File usage</u> .....	1978
<u>Metadata</u> .....	1978
<u>Namespaces</u> .....	1978
<u>Variants</u> .....	1978
<u>Views</u> .....	1978

# Table of Contents

<b><u>File:WindowsPartnerWindowProperties.PNG</u></b>	
<u>More</u> .....	1978
<b><u>File:WindowsPartnerWindowRealtimefeature.PNG</u></b> .....	<b>1979</b>
<u>File history</u> .....	1979
<u>File usage</u> .....	1979
<u>Metadata</u> .....	1980
<u>Namespaces</u> .....	1980
<u>Variants</u> .....	1980
<u>Views</u> .....	1980
<u>More</u> .....	1980
<b><u>File:WindowsPartnerWindowRealtimefeature.PNG</u></b> .....	<b>1981</b>
<u>File history</u> .....	1981
<u>File usage</u> .....	1981
<u>Metadata</u> .....	1982
<u>Namespaces</u> .....	1982
<u>Variants</u> .....	1982
<u>Views</u> .....	1982
<u>More</u> .....	1982
<b><u>File:WindowsOsyWizard.gif</u></b> .....	<b>1983</b>
<u>File history</u> .....	1983
<u>File usage</u> .....	1983
<u>Namespaces</u> .....	1983
<u>Variants</u> .....	1983
<u>Views</u> .....	1984
<u>More</u> .....	1984
<b><u>File:WindowsOsyWizard.gif</u></b> .....	<b>1985</b>
<u>File history</u> .....	1985
<u>File usage</u> .....	1985
<u>Namespaces</u> .....	1985
<u>Variants</u> .....	1985
<u>Views</u> .....	1986
<u>More</u> .....	1986
<b><u>File:WindowsRadio.gif</u></b> .....	<b>1987</b>
<u>File history</u> .....	1988
<u>File usage</u> .....	1988
<u>Namespaces</u> .....	1988
<u>Variants</u> .....	1988
<u>Views</u> .....	1988
<u>More</u> .....	1988
<b><u>File:WindowsRadio.gif</u></b> .....	<b>1989</b>
<u>File history</u> .....	1990
<u>File usage</u> .....	1990

# Table of Contents

<b><u>File:WindowsRadio.gif</u></b>	
<u>Namespaces</u> .....	1990
<u>Variants</u> .....	1990
<u>Views</u> .....	1990
<u>More</u> .....	1990
<b><u>File:WindowsRate.PNG</u></b> .....	<b>1991</b>
<u>File history</u> .....	1992
<u>File usage</u> .....	1992
<u>Namespaces</u> .....	1992
<u>Variants</u> .....	1992
<u>Views</u> .....	1992
<u>More</u> .....	1992
<b><u>File:WindowsRate.PNG</u></b> .....	<b>1993</b>
<u>File history</u> .....	1994
<u>File usage</u> .....	1994
<u>Namespaces</u> .....	1994
<u>Variants</u> .....	1994
<u>Views</u> .....	1994
<u>More</u> .....	1994
<b><u>File:WindowsRateSheet.gif</u></b> .....	<b>1995</b>
<u>File history</u> .....	1995
<u>File usage</u> .....	1995
<u>Namespaces</u> .....	1996
<u>Variants</u> .....	1996
<u>Views</u> .....	1996
<u>More</u> .....	1996
<b><u>File:WindowsRateSheet.gif</u></b> .....	<b>1997</b>
<u>File history</u> .....	1997
<u>File usage</u> .....	1997
<u>Namespaces</u> .....	1998
<u>Variants</u> .....	1998
<u>Views</u> .....	1998
<u>More</u> .....	1998
<b><u>File:WindowsRotators.PNG</u></b> .....	<b>1999</b>
<u>File history</u> .....	1999
<u>File usage</u> .....	1999
<u>Namespaces</u> .....	1999
<u>Variants</u> .....	1999
<u>Views</u> .....	2000
<u>More</u> .....	2000

# Table of Contents

<b><u>File:WindowsRotatorsConnected.PNG</u></b> .....	<b>2001</b>
<u>File history</u> .....	2001
<u>File usage</u> .....	2001
<u>Metadata</u> .....	2001
<u>Namespaces</u> .....	2002
<u>Variants</u> .....	2002
<u>Views</u> .....	2002
<u>More</u> .....	2002
<b><u>File:WindowsRotatorsConnected.PNG</u></b> .....	<b>2003</b>
<u>File history</u> .....	2003
<u>File usage</u> .....	2003
<u>Metadata</u> .....	2003
<u>Namespaces</u> .....	2004
<u>Variants</u> .....	2004
<u>Views</u> .....	2004
<u>More</u> .....	2004
<b><u>File:WindowsRotators.PNG</u></b> .....	<b>2005</b>
<u>File history</u> .....	2005
<u>File usage</u> .....	2005
<u>Namespaces</u> .....	2005
<u>Variants</u> .....	2005
<u>Views</u> .....	2006
<u>More</u> .....	2006
<b><u>File:WindowsSecondaryRadio.gif</u></b> .....	<b>2007</b>
<u>File history</u> .....	2007
<u>File usage</u> .....	2007
<u>Namespaces</u> .....	2007
<u>Variants</u> .....	2008
<u>Views</u> .....	2008
<u>More</u> .....	2008
<b><u>File:WindowsSecondaryRadio.gif</u></b> .....	<b>2009</b>
<u>File history</u> .....	2009
<u>File usage</u> .....	2009
<u>Namespaces</u> .....	2009
<u>Variants</u> .....	2010
<u>Views</u> .....	2010
<u>More</u> .....	2010
<b><u>File:WindowsSelectCty.gif</u></b> .....	<b>2011</b>
<u>File history</u> .....	2011
<u>File usage</u> .....	2012
<u>Namespaces</u> .....	2012
<u>Variants</u> .....	2012
<u>Views</u> .....	2012

# Table of Contents

<b><u>File:WindowsSelectCty.gif</u></b>	
<u>More</u> .....	2012
<b><u>File:WindowsSelectCty.gif</u></b> .....	<b>2013</b>
<u>File history</u> .....	2013
<u>File usage</u> .....	2014
<u>Namespaces</u> .....	2014
<u>Variants</u> .....	2014
<u>Views</u> .....	2014
<u>More</u> .....	2014
<b><u>File:WindowsSked.gif</u></b> .....	<b>2015</b>
<u>File history</u> .....	2016
<u>File usage</u> .....	2016
<u>Namespaces</u> .....	2016
<u>Variants</u> .....	2016
<u>Views</u> .....	2016
<u>More</u> .....	2016
<b><u>File:WindowsSked.gif</u></b> .....	<b>2018</b>
<u>File history</u> .....	2019
<u>File usage</u> .....	2019
<u>Namespaces</u> .....	2019
<u>Variants</u> .....	2019
<u>Views</u> .....	2019
<u>More</u> .....	2019
<b><u>File:WindowsSolarActivityWCY.gif</u></b> .....	<b>2021</b>
<u>File history</u> .....	2022
<u>File usage</u> .....	2022
<u>Namespaces</u> .....	2022
<u>Variants</u> .....	2022
<u>Views</u> .....	2022
<u>More</u> .....	2023
<b><u>File:WindowsSolarActivityWCY.gif</u></b> .....	<b>2024</b>
<u>File history</u> .....	2025
<u>File usage</u> .....	2025
<u>Namespaces</u> .....	2025
<u>Variants</u> .....	2025
<u>Views</u> .....	2025
<u>More</u> .....	2026
<b><u>File:WindowsSolarActivityWWV.gif</u></b> .....	<b>2027</b>
<u>File history</u> .....	2028
<u>File usage</u> .....	2028
<u>Namespaces</u> .....	2028
<u>Variants</u> .....	2028

# Table of Contents

<b><u>File:WindowsSolarActivityWWV.gif</u></b>	
<u>Views</u> .....	2028
<u>More</u> .....	2028
<b><u>File:WindowsSolarActivityWWV.gif</u></b> .....	<b>2030</b>
<u>File history</u> .....	2031
<u>File usage</u> .....	2031
<u>Namespaces</u> .....	2031
<u>Variants</u> .....	2031
<u>Views</u> .....	2031
<u>More</u> .....	2031
<b><u>File:WindowsStatus.gif</u></b> .....	<b>2033</b>
<u>File history</u> .....	2033
<u>File usage</u> .....	2033
<u>Namespaces</u> .....	2033
<u>Variants</u> .....	2033
<u>Views</u> .....	2033
<u>More</u> .....	2034
<b><u>File:WindowsStatus.gif</u></b> .....	<b>2035</b>
<u>File history</u> .....	2035
<u>File usage</u> .....	2035
<u>Namespaces</u> .....	2035
<u>Variants</u> .....	2035
<u>Views</u> .....	2035
<u>More</u> .....	2036
<b><u>File:WindowsSummary.gif</u></b> .....	<b>2037</b>
<u>File history</u> .....	2037
<u>File usage</u> .....	2037
<u>Namespaces</u> .....	2037
<u>Variants</u> .....	2038
<u>Views</u> .....	2038
<u>More</u> .....	2038
<b><u>File:WindowsSummary.gif</u></b> .....	<b>2039</b>
<u>File history</u> .....	2039
<u>File usage</u> .....	2039
<u>Namespaces</u> .....	2039
<u>Variants</u> .....	2040
<u>Views</u> .....	2040
<u>More</u> .....	2040
<b><u>File:WindowsVuMeter.gif</u></b> .....	<b>2041</b>
<u>File history</u> .....	2041
<u>File usage</u> .....	2041
<u>Namespaces</u> .....	2041

# Table of Contents

<b><u>File:WindowsVuMeter.gif</u></b>	
<u>Variants</u> .....	2041
<u>Views</u> .....	2041
<u>More</u> .....	2042
<b><u>File:WindowsVuMeter.gif</u></b> .....	<b>2043</b>
<u>File history</u> .....	2043
<u>File usage</u> .....	2043
<u>Namespaces</u> .....	2043
<u>Variants</u> .....	2043
<u>Views</u> .....	2043
<u>More</u> .....	2044
<b><u>File:WindowsWriteNote.gif</u></b> .....	<b>2045</b>
<u>File history</u> .....	2045
<u>File usage</u> .....	2045
<u>Namespaces</u> .....	2045
<u>Variants</u> .....	2045
<u>Views</u> .....	2045
<u>More</u> .....	2045
<b><u>File:WindowsWriteNote.gif</u></b> .....	<b>2047</b>
<u>File history</u> .....	2047
<u>File usage</u> .....	2047
<u>Namespaces</u> .....	2047
<u>Variants</u> .....	2047
<u>Views</u> .....	2047
<u>More</u> .....	2047
<b><u>File:WindowsZone1.gif</u></b> .....	<b>2049</b>
<u>File history</u> .....	2049
<u>File usage</u> .....	2049
<u>Namespaces</u> .....	2049
<u>Variants</u> .....	2050
<u>Views</u> .....	2050
<u>More</u> .....	2050
<b><u>File:WindowsZone1.gif</u></b> .....	<b>2051</b>
<u>File history</u> .....	2051
<u>File usage</u> .....	2051
<u>Namespaces</u> .....	2051
<u>Variants</u> .....	2052
<u>Views</u> .....	2052
<u>More</u> .....	2052
<b><u>File:WindowsZone2.gif</u></b> .....	<b>2053</b>
<u>File history</u> .....	2053
<u>File usage</u> .....	2053



# Table of Contents

<b><u>File:WindowsZone2.gif</u></b>	
<u>Namespaces</u> .....	2053
<u>Variants</u> .....	2053
<u>Views</u> .....	2054
<u>More</u> .....	2054
<b><u>File:WindowsZone2.gif</u></b> .....	<b>2055</b>
<u>File history</u> .....	2055
<u>File usage</u> .....	2055
<u>Namespaces</u> .....	2055
<u>Variants</u> .....	2055
<u>Views</u> .....	2056
<u>More</u> .....	2056
<b><u>File:WindowsZone3.gif</u></b> .....	<b>2057</b>
<u>File history</u> .....	2057
<u>File usage</u> .....	2057
<u>Namespaces</u> .....	2057
<u>Variants</u> .....	2057
<u>Views</u> .....	2058
<u>More</u> .....	2058
<b><u>File:WindowsZone3.gif</u></b> .....	<b>2059</b>
<u>File history</u> .....	2059
<u>File usage</u> .....	2059
<u>Namespaces</u> .....	2059
<u>Variants</u> .....	2059
<u>Views</u> .....	2060
<u>More</u> .....	2060
<b><u>File:wine serialconf.gif</u></b> .....	<b>2061</b>
<u>File history</u> .....	2061
<u>File usage</u> .....	2061
<u>Namespaces</u> .....	2062
<u>Variants</u> .....	2062
<u>Views</u> .....	2062
<u>More</u> .....	2062
<b><u>File:wine serialconf.gif</u></b> .....	<b>2063</b>
<u>File history</u> .....	2063
<u>File usage</u> .....	2063
<u>Namespaces</u> .....	2064
<u>Variants</u> .....	2064
<u>Views</u> .....	2064
<u>More</u> .....	2064

# Table of Contents

<b><u>File:WinkeyProperties.gif</u></b> .....	<b>2065</b>
<u>File history</u> .....	2065
<u>File usage</u> .....	2066
<u>Namespaces</u> .....	2066
<u>Variants</u> .....	2066
<u>Views</u> .....	2066
<u>More</u> .....	2066
<b><u>File:WinkeyProperties.gif</u></b> .....	<b>2067</b>
<u>File history</u> .....	2067
<u>File usage</u> .....	2068
<u>Namespaces</u> .....	2068
<u>Variants</u> .....	2068
<u>Views</u> .....	2068
<u>More</u> .....	2068
<b><u>File:wintest Config WinKey.gif</u></b> .....	<b>2069</b>
<u>File history</u> .....	2070
<u>File usage</u> .....	2070
<u>Namespaces</u> .....	2070
<u>Variants</u> .....	2070
<u>Views</u> .....	2070
<u>More</u> .....	2070
<b><u>File:wintest Config WinKey.gif</u></b> .....	<b>2071</b>
<u>File history</u> .....	2072
<u>File usage</u> .....	2072
<u>Namespaces</u> .....	2072
<u>Variants</u> .....	2072
<u>Views</u> .....	2072
<u>More</u> .....	2072
<b><u>File:wintest-linux wpxcw2007.gif</u></b> .....	<b>2073</b>
<u>File history</u> .....	2074
<u>File usage</u> .....	2074
<u>Namespaces</u> .....	2074
<u>Variants</u> .....	2074
<u>Views</u> .....	2074
<u>More</u> .....	2074
<b><u>File:wintest-linux wpxcw2007.gif</u></b> .....	<b>2076</b>
<u>File history</u> .....	2077
<u>File usage</u> .....	2077
<u>Namespaces</u> .....	2077
<u>Variants</u> .....	2077
<u>Views</u> .....	2077
<u>More</u> .....	2077

# Table of Contents

<b><u>File:WorldMapWithLightTerminator.gif</u></b> .....	<b>2079</b>
<u>File history</u> .....	2079
<u>File usage</u> .....	2079
<u>Namespaces</u> .....	2080
<u>Variants</u> .....	2080
<u>Views</u> .....	2080
<u>More</u> .....	2080
<b><u>File:WorldMapWithLightTerminator.gif</u></b> .....	<b>2081</b>
<u>File history</u> .....	2081
<u>File usage</u> .....	2081
<u>Namespaces</u> .....	2082
<u>Variants</u> .....	2082
<u>Views</u> .....	2082
<u>More</u> .....	2082
<b><u>File:WorldMapWithRBNSpots2.gif</u></b> .....	<b>2083</b>
<u>File history</u> .....	2083
<u>File usage</u> .....	2083
<u>Metadata</u> .....	2084
<u>Namespaces</u> .....	2084
<u>Variants</u> .....	2084
<u>Views</u> .....	2084
<u>More</u> .....	2084
<b><u>File:WorldMapWithRBNSpots2.gif</u></b> .....	<b>2085</b>
<u>File history</u> .....	2085
<u>File usage</u> .....	2085
<u>Metadata</u> .....	2086
<u>Namespaces</u> .....	2086
<u>Variants</u> .....	2086
<u>Views</u> .....	2086
<u>More</u> .....	2086
<b><u>File:WorldMapWithRBNSpotsContextMenu.gif</u></b> .....	<b>2087</b>
<u>File history</u> .....	2088
<u>File usage</u> .....	2088
<u>Metadata</u> .....	2088
<u>Namespaces</u> .....	2088
<u>Variants</u> .....	2088
<u>Views</u> .....	2088
<u>More</u> .....	2088
<b><u>File:WorldMapWithRBNSpotsContextMenu.gif</u></b> .....	<b>2090</b>
<u>File history</u> .....	2091
<u>File usage</u> .....	2091
<u>Metadata</u> .....	2091
<u>Namespaces</u> .....	2091

# Table of Contents

<b><u>File:WorldMapWithRBNSpotsContextMenu.gif</u></b>	
<u>Variants</u> .....	2091
<u>Views</u> .....	2091
<u>More</u> .....	2091
<b><u>File:WtDxTelnetNetworkPropertiesMultiOp.gif</u></b> .....	<b>2093</b>
<u>File history</u> .....	2093
<u>File usage</u> .....	2093
<u>Namespaces</u> .....	2093
<u>Variants</u> .....	2094
<u>Views</u> .....	2094
<u>More</u> .....	2094
<b><u>File:WtDxTelnetNetworkPropertiesMultiOp.gif</u></b> .....	<b>2095</b>
<u>File history</u> .....	2095
<u>File usage</u> .....	2095
<u>Namespaces</u> .....	2095
<u>Variants</u> .....	2096
<u>Views</u> .....	2096
<u>More</u> .....	2096
<b><u>File:Wtdxtelnet singleop.gif</u></b> .....	<b>2097</b>
<u>File history</u> .....	2097
<u>File usage</u> .....	2097
<u>Namespaces</u> .....	2097
<u>Variants</u> .....	2098
<u>Views</u> .....	2098
<u>More</u> .....	2098
<b><u>File:Wtdxtelnet singleop dxcp.gif</u></b> .....	<b>2099</b>
<u>File history</u> .....	2100
<u>File usage</u> .....	2100
<u>Namespaces</u> .....	2100
<u>Variants</u> .....	2100
<u>Views</u> .....	2100
<u>More</u> .....	2100
<b><u>File:Wtdxtelnet singleop dxcp.gif</u></b> .....	<b>2102</b>
<u>File history</u> .....	2103
<u>File usage</u> .....	2103
<u>Namespaces</u> .....	2103
<u>Variants</u> .....	2103
<u>Views</u> .....	2103
<u>More</u> .....	2103
<b><u>File:Wtdxtelnet singleop.gif</u></b> .....	<b>2105</b>
<u>File history</u> .....	2105
<u>File usage</u> .....	2105

# Table of Contents

<b><u>File:Wtdxtelnet singleop.gif</u></b>	
<u>Namespaces</u> .....	2105
<u>Variants</u> .....	2106
<u>Views</u> .....	2106
<u>More</u> .....	2106
<b><u>File:WTGoogleSearch.gif</u></b> .....	<b>2107</b>
<u>File history</u> .....	2107
<u>File usage</u> .....	2107
<u>Metadata</u> .....	2108
<u>Namespaces</u> .....	2108
<u>Variants</u> .....	2108
<u>Views</u> .....	2108
<u>More</u> .....	2108
<b><u>File:WTGoogleSearch.gif</u></b> .....	<b>2109</b>
<u>File history</u> .....	2109
<u>File usage</u> .....	2109
<u>Metadata</u> .....	2110
<u>Namespaces</u> .....	2110
<u>Variants</u> .....	2110
<u>Views</u> .....	2110
<u>More</u> .....	2110
<b><u>File:WtRotatorsAddRotator.gif</u></b> .....	<b>2111</b>
<u>File history</u> .....	2111
<u>File usage</u> .....	2111
<u>Namespaces</u> .....	2112
<u>Variants</u> .....	2112
<u>Views</u> .....	2112
<u>More</u> .....	2112
<b><u>File:WtRotatorsAddRotator.gif</u></b> .....	<b>2113</b>
<u>File history</u> .....	2113
<u>File usage</u> .....	2113
<u>Namespaces</u> .....	2114
<u>Variants</u> .....	2114
<u>Views</u> .....	2114
<u>More</u> .....	2114
<b><u>File:WtRotatorsControllersAdd.gif</u></b> .....	<b>2115</b>
<u>File history</u> .....	2115
<u>File usage</u> .....	2115
<u>Namespaces</u> .....	2115
<u>Variants</u> .....	2115
<u>Views</u> .....	2116
<u>More</u> .....	2116

# Table of Contents

<b><u>File:WtRotatorsControllersAdd.gif</u></b> .....	<b>2117</b>
<u>File history</u> .....	2117
<u>File usage</u> .....	2117
<u>Namespaces</u> .....	2117
<u>Variants</u> .....	2117
<u>Views</u> .....	2118
<u>More</u> .....	2118
<b><u>File:WtRotatorsControllerWindow.gif</u></b> .....	<b>2119</b>
<u>File history</u> .....	2120
<u>File usage</u> .....	2120
<u>Metadata</u> .....	2120
<u>Namespaces</u> .....	2121
<u>Variants</u> .....	2121
<u>Views</u> .....	2121
<u>More</u> .....	2121
<b><u>File:WtRotatorsControllerWindow.gif</u></b> .....	<b>2122</b>
<u>File history</u> .....	2123
<u>File usage</u> .....	2123
<u>Metadata</u> .....	2123
<u>Namespaces</u> .....	2124
<u>Variants</u> .....	2124
<u>Views</u> .....	2124
<u>More</u> .....	2124
<b><u>File:WtRotatorsHeadingRange.gif</u></b> .....	<b>2125</b>
<u>File history</u> .....	2125
<u>File usage</u> .....	2125
<u>Namespaces</u> .....	2125
<u>Variants</u> .....	2126
<u>Views</u> .....	2126
<u>More</u> .....	2126
<b><u>File:WtRotatorsHeadingRange.gif</u></b> .....	<b>2127</b>
<u>File history</u> .....	2127
<u>File usage</u> .....	2127
<u>Namespaces</u> .....	2127
<u>Variants</u> .....	2128
<u>Views</u> .....	2128
<u>More</u> .....	2128
<b><u>File:WtRotatorsNetworkPropertiesMultiOp.gif</u></b> .....	<b>2129</b>
<u>File history</u> .....	2129
<u>File usage</u> .....	2129
<u>Namespaces</u> .....	2129
<u>Variants</u> .....	2130
<u>Views</u> .....	2130

# Table of Contents

<b><u>File:WtRotatorsNetworkPropertiesMultiOp.gif</u></b>	
<u>More</u> .....	2130
<b><u>File:WtRotatorsNetworkPropertiesMultiOp.gif</u></b> .....	<b>2131</b>
<u>File history</u> .....	2131
<u>File usage</u> .....	2131
<u>Namespaces</u> .....	2131
<u>Variants</u> .....	2132
<u>Views</u> .....	2132
<u>More</u> .....	2132
<b><u>File:WtRotatorsNetworkPropertiesSingleOp.PNG</u></b> .....	<b>2133</b>
<u>File history</u> .....	2133
<u>File usage</u> .....	2133
<u>Namespaces</u> .....	2133
<u>Variants</u> .....	2134
<u>Views</u> .....	2134
<u>More</u> .....	2134
<b><u>File:WtRotatorsNetworkPropertiesSingleOp.PNG</u></b> .....	<b>2135</b>
<u>File history</u> .....	2135
<u>File usage</u> .....	2135
<u>Namespaces</u> .....	2135
<u>Variants</u> .....	2136
<u>Views</u> .....	2136
<u>More</u> .....	2136
<b><u>File:WtRotatorsOffset.PNG</u></b> .....	<b>2137</b>
<u>File history</u> .....	2137
<u>File usage</u> .....	2137
<u>Namespaces</u> .....	2137
<u>Variants</u> .....	2137
<u>Views</u> .....	2138
<u>More</u> .....	2138
<b><u>File:WtRotatorsOffset.PNG</u></b> .....	<b>2139</b>
<u>File history</u> .....	2139
<u>File usage</u> .....	2139
<u>Namespaces</u> .....	2139
<u>Variants</u> .....	2139
<u>Views</u> .....	2140
<u>More</u> .....	2140
<b><u>File:WtRotatorsOptions.gif</u></b> .....	<b>2141</b>
<u>File history</u> .....	2141
<u>File usage</u> .....	2141
<u>Namespaces</u> .....	2141
<u>Variants</u> .....	2141

# Table of Contents

<b><u>File:WtRotatorsOptions.gif</u></b>	
<u>Views</u> .....	2141
<u>More</u> .....	2142
<b><u>File:WtRotatorsOptions.gif</u></b> .....	<b>2143</b>
<u>File history</u> .....	2143
<u>File usage</u> .....	2143
<u>Namespaces</u> .....	2143
<u>Variants</u> .....	2143
<u>Views</u> .....	2143
<u>More</u> .....	2144
<b><u>File:WtRotatorsRotationLimits.gif</u></b> .....	<b>2145</b>
<u>File history</u> .....	2145
<u>File usage</u> .....	2145
<u>Namespaces</u> .....	2145
<u>Variants</u> .....	2146
<u>Views</u> .....	2146
<u>More</u> .....	2146
<b><u>File:WtRotatorsRotationLimits.gif</u></b> .....	<b>2147</b>
<u>File history</u> .....	2147
<u>File usage</u> .....	2147
<u>Namespaces</u> .....	2147
<u>Variants</u> .....	2148
<u>Views</u> .....	2148
<u>More</u> .....	2148
<b><u>File:WtRotatorsStatusMessages.gif</u></b> .....	<b>2149</b>
<u>File history</u> .....	2149
<u>File usage</u> .....	2149
<u>Namespaces</u> .....	2149
<u>Variants</u> .....	2149
<u>Views</u> .....	2150
<u>More</u> .....	2150
<b><u>File:WtRotatorsStatusMessages.gif</u></b> .....	<b>2151</b>
<u>File history</u> .....	2151
<u>File usage</u> .....	2151
<u>Namespaces</u> .....	2151
<u>Variants</u> .....	2151
<u>Views</u> .....	2152
<u>More</u> .....	2152
<b><u>File:WtRotatorsWindowsSecurityAlert.gif</u></b> .....	<b>2153</b>
<u>File history</u> .....	2153
<u>File usage</u> .....	2153
<u>Namespaces</u> .....	2154



# Table of Contents

<b><u>File:WtRotatorsWindowsSecurityAlert.gif</u></b>	
<u>Variants</u> .....	2154
<u>Views</u> .....	2154
<u>More</u> .....	2154
<b><u>File:WtRotatorsWindowsSecurityAlert.gif</u></b> .....	<b>2155</b>
<u>File history</u> .....	2155
<u>File usage</u> .....	2155
<u>Namespaces</u> .....	2156
<u>Variants</u> .....	2156
<u>Views</u> .....	2156
<u>More</u> .....	2156
<b><u>Multi-op/Gabbing</u></b> .....	<b>2157</b>
<u>Sending a message to another station</u> .....	2157
<u>Receiving gab messages</u> .....	2157
<u>See also</u> .....	2157
<u>Namespaces</u> .....	2157
<u>Variants</u> .....	2157
<u>Views</u> .....	2157
<u>More</u> .....	2158
<b><u>HamCAP</u></b> .....	<b>2159</b>
<u>Contents</u> .....	2159
<u>Introduction</u> .....	2159
<u>Set preferences</u> .....	2159
<u>Set Parameters</u> .....	2160
<u>Set TX and RX antennas</u> .....	2161
<u>See Also</u> .....	2162
<u>In the manual</u> .....	2162
<u>External sources</u> .....	2162
<u>Namespaces</u> .....	2162
<u>Variants</u> .....	2163
<u>Views</u> .....	2163
<u>More</u> .....	2163
<b><u>HamCAP</u></b> .....	<b>2164</b>
<u>Contents</u> .....	2164
<u>Introduction</u> .....	2164
<u>Set preferences</u> .....	2164
<u>Set Parameters</u> .....	2165
<u>Set TX and RX antennas</u> .....	2166
<u>See Also</u> .....	2167
<u>In the manual</u> .....	2167
<u>External sources</u> .....	2167
<u>Namespaces</u> .....	2167
<u>Variants</u> .....	2168
<u>Views</u> .....	2168

# Table of Contents

<b><u>HamCAP</u></b>	
<u>More</u> .....	2168
<b><u>Icon bar</u></b> .....	<b>2169</b>
<u>Namespaces</u> .....	2170
<u>Variants</u> .....	2170
<u>Views</u> .....	2170
<u>More</u> .....	2170
<b><u>Icon bar</u></b> .....	<b>2171</b>
<u>Namespaces</u> .....	2172
<u>Variants</u> .....	2172
<u>Views</u> .....	2172
<u>More</u> .....	2172
<b><u>Installation</u></b> .....	<b>2173</b>
<u>Download the software</u> .....	2173
<u>Install the software</u> .....	2173
<u>Registering the software</u> .....	2173
<u>Namespaces</u> .....	2174
<u>Variants</u> .....	2174
<u>Views</u> .....	2174
<u>More</u> .....	2174
<b><u>Interfaces</u></b> .....	<b>2175</b>
<u>Contents</u> .....	2175
<u>Interface configuration</u> .....	2175
<u>Radio configuration</u> .....	2175
<u>Configuring other interfaces</u> .....	2177
<u>COM-port CW keying</u> .....	2177
<u>LPT-port CW keying</u> .....	2178
<u>Digital Voice Keyer</u> .....	2180
<u>Sound Card</u> .....	2181
<u>Band Data</u> .....	2183
<u>Radio 1/Radio 2</u> .....	2185
<u>Headphones Control</u> .....	2185
<u>See Also</u> .....	2185
<u>From the Win-Test manual</u> .....	2185
<u>External sources</u> .....	2185
<u>Namespaces</u> .....	2185
<u>Variants</u> .....	2185
<u>Views</u> .....	2185
<u>More</u> .....	2185
<b><u>Interfaces</u></b> .....	<b>2186</b>
<u>Contents</u> .....	2186
<u>Interface configuration</u> .....	2186
<u>Radio configuration</u> .....	2186

# Table of Contents

## **Interfaces**

<u>Configuring other interfaces</u> .....	2188
<u>COM-port CW keying</u> .....	2188
<u>LPT-port CW keying</u> .....	2189
<u>Digital Voice Keyer</u> .....	2191
<u>Sound Card</u> .....	2192
<u>Band Data</u> .....	2194
<u>Radio 1/Radio 2</u> .....	2196
<u>Headphones Control</u> .....	2196
<u>See Also</u> .....	2196
<u>From the Win-Test manual</u> .....	2196
<u>External sources</u> .....	2196
<u>Namespaces</u> .....	2196
<u>Variants</u> .....	2196
<u>Views</u> .....	2196
<u>More</u> .....	2196

## **Keys.....2197**

<u>Contents</u> .....	2197
<u>Editing and moving around the QSO entry line</u> .....	2197
<u>Movement in the log</u> .....	2198
<u>Message keys</u> .....	2198
<u>Open and Close Windows</u> .....	2199
<u>Radio Control</u> .....	2199
<u>Packet</u> .....	2200
<u>Band Map</u> .....	2200
<u>DX-Cluster Announcements</u> .....	2200
<u>Networking</u> .....	2200
<u>Multi Operator</u> .....	2200
<u>SO2R</u> .....	2201
<u>Partner Mode</u> .....	2201
<u>Contest Recorder</u> .....	2201
<u>Special Keys</u> .....	2201
<u>Namespaces</u> .....	2201
<u>Variants</u> .....	2202
<u>Views</u> .....	2202
<u>More</u> .....	2202

## **Keys.....2203**

<u>Contents</u> .....	2203
<u>Editing and moving around the QSO entry line</u> .....	2203
<u>Movement in the log</u> .....	2204
<u>Message keys</u> .....	2204
<u>Open and Close Windows</u> .....	2205
<u>Radio Control</u> .....	2205
<u>Packet</u> .....	2206
<u>Band Map</u> .....	2206
<u>DX-Cluster Announcements</u> .....	2206

# Table of Contents

## **Keys**

<u>Networking</u> .....	2206
<u>Multi Operator</u> .....	2206
<u>SO2R</u> .....	2207
<u>Partner Mode</u> .....	2207
<u>Contest Recorder</u> .....	2207
<u>Special Keys</u> .....	2207
<u>Namespaces</u> .....	2207
<u>Variants</u> .....	2208
<u>Views</u> .....	2208
<u>More</u> .....	2208

## **Menu:Tools.....2209**

<u>Contents</u> .....	2209
<u>Automatic CQ repeat</u> .....	2209
<u>Intelligent Quick QSL</u> .....	2210
<u>Redefine keyboard keys</u> .....	2212
<u>Remapping [*] and [+] when using Notebook or Mini keyboard</u> .....	2213
<u>Data entry</u> .....	2214
<u>Exchange guessing</u> .....	2214
<u>Callsign check</u> .....	2215
<u>Priority</u> .....	2215
<u>Enable ESM</u> .....	2215
<u>Disable CW cut numbers translation</u> .....	2216
<u>Remap Slash to /P</u> .....	2216
<u>Enable Run/S&amp;P switching</u> .....	2216
<u>Switch keyboard</u> .....	2217
<u>Countdown timer</u> .....	2217
<u>Scripts Manager</u> .....	2218
<u>Introduction</u> .....	2219
<u># Notation</u> .....	2219
<u>Calling Scripts via Text Command</u> .....	2220
<u>Automatically Executed Scripts</u> .....	2220
<u>Synchronous vs. asynchronous - the #@ Notation</u> .....	2220
<u>Tips for Programming</u> .....	2221
<u>Basic Examples</u> .....	2221
<u>Load a target file</u> .....	2222
<u>Export a target file</u> .....	2222
<u>Check log</u> .....	2224
<u>Time shifting</u> .....	2227
<u>Correcting OP over a QSO range</u> .....	2228
<u>Download Files through the Network</u> .....	2229
<u>Namespaces</u> .....	2229
<u>Variants</u> .....	2229
<u>Views</u> .....	2229
<u>More</u> .....	2229

# Table of Contents

<b><u>Menu:Tools</u></b> .....	<b>2230</b>
<u>Contents</u> .....	2230
<u>Automatic CQ repeat</u> .....	2230
<u>Intelligent Quick QSL</u> .....	2231
<u>Redefine keyboard keys</u> .....	2233
<u>Remapping [*] and [+] when using Notebook or Mini keyboard</u> .....	2234
<u>Data entry</u> .....	2235
<u>Exchange guessing</u> .....	2235
<u>Callsign check</u> .....	2236
<u>Priority</u> .....	2236
<u>Enable ESM</u> .....	2236
<u>Disable CW cut numbers translation</u> .....	2237
<u>Remap Slash to /P</u> .....	2237
<u>Enable Run/S&amp;P switching</u> .....	2237
<u>Switch keyboard</u> .....	2238
<u>Countdown timer</u> .....	2238
<u>Scripts Manager</u> .....	2239
<u>Introduction</u> .....	2240
<u># Notation</u> .....	2240
<u>Calling Scripts via Text Command</u> .....	2241
<u>Automatically Executed Scripts</u> .....	2241
<u>Synchronous vs. asynchronous - the #@ Notation</u> .....	2241
<u>Tips for Programming</u> .....	2242
<u>Basic Examples</u> .....	2242
<u>Load a target file</u> .....	2243
<u>Export a target file</u> .....	2243
<u>Check log</u> .....	2245
<u>Time shifting</u> .....	2248
<u>Correcting OP over a QSO range</u> .....	2249
<u>Download Files through the Network</u> .....	2250
<u>Namespaces</u> .....	2250
<u>Variants</u> .....	2250
<u>Views</u> .....	2250
<u>More</u> .....	2250
<b><u>Mailing</u></b> .....	<b>2251</b>
<u>Namespaces</u> .....	2251
<u>Variants</u> .....	2251
<u>Views</u> .....	2251
<u>More</u> .....	2251
<b><u>Mailing</u></b> .....	<b>2252</b>
<u>Namespaces</u> .....	2252
<u>Variants</u> .....	2252
<u>Views</u> .....	2252
<u>More</u> .....	2252

# Table of Contents

<b><u>Mailing List</u></b> .....	<b>2253</b>
<u>Contents</u> .....	2253
<u>Knowledge needs to be shared</u> .....	2253
<u>Subscribing to the mailing list</u> .....	2253
<u>Unsubscribing to the mailing list</u> .....	2253
<u>Searching and browsing the archive</u> .....	2253
<u>Namespaces</u> .....	2254
<u>Variants</u> .....	2254
<u>Views</u> .....	2254
<u>More</u> .....	2254
<b><u>Main Page</u></b> .....	<b>2255</b>
<u>Namespaces</u> .....	2256
<u>Variants</u> .....	2256
<u>Views</u> .....	2256
<u>More</u> .....	2256
<b><u>Menu:Commands</u></b> .....	<b>2257</b>
<u>Contents</u> .....	2257
<u>OSY</u> .....	2257
<u>One band down</u> .....	2257
<u>One band up</u> .....	2258
<u>Keyboard mode</u> .....	2258
<u>CW Speed</u> .....	2258
<u>CW Weight</u> .....	2259
<u>Carrier</u> .....	2259
<u>Split frequency</u> .....	2259
<u>OSY frequency</u> .....	2260
<u>OSY back to run frequency</u> .....	2260
<u>Swap the frequency on both radios</u> .....	2260
<u>Take a sked</u> .....	2261
<u>Pass a station</u> .....	2261
<u>Operator Login</u> .....	2262
<u>Copy-paste the previous OSQ</u> .....	2263
<u>Receive QTC</u> .....	2263
<u>Transmit QTC</u> .....	2264
<u>Turn Antenna to Logged Call (Short Path)</u> .....	2265
<u>Turn Antenna to Logged Call (Long Path)</u> .....	2265
<u>DX-Cluster</u> .....	2265
<u>Spot</u> .....	2266
<u>Propagation forecast</u> .....	2266
<u>Insert into BandMap</u> .....	2268
<u>Active Radio</u> .....	2268
<u>Station Type</u> .....	2268
<u>CW/RTTY Messages</u> .....	2269
<u>Remote commands</u> .....	2270
<u>Namespaces</u> .....	2270
<u>Variants</u> .....	2270

# Table of Contents

## **Menu:Commands**

<u>Views</u> .....	2270
<u>More</u> .....	2271

## **Menu>Edit.....2272**

<u>Contents</u> .....	2272
<u>Restore QSO</u> .....	2272
<u>Initialize QSO</u> .....	2272
<u>Edit Date, Time, Freq. and Op. of QSO</u> .....	2272
<u>Edit serial number</u> .....	2273
<u>Delete QSO</u> .....	2273
<u>Delete all QSO</u> .....	2274
<u>Goto QSO</u> .....	2274
<u>Goto Callsign</u> .....	2275
<u>Apply exchange to every QSO with</u> .....	2275
<u>Move in my log only</u> .....	2275
<u>Namespaces</u> .....	2276
<u>Variants</u> .....	2276
<u>Views</u> .....	2276
<u>More</u> .....	2276

## **Menu:File new.....2277**

<u>Contents</u> .....	2277
<u>New</u> .....	2277
<u>Contest Configuration</u> .....	2280
<u>Station Parameters</u> .....	2281
<u>Contest Parameters</u> .....	2281
<u>Network Parameters</u> .....	2282
<u>Open</u> .....	2282
<u>Corrupted Files</u> .....	2284
<u>Import</u> .....	2284
<u>Export</u> .....	2285
<u>Merge Logs</u> .....	2285
<u>Clean log</u> .....	2287
<u>Cleaning</u> .....	2287
<u>Time Shift</u> .....	2288
<u>Resolving 10-Minute-Rule Violations</u> .....	2288
<u>Quit</u> .....	2288
<u>Namespaces</u> .....	2288
<u>Variants</u> .....	2288
<u>Views</u> .....	2288
<u>More</u> .....	2289

## **Menu:File open.....2290**

<u>Contents</u> .....	2290
<u>New</u> .....	2290
<u>Open</u> .....	2290
<u>Close</u> .....	2290

# Table of Contents

<b><u>Menu:File open</u></b>	
<u>Create Log Files</u>	2290
<u>Backup contest</u>	2291
<u>Archive</u>	2291
<u>Update database</u>	2291
<u>Explore</u>	2292
<u>Most Recently Used</u>	2292
<u>Quit</u>	2292
<u>Namespaces</u>	2293
<u>Variants</u>	2293
<u>Views</u>	2293
<u>More</u>	2293
<b><u>Menu:Help</u></b>	<b>2294</b>
<u>Contents</u>	2294
<u>Register software</u>	2294
<u>Use online documentation</u>	2294
<u>Reference manual</u>	2295
<u>Display text command tips for menu items</u>	2295
<u>Win-Test Home Page</u>	2295
<u>Documentation Wiki Home Page</u>	2295
<u>About</u>	2295
<u>Namespaces</u>	2296
<u>Variants</u>	2296
<u>Views</u>	2296
<u>More</u>	2296
<b><u>Menu:Messages</u></b>	<b>2297</b>
<u>Contents</u>	2297
<u>Send a Gab</u>	2297
<u>Reply to the last private gab</u>	2298
<u>Write a note regarding this QSQ</u>	2298
<u>Namespaces</u>	2298
<u>Variants</u>	2298
<u>Views</u>	2298
<u>More</u>	2298
<b><u>Menu:Operating</u></b>	<b>2299</b>
<u>Contents</u>	2299
<u>Listen to the primary radio</u>	2299
<u>Listen to the secondary radio/headphone toggle</u>	2299
<u>Listen to the secondary radio during transmit/headphone latch</u>	2299
<u>Listen both radio/headphone split</u>	2299
<u>Revert to automatic control</u>	2300
<u>Technique</u>	2300
<u>Modify the scenarios</u>	2300
<u>Shift binds to the secondary radio</u>	2301
<u>Caps Lock binds to the secondary radio</u>	2301



# Table of Contents

## **Menu:Operating**

<u>The second footswitch binds to the secondary radio</u> .....	2301
<u>Namespaces</u> .....	2301
<u>Variants</u> .....	2301
<u>Views</u> .....	2301
<u>More</u> .....	2301

## **Menu:Options.....2303**

<u>Contents</u> .....	2303
<u>Load contest at startup</u> .....	2304
<u>Automatic backup</u> .....	2305
<u>Disable log synchronization on network</u> .....	2306
<u>CW</u> .....	2306
<u>No sound</u> .....	2308
<u>Initial Speed</u> .....	2308
<u>Modify standard messages</u> .....	2308
<u>Modify additional messages</u> .....	2310
<u>Modify WAE messages</u> .....	2311
<u>Custom variables</u> .....	2312
<u>Serial number</u> .....	2313
<u>Correction</u> .....	2314
<u>Shortened spaces (CT spaces)</u> .....	2314
<u>Auto sending</u> .....	2314
<u>Remap keys in keyboard mode</u> .....	2315
<u>Work dupes</u> .....	2315
<u>Speed bursts</u> .....	2315
<u>RTTY</u> .....	2315
<u>Modify standard messages</u> .....	2316
<u>Modify additional messages</u> .....	2317
<u>Modify WAE messages</u> .....	2318
<u>Custom variables</u> .....	2319
<u>Configure interfaces</u> .....	2319
<u>Serial Ports</u> .....	2321
<u>Transceivers</u> .....	2322
<u>Printer Ports</u> .....	2322
<u>CW</u> .....	2323
<u>Local Network</u> .....	2323
<u>Network Protocol Advanced Settings</u> .....	2323
<u>Voice Keyer</u> .....	2325
<u>WinKey configuration</u> .....	2325
<u>EZMaster configuration</u> .....	2326
<u>CW Keyer</u> .....	2327
<u>Radio set-up</u> .....	2327
<u>Packet-Radio TNC</u> .....	2327
<u>Antenna configuration according to RX/TX</u> .....	2327
<u>MK/MKII/MK2R/u2R configuration</u> .....	2329
<u>OTRSP configuration</u> .....	2330
<u>RTTY configuration</u> .....	2331

# Table of Contents

## **Menu:Options**

<u>Frequency Offsets</u> .....	2332
<u>MP3 Configuration</u> .....	2333
<u>Script Editor Configuration</u> .....	2334
<u>Log</u> .....	2335
<u>Fonts</u> .....	2337
<u>Headers</u> .....	2337
<u>Hide QSO numbers</u> .....	2337
<u>Align Exchanges</u> .....	2337
<u>Stay in field when moving up and down in the log</u> .....	2337
<u>Block Cursor</u> .....	2337
<u>Colors</u> .....	2337
<u>New Contest Files Properties</u> .....	2337
<u>DXpedition Info Field</u> .....	2338
<u>Spot Warnings</u> .....	2339
<u>DX Cluster</u> .....	2339
<u>DX Cluster window shortcuts</u> .....	2339
<u>Start/stop wtDxTelnet automatically</u> .....	2339
<u>HamCAP</u> .....	2340
<u>WAEDC</u> .....	2343
<u>Data files</u> .....	2344
<u>Country files</u> .....	2345
<u>Master file</u> .....	2345
<u>Exchanges Database</u> .....	2346
<u>Default extra data files</u> .....	2346
<u>Markers files</u> .....	2347
<u>Segments files</u> .....	2347
<u>Bandplans</u> .....	2348
<u>Windows</u> .....	2349
<u>Toolbar</u> .....	2350
<u>Language</u> .....	2350
<u>Namespaces</u> .....	2351
<u>Variants</u> .....	2351
<u>Views</u> .....	2351
<u>More</u> .....	2351

## **Menus**.....2352

<u>Contents</u> .....	2352
<u>File</u> .....	2352
<u>Edit</u> .....	2352
<u>Operating</u> .....	2353
<u>Commands</u> .....	2353
<u>Messages</u> .....	2353
<u>Tools</u> .....	2354
<u>Windows</u> .....	2354
<u>Options</u> .....	2354
<u>Help</u> .....	2355
<u>Namespaces</u> .....	2355

# Table of Contents

## Menus

<u>Variants</u> .....	2355
<u>Views</u> .....	2355
<u>More</u> .....	2355

## **Menu:Tools.....2356**

<u>Contents</u> .....	2356
<u>Automatic CO repeat</u> .....	2356
<u>Intelligent Quick OSL</u> .....	2357
<u>Redefine keyboard keys</u> .....	2359
<u>Remapping [*] and [+] when using Notebook or Mini keyboard</u> .....	2360
<u>Data entry</u> .....	2361
<u>Exchange guessing</u> .....	2361
<u>Callsign check</u> .....	2362
<u>Priority</u> .....	2362
<u>Enable ESM</u> .....	2362
<u>Disable CW cut numbers translation</u> .....	2363
<u>Remap Slash to /P</u> .....	2363
<u>Enable Run/S&amp;P switching</u> .....	2363
<u>Switch keyboard</u> .....	2364
<u>Countdown timer</u> .....	2364
<u>Scripts Manager</u> .....	2365
<u>Introduction</u> .....	2366
<u># Notation</u> .....	2366
<u>Calling Scripts via Text Command</u> .....	2367
<u>Automatically Executed Scripts</u> .....	2367
<u>Synchronous vs. asynchronous - the #@ Notation</u> .....	2367
<u>Tips for Programming</u> .....	2368
<u>Basic Examples</u> .....	2368
<u>Load a target file</u> .....	2369
<u>Export a target file</u> .....	2369
<u>Check log</u> .....	2371
<u>Time shifting</u> .....	2374
<u>Correcting OP over a QSO range</u> .....	2375
<u>Download Files through the Network</u> .....	2376
<u>Namespaces</u> .....	2376
<u>Variants</u> .....	2376
<u>Views</u> .....	2376
<u>More</u> .....	2376

## **Menu:Windows.....2377**

<u>Contents</u> .....	2377
<u>Log Entry (Main window)</u> .....	2378
<u>Worked Gridsquares</u> .....	2380
<u>Worked Zones</u> .....	2383
<u>Worked DXCC</u> .....	2384
<u>Check Callsign</u> .....	2385
<u>Check Multipliers</u> .....	2385

# Table of Contents

## **Menu:Windows**

<u>Search for Worked Multipliers or Partial QTH Locators</u> .....	2386
<u>Check Partial</u> s.....	2388
<u>Check N + 1</u> .....	2390
<u>Partner</u> .....	2391
<u>Status</u> .....	2394
<u>Skeds</u> .....	2396
<u>Solar Activity</u> .....	2397
<u>QSY Wizard</u> .....	2398
<u>Extra Information</u> .....	2399
<u>XDT Files</u> .....	2399
<u>Directives</u> .....	2400
<u>Summary</u> .....	2401
<u>Live Score</u> .....	2401
<u>Rate</u> .....	2402
<u>Graphs</u> .....	2403
<u>Text Information</u> .....	2403
<u>Context Menu</u> .....	2404
<u>Statistics</u> .....	2404
<u>Gab</u> .....	2408
<u>World Map</u> .....	2409
<u>Radio 1, Radio 2 (Band Maps)</u> .....	2412
<u>Band Maps Context menu</u> .....	2414
<u>Secondary Radio</u> .....	2423
<u>RTTY (radio1, radio2)</u> .....	2423
<u>Rotators</u> .....	2424
<u>DX-Cluster Monitor</u> .....	2425
<u>DX-Cluster Announcements</u> .....	2426
<u>NCDXF/IBP Beacons</u> .....	2429
<u>Clock</u> .....	2429
<u>Contest Recorder</u> .....	2430
<u>SSB bargraph</u> .....	2431
<u>Close all Windows</u> .....	2432
<u>Namespaces</u> .....	2432
<u>Variants</u> .....	2432
<u>Views</u> .....	2432
<u>More</u> .....	2432

<b><u>Message variables</u></b> .....	<b>2433</b>
<u>Contents</u> .....	2433
<u>CW / RTTY automation</u> .....	2433
<u>RTTY only</u> .....	2434
<u>Action</u> .....	2434
<u>SO2R</u> .....	2435
<u>WAEDC QTC related</u> .....	2435
<u>Custom variables</u> .....	2435
<u>Namespaces</u> .....	2436
<u>Variants</u> .....	2436

# Table of Contents

## **Message variables**

<u>Views</u> .....	2436
<u>More</u> .....	2436

## **Message variables.....2437**

<u>Contents</u> .....	2437
<u>CW / RTTY automation</u> .....	2437
<u>RTTY only</u> .....	2438
<u>Action</u> .....	2438
<u>SO2R</u> .....	2439
<u>WAEDC QTC related</u> .....	2439
<u>Custom variables</u> .....	2439
<u>Namespaces</u> .....	2440
<u>Variants</u> .....	2440
<u>Views</u> .....	2440
<u>More</u> .....	2440

## **SO2R/MK2R.....2441**

<u>Contents</u> .....	2441
<u>Setting up the MK2R for use with Win-Test</u> .....	2441
<u>Setting up the technique</u> .....	2441
<u>Setting up the [Shift] key for secondary radio</u> .....	2441
<u>Setting up the [Caps Lock] key for secondary radio</u> .....	2441
<u>Setting the SO2R Control box</u> .....	2442
<u>See also</u> .....	2458
<u>External sources</u> .....	2458
<u>Namespaces</u> .....	2458
<u>Variants</u> .....	2458
<u>Views</u> .....	2458
<u>More</u> .....	2458

## **SO2R/MK2R.....2459**

<u>Contents</u> .....	2459
<u>Setting up the MK2R for use with Win-Test</u> .....	2459
<u>Setting up the technique</u> .....	2459
<u>Setting up the [Shift] key for secondary radio</u> .....	2459
<u>Setting up the [Caps Lock] key for secondary radio</u> .....	2459
<u>Setting the SO2R Control box</u> .....	2460
<u>See also</u> .....	2476
<u>External sources</u> .....	2476
<u>Namespaces</u> .....	2476
<u>Variants</u> .....	2476
<u>Views</u> .....	2476
<u>More</u> .....	2476

## **Networking.....2477**

<u>Contents</u> .....	2477
<u>Step 1: Configuring your Windows network</u> .....	2477

# Table of Contents

<b><u>Networking</u></b>	
<u>Step 2: Configuring Win-Test for multi-op networking</u>	2478
<u>Settings for Win-Test networking on different IP ranges</u>	2479
<u>Step 3: Testing the network</u>	2480
<u>Log Synchronization</u>	2480
<u>Large Networks</u>	2480
<u>WT Tunnel</u>	2481
<u>Traffic Shaping</u>	2481
<u>The Bridgehead Concept</u>	2481
<u>Starting at 0 QSOs</u>	2481
<u>See Also</u>	2481
<u>In the manual</u>	2481
<u>External sources</u>	2482
<u>Namespaces</u>	2482
<u>Variants</u>	2482
<u>Views</u>	2482
<u>More</u>	2482
<b><u>Networking</u></b>	<b>2483</b>
<u>Contents</u>	2483
<u>Step 1: Configuring your Windows network</u>	2483
<u>Step 2: Configuring Win-Test for multi-op networking</u>	2484
<u>Settings for Win-Test networking on different IP ranges</u>	2485
<u>Step 3: Testing the network</u>	2486
<u>Log Synchronization</u>	2486
<u>Large Networks</u>	2486
<u>WT Tunnel</u>	2487
<u>Traffic Shaping</u>	2487
<u>The Bridgehead Concept</u>	2487
<u>Starting at 0 QSOs</u>	2487
<u>See Also</u>	2487
<u>In the manual</u>	2487
<u>External sources</u>	2488
<u>Namespaces</u>	2488
<u>Variants</u>	2488
<u>Views</u>	2488
<u>More</u>	2488
<b><u>New Log</u></b>	<b>2489</b>
<u>Contents</u>	2489
<u>Step 1: Setup your log</u>	2489
<u>Editing the contest configuration</u>	2491
<u>Step 2: Choosing a file name for your log</u>	2492
<u>Opening your log automatically upon opening Win-Test</u>	2492
<u>See Also</u>	2492
<u>Namespaces</u>	2493
<u>Variants</u>	2493
<u>Views</u>	2493

# Table of Contents

<b><u>New Log</u></b>	
<u>More</u> .....	2493
<b><u>New Log</u></b> .....	<b>2494</b>
<u>Contents</u> .....	2494
<u>Step 1: Setup your log</u> .....	2494
<u>Editing the contest configuration</u> .....	2496
<u>Step 2: Choosing a file name for your log</u> .....	2497
<u>Opening your log automatically upon opening Win-Test</u> .....	2497
<u>See Also</u> .....	2497
<u>Namespaces</u> .....	2498
<u>Variants</u> .....	2498
<u>Views</u> .....	2498
<u>More</u> .....	2498
<b><u>Multi-op/Issues/Non Multipliers</u></b> .....	<b>2499</b>
<u>Non Multipliers</u> .....	2499
<u>Namespaces</u> .....	2499
<u>Variants</u> .....	2499
<u>Views</u> .....	2499
<u>More</u> .....	2500
<b><u>Multi-op/Issues/Non Multipliers</u></b> .....	<b>2501</b>
<u>Non Multipliers</u> .....	2501
<u>Namespaces</u> .....	2501
<u>Variants</u> .....	2501
<u>Views</u> .....	2501
<u>More</u> .....	2502
<b><u>Other Files</u></b> .....	<b>2503</b>
<u>Namespaces</u> .....	2504
<u>Variants</u> .....	2504
<u>Views</u> .....	2504
<u>More</u> .....	2504
<b><u>Other Files</u></b> .....	<b>2505</b>
<u>Namespaces</u> .....	2506
<u>Variants</u> .....	2506
<u>Views</u> .....	2506
<u>More</u> .....	2506
<b><u>DX Cluster/Packet</u></b> .....	<b>2507</b>
<u>Contents</u> .....	2507
<u>TNC pre-test</u> .....	2507
<u>TheFirmware or WA8DED</u> .....	2507
<u>TAPR</u> .....	2508
<u>Win-Test TNC set-up</u> .....	2509
<u>Testing the Setup</u> .....	2509

# Table of Contents

- DX Cluster/Packet**
  - Connecting node.....2509
  - Disconnecting node.....2511
  - See also.....2511
    - Namespaces.....2511
    - Variants.....2511
    - Views.....2512
    - More.....2512
  
- DX Cluster/Packet.....2513**
  - Contents.....2513
  - TNC pre-test.....2513
    - TheFirmware or WA8DED.....2513
    - TAPR.....2514
  - Win-Test TNC set-up.....2515
  - Testing the Setup.....2515
  - Connecting node.....2515
  - Disconnecting node.....2517
  - See also.....2517
    - Namespaces.....2517
    - Variants.....2517
    - Views.....2518
    - More.....2518
  
- Multi-op/Passing.....2519**
  - Contents.....2519
  - Checking if a multiplier is required on another band.....2519
  - Passing the multiplier itself.....2519
  - Alerting the other operator(s) about the mult.....2520
  - Working the passed station.....2522
  - See also.....2522
    - Namespaces.....2522
    - Variants.....2522
    - Views.....2522
    - More.....2523
  
- Positioning Windows.....2524**
  - Floating window layout.....2524
  - Configuring windows.....2525
    - Changing the log font.....2525
    - Resizing windows.....2525
    - Moving windows.....2525
  - See Also.....2525
    - Namespaces.....2525
    - Variants.....2525
    - Views.....2525
    - More.....2526



# Table of Contents

<b><u>Positioning Windows</u></b> .....	<b>2527</b>
<u>Floating window layout</u> .....	2527
<u>Configuring windows</u> .....	2528
<u>Changing the log font</u> .....	2528
<u>Resizing windows</u> .....	2528
<u>Moving windows</u> .....	2528
<u>See Also</u> .....	2528
<u>Namespaces</u> .....	2528
<u>Variants</u> .....	2528
<u>Views</u> .....	2528
<u>More</u> .....	2529
<b><u>Preface</u></b> .....	<b>2530</b>
<u>Mailing list</u> .....	2530
<u>Namespaces</u> .....	2530
<u>Variants</u> .....	2530
<u>Views</u> .....	2530
<u>More</u> .....	2530
<b><u>SO1R/Radio control</u></b> .....	<b>2531</b>
<u>SO1R/Radio Control</u> .....	2531
<u>Hardware</u> .....	2531
<u>Setup</u> .....	2531
<u>Namespaces</u> .....	2531
<u>Variants</u> .....	2531
<u>Views</u> .....	2531
<u>More</u> .....	2532
<b><u>SO1R/Radio control</u></b> .....	<b>2533</b>
<u>SO1R/Radio Control</u> .....	2533
<u>Hardware</u> .....	2533
<u>Setup</u> .....	2533
<u>Namespaces</u> .....	2533
<u>Variants</u> .....	2533
<u>Views</u> .....	2533
<u>More</u> .....	2534
<b><u>Release Notes</u></b> .....	<b>2535</b>
<u>Contents</u> .....	2535
<u>Release information 4.47.0 (to be released)</u> .....	2538
<u>Bugfixes</u> .....	2538
<u>New features</u> .....	2538
<u>Release information 4.46.0 (January 17th, 2023)</u> .....	2539
<u>Bugfixes</u> .....	2539
<u>New features</u> .....	2539
<u>Release information 4.45.0 (October 18th, 2022)</u> .....	2540
<u>Bugfixes</u> .....	2540
<u>New features</u> .....	2540

# Table of Contents

## Release Notes

<u>Release information 4.44.0 (July 22nd, 2022)</u> .....	2540
<u>Bugfixes</u> .....	2540
<u>New features</u> .....	2541
<u>Release information 4.43.0 (July 1st, 2022)</u> .....	2541
<u>Bugfixes</u> .....	2541
<u>New features</u> .....	2541
<u>Release information 4.42.0 (May 20, 2022)</u> .....	2541
<u>Bugfixes</u> .....	2541
<u>New features</u> .....	2542
<u>Release information 4.41.0 (Feb 15, 2022)</u> .....	2542
<u>Bugfixes</u> .....	2542
<u>New features</u> .....	2542
<u>Release information 4.40.0 (Jan 18, 2022)</u> .....	2543
<u>Bugfixes</u> .....	2543
<u>New features</u> .....	2543
<u>Release information 4.39.0 (Dec 6, 2021)</u> .....	2544
<u>Bugfixes</u> .....	2544
<u>New features</u> .....	2544
<u>Release information 4.38.1 (Oct 25, 2021)</u> .....	2544
<u>Bugfixes</u> .....	2544
<u>Release information 4.38.0 (Oct 25, 2021)</u> .....	2544
<u>Bugfixes</u> .....	2545
<u>New features</u> .....	2545
<u>Release information 4.37 (June 29, 2021)</u> .....	2546
<u>Bugfixes</u> .....	2546
<u>New features</u> .....	2546
<u>Release information 4.36 (May 19, 2021)</u> .....	2546
<u>Bugfixes</u> .....	2546
<u>New features</u> .....	2546
<u>Release information 4.35 (Apr. 9, 2021)</u> .....	2547
<u>Bugfixes</u> .....	2547
<u>New features</u> .....	2547
<u>Release information 4.34.1 (Feb. 5, 2021)</u> .....	2548
<u>Bugfixes</u> .....	2548
<u>Release information 4.34.0 (Jan. 25, 2021)</u> .....	2548
<u>New features</u> .....	2548
<u>Bugfixes</u> .....	2549
<u>Release information 4.33.0 (October 14, 2020)</u> .....	2549
<u>New features</u> .....	2549
<u>Bugfixes</u> .....	2549
<u>Release information 4.32.0 (September 1, 2020)</u> .....	2549
<u>New Features</u> .....	2549
<u>Bugfixes</u> .....	2550
<u>Release information 4.31.0 (June 28, 2020)</u> .....	2550
<u>New Features</u> .....	2550
<u>Release information 4.30.0 (Jan 16, 2020)</u> .....	2551
<u>Bugfixes</u> .....	2551

# Table of Contents

## Release Notes

<u>New Features</u> .....	2551
<u>Release information 4.29.0 (July 5, 2019)</u> .....	2552
<u>Bugfixes</u> .....	2552
<u>New Features</u> .....	2552
<u>Release information 4.28.0 (June 15, 2018)</u> .....	2552
<u>Bugfixes</u> .....	2552
<u>New Features</u> .....	2552
<u>Release information 4.27.0 (Jan 4, 2018)</u> .....	2553
<u>Bugfixes</u> .....	2553
<u>New Features</u> .....	2553
<u>Release information 4.26.0 (Nov 19, 2017)</u> .....	2553
<u>Bugfixes</u> .....	2553
<u>New Features</u> .....	2553
<u>Release information (4.25.0) (June 28, 2017)</u> .....	2553
<u>Bugfixes</u> .....	2553
<u>New Features</u> .....	2553
<u>Release information (4.24.0) (January 20, 2017)</u> .....	2554
<u>Bugfixes</u> .....	2554
<u>New Features</u> .....	2554
<u>Release information (4.23.0) (October 21, 2016)</u> .....	2555
<u>Bugfixes</u> .....	2555
<u>New Features</u> .....	2555
<u>Release information (4.22.0) (August 26, 2016)</u> .....	2555
<u>Bugfixes</u> .....	2555
<u>New Features</u> .....	2555
<u>Release information (4.21.0) (June 27, 2016)</u> .....	2556
<u>Bugfixes</u> .....	2556
<u>New Features</u> .....	2557
<u>Release information (4.20.0) (January 17, 2016)</u> .....	2557
<u>Bugfixes</u> .....	2557
<u>New Features</u> .....	2557
<u>Release information (4.19.0) (October 15, 2015)</u> .....	2558
<u>Bugfixes</u> .....	2558
<u>New Features</u> .....	2558
<u>Release information (4.18.0) (September 25, 2015)</u> .....	2558
<u>Bugfixes</u> .....	2558
<u>New Features</u> .....	2559
<u>Release information (4.17.0) (June 30, 2015)</u> .....	2560
<u>Bugfixes</u> .....	2560
<u>New Features</u> .....	2560
<u>Release information (4.16.0) (Mar 17, 2015)</u> .....	2561
<u>Bugfixes</u> .....	2561
<u>New Features</u> .....	2561
<u>Release information (4.15.0) (Nov 22, 2014)</u> .....	2562
<u>Bugfixes</u> .....	2562
<u>New Features</u> .....	2562
<u>Release information (4.14.0) (Oct 19, 2014)</u> .....	2562

# Table of Contents

## Release Notes

<u>Bugfixes</u> .....	2562
<u>New Features</u> .....	2562
<u>Release information (4.13.0) (Jun 30, 2014)</u> .....	2563
<u>Bugfixes</u> .....	2563
<u>New Features</u> .....	2563
<u>Release information (4.12.0) (February 10, 2014)</u> .....	2564
<u>Bugfixes</u> .....	2564
<u>New Features</u> .....	2564
<u>Release information (4.11.0) (October 20, 2013)</u> .....	2565
<u>Bugfixes</u> .....	2565
<u>New Features</u> .....	2565
<u>Release information (4.10.0) (October 23, 2012)</u> .....	2566
<u>Bugfixes</u> .....	2566
<u>New Features</u> .....	2566
<u>Release information (4.9.1) (October 27, 2011)</u> .....	2567
<u>Bugfixes</u> .....	2567
<u>Release information (4.9.0) (October 26, 2011)</u> .....	2567
<u>Bugfixes</u> .....	2567
<u>New Features</u> .....	2567
<u>Release information (4.8.0) (June 26, 2011)</u> .....	2568
<u>Bugfixes</u> .....	2568
<u>New Features</u> .....	2568
<u>Release information (4.7.0) (December 2, 2010)</u> .....	2568
<u>Bugfixes</u> .....	2568
<u>New Features</u> .....	2569
<u>Release information (4.6.1) (Released only for demo and DxPed versions)</u> .....	2569
<u>Bugfixes</u> .....	2569
<u>New Features</u> .....	2570
<u>Release information (4.6.0) (October 24, 2010)</u> .....	2570
<u>Bugfixes</u> .....	2570
<u>New Features</u> .....	2571
<u>Release information (4.5.2) (July 3, 2010)</u> .....	2576
<u>Bugfixes</u> .....	2576
<u>Release information (4.5.1) (June 27, 2010)</u> .....	2576
<u>Bugfixes</u> .....	2576
<u>Release information (4.5.0) (June 5, 2010)</u> .....	2576
<u>New Features</u> .....	2576
<u>Bugfixes</u> .....	2577
<u>Release information (4.4.0) (January 17, 2010)</u> .....	2577
<u>Bugfixes</u> .....	2577
<u>New Features</u> .....	2578
<u>Release information (4.3.0) (November 23, 2009)</u> .....	2579
<u>Bugfixes</u> .....	2580
<u>New Features</u> .....	2580
<u>Release information (4.2.0) (October 21, 2009)</u> .....	2581
<u>Bugfixes</u> .....	2581
<u>New Features</u> .....	2582

# Table of Contents

## **Release Notes**

<u>Release information (4.1.0) (August 8, 2009)</u> .....	2583
<u>New Features</u> .....	2583
<u>Bugfixes</u> .....	2584
<u>Release information (4.0.1) (June 30, 2009)</u> .....	2585
<u>Bugfixes</u> .....	2585
<u>Release information (4.0.0) (June 26, 2009)</u> .....	2585
<u>New Features</u> .....	2585
<u>Namespaces</u> .....	2586
<u>Variants</u> .....	2586
<u>Views</u> .....	2586
<u>More</u> .....	2586

## **Release Notes V3**.....**2588**

<u>Contents</u> .....	2588
<u>Release information (3.27.1-dev) (nightly)</u> .....	2590
<u>Bugfixes</u> .....	2590
<u>Release information (3.27.0) (Jun 9, 2009)</u> .....	2590
<u>New Features</u> .....	2590
<u>Bug Fixes</u> .....	2590
<u>Release information (3.26.0) (Mar 26, 2009)</u> .....	2590
<u>New Features</u> .....	2590
<u>Bugfixes</u> .....	2592
<u>Release information (3.25.1) (Feb 13, 2009)</u> .....	2592
<u>New Features</u> .....	2592
<u>Bugfixes</u> .....	2592
<u>Release information (3.24.0) (Jan 15, 2009)</u> .....	2593
<u>New Features</u> .....	2593
<u>Bugfixes</u> .....	2594
<u>Release information (3.23.0) (Oct 22, 2008)</u> .....	2594
<u>New Features</u> .....	2594
<u>Release information (3.22.0) (Sep 16, 2008)</u> .....	2595
<u>New Features</u> .....	2595
<u>Bugfixes</u> .....	2595
<u>Release information (3.21.0) (June 23, 2008)</u> .....	2596
<u>New Features</u> .....	2596
<u>Bugfixes</u> .....	2598
<u>Release information (3.20.0) (May 14, 2008)</u> .....	2598
<u>Bugfixes</u> .....	2600
<u>Release information (3.19.0) (Jan 24, 2008)</u> .....	2600
<u>New Features</u> .....	2600
<u>Bugfixes</u> .....	2601
<u>Release information (3.18.0) (Nov 3, 2007)</u> .....	2602
<u>General</u> .....	2602
<u>New Features</u> .....	2602
<u>Bugfixes</u> .....	2602
<u>Release information (3.17.0) (Oct 21, 2007)</u> .....	2603
<u>General</u> .....	2603

# Table of Contents

## Release Notes V3

<u>New Features</u> .....	2603
<u>Bugfixes</u> .....	2603
<u>Release information (3.16.0) (Sep 7, 2007)</u> .....	2604
<u>New Features</u> .....	2604
<u>Bugfixes</u> .....	2605
<u>Release information (3.15.0) (Aug 8, 2007)</u> .....	2606
<u>New Features</u> .....	2606
<u>Bugfixes</u> .....	2607
<u>Release information (3.14.0) (Jul 25, 2007)</u> .....	2608
<u>Features</u> .....	2608
<u>Bugfixes</u> .....	2608
<u>Release information (3.13.0) (Jul 23, 2007)</u> .....	2608
<u>General</u> .....	2608
<u>Features</u> .....	2609
<u>Bugfixes</u> .....	2610
<u>Release information (3.12.0) (Jul 11, 2007)</u> .....	2611
<u>Features</u> .....	2611
<u>Bugfixes</u> .....	2611
<u>Release information (3.11.0) (May 18, 2007)</u> .....	2611
<u>General</u> .....	2611
<u>Features</u> .....	2611
<u>Bugfixes</u> .....	2612
<u>Release information (3.10.0) (Mar 22, 2007)</u> .....	2612
<u>Features</u> .....	2612
<u>Bugfixes</u> .....	2614
<u>Release information (3.9.0) (Mar 13, 2007)</u> .....	2614
<u>Features</u> .....	2614
<u>Bugfixes</u> .....	2615
<u>Release information (3.8.6) (Feb 26, 2007)</u> .....	2615
<u>Features</u> .....	2615
<u>Bugfixes</u> .....	2615
<u>Release information (3.8.4) (Feb 8, 2007)</u> .....	2616
<u>Features</u> .....	2616
<u>Bugfixes</u> .....	2616
<u>Release information (3.8.0) (Jan 18, 2007)</u> .....	2617
<u>Features</u> .....	2617
<u>Bugfixes</u> .....	2618
<u>Release information (3.7.0) (Dec 1, 2006)</u> .....	2618
<u>General</u> .....	2618
<u>Features</u> .....	2618
<u>Bugfixes</u> .....	2619
<u>Release information (3.6.2) (Nov 23, 2006)</u> .....	2619
<u>Bugfixes</u> .....	2619
<u>Release information (3.6.1) (Nov 21, 2006)</u> .....	2619
<u>Bugfixes</u> .....	2620
<u>Release information (3.6.0) (Nov 20, 2006)</u> .....	2620
<u>General</u> .....	2620

# Table of Contents

<b><u>Release Notes V3</u></b>	
<u>New Features</u> .....	2620
<u>Bugfixes</u> .....	2621
<u>Release information (3.5.0) (Oct 22, 2006)</u> .....	2621
<u>General</u> .....	2622
<u>New Features</u> .....	2622
<u>Bugfixes</u> .....	2622
<u>Release information (3.4.5) (Oct. 8, 2006)</u> .....	2622
<u>New Features</u> .....	2622
<u>Bugfixes</u> .....	2624
<u>Release information (3.3.5) (Sep 20, 2006)</u> .....	2625
<u>General</u> .....	2625
<u>New Features</u> .....	2625
<u>Bugfixes</u> .....	2626
<u>Release information (3.2.0) (Aug 30, 2006)</u> .....	2626
<u>General</u> .....	2626
<u>New Features</u> .....	2626
<u>Bugfixes</u> .....	2628
<u>Release information (3.1.0) (Jul 27, 2006)</u> .....	2628
<u>General</u> .....	2628
<u>New features</u> .....	2628
<u>Bug fixes</u> .....	2629
<u>Release information (3.0.0) (Jun 22, 2006)</u> .....	2629
<u>New features</u> .....	2630
<u>Namespaces</u> .....	2630
<u>Variants</u> .....	2630
<u>Views</u> .....	2630
<u>More</u> .....	2630
<b><u>Release Notes V3</u></b> .....	<b>2632</b>
<u>Contents</u> .....	2632
<u>Release information (3.27.1-dev) (nightly)</u> .....	2634
<u>Bugfixes</u> .....	2634
<u>Release information (3.27.0) (Jun 9, 2009)</u> .....	2634
<u>New Features</u> .....	2634
<u>Bug Fixes</u> .....	2634
<u>Release information (3.26.0) (Mar 26, 2009)</u> .....	2634
<u>New Features</u> .....	2634
<u>Bugfixes</u> .....	2636
<u>Release information (3.25.1) (Feb 13, 2009)</u> .....	2636
<u>New Features</u> .....	2636
<u>Bugfixes</u> .....	2636
<u>Release information (3.24.0) (Jan 15, 2009)</u> .....	2637
<u>New Features</u> .....	2637
<u>Bugfixes</u> .....	2638
<u>Release information (3.23.0) (Oct 22, 2008)</u> .....	2638
<u>New Features</u> .....	2638
<u>Release information (3.22.0) (Sep 16, 2008)</u> .....	2639

# Table of Contents

## Release Notes V3

<u>New Features</u> .....	2639
<u>Bugfixes</u> .....	2639
<u>Release information (3.21.0) (June 23, 2008)</u> .....	2640
<u>New Features</u> .....	2640
<u>Bugfixes</u> .....	2642
<u>Release information (3.20.0) (May 14, 2008)</u> .....	2642
<u>Bugfixes</u> .....	2644
<u>Release information (3.19.0) (Jan 24, 2008)</u> .....	2644
<u>New Features</u> .....	2644
<u>Bugfixes</u> .....	2645
<u>Release information (3.18.0) (Nov 3, 2007)</u> .....	2646
<u>General</u> .....	2646
<u>New Features</u> .....	2646
<u>Bugfixes</u> .....	2646
<u>Release information (3.17.0) (Oct 21, 2007)</u> .....	2647
<u>General</u> .....	2647
<u>New Features</u> .....	2647
<u>Bugfixes</u> .....	2647
<u>Release information (3.16.0) (Sep 7, 2007)</u> .....	2648
<u>New Features</u> .....	2648
<u>Bugfixes</u> .....	2649
<u>Release information (3.15.0) (Aug 8, 2007)</u> .....	2650
<u>New Features</u> .....	2650
<u>Bugfixes</u> .....	2651
<u>Release information (3.14.0) (Jul 25, 2007)</u> .....	2652
<u>Features</u> .....	2652
<u>Bugfixes</u> .....	2652
<u>Release information (3.13.0) (Jul 23, 2007)</u> .....	2652
<u>General</u> .....	2652
<u>Features</u> .....	2653
<u>Bugfixes</u> .....	2654
<u>Release information (3.12.0) (Jul 11, 2007)</u> .....	2655
<u>Features</u> .....	2655
<u>Bugfixes</u> .....	2655
<u>Release information (3.11.0) (May 18, 2007)</u> .....	2655
<u>General</u> .....	2655
<u>Features</u> .....	2655
<u>Bugfixes</u> .....	2656
<u>Release information (3.10.0) (Mar 22, 2007)</u> .....	2656
<u>Features</u> .....	2656
<u>Bugfixes</u> .....	2658
<u>Release information (3.9.0) (Mar 13, 2007)</u> .....	2658
<u>Features</u> .....	2658
<u>Bugfixes</u> .....	2659
<u>Release information (3.8.6) (Feb 26, 2007)</u> .....	2659
<u>Features</u> .....	2659
<u>Bugfixes</u> .....	2659



# Table of Contents

## **Release Notes V3**

<u>Release information (3.8.4) (Feb 8, 2007)</u> .....	2660
<u>Features</u> .....	2660
<u>Bugfixes</u> .....	2660
<u>Release information (3.8.0) (Jan 18, 2007)</u> .....	2661
<u>Features</u> .....	2661
<u>Bugfixes</u> .....	2662
<u>Release information (3.7.0) (Dec 1, 2006)</u> .....	2662
<u>General</u> .....	2662
<u>Features</u> .....	2662
<u>Bugfixes</u> .....	2663
<u>Release information (3.6.2) (Nov 23, 2006)</u> .....	2663
<u>Bugfixes</u> .....	2663
<u>Release information (3.6.1) (Nov 21, 2006)</u> .....	2663
<u>Bugfixes</u> .....	2664
<u>Release information (3.6.0) (Nov 20, 2006)</u> .....	2664
<u>General</u> .....	2664
<u>New Features</u> .....	2664
<u>Bugfixes</u> .....	2665
<u>Release information (3.5.0) (Oct 22, 2006)</u> .....	2665
<u>General</u> .....	2666
<u>New Features</u> .....	2666
<u>Bugfixes</u> .....	2666
<u>Release information (3.4.5) (Oct. 8, 2006)</u> .....	2666
<u>New Features</u> .....	2666
<u>Bugfixes</u> .....	2668
<u>Release information (3.3.5) (Sep 20, 2006)</u> .....	2669
<u>General</u> .....	2669
<u>New Features</u> .....	2669
<u>Bugfixes</u> .....	2670
<u>Release information (3.2.0) (Aug 30, 2006)</u> .....	2670
<u>General</u> .....	2670
<u>New Features</u> .....	2670
<u>Bugfixes</u> .....	2672
<u>Release information (3.1.0) (Jul 27, 2006)</u> .....	2672
<u>General</u> .....	2672
<u>New features</u> .....	2672
<u>Bug fixes</u> .....	2673
<u>Release information (3.0.0) (Jun 22, 2006)</u> .....	2673
<u>New features</u> .....	2674
<u>Namespaces</u> .....	2674
<u>Variants</u> .....	2674
<u>Views</u> .....	2674
<u>More</u> .....	2674

<b><u>Rotators</u></b> .....	<b>2676</b>
<u>Contents</u> .....	2676
<u>Configuring wtRotators (single-op environment)</u> .....	2676

# Table of Contents

## **Rotators**

<u>Configuring Win-Test for wtRotators</u> .....	2676
<u>Configuring wtRotators (single PC, no network)</u> .....	2677
<u>Testing the configuration</u> .....	2681
<u>Editing the rotator configuration</u> .....	2682
<u>Adding additional rotators</u> .....	2682
<u>Initializing rotator communications</u> .....	2682
<u>Configuring wtRotators (multi-op environment)</u> .....	2682
<u>Obtaining your network broadcast address</u> .....	2682
<u>Configuring wtRotators (multiple PCs in a network)</u> .....	2683
<u>Add your rotators</u> .....	2684
<u>See Also</u> .....	2684
<u>In the manual</u> .....	2684
<u>Namespaces</u> .....	2685
<u>Variants</u> .....	2685
<u>Views</u> .....	2685
<u>More</u> .....	2685

## **Rotators.....2686**

<u>Contents</u> .....	2686
<u>Configuring wtRotators (single-op environment)</u> .....	2686
<u>Configuring Win-Test for wtRotators</u> .....	2686
<u>Configuring wtRotators (single PC, no network)</u> .....	2687
<u>Testing the configuration</u> .....	2691
<u>Editing the rotator configuration</u> .....	2692
<u>Adding additional rotators</u> .....	2692
<u>Initializing rotator communications</u> .....	2692
<u>Configuring wtRotators (multi-op environment)</u> .....	2692
<u>Obtaining your network broadcast address</u> .....	2692
<u>Configuring wtRotators (multiple PCs in a network)</u> .....	2693
<u>Add your rotators</u> .....	2694
<u>See Also</u> .....	2694
<u>In the manual</u> .....	2694
<u>Namespaces</u> .....	2695
<u>Variants</u> .....	2695
<u>Views</u> .....	2695
<u>More</u> .....	2695

## **RTTY.....2696**

<u>Contents</u> .....	2696
<u>Downloading MMTTY</u> .....	2696
<u>Configuring received data logging on MMTTY (optional)</u> .....	2697
<u>Win-Test RTTY configuration</u> .....	2697
<u>Open the RTTY configuration box</u> .....	2697
<u>Enable MMTTY</u> .....	2698
<u>Set up MMTTY PTT COM Port</u> .....	2700
<u>Testing</u> .....	2702
<u>General usage</u> .....	2703

# Table of Contents

## **RTTY**

<u>RTTY window</u> .....	2703
<u>Defining messages</u> .....	2705
<u>MMTTY window</u> .....	2705
<u>See also</u> .....	2706
<u>Namespaces</u> .....	2706
<u>Variants</u> .....	2706
<u>Views</u> .....	2706
<u>More</u> .....	2706

## **RTTY.....2707**

<u>Contents</u> .....	2707
<u>Downloading MMTTY</u> .....	2707
<u>Configuring received data logging on MMTTY (optional)</u> .....	2708
<u>Win-Test RTTY configuration</u> .....	2708
<u>Open the RTTY configuration box</u> .....	2708
<u>Enable MMTTY</u> .....	2709
<u>Set up MMTTY PTT COM Port</u> .....	2711
<u>Testing</u> .....	2713
<u>General usage</u> .....	2714
<u>RTTY window</u> .....	2714
<u>Defining messages</u> .....	2716
<u>MMTTY window</u> .....	2716
<u>See also</u> .....	2717
<u>Namespaces</u> .....	2717
<u>Variants</u> .....	2717
<u>Views</u> .....	2717
<u>More</u> .....	2717

## **Running a contest.....2718**

<u>Contents</u> .....	2718
<u>Logging QSOs</u> .....	2718
<u>SO1R specifics</u> .....	2718
<u>SO2R specifics</u> .....	2718
<u>Multi-op contesting</u> .....	2718
<u>Possible issues</u> .....	2719
<u>Contest specific behaviour</u> .....	2719
<u>Posting live score on-line</u> .....	2719
<u>Post-contest specifics</u> .....	2719
<u>Namespaces</u> .....	2719
<u>Variants</u> .....	2719
<u>Views</u> .....	2719
<u>More</u> .....	2719

## **running on Linux.....2720**

<u>Contents</u> .....	2720
<u>Introduction</u> .....	2720
<u>Installation</u> .....	2722

# Table of Contents

## **running on Linux**

<u>Interfaces</u> .....	2722
<u>Serial and printer ports</u> .....	2722
<u>Transceivers</u> .....	2724
<u>Version summary</u> .....	2724
<u>Known bugs</u> .....	2724
<u>Links</u> .....	2724
<u>Namespaces</u> .....	2724
<u>Variants</u> .....	2724
<u>Views</u> .....	2724
<u>More</u> .....	2724

## **running on Linux.....2725**

<u>Contents</u> .....	2725
<u>Introduction</u> .....	2725
<u>Installation</u> .....	2727
<u>Interfaces</u> .....	2727
<u>Serial and printer ports</u> .....	2727
<u>Transceivers</u> .....	2729
<u>Version summary</u> .....	2729
<u>Known bugs</u> .....	2729
<u>Links</u> .....	2729
<u>Namespaces</u> .....	2729
<u>Variants</u> .....	2729
<u>Views</u> .....	2729
<u>More</u> .....	2729

## **SO2R/Second radio window.....2730**

<u>Radio TX/RX information area</u> .....	2730
<u>Headphone audio control area</u> .....	2731
<u>Latch Mode specifics</u> .....	2731
<u>Scenario control area</u> .....	2731
<u>RUN or S/P area</u> .....	2731
<u>Secondary radio log fields area</u> .....	2732
<u>Namespaces</u> .....	2732
<u>Variants</u> .....	2732
<u>Views</u> .....	2732
<u>More</u> .....	2732

## **SO2R/Second radio window.....2733**

<u>Radio TX/RX information area</u> .....	2733
<u>Headphone audio control area</u> .....	2734
<u>Latch Mode specifics</u> .....	2734
<u>Scenario control area</u> .....	2734
<u>RUN or S/P area</u> .....	2734
<u>Secondary radio log fields area</u> .....	2735
<u>Namespaces</u> .....	2735
<u>Variants</u> .....	2735

# Table of Contents

<b><u>SO2R/Second radio window</u></b>	
<u>Views</u> .....	2735
<u>More</u> .....	2735
<b><u>Multi-op/Issues/Sequential serials</u></b> .....	<b>2736</b>
<u>Sequential Serials</u> .....	2736
<u>Namespaces</u> .....	2736
<u>Variants</u> .....	2736
<u>Views</u> .....	2736
<u>More</u> .....	2736
<b><u>SO2R/EZMaster</u></b> .....	<b>2737</b>
<u>Contents</u> .....	2737
<u>Setting up the EZMaster for use with Win-Test</u> .....	2737
<u>Setting up the technique</u> .....	2737
<u>Setting up the [Shift] key for secondary radio</u> .....	2737
<u>Setting up the [Caps Lock] key for secondary radio</u> .....	2737
<u>Setting the SO2R Control box</u> .....	2737
<u>See also</u> .....	2737
<u>External sources</u> .....	2738
<u>Namespaces</u> .....	2738
<u>Variants</u> .....	2738
<u>Views</u> .....	2738
<u>More</u> .....	2738
<b><u>SO2R/EZMaster</u></b> .....	<b>2739</b>
<u>Contents</u> .....	2739
<u>Setting up the EZMaster for use with Win-Test</u> .....	2739
<u>Setting up the technique</u> .....	2739
<u>Setting up the [Shift] key for secondary radio</u> .....	2739
<u>Setting up the [Caps Lock] key for secondary radio</u> .....	2739
<u>Setting the SO2R Control box</u> .....	2739
<u>See also</u> .....	2739
<u>External sources</u> .....	2740
<u>Namespaces</u> .....	2740
<u>Variants</u> .....	2740
<u>Views</u> .....	2740
<u>More</u> .....	2740
<b><u>SO2R/MK2R</u></b> .....	<b>2741</b>
<u>Contents</u> .....	2741
<u>Setting up the MK2R for use with Win-Test</u> .....	2741
<u>Setting up the technique</u> .....	2741
<u>Setting up the [Shift] key for secondary radio</u> .....	2741
<u>Setting up the [Caps Lock] key for secondary radio</u> .....	2741
<u>Setting the SO2R Control box</u> .....	2742
<u>See also</u> .....	2758
<u>External sources</u> .....	2758

# Table of Contents

## **SO2R/MK2R**

<u>Namespaces</u> .....	2758
<u>Variants</u> .....	2758
<u>Views</u> .....	2758
<u>More</u> .....	2758

## **SO2R/MK2R.....2759**

<u>Contents</u> .....	2759
<u>Setting up the MK2R for use with Win-Test</u> .....	2759
<u>Setting up the technique</u> .....	2759
<u>Setting up the [Shift] key for secondary radio</u> .....	2759
<u>Setting up the [Caps Lock] key for secondary radio</u> .....	2759
<u>Setting the SO2R Control box</u> .....	2760
<u>See also</u> .....	2776
<u>External sources</u> .....	2776
<u>Namespaces</u> .....	2776
<u>Variants</u> .....	2776
<u>Views</u> .....	2776
<u>More</u> .....	2776

## **SO2R/Shift binds second radio.....2777**

<u>Special issues</u> .....	2777
<u>Namespaces</u> .....	2777
<u>Variants</u> .....	2778
<u>Views</u> .....	2778
<u>More</u> .....	2778

## **SO2R/Shift binds second radio.....2779**

<u>Special issues</u> .....	2779
<u>Namespaces</u> .....	2779
<u>Variants</u> .....	2780
<u>Views</u> .....	2780
<u>More</u> .....	2780

## **Multi-op/Status window.....2781**

<u>Understanding the status window</u> .....	2781
<u>Observing the 10-minute rule</u> .....	2781
<u>OSY Timers</u> .....	2781
<u>Hiding unnecessary information in the status window</u> .....	2782
<u>See also</u> .....	2782
<u>Namespaces</u> .....	2782
<u>Variants</u> .....	2782
<u>Views</u> .....	2782
<u>More</u> .....	2782

## **StyleSheet.....2784**

<u>Contents</u> .....	2784
<u>Language</u> .....	2784

# Table of Contents

## **StyleSheet**

<u>Structuring of articles</u> .....	2784
<u>Previewing and summarising your edits</u> .....	2785
<u>Menu items</u> .....	2785
<u>Text commands</u> .....	2785
<u>Keys</u> .....	2785
<u>Images</u> .....	2785
<u>References</u> .....	2786
<u>Notes and Tips</u> .....	2786
<u>Namespaces</u> .....	2786
<u>Variants</u> .....	2786
<u>Views</u> .....	2786
<u>More</u> .....	2787

## **StyleSheet.....2788**

<u>Contents</u> .....	2788
<u>Language</u> .....	2788
<u>Structuring of articles</u> .....	2788
<u>Previewing and summarising your edits</u> .....	2789
<u>Menu items</u> .....	2789
<u>Text commands</u> .....	2789
<u>Keys</u> .....	2789
<u>Images</u> .....	2789
<u>References</u> .....	2790
<u>Notes and Tips</u> .....	2790
<u>Namespaces</u> .....	2790
<u>Variants</u> .....	2790
<u>Views</u> .....	2790
<u>More</u> .....	2791

## **Supported Accessories.....2792**

<u>Contents</u> .....	2792
<u>CW and/or voice keyers</u> .....	2792
<u>Band decoders</u> .....	2792
<u>CAT interfaces</u> .....	2792
<u>Integrated SO2R boxes</u> .....	2793
<u>microHAM MK2R/MK2R+/micro2R</u> .....	2793
<u>YCCC SO2R Box</u> .....	2793
<u>Top Ten Devices DX Doubler</u> .....	2794
<u>Ham Radio Solutions EZMaster</u> .....	2795
<u>W5XD Multi-Keyer</u> .....	2795
<u>Namespaces</u> .....	2795
<u>Variants</u> .....	2795
<u>Views</u> .....	2795
<u>More</u> .....	2795

# Table of Contents

<b><u>Supported Accessories</u></b> .....	<b>2796</b>
<u>Contents</u> .....	2796
<u>CW and/or voice keyers</u> .....	2796
<u>Band decoders</u> .....	2796
<u>CAT interfaces</u> .....	2796
<u>Integrated SO2R boxes</u> .....	2797
<u>microHAM MK2R/MK2R+/micro2R</u> .....	2797
<u>YCCC SO2R Box</u> .....	2797
<u>Top Ten Devices DX Doubler</u> .....	2798
<u>Ham Radio Solutions EZMaster</u> .....	2799
<u>W5XD Multi-Keyer</u> .....	2799
<u>Namespaces</u> .....	2799
<u>Variants</u> .....	2799
<u>Views</u> .....	2799
<u>More</u> .....	2799
<b><u>Supported Contests</u></b> .....	<b>2800</b>
<u>HF Contests</u> .....	2800
<u>VHF and above Contests</u> .....	2801
<u>Special for DXPeditions</u> .....	2802
<u>Namespaces</u> .....	2802
<u>Variants</u> .....	2802
<u>Views</u> .....	2802
<u>More</u> .....	2802
<b><u>Supported Contests</u></b> .....	<b>2803</b>
<u>HF Contests</u> .....	2803
<u>VHF and above Contests</u> .....	2804
<u>Special for DXPeditions</u> .....	2805
<u>Namespaces</u> .....	2805
<u>Variants</u> .....	2805
<u>Views</u> .....	2805
<u>More</u> .....	2805
<b><u>Supported rigs</u></b> .....	<b>2806</b>
<u>Contents</u> .....	2806
<u>Kenwood</u> .....	2806
<u>Icom</u> .....	2807
<u>Other Icom radios</u> .....	2808
<u>Yaesu</u> .....	2808
<u>Ten-Tec</u> .....	2809
<u>Elecraft</u> .....	2810
<u>Others</u> .....	2810
<u>Namespaces</u> .....	2810
<u>Variants</u> .....	2810
<u>Views</u> .....	2810
<u>More</u> .....	2810



# Table of Contents

<b><u>Supported rigs</u></b> .....	<b>2811</b>
<u>Contents</u> .....	2811
<u>Kenwood</u> .....	2811
<u>Icom</u> .....	2812
<u>Other Icom radios</u> .....	2813
<u>Yaesu</u> .....	2813
<u>Ten-Tec</u> .....	2814
<u>Elecraft</u> .....	2815
<u>Others</u> .....	2815
<u>Namespaces</u> .....	2815
<u>Variants</u> .....	2815
<u>Views</u> .....	2815
<u>More</u> .....	2815
<b><u>Sweepstakes</u></b> .....	<b>2816</b>
<u>Contents</u> .....	2816
<u>Define your ARRL Section, Check, and Precedence</u> .....	2816
<u>Program your CW Messages</u> .....	2818
<u>ARRL Section "equivalence" file</u> .....	2818
<u>Super Check Partial file for ARRL Sweepstakes</u> .....	2818
<u>Logging QSOs</u> .....	2819
<u>Displaying Sections worked</u> .....	2821
<u>Check your log after the contest</u> .....	2822
<u>Namespaces</u> .....	2823
<u>Variants</u> .....	2823
<u>Views</u> .....	2823
<u>More</u> .....	2823
<b><u>Sweepstakes</u></b> .....	<b>2824</b>
<u>Contents</u> .....	2824
<u>Define your ARRL Section, Check, and Precedence</u> .....	2824
<u>Program your CW Messages</u> .....	2826
<u>ARRL Section "equivalence" file</u> .....	2826
<u>Super Check Partial file for ARRL Sweepstakes</u> .....	2826
<u>Logging QSOs</u> .....	2827
<u>Displaying Sections worked</u> .....	2829
<u>Check your log after the contest</u> .....	2830
<u>Namespaces</u> .....	2831
<u>Variants</u> .....	2831
<u>Views</u> .....	2831
<u>More</u> .....	2831
<b><u>Talk:Mailing List</u></b> .....	<b>2832</b>
<u>Namespaces</u> .....	2832
<u>Variants</u> .....	2832
<u>Views</u> .....	2832
<u>More</u> .....	2832

# Table of Contents

<b><u>Talk:StyleSheet</u></b> .....	<b>2834</b>
<u>Punctuation</u> .....	2834
<u>Screenshots</u> .....	2834
<u>Namespaces</u> .....	2834
<u>Variants</u> .....	2834
<u>Views</u> .....	2834
<u>More</u> .....	2834
<b><u>DX Cluster/Telnet</u></b> .....	<b>2835</b>
<u>Contents</u> .....	2835
<u>Configuring wtDxTelnet (single-op environment)</u> .....	2835
<u>Configuring Win-Test for wtDxTelnet</u> .....	2835
<u>Configuring wtDxTelnet</u> .....	2836
<u>Testing the configuration</u> .....	2837
<u>Configuring wtDxTelnet (multi-op environment)</u> .....	2837
<u>Obtaining your network broadcast address</u> .....	2838
<u>Configuring wtDxTelnet</u> .....	2839
<u>See Also</u> .....	2839
<u>In the manual</u> .....	2839
<u>Namespaces</u> .....	2840
<u>Variants</u> .....	2840
<u>Views</u> .....	2840
<u>More</u> .....	2840
<b><u>Talk:DX Cluster/Telnet</u></b> .....	<b>2841</b>
<u>Namespaces</u> .....	2841
<u>Variants</u> .....	2841
<u>Views</u> .....	2841
<u>More</u> .....	2841
<b><u>Talk:DX Cluster/Telnet</u></b> .....	<b>2842</b>
<u>Namespaces</u> .....	2842
<u>Variants</u> .....	2842
<u>Views</u> .....	2842
<u>More</u> .....	2842
<b><u>DX Cluster/Telnet</u></b> .....	<b>2843</b>
<u>Contents</u> .....	2843
<u>Configuring wtDxTelnet (single-op environment)</u> .....	2843
<u>Configuring Win-Test for wtDxTelnet</u> .....	2843
<u>Configuring wtDxTelnet</u> .....	2844
<u>Testing the configuration</u> .....	2845
<u>Configuring wtDxTelnet (multi-op environment)</u> .....	2845
<u>Obtaining your network broadcast address</u> .....	2846
<u>Configuring wtDxTelnet</u> .....	2847
<u>See Also</u> .....	2847
<u>In the manual</u> .....	2847
<u>Namespaces</u> .....	2848

# Table of Contents

<b><u>DX Cluster/Telnet</u></b>	
<u>Variants</u> .....	2848
<u>Views</u> .....	2848
<u>More</u> .....	2848
<b><u>Text commands</u></b> .....	<b>2849</b>
<u>Contents</u> .....	2849
<u>Changing Bands or Jumping to a Frequency</u> .....	2849
<u>Changing Mode</u> .....	2849
<u>List of Text Commands</u> .....	2850
<u>CW Functions</u> .....	2850
<u>Voice Keyer Control Functions</u> .....	2851
<u>Multi Operating</u> .....	2851
<u>Open/Close/Database Functions</u> .....	2852
<u>Frequency Control Functions</u> .....	2852
<u>Log synchronisation</u> .....	2852
<u>WinKey</u> .....	2852
<u>Other Functions</u> .....	2853
<u>Namespaces</u> .....	2854
<u>Variants</u> .....	2854
<u>Views</u> .....	2854
<u>More</u> .....	2854
<b><u>Text commands</u></b> .....	<b>2855</b>
<u>Contents</u> .....	2855
<u>Changing Bands or Jumping to a Frequency</u> .....	2855
<u>Changing Mode</u> .....	2855
<u>List of Text Commands</u> .....	2856
<u>CW Functions</u> .....	2856
<u>Voice Keyer Control Functions</u> .....	2857
<u>Multi Operating</u> .....	2857
<u>Open/Close/Database Functions</u> .....	2858
<u>Frequency Control Functions</u> .....	2858
<u>Log synchronisation</u> .....	2858
<u>WinKey</u> .....	2858
<u>Other Functions</u> .....	2859
<u>Namespaces</u> .....	2860
<u>Variants</u> .....	2860
<u>Views</u> .....	2860
<u>More</u> .....	2860
<b><u>Main Page</u></b> .....	<b>2861</b>
<u>Namespaces</u> .....	2862
<u>Variants</u> .....	2862
<u>Views</u> .....	2862
<u>More</u> .....	2862

# Table of Contents

<b><u>WAEDC</u></b> .....	<b>2863</b>
<u>Contents</u> .....	2863
<u>WAEDC - Worked All Europe DX Contest</u> .....	2863
<u>General</u> .....	2863
<u>Setup</u> .....	2863
<u>Receiving QTCs</u> .....	2867
<u>Editing QTCs at a later time</u> .....	2868
<u>Transmitting QTCs</u> .....	2868
<u>RTTY</u> .....	2869
<u>General</u> .....	2869
<u>Transmitting QTCs</u> .....	2869
<u>Receiving QTCs</u> .....	2869
<u>Namespaces</u> .....	2870
<u>Variants</u> .....	2870
<u>Views</u> .....	2870
<u>More</u> .....	2870
<b><u>WAEDC</u></b> .....	<b>2871</b>
<u>Contents</u> .....	2871
<u>WAEDC - Worked All Europe DX Contest</u> .....	2871
<u>General</u> .....	2871
<u>Setup</u> .....	2871
<u>Receiving QTCs</u> .....	2875
<u>Editing QTCs at a later time</u> .....	2876
<u>Transmitting QTCs</u> .....	2876
<u>RTTY</u> .....	2877
<u>General</u> .....	2877
<u>Transmitting QTCs</u> .....	2877
<u>Receiving QTCs</u> .....	2877
<u>Namespaces</u> .....	2878
<u>Variants</u> .....	2878
<u>Views</u> .....	2878
<u>More</u> .....	2878
<b><u>Main Page</u></b> .....	<b>2879</b>
<u>Namespaces</u> .....	2880
<u>Variants</u> .....	2880
<u>Views</u> .....	2880
<u>More</u> .....	2880
<b><u>Preface</u></b> .....	<b>2881</b>
<u>Mailing list</u> .....	2881
<u>Namespaces</u> .....	2881
<u>Variants</u> .....	2881
<u>Views</u> .....	2881
<u>More</u> .....	2881

# Table of Contents

<b><u>Win-Test Wiki:Sandbox</u></b> .....	<b>2882</b>
<u>Namespaces</u> .....	2883
<u>Variants</u> .....	2883
<u>Views</u> .....	2883
<u>More</u> .....	2883
<b><u>WT.INI</u></b> .....	<b>2884</b>
<u>Generic ICOM radio</u> .....	2884
<u>See Also</u> .....	2884
<u>In the manual</u> .....	2884
<u>Namespaces</u> .....	2885
<u>Variants</u> .....	2885
<u>Views</u> .....	2885
<u>More</u> .....	2885
<b><u>WT.INI</u></b> .....	<b>2886</b>
<u>Generic ICOM radio</u> .....	2886
<u>See Also</u> .....	2886
<u>In the manual</u> .....	2886
<u>Namespaces</u> .....	2887
<u>Variants</u> .....	2887
<u>Views</u> .....	2887
<u>More</u> .....	2887
<b><u>Running a contest</u></b> .....	<b>2888</b>
<u>Contents</u> .....	2888
<u>Logging QSOs</u> .....	2888
<u>SO1R specifics</u> .....	2888
<u>SO2R specifics</u> .....	2888
<u>Multi-op contesting</u> .....	2888
<u>Possible issues</u> .....	2889
<u>Contest specific behaviour</u> .....	2889
<u>Posting live score on-line</u> .....	2889
<u>Post-contest specifics</u> .....	2889
<u>Namespaces</u> .....	2889
<u>Variants</u> .....	2889
<u>Views</u> .....	2889
<u>More</u> .....	2889
<b><u>Multi-op/Gabbing</u></b> .....	<b>2890</b>
<u>Sending a message to another station</u> .....	2890
<u>Receiving gab messages</u> .....	2890
<u>See also</u> .....	2890
<u>Namespaces</u> .....	2890
<u>Variants</u> .....	2890
<u>Views</u> .....	2890
<u>More</u> .....	2891

# Table of Contents

<b><u>Multi-op/Passing</u></b> .....	<b>2892</b>
<u>Contents</u> .....	2892
<u>Checking if a multiplier is required on another band</u> .....	2892
<u>Passing the multiplier itself</u> .....	2892
<u>Alerting the other operator(s) about the mult</u> .....	2893
<u>Working the passed station</u> .....	2895
<u>See also</u> .....	2895
<u>Namespaces</u> .....	2895
<u>Variants</u> .....	2895
<u>Views</u> .....	2895
<u>More</u> .....	2896
<b><u>Multi-op/Status window</u></b> .....	<b>2897</b>
<u>Understanding the status window</u> .....	2897
<u>Observing the 10-minute rule</u> .....	2897
<u>QSY Timers</u> .....	2897
<u>Hiding unnecessary information in the status window</u> .....	2898
<u>See also</u> .....	2898
<u>Namespaces</u> .....	2898
<u>Variants</u> .....	2898
<u>Views</u> .....	2898
<u>More</u> .....	2898
<b><u>Multi-op/Deleting OSO</u></b> .....	<b>2900</b>
<u>Deleting a OSO mid-contest in a multi-op situation</u> .....	2900
<u>Namespaces</u> .....	2900
<u>Variants</u> .....	2900
<u>Views</u> .....	2900
<u>More</u> .....	2900
<b><u>Multi-op/Issues/Sequential serials</u></b> .....	<b>2901</b>
<u>Sequential Serials</u> .....	2901
<u>Namespaces</u> .....	2901
<u>Variants</u> .....	2901
<u>Views</u> .....	2901
<u>More</u> .....	2901
<b><u>Multi-op/Issues/Editing serials</u></b> .....	<b>2902</b>
<u>Overcoming out-of-sync scenarios</u> .....	2902
<u>Editing serial numbers</u> .....	2902
<u>Preventing crashes mid-contest</u> .....	2902
<u>Namespaces</u> .....	2903
<u>Variants</u> .....	2903
<u>Views</u> .....	2903
<u>More</u> .....	2903

# Table of Contents

<b><u>Mailing List</u></b> .....	<b>2904</b>
<u>Contents</u> .....	2904
<u>Knowledge needs to be shared</u> .....	2904
<u>Subscribing to the mailing list</u> .....	2904
<u>Unsubscribing to the mailing list</u> .....	2904
<u>Searching and browsing the archive</u> .....	2904
<u>Namespaces</u> .....	2905
<u>Variants</u> .....	2905
<u>Views</u> .....	2905
<u>More</u> .....	2905
<b><u>Release Notes</u></b> .....	<b>2906</b>
<u>Contents</u> .....	2906
<u>Release information 4.47.0 (to be released)</u> .....	2909
<u>Bugfixes</u> .....	2909
<u>New features</u> .....	2909
<u>Release information 4.46.0 (January 17th, 2023)</u> .....	2910
<u>Bugfixes</u> .....	2910
<u>New features</u> .....	2910
<u>Release information 4.45.0 (October 18th, 2022)</u> .....	2911
<u>Bugfixes</u> .....	2911
<u>New features</u> .....	2911
<u>Release information 4.44.0 (July 22nd, 2022)</u> .....	2911
<u>Bugfixes</u> .....	2911
<u>New features</u> .....	2912
<u>Release information 4.43.0 (July 1st, 2022)</u> .....	2912
<u>Bugfixes</u> .....	2912
<u>New features</u> .....	2912
<u>Release information 4.42.0 (May 20, 2022)</u> .....	2912
<u>Bugfixes</u> .....	2912
<u>New features</u> .....	2913
<u>Release information 4.41.0 (Feb 15, 2022)</u> .....	2913
<u>Bugfixes</u> .....	2913
<u>New features</u> .....	2913
<u>Release information 4.40.0 (Jan 18, 2022)</u> .....	2914
<u>Bugfixes</u> .....	2914
<u>New features</u> .....	2914
<u>Release information 4.39.0 (Dec 6, 2021)</u> .....	2915
<u>Bugfixes</u> .....	2915
<u>New features</u> .....	2915
<u>Release information 4.38.1 (Oct 25, 2021)</u> .....	2915
<u>Bugfixes</u> .....	2915
<u>Release information 4.38.0 (Oct 25, 2021)</u> .....	2915
<u>Bugfixes</u> .....	2916
<u>New features</u> .....	2916
<u>Release information 4.37 (June 29, 2021)</u> .....	2917
<u>Bugfixes</u> .....	2917
<u>New features</u> .....	2917

# Table of Contents

## Release Notes

<u>Release information 4.36 (May 19, 2021)</u> .....	2917
<u>Bugfixes</u> .....	2917
<u>New features</u> .....	2917
<u>Release information 4.35 (Apr. 9, 2021)</u> .....	2918
<u>Bugfixes</u> .....	2918
<u>New features</u> .....	2918
<u>Release information 4.34.1 (Feb. 5, 2021)</u> .....	2919
<u>Bugfixes</u> .....	2919
<u>Release information 4.34.0 (Jan. 25, 2021)</u> .....	2919
<u>New features</u> .....	2919
<u>Bugfixes</u> .....	2920
<u>Release information 4.33.0 (October 14, 2020)</u> .....	2920
<u>New features</u> .....	2920
<u>Bugfixes</u> .....	2920
<u>Release information 4.32.0 (September 1, 2020)</u> .....	2920
<u>New Features</u> .....	2920
<u>Bugfixes</u> .....	2921
<u>Release information 4.31.0 (June 28, 2020)</u> .....	2921
<u>New Features</u> .....	2921
<u>Release information 4.30.0 (Jan 16, 2020)</u> .....	2922
<u>Bugfixes</u> .....	2922
<u>New Features</u> .....	2922
<u>Release information 4.29.0 (July 5, 2019)</u> .....	2923
<u>Bugfixes</u> .....	2923
<u>New Features</u> .....	2923
<u>Release information 4.28.0 (June 15, 2018)</u> .....	2923
<u>Bugfixes</u> .....	2923
<u>New Features</u> .....	2923
<u>Release information 4.27.0 (Jan 4, 2018)</u> .....	2924
<u>Bugfixes</u> .....	2924
<u>New Features</u> .....	2924
<u>Release information 4.26.0 (Nov 19, 2017)</u> .....	2924
<u>Bugfixes</u> .....	2924
<u>New Features</u> .....	2924
<u>Release information (4.25.0) (June 28, 2017)</u> .....	2924
<u>Bugfixes</u> .....	2924
<u>New Features</u> .....	2924
<u>Release information (4.24.0) (January 20, 2017)</u> .....	2925
<u>Bugfixes</u> .....	2925
<u>New Features</u> .....	2925
<u>Release information (4.23.0) (October 21, 2016)</u> .....	2926
<u>Bugfixes</u> .....	2926
<u>New Features</u> .....	2926
<u>Release information (4.22.0) (August 26, 2016)</u> .....	2926
<u>Bugfixes</u> .....	2926
<u>New Features</u> .....	2926
<u>Release information (4.21.0) (June 27, 2016)</u> .....	2927



# Table of Contents

## Release Notes

<u>Bugfixes</u> .....	2927
<u>New Features</u> .....	2928
<u>Release information (4.20.0) (January 17, 2016)</u> .....	2928
<u>Bugfixes</u> .....	2928
<u>New Features</u> .....	2928
<u>Release information (4.19.0) (October 15, 2015)</u> .....	2929
<u>Bugfixes</u> .....	2929
<u>New Features</u> .....	2929
<u>Release information (4.18.0) (September 25, 2015)</u> .....	2929
<u>Bugfixes</u> .....	2929
<u>New Features</u> .....	2930
<u>Release information (4.17.0) (June 30, 2015)</u> .....	2931
<u>Bugfixes</u> .....	2931
<u>New Features</u> .....	2931
<u>Release information (4.16.0) (Mar 17, 2015)</u> .....	2932
<u>Bugfixes</u> .....	2932
<u>New Features</u> .....	2932
<u>Release information (4.15.0) (Nov 22, 2014)</u> .....	2933
<u>Bugfixes</u> .....	2933
<u>New Features</u> .....	2933
<u>Release information (4.14.0) (Oct 19, 2014)</u> .....	2933
<u>Bugfixes</u> .....	2933
<u>New Features</u> .....	2933
<u>Release information (4.13.0) (Jun 30, 2014)</u> .....	2934
<u>Bugfixes</u> .....	2934
<u>New Features</u> .....	2934
<u>Release information (4.12.0) (February 10, 2014)</u> .....	2935
<u>Bugfixes</u> .....	2935
<u>New Features</u> .....	2935
<u>Release information (4.11.0) (October 20, 2013)</u> .....	2936
<u>Bugfixes</u> .....	2936
<u>New Features</u> .....	2936
<u>Release information (4.10.0) (October 23, 2012)</u> .....	2937
<u>Bugfixes</u> .....	2937
<u>New Features</u> .....	2937
<u>Release information (4.9.1) (October 27, 2011)</u> .....	2938
<u>Bugfixes</u> .....	2938
<u>Release information (4.9.0) (October 26, 2011)</u> .....	2938
<u>Bugfixes</u> .....	2938
<u>New Features</u> .....	2938
<u>Release information (4.8.0) (June 26, 2011)</u> .....	2939
<u>Bugfixes</u> .....	2939
<u>New Features</u> .....	2939
<u>Release information (4.7.0) (December 2, 2010)</u> .....	2939
<u>Bugfixes</u> .....	2939
<u>New Features</u> .....	2940
<u>Release information (4.6.1) (Released only for demo and DxPed versions)</u> .....	2940

# Table of Contents

## **Release Notes**

<u>Bugfixes</u> .....	2940
<u>New Features</u> .....	2941
<u>Release information (4.6.0) (October 24, 2010)</u> .....	2941
<u>Bugfixes</u> .....	2941
<u>New Features</u> .....	2942
<u>Release information (4.5.2) (July 3, 2010)</u> .....	2947
<u>Bugfixes</u> .....	2947
<u>Release information (4.5.1) (June 27, 2010)</u> .....	2947
<u>Bugfixes</u> .....	2947
<u>Release information (4.5.0) (June 5, 2010)</u> .....	2947
<u>New Features</u> .....	2947
<u>Bugfixes</u> .....	2948
<u>Release information (4.4.0) (January 17, 2010)</u> .....	2948
<u>Bugfixes</u> .....	2948
<u>New Features</u> .....	2949
<u>Release information (4.3.0) (November 23, 2009)</u> .....	2950
<u>Bugfixes</u> .....	2951
<u>New Features</u> .....	2951
<u>Release information (4.2.0) (October 21, 2009)</u> .....	2952
<u>Bugfixes</u> .....	2952
<u>New Features</u> .....	2953
<u>Release information (4.1.0) (August 8, 2009)</u> .....	2954
<u>New Features</u> .....	2954
<u>Bugfixes</u> .....	2955
<u>Release information (4.0.1) (June 30, 2009)</u> .....	2956
<u>Bugfixes</u> .....	2956
<u>Release information (4.0.0) (June 26, 2009)</u> .....	2956
<u>New Features</u> .....	2956
<u>Namespaces</u> .....	2957
<u>Variants</u> .....	2957
<u>Views</u> .....	2957
<u>More</u> .....	2957

## **FAQ:Networking**.....**2959**

<u>Contents</u> .....	2959
<u>What is the Win-Test network protocol?</u> .....	2959
<u>In a networked environment, can we mix different versions of Win-Test?</u> .....	2959
<u>UDP error opening socket #10013 and #10038 Errors</u> .....	2959
<u>See also</u> .....	2960
<u>Namespaces</u> .....	2960
<u>Variants</u> .....	2960
<u>Views</u> .....	2960
<u>More</u> .....	2960

## **FAQ:User Interface**.....**2961**

<u>Contents</u> .....	2961
<u>How can I change the default window layout so that it is the same as it was in the last contest?</u> .....	2961

# Table of Contents

## **FAQ:User Interface**

<u>How can I save my CW messages so that they are the same ones I used the last time I entered this contest?</u> .....	2962
<u>How do I get the S&amp;P Messages to Work?</u> .....	2962
<u>Can I use "Insert Mode" in a serial number or exchange field?</u> .....	2962
<u>How can I change the font and background colors?</u> .....	2962
<u>How can I change threshold for off-time calculation?</u> .....	2963
<u>Is a log transfer between Win-Test and XXX (put your favorite logging software here) possible?</u> .....	2963
<u>Do I have to set my machine in UTC?</u> .....	2963
<u>I want to enter a post-contest log in Win-Test. How can I enter the date and the time of QSO?</u> .....	2963
<u>When I try to use the Parallel Port (LPT1), I get a message DLPortIO.DLL not loaded or DLPORIO.SYS not not found.....</u>	2963
<u>Windows NT, Windows 2000, Windows/XP.....</u>	2963
<u>32-bit Windows Vista or Windows 7.....</u>	2964
<u>64-bit Windows Vista, Windows 7, or Windows 8.....</u>	2965
<u>There are no messages, but the parallel port still doesn't work.....</u>	2965
<u>When using CW with WT, it sometimes chokes. What can I do?</u> .....	2965
<u>Can I define a new contest in Win-Test?</u> .....	2965
<u>During a contest, can I change a DXCC country "on the fly", like in CT where you say TO5X=FG?</u> .....	2965
<u>I have a question. What should I do?</u> .....	2965
<u>I asked a question directly to the author and I did not have an answer!</u> .....	2966
<u>I would like such and such features!</u> .....	2966
<u>Where can I read the archives of this mailing list you do not stop talking about?</u> .....	2966
<u>Namespaces.....</u>	2966
<u>Variants.....</u>	2966
<u>Views.....</u>	2966
<u>More.....</u>	2966

## **FAQ:Licensing.....2967**

<u>Contents.....</u>	2967
<u>I bought Win-Test on the web with my PayPal account since several days, but I haven't received any CD-ROM ! What's wrong ?.....</u>	2967
<u>I bought Win-Test on the web with my PayPal account since several days, but I haven't received my registration key ! What's wrong ?.....</u>	2967
<u>I received your automatic email, but my registration key is not in ! What's wrong ?.....</u>	2968
<u>I went to your registration page but the form requires a computer code. I totally dismantled my computer and I can't find it. Where is it located ?.....</u>	2968
<u>I am hosting a multi-op station with several machines. Do I need to buy a licence for each of them ?.....</u>	2968
<u>I personally own a Win-Test licence. Can I install Win-Test using my identifiers on the computer of my local radio club ?.....</u>	2968
<u>I personally own a Win-Test licence. Can I install Win-Test using my identifiers on the computer brought by my mates who come home for a multi-op effort ?.....</u>	2968
<u>I have registered the Win-Test licence to my personal call. Can I use it with a different callsign, like a vanity one?.....</u>	2968
<u>My local radio-club owns a Win-Test licence. As a member of this club, can I use its identifiers</u>	

# Table of Contents

## **FAQ:Licensing**

<u>to install and register Win-Test on my own computer?</u> .....	2969
<u>I have registered Win-Test on my desktop computer. Can I register it on my notebook (or my other computer), and if so, how to do it?</u> .....	2969
<u>I just upgraded to Win-Test V3. But my license is gone?</u> .....	2969
<u>Can I have a registered WT2 and a registered WT3 in the same installation directory?</u> .....	2969
<u>I asked a question directly to the author and I did not have an answer !</u> .....	2969
<u>Where can I read the archives of this mailing list you do not stop talking about ?</u> .....	2969
<u>See also</u> .....	2969
<u>Namespaces</u> .....	2970
<u>Variants</u> .....	2970
<u>Views</u> .....	2970
<u>More</u> .....	2970

# Main Page

From Win-Test Wiki

[Jump to navigation](#) [Jump to search](#)

## Win-Test Documentation

- This documentation is current to version 4.47
- This documentation can be [downloaded in PDF format](#).

### I. **Preface**

1. [Authors and contributors](#)

### II. **Installation**

1. [Download the software](#)
2. [Install the software](#)
3. [Registering the software](#)

### III. **Configuration**

1. [One-time configuration](#)
  - ◇ [Interface configuration](#)
  - ◇ [DX Cluster configuration](#)
  - ◇ [Rotator configuration](#)
  - ◇ [RTTY configuration](#)
  - ◇ [Setting up networking](#)
  - ◇ [Category:BestPractice](#)
2. [Pre-contest configuration](#)

### IV. **Running a contest**

1. [Logging OSOs](#)
2. [SO1R](#)
3. [SO2R](#)
4. [Multi-op](#)
5. [Contest-specific behaviour](#)
6. [Posting live score on-line](#)
7. [Post-contest specifics](#)

### V. **Menus**

1. [File \(without a Win-Test file opened\)](#)
2. [File \(with a Win-Test file opened\)](#)
3. [Edit](#)
4. [Operating](#)
5. [Commands](#)
6. [Messages](#)
7. [Tools](#)
8. [Windows](#)
9. [Options](#)
10. [Help](#)

### VI. **More...**

1. [Icon bar](#)
2. [Text commands](#)
3. [Keys](#)
4. [Message variables \(aka macros\)](#)
5. [Supported contests](#)
6. [Supported rigs](#)

7. [Supported accessories](#)
8. [Check Partial and N+1 Files](#)
9. [Database files](#)
10. [Other files...](#)
11. [Release notes](#)
12. [Release notes \(old version 3 archive\)](#)

#### VII. **Frequently Asked Questions (FAQ)**

1. [Problems registering and running](#)
2. [DX Cluster and wtDxTelnet](#)
3. [Rotator control and wtRotators](#)
4. [User interface](#)
5. [Networking](#)
6. [Licensing issues](#)

#### VIII. **See also**

- ◆ [Win-Test installation, registration and configuration guide](#)
- ◆ [Win-Test quick start manual](#) — for Win-Test 3.11.0 (slightly outdated)
- ◆ [Win-Test mailing list](#)

## Namespaces

- [Main page](#)
- [Discussion](#)

## Variants

## Views

- [Read](#)
- [View source](#)
- [View history](#)

## More

- This page was last edited on 5 April 2020, at 16:54.

- [Privacy policy](#)
- [About Win-Test Wiki](#)
- [Disclaimers](#)



# Preface

From Win-Test Wiki

[Jump to navigation](#) [Jump to search](#)

The Win-Test wiki documentation project was originally started as an additional source of information for Win-Test users. As time progressed, more and more Win-Test users assisted and the wiki as seen now is the culmination of many people's contributions to the project. A big thank you to everyone who has helped!

## Mailing list

An email-based [mailing list](#) exists for Win-Test users. This is the **primary source** for support. The Win-Test community are very helpful and the Win-Test developers are also very active on the reflector. It is highly recommended all Win-Test users subscribe. Please do not contact the Win-Test developers directly - they have private lives and your email may well be overlooked, missed or ignored if you do so.

## Namespaces

- [Page](#)
- [Discussion](#)

## Variants

## Views

- [Read](#)
- [View source](#)
- [View history](#)

## More

- This page was last edited on 27 December 2023, at 01:15.
- [Privacy policy](#)
- [About Win-Test Wiki](#)
- [Disclaimers](#)



# Installation

From Win-Test Wiki

[Jump to navigation](#) [Jump to search](#)

**Attention:** For detailed screen shots describing how to purchase, download, install, register, and configure Win-Test, please review the *Win-Test Installation, Registration, and Configuration Guide* by following one of the links on the [FAQ Page](#).

## Download the software

Win-Test is provided as a trial version, free to use for 15 days. You can download it from <http://www.win-test.com>.

The trial version randomly quits, between 30 minutes and 2 hours after startup, and exported files (Cabrillo, Reg1test, ADIF) are limited to 50 QSOs.

If you wish to use Win-Test without these limitations, or if the 15-day trial period has expired, you can [purchase a licence](#) and register the software for a fee of 50 EUR.

One licence entitles you to use Win-Test on an unlimited number of computers. However, registration keys must be provided on each computer which can be requested [here](#).

If you fail to receive an email with your registration details, please check your spam folder. Occasionally, Win-Test emails end up in spam due to the content of the email being written in three different languages.

Should you have any issues, please use the [mailing list](#) for further support.

## Install the software

Install the software in a directory on your harddisk you like, normally in

```
C:\Program Files (x86)\Win-Test.
```

You can install new versions over a previous version. If you upgrade to a new major version (like from V3 to V4) your old registration key will become invalid and you'll have to acquire a new one.

Although a Windows program, some have managed to get Win-Test [running on Linux](#) in a Windows Emulator called wine on Linux.

## Registering the software

You can register the software [here](#).

After you have entered your registration details, you will *not* see a "thanks for registering" dialog or such-like; however, you can confirm registration was successful by restarting Win-Test and if all went well, you will no longer have to press the [1], [2], or [3] buttons.



## Namespaces

- [Page](#)
- [Discussion](#)

## Variants

## Views

- [Read](#)
- [View source](#)
- [View history](#)

## More

- This page was last edited on 11 April 2023, at 15:15.

- [Privacy policy](#)
- [About Win-Test Wiki](#)
- [Disclaimers](#)



# Configuration

From Win-Test Wiki

[Jump to navigation](#) [Jump to search](#)

Articles on how to configure Win-Test...

## One-time configuration

Some of Win-Test's configuration only needs to be done once and is saved for future contests. This includes:

### Interface configuration

*How to control your rig, CW keyer, DVK, SO2R interfaces etc.*

### DX Cluster configuration

*How to connect Win-Test to DX Clusters, CW Skimmer, or TNCs using **wtDxTelnet***

### Rotator configuration

*How to connect Win-Test to your rotators using **wtRotators***

### RTTY configuration

*How to set up Win-Test for RTTY*

### Networking

*How to set up Win-Test networking in a multi-op environment*

### Win-Test Initialization file

*Changing Win-Test default parameters in WT.INI file*

## Pre-contest configuration

A description of what one needs to do prior to the start of each contest with Win-Test:

1. Create a new log for the contest - Also describes how to re-open an existing log and how enable automatic loading of a log when Win-Test starts
2. Download the latest country file - Select CTY\_WT\_MOD.DAT instead of CTY.DAT for best results
3. Install the latest super-check partial file (MASTER.SCP)
4. Set up DX cluster access
  1. Via telnet
  2. Via packet radio (TNC)
5. Program Digital Voice Keyer (DVK), CW and RTTY messages
6. Position windows and set fonts
7. Install contest-specific databases for exchange guessing (optional)
8. Load contest objectives (optional)
9. Interface HamCAP (optional)

## Namespaces

- [Page](#)
- [Discussion](#)

## Variants

## Views

- [Read](#)
- [View source](#)
- [View history](#)

## More

- This page was last edited on 9 December 2016, at 23:43.

- [Privacy policy](#)
- [About Win-Test Wiki](#)
- [Disclaimers](#)



# Menus

From Win-Test Wiki

[Jump to navigation](#) [Jump to search](#)

## Contents

- [1 File](#)
- [2 Edit](#)
- [3 Operating](#)
- [4 Commands](#)
- [5 Messages](#)
- [6 Tools](#)
- [7 Windows](#)
- [8 Options](#)
- [9 Help](#)

## File

*Without a Win-Test file opened...*

- [New...](#)
- [Open...](#)
- [Import](#)
  - ◆ [Editest...](#)
  - ◆ [Cabrillo...](#)
- [Export](#)
  - ◆ [WT Version2...](#)
- [Merge logs...](#)
- [Clean log...](#)
- [Quit](#)

*With a Win-Test file opened...*

- [New...](#)
- [Open...](#)
- [Close...](#)
- [Create log files](#)
- [Backup Contest](#)
- [Update database](#)
- [Quit](#)

## Edit

- [Restore QSO](#)
- [Initialize QSO](#)
- [QSO date and time](#)
- [Edit serial number](#)

- [Delete QSO](#)
- [Delete all QSO...](#)
- [Goto QSO](#)
- [Move in my log only](#)

## **Operating**

- [Listen to the primary radio](#)
- [Listen to the secondary radio/headphone toggle](#)
- [Listen to the secondary radio during transmit/headphone latch](#)
- [Listen both radio/headphone split](#)
- [Revert to automatic control](#)
- [Technique](#)
- [Modify the scenarios](#)
- [Shift binds to the secondary radio](#)
- [The second footswitch binds to the secondary radio](#)

## **Commands**

- [QSY](#)
- [Keyboard mode](#)
- [CW Speed...](#)
- [CW weight...](#)
- [Carrier](#)
- [Split frequency](#)
- [QSY frequency](#)
- [QSY to run frequency](#)
- [Swap the frequency on both radios](#)
- [Take a sked](#)
- [Pass a station](#)
- [Copy-paste the previous QSO](#)
- [Receive QTC](#)
- [Transmit QTC](#)
- [DX-Cluster](#)
- [Spot](#)
- [Propagation forecast](#)
- [Insert into BandMap](#)
- [Active Radio](#)
- [Station Type](#)
- [CW Messages](#)

## **Messages**

- [Send a gab...](#)
- [Reply to the last private gab...](#)
- [Write a note regarding this QSO](#)

## **Tools**

- [Automatic CQ repeat](#)
- [Redefine keyboard keys](#)
- [Data entry](#)
- [Load an target file](#)
- [Export an target file](#)
- [Check log](#)

## **Windows**

- [Worked Gridsquares](#)
- [Worked Zones](#)
- [Worked DXCC](#)
- [Check Multipliers](#)
- [Search for Worked Multipliers](#)
- [Check Partial](#)
- [Check N + 1](#)
- [Status](#)
- [Skeds](#)
- [Summary](#)
- [Rate](#)
- [Statistics](#)
- [Gab](#)
- [World Map](#)
- [Radio 1](#)
- [Radio 2](#)
- [DX-Cluster Monitor](#)
- [DX-Cluster Announcements](#)
- [Clock](#)
- [SSB bargraph](#)

## **Options**

- [Load contest at startup](#)
- [Automatic backup...](#)
- [Disable log synchronization on network](#)
- [CW](#)
- [Configure interfaces...](#)
- [WinKey configuration...](#)
- [EZMaster configuration...](#)
- [RTTY configuration...](#)
- [Log](#)
- [Spots warnings](#)
- [DX cluster shortcuts](#)
- [HamCAP](#)
- [WAEDC](#)
- [Data files](#)
- [Bandplans...](#)

- [Windows](#)
- [Toolbar](#)
- [Language](#)

## **Help**

- [Register software](#)
- [Use online manual](#)
- [Reference manual](#)
- [About](#)

## **Namespaces**

- [Page](#)
- [Discussion](#)

## **Variants**

## **Views**

- [Read](#)
- [View source](#)
- [View history](#)

## **More**

- This page was last edited on 9 December 2016, at 23:43.

- [Privacy policy](#)
- [About Win-Test Wiki](#)
- [Disclaimers](#)



# Menu:File new

From Win-Test Wiki

[Jump to navigation](#) [Jump to search](#)

## Menu:File (without a file opened)

### Contents

- [1 New](#)
- [2 Contest Configuration](#)
  - ◆ [2.1 Station Parameters](#)
  - ◆ [2.2 Contest Parameters](#)
  - ◆ [2.3 Network Parameters](#)
- [3 Open](#)
  - ◆ [3.1 Corrupted Files](#)
- [4 Import](#)
- [5 Export](#)
- [6 Merge Logs](#)
- [7 Clean log](#)
  - ◆ [7.1 Cleaning](#)
  - ◆ [7.2 Time Shift](#)
  - ◆ [7.3 Resolving 10-Minute-Rule Violations](#)
- [8 Quit](#)

### New

You may use `File | New . . .` to create a new log file.

**Note:** Since Win-Test stores most CW/RTTY messages and window positions in each log file, it is usually more convenient to copy an old Win-Test log file of the same contest type, rather to use the method described below. When you create a brand new log file with Win-Test, it resets all CW/RTTY messages and Window positions to Win-Test defaults, and these may not represent your personal preferences.

Win-Test first shows the contest configuration screen, which is described in detail in the [Contest Configuration](#) section below.



# Win-Test Wiki

**Contest configuration** ✖

**Station**

Callsign:  Locator:  Exchange (zone, ...):   ?

DXCC Prefix:  WAZ zone:  ITU zone:  State/Province/Other:

Name:

Address:

Address:

Address:

Club:

**Load**

**Save as**

**Contest**

Contest:    This month only

Category:  Mode:

Overlay:  Band plan:

Class:  Power:

Operators:

**Network**

Station:   Enable time distribution across the network

Contest Configuration screen

After selecting a contest type and clicking the **OK** button, Win-Test automatically generates a new file name based on the type, mode, year, callsign, etc. Win-Test then displays the following dialog box, which you may use to change the generated name and subdirectory. The default extension for Win-Test log files is .wt4, which should not be changed. (Win-Test 3 used .wtb as the file extension, which stood for "Win-Test binary".)

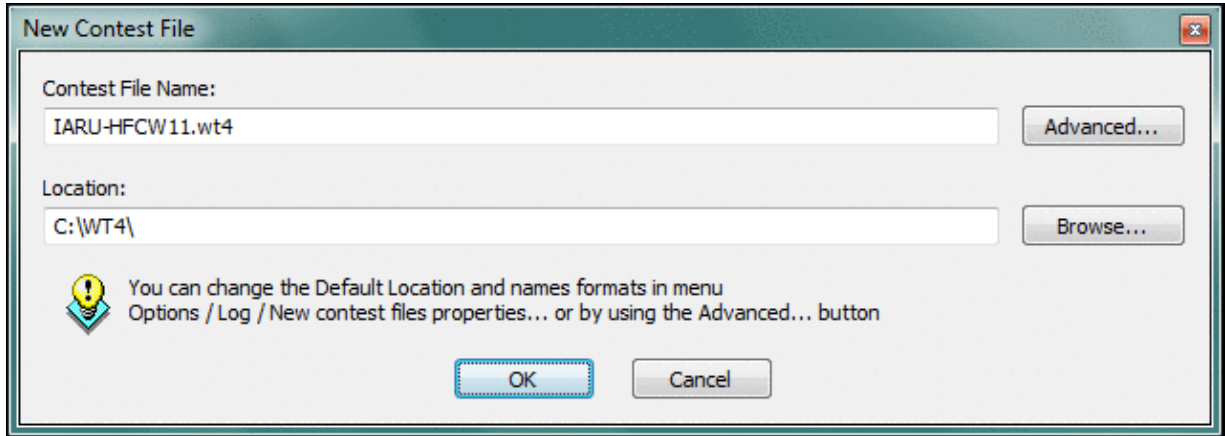

Dialog allowing you to customize the name and location of your log file

**Note:** For a multi-op setup, do *not* put log files on a shared network drive. Each computer must use its own local log file, stored on its own local hard disk drive. Log data will be automatically shared and synchronized between computers (when enabled) across the local network by Win-Test.

To change the default location and naming convention, click the **Advanced...** button and refer to the legend displayed at the bottom of the dialog, as shown below:

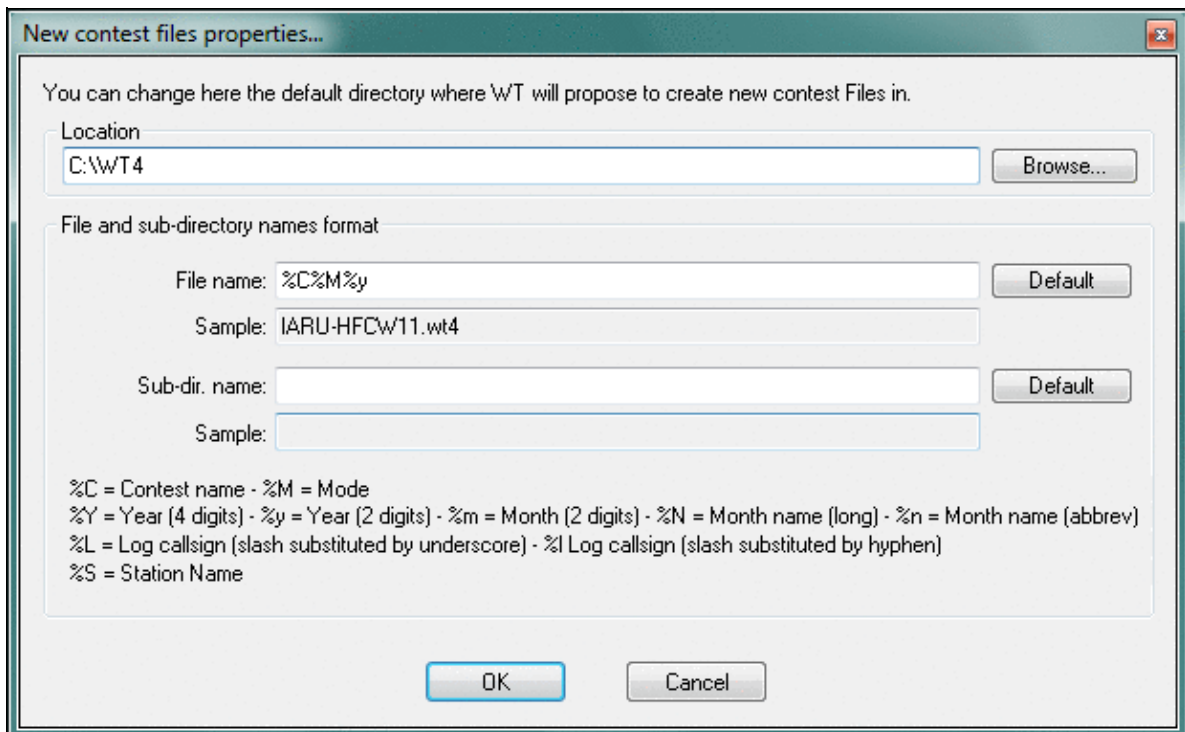

Use this dialog to change the default naming convention and location of your Win-Test log files. By default, Win-Test creates a new sub-directory for every contest type. If you wish to have all of your logs stored in the *same* directory, leave the **Sub-dir. name** field blank, as shown above.

## Contest Configuration

After selecting **New**, **Open**, or entering the **REOPEN** text command when a log is already open, the contest parameters are shown in the following dialog box:

The screenshot shows the "Contest configuration" dialog box with the following fields and options:

- Station**
  - Callsign:  Locator:  Exchange (zone, ...):    - DXCC Prefix:  WAZ zone:  ITU zone:  State/Province/Other:
  - Name:
  - Address:
  - Address:
  - Address:
  - Club:
- Load**
  -
- Save as**
  -
- Contest**
  - Contest:    This month only
  - Category:  Mode:
  - Overlay:  Band plan:
  - Class:  Power:
  - Operators:
- Network**
  - Station:   Enable time distribution across the network

Buttons:

## Contest configuration parameters

**Station Parameters**

- **Callsign:** The one used during the contest. Do not specify the departement (REF contest), or the zone number in this field ! On the other hand, the potential /P, /M or /MM must be specified.
- **Locator:** Mandatory for a VHF contest. Optional but useful for an HF contest (this will allow to get accurate beam headings or sunrises/sunsets). To determine your locator, go to <http://f6fvy.free.fr/qthLocator/fullScreen.php>, find your location on the interactive map, and click on it to display your grid square number.
- **Exchange:** Type your zone, your state, your department... according to the contest you will run. For example, for a CQWW DX contest, specify your WAZ zone. Let this box empty if the sent report is a serial number (for the WPX, for example). If there is a domestic and a DX side in the contest, specify DX if it is your case. Press the button with the "?" symbol to get more information.
- **DXCC prefix:** Standard prefix of your DXCC country. This information is used only for live score reporting, so you may leave that open.
- **WAZ zone:** Your WAZ zone. This information is used only for live score reporting, so you may leave that open.
- **ITU zone:** Your ITU zone. This information is used only for live score reporting, so you may leave that open.
- **State/Province/Other:** Your state, province or other regional designator. This information is used only for live score reporting, so you may leave that open.
- **Name:** Name of the callsign's owner.
- **Address:** You have 3 free lines to give the address of the station. Keep the last one to specify your zip code and town, as well as your country for an international contest.
- **Profiles:** You can save up to five different station profiles. Profiles are a set of station information (Callsign, Name, Address, etc.) that can be reused when necessary; they allow quick Win-Test setup for operators that frequently change their contest call, or go to DXpeditions, or operate on a multi-op team. Profiles are saved in specific sections in the `wt.ini` file.
  - ◆ **Load:** click the button to load the previously-saved station profile
  - ◆ **Save as:** click the button to create a Station profile. To *rename* or reuse a station profile, [**Shift**]+**click** on the button and follow the prompts.

**Contest Parameters**

- **Contest:** The contest to run. Multipliers, dupe checking, points scoring etc... will depend on this choice. Please be careful! Regarding VHF contests, Win-Test supports 2 "generic" contests: "European VHF" and "European VHF (gridsquare counting as multiplier)". These 2 contests will be compatible with the vast majority of the minor contests having the same scoring system.
- **Category:** Choose the category in which you will participate. Check in the rules that the corresponding category really exists in the specified contest! Win-Test does not check for the existence of a specific category against the current contest rules.
- **Overlay:** Some contests rules show overlays (like Rookie). Check in the rules that the corresponding overlay really exists in the specified contest!
- **Mode:** Choose the mode in which you will participate. Selecting **MIXED** will allow you to switch between SSB and CW. If you also wish to have digital modes, select **ALL**. Check the rules if the corresponding mode really exists in the specified contest!
- **Band plan:** Select a contest-specific band plan or leave the Default one. For more details, please see [Options | Bandplans...](#)
- **Power:** Your effective power, compulsory for the ARRL DX, on the DX side. Use only numbers, figures like **5** or **100**, but do not specify watts! If you are allowed to transmit more than 1 kW,

specify **KW**.

- **Class:** Choose the power class.
- **Operators:** Put the operators' callsigns here. For strict compatibility with the Cabrillo format, please leave a blank space between each listed callsign.

## Network Parameters

The following parameters make sense only in a networked Win-Test environment.

- **Station name:** All computers in the network must have different names. Use descriptive names to easily recognize a computer in the status window. To prevent any side effect (especially on the network), the syntax of the station name is checked, and 'exotic' characters are replaced by an underscore if needed.
- **Enable time distribution in network:** In order to synchronize the timestamps of all logged QSOs, *one and only one* computer should be defined as **time master** by checking this box.

## Open

Opens a log file in the Win-Test format (.wt4 for Win-Test version 4, .wtb for Win-Test 3).

There is no need to close the file already in use. The new file will take its place.

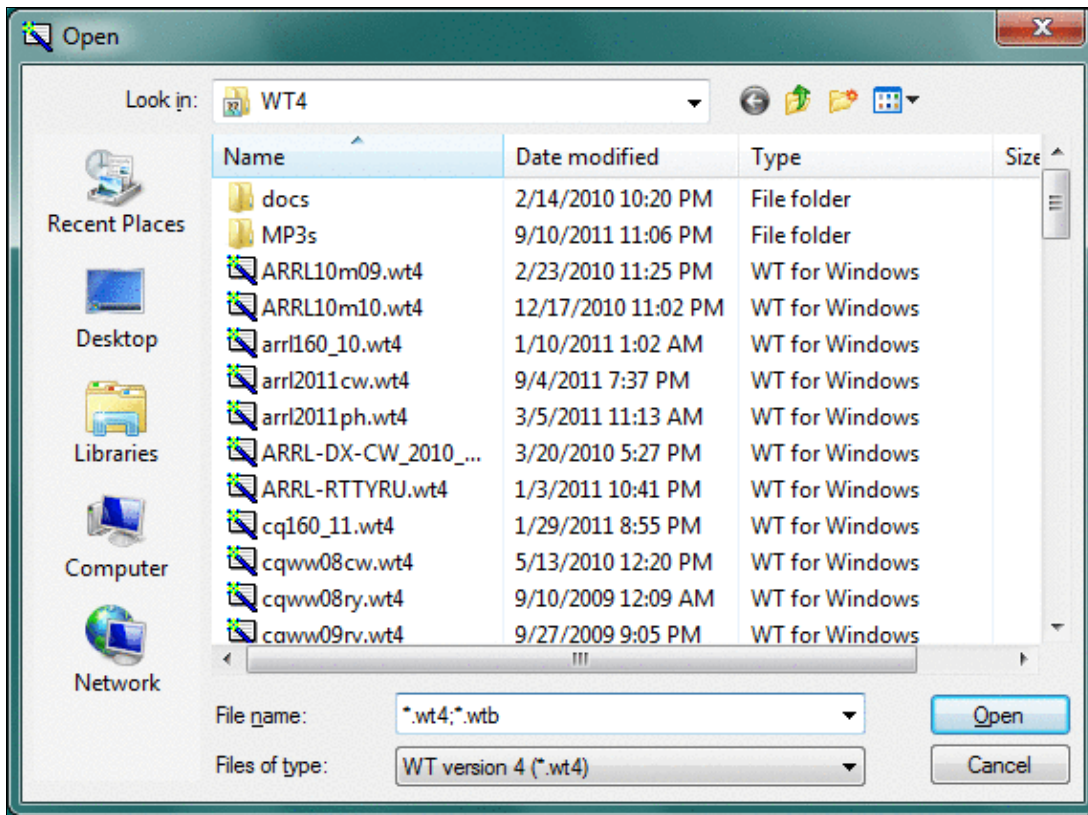

Opening a Win-Test binary log file

After choosing the file, the contest configuration dialog appears:

**Contest configuration**

Station

Callsign:  Locator:  Exchange (zone, ...):   ?

DXCC Prefix:  WAZ zone:  ITU zone:  State/Province/Other:

Name:

Address:

Address:

Address:

Club:

Load

Save as

Contest

Contest:    This month only

Category:  Mode:

Overlay:  Band plan:

Class:  Power:

Operators:

Network

Station:   Enable time distribution across the network

Contest configuration screen

You can then modify these parameters, if needed, before starting to log contacts. See the [Contest Configuration](#) section above for more information.

A progress bar is then displayed as the log file is loaded, as well as information about data base files associated with the contest.

## Corrupted Files

Should your file have been corrupted by any means, Win-Test will automatically open up a dialog to fix the error.

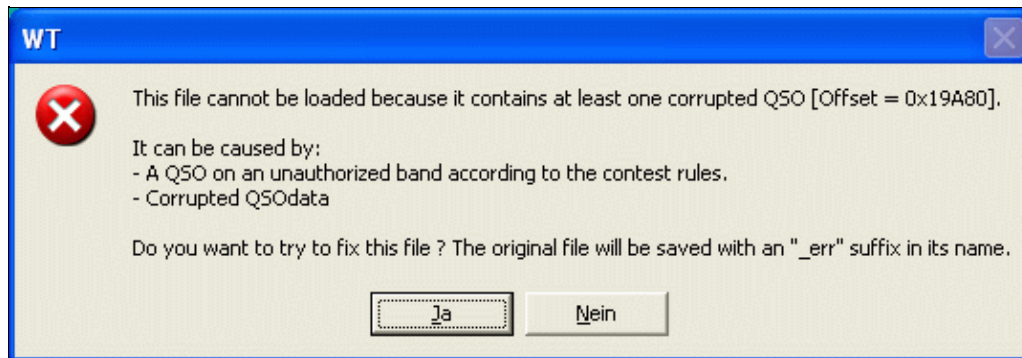

Fix Errors Dialog. Make sure you know what you're doing

The original log will be saved under the original name with an **\_err** suffix before the .wt4 extension.

The fix will most probably delete the QSO records in question to allow for a clean log. Make sure you know what you're doing and be sure to have a backup of the original! Fixing the file is only possible in some cases. For example, when you inadvertently opened a v3 Win-Test file with Win-Test version 2, you are at a loss (see <http://www.f5mzn.org/pipermail/support/2006-November/072424.html>).

## Import

Allows to import logs from Editest or Cabrillo format to Win-Test format.

Furthermore, after importing the log file, you can immediately load this file in Win-Test, by checking the appropriate box.

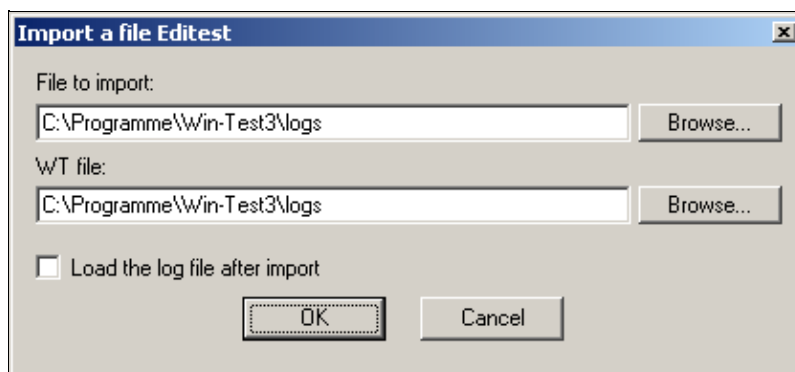

## Editest Import

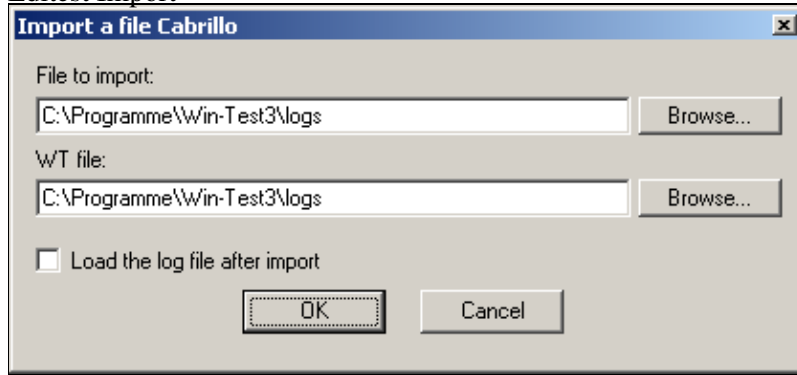

### Cabrillo Import

Of course, the original file is not modified.

## Export

Provides a way to export a Win-Test version 4 (.wt4) log into an Win-Test version 3 (.wtb) file format. The former Editest format is no longer supported for export.

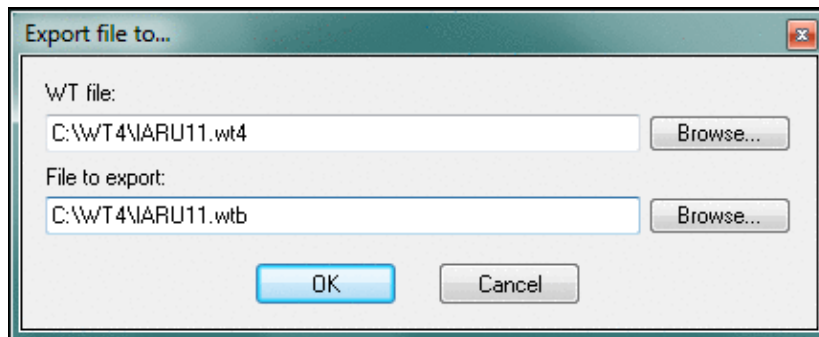

### Export to Win-Test version 3 format

The original .WT4 file is not modified.

## Merge Logs

Merging is the process of manually bringing two or more (partly) separate log files together.

Useful in a multi-operator Win-Test LAN, this menu allows to merge the logs issued from different computers. You can thus gather all the QSO in a unique file (named "master"), which has to be the first added to the list. The original file will be automatically saved before any modification (.bak).

Since Win-Test version 3, with networking and log synchronization, this should no longer be necessary. A valid scenario, however, could be a DXpedition, where several computers run independently, without a network backbone and a complete log has to be created on a day-by-day basis and distributed to all stations for completeness and redundancy or uploaded as an on-line-log.



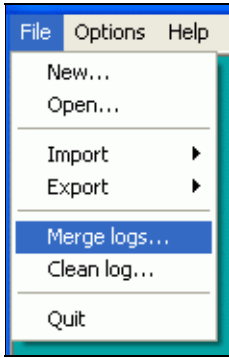

Start up the merge dialog; this menu item is visible only when no WT file is open

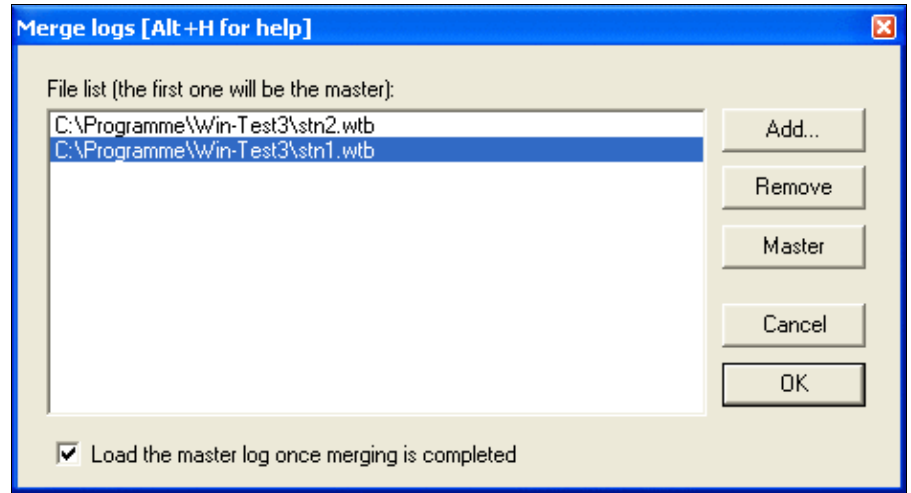

Now select the files to be merged

Merging Logs is done in six steps:

1. Close the current log
2. Collect all log fiels to be merged on your computer
3. Go to **File | Merge logs...**
4. Select all the log files you would like to merge
5. Select the file that should become the master file
6. Press OK to start merging

Win-Test will read QSO data from all the files and incorporate them into the designated master log file, removing any duplicate contacts. Optionally, you may chose to load the master log file after the merge process has finished.

This menu is only visible if no file is opened. If a log is opened, just close it by the **File | Close** menu or the **CLOSE** text command.

**Note:** If you have changed a QSO in a partial file and the unchanged QSO is still contained in another log that is being merged, you will end up with both the changed and the unchanged QSO in the final log.

**Note:** Win-Test will not allow merging logs from different contests.

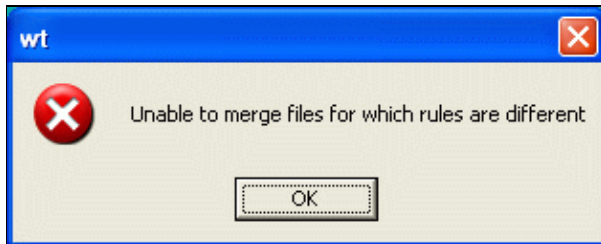

Files from different contests cannot be merged

## Clean log

### Cleaning

This function removes QSOs logged with your own callsign. It can also remove duplicate QSOs.

The recommended way to remove QSOs during a contest is to overwrite them with your own callsign. Later, after the contest, you can delete these QSOs from the log. Win-Test allows you to do that very easily via a menu item. QSOs with own callsign are ignored by WÅ–n-Test both for multiplier and QSO point credit during the contest.

**First, close the log** via **File | Close** or the **CLOSE** command. The Clean Log item is only visible, in the File menu, when the log is closed.

Then from the menu choose **File | Clean log**.

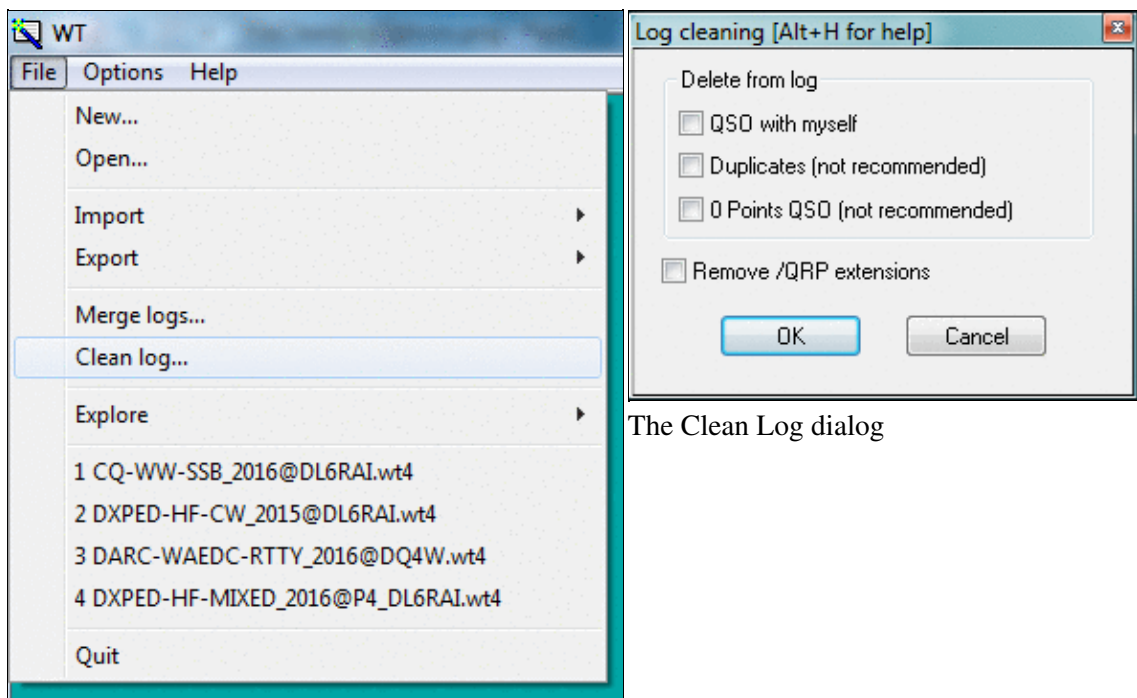

The Clean Log dialog

The Clean Log menu item

When you select Clean Log, Win-Test prompts you to select the log file you want to clean. Next the Clean Log dialog prompts you choose the actions you want to perform:

- to delete QSOs with yourself (good, these should be QSOs marked for deletion)
- to delete all duplicate QSOs (bad idea)
- to delete all zero point QSOs
- to remove any "/QRP" extensions (generally OK).

Please refer also to the [Multi-op/Deleting\\_QSO](#) chapter.

**Warning:** Contest sponsors advise to not delete duplicate QSOs from your log. In fact, if the other station did not correctly get your callsign during the first QSO, this QSO will be lost! The log checking software used by contest sponsors never penalizes a log for dupes, so it is OK to leave them in your log.

## Time Shift

This feature allow to move your log, or a portion of it, ahead or back in time. It is comparable to the CT\_TIME.EXE utility supplied with CT, back in the old days, and it has been extended in fuctionality.

For complete details please refer to [Menu:Tools Time shifting](#) in this manual.

## Resolving 10-Minute-Rule Violations

This is a typical Multi-OP item. Please see [Multi-op/Issues/Non Multipliers](#) for more information about this topic.

## Quit

Closes the current file and quits Win-Test back to the Windows environment.

[Back to Menus](#)

## Namespaces

- [Page](#)
- [Discussion](#)

## Variants

## Views

- [Read](#)
- [View source](#)
- [View history](#)

## More

- This page was last edited on 17 December 2016, at 17:53.

- [Privacy policy](#)
- [About Win-Test Wiki](#)
- [Disclaimers](#)



# Menu:File open

From Win-Test Wiki

[Jump to navigation](#) [Jump to search](#)

## Menu:File (with a file opened)

### Contents

- [1 New](#)
- [2 Open](#)
- [3 Close](#)
- [4 Create Log Files](#)
- [5 Backup contest](#)
- [6 Archive](#)
- [7 Update database](#)
- [8 Explore](#)
- [9 Most Recently Used](#)
- [10 Quit](#)

### New

This will create a new Win-Test file. Please see [elsewhere](#) for a detailed description.

### Open

This will open an existing Win-Test file. Please see [elsewhere](#) for a detailed description.

### Close

Closes the current file, but remains in the Win-Test environment. The way to switch logs without having to restart Win-Test.

### Create Log Files

Text command shortcut: **WRITELOG**

Creates log files to be sent to the contest organizer for checking (usually Cabrillo), or to import into your personal log book software. Note that not all formats are available for all contests.

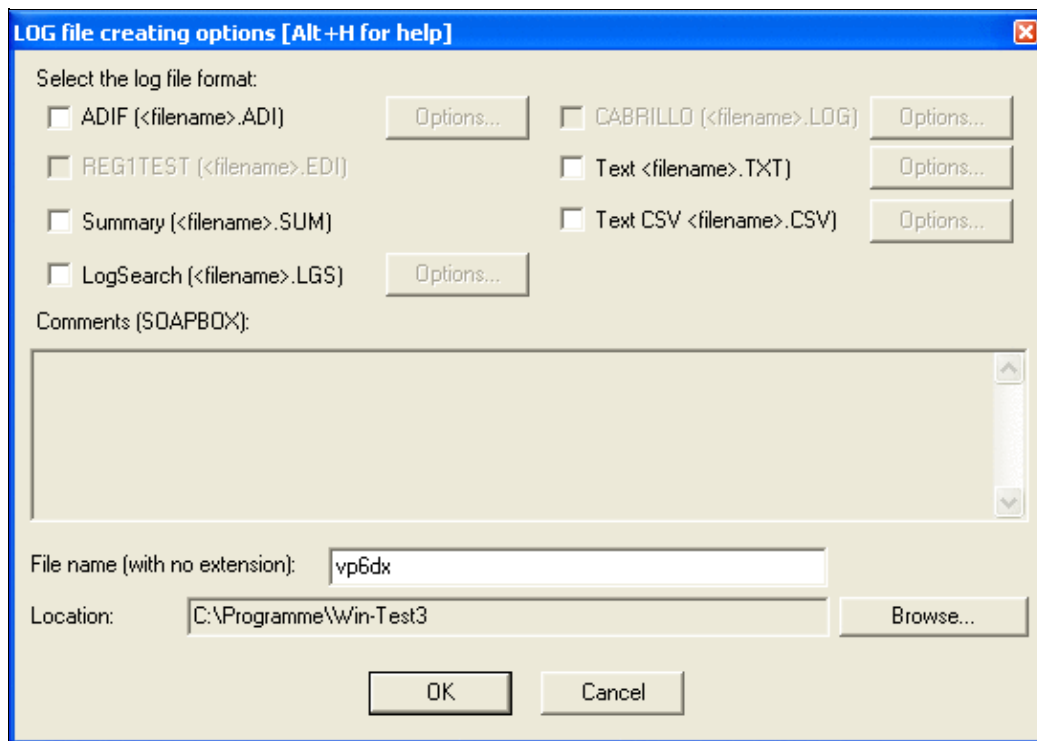

The "Create Log Files..." dialog box

Select the files to be created, optionally add comments (soapbox), and specify a name to be used for the files. You may also specify a target directory path that is different than the log file directory

For more details, please see [Creating](#).

## Backup contest

Saves a copy of the complete log file in a backup directory, which has to be specified in the **Options | Automatic backup** dialog. If this directory is embedded in a floppy disk, it has to be present in the drive A: while executing this command. The file will have an additional **.bak** extension (**test.wtb.bak** for example). To use this backup file, just rename the file without the **.bak** extension.

**Warning:** A 1.44" MB floppy disk will accept no more than approximately 7,000 QSOs!

## Archive

Creates a timestamped zipped file in the log directory of the files related to the current log that are selected. Warning: Archiving audio recordings file that are usually pretty large can take a while... be patient!

When archiving, the full path of the generated zip file is copied to the clipboard.

## Update database

Allows to enrich the database of the contest with the datas from your log. If a callsign already exists in the database, the attached datas in your log may replace those in the database. If the callsign does not exist, it will be added, with its attached datas.

## Explore

Comfortably open the Windows Explorer in one of Win-Test's directories.

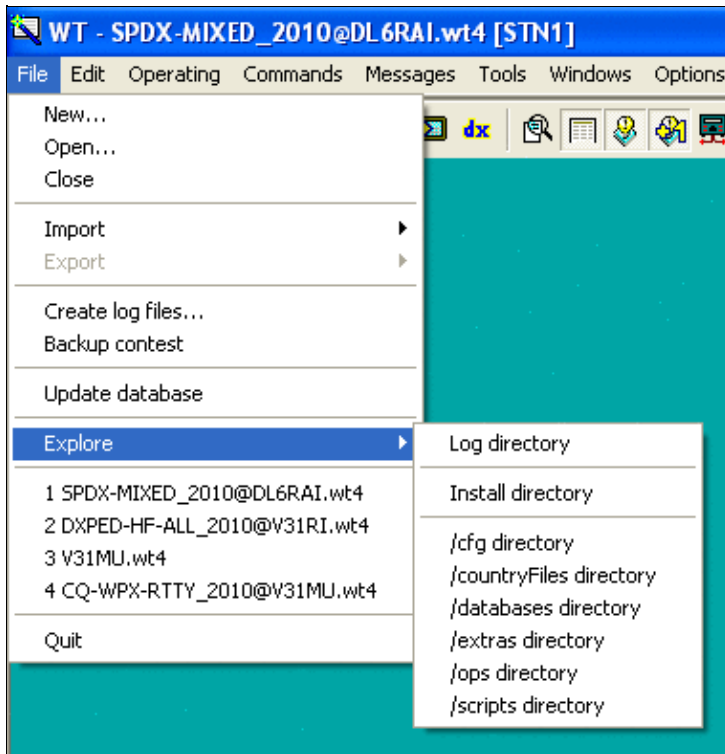

The "File | Explore" dialog box

### Most Recently Used

The next menu block lists the last four most recently opened files. This will let you switch between files quickly.



Most recently used Files List

### Quit

This selection will Quit Win-Test and will bring you back to the Windows environment. Before using this command, **don't forget** to complete your last QSO!

[Back to Menus](#)

## Namespaces

- [Page](#)
- [Discussion](#)

## Variants

## Views

- [Read](#)
- [View source](#)
- [View history](#)

## More

- This page was last edited on 10 April 2023, at 07:04.

- [Privacy policy](#)
- [About Win-Test Wiki](#)
- [Disclaimers](#)





# Menu:Edit

From Win-Test Wiki

[Jump to navigation](#) [Jump to search](#)

## Menu:Edit

### Contents

- [1 Restore QSO](#)
- [2 Initialize QSO](#)
- [3 Edit Date, Time, Freq. and Op. of QSO...](#)
- [4 Edit serial number](#)
- [5 Delete QSO](#)
- [6 Delete all QSO...](#)
- [7 Goto QSO...](#)
- [8 Goto Callsign...](#)
- [9 Apply exchange to every QSO with...](#)
- [10 Move in my log only](#)

### Restore QSO

Shortcut: **Ctrl-Z**. Allows you to restore all the original data of a QSO you are modifying. Of course, the QSO you are modifying must already be logged before you use this command. It is most useful if you accidentally change something on a prior QSO, and wish to restore it.

### Initialize QSO

Shortcut: **[F11]** or **Alt-W**. Erases all the fields of the current QSO if it has not been confirmed. However, this key will not delete a QSO that has already been logged with **[Enter]**!

However, the best way to "delete" a QSO is to do it after the end of the contest, in the final log files. Otherwise, you can enter your own callsign instead (and clear it afterwards with [File Clean log...](#)), but this may create errors in the multipliers list. A better way is to duplicate the previous QSO, on the same band. It will be one more dupe QSO, but the points and the mutipliers will be correct.

### Edit Date, Time, Freq. and Op. of QSO...

Shortcut: **Alt-F**. Allows you to modify the date, time, frequency and operator of an already logged QSO. Note that you can only change the frequency on the same band. If you need to change bands, use **Alt+F1** or **Alt+F2** (see [QSY](#)).

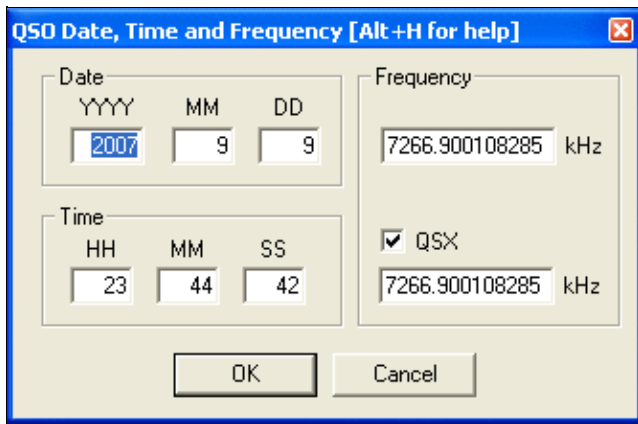

Editing QSO date and time and frequency

**Warning:** After a modification, Win-Test does not sort the logged QSO by time. The logging sequence by numbers is kept.

If you need to move your log, or a portion of it, ahead or back in time, please refer to the Tools [time shifting](#) feature in this manual.

## Edit serial number

This opens the edit serial dialog box. Here you can change your sent serial number.

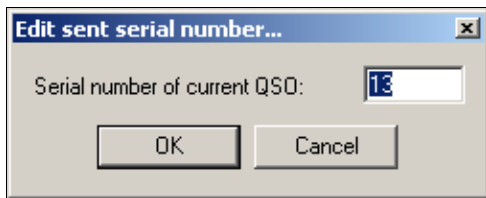

Editing the serial number

## Delete QSO

Permanently deletes a QSO in the log. As noted below, this command is irreversible. Note that you cannot delete QSOs unless log synchronization is disabled (see [Options | Disable log synchronization on network](#)).

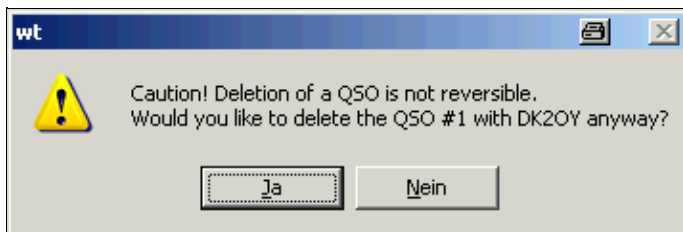

Deleting A QSO from the log. This feature is not supported when log synchronization is enabled, such as in a multi-computer network.

However, the best way is to make a note via **Alt-N**, then delete the QSO after the end of the contest, in the Win-Test file or the Cabrillo/ADIF files. Another option is to enter your own callsign in the logging window, then remove it after the contest with File | Clean log...

Yet another option is to duplicate the previous QSO. It will be one more dupe QSO, but the points and the multipliers will be correct.

## Delete all QSO...

Equivalent text command: **CLEARLOG**.

See also the **CLEARLOGNOW** and **COPYLOGCLEAR** text commands, which may be more convenient if you understand what they do.

This command deletes all the QSOs in the current opened file. Of course, as this should be rather unusual, you need to confirm the command.

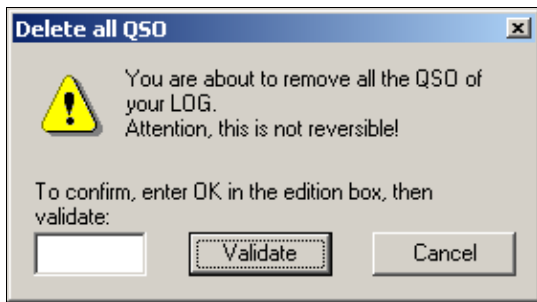

Deleting all QSOs

You need to literally type **OK** (uppercase) in the box, and then press **[Validate]** to delete all QSOs.

## Goto QSO...

Presents the dialog allowing to go directly to a QSO (if you know its number).

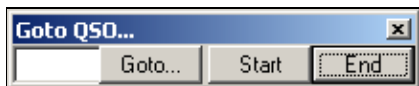

Goto QSO

With the two labelled buttons, you can locate the cursor at the beginning or at the end of the log. Same action will result by typing **START** (or **FIRST**) and **END** (or **LAST**) in the callsign logging field.

You can also locate the cursor on the desired QSO number just by typing this number in the callsign logging field and use this menu item, or by using its shortcut (**Ctrl-G**) for backward CT compatibility.

When you have jumped to a specific QSO, Win-Test will not let you move away unless there is a valid call in the callsign field and a valid exchange in the report field. If you inadvertently delete the callsign or report, press **Ctrl-Z** to undo the change.

## Goto Callsign...

Presents a dialog allowing you to go directly to a callsign. You can also use the shortcut **[Shift]–[Control]–G**.

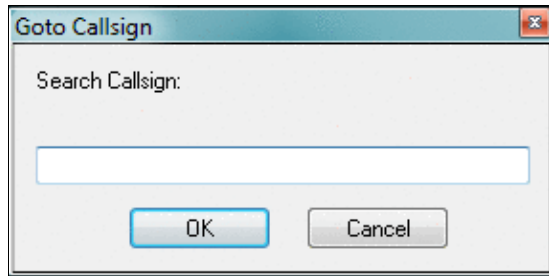

### Goto Callsign

By default, the callsign of the current QSO is searched. If the current line is empty (i.e. if the cursor is set to the last (empty) line of the log), a dialog is opened. The search is done backwards through the log.

## Apply exchange to every QSO with...

Allows you to correct a fixed exchange to every QSO in the log. This function is only available in contests, where fixed exchanges (like zones, states, districts) are exchanged. It allows you to make a consistent change without much typing.

You can also use the shortcut **[Control]–[F10]**.

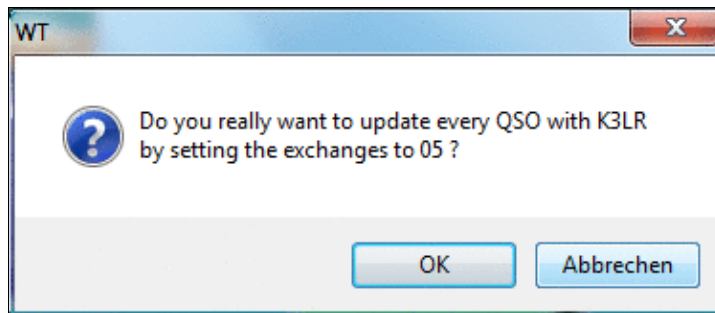

Apply Exchange to every QSO dialog.

## Move in my log only

Only useful in a multi-operating environment. Checking this option will allow the operator to step through QSOs in his own log, using the **[up arrow]** and **[down arrow]** keys. This makes it much easier to correct the last QSO logged, since the cursor skips over QSOs being logged by other computers in the network.

If this option is checked, you can still move to any QSO by pressing **[Shift]–[Up arrow]** and **[Shift]–[down arrow]**. On the other hand, if this option is unchecked, using these key combinations will navigate to QSOs made in your log only.

[Back to Menus](#)

## Namespaces

- [Page](#)
- [Discussion](#)

## Variants

## Views

- [Read](#)
- [View source](#)
- [View history](#)

## More

- This page was last edited on 17 December 2016, at 16:40.

- [Privacy policy](#)
- [About Win-Test Wiki](#)
- [Disclaimers](#)



# Menu:Operating

From Win-Test Wiki

[Jump to navigation](#) [Jump to search](#)

## Menu:Operating

The following controls are only available if [Technique | SO2R](#) or [Technique | Advanced SO2R](#) are checked. They are specific to SO2R operation. For more information on SO2R, please see [Running a Contest](#).

### Contents

- [1 Listen to the primary radio](#)
- [2 Listen to the secondary radio/headphone toggle](#)
- [3 Listen to the secondary radio during transmit/headphone latch](#)
- [4 Listen both radio/headphone split](#)
- [5 Revert to automatic control](#)
- [6 Technique](#)
- [7 Modify the scenarios](#)
- [8 Shift binds to the secondary radio](#)
- [9 Caps Lock binds to the secondary radio](#)
- [10 The second footswitch binds to the secondary radio](#)

### Listen to the primary radio

Shortcut: **[AltGr-A]** or **[Ctrl-Alt-A]**. This switches the headphones to the primary radio.

### Listen to the secondary radio/headphone toggle

Shortcut: **[AltGr-T]** or **[Ctrl-Alt-T]**. This switches the headphones to the secondary radio.

### Listen to the secondary radio during transmit/headphone latch

Shortcut: **[AltGr-L]** or **[Ctrl-Alt-L]**. This option automatically switches the headphones to the secondary radio on transmit.

### Listen both radio/headphone split

Shortcut: **[AltGr-S]** or **[Ctrl-Alt-S]**. Switches to both radios (left radio on the left headphone, right radio on the right headphone).

## Revert to automatic control

Shortcut: [**AltGr-R**] or [**Ctrl-Alt-R**]. Restores automatic control.

## Technique

Here you can choose the operating technique:

- SO1R / MultiOp
- SO2R
- Advanced SO2R

This menu entry enables/disables the above mentioned listening functions.

## Modify the scenarios

Shortcut: in the Secondary Radio Window, just *double-click* on the scenario *name*.

Here you can configure the SO2R "scenarios," which define how pressing a function key will affect headphone audio for an SO2R operator, in both Run and S&P modes.

Modify the SO2R scenarios

See [SO2R/Advanced SO2R/Setting up scenarios](#) for more information.

## Shift binds to the secondary radio

When checked, the [**Shift**] key can be pressed to bind the keyboard input focus to the secondary radio window.

See [SO2R/Shift binds second radio](#) for important keyboard mapping considerations before selecting this option.

When a binding key is used, the color background of the QSO area is changed.

## Caps Lock binds to the secondary radio

When checked, the [**Caps Lock**] key can be pressed to bind the keyboard input focus to the secondary radio window.

See [SO2R/Caps Lock binds to the secondary radio](#) for more information.

When a binding key is used, the color background of the QSO area is changed.

## The second footswitch binds to the secondary radio

When checked, the second footswitch can be pushed to bind the keyboard focus to the secondary radio window. This option is only supported for the EZMaster SO2R controller.

[Back to Menu](#)

## Namespaces

- [Page](#)
- [Discussion](#)

## Variants

## Views

- [Read](#)
- [View source](#)
- [View history](#)

## More

- This page was last edited on 1 July 2018, at 22:37.
- [Privacy policy](#)
- [About Win-Test Wiki](#)



- Disclaimers



# Menu:Commands

From Win-Test Wiki

[Jump to navigation](#) [Jump to search](#)

## Menu:Commands

### Contents

- [1 QSY](#)
  - ◆ [1.1 One band down](#)
  - ◆ [1.2 One band up](#)
- [2 Keyboard mode](#)
- [3 CW Speed...](#)
- [4 CW Weight...](#)
- [5 Carrier](#)
- [6 Split frequency](#)
- [7 QSY frequency](#)
- [8 QSY back to run frequency](#)
- [9 Swap the frequency on both radios](#)
- [10 Take a sked](#)
- [11 Pass a station](#)
- [12 Operator Login...](#)
- [13 Copy-paste the previous QSO](#)
- [14 Receive QTC](#)
- [15 Transmit QTC](#)
- [16 Turn Antenna to Logged Call \(Short Path\)](#)
- [17 Turn Antenna to Logged Call \(Long Path\)](#)
- [18 DX-Cluster](#)
- [19 Spot...](#)
- [20 Propagation forecast](#)
- [21 Insert into BandMap](#)
- [22 Active Radio](#)
- [23 Station Type](#)
- [24 CW/RTTY Messages](#)
- [25 Remote commands...](#)

## QSY

### One band down

Modify the band of the current QSO (logging field), to the nearest lower band (vs frequency). While on 160m, the nearest "lower band" will be 10m. Shortcut: **Alt-F1**. You can also directly type the desired band (if the logging field is empty, of course), and even a frequency in kHz (such as 14265).

## One band up

Modify the band of the current QSO (logging field), to the nearest upper band (vs frequency). While on 10m, the nearest "upper band" will be 160m. Shortcut: **Alt-F2**. You can also directly type the desired band (if the callsign field is empty, of course), and even a frequency in kHz (such as 14265).

## Keyboard mode

Allows you to use the keyboard to generate CW or RTTY text. This is needed in unusual situations, for example to say a few words to your old contesting friend before you send him a report or to manage a DX station to QSY to another band. This feature has no meaning on SSB.

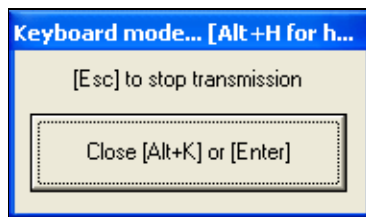

### Keyboard Mode

You have to type blind - you will only hear (or see in the RTTY monitor) what you have typed when it's being transmitted.

Note that in keyboard mode you have the usual function keys available, so instead of typing your callsign, you may simply press **F4**. If you have remapped other keys such as the backslash [**\**] to send your callsign, those keys will *not* work in keyboard mode *unless* you enable the CW Option Remap keys in keyboard mode.

Keyboard mode can also be started with the shortcut **Alt-K**. To exit keyboard mode, click on the Stop button, or press **Return** or press again **Alt-K**. Note that on CW **Escape** will also exit the Keyboard mode, but it also aborts the transmission if remaining data are still in the buffer. On RTTY, **Escape** empties the TX buffer, but leaves the PTT ON, so you can continue typing until you close the window (which resets the PTT).

By the way, you can exit the Keyboard mode with **Alt-K** when you are done typing - you do not need to wait until the transmission finishes.

## CW Speed...

Shortcut: **Alt-V**. Opens the CW speed dialog box:



Entering the CW speed

In this dialog you also can use :

- **Up arrow**: Increases the speed by 1 WPM

- **Page up**: Increases the speed by 2 WPM
- **Down arrow**: Decreases the speed by 1 WPM
- **Page down**: Decreases the speed by 2 WPM

The CW-Speed can also be changed via **Alt-F9** (decreases by 2 WPM) and **Alt-F10** (increases by 2 WPM) while operating.

Finally, you can also directly enter a speed (in WPM) in the callsign field and hit **Alt-V**.

**Note:** The settings used for WinKey are minimum 20/maximum 60 wpm. Setting any other speed min/max values with the WinKey software usually causes unpredictable, unwanted CW speed jumps when using Win-Test.

## CW Weight...

Open the CW weight dialog box:



CW weight dialog box

This is the weight (ratio) of dashes to dots - the default value (3.0) should be fine for most people.

## Carrier

Sends a carrier to the CW output. You can choose a plain carrier or pulses (in order to take care of the PA while tuning ...). Shortcut **Ctrl-T**, or enter **TUNE** in the main window. For safety reasons, a 30-second timeout automatically stops the transmission no matter what, in the meantime remaining seconds are displayed.

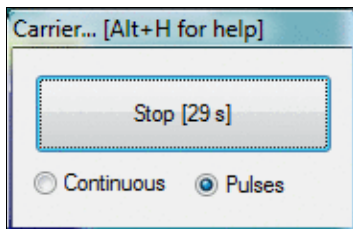

Tuning carrier

To exit this mode, click on the Stop button, press **Return** or **Escape**.

## Split frequency

Allows to directly adjust the split frequency of the current radio.

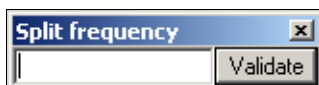

### Split frequency adjustments

A direct access to this dialog box is also possible by typing [**Minus**] from the numeric keypad, as well as the text command **SPLITFREQ** in the QSO logging field.

Enter "+1" or "-5" to set the receive frequency 1 kHz up respectively 5 kHz down.

Note that you can enter only the kHz part of the current band, and that entering an empty field or "0" cancels the split mode if it was engaged (as well as the **NOSPLIT** text command).

## QSY frequency

Allows you to adjust directly the QSY frequency on the current band.

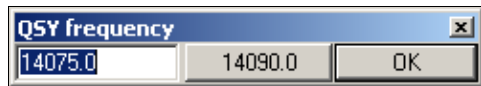

### QSY Frequency

In the dialog box, you can also use and save the current frequency as a the QSY frequency, by clicking the central button.

You can also have a direct access to this dialog box by using **QSYFREQ** or **PASSFREQ** text commands.

This frequency will then appear in the status window.

## QSY back to run frequency

This command will bring you back to the last frequency and mode on which you hit [**F1**] (=CQ, your last run frequency). It is accessible with the shortcut **Alt-F4**. The original CW speed will be restored which you had when you left the CQ frequency. Also RUN status will be restored, which is handy when you actively use the Run Mode/S&P mode.

## Swap the frequency on both radios

Shortcut: **Ctrl-S**

After typing **SWAP** or pressing **Ctrl-S**, the frequency of the primary radio is swapped with the secondary radio frequency, and this radio now becomes the primary radio. Imagine Radio2 is primary radio on 21025 and Radio1 is on 7001 After typing **SWAP** the primary radio is Radio1 on 21025. Secondary radio is now Radio2 on 7001.

This is slightly different to pressing the [**\***] key, where only primary and secondary radios are swapped.

One of the possibilities that is offered by this command, is to be able to work with a single automatic amplifier (for example ACOM 2000A) with two radios. With Win-Test and EZMaster this is possible.

The scenario is as follows:

- ◆ Radio1 running, calling CQ (high power)
- ◆ Radio2 looking for multipliers (low power)

If Radio2 locates a multiplier you try to work him, but if the pile-up is too bad this is the moment to type **SWAP** and Win-Test and EZMaster will do all the changes of frequencies and antennas. The amplifier automatically tunes to the antenna of Radio2, you work the multiplier (now with high power), while Radio1 continues calling CQ with low power maintaining the frequency (nobody will take it away). Once you have worked the multiplier on Radio2, type **SWAP** again and Radio1 will continue to CQ with high power and you continue looking for multipliers on Radio2.

Another application is looking for a clear frequency with the secondary radio on a new band, while keeping the CQ going on the primary radio. Once you find a clear spot, type **SWAP** and start CQ-ing on the new band without delay.

## Take a sked

Shortcut **Alt-E**. To take a sked with a station, the following dialog box appears :

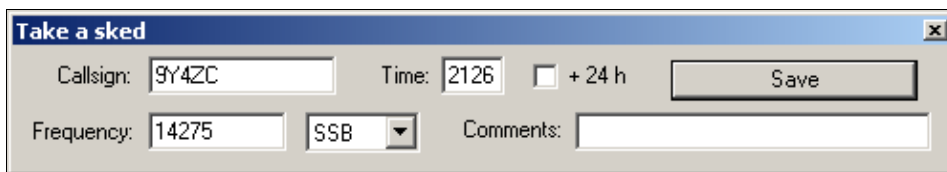

Taking a sked

You must write down the callsign of the station you want to take a sked with (the current callsign in the logging field will be taken by default), the time of the sked (possibly specifying if this time must shifted + 24h, see comment below), the frequency, the mode (only in a multi mode contest), and an optional comment. Once recorded, the sked will appear in the skeds window.

Remark about the time of the sked : checking the "+ 24 h" box does not always mean that the sked will be taken for "tomorrow", but that the time must be shifted by + 24 hours.

Example 1 : It is Saturday 1000z. You take a sked for Sunday 0600z : do not check the "+ 24 h" box.

Example 2 : It is Saturday 0400z. You take a sked for Sunday 0600z : you must check the "+ 24 h" box, otherwise the sked will be taken for saturday 0600z !

## Pass a station

Shortcut **Alt-D**. To pass a callsign to another operating position (multi operators), the following window appears :

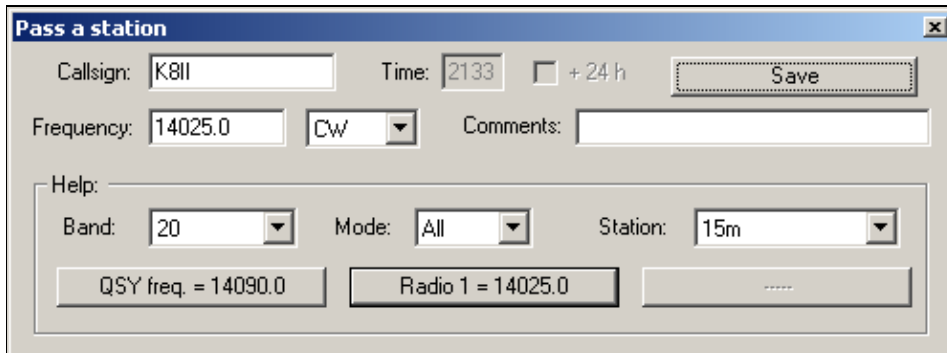

Swap the frequency on both radios

## Pass a station

You must write down the callsign of the station you want to pass (default: the callsign in the logging field), the frequency, the mode (only during a multi mode contest), and an optional comment. Once OK is pressed, the information will appear in the skeds window.

To make it easier passing a callsign in a multi operating environment, the lower part of window lets you know, by means of filters (combo box), what station is on the band where you wish the calling station to be, and the frequencies of the radios being on that band.

## Operator Login...

This feature was added to provide a basic operator management. The feature is only available to multi operator logs.

It was mainly added to help DXPeditioners to identify operators for the web log search scripts, and for various DX or testers challenges (RRDXA etc.). The new text commands **OPON** or **LOGIN** allow the operator to identify himself. The operator change is propagated across the network, meaning that if you login on a station, you will be automatically logged out of the previous one you were logged on (if any).

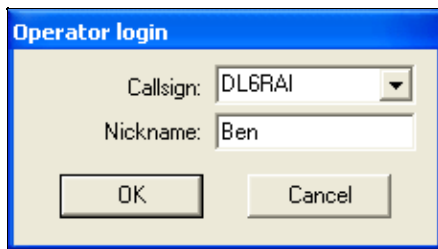

Log in a new Operator using the LOGIN command

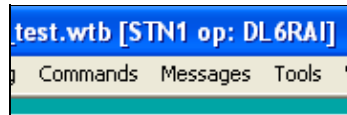

The current operator's callsign is displayed inside the title bar of Win-Test

When a list of operators was entered in the contest settings dialog when creating the log, it will be parsed to init the combo-box. You can also add ops "on the fly" to this combo box.

If you add nicknames to operators of this list (JOE, JACK, WILLIAM, AVERELL, JOSETTE or whatever - letters and numbers are accepted, allowing exotic nicknames like L33T etc.), you can enter them as text commands to quickly change operator, without using the **OPON** command. However, you cannot enter the operator's callsign; this will log a QSO with the operator.

To log off, simply change the operator or use the **OPOFF** or **LOGOOUT** text command.

Operators' callsigns are limited to 7 chars, while nicknames are limited to 13 characters in length. The ADIF file export includes the operator's callsign in the QSO record, if an operator was defined for that QSO. The text and CSV export files also allow the inclusion the operator's callsign.

When an operator logs on, Win-Test now automatically tries to run an executable (.exe, .bat or .com) named op\_"callsign" which must be located in the Win-Test installation directory. For example, if DL6RAI logs in, WT will try to run op\_dl6rai.exe (or .bat or .com), if this file exists. If the callsign includes a "/" character, it will be replaced by an underscore ("\_"). This feature may be useful to automate various actions.

## Copy-paste the previous QSO

Shortcut **Alt-[UP]**. This copies the calling from previous QSO to the QSO edit field. Useful for passed stations or after QSY.

## Receive QTC

Shortcut **Alt-L**.

Only for WAEDC contest and for European stations. Opens the QTC RX dialog box

Station: **VE3KR**

Gr/Num	Time	Callsign	Serial
1			
2			
3			
4			
5			
6			
7			
8			
9			
10			

F1 ... QTC?  
 F2 ... QRV  
 F5 ... TIME?  
 F6 ... CL?  
 F7 ... NR?  
 F8 ... AGN  
 F9 ... QSL + gr/nr  
 F10 ... QSL ALL  
 CR ... R & Next  
 + ... TU & Valid  
 Validate

Space: change field (Time, Callsign, Serial)  
 Tab: same as space + Gr/Num  
 Ctrl+Arrows: change line or column  
 Alt+K: enter keyboard mode (CW)  
 Alt+F9 & Alt+F10: change speed (CW)  
 Alt+L: exit without saving



QTC RX dialog  
 See [WAEDC](#) for more information.

## Transmit QTC

Shortcut **Ctrl-L**.

Only for WAEDC contest and for DX stations. Opens the QTC TX dialog box where you can select how many QTCs you want to send:

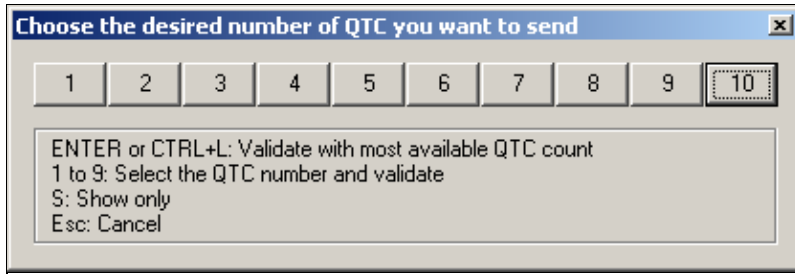

Selecting the number of QTCs to transmit  
 After pressing **ENTER** or selecting **10** You will get something like this:

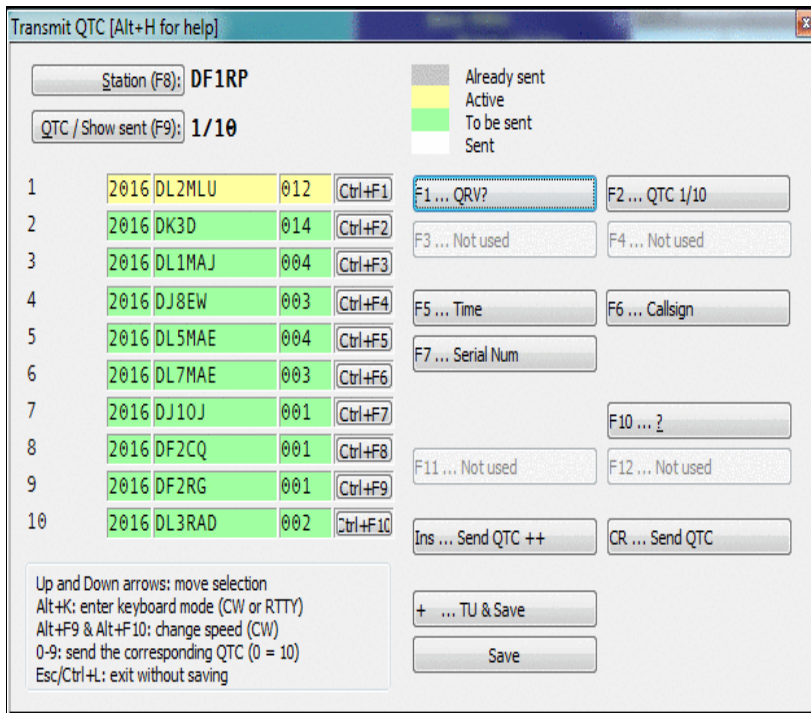

Transmitting QTCs  
See [WAEDC](#) for more information.

## Turn Antenna to Logged Call (Short Path)

Shortcut **Ctrl-F12**. Turns the antenna to the logged call (short path) in case wtRotators.exe is active and properly configured.

## Turn Antenna to Logged Call (Long Path)

Shortcut **Alt-F12**. Turns the antenna to the logged call (long path) in case wtRotators.exe is active and properly configured.

## DX-Cluster

Shortcut **Alt-T**. This window allows you to send commands to the DX cluster you are connected to. These commands are then forwarded either to a TNC physically connected on a COM port, a DX Cluster connection established via the wtDxTelnet application or a remote TNC in a multi computer network.

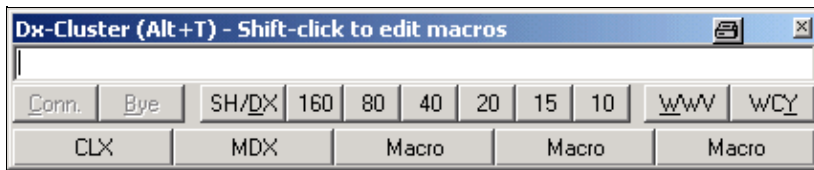

Sending commands to the DX cluster

The buttons below the entry line of that window are pre-defined commands that can be activated by clicking with your mouse.

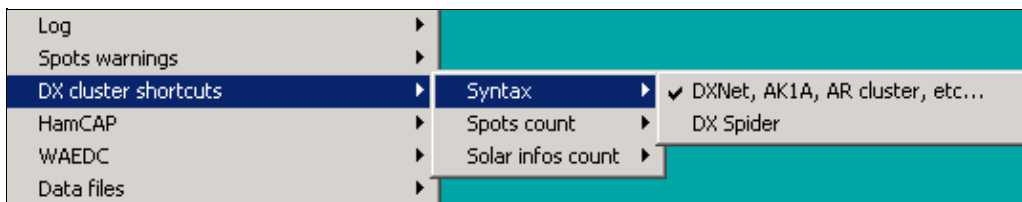

The DX Cluster Shortcuts dialog

The count of DX spots and solar data can be set in the [Options | DX cluster | DX cluster window shortcuts](#) menu. This menu also allows you to select which type of DX Cluster you are connecting to, either the DXNet/AK1A/ARcluster type or the DX Spider type, where the command syntax is slightly different.

Additionally, there are five macro buttons that allow you to store often used commands or sequences. They come in handy for setting up the connection over a flakey or unstable link. Use **[Shift]** - Click to edit these macros.

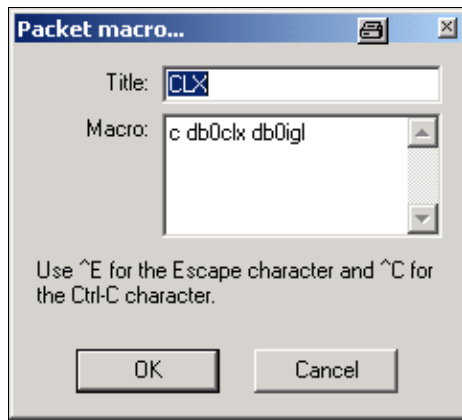

The DX Cluster Macros dialog

Since pressing **[Escape]** would close the current window, you can use **Ctrl-E** to send an Escape character to the TNC (if it is in WA8DED host mode) to generate commands like

```
* I DL6RAI
* S1
* CDB0IGL
```

All entered commands are stored in a 10-slot recall buffer, in which you can navigate with the **[Up]** and **[Down]** arrow keys.

## Spot...

Shortcut **Alt-F3**.

Sends a DX spot with the callsign of the current call in the callsign field or the previously logged QSO to the DX cluster you are connected to. The frequency is the active frequency of the current radio or the frequency on which the QSO was logged. This even works correctly when the cursor is positioned on a previous QSO.

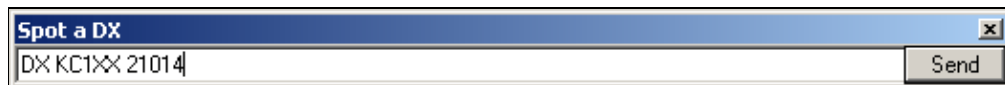

Spot a station on a DX cluster

You can also modify the command (by adding a comment for example), before sending the spot. To cancel sending a spot, close the dialog box or press **[Escape]**.

If you have no computer control for your transceiver, you will have to manually enter the frequency before the spot can be sent.

The context menu of the Band Map lets you select the policy after which time (if at all) spots entered by the operator are deleted from the band map.

## Propagation forecast

Shortcut **Ctrl-P**.

This function will be activated only if:

DX-Cluster

• Ham CAP (by VE3NEA), and its pre-requisite VOACAP v.08.1124W, are installed on your computer and

- a **CALLSIGN** is typed in the entry field

This is a sample of a Propagation Prediction Map you can get.

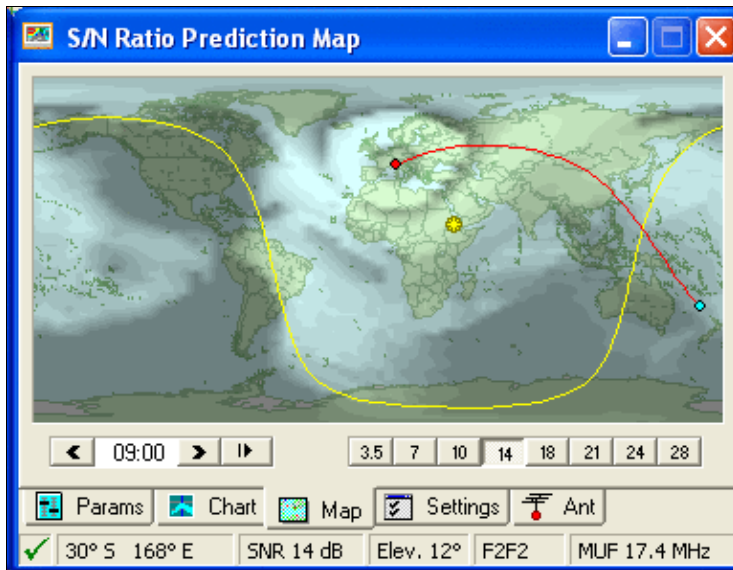

Propagation prediction map.

Clicking on the **Chart** Tab this is what will appear:

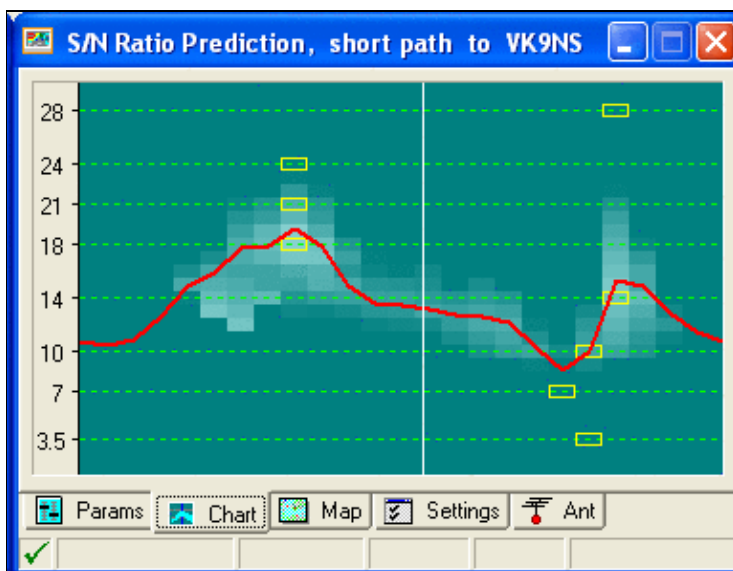

Point-to-Point Prediction Chart.

This is a very comprehensive and useful representation.

The red curve shows the statistical median MUF (50% Maximum Usable Frequency), while the yellow boxes mark the best hour for each ham frequency.

For more information refer to:

- [HamCap](#) Installation and Configuration
- [Options | HamCAP](#)

## Insert into BandMap

Shortcut **Ctrl-[Enter]**. Inserts - into the band map of the active radio - the callsign captured in the logging field. This is very useful, especially while hunting for multipliers, to quickly detect a station in the band when you turn the VFO knob.

## Active Radio

Switches the active radio. A double-click on one of the VFOs of the corresponding Bandmap will provide the same result. The "\*" key also swaps the 2 radios (useful for SO2R operation).

## Station Type

Indicates the station type for the current QSO. This command is useful for multi operators set-ups (M/S or M/2), if the contest rules make a difference between these status for the current category. If not, only the RUN (or RUN / SUPPORT) status can be used. At the end of each QSO line (or in the [Status Window](#)), you can see:

- R : RUN (running station in M/S)
- M : MULT (multiplier station in M/S, non-multipliers worked by multiplier station will be clearly indicated)
- R1 : RUN 1 (First M/2 station)
- R2 : RUN 2 (Second M/2 station)
- R+ : SUPPORT (see below)

The station type can be fixed for a computer so that when you reopen the log, or create a new log, the station type is the same as it was previously. Select the **Sticky Setting** checkbox to enable this feature.

The + indicates that the station is a SUPPORT station.

A SUPPORT station has the same settings as the MASTER station it refers to. It allows to have a RUN station, which runs the pile-up, and a RUN SUPPORT station (R+) which searches for multipliers on the same band as the RUN station (usually called INBAND station). As well, there can also be several MULTI, RUN1 stations ...

**Note:** The station type has no connection with the network station name in a Multi-OP environment setup which you set up when opening a [new log](#). For a correct generation of the

Cabrillo file of a M-2 entry, make sure your two active stations are type R1 and R2 - no matter what name they have in the network.

## CW/RTTY Messages

Sends the CW and RTTY messages [F1]...[F7], [Insert] and [+]. See [Keys](#) for more information.

You can also open and modify the **additional messages**-dialog (which may be opened any time with the shortcut **Alt-C**).

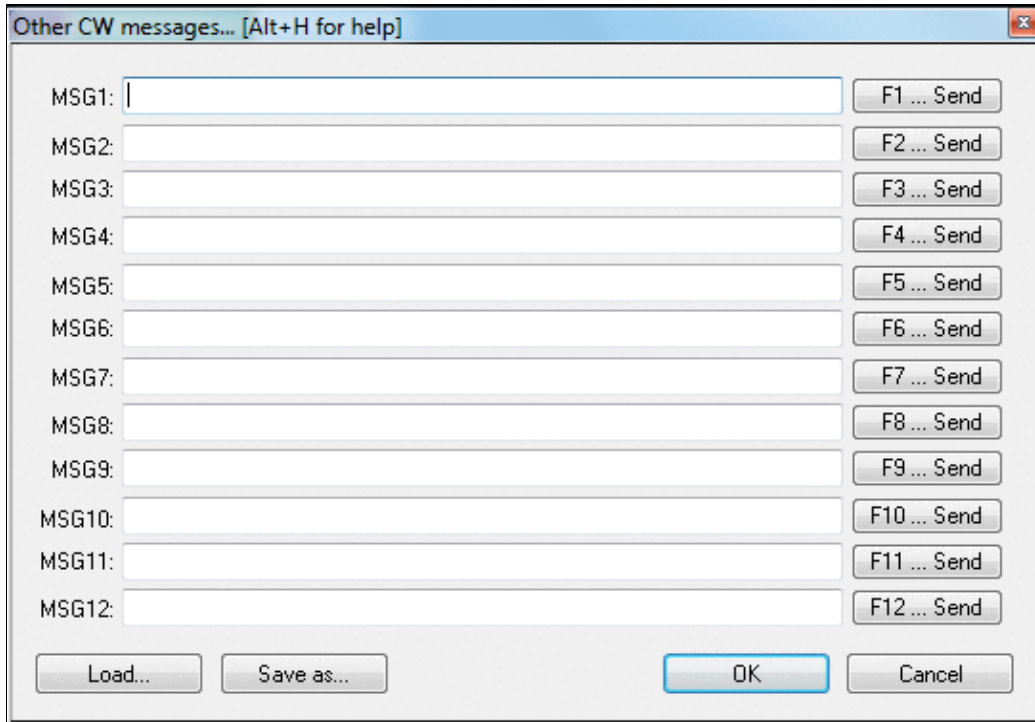

Additional CW/RTTY messages dialog

Please pay attention to the fact that the Message Variables (beginning with \$), like **\$MYCALL**, **\$SERIAL**, etc. DO NOT work within these additional messages.

## Remote commands...

Equivalent to the **REMOTE** text command.

Allows you to send a single text command to the local PC and to all other stations connected to the network at the same time.

In the example below, the **NOSYNC** text command is being used to temporarily disable log synchronization on the local PC and the remote PC named "20m" (see Clearing all logs before the start for why you might need to do this).

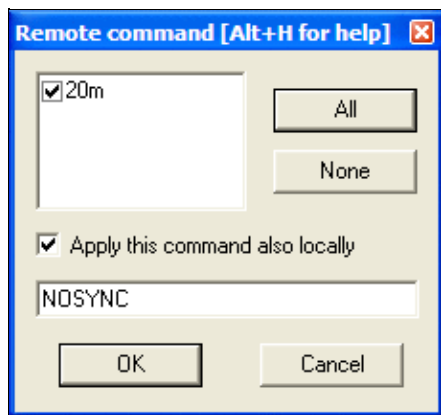

The **REMOTE** dialog lets one operator run a command on one or more networked computers

After entering the command, a gab message is generated automatically to confirm execution of the command on the local and remote computers, e.g.

```
20m: 40m: The command "NOSYNC" was carried out.
```

This menu item is only available if more than one station is available on the network.

**Use with great care!**

## Namespaces

- [Page](#)
- [Discussion](#)

## Variants

## Views

- [Read](#)
- [View source](#)
- [View history](#)

## More

- This page was last edited on 10 April 2023, at 07:06.

- [Privacy policy](#)
- [About Win-Test Wiki](#)
- [Disclaimers](#)





# Menu:Messages

From Win-Test Wiki

[Jump to navigation](#) [Jump to search](#)

## Contents

- [1 Send a Gab...](#)
- [2 Reply to the last private gab...](#)
- [3 Write a note regarding this QSO](#)

# Menu:Messages

## Send a Gab...

Messages | Send a gab... or **Alt-G**

Sends a gab on the local network, which will appear in the gab window of every connected computer. You can choose to send the gab to all or only to **one** station (drop down box on the left).



Sending a gab

The gab window opens up on all other computers and displays your message.



Gab window

The window will be visible for 15 seconds and then closes by itself. The operator can bring the window up again with **Alt-I**.

This way you can send messages to the other stations in a multi operator setup. Private gabs are displayed in different colors. Also multipliers passed from other bands will show up in this window in a different color, as you can see in the example.

If the text starts with "/me", it is replaced with the station name and the message is emphasized with a leading and a trailing star symbol.

If the text contains CAPITALS only, the recipients Gab window will shake, when receiving the text.

The gab messages are also written to disk and can be found as \*.gab (a text file that you can open with Notepad) after the contest.

## Reply to the last private gab...

Messages | Reply to the last private gab... or **Alt-P**

Like 'Send a gab' but directs the destination to the last private gab originator instead of all.

## Write a note regarding this QSO

Messages | Write a note regarding this QSO or **Alt-N**

Opens the note input dialog.



Making a note

The notes are written to disk and can be found as \*.not (a text file that you can open with Notepad) after the contest.

The notes are also forwarded to the network so that there is a complete notes file on every station.

[Back to Menus](#)

## Namespaces

- [Page](#)
- [Discussion](#)

## Variants

## Views

- [Read](#)
- [View source](#)
- [View history](#)

## More

- This page was last edited on 30 December 2021, at 13:20.

- [Privacy policy](#)
- [About Win-Test Wiki](#)
- [Disclaimers](#)



# Menu:Tools

From Win-Test Wiki

[Jump to navigation](#) [Jump to search](#)

## Menu:Tools

### Contents

- [1 Automatic CQ repeat](#)
- [2 Intelligent Quick QSL...](#)
- [3 Redefine keyboard keys](#)
  - ◆ [3.1 Remapping \[\\*\] and \[+\] when using Notebook or Mini keyboard](#)
  - ◆ [3.2 QWERTY and AZERTY Keyboards](#)
- [4 Data entry](#)
  - ◆ [4.1 Exchange guessing](#)
  - ◆ [4.2 Callsign check](#)
  - ◆ [4.3 Priority](#)
  - ◆ [4.4 Enable ESM](#)
  - ◆ [4.5 Disable CW cut numbers translation](#)
  - ◆ [4.6 Remap Slash to /P](#)
  - ◆ [4.7 Enable Run/S&P switching](#)
  - ◆ [4.8 Switch keyboard...](#)
- [5 Countdown timer...](#)
- [6 Scripts Manager](#)
  - ◆ [6.1 Introduction](#)
  - ◆ [6.2 # Notation](#)
  - ◆ [6.3 Calling Scripts via Text Command](#)
  - ◆ [6.4 Automatically Executed Scripts](#)
  - ◆ [6.5 Synchronous vs. asynchronous - the #@ Notation](#)
  - ◆ [6.6 Tips for Programming](#)
  - ◆ [6.7 Basic Examples](#)
    - ◇ [6.7.1 Example 1](#)
    - ◇ [6.7.2 Example 2](#)
    - ◇ [6.7.3 Example 3](#)
- [7 Load a target file](#)
- [8 Export a target file](#)
- [9 Check log](#)
- [10 Time shifting](#)
- [11 Correcting OP over a QSO range](#)
- [12 Download Files through the Network](#)

### Automatic CQ repeat

Use the [text command](#) **RPTDELAY** to get to this menu quickly.

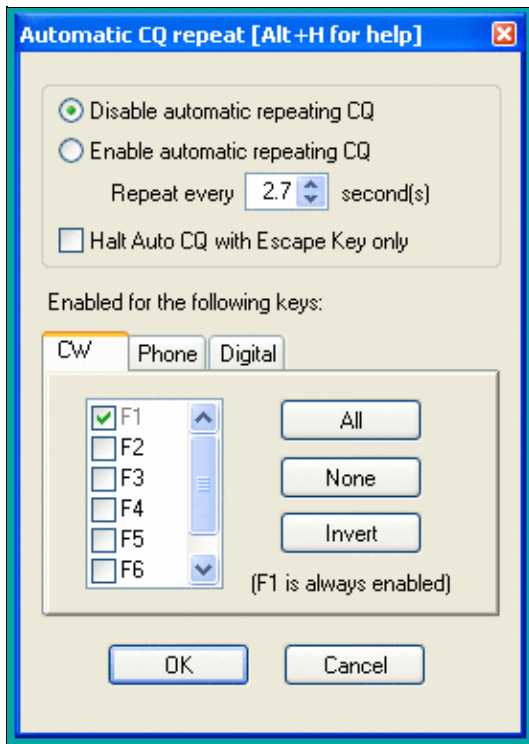

### Auto CQ Settings

This option allows you to automatically repeat messages after a certain amount of time if no key was pressed by the operator. This feature works on all modes and simulates the operator pressing one of the keys [F1] to [F7] key after so and so many seconds.

Traditionally, this is used for the [F1] key to auto-repeat CQ but it can also be used on other keys.

Contrary to CW operation, note that when using an external voice keyer on SSB (like the built-in DRU-2 in a Kenwood TS-850) Win-Test does not know when the message ends. For this reason, the time period to be set is the time that elapses between two CQ calls. This is also true for RTTY when using the MMTTY plug-in.

You may want to use the text commands **NORPT** or **RPT** to deactivate and later reactivate that function. Optionally, you may choose that only the Escape key deactivates the repeat function by clicking the appropriate option in the context menu or by **RPTESCONLY** and **NORPTESCONLY** text commands.

## Intelligent Quick QSL...

Use the text command **QUICKQSL** to get to this menu quickly. Use **QQSLON / QQSLOFF** or **QQSL / NOQQSL** text commands to enable (or disable) the Quick QSL feature.

This option controls the content of the two message variables **\$QQSLT** and **\$QQSLC**. When used, these variables change their content after so and so many seconds or when a number of QSOs have been logged. That way you can send a short QSL message to confirm the QSO in a pileup, but make sure your full callsign gets transmitted automatically every 2 minutes or every 5 QSOs only. So while most QSOs would be completed with **TU** or **EE** sometimes we would send a message like **TU F5MZN**.

Intelligent Quick QSL configuration... [Alt+H for help]

Quick QSL Timing and Counting configuration

Enable Adaptive Intelligent Quick QSL

Instant Rate greater than:	Send long QSL based on time every:	Send long QSL based on QSO count every:
by default:	10 seconds	1 QSO
60	20 seconds	2 QSO
120	30 seconds	3 QSO
180	40 seconds	4 QSO
240	50 seconds	5 QSO
300	60 seconds	6 QSO

Number of QSO taken for the Instant Rate computation:

3

Messages

CW SSB Digital

Short QSL message:

EE

Long QSL message:

++TU-- \$MYCALL

OK Cancel

The intelligent quick QSL option allows you to automatically control sending of your own callsign every so often during a heavy pileup.

A timer (**\$QOQSLT** macro) or a counter (**\$QOQSLC** macro) are associated with these macros to determine if either a short or a long QSL message is to be transmitted. Additionally, this feature can be related to the current QSO rate (so-called adaptive intelligent quick QSL).

The **\$QOQSLC** and **\$QOQSLT** macros can either be used in the CW/RTTY Messages or in the advanced SO2R scenarios. It is also possible to use the feature in SSB (SO1R and SO2R not advanced) but this needs a specific configuration in the SSB tab of the configuration window.

In the **PLUS** message in the Standard CW messages configuration, replace **TU \$MYCALL** with **\$QOQSLC** or **\$QOQSLT**. Intelligent Quick QSL will then send a short QSL message or a long QSL message according to the set counter or the set timer in the respective variable.

The macro **\$QOQSLRESET** resets the timer or the counter like if the long QSL message were just sent. It makes sense to use this macro in each message you send your callsign in like CQ (**F1**) or MYCALL (**F4**). That way, you won't send a long QSL message after just having sent your call a few seconds before.

## Redefine keyboard keys

Use the text command **DEFINEKEYS** to get to this menu quickly.

On some keyboards, it is difficult to reach specific keys, so Win-Test allows you to re-define some of the keys on your keyboard.

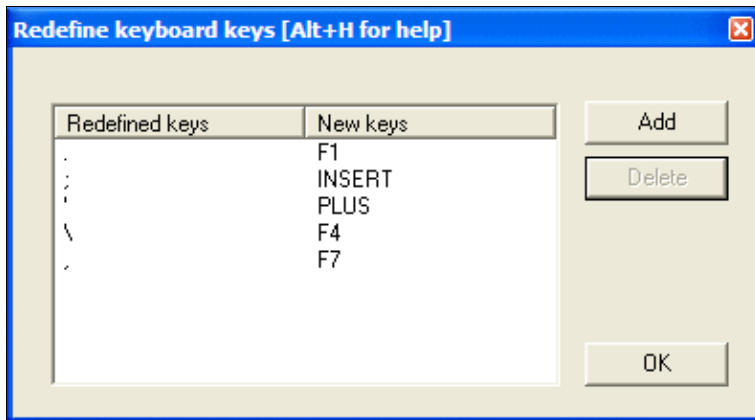

### Redefine Keyboard Keys

For example, to make the period key [ . ] call CQ, just like **[F1]**:

1. Press the **[Add]** button
2. Press the key you want to reprogram: the period key [ . ]
3. Press the key that does the function you want: the **[F1]** key
4. Press the **[OK]** button to save the changes, or press the **[Esc]** key to exit without saving any changes

To restore a remapped key to its default behavior, highlight a line by clicking on it with the mouse, then press the **[Delete]** button.

Remapping is done on a 1:1 basis. One keystroke becomes an alternate version of another. The original key still works as before. Keyboard remapping is saved in the wt.ini file, so the same map will automatically be used for all contests.

**WARNING:** Do not copy wt.ini from one machine to a new machine that already has a registered version of Win-Test, or else will have to re-enter the registration key on the new machine. See registration instructions.

In the example above, you can see how the commonly-used keys like **[F1]**, **[Ins]**, and **[+]** have all been remapped to keys that are much easier to reach on a U.S. keyboard, especially if you are a touch-typist. The keyboard map shown in the example was developed by N6TV for Team Vertical:

- **[.]** (the period key) calls CQ, just like **[F1]**
- **[;]** (the semicolon key) sends the message, just like the **[Ins]** key
- **[']** (the single-quote key) sends TU and logs the QSO, just like the **[+]** key
- **[\\]** (the backslash key, just above the **[Enter]** key on many U.S. keyboards) sends **\$MYCALL**, just like **[F4]**
- **[,]** (the comma key) sends a single question mark, just like **[F7]**

**NOTE:** Remapped keys are ignored in keyboard mode unless you enable the CW Option Remap keys in keyboard mode. It is generally a good idea to enable this option so that all message keys work the same, whether you are in keyboard mode or not.

### Remapping **[\*]** and **[+]** when using Notebook or Mini keyboard

By default, the asterisk key **[\*]** is used to switch active radios, and the plus key **[+]** is used to send "TU" and log a QSO. These keys are located on the numeric keypad of a full-sized keyboard. Win-Test does *not* treat these keys the same as **Shift-[\*]** and **Shift-[+]**, which is what you would normally press when typing text.

If you are using a Notebook, Laptop or "mini" keyboard without a separate numeric keypad on the right side, equivalent keys with special colored symbols become active only when you press the **[NumLock]** key. One of these keys should be labeled with an asterisk in a different color, and another should be the plus. For example, on a U.S. ThinkPad keyboard, the colored asterisk may be located on the **[P]** key, and the colored plus may be shared with the **[/]** key. Those are the keys to use when remapping, after activating Num Lock mode.

For example, to make Ctrl-S act as the "Switch Active Radio" key when using a keyboard without a numeric keypad:

1. Press the **[Add]** button
2. Press **[Ctrl-S]**
3. Press **Shift-[NumLock]** to enter Num Lock mode
4. Press the key that does the function of the asterisk when in Num Lock mode, perhaps the letter P?
5. Press **Shift-[NumLock]** again to exit Num Lock mode

If a single asterisk **\*** appears in the New Keys column as shown below, the key has been correctly defined. If it says **Shift \*** or something else, it has not.

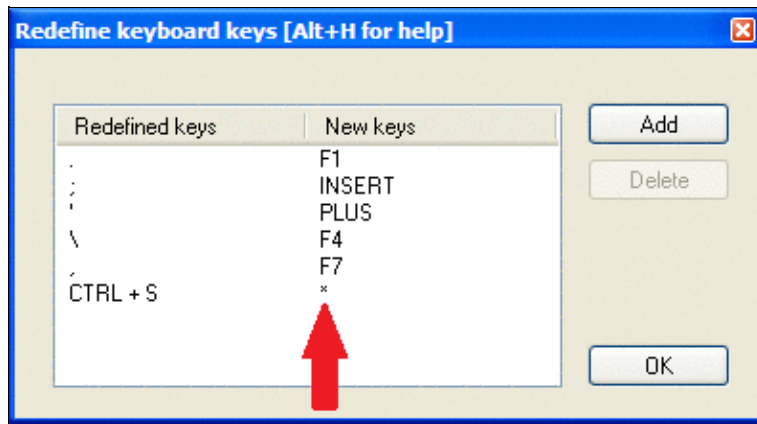

Redefine Keyboard Keys, with function of ASTERISK and PLUS keys properly re-assigned to other keys.  
**QWERTY and AZERTY Keyboards**

French (and some Belgian) users: Button added in the keys redefinitions dialog to load AZERTY redefinitions that allow the AZERTY keyboards users to access the numbers located on the top row without using the Shift or Shift Lock keys. They allow direct access to the ?, . and / keys of the bottom row as well. This button is displayed only when the language is set to French.

## Data entry

These functions describe settings that influence data entry to the log entry line.

## Exchange guessing

Exchange guessing is a feature of Win-Test that predicts the exchange that is going to be received before your QSO partner actually sends the report. In many contests a fixed piece of information is exchanged like the CQ zone in the CQWW contests, or ITU zone in IARU. This option allows you to select the way Win-Test fills in the exchange:

- pressing the space bar
- automatically
- after timeout

Note this option also acts on the various warnings (dupe, new mult, etc., if any) displayed under the log lines.

This feature saves you from continuously typing the same information over and over again but you better make yourself sure the guessed report is correct before you press the **[Enter]** key.

Please refer also to [Setting up Exchange Guessing in Win-Test](#) to know how to activate this feature for a specific contest.

**Note:** CQ zones in the USA and Russia will be guessed correctly (well, 99%) only when you have loaded F5IN's **CTY\_WT\_MOD.DAT** file. Otherwise Win-Test will always come up with the default zone of that country (5 for USA, 17 for UA9 and UA0). Please see [Data files](#) for more details on how to select the right **CTY** file.



## Callsign check

On the fly callsign pattern check based on the K1TTT callsign.pat file, described [here](#) (over 400 rules applied today). The latest version of callsign.pat may be downloaded [here](#).

Yellow text denotes a warning, red text denotes an invalid callsign.

5127 160 23:53 G3B	59 59 14	5127 160 23:53 G3B	59 59 14
5128 160 23:53 DR2W	59 59 14	5128 160 23:53 DR2W	59 59 14
5129 40 DP3Ø1DA	59 59 14	5129 40 DLOWB	59 59 14
* Call too long? *		* Starts with 3 characters! *	

Callsign possibly wrong

Callsign definitely wrong

Callsign pattern file location:

- Windows XP: **C:\Documents and Settings\All Users\Application Data\Win-Test\extras\callsign.pat**
- Windows Vista or Windows 7: **C:\ProgramData\Win-Test\extras\callsign.pat**

Updates may be downloaded from <http://download.win-test.com/files/extras/>.

You are encouraged to report to the author ([K1TTT](#)) any mistakes or updates needed in this file.

Callsigns which don't follow the usual rules, like RAEM, 5VDE, 7QAA, etc.) are grouped in the **exceptions.dat** file for easy updating.

## Priority

To change bands, you may wish to enter a frequency or band (m) into the callsign field. This option determines how these figures are to be understood by the program:

- Band - take 10,15,20,40,80,160 as a meter band
- Frequency - take the input as a frequency; shorted inputs as kHz

To make this a little more clear, if you enter 40:

- In the first case will switch the band to 40 meters (thus, enter 040 or 40.0 if you want to tune your radio to 040)
- In the second case it will tune your radio to decimal 040 on the current band (thus, enter 40M if you want to switch to 40 meters).

## Enable ESM

Win Test v4 comes with an Enter Sends Message (ESM) feature, well-known by users of TR LOG by N6TR. The functionality can be turned on or off via this menu item or using the [text commands](#) **ESM/NOESM**.

ESM relies on the following messages assignation:

F1: CQ

```
F2: Sent report
F4: Mycall
F5: Logged callsign ($LOGGED)
F7: ? (or "Again ?" in phone)
INSERT: Callsign + sent report
PLUS: TU + enter Q
```

The basic functionality of ESM can be described like this:

- Pressing **[Enter]** with an empty callsign field, will send the **[F1]** message.
- Pressing **[Enter]** with a callsign filled in but no report will send the **[INSERT]** message.
- Pressing **[Enter]** with callsign and report filled in will send the **[PLUS]** message.
- Pressing **[Enter]** with callsign and partial report filled in will send **[F7]** message.

It makes CW/RTTY easier, as you use one key for most of the operations instead of the various F keys.

There are additional minor details to ESM, which are not described here. On top, ESM behaviour is user-modifiable by using a script editor.

Once ESM is enabled, the **[Enter]** key **can no longer** be used to silently log a QSO. The key combination **[Ctrl+Plus]** has been introduced and added for this purpose.

When using the SO2R advanced technique, the scenarios messages are used instead of the standard.

## Disable CW cut numbers translation

Allows to completely disable Win-Test's intelligent translation of cut numbers like **TTA** to **001**. Note that this translation is performed on a contest and worked station contextual basis. The equivalent text commands are **CUTON** and **CUTOFF**. Do not mix up with **CUT/NOCUT** that are reserved for CW cut numbers generation !

## Remap Slash to /P

This option allows you to map "/" to "/P" for Field Day, VHF/UHF contests and DX pedition mode.

## Enable Run/S&P switching

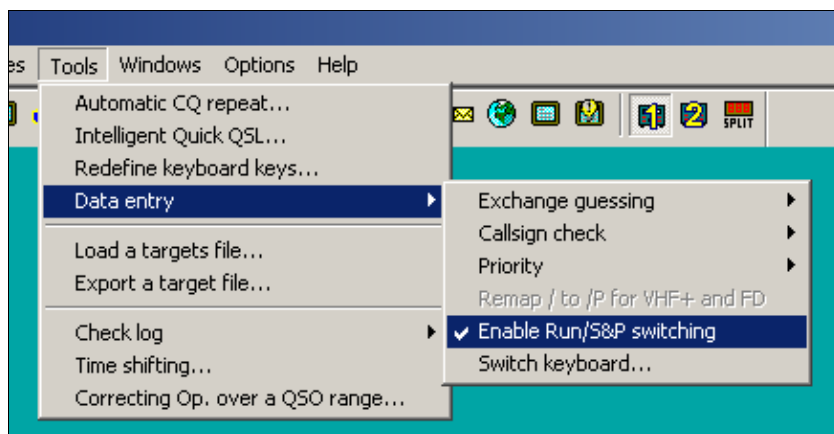

### Enable RUN/S&P switching

Allow switching between Run and Search & Pounce Operating Mode in order to have two different sets of CW/RTTY messages: one when running, and one when searching multipliers.

- The Run and S&P sets of messages are editable in the "Messages" Tab of the Standard CW/RTTY Messages Configuration window.
- Use [**Ctrl-tab**] to switch between RUN and S&P mode on the Primary Radio. The current mode is shown in the clock window. To change the mode of the Secondary Radio Window, use either [**Ctrl-Shift-tab**] or a mouse click on the appropriate control in the Secondary Radio Window.
- It is possible to configure WT to automatically populate the Band Map and wipe the data entry area whenever the operator changes the radio's frequency, if Search & Pounce mode is activated on that radio. This can be configured from the Band Map Properties dialog (right click in the Band Map window).

**Note:** Search & Pounce is not activated by default. To automatically populate the Band Map, you must switch to S&P mode.

**Note:** When switching from Run to S&P mode, Auto CQ and Auto CW Sending are automatically disabled.

### Switch keyboard...



Switch keyboard during the contest - useful for mult-national teams

Keyboard switching for international teams with different keyboards. It is enabled only if several keyboards are installed on your system. You can also access this dialog by entering the text commands **KEYBOARD** or **KEYB** for short.

### Countdown timer...

The countdown timer indicates exactly when the single operator can start operating again after a break. It's based on the time of the last QSO entered in the log, truncated to the minute.

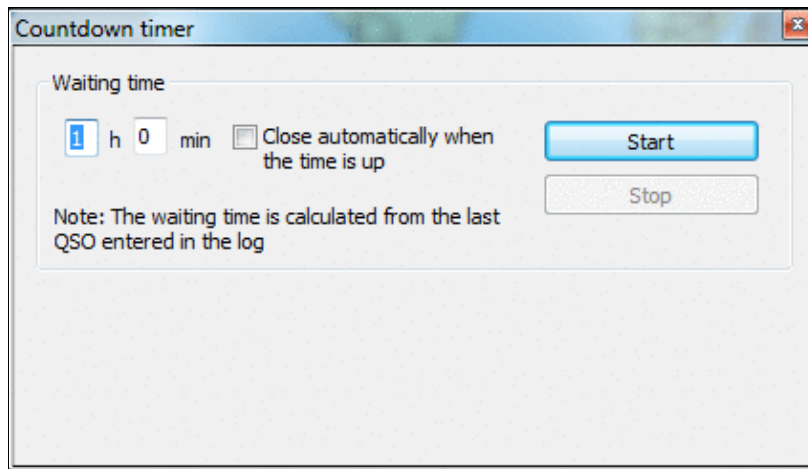

Countdown timer to plan breaks.

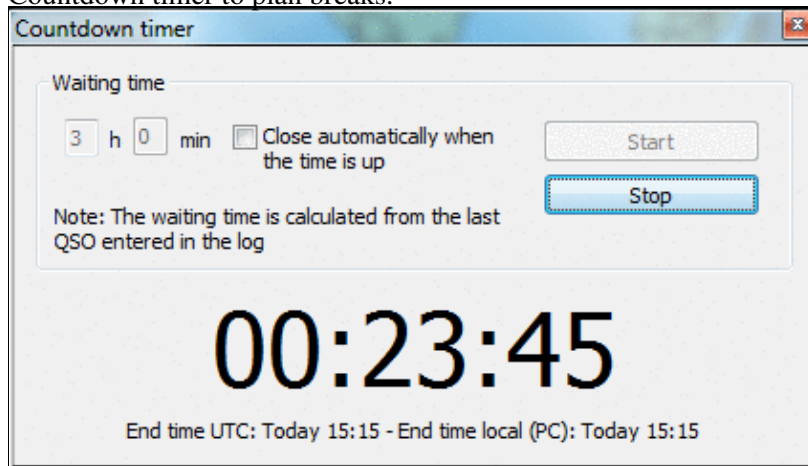

When running, it displays minutes when operation can commence.

You can also use the text command **TIMER/nnHmmM'** or **TIMER/nnHmm** (meaning nn hours and mm minutes), or **TIMER/xxH** (nn hours) or **TIMER/nnM** (nn minutes) to set and start the timer automatically.

## Scripts Manager

Allows to edit, create, delete or rename scripts. It's also used to assign a key and/or an argument to a script. Scripts are to be created and maintained by the user using the Lua programming language. See the [Win-test Lua API](#). For a reference of the Lua programming language, see <http://www.lua.org/manual/5.1/>. Sample Lua scripts demonstrating how to control the RIT and internal DVR (voice keyer) of the Elecraft K3 and other radios may be downloaded from <http://bit.ly/wtscripts>.

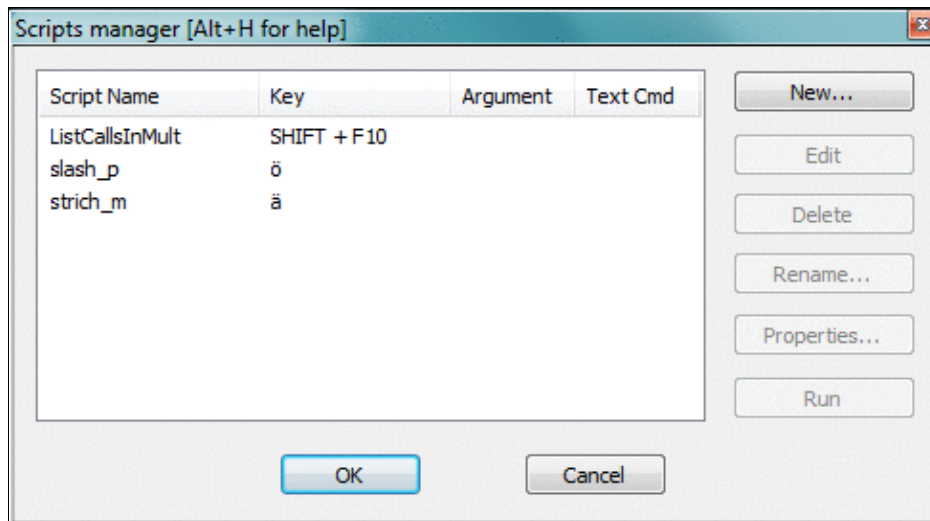

The Win-Test Scripts Manager to edit, create, delete or rename WTS scripts  
 You may also use the text command **SCRIPTS** to open the scripts manager.

By double-clicking an existing script, the default Editor is opened. Ctrl + Double click brings up the properties dialog.

Before you can modify scripts, you must configure an appropriate script editor. Per Default, Win-Test uses the SciTE Editor, which can be optionally installed. It does context sensitive highlighting, syntax checking etc. If you are only writing a simple script, Windows notepad.exe is probably sufficient.

## Introduction

The Win-Test scripting language gives the user the unique ability to achieve dynamic tasks in Win-Test. It also provides a way to share your work with other Win-Test users who don't have time or skill to write their own scripts.

ESM (Enter Sends Message) was the first Win-Test application where the scripting language **Lua** was used. The ESM function itself is a Lua script, embedded in Win-Test (not modifiable). But, it has been designed to be totally overridden by a user-written script if desired, i.e., you can write and use you own modified version of the ESM script to change the default ESM actions. See ESM Script (embedded into Win-Test) for the LUA source code.

To do this, the minimum requirement is to know some basics of a programming language. The Lua syntax is **very** simple for doing easy tasks. If you're comfortable with **any** programming language, you will learn Lua in minutes, at least for basic scripting involved in Win-Test. Many Win-Test API (Application Programming Interface) functions are provided to control various Win-Test features.

For a list of Win-Test API Functions and Constants, see API.

## # Notation

Scripts can either be called by pressing a key or from within a CW or RTTY message. For this, you must use the **#SCRIPTNAME (ARGUMENT)** notation. The argument (and parenthesis) are optional. The script will be called synchronously, but is executed in the main thread, meaning that it is not blocking the CW/RTTY

stream.

For example :

```
TU N6TV #CLEARIT
```

assuming your script is called **CLEARIT.wts** - or

```
TU #QSYUP(200)
```

assuming you created a script named **QSYUP.wts** to QSY up **wtArgument** Hz after a QSO.

## Calling Scripts via Text Command

Scripts may be triggered using a Text Command. **SCRIPT.wts** can be executed by entering **SCRIPT** in the callsign field.

An argument can be passed to the script by expanding it with a slash. **SCRIPT/5** will call **SCRIPT.wts** and pass the parameter "5" in the **wtArg** global variable. The argument is always passed as a string when the script is called from a text command. If no argument is specified, the default argument defined in the script manager will be used (if any).

## Automatically Executed Scripts

Some scripts are being executed automatically, whenever a specific event occurs.

<b>onFileOpen.wts</b>	Executed when .wt4 file is opened
<b>onFileClose.wts</b>	Executed when .wt4 file is closed
<b>onMicrohamFsOn.wts</b>	Executed, when microHAM footswitch is pressed
<b>onMicrohamFsOff.wts</b>	Executed, when microHAM footswitch is released
<b>onOtrspCrOn.wts</b>	Executed, when OTRSP control has value 1
<b>onOtrspCrOff.wts</b>	Executed, when OTRSP control has value 0
<b>onOtrspCrEvent.wts</b>	Executed, for all states of OTRSP events

## Synchronous vs. asynchronous - the #@ Notation

The scripts calls in the CW or RTTY messages are synchronous to the CW or the RTTY streams. To execute them asynchronously, they can be called with the #@ notation. Example:

```
-- script.wts
wtApp:AlertBox("Hello World!");
```

and the CW/RTTY message content is:

```
AAA #SCRIPT BBB
```

The keyer sends AAA, then "waits" until the user hits the OK button in the "Hello World!" alert box to send BBB. If the CW/RTTY message content is:

```
AAA #@SCRIPT BBB
```

The keyer sends AAA and starts the script (and the alert box is open), **but** it continues to key the rest of the message ("BBB") without waiting the user intervention. This is the asynchronous mode.

## Tips for Programming

1. Use the Scripts Manager to manage scripts, using a simple editor like Notepad. The scripts are stored in the {AppData}/All Users/Win-Test/scripts/ directory.
2. Before you can press the Edit button, make sure you have configured an ASCII editor in the Options Menu
3. If you wish to replace the built-in ESM script in Win-Test, save your script as "esm.wts". The value returned by your script will tell Win-Test what to do after it is executed:
  - ◆ If the return value is 0 (or if there is no return value), WT will run its own embedded script after yours.
  - ◆ If the return value is 1, WT will continue the Enter key process, without calling its embedded script.
  - ◆ And if the return value is -1, WT will stop the Enter key process, without calling its embedded script.
4. WT maintains two different QSO status: One for each radio. They are automatically cleared when the QSO is entered, if the operating mode (RUN/S&P) is switched or if the `wtQso:ClearStatus()` is executed.
5. Lua global variables are persistent between scripts calls. If you don't want this behavior, use local variables instead (keyword local).

## Basic Examples

### Example 1

```
-- esm.wts
wtApp:AlertBox("Enter key ! ESM rulez...");
return 0; -- This line can be omitted
-- end
```

No return value (or 0) => WT will execute this script (the alert box will be displayed), and the embedded script will be called after it.

### Example 2

```
-- esm.wts
wtApp:AlertBox("Enter key ! The key is processed by WT");
return 1;
-- end
```

The return value is 1 => After executing the script (the alert box will be displayed), WT will continue its own process and act exactly as if someone hit Enter. Read: It silently enters the QSO if it is OK. The embedded ESM script is ignored.

### Example 3

```
-- esm.wts
wtApp:AlertBox("Enter key ! The key processing is stopped");
return -1;
-- end
```

The return value is -1 => After executing the script (the alert box will be displayed), the embedded ESM script is ignored and WT will also ignore the Enter key process (no QSO is entered).

For a collection of more advanced programming examples please see [user contributed scripts](#) and [advanced programming examples](#).

## Load a target file

This option allows you to load a so-called target file - an ASCII file (maybe self-generated) that has QSO and multiplier targets for each hour of the contest. This is a nice way to integrate a plan into your contest environment to keep yourself motivated. In the old days we used to have a piece of paper on the wall - today Win-Test automatically tracks this information for your convenience.

Before you can load a target file you will have to create one or receive one from somebody else. Please see [Export a target file](#) on how to do that.

The content of the target file becomes visible in the statistics window (see [Statistics](#)) when you compare current standings with the values in the target file.

Loading a target file is usually a Pre-contest configuration task. Please refer to the usual [Pre-contest configuration](#) activities chapter in this manual.

A target file can also be loaded at any time during the contest. If you see your target score was too easy, you can load a new target to keep your motivation high. You set a target to break your national record, and now things go better and you see the possibility to break the continental record. How can you track this new situation? Preparing more than one file with different targets is a good practice: if conditions change then simply load the new target file and WT will show you how you are doing against that new target!

## Export a target file

This option allows you to create a target file from the log file currently loaded. It is useful to use last year's log as a start to create a target for this year's contest.



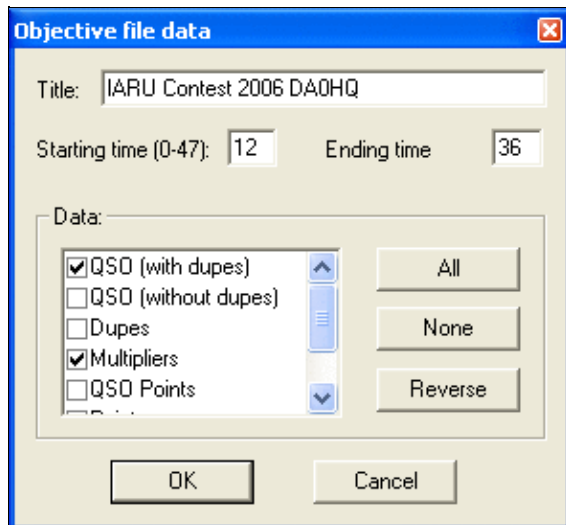

### Exporting a target (.obf) file

You should give a title to the target file to make clear what you're comparing to. Maybe you will want to change the target file to a more optimistic one when you'll realize band conditions are so great this time!

You may want to select which time frame to export (Starting time, ending time). Hours on Sunday have to be given in time + 24 hours so that 12:00 UTC on Sunday becomes 36.

Next you have to choose which columns to export to the target file. Normally you will want QSO count (with or without dupes), multipliers and points.

After pressing **OK** a file with the extension **.obf** will be created which will look similar to the file below:

```
#
# Target file generated by Win-Test
#
# VERSION 100
#
TITLE IARU Contest 2006 DA0HQ
START = 12
END = 36
12 QSO = 0 MULT = 0 POINTS = 0
13 QSO = 1 MULT = 1 POINTS = 1
14 QSO = 1 MULT = 1 POINTS = 1
15 QSO = 1 MULT = 1 POINTS = 1
16 QSO = 1 MULT = 1 POINTS = 1
17 QSO = 2 MULT = 2 POINTS = 4
18 QSO = 3 MULT = 2 POINTS = 4
19 QSO = 4 MULT = 2 POINTS = 6
20 QSO = 4 MULT = 2 POINTS = 6
21 QSO = 4 MULT = 2 POINTS = 6
22 QSO = 8 MULT = 3 POINTS = 18
23 QSO = 8 MULT = 3 POINTS = 18
24 QSO = 8 MULT = 3 POINTS = 18
25 QSO = 8 MULT = 3 POINTS = 18
26 QSO = 8 MULT = 3 POINTS = 18
27 QSO = 8 MULT = 3 POINTS = 18
28 QSO = 8 MULT = 3 POINTS = 18
29 QSO = 8 MULT = 3 POINTS = 18
30 QSO = 8 MULT = 3 POINTS = 18
31 QSO = 8 MULT = 3 POINTS = 18
```

32 QSO = 18 MULT = 3 POINTS = 21  
33 QSO = 30 MULT = 5 POINTS = 45  
34 QSO = 42 MULT = 5 POINTS = 50  
35 QSO = 81 MULT = 7 POINTS = 224

As you can see the structure of the file is so easy to understand that you might want to use an ASCII editor to go and make some changes - or create it completely from scratch yourself using this template!

## Check log

This tool allows you to verify if special restrictions of the contest rules have been adhered to in this log. You have different options, depending on the category you choose (see pictures below):

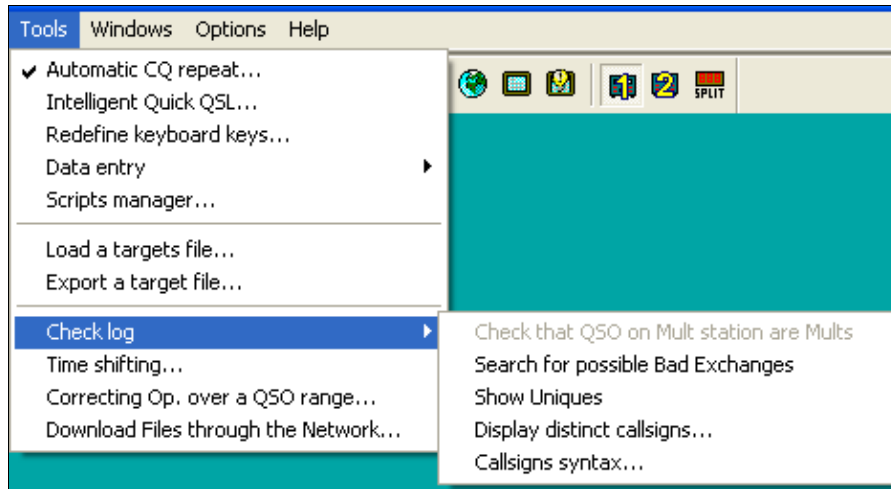

Check Log feature for the single operator category

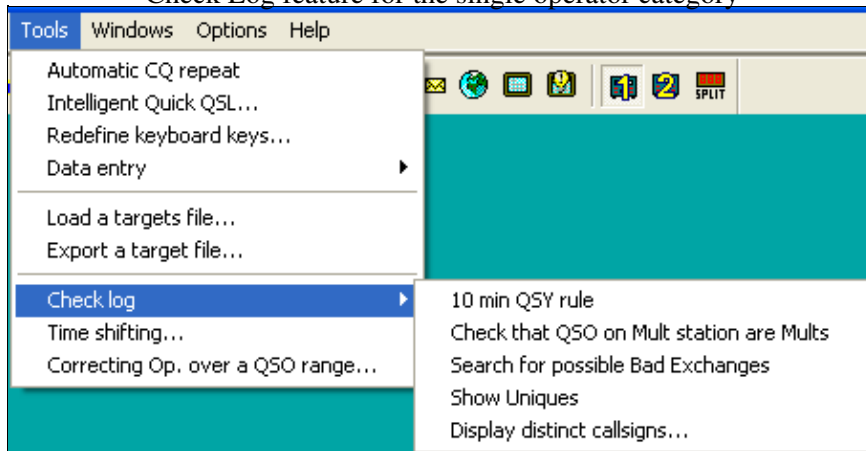

## Check Log feature for M/S category

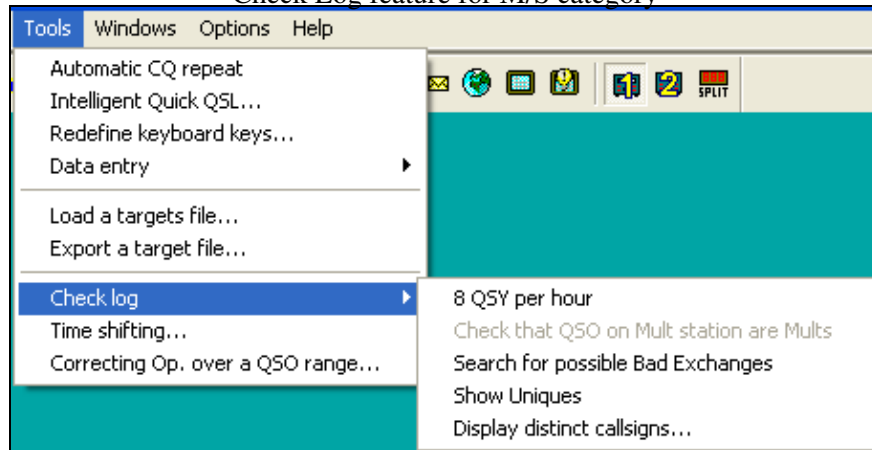

Check Log feature for the M2 category - note the differences in options offered. If you select a contest and/or category which does not have a QSY limit, this option will not show up.

Depending on the selected contest category, you may check for:

- **8 QSY per Hour:** Check the QSY count per hour (ARRL DX in M/2 category for example).
- **10 min QSY rule:** Check if the minimum time on a band has been respected (Multiplier station in a M/S effort during a CQWW DX for example).
- **Check that QSO on Mult station are Mults:** Check if all QSOs made on the multiplier station are actually multipliers. You may want to quote the exceptions (if any) when sending your log to the contest sponsor to avoid massive score reductions.
- **Search for possible Bad Exchanges:** Search the logged exchanges which are potentially bad, according to the database or to the other QSOs made with the same station during the contest. Works for CQWW, ARRL DX or any contest in which there is something which apparently is a zone. It also works for the VHF contest when a Gridsquare is logged.
- **Show Uniques:** Search N+1 for each unique logged callsign in the log. A unique callsign is a callsign that appears in the log only once (contact only on one band and mode, and no dupe). N+1 can be searched against the log, the callsign database (Master database) or both. It is possible to switch off N+1 searching for unique callsigns which are known to the callsign database.
- **Display distinct callsigns...:** Display all distinct callsigns of a log, and band(s)/mode(s) worked by each station. You can sort this report by callsign, by number of Q and by country.
- **Callsigns syntax...:** Match the callsigns to the callsign pattern file (see [Other Files](#)).
- **Open the notes linked to the current log:** Allows you to comfortably walk through your notes taken during the contest. Clicking on a line brings you to that specific QSO. Edit a note by selecting it and use **Alt-N** to modify the comment.
- **Open a different notes file:** Switch notes file, if more than one exists.
- **Download the LCR file:** Download your Log Check Report from the contest web site.

## Win-Test Wiki

- **Open a Different LCR file:** Switch to a different Log Check Report.

These are some of the typical reports you get:

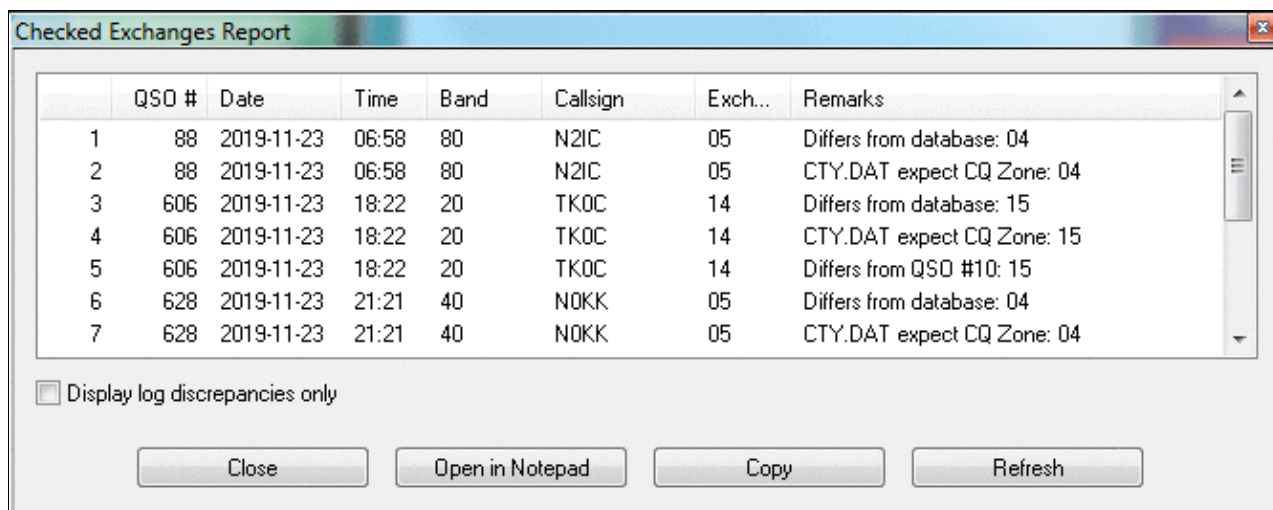

The screenshot shows a window titled "Checked Exchanges Report". It contains a table with 8 columns: QSO #, Date, Time, Band, Callsign, Exch..., and Remarks. There are 7 rows of data. Below the table is a checkbox labeled "Display log discrepancies only" which is unchecked. At the bottom are four buttons: "Close", "Open in Notepad", "Copy", and "Refresh".

QSO #	Date	Time	Band	Callsign	Exch...	Remarks	
1	88	2019-11-23	06:58	80	N2IC	05	Differs from database: 04
2	88	2019-11-23	06:58	80	N2IC	05	CTY.DAT expect CQ Zone: 04
3	606	2019-11-23	18:22	20	TK0C	14	Differs from database: 15
4	606	2019-11-23	18:22	20	TK0C	14	CTY.DAT expect CQ Zone: 15
5	606	2019-11-23	18:22	20	TK0C	14	Differs from QSO #10: 15
6	628	2019-11-23	21:21	40	N0KK	05	Differs from database: 04
7	628	2019-11-23	21:21	40	N0KK	05	CTY.DAT expect CQ Zone: 04

### Checked Exchanges Report

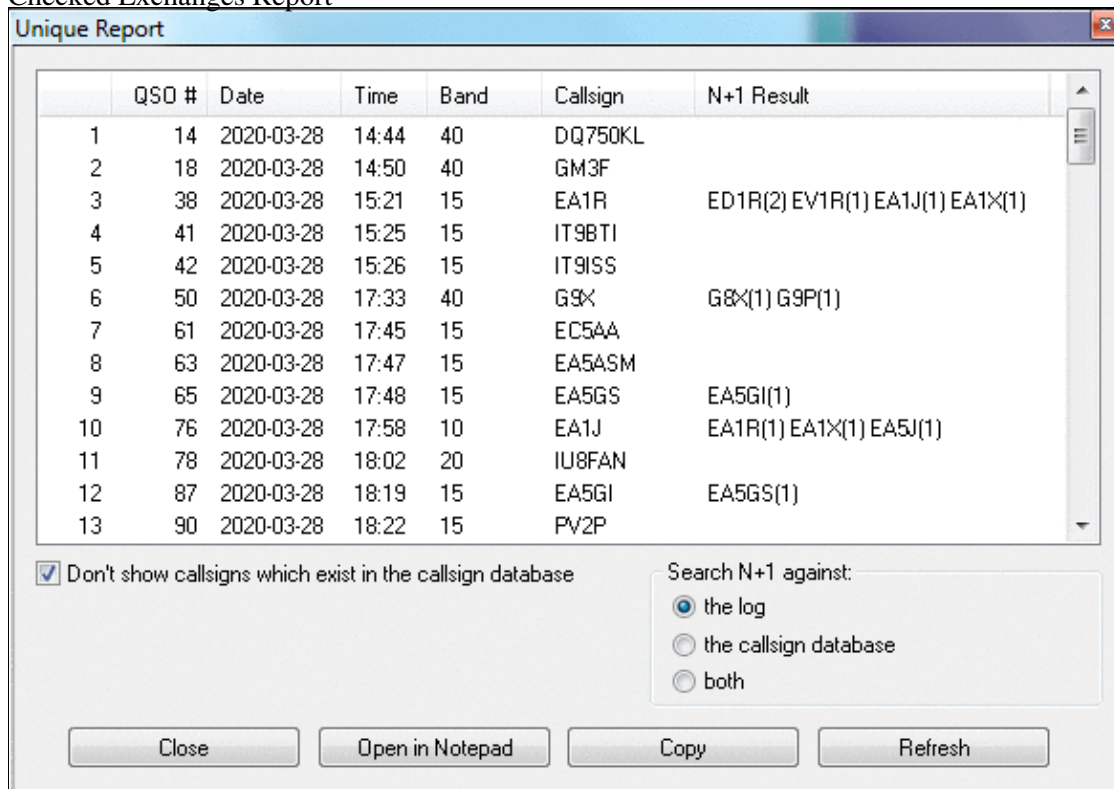

The screenshot shows a window titled "Unique Report". It contains a table with 7 columns: QSO #, Date, Time, Band, Callsign, and N+1 Result. There are 13 rows of data. Below the table is a checkbox labeled "Don't show callsigns which exist in the callsign database" which is checked. To the right of this checkbox is a section titled "Search N+1 against:" with three radio button options: "the log" (selected), "the callsign database", and "both". At the bottom are four buttons: "Close", "Open in Notepad", "Copy", and "Refresh".

QSO #	Date	Time	Band	Callsign	N+1 Result
1	14	2020-03-28	14:44	40	DQ750KL
2	18	2020-03-28	14:50	40	GM3F
3	38	2020-03-28	15:21	15	EA1R ED1R(2) EV1R(1) EA1J(1) EA1X(1)
4	41	2020-03-28	15:25	15	IT9BTI
5	42	2020-03-28	15:26	15	IT9ISS
6	50	2020-03-28	17:33	40	G9X G8X(1) G9P(1)
7	61	2020-03-28	17:45	15	EC5AA
8	63	2020-03-28	17:47	15	EA5ASM
9	65	2020-03-28	17:48	15	EA5GI(1)
10	76	2020-03-28	17:58	10	EA1J EA1R(1) EA1X(1) EA5J(1)
11	78	2020-03-28	18:02	20	IU8FAN
12	87	2020-03-28	18:19	15	EA5GI EA5GS(1)
13	90	2020-03-28	18:22	15	PV2P

Unique Report

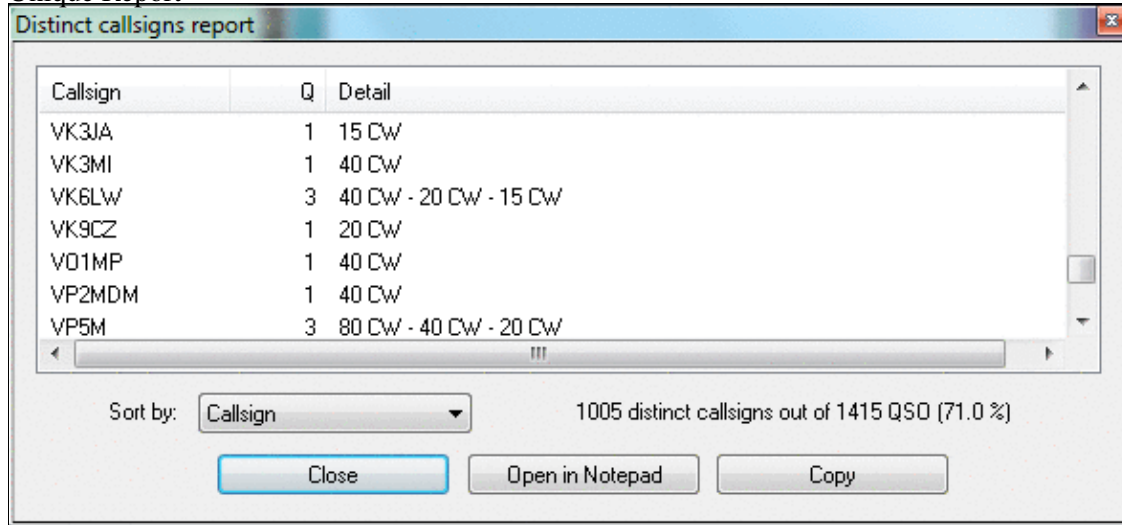

Distinct Callsigns Report - see who you worked on which bands/modes

You have the options of opening the report in a Notepad window for further processing. The Copy button allows you to Copy & Paste the data into a spreadsheet for comfortable filtering and processing. Additionally, you may press the Update button to create an updated report after you have done some changes to the log.

## Time shifting

This option allows you to **time shift** selected QSOs by any amount of time - either positive or negative. It lets you correct a constant time offset (like you had set the wrong date on the computer, or the clock was off by one hour). You may consider to use this option after the contest to avoid heavy manual editing of many QSO's time through the use of **Alt-F**.

The time shift can be applied to the entire log or to a range of QSOs, to the QSOs entered by your own station (this could make sense in a multi operator environment), to QSOs entered by several stations. Note that in a multi operator environment, one station should always be (or should have been) defined as the time master to establish a common time base in the network.

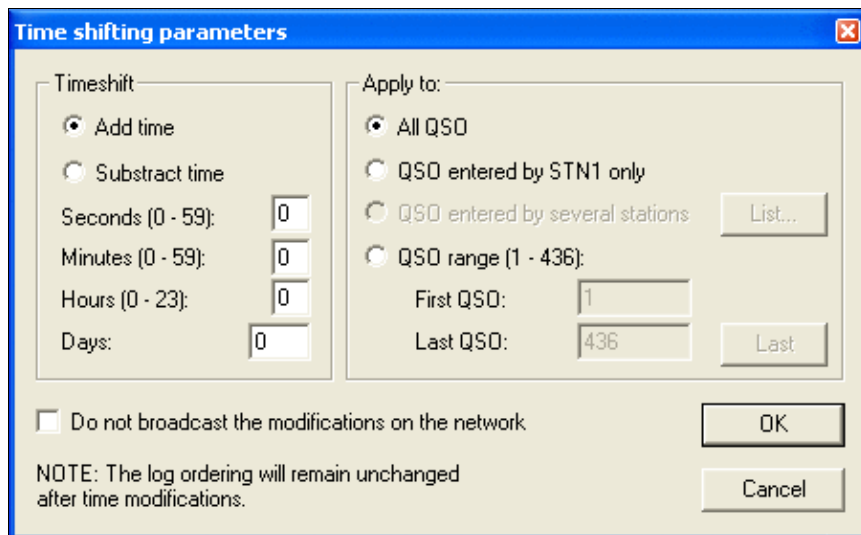

### Time Shifting Parameters

Even though this tool is supposed to be used after a contest to correct a wrong clock setting, each time change will be broadcasted to all other stations of the network by default. You can disable this broadcasting — if not needed.

Note that time shifting is pretty CPU consuming. It may take quite some time for large logs, because each QSO modification requires several internal structures (mainly statistics) to be updated accordingly. Time shifting **can not be cancelled** while it is in progress, to avoid any log inconsistency.

**Note:** Wise users will create a backup of their log before using this option.

## Correcting OP over a QSO range

This function lets you change (or add) the operator to a range of QSO. The QSOs are selectable by QSO number, by band, by mode or by callsign.

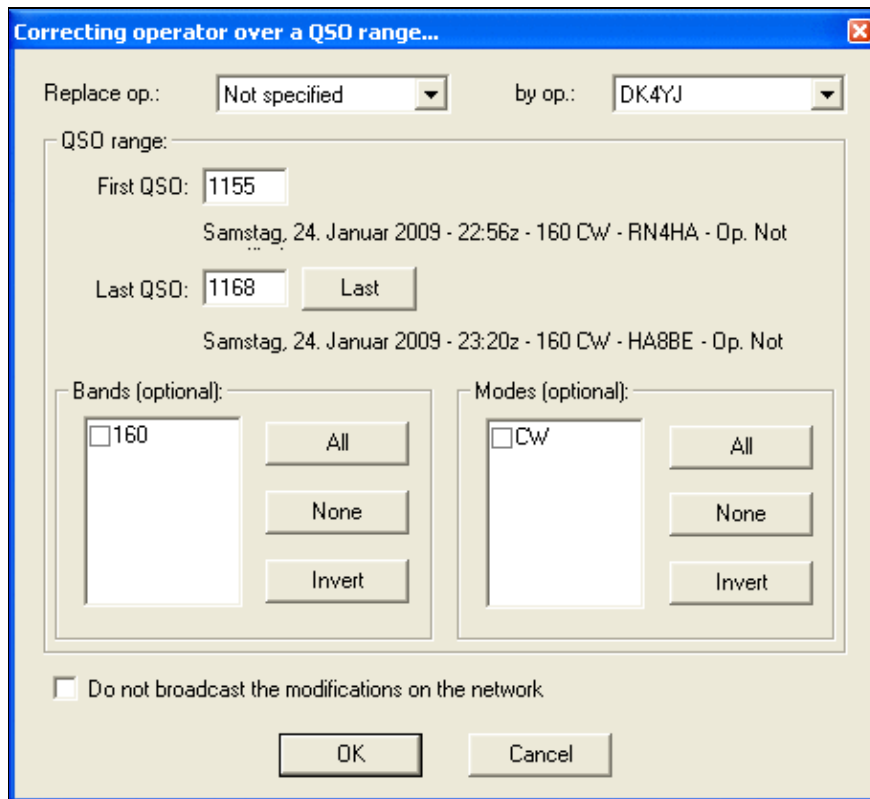

Tool to correct operator for a range of QSOs

## Download Files through the Network

To collect logs from different networked computers after a contest is over is the task of this function. Instead of having to visit each single computer, plug in the USB drive, copy the files over and move on to the next, this feature let's you collect the binary and notes files from all computers at once.

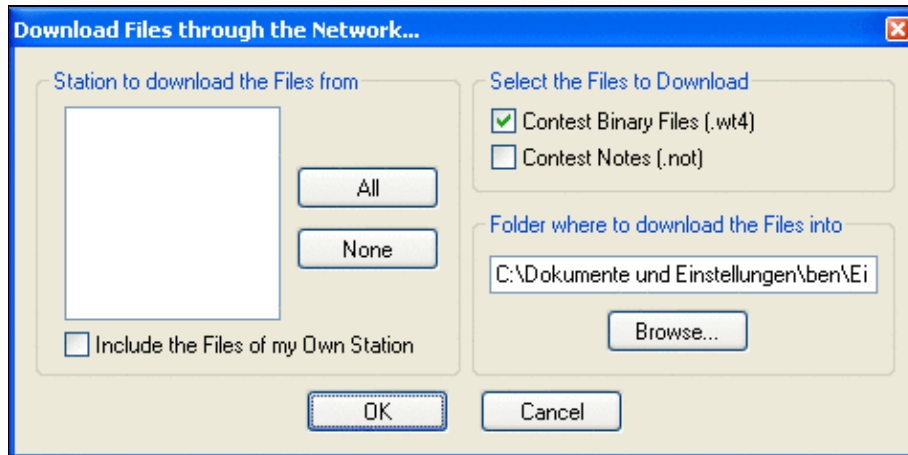

Collect files after the contest without leaving your chair

[Back to Menu](#)

## Namespaces

- [Page](#)
- [Discussion](#)

## Variants

## Views

- [Read](#)
- [View source](#)
- [View history](#)

## More

- This page was last edited on 9 April 2023, at 15:19.

- [Privacy policy](#)
- [About Win-Test Wiki](#)
- [Disclaimers](#)



# Menu:Windows

From Win-Test Wiki

[Jump to navigation](#) [Jump to search](#)

## Menu:Windows

Most of the windows have a context or "pop-up" menu which can be opened by right-clicking on the window.

All windows can be moved by "dragging" the title bar with the mouse pointer. Simply hold down the left mouse button while the cursor is over the title bar, and drag the window with the mouse. Another option is to hold down the **Ctrl** key and the left mouse button while the mouse pointer is positioned anywhere within a window (except for the RTTY reception windows), then drag.

**Tip:** Hold down the **Shift** key while dragging or resizing a window to "snap" it into position, right next to the edge of an adjacent window.

## Contents

- [1 Log Entry \(Main window\)](#)
- [2 Worked Gridsquares](#)
- [3 Worked Zones](#)
- [4 Worked DXCC](#)
- [5 Check Callsign](#)
- [6 Check Multipliers](#)
- [7 Search for Worked Multipliers or Partial QTH Locators](#)
- [8 Check Partial](#)s
- [9 Check N + 1](#)
- [10 Partner](#)
- [11 Status](#)
- [12 Skeds](#)
- [13 Solar Activity](#)
- [14 QSY Wizard](#)
- [15 Extra Information](#)
  - ◆ [15.1 XDT Files](#)
  - ◆ [15.2 Directives](#)
- [16 Summary](#)
  - ◆ [16.1 Live Score](#)
- [17 Rate](#)
  - ◆ [17.1 Graphs](#)
  - ◆ [17.2 Text Information](#)
  - ◆ [17.3 Context Menu](#)
- [18 Statistics](#)
- [19 Gab](#)
- [20 World Map](#)
- [21 Radio 1, Radio 2 \(Band Maps\)](#)
  - ◆ [21.1 Band Maps Context menu](#)
    - ◇ [21.1.1 Special cursors](#)
    - ◇ [21.1.2 Extended information](#)



- ◇ [21.1.3 Markers](#)
- ◇ [21.1.4 Segments](#)
- ◇ [21.1.5 Band Map properties](#)

- [22 Secondary Radio](#)
- [23 RTTY \(radio1, radio2\)](#)
- [24 Rotators](#)
- [25 DX-Cluster Monitor](#)
- [26 DX-Cluster Announcements](#)
- [27 NCDXF/IBP Beacons](#)
- [28 Clock](#)
- [29 Contest Recorder](#)
- [30 SSB bargraph](#)
- [31 Close all Windows](#)

## Log Entry (Main window)

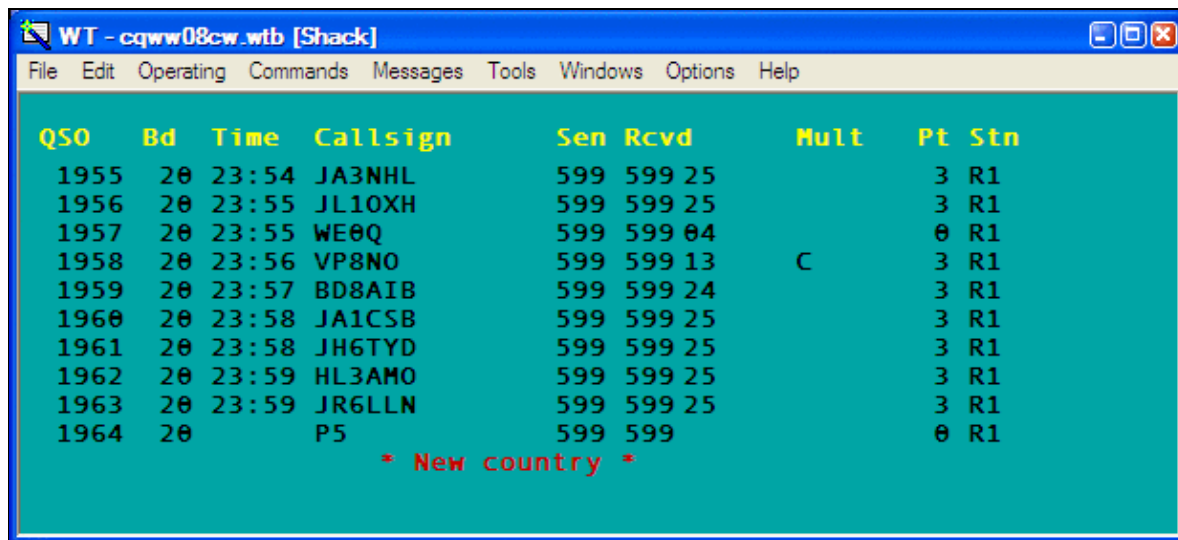

The screenshot shows the Win-Test main logging window titled "WT - cqww08cw.wtb [Shack]". The window has a menu bar with "File", "Edit", "Operating", "Commands", "Messages", "Tools", "Windows", "Options", and "Help". The main area displays a log of QSOs with the following columns: QSO, Bd, Time, Callsign, Sen, Rcvd, Mult, Pt, and Stn. The log entries are as follows:

QSO	Bd	Time	Callsign	Sen	Rcvd	Mult	Pt	Stn
1955	20	23:54	JA3NHL	599	599 25		3	R1
1956	20	23:55	JL10XH	599	599 25		3	R1
1957	20	23:55	WE0Q	599	599 04		0	R1
1958	20	23:56	VP8NO	599	599 13	C	3	R1
1959	20	23:57	BD8AIB	599	599 24		3	R1
1960	20	23:58	JA1CSB	599	599 25		3	R1
1961	20	23:58	JH6TYD	599	599 25		3	R1
1962	20	23:59	HL3AMO	599	599 25		3	R1
1963	20	23:59	JR6LLN	599	599 25		3	R1
1964	20		P5	599	599		0	R1

Below the log entries, there is a red asterisk followed by the text "New country" and another red asterisk: \* New country \*

The Win-Test main logging window.

Use the Win-Test main window or "Log Entry" window to enter all QSOs made on the primary radio. The window displays the last nine QSOs in the log, plus a tenth line for entering the next QSO. The title bar displays the current log file name, the station name entered in the [Contest Configuration window](#) (e.g. "[Shack]"), and the current operator's callsign (for multi-ops that use the **OPON** or **LOGIN** text commands). By default, the Win-Test main window serves as a background for all other windows, but you may also choose to have every window "float" independently (see [Menu:Options#Windows](#)).

When you close the log entry window, Win-Test terminates.

Any QSO may be edited simply by typing over anything that needs correction. Use the **[Up arrow]** and **[Down arrow]** keys to edit previous QSOs. To restore the original QSO data, press **Ctrl-Z** before moving the cursor from that line. You can also delete a QSO (if single-op), though it is usually better to just enter a duplicate QSO -- see [Menu>Edit#Delete\\_QSO](#) for more information.

When the cursor is positioned in the callsign field, data is entered in "insert mode", that is, typing does not replace characters, it only inserts them. In all other fields, data is entered in "overtyping mode". See [this entry in the FAQ](#) for the rationale.

The **[Spacebar]** key is used to quickly move the cursor back and forth between the callsign field and the received exchange field, skipping over the RST columns.

**Tip:** Enter a "?" character in the middle of a callsign or exchange as a placeholder for missing information, e.g. F?MZN. Then when you press **[Spacebar]**, the cursor will jump directly to the "?" character, and you can overwrite it with the missing data (even in the callsign field).

The **[Backspace]**, **[Del]**, **[Left arrow]**, **[Right arrow]**, **[Home]**, **[End]**, **[Ctrl][Left arrow]** and **[Ctrl][Right arrow]** keys operate conventionally, within a single field; they do not move the cursor outside of the current field.

The **[Tab]** key may be used to position the cursor under the RST sent column as well as callsign and exchange. The **[>]** and **[<]** keys work similarly, but they also allow you to move the cursor to the QSO time field for direct editing. You can also change the time, date, frequency, serial number sent and other fields of a QSO by positioning the cursor on any line and pressing **[Alt-F]** to display the Edit QSO pop-up menu.

You may scroll back through the entire log by pressing the **[PageUp]** and **[PageDown]** keys.

**Tip:** Press **Ctrl-PageUp** to scroll back in the log by 24 hours.

Enter a **QSO number** on the last line and press **[Ctrl-g]** to "Go to" that QSO number in the log. Press **[Ctrl-g] [Enter]** to return to the bottom of the log.

Enter a callsign, prefix or **beam heading** (0 to 360°) on the last line and press **[Ctrl]+[F12]** to rotate to that heading. Press **[Alt]+[F12]** for long (or "alternate") path. For more information, see Rotators.

Many other keys may be used in this window to assist with rapid data entry. For example, **[F11]** clears the entire QSO, whereas **Ctrl-W** clears only the current field. See Keys - Editing and moving around the QSO entry line.

The font size, background color, and header line attributes of this window may be adjusted by right clicking and selecting the **Log** option (see Menu:Options#Log). The yellow header text can be centered, left-justified, or completely hidden.

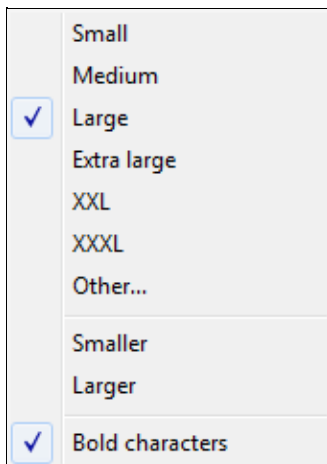

Changing the log font size of the log window.

The columns vary from contest to contest. In the CQ World-Wide example above,

- **QSO** - raw QSO number. Can be hidden using [Hide QSO numbers](#) (recommended for Multi-Multi contests with a sent serial number)
- **Bd** - band. Can be changed with [**Alt-F1**], [**Alt-F2**], or [**Alt-F**]
- **Time** - QSO time (UTC). Can be changed by moving the cursor with the [**<**] key, or [**Alt-F**]
- **Callsign** - Callsign of station worked.

**Tip:** Enter Win-Test [text commands](#) (menu shortcuts) in the callsign field.

- **Sen/Rcvd** - Sent and received exchanges
- **Mult** - multipliers and other information:
  - ◆ **C** - Country multiplier
  - ◆ **Z** - Zone multiplier
  - ◆ **DUPE** - Duplicate contact
  - ◆ **????** - Multiplier in received exchange field not recognized (e.g. unrecognized state or section abbreviation, zone number out of range)
  - ◆ **////** - Unrecognized country prefix
  - ◆ **!!!!** - Multiplier violation (non-mult worked by a Mult station in a Multi-single, band change violation, etc.)
  - ◆ *other* - Prefix, country, state, grid, etc. multiplier
- **Pt** - QSO points
- **Stn** - Station identifier (can be changed by pressing **Alt-Y** - see [Keys#Multi\\_Operator](#))
  - ◆ **R1/R2** - Run 1 or Run 2 (multi-two), or Radio 1 / Radio 2 (SO2R).
  - ◆ **R/M** - Run or Mult (Multi-single)
  - ◆ **+** (suffix) - Indicates QSO data entered by a support or [partner station](#)

Finally, a red information line at the bottom of the window displays additional information, such as

- **\* New zone \***
- **\* New country \***
- **\* Dupe with #1963 at 23:59Z 2008-11-30 (25) \***
- **\* Spotted by F5MZN \***
- Brief one-line packet cluster announcements of new multipliers

## Worked Gridsquares

Windows | Worked Gridsquares or **Alt-L**

Opens (or closes) the gridsquares window. The gridsquares worked are in grey, the red spots are the stations worked and the green spots are the stations spotted. The current gridsquare is displayed in red color to give an indication of direction. This works even with only four of the six characters entered.

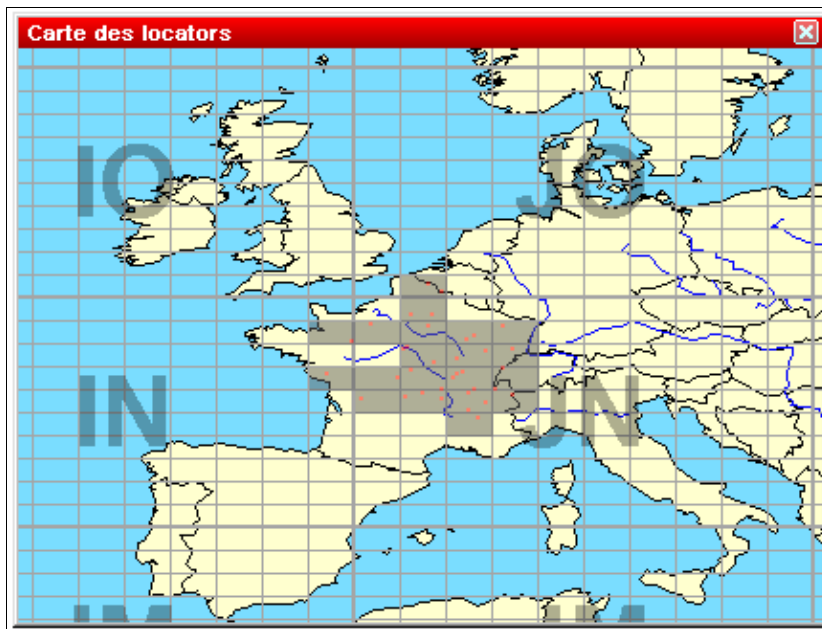

### Gridsquares Map

If the DX-Cluster Announcements window is opened and the gridsquare of a spot is known, passing the mouse over this spot will blink its location in this window.

Right click on the map to display the pop-up window:

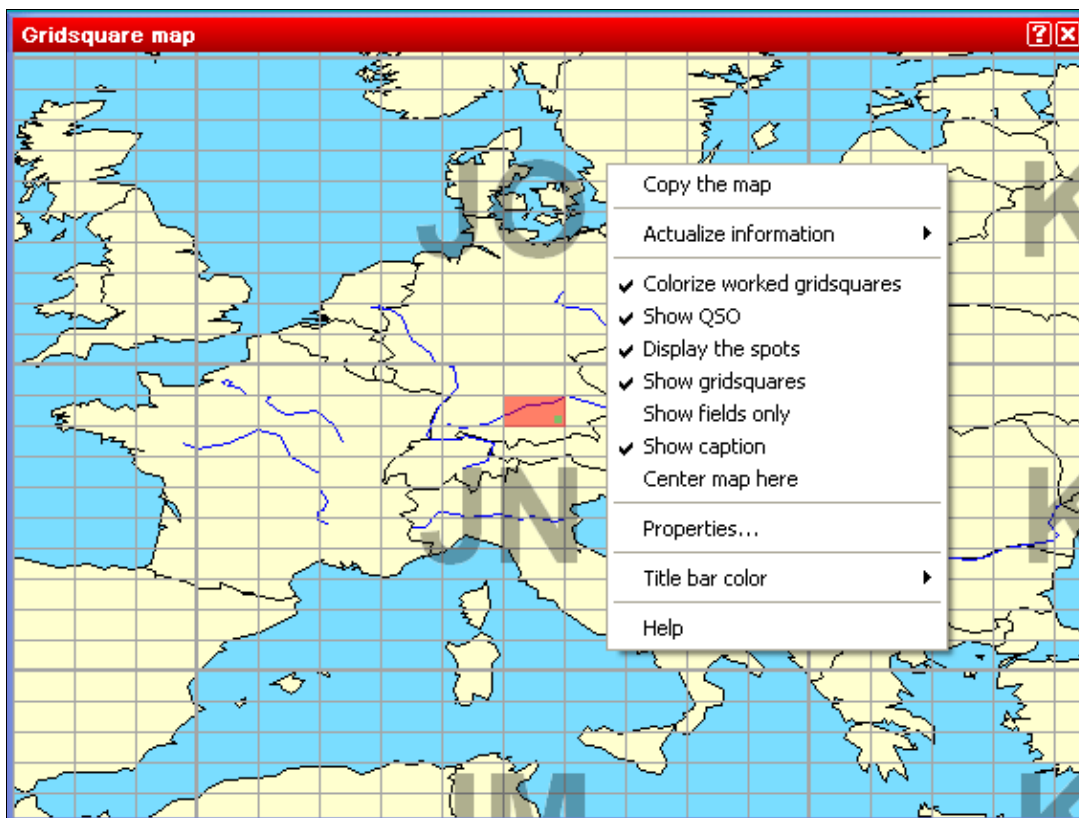

Gridsquare map pop-up window displayed by right-clicking on the map

- **Copy the map** copies the image to the Windows clipboard
- **Actualize Information** controls when the map will be updated:
  - ◆ Pressing the spacebar
  - ◆ Automatically
- **Colorize worked gridsquares** marks worked grid squares in gray
- **Show QSO** marks QSOs with a red dot
- **Display the spots** marks spotted stations with a green dot
- **Show gridsquares** draws the squares and the grid square lines
- **Show fields only** turns grid square outlines off
- **Show caption** displays the major grid square names (first two letters)
- **Center map here** lets you move the center of the map interactively.

**Note:** This option is available only if you have **not** selected "Always center on the operating QTH" in the Properties dialog (see below).

- **Properties...** allows you to modify several display parameters:

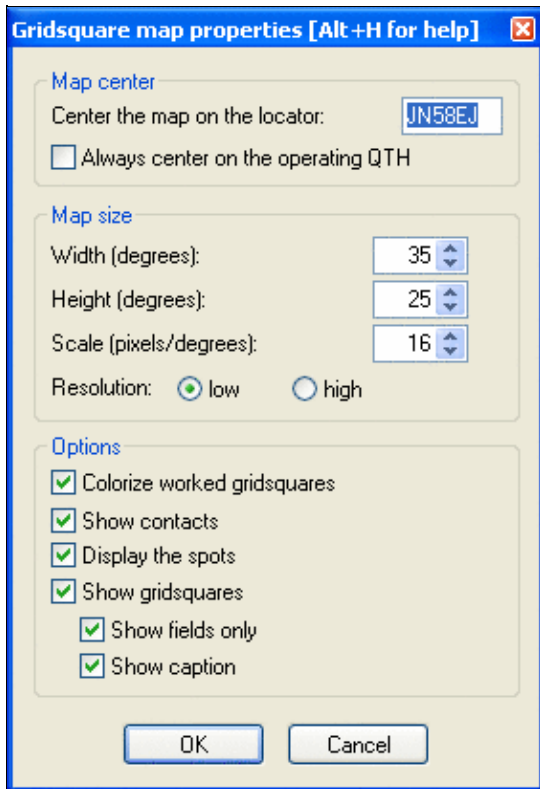

Gridsquares Map Properties

The larger the scale, the bigger the map.

## Worked Zones

Windows | Worked Zones or **Alt-Z**

Opens (or closes) the worked zones window. The title of this menu item will fit to the chosen contest. The window displays the worked multipliers (in blue) or not (in white) on the current band, and possibly the current mode.

Some examples:

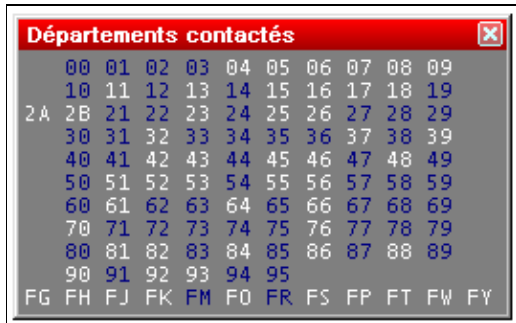

Worked departements window (French REF HF contest)

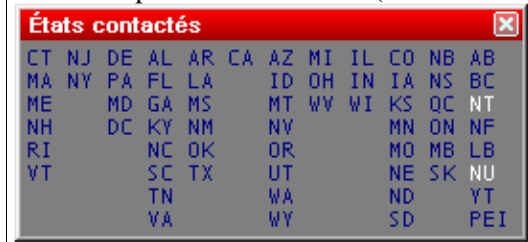

Worked states and provinces window (International ARRL DX contest)

Furthermore, with a right click on this window (if the contest is multi-bands and/or multi-modes) you can display the distribution of these multipliers by band (and/or mode).

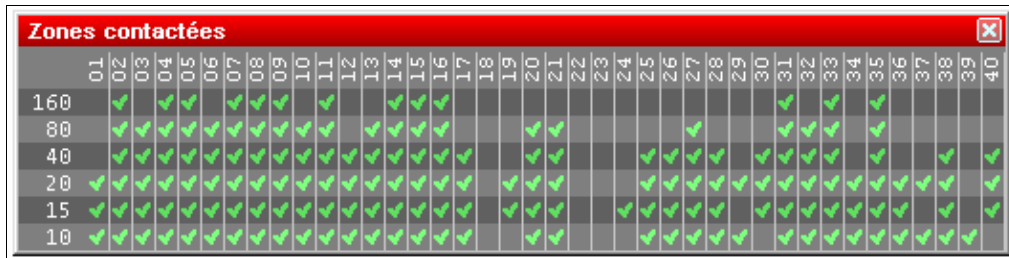

WAZ zones worked window by band (CQWW DX contest)

At last, the same contextual menu allows you to copy all the datas of this window into the clipboard as an image or a text, and directly paste it as a text file or an Excel (TM) or OpenOffice spreadsheet.

## Worked DXCC

Windows | Worked DXCC or **Alt-M**

Opens (or closes) the worked DXCC window. The title of this menu item will change with the contest chosen.

The screenshot shows a window titled "DXCC contactés" with a red header bar. The window is divided into two main sections: "Amérique du Sud" and "Afrique", each with a yellow header bar. Each section contains a list of DXCC stations with their call signs and associated numerical data (likely counts for different bands or modes). The data is presented in a grid-like format with three columns of call signs and their corresponding values.

Amérique du Sud		
3Y/p	: 160 80 40 20 15 10	
CE	: 160 80 40 20 15 10	
CE0Z	: 160 80 40 20 15 10	
CX	: 160 80 40 20 15 10	
HC8	: 160 80 40 20 15 10	
LU	: 160 80 40 20 15 10	
PJ2	: 160 80 40 20 15 10	
PY0S	: 160 80 40 20 15 10	
VP8	: 160 80 40 20 15 10	
VP8/o	: 160 80 40 20 15 10	
ZP	: 160 80 40 20 15 10	
8R	: 160 80 40 20 15 10	
CE0A	: 160 80 40 20 15 10	
CE9	: 160 80 40 20 15 10	
FY	: 160 80 40 20 15 10	
HK	: 160 80 40 20 15 10	
OA	: 160 80 40 20 15 10	
PY	: 160 80 40 20 15 10	
PY0T	: 160 80 40 20 15 10	
VP8/g	: 160 80 40 20 15 10	
VP8/s	: 160 80 40 20 15 10	
9Y	: 160 80 40 20 15 10	
CE0X	: 160 80 40 20 15 10	
CP	: 160 80 40 20 15 10	
HC	: 160 80 40 20 15 10	
HK0/m	: 160 80 40 20 15 10	
P4	: 160 80 40 20 15 10	
PY0F	: 160 80 40 20 15 10	
PZ	: 160 80 40 20 15 10	
VP8/h	: 160 80 40 20 15 10	
YW	: 160 80 40 20 15 10	
Afrique		
3B6	: 160 80 40 20 15 10	
3C	: 160 80 40 20 15 10	
3V	: 160 80 40 20 15 10	
5A	: 160 80 40 20 15 10	
5R	: 160 80 40 20 15 10	
5V	: 160 80 40 20 15 10	
6W	: 160 80 40 20 15 10	
7X	: 160 80 40 20 15 10	
9L	: 160 80 40 20 15 10	
9X	: 160 80 40 20 15 10	
C9	: 160 80 40 20 15 10	
D2	: 160 80 40 20 15 10	
E3	: 160 80 40 20 15 10	
EL	: 160 80 40 20 15 10	
FR	: 160 80 40 20 15 10	
FR/t	: 160 80 40 20 15 10	
FT8Z	: 160 80 40 20 15 10	
J5	: 160 80 40 20 15 10	
3B8	: 160 80 40 20 15 10	
3C0	: 160 80 40 20 15 10	
3X	: 160 80 40 20 15 10	
5H	: 160 80 40 20 15 10	
5T	: 160 80 40 20 15 10	
5X	: 160 80 40 20 15 10	
7P	: 160 80 40 20 15 10	
9G	: 160 80 40 20 15 10	
9Q	: 160 80 40 20 15 10	
A2	: 160 80 40 20 15 10	
CN	: 160 80 40 20 15 10	
D4	: 160 80 40 20 15 10	
EA8	: 160 80 40 20 15 10	
ET	: 160 80 40 20 15 10	
FR/g	: 160 80 40 20 15 10	
FT8W	: 160 80 40 20 15 10	
IG9	: 160 80 40 20 15 10	
S0	: 160 80 40 20 15 10	
3B9	: 160 80 40 20 15 10	
3DA	: 160 80 40 20 15 10	
3Y/b	: 160 80 40 20 15 10	
5N	: 160 80 40 20 15 10	
5U	: 160 80 40 20 15 10	
5Z	: 160 80 40 20 15 10	
7Q	: 160 80 40 20 15 10	
9J	: 160 80 40 20 15 10	
9U	: 160 80 40 20 15 10	
C5	: 160 80 40 20 15 10	
CT3	: 160 80 40 20 15 10	
D6	: 160 80 40 20 15 10	
EA9	: 160 80 40 20 15 10	
FH	: 160 80 40 20 15 10	
FR/j	: 160 80 40 20 15 10	
FT8X	: 160 80 40 20 15 10	
J2	: 160 80 40 20 15 10	
S7	: 160 80 40 20 15 10	

### Worked DXCC countries window

If one DXCC country has been worked on a band (possibly a mode), this band will be displayed in blue, otherwise it remains in white. This window is resizable.

A right click on this window allows to display the countries alphabetically sorted (within the same continent), or sorted by number of band/mode worked. More, to easily search for missing countries, the countries worked on all bands can be hidden (clean sweeps). Also, countries never worked in the contest can be hidden.

You can easily move to the next (or previous) bookmark - displayed on a yellow background by default - by holding the **Shift** key down, while rolling your mouse wheel.

Last, all the data included in this window can be copied as a text file, and pasted in text or directly in an Excel (TM) or OpenOffice spreadsheet, for a later analysis.

## Check Callsign

Windows | Check Callsign or **[F9]**

Opens (or closes) the worked callsign window. This window displays a checkmark if and on which bands a specific callsign has been logged before. Depending on the type of the contest, the display may show more than one column to display the different possible modes.

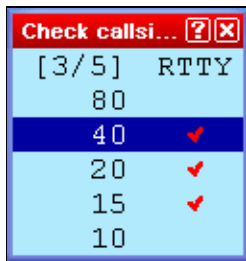

### The Check Callsign Window

Moving the mouse cursor over the checkmark will bring up additional information about this QSO. And a double-click on it will move the cursor to this QSO.

## Check Multipliers

Windows | Check Multipliers or **[F10]**

Opens (or closes) the checking multipliers window.

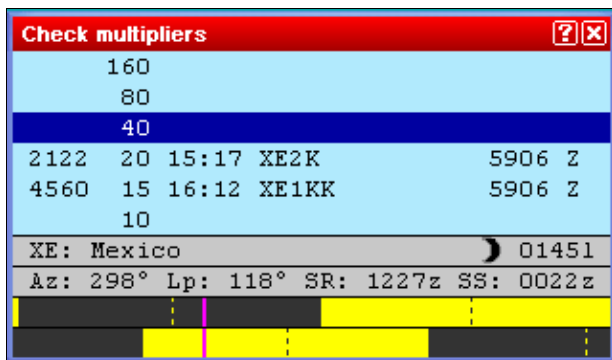



Check Multipliers window for the CQ World-Wide DX contest

To use this window, enter a callsign or country prefix in the data entry area of the main logging window. The dark blue line indicates the current band. The other lines indicate whether this multiplier has been worked or not on other bands (and in other modes if the contest rules permit). If the callsign entered has been worked on other bands, Win-Test displays those QSOs (in DXpedition mode, also the date of the QSO is displayed). Otherwise, the callsign of the first station worked in that multiplier on that band is displayed, if any. For the CQ World-Wide DX contest, display priority is: same callsign, same country and same zone. An uppercase "Z" in the last column indicates that the zone and country have been worked on the indicated band. A lowercase "z" means the zone has been worked, but not the country. And of course a blank line indicates that both the zone and country are needed. See also the [Search for Worked Multipliers](#) window.

Additional information about the multiplier is displayed at the bottom:

- The official country prefix and country name
- A small icon indicating if it is local day, night, or sunrise/sunset time in that country
- The current local time in that country (suffixed by a lowercase "l")
- The short (Az) and long path (Lp) beam headings (azimuths) to this multiplier (based on the station locator entered in the [Contest configuration screen](#))
- The sunrise (SR) and sunset (SS) time in this country, expressed as UTC (suffixed by a lowercase "z"). These times are computed from the geographical coordinates given taken from the CTY\* file or your QTH locator, if specified in the setup dialog.
- Graphical indication of the sun status on both sides of the QSO (may be disabled via the context menu)
  - ◆ Two yellow bars represent the sun over 24 hours of the day. The top bar displays the situation at the DX location, while the bottom bar represents your own location.
  - ◆ A pink cursor denotes current time.
  - ◆ Dotted lines represent local noon or local midnight.

A double click on a line will move the cursor to the specified QSO. Press [**Ctrl-End**] or [**Ctrl-G**], [**Enter**] to return the cursor to the blank line at the end of the data entry area.

Finally, using the context menu (right click on the window), you can change **Actualize information to Automatically** (recommended) or to **Pressing the space bar** to indicate when you want the check multiplier screen to be updated. "Automatically" updates the screen after each keystroke. Any modification in the received exchange field (e.g. zone) also updates this check multiplier window.

## Search for Worked Multipliers or Partial QTH Locators

Windows | Search for Worked Multipliers

Keyboard shortcut: **Shift+F10**

Lists all the callsigns logged in a specified multiplier (Zone, State, ARRL Section, Grid Square Locator, etc.).

To quickly list everyone you have logged in a particular multiplier, sorted by band, enter the multiplier in the *callsign* field and press **Shift+F10**. The [Check Partial Window](#) will be displayed in a different format, as shown below.



Looking for a departement during the REF HF Contest



Looking for a WAZ zone during the CQWW DX (Zone 40)

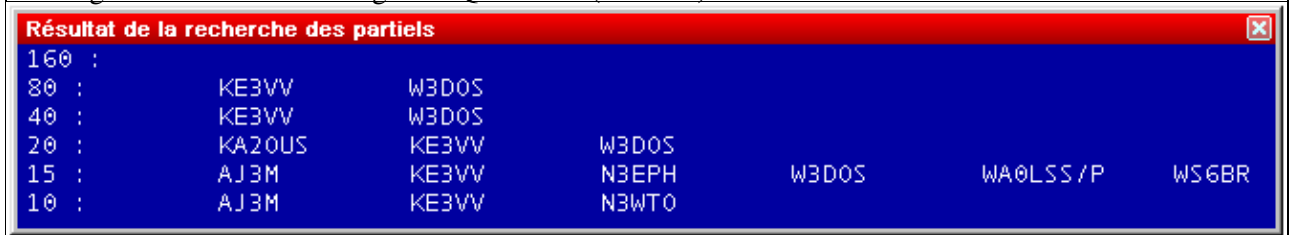

Looking for an US state during the ARRL DX Contest (here: District of Columbia, DC)

Any further typing in the callsign field restores the [Check Partial Window](#) to its normal appearance. You can also use **[Ctrl-W]**, **[Alt-W]**, or **[F11]** to erase the multiplier from the callsign field.

**Note:** This search only works for contests where the multiplier is logged as part of the exchange, so it doesn't work for the CQ WPX contest or the ARRL DX Contest (when operating from the U.S. and Canada).

For VHF/UHF/SHF... contests, this function is dedicated to partial QTH locator search. Enter the partial QTH locator either in the callsign or in the locator field and then press **Shift-F10**.

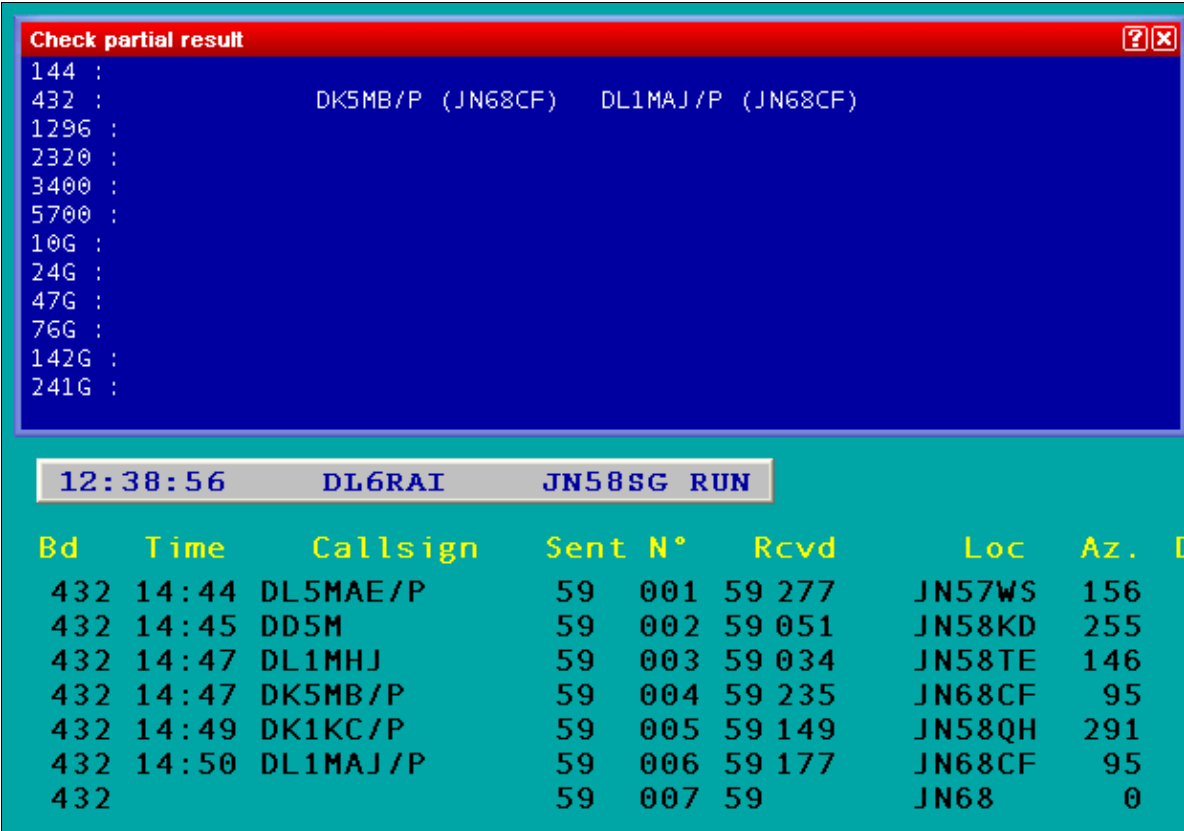

144 :  
 432 : DK5MB/P (JN68CF) DL1MAJ/P (JN68CF)  
 1296 :  
 2320 :  
 3400 :  
 5700 :  
 10G :  
 24G :  
 47G :  
 76G :  
 142G :  
 241G :

12:38:56 DL6RAI JN58SG RUN

Bd	Time	Callsign	Sent	N°	Rcvd	Loc	Az.	Dist	Mult
432	14:44	DL5MAE/P	59	001	59 277	JN57WS	156	61	LOC
432	14:45	DD5M	59	002	59 051	JN58KD	255	52	LOC
432	14:47	DL1MHJ	59	003	59 034	JN58TE	146	12	
432	14:47	DK5MB/P	59	004	59 235	JN68CF	95	50	LOC
432	14:49	DK1KC/P	59	005	59 149	JN58QH	291	14	
432	14:50	DL1MAJ/P	59	006	59 177	JN68CF	95	50	
432			59	007	59	JN68	0	0	

Searching callsigns by QTH locator

## Check Partial

Windows | Check Partial or [F12]

Opens (or closes) the Check Partial window. The master file used is normally MASTER.SCP or DEFAULT.SCP or *contest.DTB*, as described under [Check Partial and Np1 Files](#).



Résultat de la recherche des partiels

KA2QIT WA2QAV WA2QHL WA2QNW  
 WA2QQF

Checking partials. Partial callsign entered: A2Q

If this window is open, and at least 3 characters are entered in the callsign logging field, Win-Test looks in the master database for the callsigns including the 3-character string.

For example, in this upper screen-shot, the partial callsign entered is "A2Q". All the callsigns found by Win-Test show this string.

The white callsigns are those not worked yet. The green callsigns are stations worked on another band, but not the current band. The red callsigns are the dupes (callsigns already worked on the current band).

You may also use the wildcard character "?" like "DL6?A?" to filter out unwanted calls.

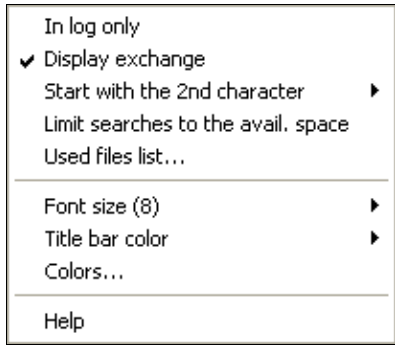

Available context menu options in the Check Partial window  
 Double clicking on a callsign copies it into the callsign logging field.

Right click in the window to brings up a context menu where you can choose if Win-Test is to use the master database or just your log. Another option is (in some contests) if you want to see the expected report in that window (from *contest.DTB*).

For slow contests, it might make sense to start the check partial search after the second letter is entered into the callsign field, rather than the third.

Another option allows you limit the number of callsigns displayed to fit the available space in the window.

Finally, the option **Used files list** will display the master file that Win-Test has loaded to feed the Check Partial window:

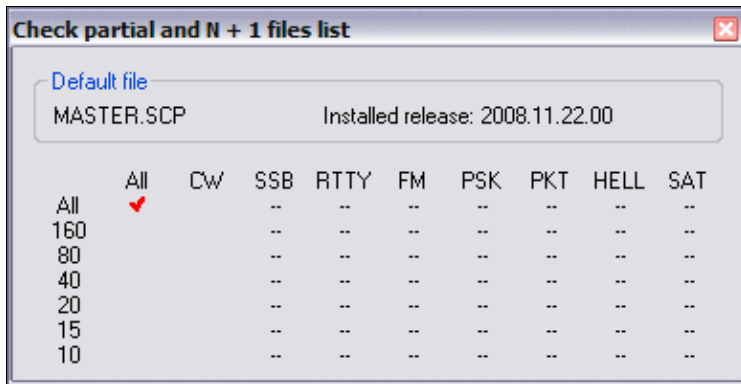

Used files list selected from Check Partial window pop-up menu

See [Check Partial and Np1 Files](#) for more info about naming super check files, search order, and how to update them.

In HF contests such as CQ World-Wide, you can enter a zone number in the **callsign** field and press **Shift+F10** to display a list of prefixes in that zone, and a list of stations worked in that zone.



Check partial window after entering 37 in the callsign field and pressing Shift+F10 to view countries in that zone. 5H3EE is in zone 37 and has been worked on 20m.

In VHF/UHF contests, pressing **Shift+F10** on a partial QTH locator changes the Check Partials Window to the Partial QTH Locator Search Window. This feature is helpful to identify stations in a VHF/UHF contest when you copy only the QTH locator.

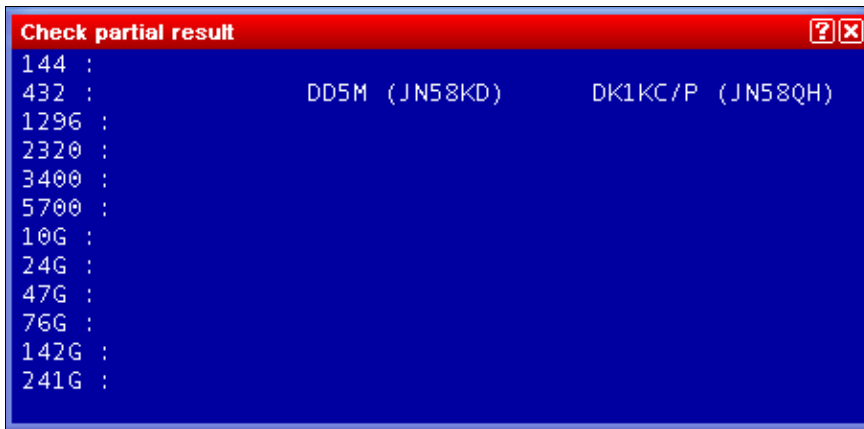

### Check Partial QTH Locator window

You may enter the partial QTH locator either in the callsign or in the QTH locator fields. A minimum of four characters has to be present in order to check the locator.

## Check N + 1

Windows | Check N + 1 or **[F8]**

Opens (or closes) the N + 1 window. The master file used is normally MASTER.SCP or DEFAULT.SCP or *contest.DTB*, as described under [Check Partial and Np1 Files](#).

If this window is open, and at least 3 characters are entered in the callsign logging field, Win-Test looks in the master database for the callsigns differing from the partial callsign by one character.

This command also detects 2-character swap (dyslexia), as well as one missing character.

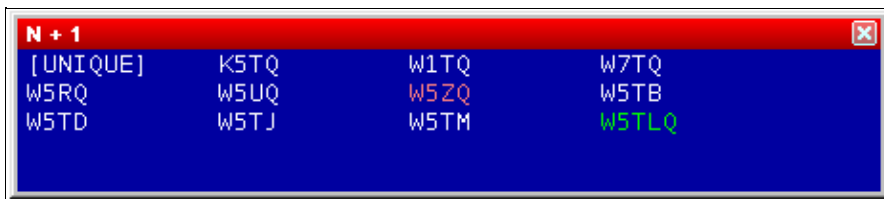

N + 1 window (Partial call entered: W5TQ)

If the callsign is not included in the master database, and has not been worked yet, it is considered a UNIQUE. Otherwise, it is displayed in the first position.



N + 1 window (Partial call entered: K3OK)

The white callsigns are the stations not yet worked. The green ones are those worked on another band, but not the current band. The red callsigns are dupes.

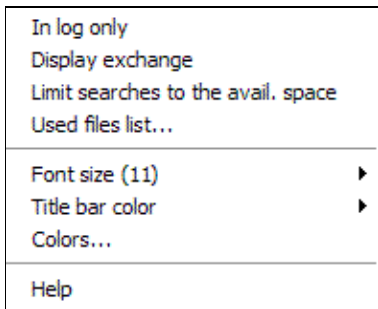

Available context menu options in the N+1 window

Double clicking on a callsign copies it into the callsign logging field.

A right click in the window brings up a context menu where you can choose to use the master database or just your log. A second option (in some contests) is if you want to see the expected report in that window (from *contest.DTB*). You may also wish to limit the number of callsigns displayed to the available space in the N+1 window. Finally, the option "Used files list" will display the master file that Win-Test has loaded to feed the Check Partials window.

## Partner

Windows | Partner

Opens (or closes) the partner window.



Partner window with two entries. You can now pull W6XR into the callsign field by pressing **Alt-1**

This feature is especially useful in a Multi-OP environment when facing large pile-ups and/or weak signals or when you are training a new operator.

Situation: You get several callers coming back to your CQ. You pull out one callsign - but sometimes you are able to copy another callsign or at least parts of it. If you could remember this second call after the first QSO, you'd be able to call the second station right away (without QRZ) and save time.

Improvement: Set up a second operator (OP2), a second computer and a second pair of headphones, sometimes a second receiver. Both OPs now open up the Partner window on their computer. The running operator OP1 continues like before: He works the first callsign. In the mean time, the OP2 supports OP1 to copy the callsign - or alternatively - he can add callsigns he copied from the pile-up by entering the callsign on the QSO entry field and then pressing **Alt-Enter**.

This callsign will now be displayed on all computers in the network that are set at the same band and mode. OP1 will see the new callsign after his first QSO and calls that station right away.

The Partner window can hold up to 9 callsigns, and these calls can be pulled into the callsign field with **Alt-1, Alt-2...Alt-9**. Usually this is done by OP1 to log that callsign, while OP2 uses this function to remove the call from the partner window. Once the QSO is logged, that callsign will disappear from both partner windows.

You can also swap the callsign field with one of the entries by pressing **Ctrl-1, Ctrl-2...Ctrl-9**.

Using message variables on CW and RTTY you can now enter a QSO (with correction or not), grab another callsign from the Partner window, and send the new report in one keystroke, by using:

```
$CORRECT TU $CR NOW $GRABPARTNER $NEXT $F2 (sends call if corrected before the TU)
```

for the **[Plus]** key, or

```
$CURRENT TU $CR NOW $GRABPARTNER $NEXT $F2 (resends full call before the TU)
```

assuming **\$F2** contains the report.

If you want to manually grab a callsign from the Partner window you can use:

```
$PREV TU NOW $LOGGED $F2
```

Then

1. Use the **[Enter]** key to silently enter the current QSO
2. Grab the next callsign from the Partner window (via double-click or Alt-n)
3. Send the message above

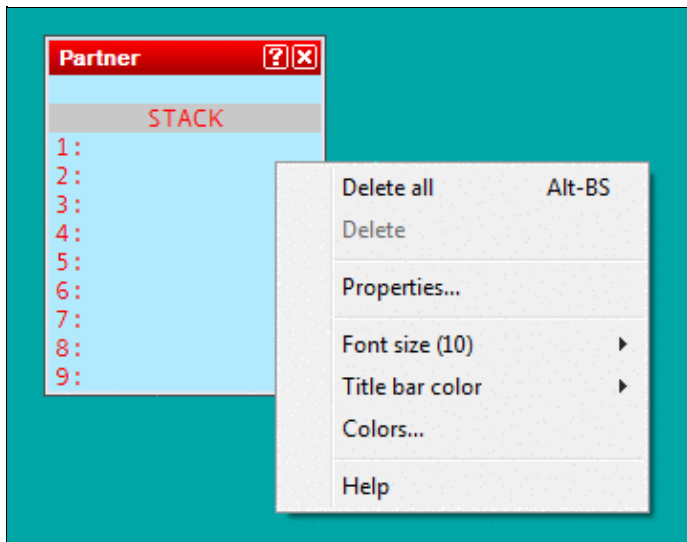

### Partner Window Context Menu

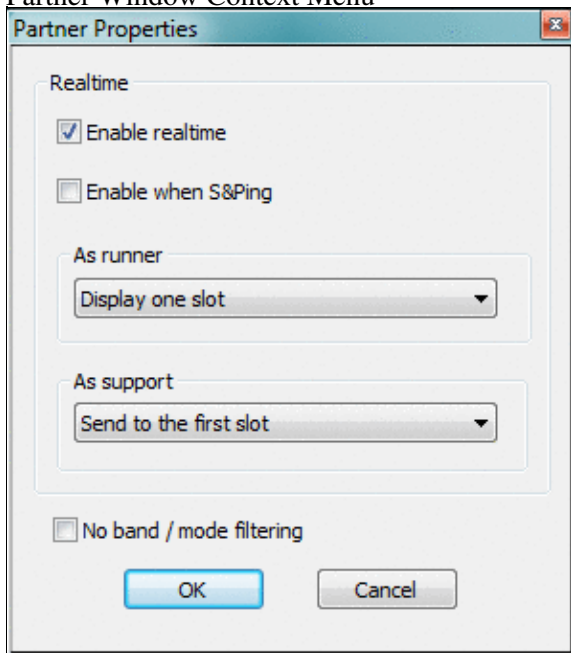



### Partner Window Properties

When a QSO is logged locally or via the network it is checked against the contents of the partner window, and - if found - removed from the partner window as it is now obsolete.

If automatic exchange guessing is enabled, a callsign grabbed from the partner window will have the exchange window filled in and will update the check partials and N+1 windows.

Finally, the entire Partner window content can be cleared by using the appropriate context menu item or by pressing **Alt-Backspace**. Individual entries can be removed via **Ctrl-Doubleclick**.

Up to three support partners can be engaged. If you do not want the partner to be limited by band and mode, use the "No band/mode filtering" option in the context menu of the partner window.

A **real-time** mode is available in the partner window's context menu. This allows the main operator to have a real-time view on what the partner(s) is(are) typing (character by character) so he(he) does not have to wait until they press **Alt-Enter** in this time-critical situation. For this to work, the supporting partner has to change his station type to "Support" (see section [Menu:Commands#Station\\_Type](#)), indicated by **R+** on the QSO entry line.

In the context menu of the partner window there are two settings that can be done, when more than one partner (up to 3) is engaged:

- as support, must be selected to which slot this partner will send its real-time characters
- as runner, must be selected how many slot are being displayed at the partner window top

The runner will then grab a real-time slot with **Alt-Space**, or in all cases, he can also double-click on any callsign of this window.

## Status

Windows | Status or **Alt-J**  
Opens (or closes) the status window.

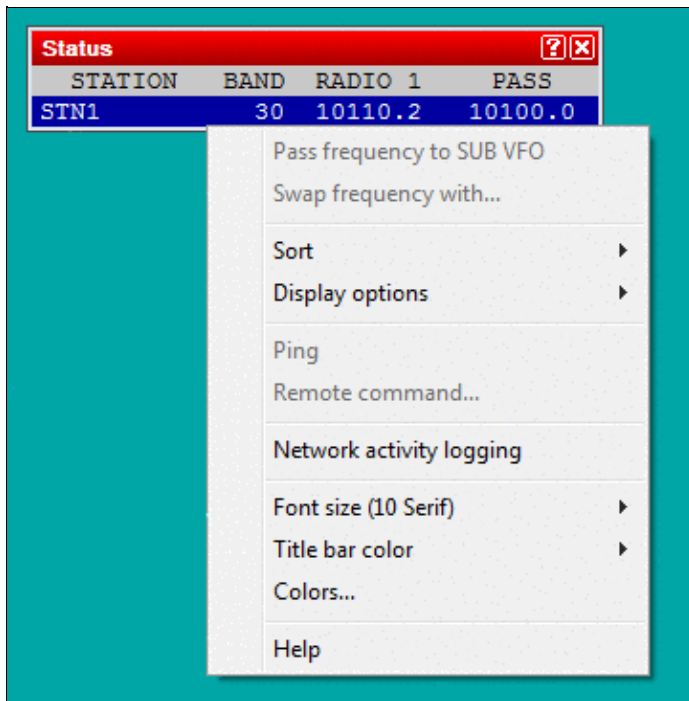

### Status Window

This window indicates the status of each station connected to the network. From left to right, are displayed :

- Station name
- Current band and mode
- Station type
- QSY frequency of the current band and mode
- Radio 1 frequency
- Radio 2 frequency
- Operator
- Time left before a possible QSY, according to the 10 minutes M/S rule, or "OK" if the station is allowed to make a QSY on another band. Note that this column only appears if the contest specifies this particular rule.

Your own station is displayed in a deep blue background. The active radio of each station has its frequency in red characters. The list may be by band and station names when it gets cluttered in a very large network by using the appropriate function in the context menu.

A double left click on a station name will display the chat dialog with this station name as default destination.

Opening the context menu with a right mouseclick will allow you to turn on network traffic logging. This might be useful for basic network troubleshooting. This log file uses the .ntk (stands for NeTworK) file extension.

Ping a specific station from the context menu on this station name and use "Ping XXX". The Win-Test version, the Master, Bridgehead, Sync indicators and the propagation time are returned in the Gab window (Alt-I). Reminder: You may also use the INV (stands for Inventory) text command to get a summary of the complete network.

A remote command to a specific station can be sent by opening the context menu on this station name and use "Send remote command to XXX...".

At last, a double left click on any frequency displayed will tune the current radio to that frequency.

## Skeds

Windows | Skeds or **Alt-B**  
 Opens (or closes) the skeds window.

Time	Frequency	Mode	Call Sign	Signal
12:59	21129.0	SSB	ZS6UN	[38]
13:14	14138.0	SSB	Z31CZ	[15]
13:18	14138.0	SSB	T94B	[15]
13:23	14138.0	SSB	MMOBRG	[14]
13:38	14138.0	SSB	EW1GA	[16]
19:14	21205.0	SSB	KHOAA	[27]
19:16	14138.0	SSB	KHOAA	[27]
19:21	14155.0	SSB	KHOAA	[26]
19:23	14247.0	SSB	AH2R	[27]
19:38	14138.0	SSB	VE8JL	[01]
21:25	14138.0	SSB	YS1JBL	[07]
21:35	14138.0	SSB	YS1JBL	[04]
23:41	7015.0	SSB	HSOZAA	[26]
23:43	7015.0	SSB	VP2MEG	[08]
23:49	7015.0	SSB	J69EN	08
23:55	21130.0	SSB	VP2MEG	[08]
00:43	7015.0	SSB	KL7HBK	[01]
01:34	7015.0	SSB	6Y4Y	[08]
01:37	7015.0	SSB	HK1JMF	[09]
02:39	3795.0	SSB	LW7DX	[13]
04:22	3751.0	SSB	5JOX	[07]
04:24	3730.0	SSB	LZ9W	[20]
06:03	1825.0	SSB	VE3BW/HR9	[07]
06:13	3775.0	SSB	TU2CI	[14]
06:17	1825.0	SSB	GMOB	[14]
06:26	3775.0	SSB	TG9AVV	[07]
06:27	3775.0	SSB	TG9AVV	[07]
06:34	1826.0	SSB	GI3NVW	[14]
06:42	1826.0	SSB	TI8M	[07]
06:45	3775.0	SSB	KH7X	[31] dans 8 min il nous entend !!!
06:59	3675.0	SSB	EA9PY	[33]

### Skeds Window

Skeds (Alt-E) and passed stations (Alt-D) are displayed in this window. See [Multi-op/Passing](#).

- A grey background means that the sked is over for more than 10 minutes.
- A yellow background means that the sked is planned within less than 10 minutes maximum (a "hot sked"). If the window was not open, it will pop-up to remind the operator of the hot sked. The pop-up will be suppressed, however, if Win-Test is running minimized.
- A green background means that the sked is planned in more than 10 minutes.

A - (minus) sign before the hour means that the sked is over for more than 24 hours. A + (plus) sign before the hour means that the sked is planned in more than 24 hours.

A right click allows to sort the skeds window by time or by band. You can also hide the older skeds, and modify or cancel a sked. In a multi operating configuration, the sked data are sent across the network.

At last, note that a double left click will tune the current radio on the sked frequency and capture the callsign of the scheduled station in the callsign logging field. You will thus just need to press [**Return**] after completing the QSO!

## Solar Activity

Windows | Solar Activity

This option displays solar activity data that has been received from the DX cluster connection. You can chose between SSN, SFI, K and A indexes. It is an interesting tool to discover trends in propagation during a contest.

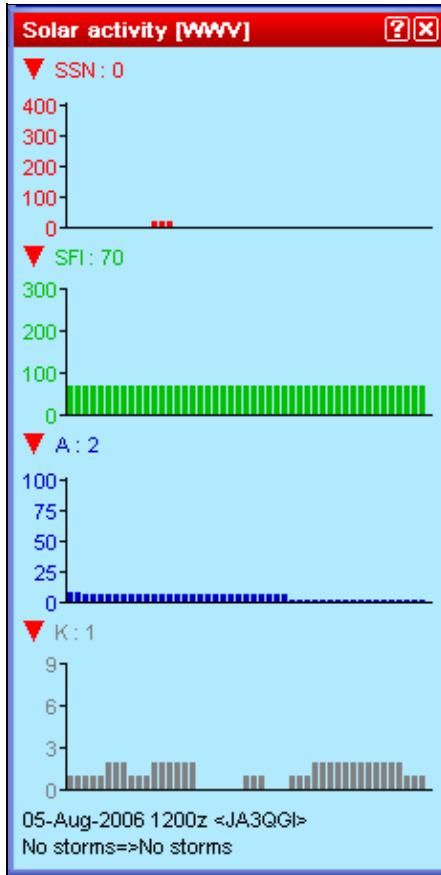

Solar Activity Window (WWV data)

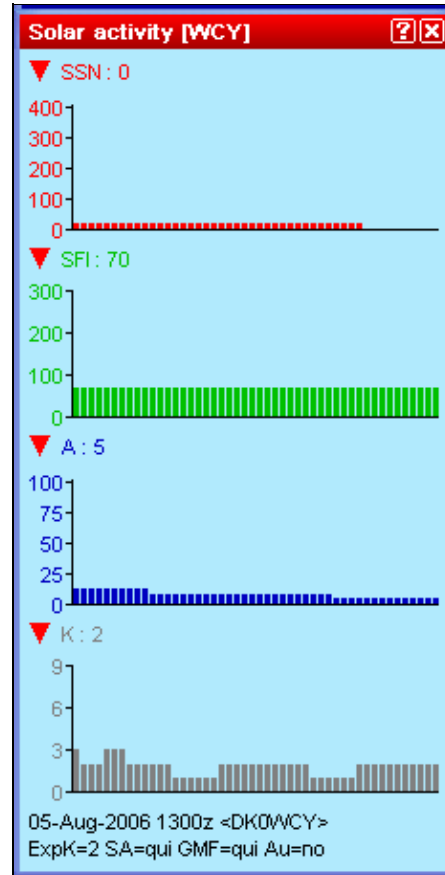

Solar Activity Window (from DK0WCY)

As there are two sources on the DX cluster for this kind of information, you may chose between WWV and WCY. This information can also be applied - in conjunction with HamCap - for specific propagation forecasts. See [Menu Options HamCAP](#) in this manual.

Click on the triangles to open or close a chart. You may open or close all charts at once by holding the **[Shift]** key down while clicking on one of the triangles.

## QSY Wizard

Windows | QSY Wizard

The QSY Wizard can only be used if [HamCAP](#) is installed and running. You must also have [Options | HamCAP | Tab](#) set to **Charts**.

After working a DX, pressing **Ctrl-P** will bring up the HamCAP window with a propagation prediction to this DX. Then, the QSY Wizard will display the bands on which to which a QSY or sked may be useful:

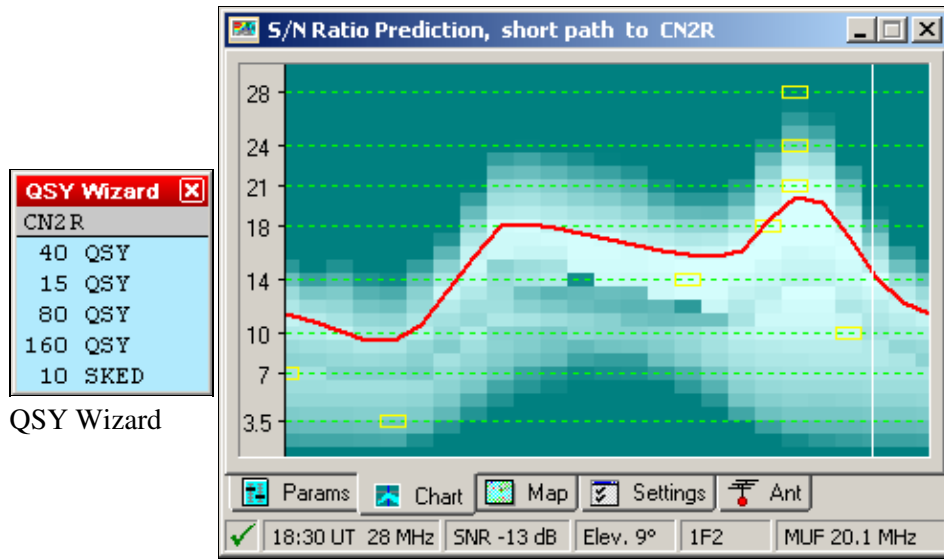

HamCAP prediction to CN2R

In the above example CN2R has been worked on 20m. After pressing **Ctrl-P** the wizard tells us that a QSY may be promising to 15, 40, 80 and 160m. For 10m, however, the wizard recommends a sked at 18:30 UT instead. This is the peak time predicted by HamCap for this path but MUF will be only be 20.1 MHz (the mouse cursor was over the 18:30/28MHz yellow square while creating this screenshot).

## Extra Information

This window displays data included in .XDT (eXtra DaTa) files. These files are textual and have a very basic syntax. These files are suitable for name lists (your favorite contest friends or club members, whose names you never get to remember in the middle of the contest) or information about a station's capabilities on other VHF/UHF/SHF bands so that you will want to ask for a sked.

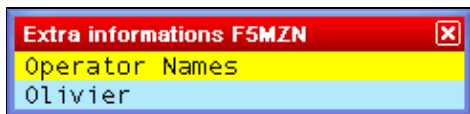

The Extra Data Files Window can be used to display additional useful information during the contest.

## XDT Files

The first column is the callsign of the station for which information is to be displayed. The rest of the line carries the information to display. There can be only one line per callsign. Lines have to be formatted in MS-DOS mode, i.e. CR/LF at the end.

You can set up to 10 default extra data files by the menu function **Options | Data files | Default data files**. These files will be opened with every log. They must be located in the WT installation directory. Refer to [Menu: Options Default extra data files...](#) for detailed information.

You can also add **log-specific** extra data files by using the **Extra files...** item in the context menu of this window (right-click to open the contextual menu). A new window will open-up where you can click the ADD button to browse the computer resources to locate and select the file you need (see picture).

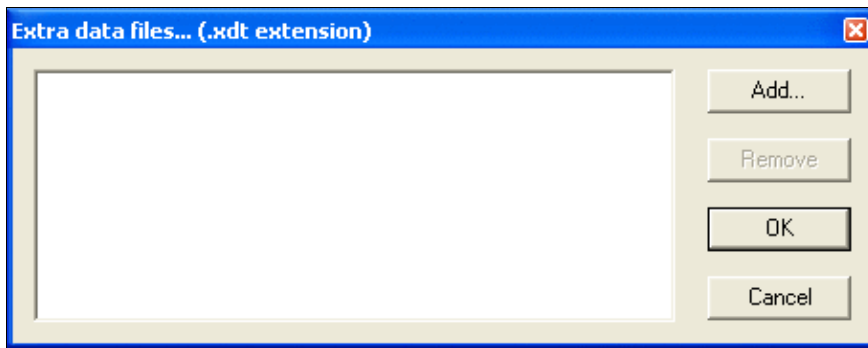

Click the ADD button to locate and select the file you need

There is no limitation to the location and the number of these log-specific files. The added file names and paths will then be save in a file with **.xdt** extension among all the other contest specific files (.LOG, .SUM, .pkt, .gab, .wtb, etc.).

If you modify an **.XDT** file while it is in use, you must reload it by using the **Reload files** item in the context menu.

**Note:** This function is designed to work with no more than a few thousand callsigns only. Don't try it with millions of lines or a Callbook file!

## Directives

Directives are special statements in the data file beginning with a hash sign and a space.

The **# TITLE** directive is used to display a title in the window, like this:

```
# TITLE Operator Names
CT1BOH Jose
DJ1YFK Fab
DL4NER Werner
DL6RAI Ben
F5HRY Herve
F5MZN Olivier
F6FVY Larry
M0CLW Simon
M3PHP Peter
```

The **# VARIABLE** directive allows you to send the extra information in a CW message by using a variable name. The variable name **must** begin with the \$ character.

Example: The following line will substitute the \$OPNAME string in the CW messages with the extra info included in this file, if the sent callsign has matching data.

```
# VARIABLE $OPNAME
```

**Note:** The variable substitution only works with the internal CW keyer.

## Summary

Windows | Summary or **Alt-S**

Opens (or closes) the scoring summary window.

Récapitulatif						
BANDE	QSO	DBL	DXC	CQ	POINTS	MOY
160	102	3	50	13	280	2.75
80	328	5	81	21	942	2.87
40	916	31	119	29	2652	2.90
20	1208	17	140	35	3532	2.92
15	2297	69	145	34	6701	2.92
10	4334	137	145	33	12762	2.94
TOTAL	9185	262	680	165	26869	2.93
<b>SCORE FINAL : 22 704 305</b>						

### Summary

The displayed number of QSO does not include the dupes. Thus, the QSO column displays only the QSO that have generated points.

A right click allows to copy the scoring summary data in the clipboard as an image or as a text file (in WT language or in English, depending on the contest).

## Live Score

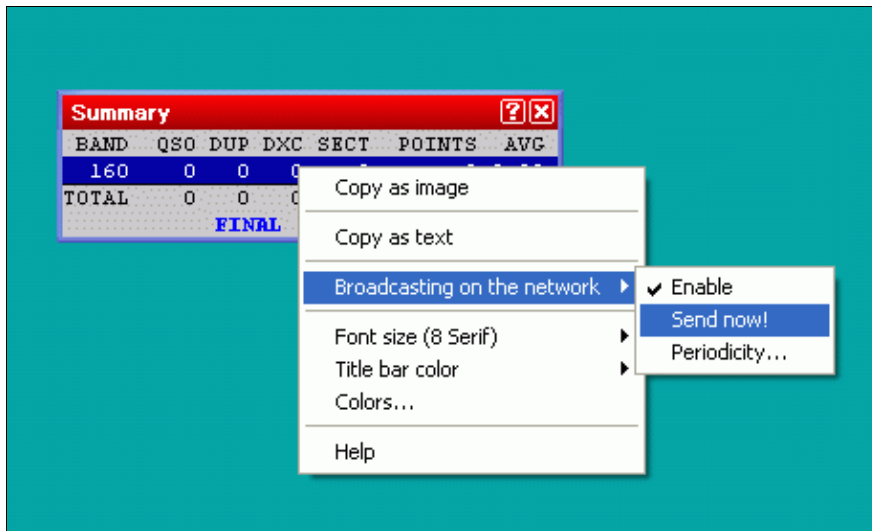



Enabling Live Score Broadcasting through the context menu

The context menu also allows you to configure and enable live score reporting by using a specific UDP broadcast protocol [1]. Please note that additional third-party software is needed to post your score to one of the live scoreboards on the internet.

For testing purposes, there is an option to create a live score broadcast "now"; typically, it will be broadcasted automatically once every five minutes or however you set up the periodicity. Live score broadcasting in a multi operator environment is limited to the station that is the network time master.

For further information about live scores, please see [2] and [3] (German language).

## Rate

Windows | Rate or **Alt-R**

Opens (or closes) the rate window.

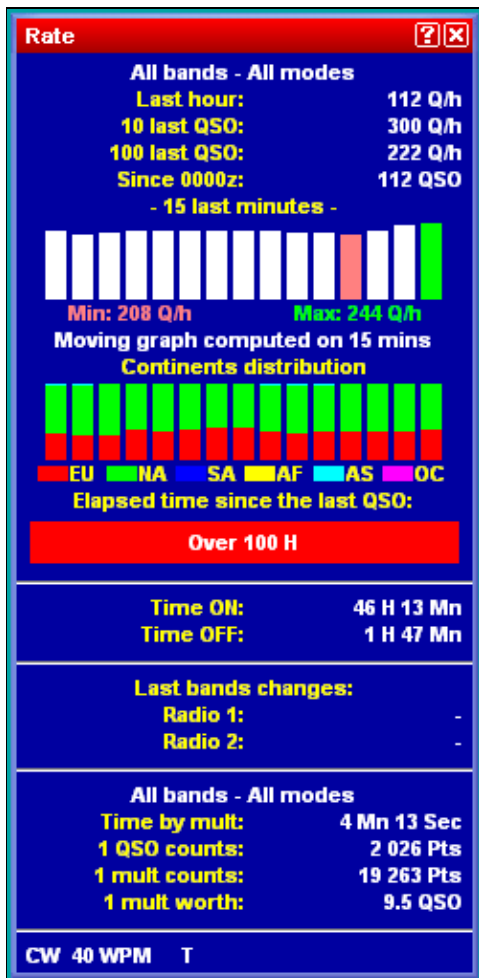

## Rate Window

This window is divided in different parts:

The upper part displays the rate of the last hour, of the last 10 QSO, and of the last 100 QSO. It also displays a moving graph of the rate, computed on the last 15 minutes before the current QSO. The lower portion of that window displays additional rate information in text format.

## Graphs

The graph is calculated on the last 15 minutes (default). Each bar, thus representing one minute on the air, calculates the moving average rate on the last X minutes, this time being selectable between 5 to 30 minutes. A short period will be selected for a contest with high rates (international HF, such as CQWW or WPX), and a longer one for a contest with slower rates (such as a national HF, or a VHF).

Below is a display that shows instant continent distribution of previous QSOs. It uses the same timing parameters as the instant rates above.

The QSO Timer Alarm progress bar appears below that. This bar gives a clear visual indication of the time elapsed since your last QSO. Right click and select **Off-time timer alarm** to set the full scale range of the progress bar. In the screen shot above, it is the red bar showing over 100H elapsed since the last QSO, but normally it is a green progress bar that advances from left to right. It begins as 100% green and slowly more of it turns red until it reaches full scale, when the bar becomes 100% red. The default scale is 5 minutes, but it is configurable between 1 and 120 minutes.

## Text Information

The next part displays information about Time ON and Time OFF. For new logs, the off-time calculation is based on the contest rules. You can still use a custom setting to check your operating efficiency. Right click and select **Off-time calculation threshold**. If the contest rule is unknown, 30 minutes will be used as a default threshold.

The next part shows information about band changes.

The central part gives general information about the point statistics of the contest, e.g. time by mult, QSO counts, Mult worth, etc.

The bottom part indicates the current mode and, in CW, the current speed, as well as the status of the automated CQ repeat mode. Some indicators that may appear there include:

- **CW** - Operating mode is set to CW (press **Ctrl-F1** or **Ctrl-F2** to change)
- **SSB** - Operating mode is set to Phone
- **RTTY** - Operating mode is set to RTTY
- **34 WPM** - CW speed in Words Per Minute (adjust with **Alt-F9**, **Alt-F10**, and **Alt-V**)
- **34/32 WPM** - Independent CW speed between Win-Test and WinKey pot (WinKey speed displayed on right)
- **S** - Operator is listening in Stereo mode (operator pressed **AltGr-S** or **Ctrl-Alt-S**, press **AltGr-A** or **Ctrl-Alt-A** to remove)
- **T** - Operator is listening to the Secondary Radio (operator pressed **AltGr-T** or **Ctrl-Alt-T**, press **AltGr-A** or **Ctrl-Alt-A** to remove)

- **REPEAT** - Automatic repeating CQ feature is active and [**F1**] has been pressed. See [Automatic CQ Repeat](#).

## Context Menu

A right click allows you to choose on what bands and modes these calculations have to be done:

- All : No filtering is done
- Current : Filters only QSO done in the mode and band of the current radio
- According to QSO : Filters only QSO done in the mode and band of the current QSO

You can also choose to display the calculations as :

- QSO / h : Only based on the number of QSO
- Points / QSO : Averages the points of the QSO
- Points QSO / h : Without the multipliers
- Points / h : Including the multipliers

Thresholds are defined and can be modified on the following properties:

- Instant moving graph window -how many minutes of history are taken into account
- Off Time Alarm - after how many minutes the color of the green bar will turn red
- Off-time calculation - after how much time of no QSO, time is counted towards off-time (may be contest specific)
- Last band change method - which event triggers the timer after a band change

Moreover, the contents of the rate window can be customized by selecting one or more of the following, which are listed under the **Display** menu item of the context menu:

- Instant rate moving graph
- Instant continents distribution
- Off-time timer
- Time ON / Time OFF
- Band Changes
- Band Changes elapsed times
- QSO/Mult ratio
- Distances Data

Finally, right click and select the **Copy** menu item to copy this window, as an image, to the Windows clipboard.

**Note:** The available menu items in the context menu may vary depending on where you right click in the window.

## Statistics

Windows | Statistics or [**Ctrl-F9**]  
Opens (or closes) the Statistics window, a rate sheet.

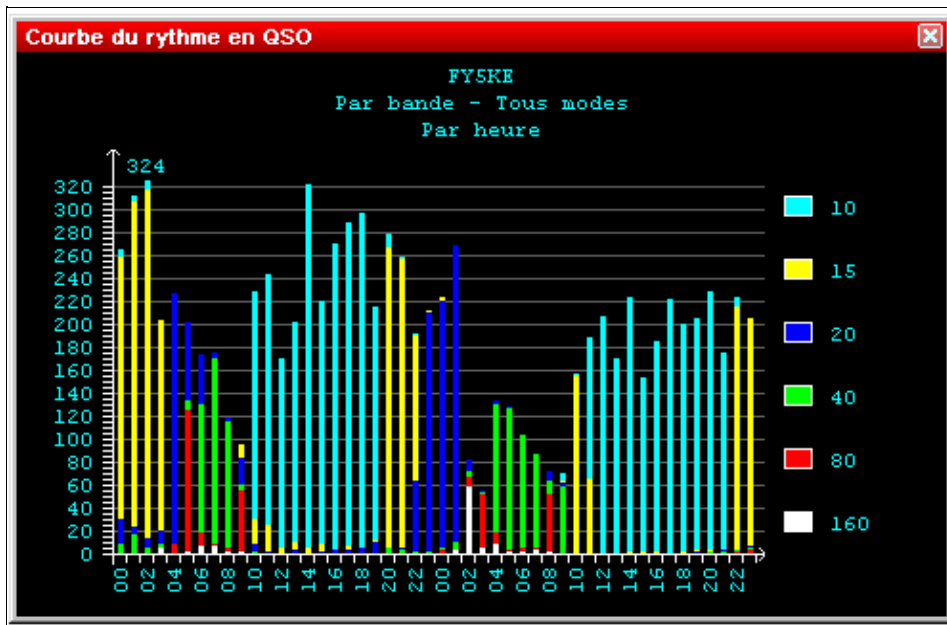

Statistics Window showing total QSOs made on all bands and modes, per hour  
 The size of this window can be changed by dragging the edges. The window displays the number of QSOs, hour by hour, for the entire contest period.

The time span is fixed depending on the contest type. For the shorter contests, the display spans 24 hours; for the major contests, it spans the full 48 hours. For DXpeditions, it is configurable from 1 to 15 days via the [Days...] button in the Contest Configuration window.

Switching to the **Targets** tab in the statistics window, you may compare your current score to a pre-loaded estimate, which may be derived from a previous contest operation or generated by hand. Positive offsets with respect to the target file are shown in green color, negative offsets in red color.

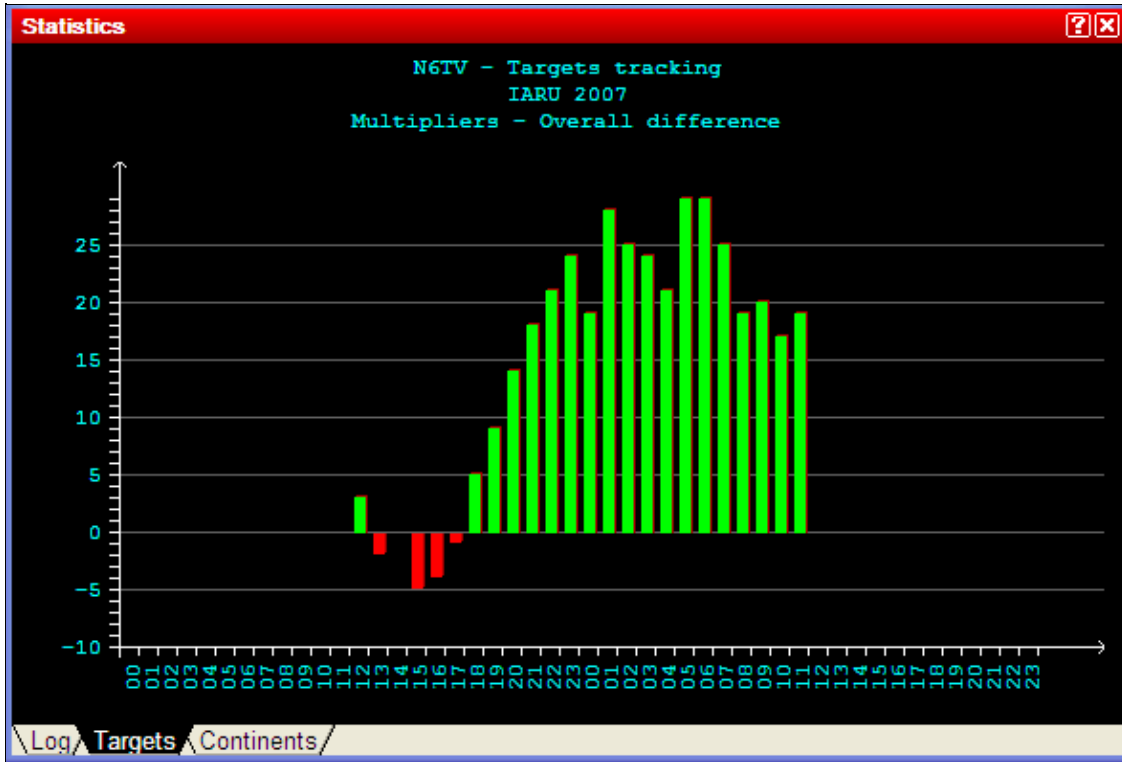

Cumulative (overall) Multiplier tracking vs. target  
 You may also display hour-by-hour comparisons with the targets.

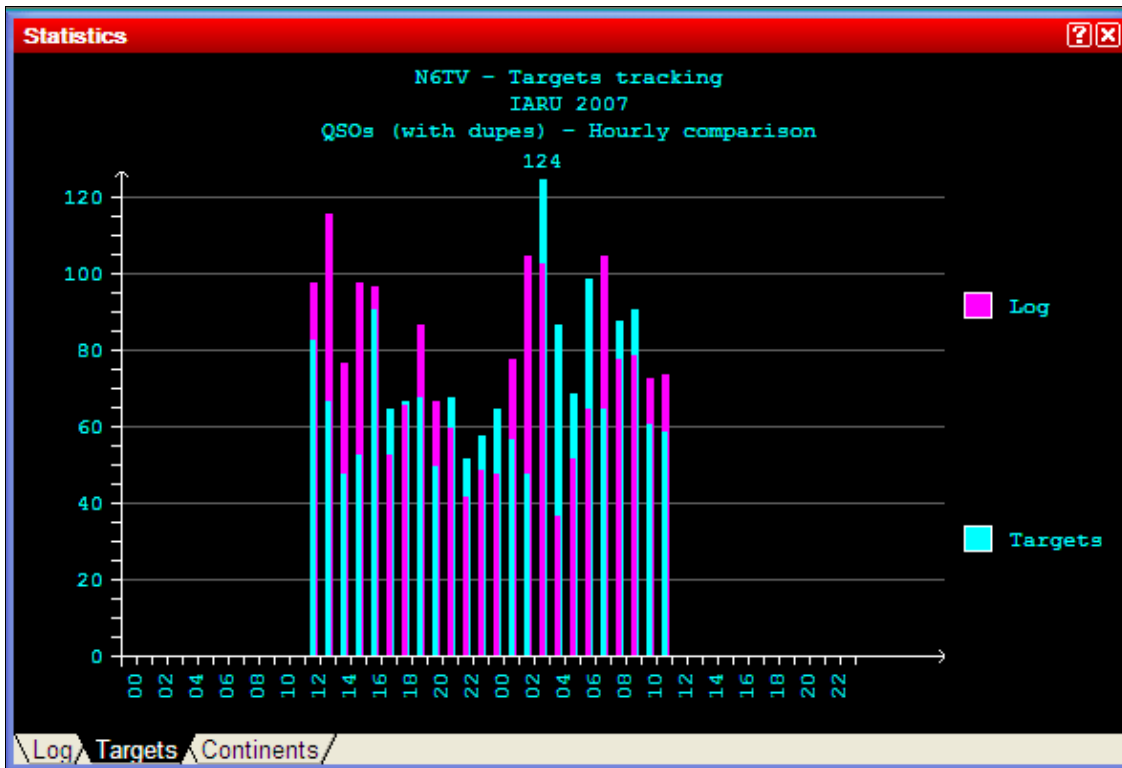

Hour by hour QSO tracking vs. target

Please see [Menu | Tools | Load a targets file...](#) for further information on exporting and loading target files.

Switching to the **Continents** tab displays continental QSO statistics.

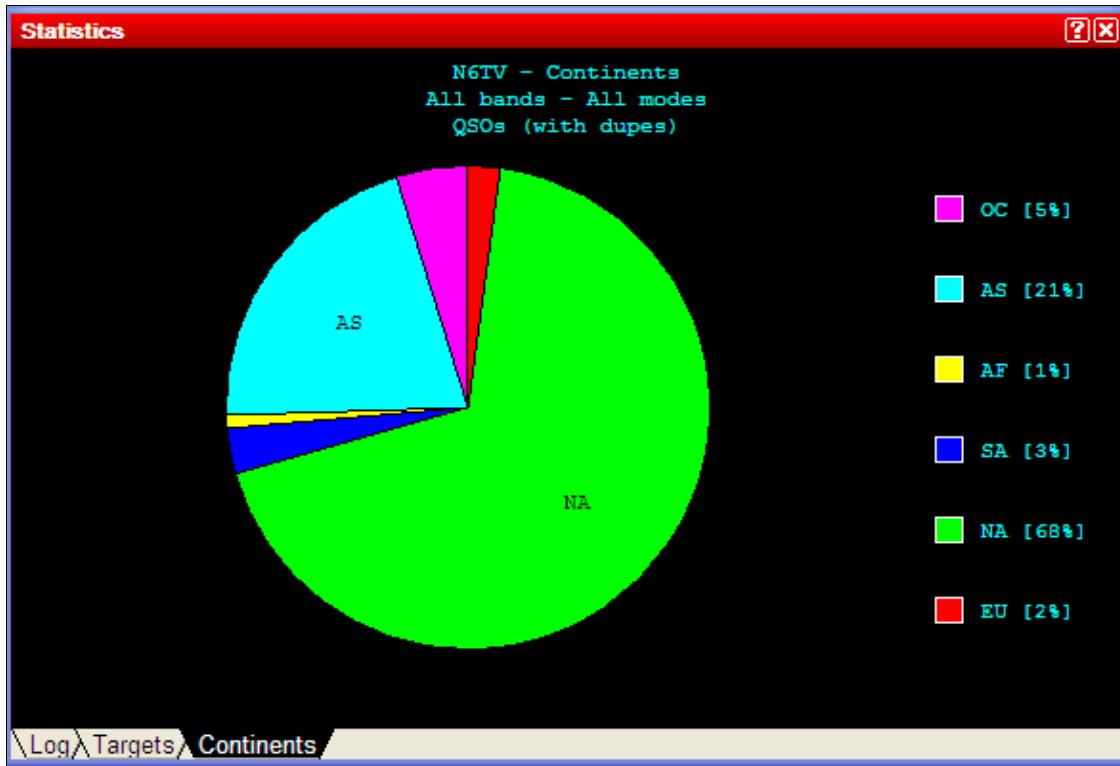

Continental QSO statistics

A right click allows to set different display options:

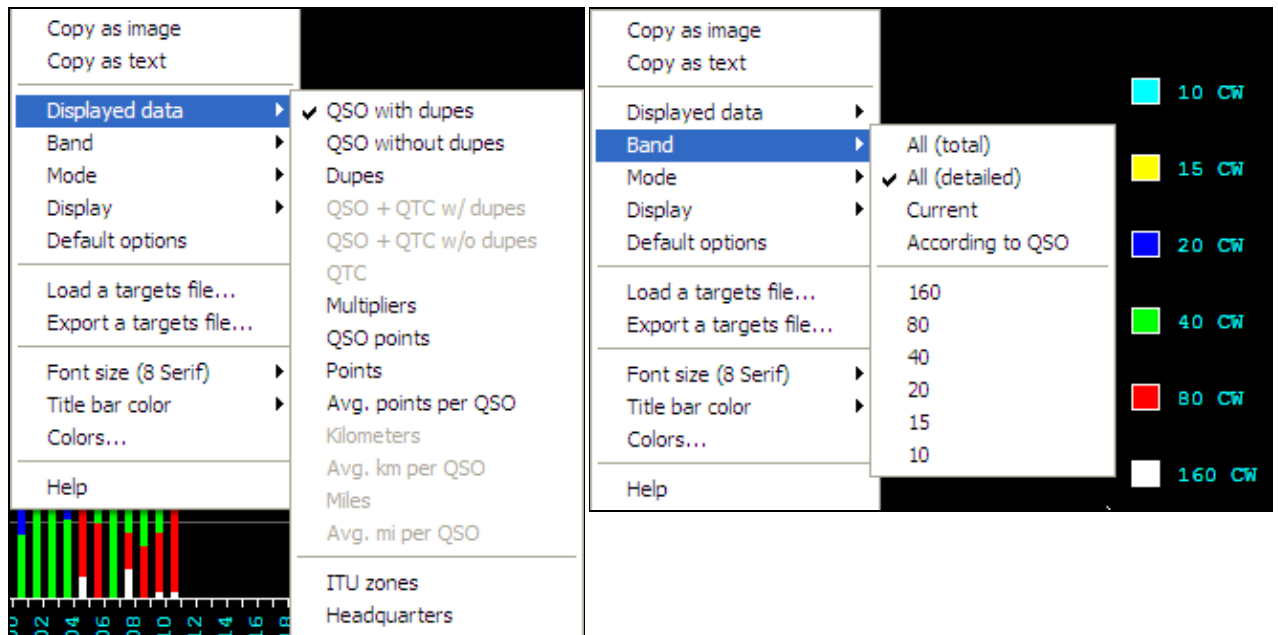

Pop-up menu showing displayed data options      Pop-up menu showing band options  
Displayed Data

- Select which kind of data to display: QSOs, Multipliers, QSO Points, etc.

#### Band

- All (total): Single color display, all bands combined
- All (detailed): Multicolor display, one color per band
- Current: Displays statistics for the current band
- According to QSO: Displays statistics for the band of the currently selected QSO

#### Mode

- All (total): Single color display, all modes combined
- All (detailed): Multicolor display, one color per mode
- Current: Displays statistics for the current mode
- According to QSO: Displays statistics for the mode of the currently selected QSO

#### Display

- By time: Displays an hour by hour comparison
- Overall: Displays a cumulative (overall total) comparison

Another option allows you to load a targets file for comparison, or export a targets file based on the current log.

Finally, it is possible to copy any of the Statistics windows as image or text to the Windows clipboard. Then you can copy the data into to a text document or even into an Excel® or OpenOffice spreadsheet.

## Gab

Windows | Gab or **Alt-I**

Opens (or closes) the gab window.

```

Tchatche
[20:45:55] MULT2: Fiar : arrête de regarder le rate !
[21:16:54] MULT2: le v63b sur 10m c'est potable ?
[22:19:06] MULT1: le 80m est grandiose.... du bruit rien que du bruit...
[22:49:13] RUN1: un ricain envoie qq'un sur 7205 simplex...
[22:49:48] MULT1: c'est le coca qui fait ça....
[22:52:08] MULT1: c est KC1XX qui cherche un CE6 dans du broadcast infernal
[23:02:49] MULT1: dernière ligne droite Did
[23:02:57] MULT2: pz5a a un bon pile sur 20m, est-ce meilleur que sur 15m ?
[23:03:01] SUPPORT: go, Did, go !
[23:17:18] MULT2: nous sommes spottes par les JA sur 15m !
[23:17:57] SUPPORT: oué, mais les JA sont 31 avec leur accent de dozo
[23:18:32] MULT2: dozo gozo mahista Oli san
[23:22:36] MULT2: la moyenne sur 80m baisse ... on est a 3.01
[23:34:16] SUPPORT: excuse
[23:37:52] MULT1: not heard
[23:56:11] SUPPORT: r0m
[23:59:25] SUPPORT: go, gégé, go
[23:59:37] RUN1: ENQUILLLLLLLLLLLE GG
[23:59:50] SUPPORT: trop de la balle
[23:59:52] MULT1: RV... goto 3830
[23:59:56] RUN1: 23MPts !!!

```

### Gab Window

All the gab chat is displayed in this window. With a right click, you can choose to display (or not) the time when the message was sent, including (or not) the seconds. Moreover, this window can be copied as an image.

In the context menu, the option "Taskbar flashing" can be selected to make the Windows Task Bar flash every time a gab is received.

All the gab chat is recorded in the .gab file of the current contest.

A double-click in a station name in this window will open the chat dialog, with this station name as default destination.

If the gab window becomes too cluttered, you may wish to clear it via the context menu.

## World Map

Windows | World Map

Opens (or closes) the map window



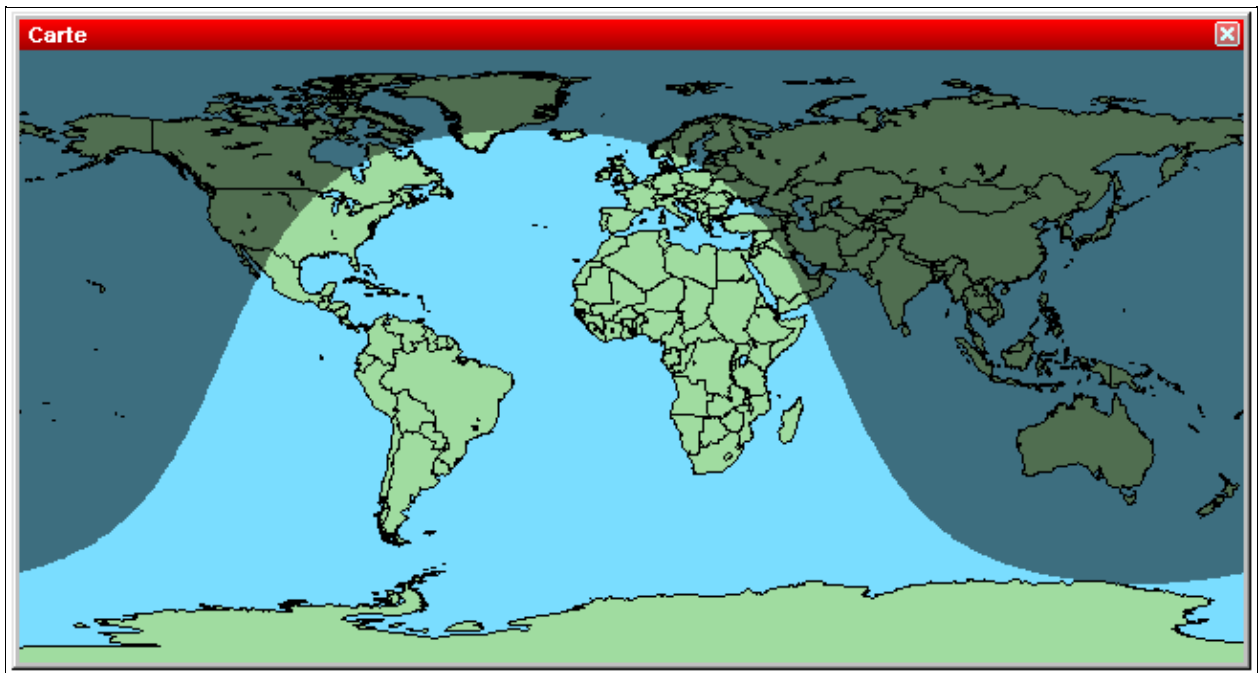

World Map

The World Map shows when you get spotted by someone.

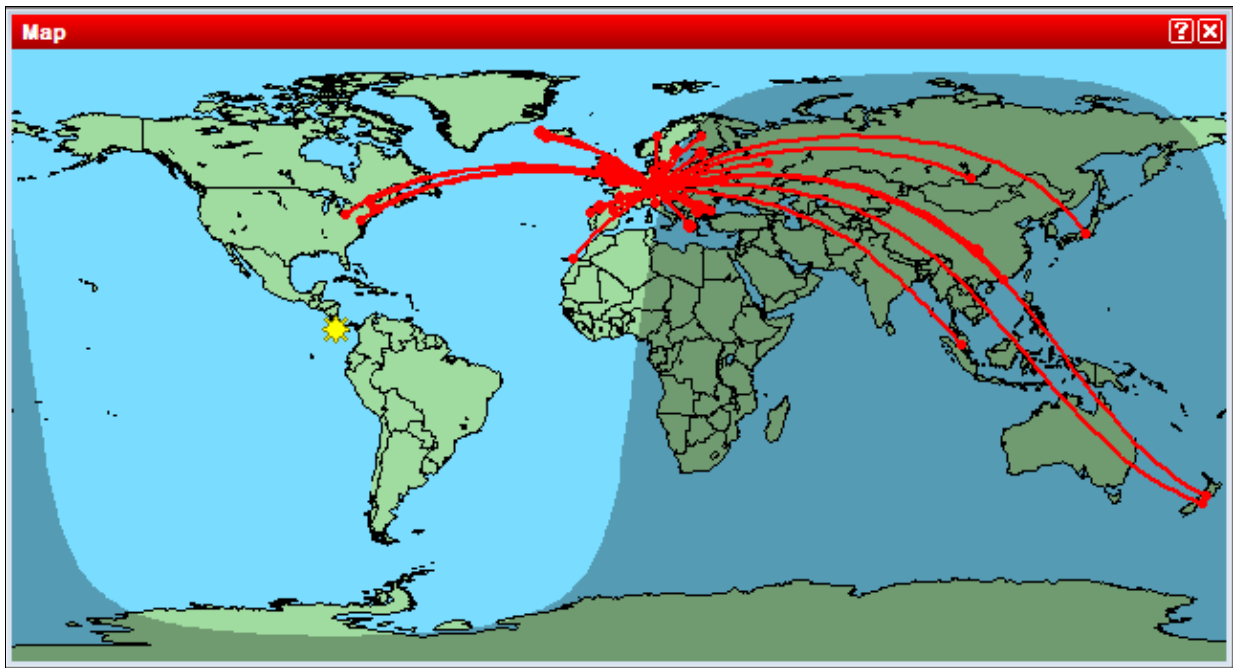

World Map displaying when you are being heard.

The dimensions of this worldmap window can be modified. With a right click, you can display (or not) the grey-line. Moreover, you can increase or decrease the format (zoom). There is a number of options to select in the appropriate context menu.

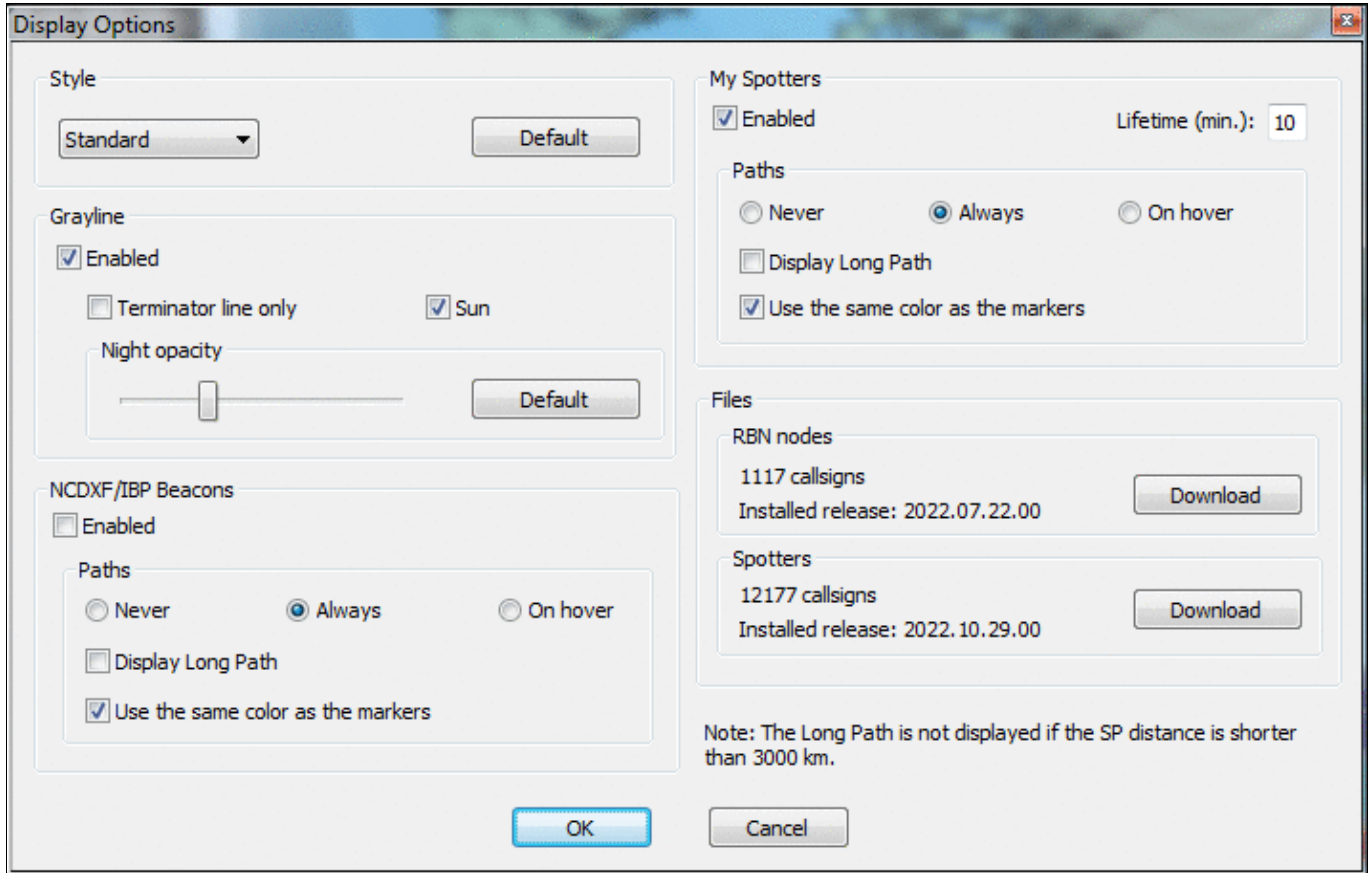

### World Map Context Menu

An additional option allows you to display only the greyline terminator plus a little symbol for the sun which makes reading the information a little easier at times.



World Map with light terminator

## **Radio 1, Radio 2 (Band Maps)**

Windows | Radio 1 or Windows | Radio 2  
Opens (or closes) the radio window.

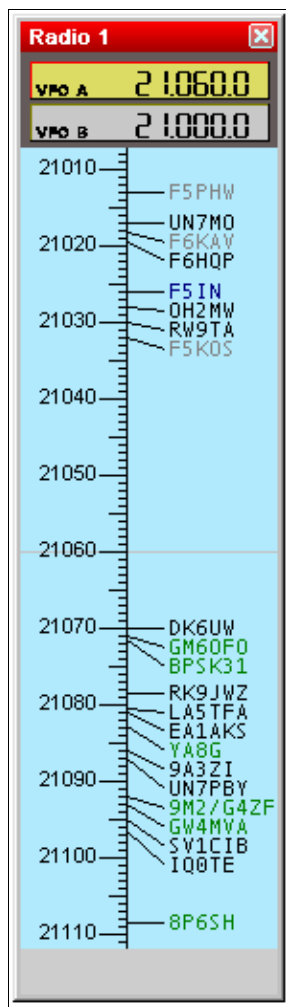

Radio window (band map)

These resizable windows are also called Band Maps.

The frequencies of the 2 VFOs are displayed. The active VFO has a yellow background.

If Win-Test has a DX cluster connection, the bandmaps are automatically fed from the DX cluster data stream, from logging contacts, and by manually adding information using **Ctrl-Enter** instead of **[Enter]**. Op-entered spots are protected from spots of the same DX on a freq inside the mode bandwidth window.

The green callsigns denote new multipliers, the black ones new callsigns (not worked so far), and dupes are in grey color and slanted font.

A double click on a callsign will automatically put the radio on the spot frequency and capture the callsign in the logging field. You just need to complete the QSO and press **[Enter]**! Press **[Alt-F4]** to return to your run frequency.

An **[Alt]**-double click on a callsign will load the spot frequency into the Sub VFO (VFO B), if your radio supports it.

While in split mode during 40m and 80m SSB operation, when adding a spot to the band map, Win-Test remembers both the RX and the TX VFO frequencies, and will store this information so that when you select the spot, both VFOs will be set correctly, and you'll be ready to call (unless the QSX frequency has changed in the mean time).

Moving the mouse pointer over a spot in the band map will bring up additional information, such as the age of the spot the callsign of the spotter, and any comments. Double-clicking the spot with the **[Ctrl]** key removes the spot from the band map (without confirmation).

Other key combinations can be used to operate with the Band Map.

### Band Maps Context menu

A right click on this window brings up its context menu.

- The top option in this Context Menu allows you to program the Sub VFO (if your radio supports it) with this spot.
- The **Propagation** submenu item allows you to gather propagation information via HamCAP (if installed)
- The next two entries **Modify...** and **Delete** allow you to change or remove spots in the band map. Note that you can quickly remove a spot by double-clicking it with the **[Ctrl]** key pressed.
- Additionally, you can change the scale of the band map display from 1:1 up to 30:1. The scale can also be set through the mouse wheel.
- More options are hidden in the sub menus Display Options and Properties... where one can set a lot of minor details of the band map.

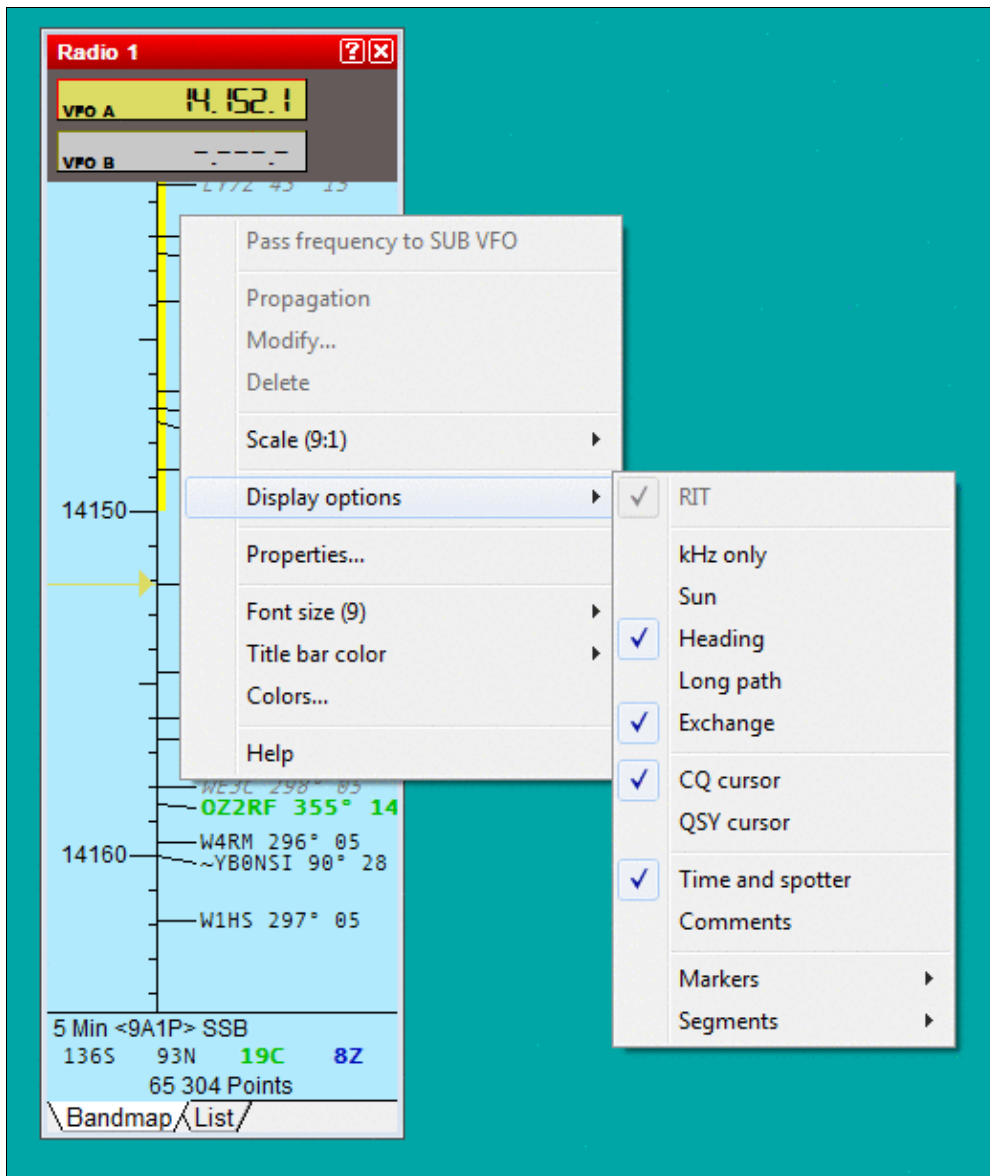

Band Map Context Menu

- 29S 11N at the bottom indicates there are 29 spots total, 11 new calls (not yet worked).
- The List tab of the band map has a context menu with several sorting options:

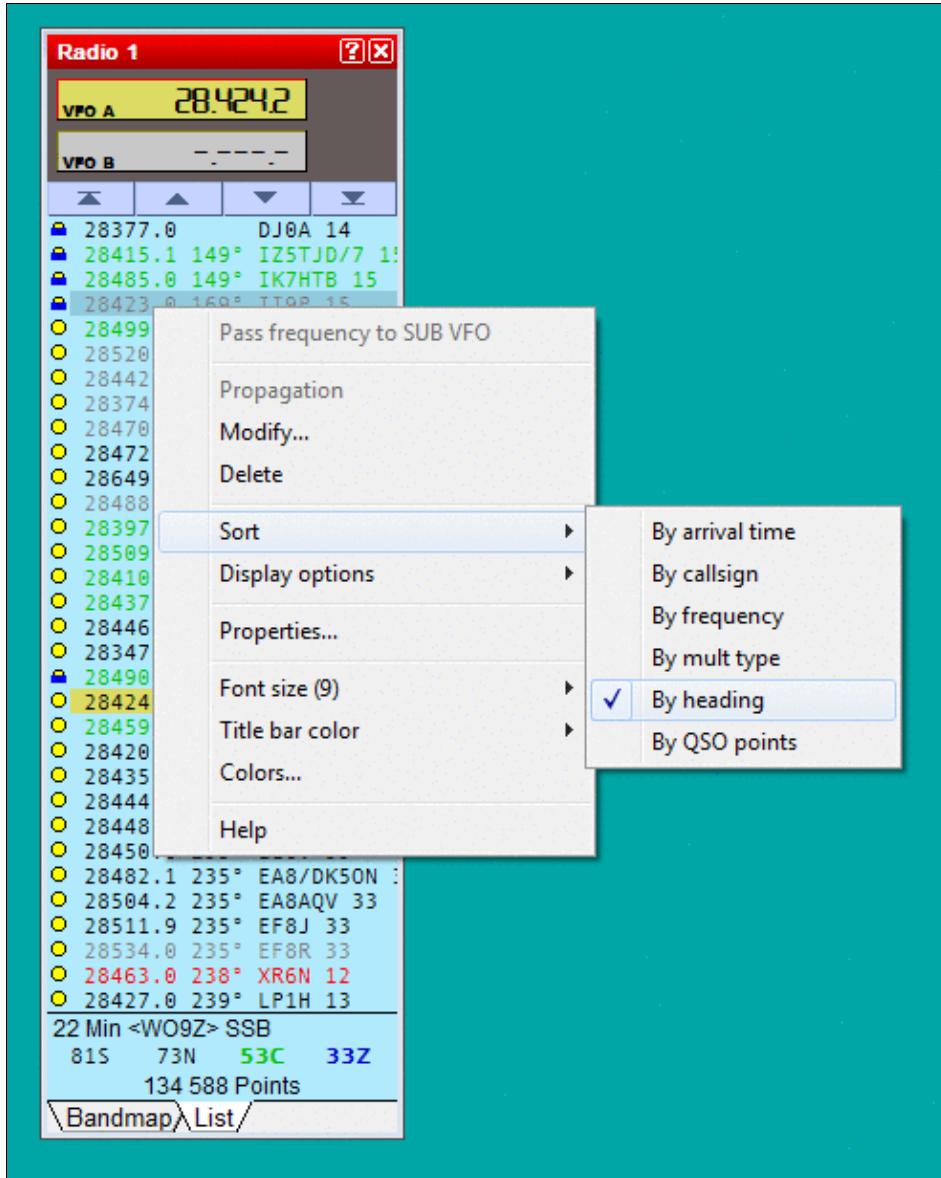

Band Map List View Context Menu - sorting options

- The List tab of the band map has a display option that lets you hide dupes and display additional information:

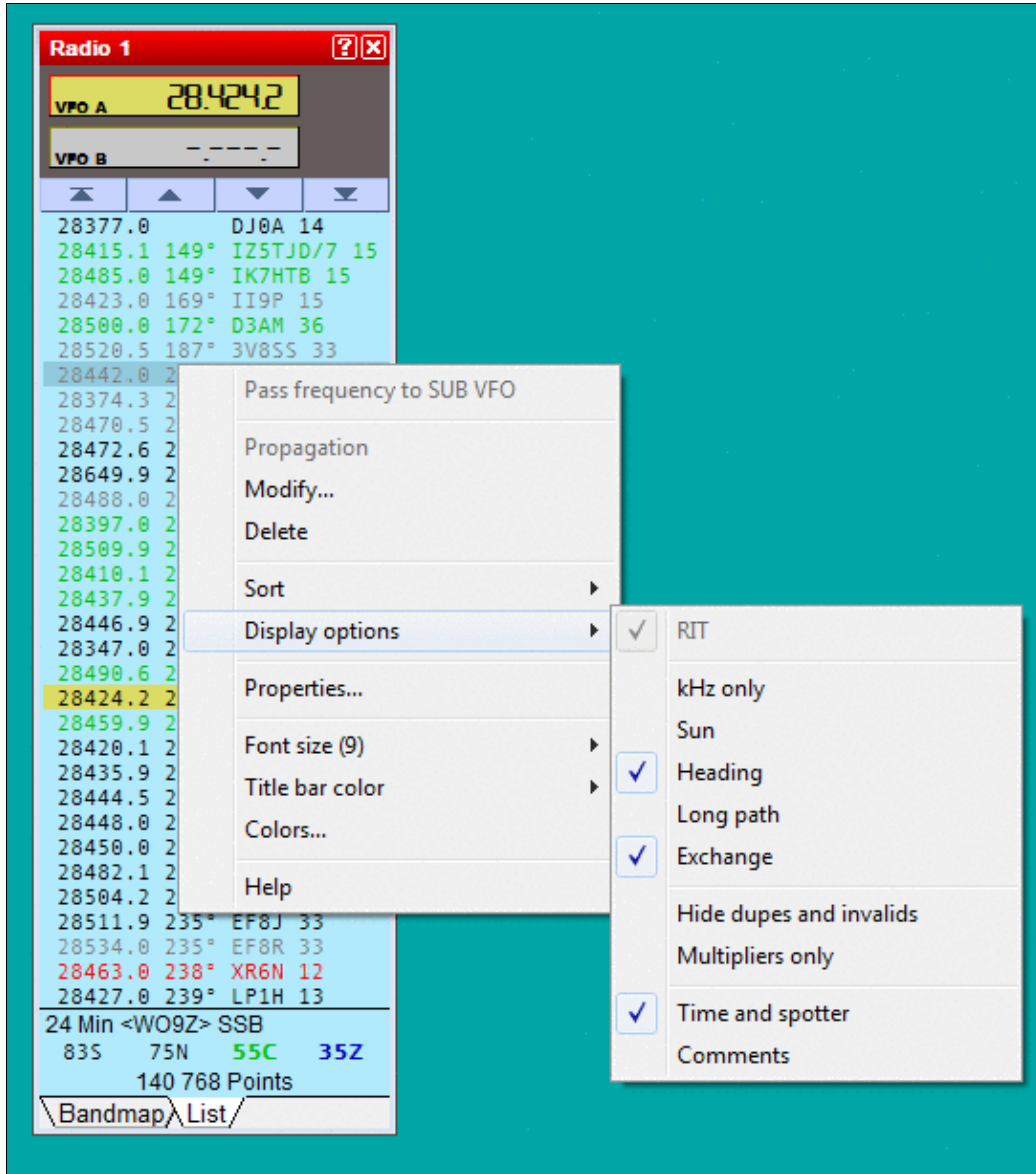



## Band Map List View Context Menu - hiding dupes

- You may toggle between band map and list view using **[Ctrl-tab]**

### Special cursors

Special indicators for the last CQ frequency or the QSY frequency (set with the PASSFREQ text command, or with the Commands | QSY frequency menu option) can also be activated (see picture).

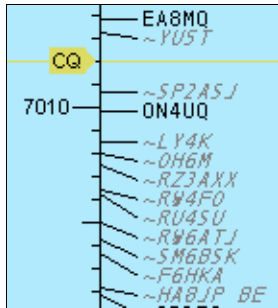

Band Map with CQ cursor

To enable them, tag the CQ cursor and/or the QSY cursor items in the Display Options submenu of the context menu itself.

### Extended information

The Display Options menu also allows you to select if the expected exchange will be displayed in the band map and other minor details, like day/sunrise/sunset/night symbols, time and sender, comments etc.

### Markers

The Display Options menu allows you to enable the displaying of markers. These can be useful for beacons and other known stations on the bands.

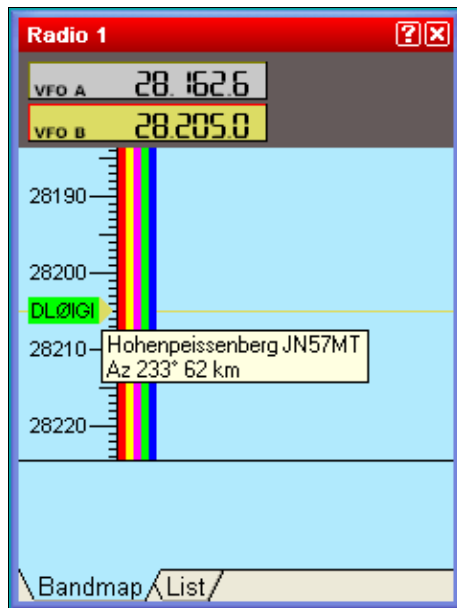

Band Map with a marker file for 10 m beacons loaded

Markers are defined by text files with a **.mkr** extension located in the Win-Test directory. WT can use and display up to 10 files simultaneously; they can be selected in the `Options | Data files | Markers files` menu. For detailed information, please see [Menu: Options Data files Markers files](#).

Marker display settings can be different for each radio. The syntax of the marker files is very basic and they are easy to create with a simple text editor like Notepad.

A marker is defined by its frequency (in kHz), a label (one word) and an optional tooltip (30 chars max.) that will flash when the mouse cursor is positioned on the marker for a few seconds. If you include a four or six character gridsquare locator, WT will display heading and distance to this gridsquare in the tooltip window.

Example:

```
28205 DL0IGI Hohenpeissenberg JN57MT
28257 DK0TEN Sipplinger Berg JN47NT
28277.5 DF0AAB Kiel JO54GH
```

Two **DIRECTIVES** (or **KEYWORDS**) define the background and foreground color:

- **# BACKGROUND** color => Sets the background color of the following markers in the file. If no color is specified, the default color is green.
- **# TEXT** color => Sets the text color of the following markers in the file. If no color is specified, the default color is black.

The known colors are: White, Black, Red, Green, Blue, Yellow, Magenta, Cyan. The case of the color is irrelevant, so "green" and "Green" are identical.

Example :

```
# BACKGROUND white
# TEXT green
#
14100 Bcn NCDXF Beacon
```

This will display a white marker with a green text "Bcn". The associated tooltip will be "NCDXF Beacon". As usual, you can double-click on a marker to set the current radio on the frequency of the marker. A sample file **NcdxfBeacons.mkr** is located in the WT repository at: <http://download.win-test.com/files/markers/>. It displays markers for each NCDXF beacon.

You may build your own marker files (VHF beacons etc.) and share it with the WT community if you want.

### Segments

WT can display band allocations for different license types in the bandmap tab of the radio windows. This allows you to select a run frequency which is in right band segment for US-Advanced or US-Novice amateurs for example.

Band segments are defined by text files with a **.seg** extension located in the Win-Test Extras directory. WT can use and display up to 10 files simultaneously; they can be selected in the Options | Data files | Segments files menu. Please find more detailed information in [Menu: Options Data files Segments files](#).

Due to space constraints - you can't have more than 5 segments displayed per band for any given frequency.

The segments display settings can be different for each radio.

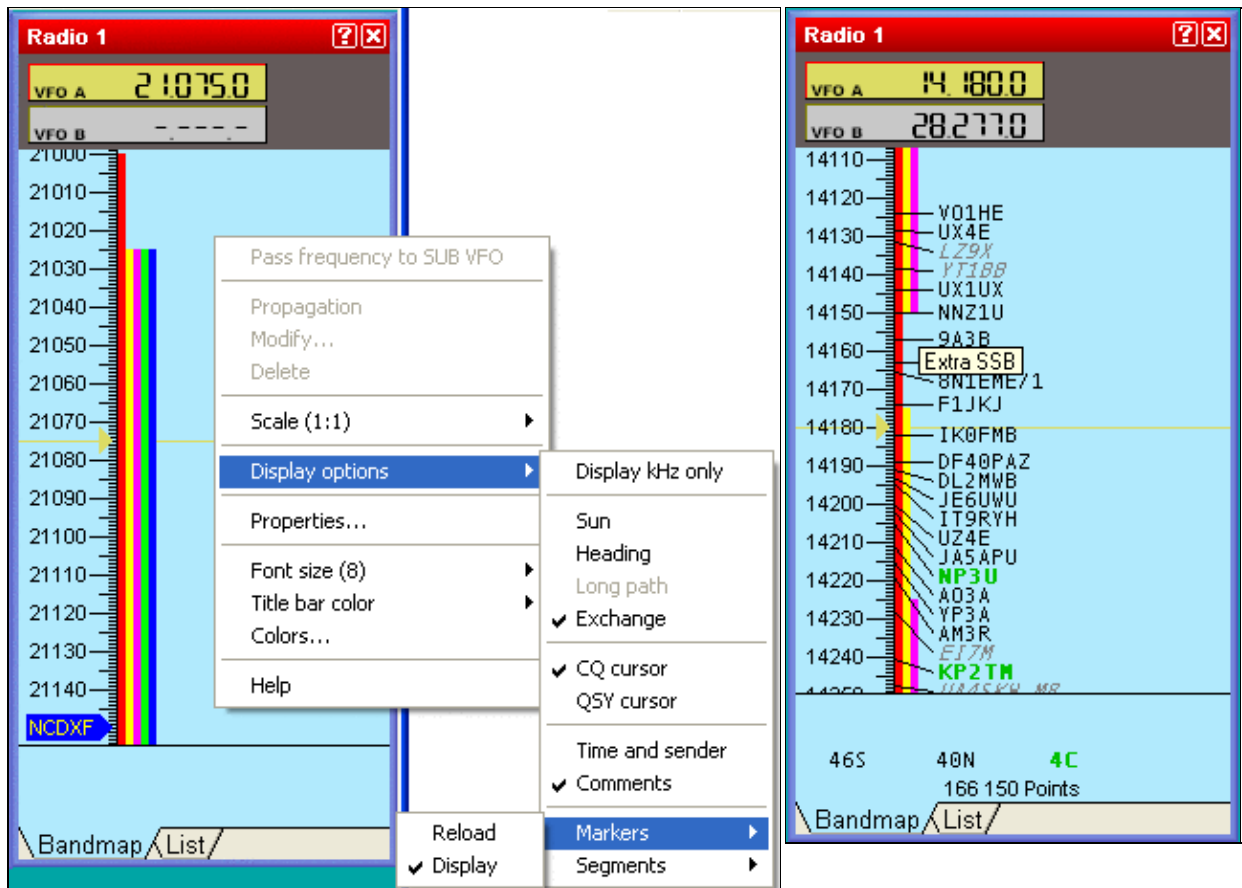

### Band Map with marker and segments

### Band Map with US band allocation

The syntax of the segments files is very basic, and the files are easily created with a simple text editor like Notepad. A segment is defined by specifying its lowest and its highest frequency (in kHz). The two frequencies may be linked by an hyphen for easier reading. An optional tooltip text (30 chars max.) can be given to explain the meaning of the color segment. By placing the mouse cursor over a colored line in the band map display, the tooltip will display.

The BandMap segment color is indicated by the DIRECTIVE (keyword) COLOR like given below. The known colors are: White, Black, Red, Green, Blue, Yellow, Magenta, Cyan. The case of the color name is irrelevant. If no color is specified, the segments will be displayed in yellow.

Example:

```
# COLOR Red
14000-14150 Extra CW
14150-14350 Extra SSB
# COLOR Yellow
14025-14150 Advanced CW
14175-14350 Advanced SSB
# COLOR Magenta
14025-14150 General CW
14225-14350 General SSB
```

This will display the US band allocation in the 20-m-band.

The segments order, and potential overlaps in the file are irrelevant. WT will take care to display them in an optimized way.

Two sample files are located in the WT repository at <http://download.win-test.com/files/segments/>

- **UsSegmentsDetailed.seg** displays all band segments for every US licence type.
- **UsSegments.seg** displays all band segments in which all US licencees are potentially active.

You may create your own band segments files for other countries, regions, etc. and share them with the WT community if you want.

### Band Map properties

Selecting **Properties...** in the context menu of the Radio 1 or Radio 2 band map windows displays the Bandmaps Properties window:

**Bandmaps properties [Alt+H for help]** ✖

**Spots lifetime (min.)**  
From DX cluster:   
Op-entered:

**Spots entered or sent by the operator**  
Log fields are cleared:  
 Always  Never  When dupe

Do not automatically fill the log fields when one grabs a spot  
 Randomize TX frequency in CW (-100/0/+100 Hz)

**Search & Pounce Options**  
When leaving the Operating Frequency, automatically:  
 Wipe the QSO  
 Populate the Band Map  
 Only if the callsign looks valid  
Frequency Change Threshold (in Hz):

**Spots bandwidth (in Hz)**  
CW  SSB  RTTY  Others   
Note: All values must be multiples of 200 Hz and between 200 and 5000 Hz.

**Bandplan**  
Current bandplan in use:

## Bandmap properties window

Here you can define the lifetime of two kinds of spots, control the behavior of the logging window when you press **[Ctrl-Enter]** to create an operator-entered spot, control the automatic entry of data in the logging window when you grab a spot in the bandmap (via double click), select random 100 Hz TX frequency offsets to improve the chances of calling a spot on a clearer frequency (recommended), and the spot bandwidth for each mode (CW, SSB, RTTY) which is used to determine when two spots are on the same frequency. The spot bandwidth can be set between 0 Hz and 5000 Hz, in 100 Hz steps. The lifetime of spots in the band map can be changed from the default (60 minutes) to any other value below 100 minutes.

Search & Pounce Options allow you to add spots to the band map without having to press **[Ctrl-Enter]**. Simply enter the callsign and turn the VFO by the specified frequency change threshold to automatically populate the band map.

**Note:** To automatically populate the Band Map, you must be in S&P mode. Search & Pounce is not activated by default. Select **Tools | Data entry | Enable Run/S&P switching** (text command shortcut: **RUNSP [Enter]**), and then press **[Ctrl-tab]** once to toggle from Run to S&P mode. The clock window indicates the current mode.

## Secondary Radio

Windows | Secondary Radio

Opens (or closes) the Secondary Radio window.

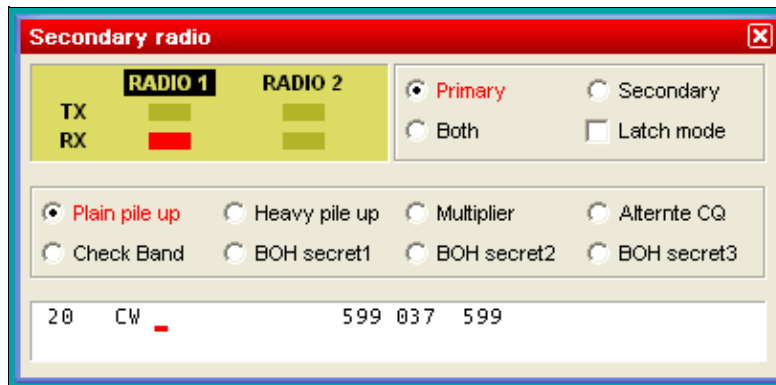

### Secondary Radio Window

This window controls the "other" radio that is currently not in use during SO2R operation, not necessarily radio 2. For more information, please see [SO2R/Second\\_radio\\_window](#).

## RTTY (radio1, radio2)

Windows | RTTY (radio 1)

Windows | RTTY (radio 2)

Opens (or closes) the RTTY Transit/Receive windows.

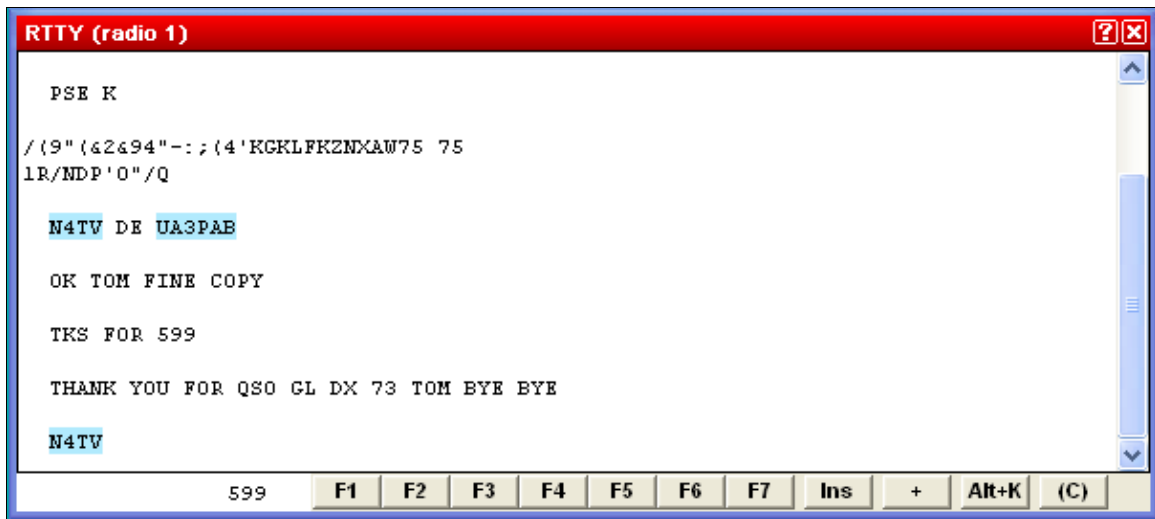

### RTTY TX/RX Window

For more information, see [RTTY Receive/Transmit window](#) in the [RTTY](#) chapter.

## Rotators

Windows | Rotators

Opens (or closes) the Rotators window, which displays the true beam heading (after adding any programmed offsets) of all the antennas available on the current operating band or bands (two bands if using two radios).

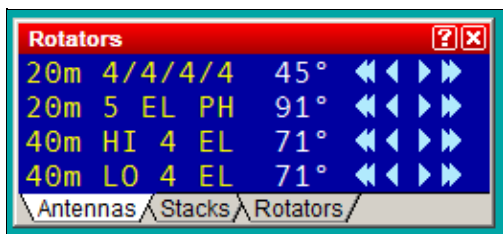

Rotators window with true heading of four antennas on current operating bands

The three tabs at the bottom may be used to select what is displayed:

- **Antennas** - Display the true beam heading (by antenna name) of all named antennas defined for the current operating band or bands. Any defined antenna offsets are used to calculate the displayed heading. Arrow buttons can be used to rotate one antenna at a time.
- **Stacks** - Display the true beam heading of any wtRotator "Stacks" (or "Groups") on the current band. The buttons may be used to rotate the entire stack at once to the same heading, even if each antenna has a separate rotator. The heading of the first rotator added to a stack or group determines which heading is shown for the stack (even if another antenna in the stack is currently pointing in a different direction).
- **Rotators** - Display *all* connected rotators (by rotator name), regardless of band, and the heading of each, as displayed on the control box. Any antenna offsets are ignored.

Click on the arrow buttons to rotate the current antenna, stack, or rotator as follows:

- [ $\ll$ ] - Rotate  $45^\circ$  counter-clockwise
- [ $\lt$ ] - Rotate  $15^\circ$  counter-clockwise

- [**>**] - Rotate 15° clockwise
- [**>>**] - Rotate 45° clockwise

You may also enter a callsign, DXCC prefix, or beam heading in the Win-Test logging Window, and press [**Ctrl**]-**F12** to rotate all antennas defined on the current band to desired heading (assuming your Grid Square or "Locator" is properly defined in the Contest Configuration screen).

*Right click* on the dark blue area of the Rotators window to display the pop-up menu.

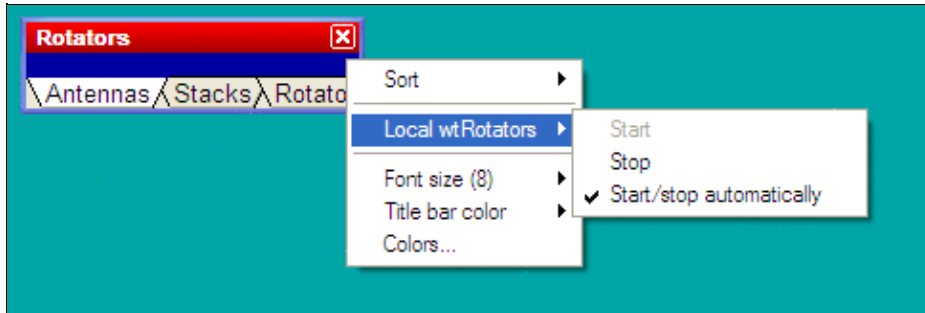

Rotators window with pop-up menus

Use the pop-menu to sort the list, change font size, or start or stop the companion program, **wtRotators**, on the local PC. wtRotators is a program that communicates with one more more rotators, similar to the way that wtDxTelnets communicates with one or more packet clusters. It can be located on the current computer or a separate computer on the LAN, whichever computer is physically connected to a rotator's serial port.

Select the **Start/stop automatically** option to have Win-Test automatically start and stop the wtRotators program on the local computer whenever you open or close Win-Test.

See the [Rotators](#) main topic for more information about configuring and using wtRotators with Win-Test.

## DX-Cluster Monitor

Windows | DX-Cluster monitor or **Alt-O**  
Opens (or closes) the DX Cluster monitoring window.



```

Dx Cluster
Deconnexion de l'utilisateur F6IPS
DX de JJ2LPV:      7005.0 YA1D      1332Z
DX de W2QN:       18140.1 V25A      Bob      1332Z
DX de DJ9HQ:      18105.0 PIRATE      USB      1336Z
DX de K3Z0:       7005.0 YA1D      relayed by HS0ZDY  1336Z
DX de ON4ACU:     21012.0 EA8/DJ3XD    not rw0bb/9 !    1338Z
DX de IT9EJW:     14030.0 YI9ZF      qs1 SM1DTE cq    1337Z
DX de DJ4MJ:      14030.0 YI9ZF      1338Z
Deconnexion de l'utilisateur GU6RWD
DX de NJ6D:       7002.5 UR8QQ      Cqing LP  1338Z
DX de DG4FDQ:     18135.0 US6IRA      59       1339Z
DX de WA60EC:     7015.0 BG9BA      CQ       1340Z
DX de OZ1PMX:     14081.7 RA0QR/6    RTTY     1341Z
DX de SM5EDX:     3799.0 W6UC       1343Z
DX de SP2DNI:     14030.0 YI9ZF      1344Z
Deconnexion de l'utilisateur F5KDC-1
DX de K3KO:       14030.0 YI9ZF      LP       1345Z
DX de W6UC:       3799.0 OH6WW      1346Z

```

### DX Cluster monitoring window

The contents of this window are logged to the **.pkt** file. Logging can optionally be disabled to save disk space or to prevent malware scanners from slowing down the system -- in particular, when a lot of spots is being received (e.g. via RBN). To disable logging, right-click in the window and uncheck "Stream logging".

The window is scrollable so that you can step back through history, back - even to the beginning of the file. The scrolled window will not update when new spots arrive. However, there is a little hint in the title bar like **[+1138 lines]**. In order to see all spots which have arrived in the mean time you have to move the scrollbar back to the end of the window.

For more information regarding the setup of DX Cluster connections, please see [Commands | DX Cluster](#)

## DX-Cluster Announcements

Windows | DX-Cluster Announcements or **Alt-A**  
 Opens (or closes) the DX cluster announcements window.

```

DX-Cluster announcements
) 14080.0 VK45N      1027z <SQ3PAK>
) 3574.2 KG7UL      1027z <KL7X>
) 21014.0 R022NY    1026z <9A5CW>
) 28076.4 OZ4TX     1026z <OZ5BD>
) 28076.0 Z54JAN    1025z <EA3OR>
) 28076.6 EA1CP     1024z <HS2AQG>
) 1818.5 N4DB       1024z <VK2WF>
) 28074.5 OZ9FZ     1028z <OZ5BD>
) 14019.5 R104FSB   1028z <RV7C>
) 21073.0 Z38/DF8AN 1028z <G800>
) 3573.0 VK4ZD     1028z <W3KB>
) 7067.0 IQ6KX     1028z <S54KD>
) 21022.0 VK9DX     1029z <IU3MIK>
) 14058.0 EC6PG     1029z <CU3BL>
) 28074.0 OZ5BD     1030z <OZ9FZ>

```

### DX Cluster Announcements Window

This window gathers all the spots coming from the DX cluster. New multipliers are green, other stations (but not dupes) are black.

A double click on a selected line will automatically switch the active radio to the spot frequency, and will grab the call and enter it in the callsign logging field. You just need to complete the QSO and press **[Return]**.

QSO information (like QSO 7239) is parsed from the comment field of the spot and handled correctly, so that when you click on such a spot, the transceiver will switch to split mode, put VFO A on the RX frequency and VFO B on the TX frequency. QSO is indicated by an asterisk (\*) character on the spotted callsign. Cross-band QSO frequencies are being ignored.

With a right click, you can choose to display only new multipliers, only spots entered by the operator and/or selected bands:

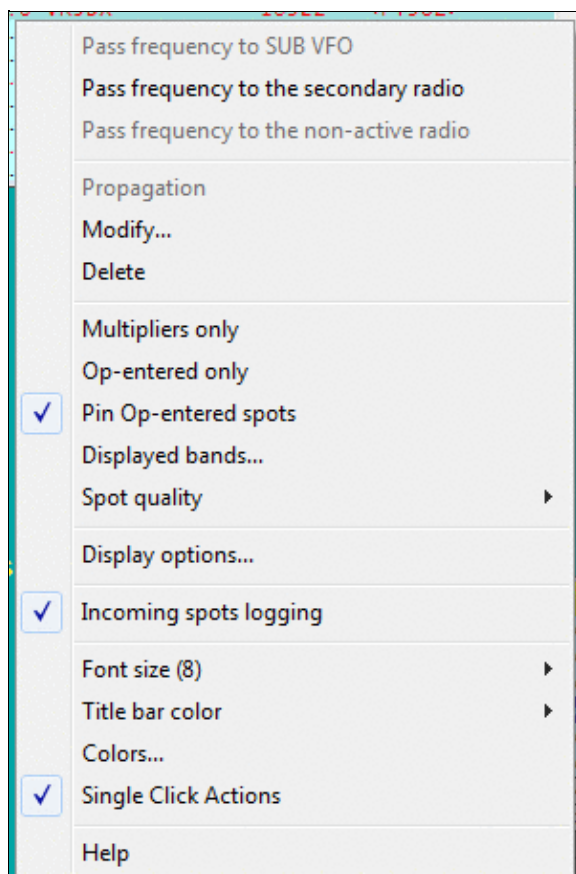

## Win-Test Wiki

Band selection pop-up menu for the DX Cluster Announcements window

Op-entered spots enable you to enter spots on your own - they will be marked with a circonflex and remain at the bottom of the announcements window and not overwritten by incoming DX Cluster spots.

CT1BOH's quality tags can be used to filter out unwanted spots (if supported by your Skimmer or DX Cluster). Check the appropriate fields in the context menu to select spots you want.

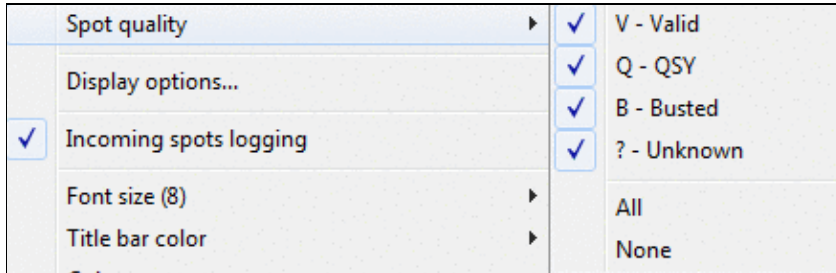

Enable spot quality for the DX Cluster Announcements window

All spots are logged to the corresponding **.dxc** file in the log directory. Logging can be disabled to save disk space or prevent malware scanners from slowing down the system - in particular, when a lot of spots is being received (e.g. via RBN). Manually entered spots are still being logged to the **.dxc** file.

The displayed information is selectable (local time as a sun symbol, exchange, time spotted, spot comments, spot quality, beam heading, and the callsign of the spotter):

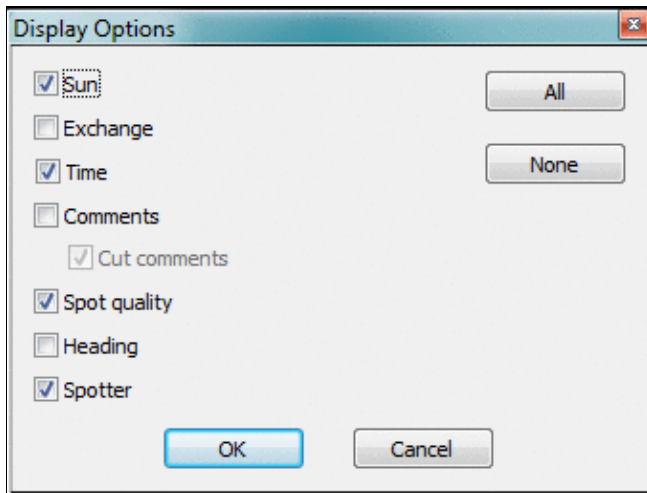

Display options for the DX Cluster Announcements window  
 Additional shortcuts:

- **[Ctrl] + Dbl click** on a spot removes the spot from the Announcements window (without confirmation).
- **[Alt] + Dbl click** on a spot loads the spot frequency in the sub VFO of the active radio (if your radio supports it)

For more information regarding the setup of DX Cluster connections, please see [Commands | DX Cluster](#)

## NCDXF/IBP Beacons

Displays the transmission schedule of the NCDXF / IBP (International Beacons Project) beacons. A double click on a line sends the radio to the beacon freq. An "i" (stands for "info") in the status column indicates a comment you can read by hovering the mouse over it.

FREQ	BEACON	DIST.	SP	LP	ST.
14100.0	VE8AT	6748 km	346°	166°	ON i
18110.0	4U1UN	6490 km	297°	117°	ON
21150.0	YV5B	8478 km	268°	88°	ON
24930.0	0A4B	10906 km	261°	81°	ON
28200.0	LU4AA	11526 km	233°	53°	ON

NCDXF/IBP Beacons Window allows you to keep an eye on propagation conditions.

## Clock

Windows | Clock

Opens (or closes) the clock window.

11:50:26	I2WIJ	JN450L	SR 0507z	SS 1723z	S/P
12:00:05	I2WIJ	JN450L	SR 0507z	SS 1723z	RUN

Clock window samples

To set time in Win-Test, you don't need to change the computer time. You just need to adjust the computer clock in the local time, within the right time zone. Win-Test will compute the UTC time from this information.

The color of the time display changes in minutes 59 and 00, to prepare an operator changeover in a multi-op environment.

This window also displays sunrise and sunset times (SR and SS) according to your location. To catch your eye, the color of these times will change when you are within 30 minutes of sunrise or sunset times.

This window also displays your Locator (which is needed if you want that WT exactly compute SR/SS times as well as Bearings and distance to the correspondent) and the Win-Test operating mode, RUN or S/P, according to your operating needs. For details on this feature see also [Menu:Tools Data entry](#).

Just as a side note, WinXP allows you to synchronize your computer's clock time through the Internet. Please see more details on Microsoft's support pages ([overview](#) and [details](#)).

The font type and size, as well as the background and all the usual window colors can be changed through the context menu using a right mouse click on that window.

## Contest Recorder

Windows | Contest Recorder

Opens (or closes) the Contest Recorder window.

Before recording, right click and select [MP3 Configuration](#) to set the recording parameters.

A right-click on the Recorder window provides help to the keyboard shortcuts. Use `right-click | Files Information` to see information about recorded files, or to delete recorded files. Start the recording by pressing **AltGr-O** or using the text command shortcut: **RECORD** or **STARTRECORD**, stop the recording using **NORECORD** or **STOPRECORD**.

The recording is a standard MP3 file which can be played on any MP3 player. Win-Test actually saves timestamps in the MP3 files which allows for a quick navigation when run from within Win-Test. Win-Test creates sequential files up to a specific size (690 MBytes by default) and then switches to a new file.

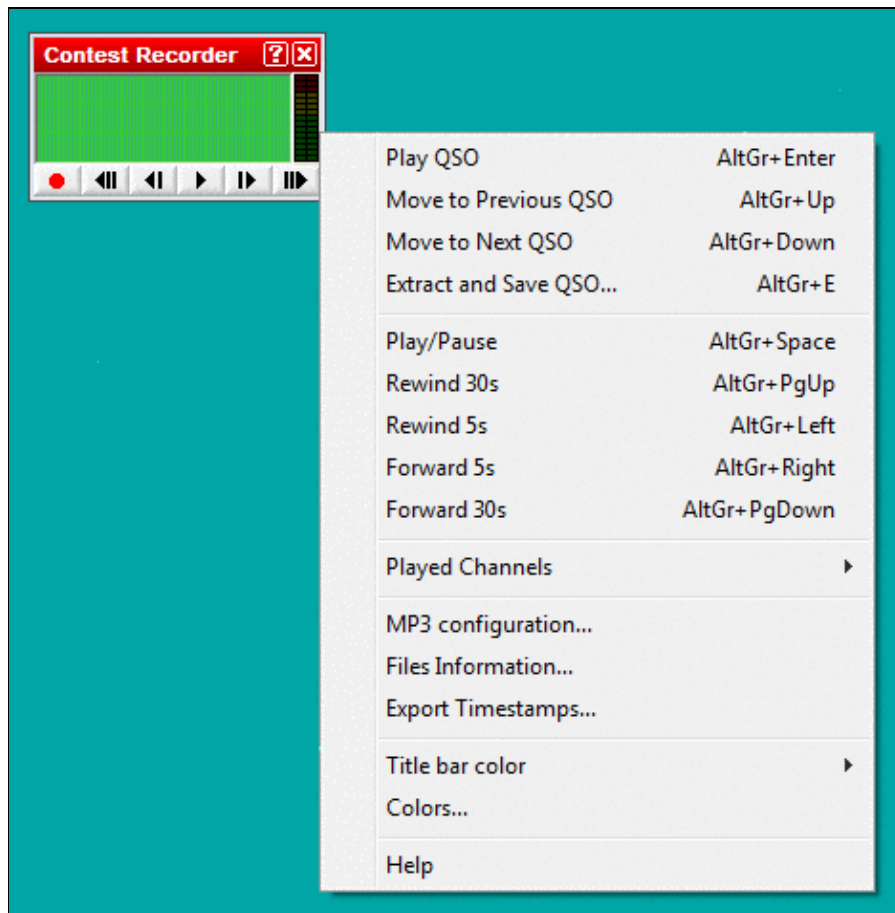

### Contest Recorder window with context menu

The Contest recorder is a powerful tool to check your copying abilities, verify notes you have made during the contest or let others listen to what was audible on your end of the QSO. The shortcut **AltGr+Enter** quickly lets you jump to a specific QSO recording and you can then use the fast forward and fast backward functions to play it over and again.

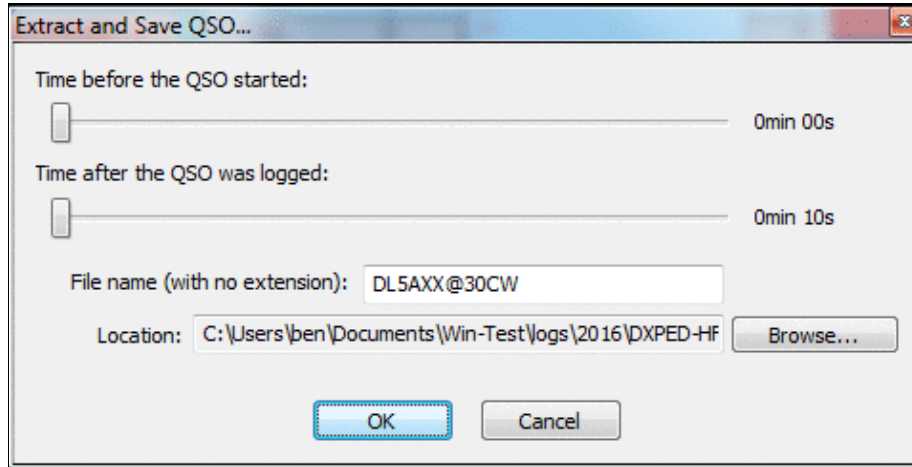

### Extract QSO dialog

Please note that in some contests, modifying your log after the contest is against the rules. However, it is never prohibited to go back to your log after having received your UBN report from the contest sponsor and find out why you failed to copy something or assumed a QSO where it wasn't a perfect QSO.

In very fierce competitions like WRTC, teams must provide a complete recording of the whole contest (both receive and transmit audio) to their referee. To record the transmit signal can be tricky and may require additional hardware, as some radios do not supply the monitor signal on the audio output line.

Win-Test uses the "standard" MP3 tags.

```
Title : Contest name + Category mode + File number (starting at 000)
Artist : Callsign
Album : Station
Year : Contest year (1st QSO)
```

In order to play QSOs, the MP3 tags must match the settings in the current .wt4 file. Otherwise, the recorder will display the message "No record for station X", with X being the current station number.

N6TV gave a comprehensive presentation on the subject at the Visalia International DX Convention 2019 which you can find on his web page:

[https://www.kkn.net/~n6tv/N6TV\\_Visalia\\_2019\\_Recording\\_A\\_Contest.pdf](https://www.kkn.net/~n6tv/N6TV_Visalia_2019_Recording_A_Contest.pdf)

## SSB bargraph

Windows | SSB bargraph

Opens (or closes) the SSB bargraph window



SSB bargraph window

This bargraph displays the audio level of the Win-Test's digital voice player (if used, of course). The appropriate level is the yellow part of this bargraph. The windows can be rotated by 90 degrees.

## Close all Windows

Windows | Close all windows

Closes all windows except the log entry area in the left lower area.

[Back to Menu](#)

## Namespaces

- [Page](#)
- [Discussion](#)

## Variants

## Views

- [Read](#)
- [View source](#)
- [View history](#)

## More

- This page was last edited on 9 April 2023, at 15:44.

- [Privacy policy](#)
- [About Win-Test Wiki](#)
- [Disclaimers](#)

- The logo for MediaWiki, featuring a sun icon and the text "Powered By MediaWiki".

# Menu:Options

From Win-Test Wiki

[Jump to navigation](#) [Jump to search](#)

## Menu:Options

### Contents

- [1 Load contest at startup](#)
- [2 Automatic backup...](#)
- [3 Disable log synchronization on network](#)
- [4 CW](#)
  - ◆ [4.1 No sound](#)
    - ◇ [4.1.1 Note for some new Laptops](#)
  - ◆ [4.2 Initial Speed](#)
  - ◆ [4.3 Modify standard messages...](#)
    - ◇ [4.3.1 Sprint Exchange Logic](#)
  - ◆ [4.4 Modify additional messages...](#)
  - ◆ [4.5 Modify WAE messages...](#)
  - ◆ [4.6 Custom variables...](#)
  - ◆ [4.7 Serial number](#)
  - ◆ [4.8 Correction](#)
  - ◆ [4.9 Shortened spaces \(CT spaces\)](#)
  - ◆ [4.10 Auto sending...](#)
  - ◆ [4.11 Remap keys in keyboard mode](#)
  - ◆ [4.12 Work dupes](#)
  - ◆ [4.13 Speed bursts](#)
- [5 RTTY](#)
  - ◆ [5.1 Modify standard messages...](#)
  - ◆ [5.2 Modify additional messages...](#)
  - ◆ [5.3 Modify WAE messages...](#)
  - ◆ [5.4 Custom variables...](#)
- [6 Configure interfaces...](#)
  - ◆ [6.1 Serial Ports](#)
  - ◆ [6.2 Transceivers](#)
  - ◆ [6.3 Printer Ports](#)
  - ◆ [6.4 CW](#)
  - ◆ [6.5 Local Network](#)
  - ◆ [6.6 Network Protocol Advanced Settings](#)
  - ◆ [6.7 Voice Keyer](#)
- [7 WinKey configuration...](#)
- [8 EZMaster configuration...](#)
  - ◆ [8.1 CW Keyer](#)
  - ◆ [8.2 Radio set-up](#)
  - ◆ [8.3 Packet-Radio TNC](#)
  - ◆ [8.4 Antenna configuration according to RX/TX](#)
- [9 MK/MKII/MK2R/u2R configuration...](#)
- [10 OTRSP configuration...](#)



- [11 RTTY configuration...](#)
- [12 Frequency Offsets](#)
- [13 MP3 Configuration](#)
- [14 Script Editor Configuration](#)
- [15 Log](#)
  - ◆ [15.1 Fonts](#)
  - ◆ [15.2 Headers](#)
  - ◆ [15.3 Hide QSO numbers](#)
  - ◆ [15.4 Align Exchanges](#)
  - ◆ [15.5 Stay in field when moving up and down in the log](#)
  - ◆ [15.6 Block Cursor](#)
  - ◆ [15.7 Colors...](#)
  - ◆ [15.8 New Contest Files Properties](#)
- [16 DXpedition Info Field](#)
- [17 Spot Warnings](#)
- [18 DX Cluster](#)
  - ◆ [18.1 DX Cluster window shortcuts](#)
  - ◆ [18.2 Start/stop wtDxTelnet automatically](#)
- [19 HamCAP](#)
- [20 WAEDC](#)
- [21 Data files](#)
  - ◆ [21.1 Country files...](#)
  - ◆ [21.2 Master file...](#)
  - ◆ [21.3 Exchanges Database...](#)
  - ◆ [21.4 Default extra data files...](#)
  - ◆ [21.5 Markers files...](#)
  - ◆ [21.6 Segments files...](#)
- [22 Bandplans...](#)
- [23 Windows](#)
- [24 Toolbar](#)
- [25 Language](#)

## Load contest at startup

Options | Load contest at startup

Enables or disables the automatic loading of the last contest file in use. This command is useful to get on line again quickly if - for some reason - Win-Test crashed or you had to quit the Win-Test in the middle of the contest.

If you like to switch to another file, close this file using `File | Close` and then `File | Open` menu dialog.

If Win-Test is started with the `[Ctrl]` key down, it doesn't automatically load the previous log.

When starting Win-Test from the command line, use `-n` or `--noautoload` option to prevent automatically loading the last file in use.

## Automatic backup...

Options | Automatic backup...

This function enables or disables the automatic backup of the .wt4 file to another location, e.g. network drive or removable media like an USB stick.

You can choose an automatic backup interval between 1 and 120 minutes. If a backup fails, you are prompted if you wish to disable the backup.

The backedup files will be named identical to the original name with the extension .bak. Optionally a different (time-stamped) filename will be used for every new backup file (actually a good idea for backing up to a network drive!).

If the option "Always notify..." is ticked, an informal message will be displayed at the bottom of the screen after a backup run has finished.

For DXpeditions it may be useful to automatically create a Logsearch File with every backup. In this case, tick the corresponding option.

**Note:** Contrary to the .wt4 backup files, the LogSearch exports are not done in a separate background thread. Thus, it is not recommended to enable this option on a running station because WT will be unavailable for logging for a while every time an export is in progress.

Since Win-Test version 4.19, the backup also includes QTC files for WAEDC.

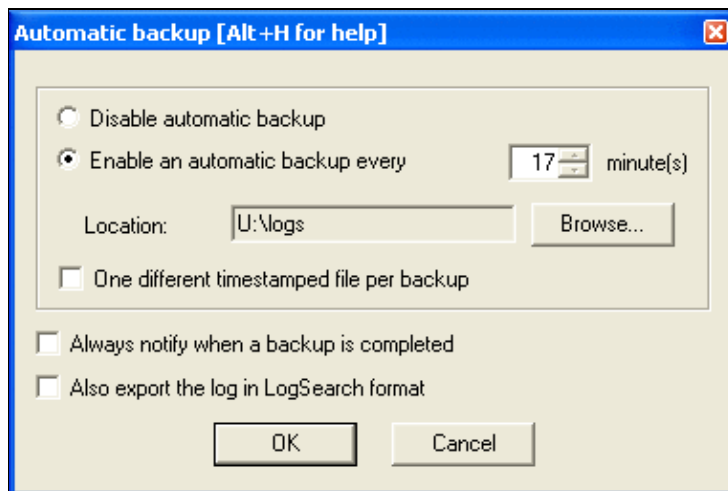

## Setting up Automatic Backup

Here is some additional advice:

- Backups are processed in a separate thread, meaning that you will not even notice that a backup is in progress! No slowdown, no keyboard blocking etc...
- Of course, it makes sense to backup to a different volume than your "working" drive. This avoids loss of everything if your hard disk fails. Do not smile... It happens, sometimes! (ARRL SSB 2002 FY5KE, IIRC!)
- Once you entered the last QSO, for safety, generate your Cabrillo log(s) before exiting. A simple "MAKELOG" command opens the appropriate dialog.
- In all cases, always make a copy of a file when you want to use/test/modify it. Always keep a backup, never use the original! If you have FTP access somewhere, copy the file there as soon as possible! If your computer crashes, you still will have a safe copy.

Call me paranoid, but believe me, you need to loose some day a **very** big chunk of data to understand the importance of backups!

## Disable log synchronization on network

Options | Disable log synchronization on network

Text command shortcuts: **NOSYNC** | **SYNC**

When selected, this option disables automatic background log synchronization over the network. It is only useful under certain circumstances, such as Clearing all logs before the start or deleting individual QSOs from a log when single-op, and using only one computer, because QSOs cannot be removed from a log when log synchronization is enabled.

**This option does not prevent QSOs logged on other computers from being added to the current log;** it only stops the background synchronization of any "missing" QSOs, which reduces network traffic when needed, such as when using very slow legacy serial port networking.

**Note:** Even when log sync is disabled via **NOSYNC**, whenever a *new* QSO is made on another computer in the network, **that QSO will still be broadcasted and added on all connected computers** as soon as it is logged. The best way to keep *all* QSOs from other computers from appearing in a log is to use the **Packet sharing only** button in the Network Protocol Advanced Settings dialog.

## CW

Options | CW

This menu item allows you to control different aspects of CW operation. It is enabled only when the selected operating mode is CW (otherwise it is greyed out).

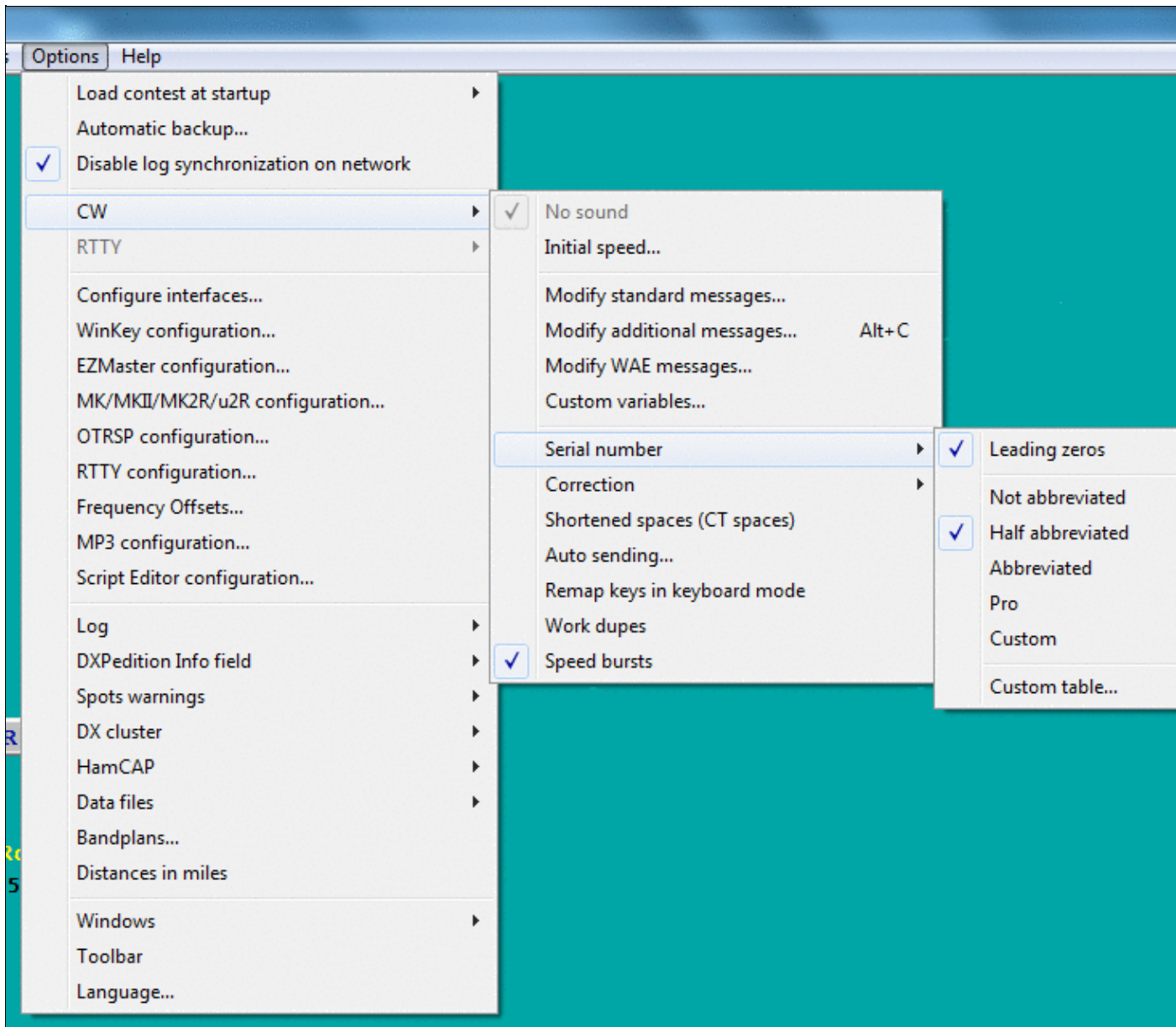

CW Options submenus

## No sound

Options | CW | No sound

If checked, no CW sound will be played through the internal speaker. This option is also available through the **SOUND/NOSOUND** text commands.

This option is disabled by default since Win-Test Version 4.18.0 when Win-Test runs under an operating system after Vista included. It means that it will not work for those newer OS, and *may* work on previous OS, depending on the hardware. In all cases, it is very much recommended to rely on the radio's internal sidetone generator instead.

### Note for some new Laptops

In some new generation Laptops, it is necessary to enable the PC Speaker in the BIOS to have it to work properly.

Moreover, with some Sound systems, you have also to enable the PC Speaker in the "Volume Control". Here is how to do it:

- Double click on the Speaker icon in the system tray
- In the menu, select Options | Properties, and search for the PC Speaker Volume Control and enable it
- Set the Volume slider to the appropriate sound level

Unfortunately, some newer Laptops do not support the PC Speaker "beep" at all anymore... :(

## Initial Speed

Options | CW | Initial Speed

Sets the initial CW speed for new files.

## Modify standard messages...

Options | CW | Modify standard messages...

For quick access to this dialog, use the text command **MESSAGES** or **MSGS**.

The place to change the CW messages, both for Run and S&P mode. See [Enable Run/S&P Switching](#).

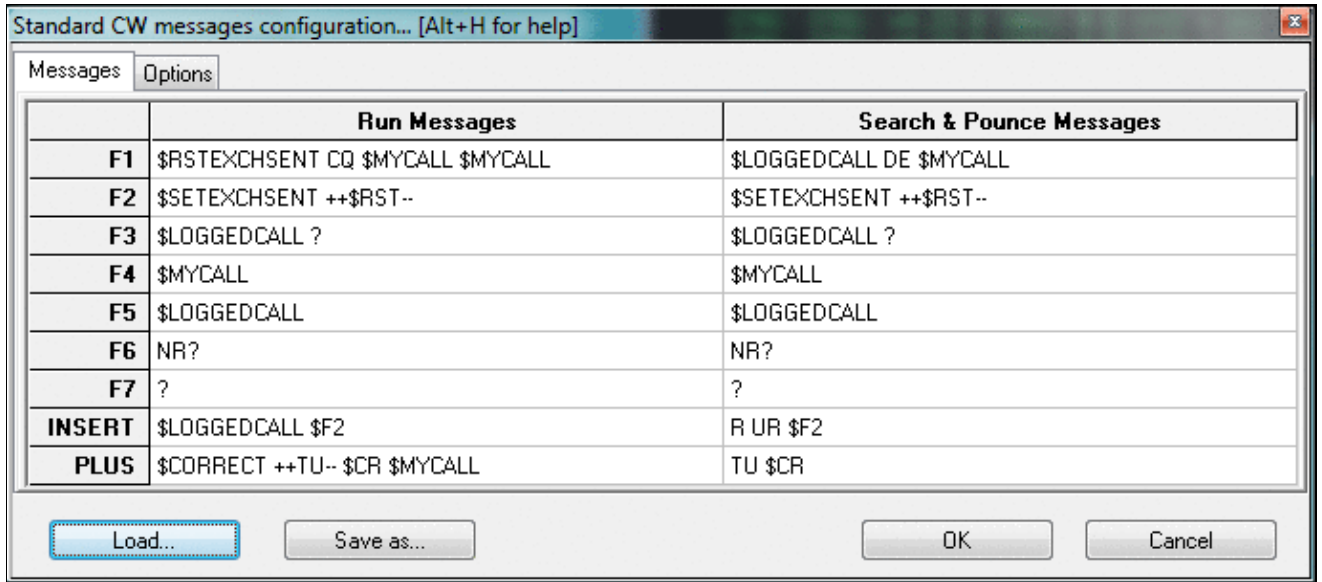

Modifying CW messages; you may also edit the memories one by one using **Shift+F1**, **Shift+F2** etc. Please have a look at the list of [message variables](#) you can use in the CW memories to control different aspects of the operation.

Since Win-Test version 4.20, messages can be saved and loaded from previous **\*.wt4** or special **\*.msg** files.

The Options tab of this window lets you redefine the \$QSOB4 macro. The only variable that can be used in this field is \$MYCALL, e.g. "QSO \$MYCALL TEST".

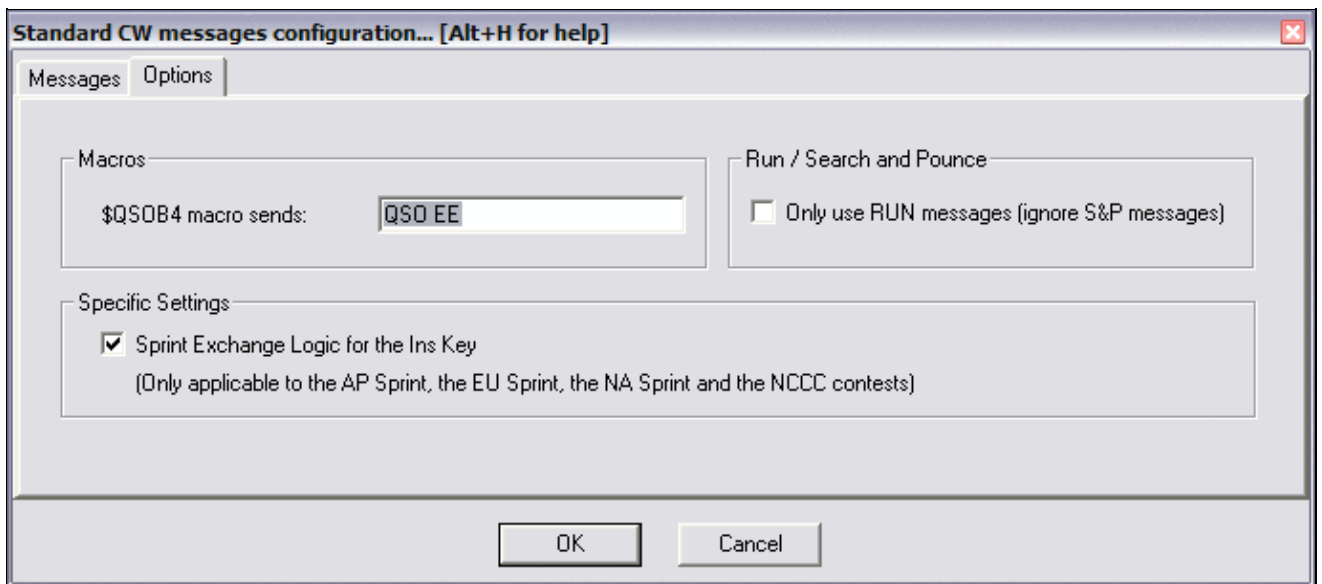

CW messages options.

Check **Only use RUN Messages (ignore S&P Messages)** to force Win-Test to use only one set of CW messages, regardless of operating mode.

### Sprint Exchange Logic

Use **Sprint Exchange Logic for the Insert key** to signal to a listening station that you will take over the frequency after a QSO, by signing your call at the end of the exchange. When checked, pressing **[Insert]** sends the "Run Message" if the logged serial number field is blank, otherwise it sends the "Search & Pounce Message". This option only applies to the Sprint contests. It is ignored for other contests, so it may be left checked all the time.

Here is example of how to set up the CW messages for the NA Sprint, with Sprint Exchange Logic enabled. Note the programming of the **[Insert]** message:



Sample CW messages to be used for the NA Sprint, with Sprint Exchange Logic

### Modify additional messages...

Options | CW | Modify additional messages...

The place to create or modify additional CW messages which can be accessed using **Alt-C**. These memories can be used for transmitting QSL information, special greetings, QSY/skeds information. It also defines the macros \$MSG1 to \$MSG12 that may optionally be used as part of any standard CW message.

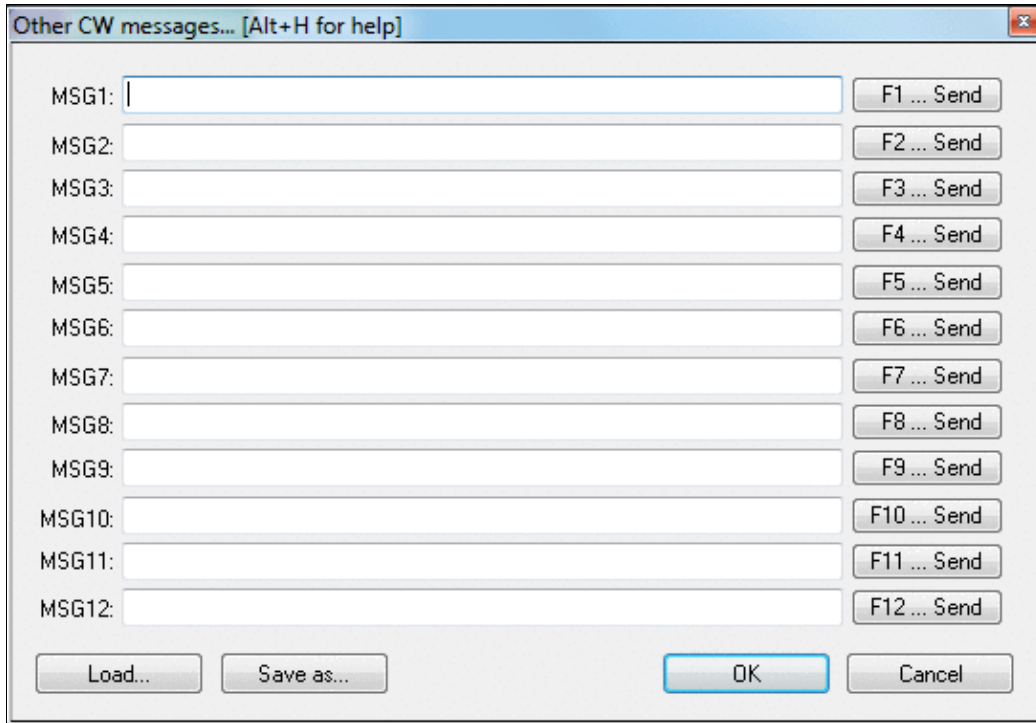

Additional CW messages that may be used occasionally like QSL info etc.

### Modify WAE messages...

Options | CW | Modify WAE messages...

This function allows you to define CW message text which is available during transmit/receive of QTC traffic. The QTC window is specific to the WAE DX Contest and can be opened using **ctrl-L** (transmit QTCs) or **Alt-L** (receive QTCs). For more details of WAEDC, please see [WAEDC](#).

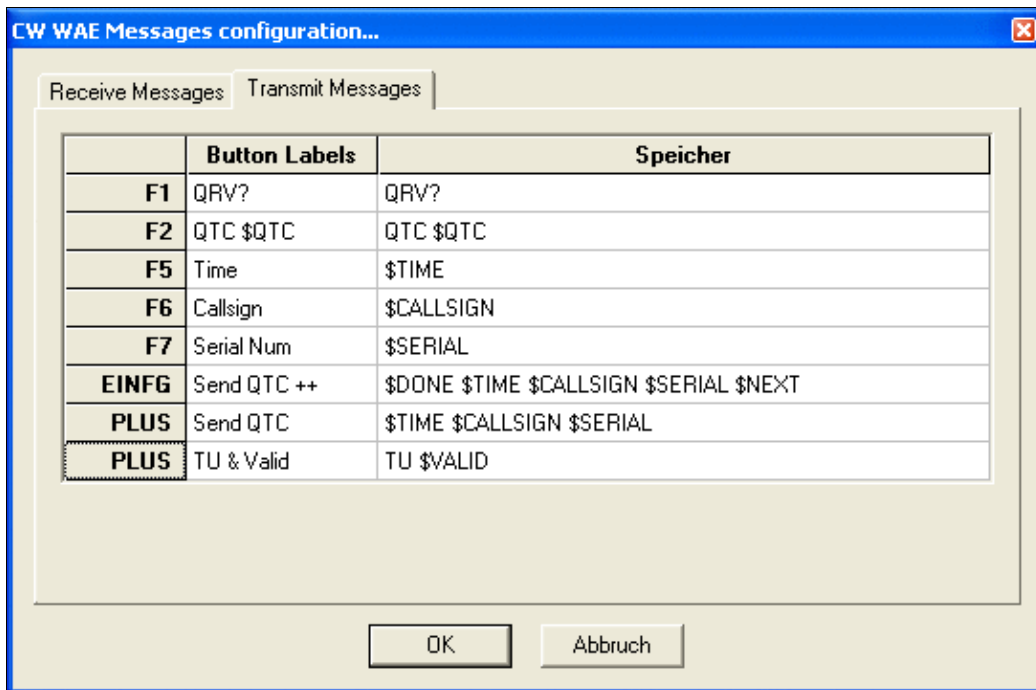



Additional messages (transmit) for QTC handling in the Worked All Europe DX Contest.

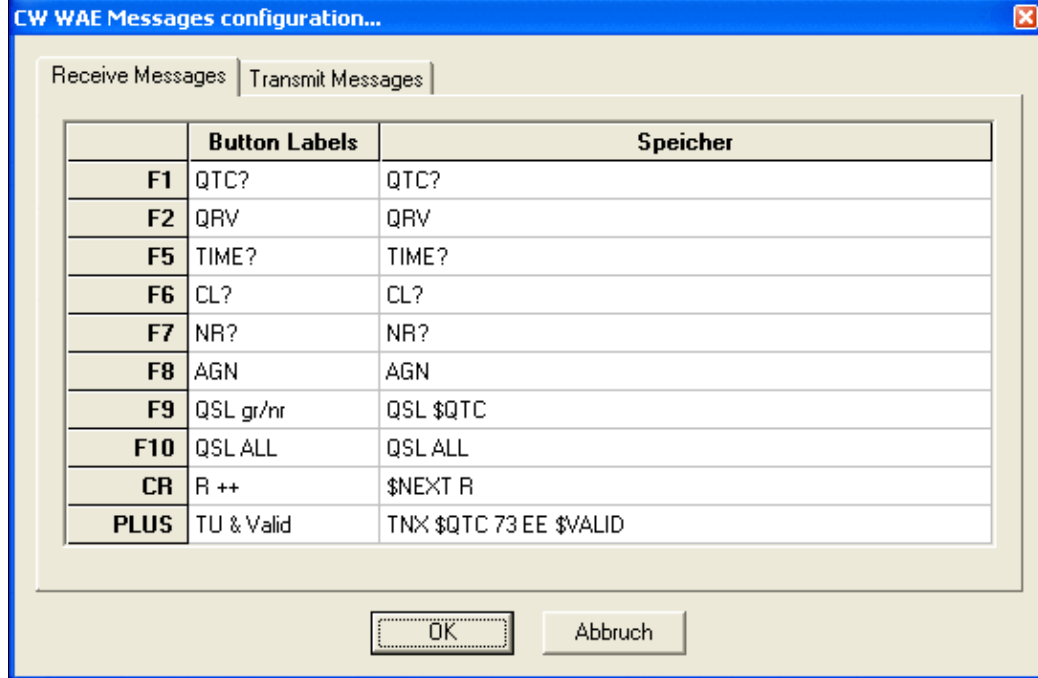

Additional messages (receive) for QTC handling in the Worked All Europe DX Contest.

### Custom variables...

Options | CW | Custom variables...

For quick access to this dialog, use the text command **VARIABLES**.

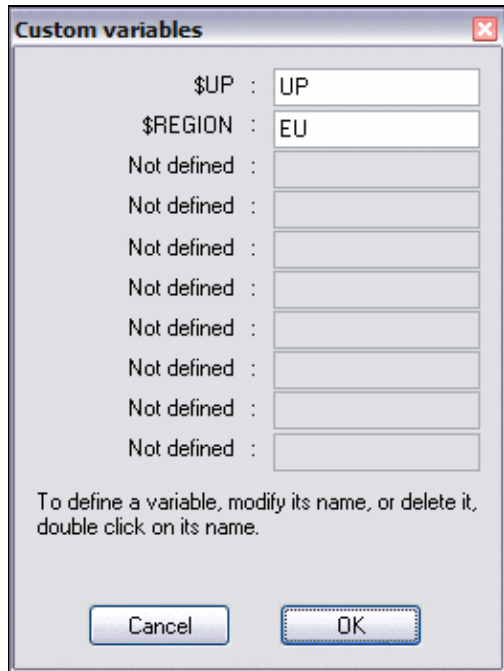

Custom message variables for DXpeditions or other purposes

Mainly useful for DXpeditions, this feature allows you to create custom variables to be used in CW or RTTY messages.

To define a new variable, double-click on the variable name or the words **Not defined**, and follow the prompts. All variables can be used in CW or RTTY messages, (one common set of custom variables is used regardless of mode).

For example, define [Plus] as

```
$CORRECT TU $MYCALL $REGION$UP $CR
```

then change the value of \$REGION as required by typing REGION [Enter] in the callsign field of the main logging window and following the prompts.

To rename a message variable, double-click on its name, and follow the prompts. To delete a message variable, rename it to an empty string.

**WARNING:** Don't try to add a variable name that is already used by Win-Test or it won't work.

## Serial number

Options | CW | Serial number

Equivalent text commands are **LZ**, **NOLZ**, **NOABBREV**, **SEMIABBREV**, **FULLABBREV** and **PROABBREV**.

**Leading zeros** - If checked, leading zeros for all serial numbers below 100 will be sent by Win-Test (text commands **LZ** and **NOLZ**)

**Spaced Digits** - When enabled, a half-space (^) is inserted between each digit of the serial, making it more readable at high speed.

There are 5 possible abbreviation levels for the serial numbers:

- **Not abbreviated** - all numbers are sent without any abbreviations or "cut numbers" (**NOABBREV**)
- **Half abbreviated** - only leading zeros are shortened to "T" (**SEMIABBREV**)
- **Abbreviated** - The 0 and the 9 are shortened to "T" and "N" (**FULLABBREV**)
- **Pro** - The 0, 1, 4, 5 and 9 are shortened to "T", "A", "V", "E" and "N" (**PROABBREV**)
- **Custom** - use the settings in the custom table. Each number can be shortened to a letter of your own choosing.

**Custom table...** - displays the dialog shown below:

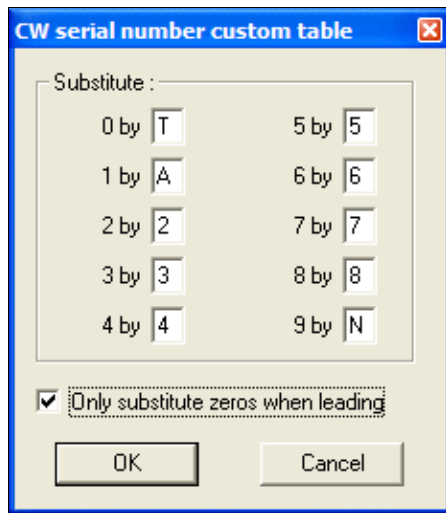

Customized abbreviations for sending CW serial numbers sent by Win-Test. 0, 1, and 9 are shortened to "T", "A", and "N", but only leading zeros are abbreviated.

This option only affects *serial numbers*, not numbers within callsigns.

## Correction

Options | CW | Correction

Equivalent to the [text commands](#) **CORRECT** and **NOCORRECT**.

Controls the value of the [\\$CORRECT message variable](#). When enabled, Win-Test automatically sends a call correction if the callsign sent ([\\$LOGGEDCALL](#)) by the [Ins] key is changed before you press [+] to log the QSO. This is most useful when the [+] key is programmed with **\$CORRECT TU \$MYCALL \$CR** or similar. **NOCORRECT** disables the feature.

When "Smart correction" is enabled ([text command](#): **SMART**), Win-Test resends only what needs to be sent (prefix, suffix, or full call). When disabled (**NOSMART**), Win-Test sends the full callsign for all corrections .

## Shortened spaces (CT spaces)

Options | CW | Shortened spaces (CT spaces)

Equivalent to the [text commands](#) **CTSPACE** and **NOCTSPACE**.

The standard spacing between CW words is 7 dits length, instead of 6 (known as "CT space"). With this option you can set it back to 6 dits if you want, achieving slightly shorter spacing between words.

## Auto sending...

Options | CW | Auto sending...

Equivalent to the [text commands](#) **CWAUTO**, **NOCWAUTO/CWAUTOOFF**, **CWAUTO3**, and **CWAUTO4**

This lets Win-Test automatically send the [Insert] message as soon as some number of characters are entered in the callsign field, eliminating the need to press the [Ins] key to send an exchange.

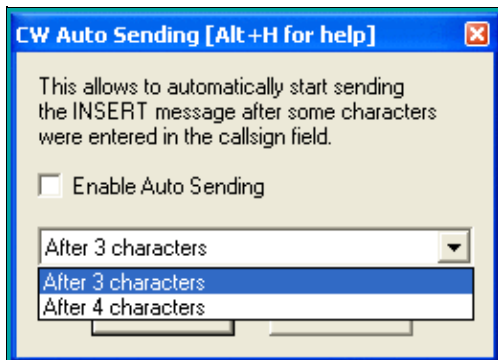

### Configuring Auto sending

When CW Auto Sending is enabled, if the cursor is in the callsign field, hitting **[Escape]** will disable Auto Sending for the current QSO if no CW is being transmitted. When you hit **[Escape]** during transmit, or when the cursor is not in the callsign field, it stops the current CW transmission, but does not disable the CW Auto Sending setting.

Detail: If there is a slash character in the callsign, the triggering starts after the slash.

## Remap keys in keyboard mode

Options | CW | Remap keys in keyboard mode

If you have remapped certain keys using the [Redefine keyboard keys](#) dialog or the **DEFINEKEYS** text command, these mappings are ignored when in [keyboard mode](#) **[Alt-K]**. So for example, if you have redefined the backslash key **[\]** to send your callsign, or the semicolon key **[ ; ]** as an alternative to the plus key **[+]**, those keys will not work the same when you are in keyboard mode. Check this option to have these remapped keys work consistently, whether you are in keyboard mode or not.

## Work dupes

Options | CW | Work dupes

CW and RTTY option to work dupes or not. If dupes are worked, the \$QSOB4 variable is ignored. The equivalent text commands are **WORKDUPE/NOWORKDUPE** or **WORKDUPEON/WORKDUPEOFF**. There is a different setting available per mode (CW or RTTY).

## Speed bursts

Options | CW | Speed bursts

CW option to enable/disable the speed bursts (+/-) without modifying the messages. Text commands are **BURSTS/NOBURSTS**. Useful to defeat CW skimmers on-demand.

## RTTY

Options | RTTY

This menu item allows you to setup the standard and additional messages for RTTY operation. It is enabled only when the selected operating mode is RTTY. (otherwise it is greyed out)

## Modify standard messages...

Options | RTTY | Modify standard messages...  
 The place to change the RTTY messages.

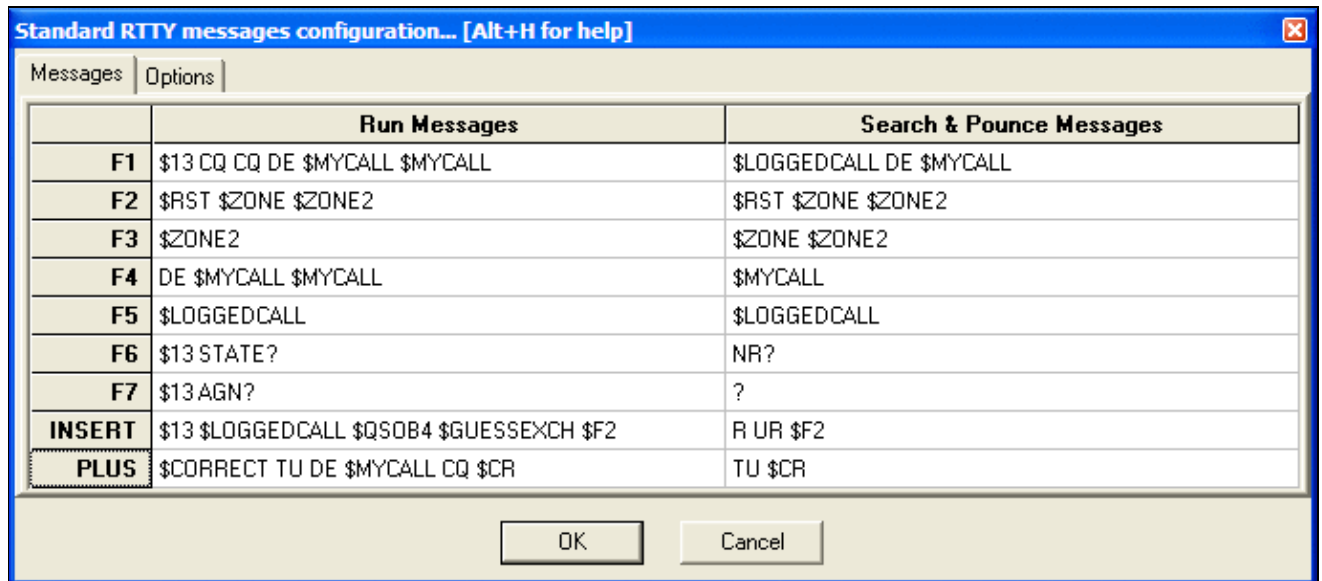

Modifying RTTY standard messages; you may also edit them one by one using **Shift+F1**, **Shift+F2** etc. Please have a look at the list of [Message Variables](#) you can use in the RTTY memories to control different aspects of the operation.

The Options tab of this window lets you redefine the \$QSOB4 macro. The only variable that can be used in this field is \$MYCALL, e.g. "QSO QRZ \$MYCALL".

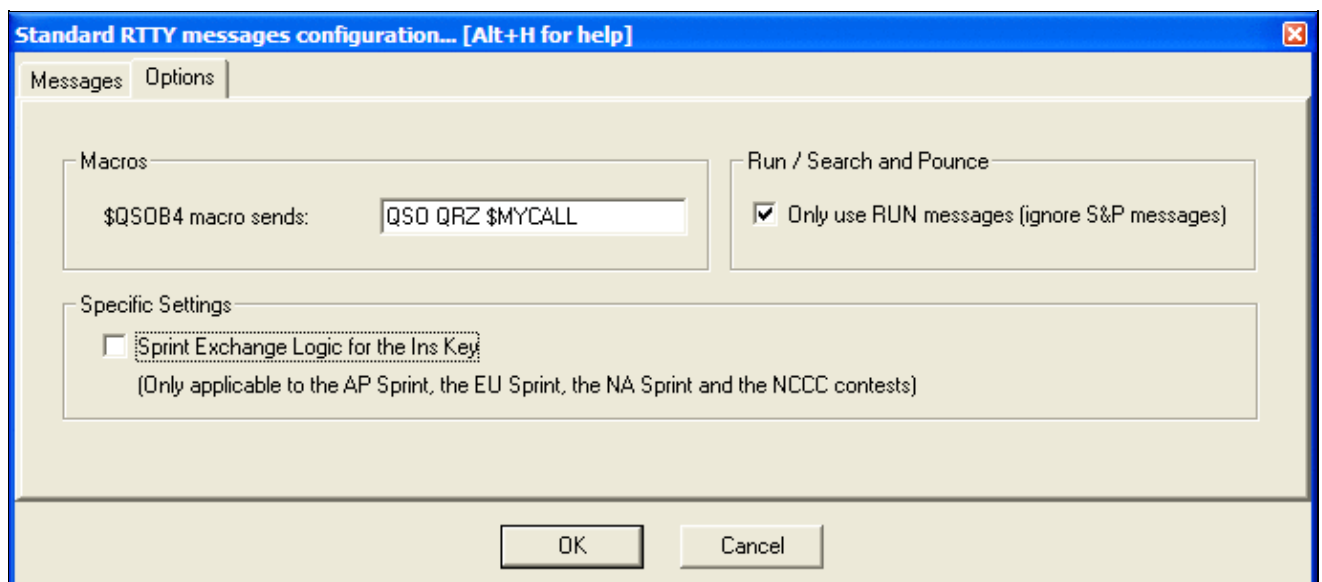

RTTY messages options.

Check **Only use RUN Messages (ignore S&P Messages)** to force Win-Test to use only one set of RTTY messages, regardless of operating mode.

## Modify additional messages...

Options | RTTY | Modify additional messages...

The place to create or modify additional RTTY messages which can be accessed using **Alt-C**. These memories can be used for transmitting QSL information, special greetings, QSY/sked information, ...

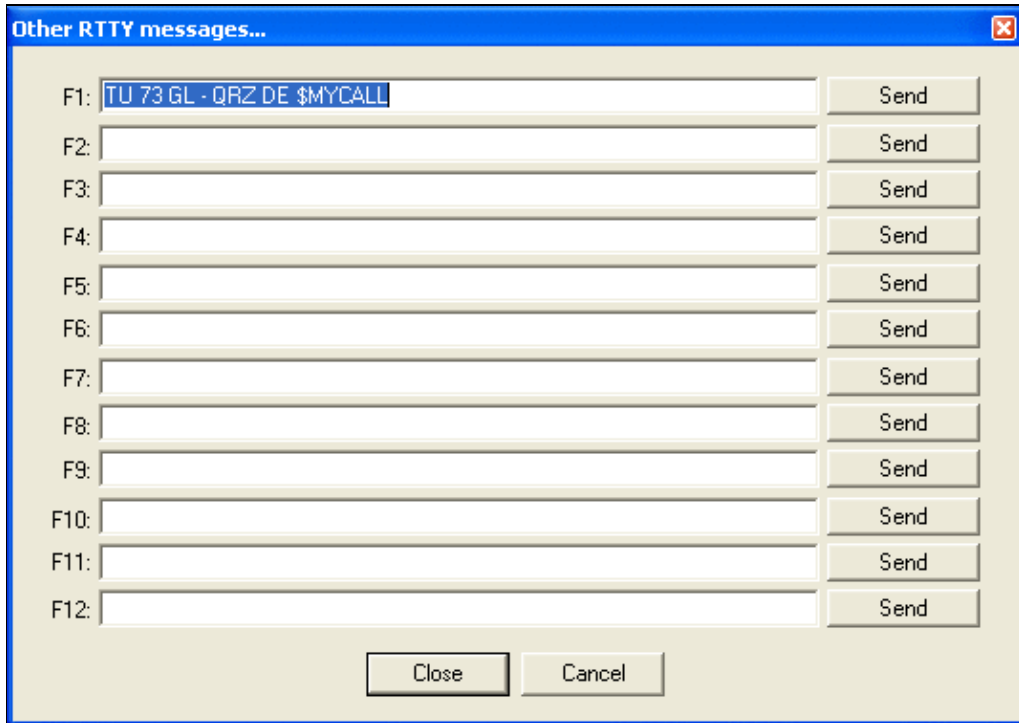

Additional RTTY messages that may be used occasionally like QSL info, greetings, etc. [Message Variables](#) can also be used within these additional messages.

## Modify WAE messages...

Options | RTTY | Modify WAE messages...

This function allows you to define RTTY message texts which are available during transmit/receive of QTC traffic. The QTC window is specific to the WAE DX Contest and can be opened using **Ctrl-L** (transmit QTCs) or **Alt-L** (receive QTCs). For more details of WAEDC, please see [WAEDC](#).

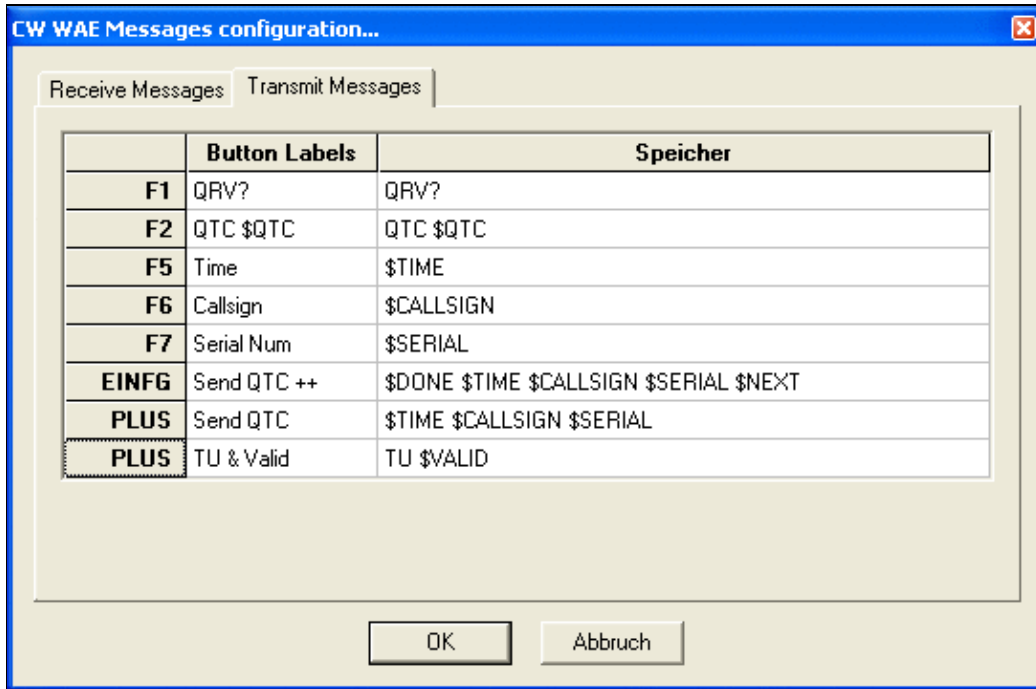

Additional messages (transmit) for QTC handling in the Worked All Europe DX Contest.

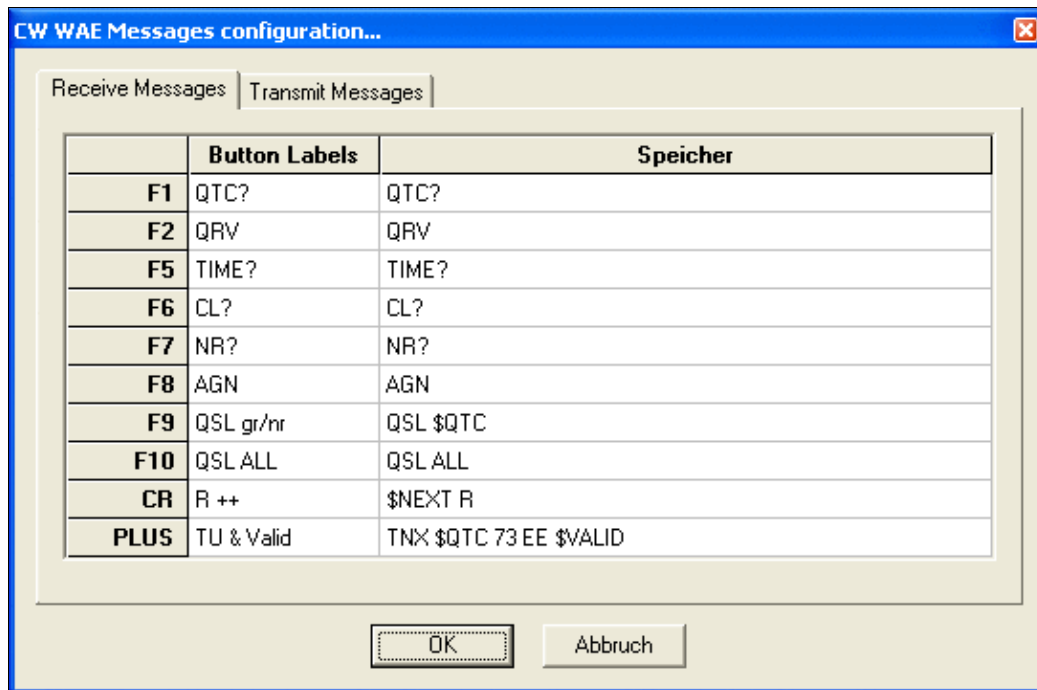

Additional messages (receive) for QTC handling in the Worked All Europe DX Contest.

## Custom variables...

Options | RTTY | Custom variables...

For quick access to this dialog, use the text command **VARIABLES**.

See Options | CW | Custom variables...

## Configure interfaces...

Options | Configure interfaces...

For quick access to this dialog, use the text command **SETUP**.

All the interfaces you wish to use with Win-Test can be parametered by using this dialog box.



**Interfaces configuration...**

**Serial ports**

<input type="checkbox"/>	COM1	Network	19200 8-N-1	Configure...
<input type="checkbox"/>	COM2	Network	19200 8-N-1	Configure...
<input type="checkbox"/>	COM3	Network	9600 8-N-1	Configure...
<input type="checkbox"/>	COM4	Network	19200 8-N-1	Configure...
<input checked="" type="checkbox"/>	COM5	Radio 1	4800 8-N-1	Configure...
<input checked="" type="checkbox"/>	COM6	Other interface...	9600 8-N-1 CW PTT	Configure...
<input type="checkbox"/>	COM7	Network	19200 8-N-1	Configure...
<input type="checkbox"/>	COM8	Network	19200 8-N-1	Configure...
<input type="checkbox"/>	COM9	Network	19200 8-N-1	Configure...
<input type="checkbox"/>	COM10	Network	19200 8-N-1	Configure...
<input type="checkbox"/>	COM11	Network	19200 8-N-1	Configure...
<input type="checkbox"/>	COM12	Network	19200 8-N-1	Configure...

**Printer ports**

LPT Configure...

**CW**

PTT ON delay (ms):

**Ethernet**

Enable ethernet network

Broadcast address:  By default

Port number:  By default

**Network protocol**

Advanced settings...

**Voice keyer**

Enable sound card

▼

Mute the microphone input when the DVK is playing

Mute the microphone input when the DVK is not playing

**Transceivers**

Radio 1:  ▼  Don't poll  Use CI-V Transceive Polling rate (ms):  ▼

Radio 2:  ▼  Don't poll  Use CI-V Transceive Polling rate (ms):  ▼

OK Cancel

## Interface Configuration

**Serial Ports**

The serial ports can be used for an RS-232 network (rarely used now), for a connection to a packet radio controller (also rarely used), for CW or PTT on/off keying output, for headphone audio control, for SO2R active radio control, or for an RS-232 (serial) radio, amplifier, SO2R box, or Winkey interface.

If using a radio or amplifier interface, you must first specify what model you are using. Press the **Default Settings** button to configure all serial port settings to the standard defaults for the selected radio model or Winkey (highly recommended).

If using an SO2R box, you can control it via serial commands (device type = microHAM, EZMaster, or OTRSP), or you can set the device type to "Other device" and use on/off activation of the DTR and RTS pins to control the SO2R box via "Classic Auto Control" hardware instead of via software commands.

Use the serial port configuration dialog to select the appropriate settings:

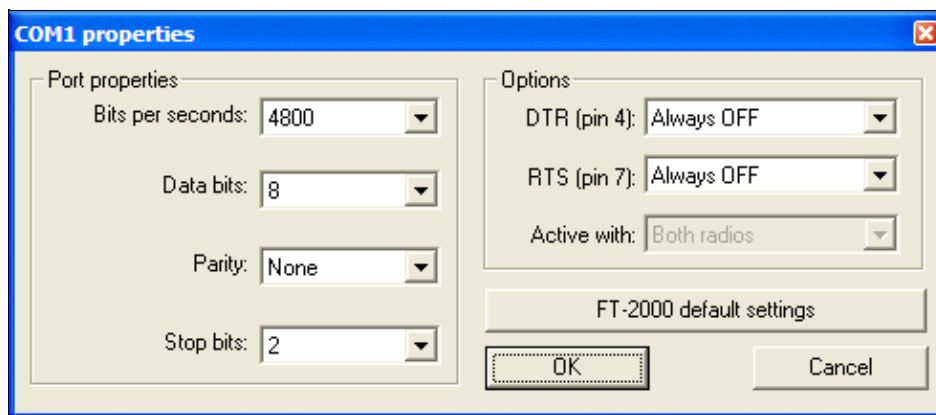

## Serial port configuration

The **DTR** (pin 4) and **RTS** (pin 7) options are:

- Handshake - RS-232 hardware handshake, supported by some radios
- CW - For on/off CW keying of Radio 1, Radio 2, or both, similar to LPT port CW keying. The convention is to use for DTR for CW and RTS (optionally) for PTT.
- PTT - For activating PTT on Radio 1, Radio 2, or both, when a CW or internal DVK message is sent.
- Always ON - Pin is always set "high" (required by some USB-to-Serial adapters and radios)
- Always OFF - Pin is always set "low"
- Active radio - Pin is connected to an SO2R box "Swap TX radio" line.
- Stereo RX Audio - Pin is connected to an SO2R box "Stereo on/off" line.
- Headphone control - Pin is connected to an SO2R box "Swap RX radio" line.

The **Active with** option is only available when PTT or CW is selected for DTR or RTS, otherwise it is grayed out.

- Radio 1 - PTT and CW is only sent when Radio 1 is active
- Radio 2 - PTT and CW is only sent when Radio 2 is active
- Both radios - PTT and CW is sent when either radio is active (external steering via SO2R box required)

**Note:** The pin numbering applies to a standard DB9 connector.

## Transceivers

This region of the interfaces configuration window lets you select the type of transceiver for radio 1 and 2 plus various settings like polling, polling rate (actually, delay before polling the radio again after the previous sequence) and if the ICOM specific CI-V feature is to be used or not. By the way, when you use an ICOM radio with an address different from factory settings, please see [WT.INI](#)

## Printer Ports

A parallel port can be used to send CW and other signals from Win-Test via [legacy keying interfaces](#), or the microHAM MK2R/MK2R+ operating in "Classic Auto Control" mode. Press [**Configure . . .**] to display the following dialog box:

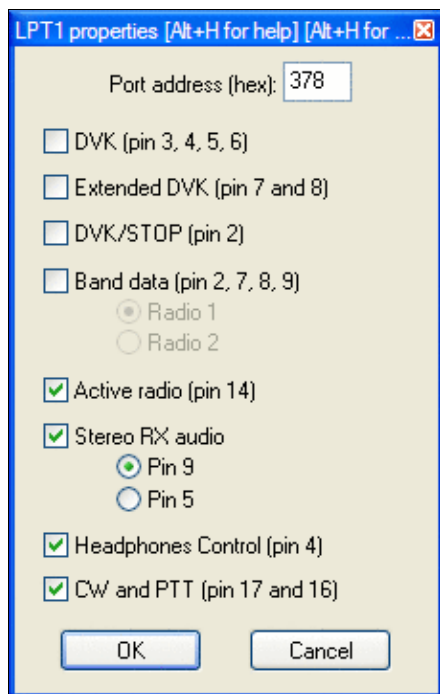

Parallel port configuration showing pin 14 used for TX Radio, Pin 9 for Stereo On/Off, and Pin 4 for RX Radio, Pin 17 for CW, and Pin 16 for PTT

Specify the address of your printer port in hex. Common values are **378** and **3BC**. To determine the address used by your printer port, open the Windows Device Manager (Start, Control Panel, System, Hardware tab, Device Manager; or Start, Run, **devmgmt.msc**). Select Ports (COM & LPT), Printer Port (LPT1), Right Click, Properties, and finally, click the Resources Tab. You will see **I/O range 0378 - 037A** or similar. Use the first address as your port address. If you do not specify the correct port address, Win-Test will appear to operate normally, but it will not key the radio at all.

## CW

**PTT ON Delay** specifies the time delay between first PTT closure and first CW output. When using an amplifier with a slow relay, this setting allows you to close the relay line well before RF is applied, which prevents the first dot or dash sent by Win-Test from being truncated. The delay between the PTT command and the effective CW transmission is adjustable between 0 (for QSK amps) to 1000 ms.

## Local Network

The Local Network interface is used to define Win-Test's local area network in a multi-operating environment. If needed, you can change the broadcast address and the port number used. If you ignore the meaning of these terms, note that there should normally be no need to modify the default values given by Win-Test. See [Networking](#) for more information.

## Network Protocol Advanced Settings

Under the Network Protocol Advanced Settings dialog you will find a way to restrict network traffic in very specific ways. **CAUTION:** Modifications to the default settings must be done with extreme care. It is intended for very particular configurations and purposes, mainly used by expert users. You are on your own!

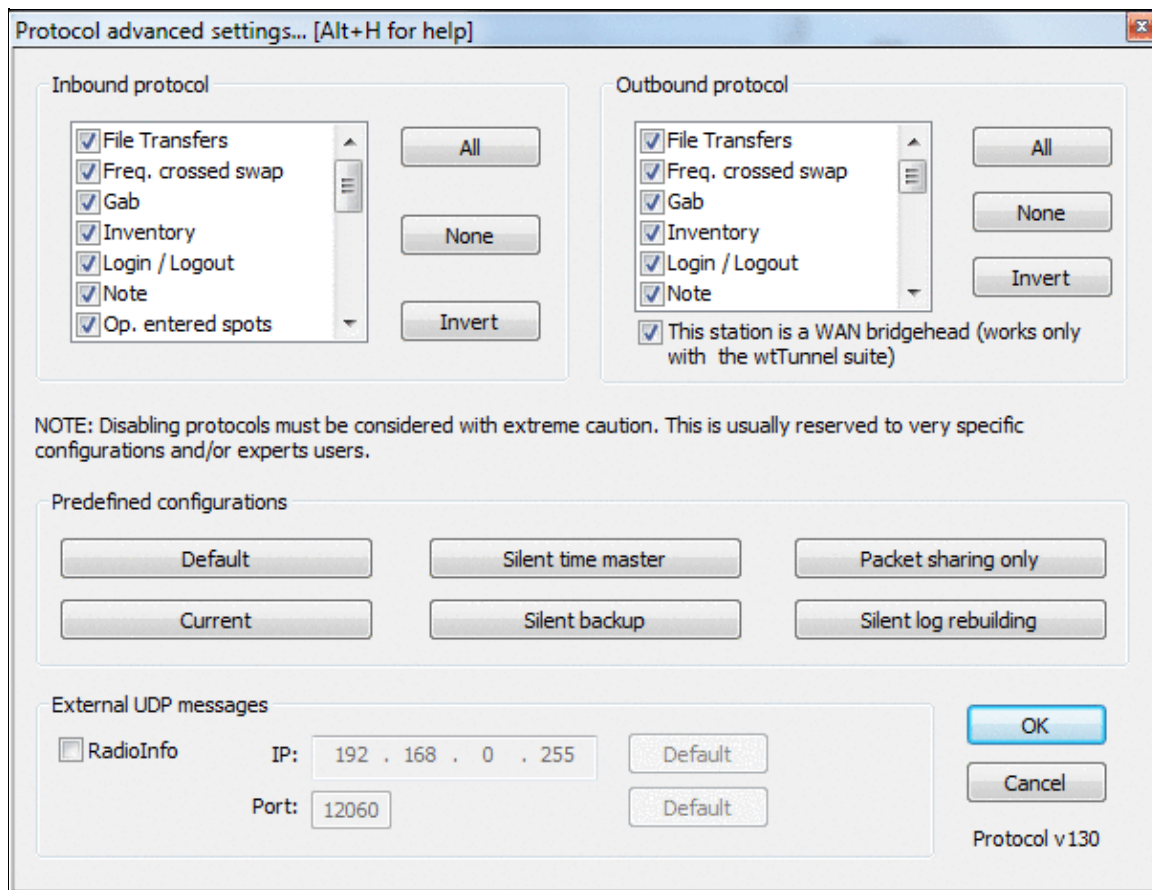

Network Protocol Advanced Settings allows you to fine-tune your network traffic. Network protocol version displayed in the right bottom corner.

Some pre-set typical configurations are available:

- **Silent time master:** Can be used if the computer is used *only* to distribute an accurate clock. This PC will not appear in the status window of any other networked computer. Note that with this setting, no QSOs will be recorded on (or sent from) any machine with this setting.
- **Silent backup:** Can be used if the computer is *only* used for backup purposes. This PC will not appear in the status window of any other networked computer.
- **Packet sharing only:** Can be used if stations are networked with different callsigns, and do not want a common log, but do want to share a common packet stream. It can be used for several co-located single-op stations on VHF/UHF, for example.
- **Silent log rebuilding:** Can be used if you need to rebuild from scratch a complete log from networked stations, without appearing in the status window of any other networked computer.

Note that in all settings, the station will still be visible in the network via the **INVENTORY** command.

[x] This station is a WAN bridgehead

This feature only works with the wtTunnel suite. To respect multi-op ethics, the wtTunnel package is *only* available for headquarters stations during the IARU HF contest. Check this box to restrict the synchronization

of QSO inventories to the local network to reduce network traffic when stations are at different sites on a wide area network (WAN).

See [The Bridgehead Concept](#) for further details.

To control external interfaces by UDP, Outbound RadioInfo external UDP messages capability was added, to allow using additional programs or devices. Already tested with the RF2K-S SSPA (see <https://www.rf-kit.de>).

## Voice Keyer

At last, if your computer has an embedded sound card, you can select and use it as a digital voice keyer by checking the appropriate box.

If you want to use a third-party software to record or modify voice messages, be sure to use the following file format : WAV, PCM, 8000 Hz sampling frequency, 1 channel (mono) and 16 bits per sample.

## WinKey configuration...

Options | Winkey configuration...

For quick access to this dialog, use the [text command](#) **WKSETUP**.

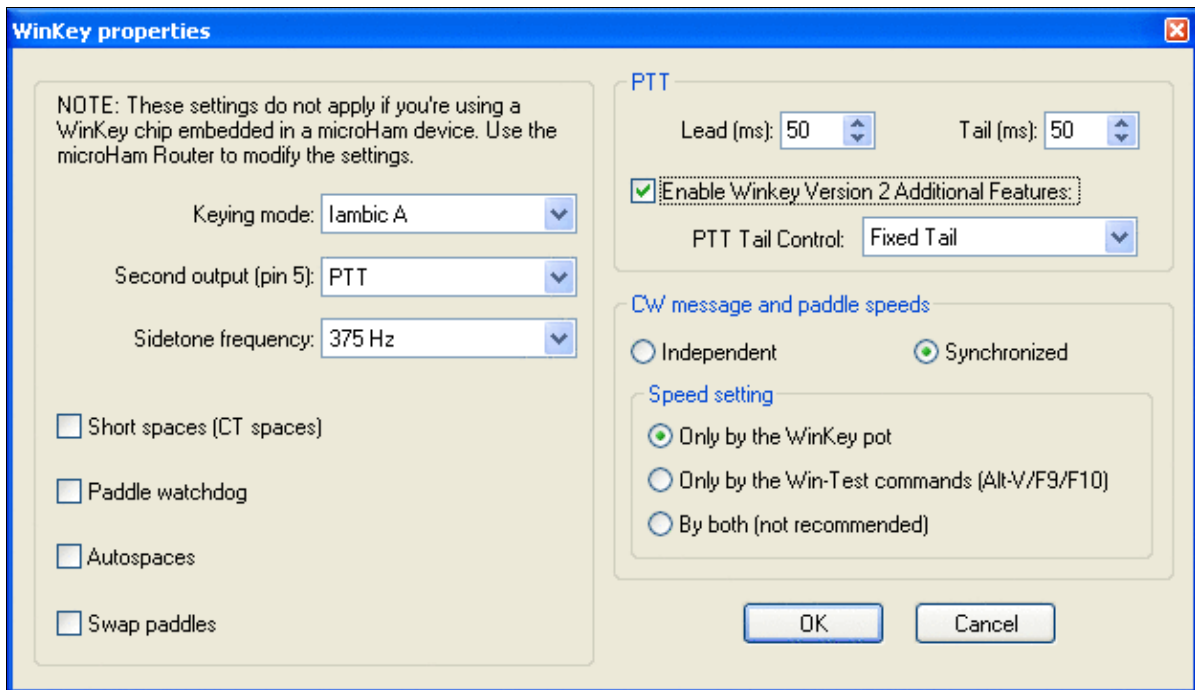

## Configuring the WinKey properties

- **Keying mode:**
  - ◆ **Iambic A** - Curtis A iambic timing
  - ◆ **Iambic B** - Curtis B iambic timing
  - ◆ **Ultimatic** - Non iambic mode
  - ◆ **Bug (semi-automatic)** - WinKey makes the dits and you make the dahs

In either iambic mode, alternating dits and dahs are sent while both paddles are held closed. In mode B, an extra alternate dit or dah is sent after both paddles are released. In Ultimatic mode, when both paddles are pressed, the keyer will send a continuous stream of whichever paddle was last pressed.

- **Second Output (pin 5)** (WinKey only, ignored by WinKey2 chip)
  - ◆ **PTT** - WinKey pin 5 acts as a PTT line
  - ◆ **Sidetone frequency** - WinKey pin 5 acts as a sidetone output
  - ◆ **Radio 2** - WinKey pin 5 keys a second radio
- **Sidetone Frequency** - sets WinKey oscillator sidetone on pin 5 (ignored by WinKey2 chip)
- **Short spaces (CT spaces)** - WinKey generates a 6-baud word space instead of a 7-baud space (1 baud = length of one dit)
- **Paddle watchdog** - disable the key output after 128 consecutive dits or dahs. This is to guard against the paddles being accidentally keyed continuously by your cat.
- **Autospaces** - If you pause for more than one dit time between a dit or dah, Winkey will interpret this as a letter-space and will not send the next dit or dah until a full letter-space time (3 dits) has passed
- **Swap paddles** - reverse the dit/dah paddles (e.g. for keying with the left hand)
- **PTT**
  - ◆ **PTT Lead(ms)** specify PTT lead (switch to transmit before CW begins)
  - ◆ **PTT Tail(ms)** specify PTT tail (keep transmitter up after CW has finished)
  - ◆ V2 of WinKey provides additional features:
    - ◇ PTT tail control (fixed, 1.00 letter space, 1.33, 1.66, 2.00)
- **CW Message and paddle speeds**
  - ◆ **Independent** - CW speed sent by the paddle is controlled by the WinKey speed knob, and CW speed set by Win-Test is controlled independently by the Win-Test keyboard commands (**[Alt-F9]**, **[Alt-F10]**, and **[Alt-V]**). In addition, both CW speeds will be displayed at the bottom of the Rate Window.
  - ◆ **Synchronized** - Win-Test will keep the CW speed synchronized, whether sent by paddles or by Win-Test
    - ◇ **Only by WinKey pot** - Only the WinKey speed knob will control CW speed; Win-Test speed commands sent via the keyboard are ignored.
    - ◇ **Only by the Win-Test commands (Alt-V/F9/F10)** - The WinKey speed knob is ignored and CW speed changes may only be controlled by the Win-Test keyboard commands (**[Alt-F9]**, **[Alt-F10]**, and **[Alt-V]**).
    - ◇ **By both (not recommended)** - CW speed may be controlled by either the WinKey speed knob or by Win-Test keyboard commands, but this setting is not recommended as there is no way to automatically turn the WinKey speed knob to match the CW speed set by Win-Test.

## EZMaster configuration...

Options | EZMaster configuration...

For quick access to this dialog, use the text command **EZSETUP**.

Advanced SO2R mode and setting up scenarios requires external SO2R control equipment of the last generation, communicating with Win-Test via a USB port.

This menu option enables the user to configure five different option for EZMaster to work with Win-test:

## **CW Keyer**

Internal EZMaster CW Keyer (tick Enable WinKey Box) or Win-Test keyer (do not tick box).

## **Radio set-up**

In the image below find configuration for FT1000MP

## **Packet-Radio TNC**

## **Antenna configuration according to RX/TX**



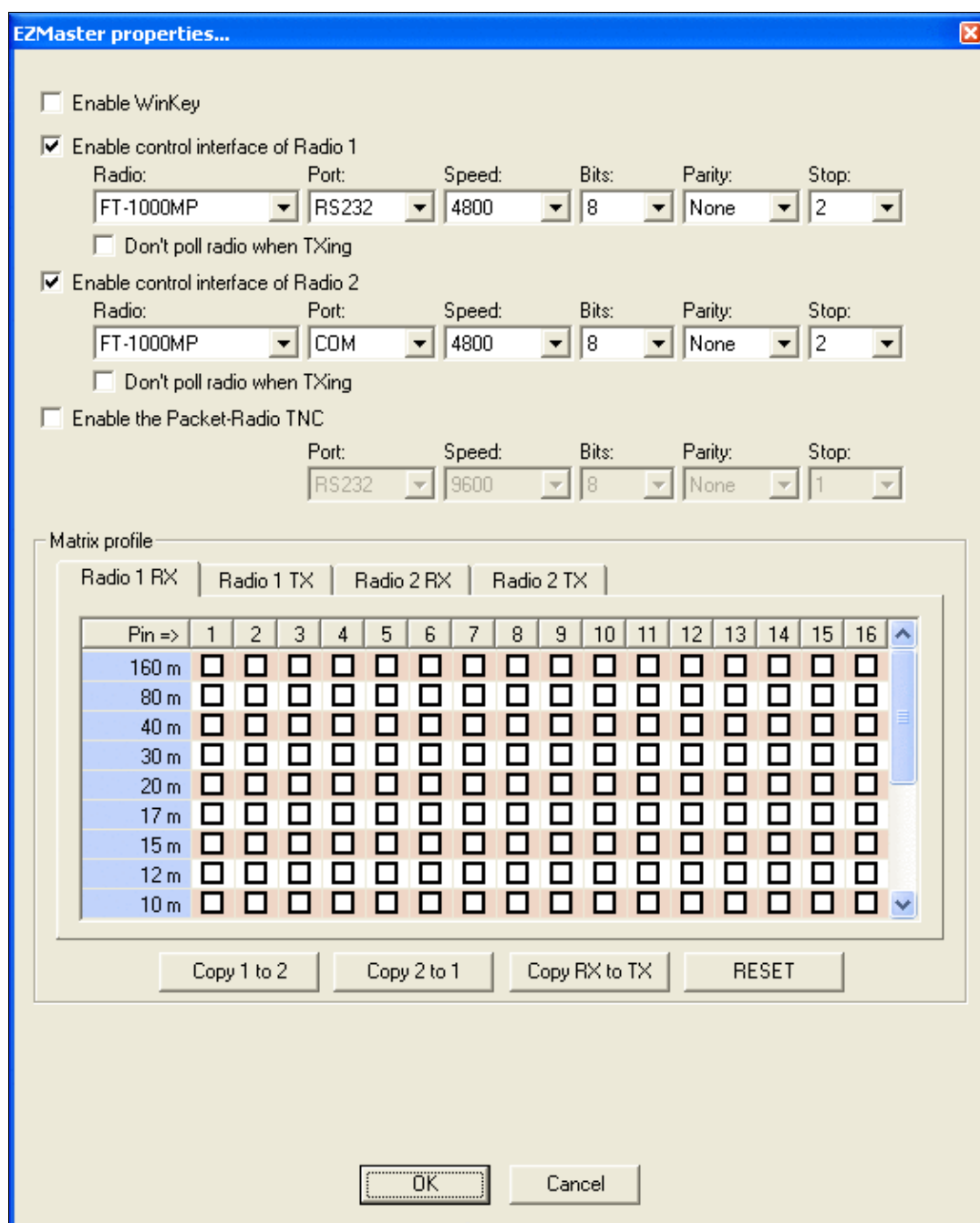

EZMaster configuration window

## MK/MKII/MK2R/u2R configuration...

Options | MK/MKII/MK2R/u2R configuration...

For quick access to this dialog, use the [text command](#) **MKSETUP**.

This option allows you to configure the microHAM devices microHAM Keyer, microHAM Keyer 2 and MK2R SO2R device. It lets you select if the microHAM protocol should be used for communication with the device. Moreover, you can specify, which pins on the ACC connected of the device will be activated, when the radio1 or radio 2 is tuned to a specific band.

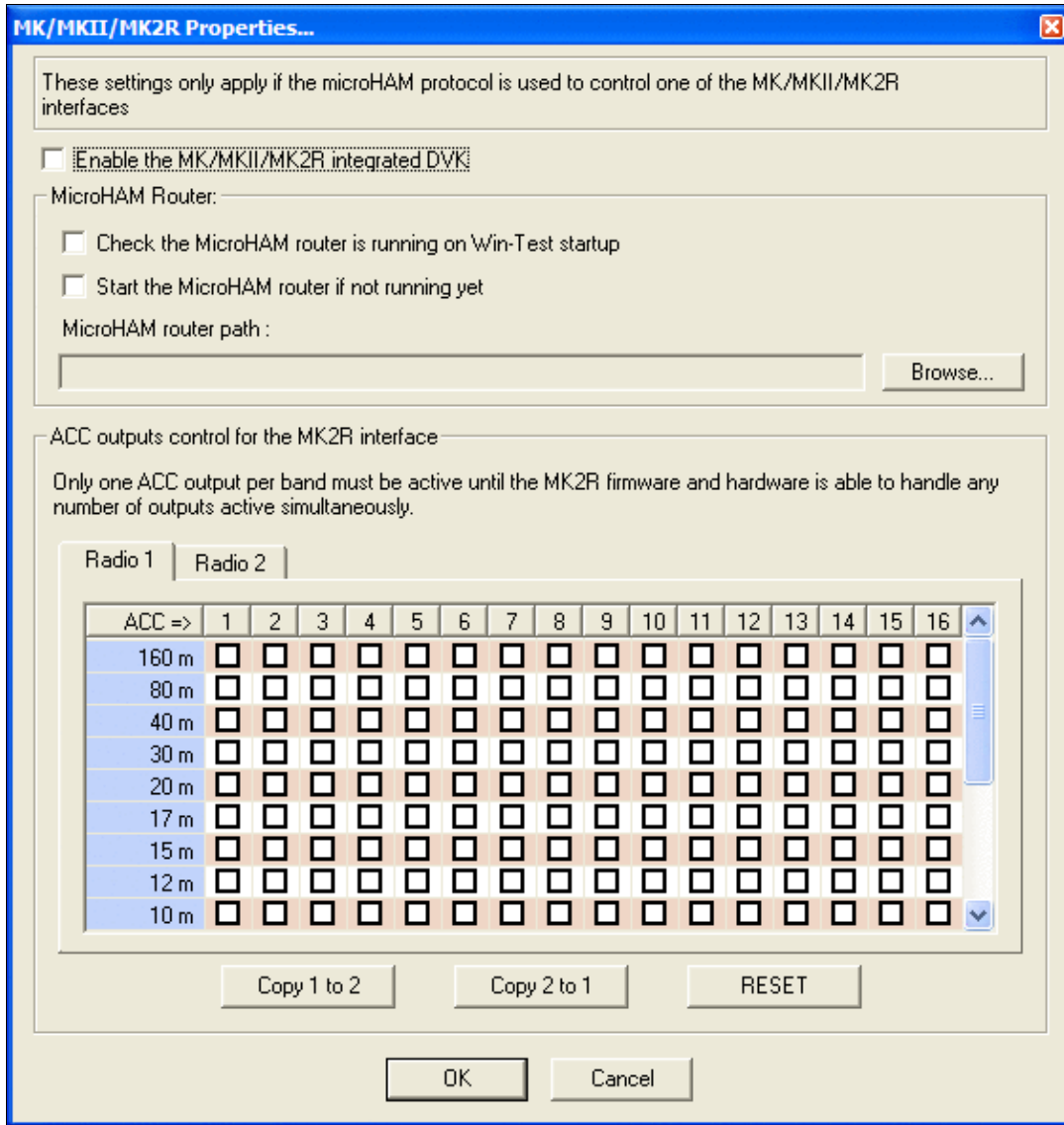

microHAM MK, MKII and MK2R configuration window

When an attached footswitch is used, two dedicated Lua scripts named **onMicrohamFsOn.wts** and **onMicrohamFsOff.wts** (not case-sensitive) are called. **wtArg** is set the radio number of the footswitch (0 for MK/MKII - 0 or 1 for MK2R/MK2R+/u2R depending on the footswitch that generated the event).

## OTRSP configuration...

Options | OTRSP configuration...

This option allows you to set up an Open Two Radio Switching Protocol (OTRSP) compatible device like the YCCC SO2R Box (for more information, visit <http://www.k1xm.org/OTRSP>).

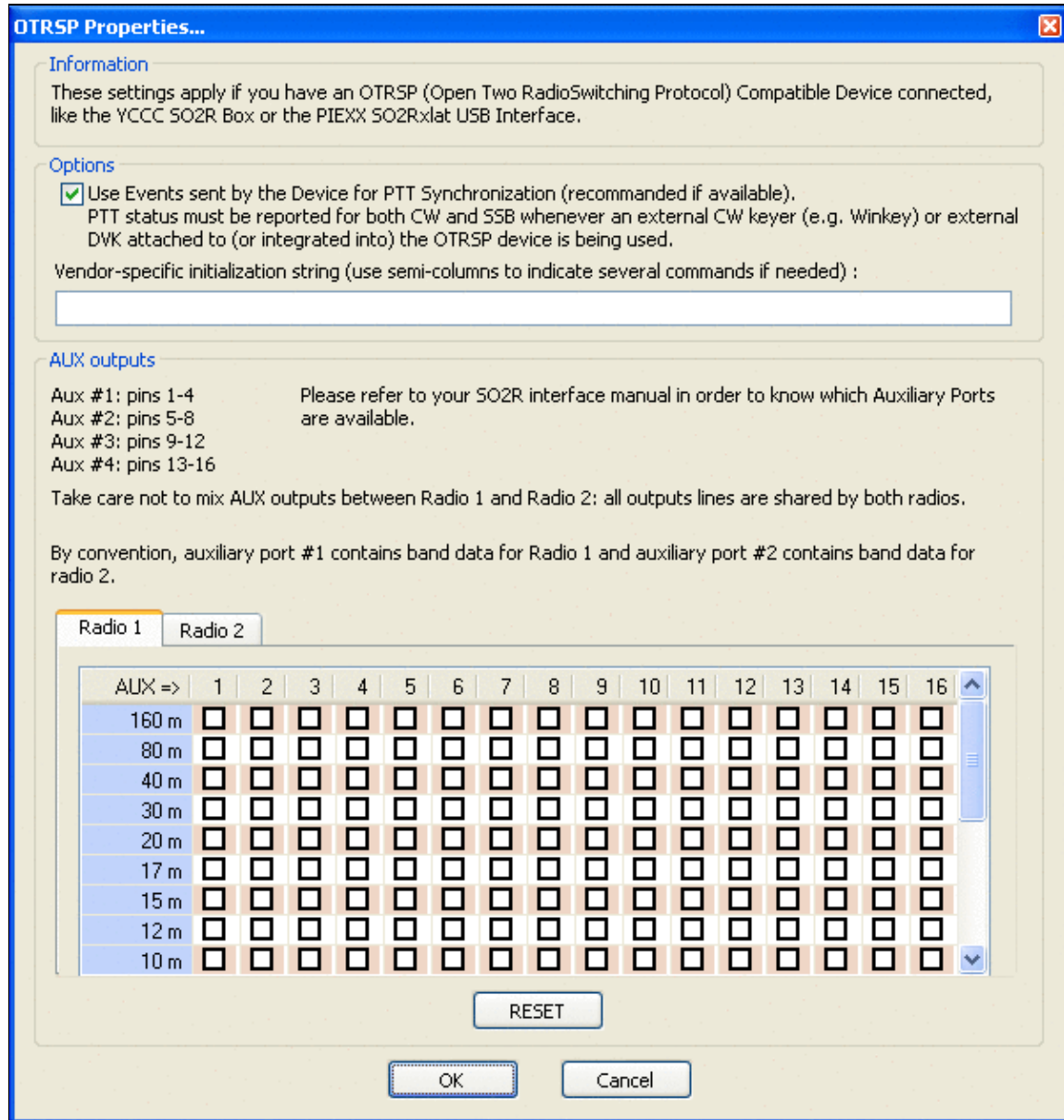

## OTRSP configuration window

If the OTRSP device has controls and if they can generate events, dedicated Lua scripts are called when events occur :

- **onOtrspCrOn.wts** and **onOtrspCrOff.wts** (not case-sensitive) are called when such a control has values 1 and 0 respectively. **wtArg** is set to the control number (0 to 9).
- **onOtrspCrEvent.wts** (not case-sensitive) is called for all states of the events. **wtArg** is set to  $(256 * cr) + state$  ( $cr = control\ number - 1$  to 9, and  $state = value\ of\ the\ state\ when\ the\ event\ occurred - 0$  to 255).

**Note:** If the PTT events are used, the control 0 is restricted to this usage, and doesn't fire the onOtrspCrOn/Off/Event.wts scripts. If the PTT events are not used, onOtrspCrEvent is not called when an event on this control occurs. Only the onOtrspCrOn/Off scripts are executed in this case.

## RTTY configuration...

Options | RTTY configuration...

For quick access to this dialog, use the text command **RTTYSETUP**.

This menu entry opens the control box for RTTY configuration.

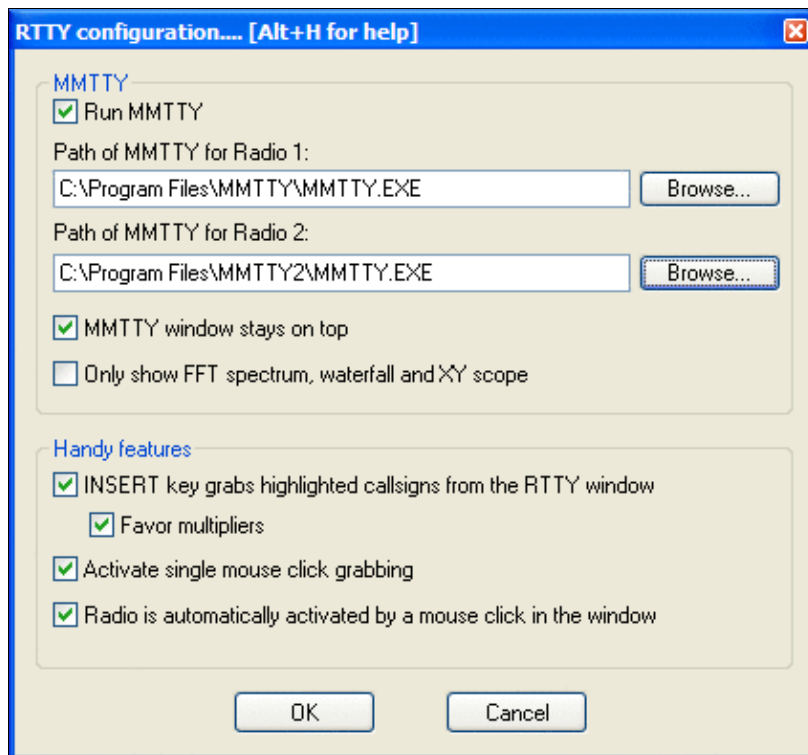

## RTTY Configuration Box

Please refer to the [RTTY chapter](#) for all the details.

## Frequency Offsets

This function is mainly used for a VHF/UHF/SHF setup involving a transverter. An HF radio tuned on 28 MHz is used as the user front-end which drives the transverter for 144 MHz or 432 MHz. Or a 144 MHz transceiver is used to drive a transverter to 5.7 and 10 GHz.

The point is that Win-Test only sees the frequency of the front-end. For example it would find the radio tuned to 28 MHz and simply ignore its frequency read-out when set up for a VHF/UHF contest. Likewise, the radio would ignore commands to tune to 144.054 from Win-Test because it is a HF transceiver that only knows 1.8-30 MHz. This is where the frequency offset feature comes in handy. It allows you to specify a frequency (in kHz) that will be added to any frequency read from the radio and subtracted from any frequency command that goes to the radio.

In other words, assume the frequency offset is set at 116000 kHz. The radio is tuned to 28054 kHz. Now Win-Test "sees" the radio at 144054 kHz, because the offset is added. Likewise, when the user clicks on a packet spot on 144088, Win-Test sends the radio to 28088 because the offset is subtracted.

This way, Win-Test gives you great flexibility to enter one offset per band per radio.

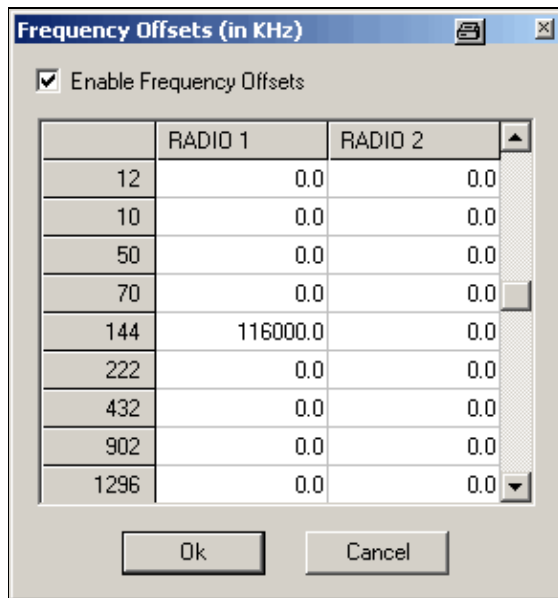

Frequency Offset allows you to use a transverter with Win-Test  
Text commands **OFFSETSETUP** (or **OFFSETSSETUP**) to open the dialog and. **OFFSET/NOOFFSET**, **OFFSETS/NOOFFSETS**, **OFFSETON/OFFSETOFF**, **OFFSETSON/OFFSETSOFF** to enable/disable the frequency offset.

## MP3 Configuration

Options | MP3 Configuration

For quick access to this dialog, use the text command **MP3SETUP**.

Allows you to select the sound device used for recording and playback in use with the contest recorder. You must have installed a MP3 ACM Codec (e.g. LAME, Fraunhofer). The encoder is not part of the Win-Test distribution.

Download LAME from [http://www.free-codecs.com/LAME\\_ACM\\_Codec\\_download.htm](http://www.free-codecs.com/LAME_ACM_Codec_download.htm). The version which worked at the time of this writing was 3.99.5. Follow instructions in the ZIP-File. With WinXP it used to work as described in <http://lists.f5mzn.org/pipermail/support/2010-January/079240.html>.

For Windows 7 and Windows 10, the important point is to run the installation a CMD window explicitly executed as Administrator.

Assuming, you have downloaded and unpacked the LAME ACM version to the directory C:\LAME, the following command will register the codec in Window's Audio Codec Manager:

```
cd %windir%\SysWOW64
rundll32 setupapi.dll,InstallHinfSection DefaultInstall 0 C:\LAME\LameACM.inf
```

For Windows 10 use this command:

```
C:\Windows\SysWOW64\rundll32.exe setupapi.dll,InstallHinfSection DefaultInstall 0 C:\LAME\
```

There may already be an encoder on your system due to other software previously installed, like the Fraunhofer IIS MPEG Layer-3 Codec. The Fraunhofer codec also works perfectly OK with Win-Test.

The default settings (Stereo/32000 Hz sample rate, 96 kBit/s bitrate) will produce a file of about 2 GB in size for an 48h contest.

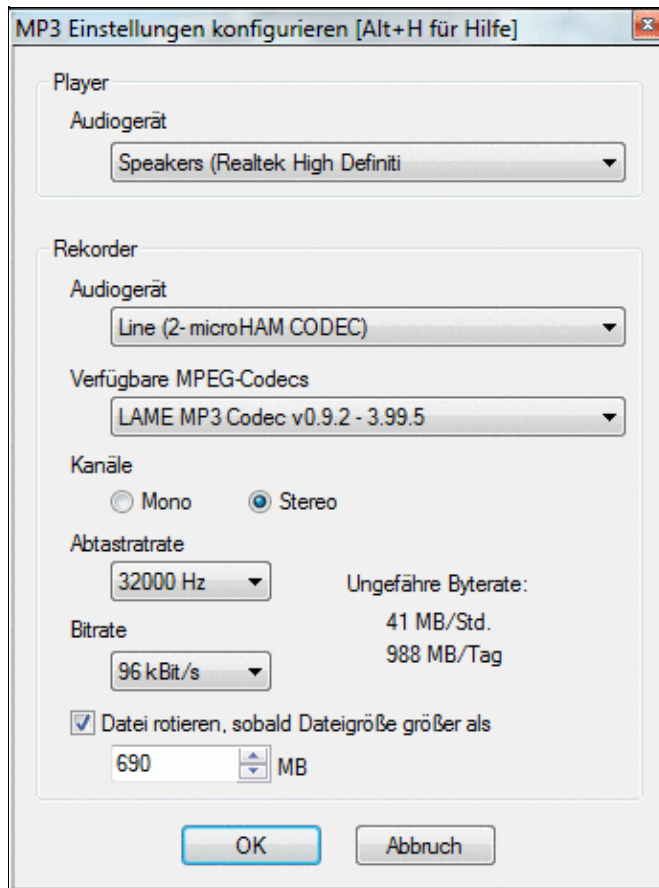

Display options for MP3/Contest Recorder configuration.

To make your MP3 recordings available on the Internet after the contest, see:

<http://lists.f5mzn.org/pipermail/support/2009-December/078951.html>

## Script Editor Configuration

This menu lets you configure the application to start when clicking the Edit button in the Scripts Manager. Basically, every ASCII editor is usable, SciTE is the recommended editor as it provides syntax highlighting.

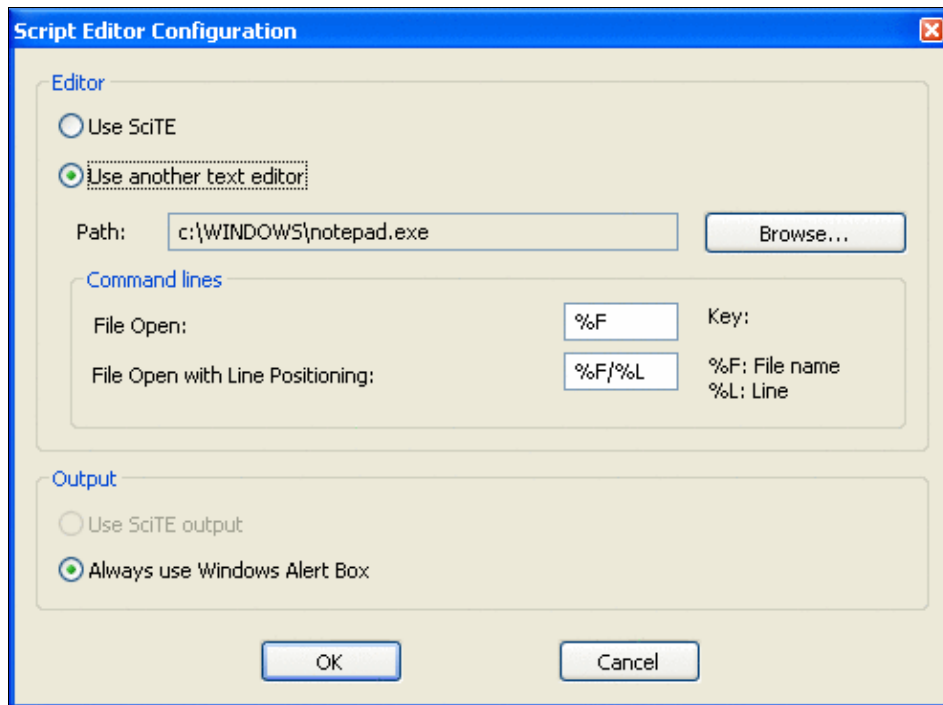

Configure the preferred editor to manage Lua scripts from within Win-Test

## Log

Options | Log

Allows you to change the display of the log entry area (the last 9 QSOs plus the current QSO entry line), including the Win-Test background color. You may select font size, colors, headings and so on.



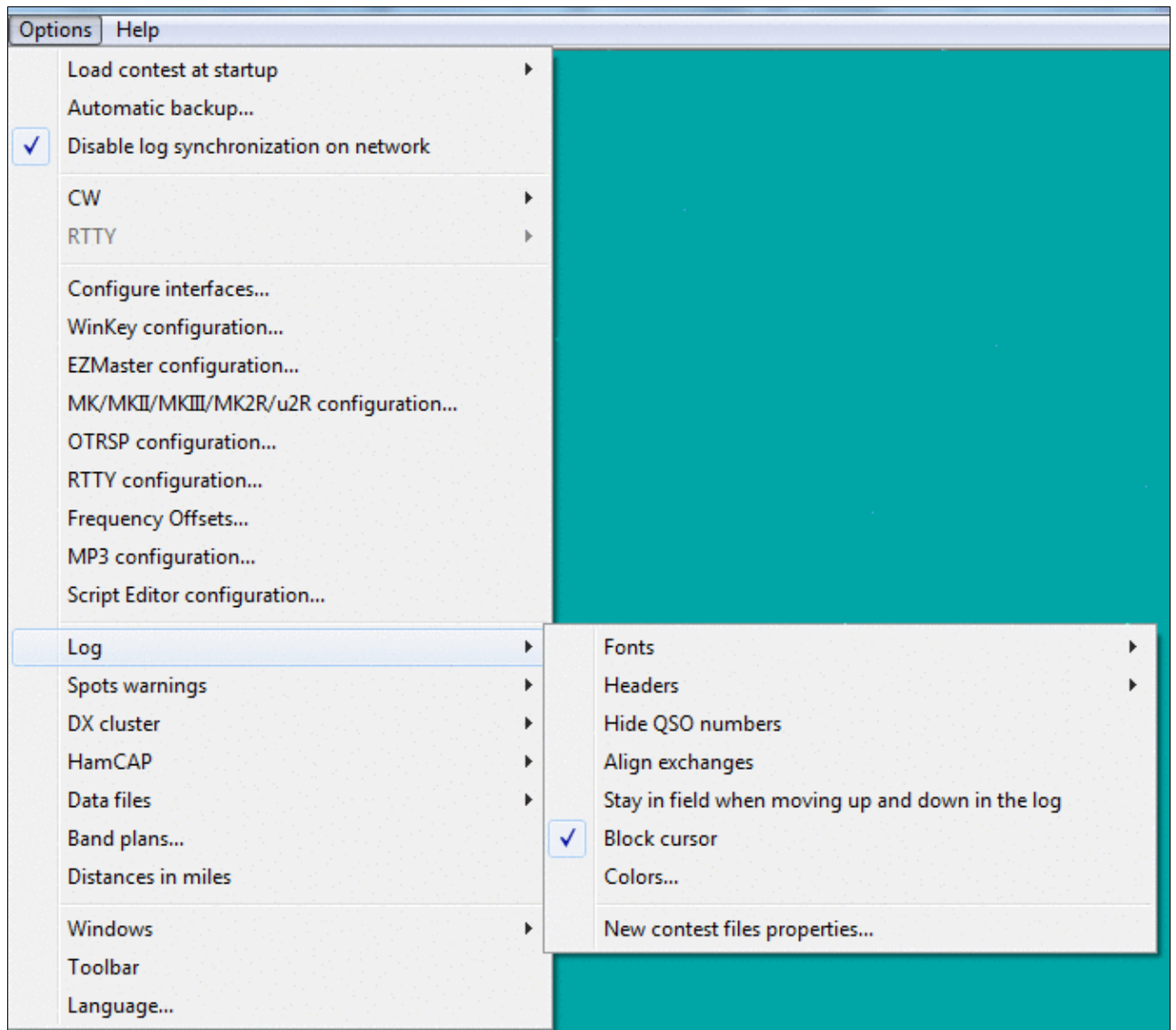

Display options for the log entry area.

## Fonts

Select the text font for the log entry area

## Headers

Controls the display of the column titles in the log entry area. The headers may be hidden, left aligned, or centered

## Hide QSO numbers

Hides the first column in the log entry area, to avoid confusion with the serial number sent, especially for multi-op entrants.

## Align Exchanges

Option to line up received exchanges in mixed mode.

## Stay in field when moving up and down in the log

Select this option to have the cursor move up and down as it would in a spreadsheet. For example, to stay in the report field when pressing the **[Up]** or **[Down]** cursor keys, instead of having the cursor jump to the beginning of the callsign field.

## Block Cursor

Allows you to change the red linking line cursor to a block cursor.

## Colors...

Use this option to change the background color for the entire screen, the color of the logging text, the header text, or the warning message text. Press the **[Factory colors]** button to restore these to the Win-Test default colors.

## New Contest Files Properties

This window lets you define a directory structure and file name template for newly created contest log files. This is a nice feature to keep contest files including MP3 recordings etc. well organised.

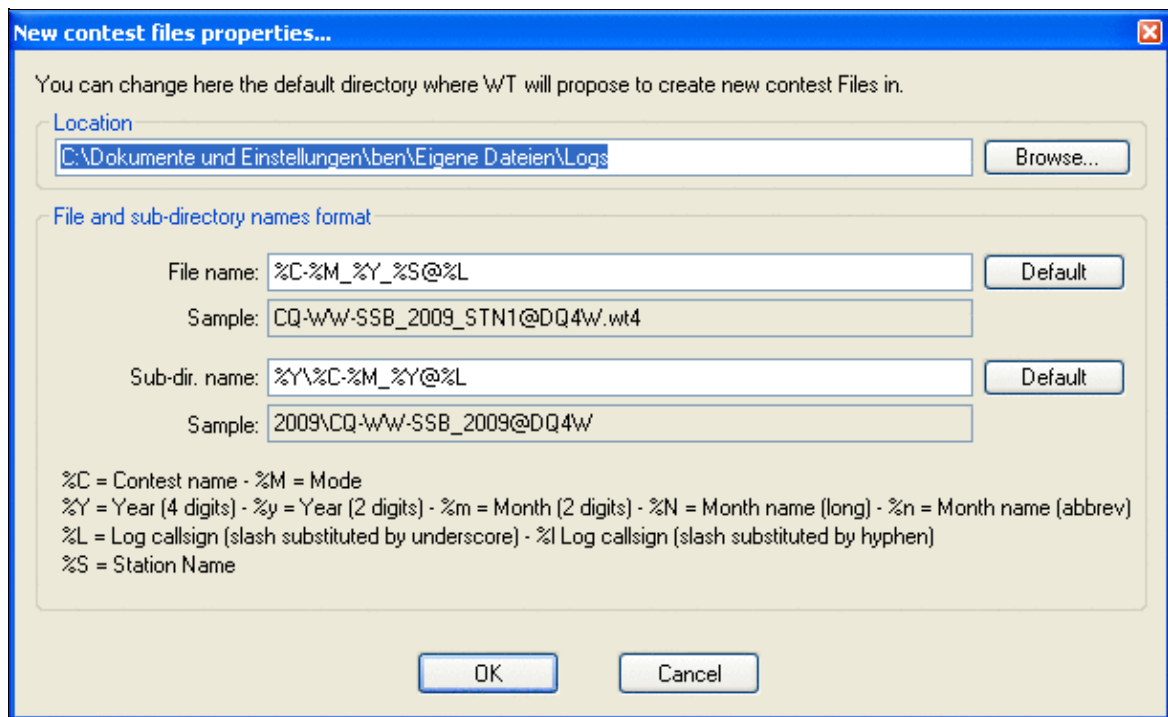

### New Contest File Properties dialog

The following macros may be used to specify the file name.

```
%C = Contest name
%I = Log callsign (slash substituted by hyphen)
%L = Log callsign (slash substituted by underscore)
%M = Mode
%m = Month (2 digits)
%N = Month name (long)
%n = Month name (abbrev)
%S = Station name
%Y = Year (4 digits)
%y = Year (2 digits)
```

## DXpedition Info Field

### Options | DXpedition Info Field

This submenu allows you to configure some options regarding the use of Win-Test on a DXpedition. It is only visible if you have selected the contest type DXpedition.

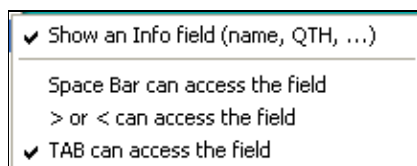

### Options available for DXpedition operation

An info field is available to store up to 13 characters of information with the QSO, e.g. the operator's name, QTH or other information that you wish to keep visible during the QSO. The info field can be accessed with the space bar, the [**>**] and [**<**] keys or the [**Tab**] key.

QSO	Mode	Bd	Time	Callsign	SentRcvd	Info	Dup
1	CW	20	12:28	DK20Y	599 599	MANFRED M15	
2	CW	20			599 599		

The DXpedition Info Field can store up to 13 characters. If you don't use space to switch fields, you can also enter a space character like shown above.

## Spot Warnings

When this option is enabled, the DX cluster spots are briefly displayed (as soon as they arrive), in the line under below the log entry line. You can choose to display only the spots of the current band and/or the new multipliers, as well as your own callsign (good to know when you're being spotted!). And of course you may want to hide dupes and invalid callsigns.

## DX Cluster

Options | DX Cluster

### DX Cluster window shortcuts

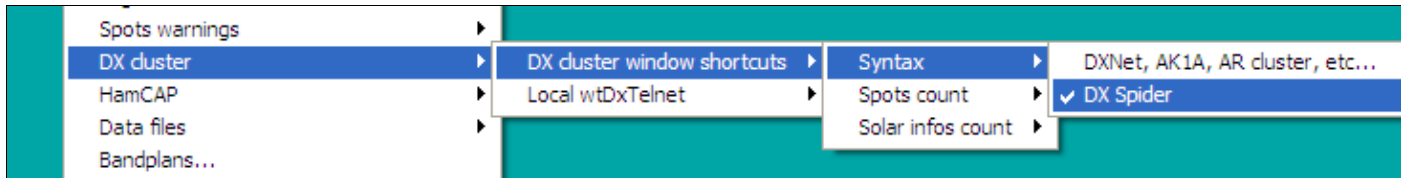

Selecting the syntax of your DX Cluster

This option controls the syntax of the DX-cluster node that you are using (DX Spider vs. AK1A, DXNet, etc.), and the count of spots and solar information requested by using the buttons in the DX cluster window.

### Start/stop wtDxTelnet automatically

When wtDxTelnet is installed in the Win-Test directory, this option allows you to start and stop this application from within Win-Test or start and stop it automatically when Win-Test is launched.

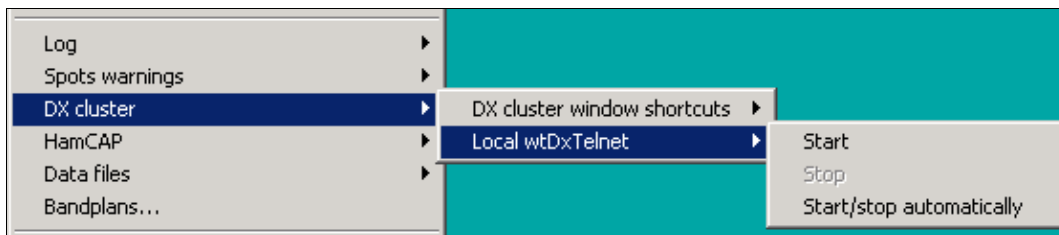

Starting and stopping wtDxTelnet from Win-test

## HamCAP

Options | HamCAP

With this menu option you can configure the way Win-Test will integrate with [HamCAP](#) (by VE3NEA). You can select if you want to see immediately the HamCAP window, as soon as you call for it with the shortcut **Ctrl-P**, or if you want it to calculate in background and you will recall the propagation forecast window later.

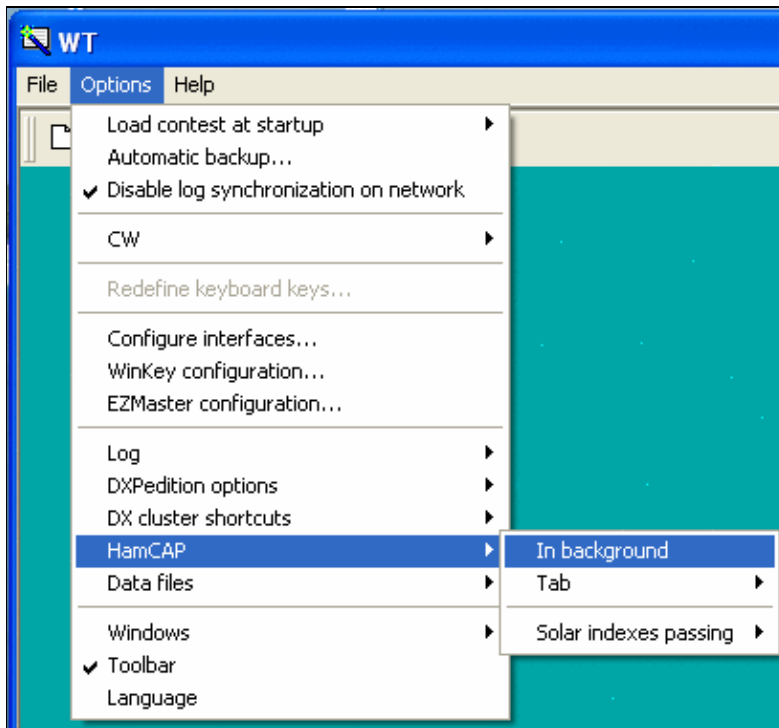

Option In Background

It is just a matter of taste and of how big is your monitor screen: if you have plenty of room, maybe you don't care to leave it in background (**In background** option **checked**), but in a visible part of the screen, so you don't lose the keyboard focus from the WT main window; otherwise you will see immediately HamCAP (**In background** option **unchecked**), and so you'll need to regain the focus with a mouse click.

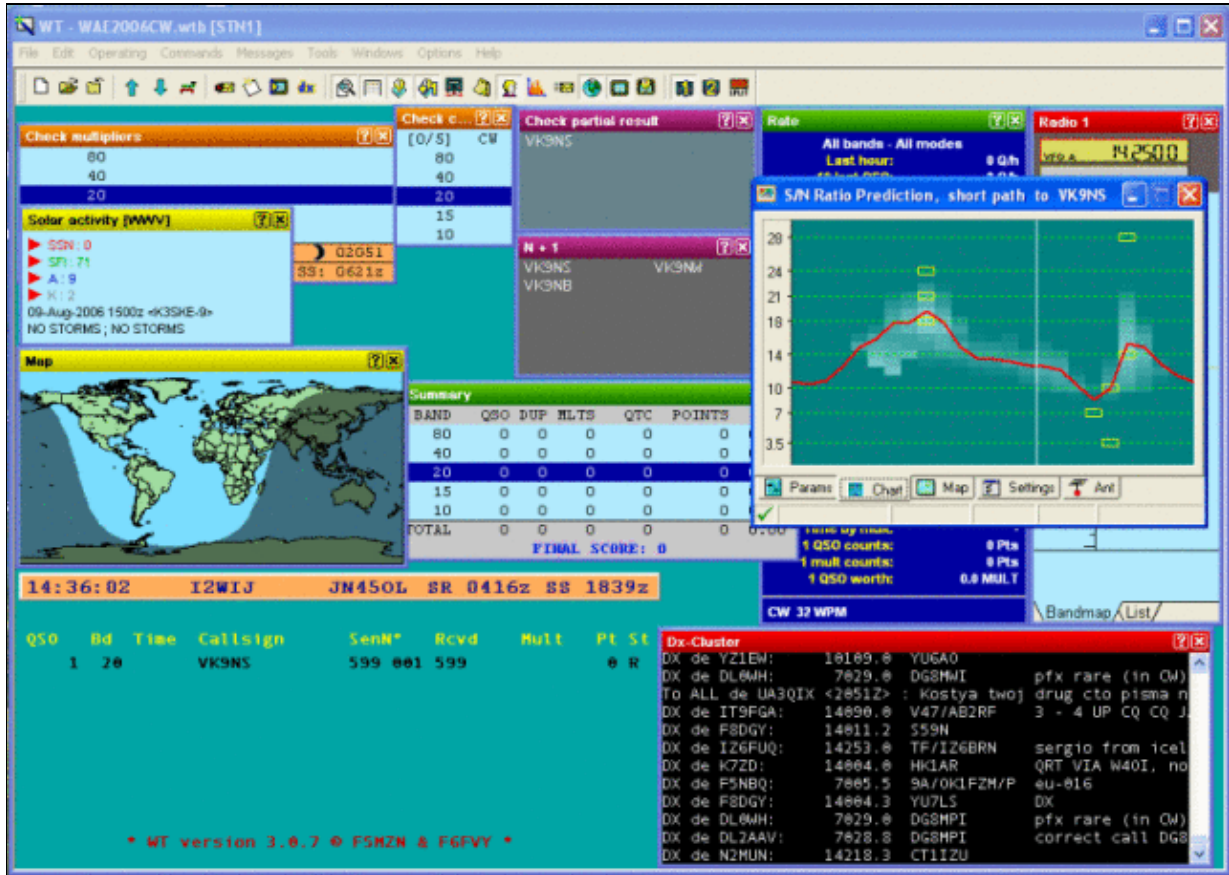

HamCAP in foreground

Then you need to setup which HamCAP tab you want to see first.

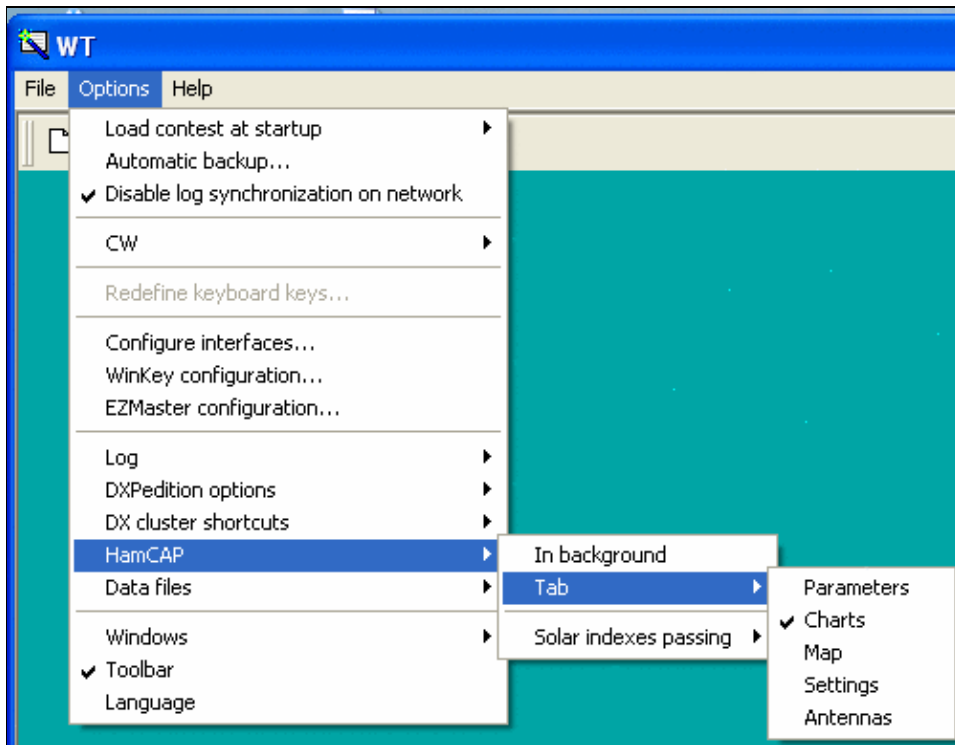

#### Option In Background

The most useful are the **Charts** or the **Map** tab, which are those that give the propagation information, while the others, namely Params, Settings, and Antennas, are useful in the HamCAP itself setup phase.

See [HamCAP](#) in this manual for more details on the setup phase.

Then you have to setup in which way HamCAP has to deal with Solar figures (SSN, SFI, A and K indexes). (See [Menu Windows Solar Activity](#) in this manual).

HamCAP has at least three different modes of operation:

- stand-alone
- in cooperation with [IonoProbe](#) (by VE3NEA)
- feeded by a calling application (Win-Test)

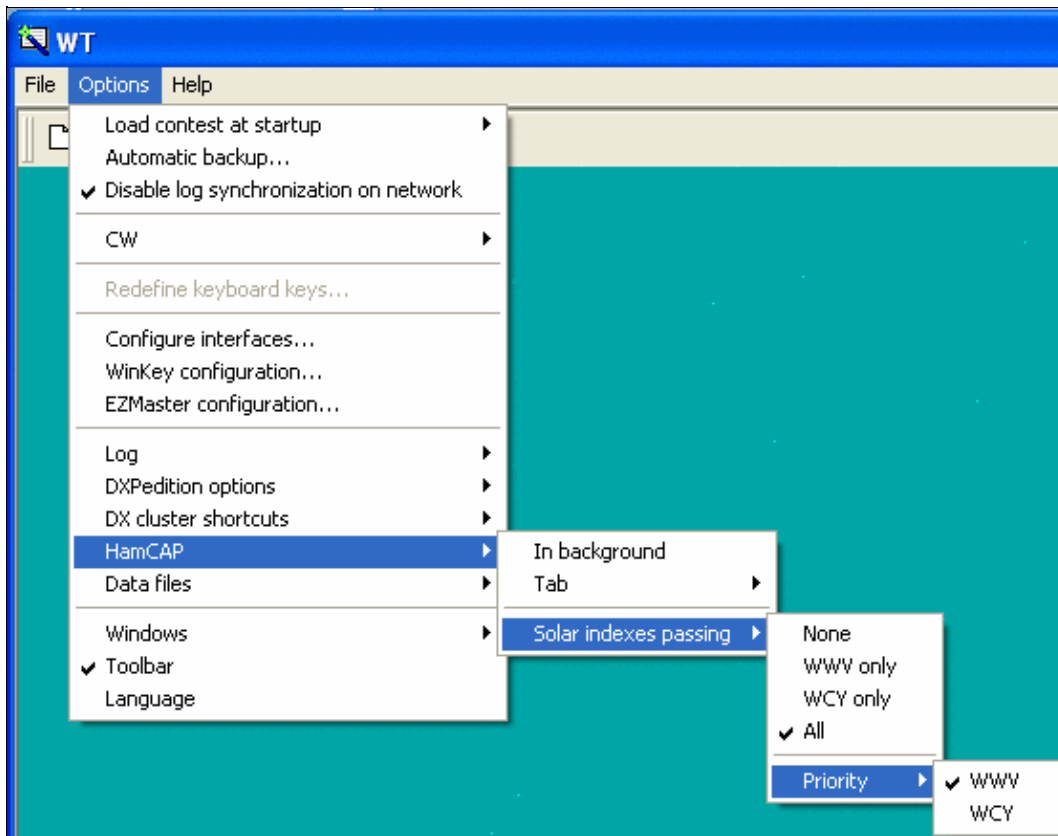

### Option Solar indexes passing

So, at this time, you should check one of the following options:

- **None**, if you don't want, or need, Win-Test to pass any data to HamCAP, which will be working in stand-alone mode or in cooperation with IonoProbe;
- **WWV only**, or **WCY only**, if you want Win-Test to pass the corresponding Solar figures, if present, to HamCAP;
- **All**, and then choose **Priority**, if you want to try to use both figures and Win-Test to pass the prioritized one in case both data are present.

## WAEDC

Options | WAEDC

Special option for the Worked All Europe DX Contest. This menu item is only visible when WAEDC Contest is selected.

For more information about Win-Test and WAEDC see WAEDC.



## Data files

Options | Data Files

Through this section you will be enabled to select four more different options in the pop-up menu as shown in the following picture.

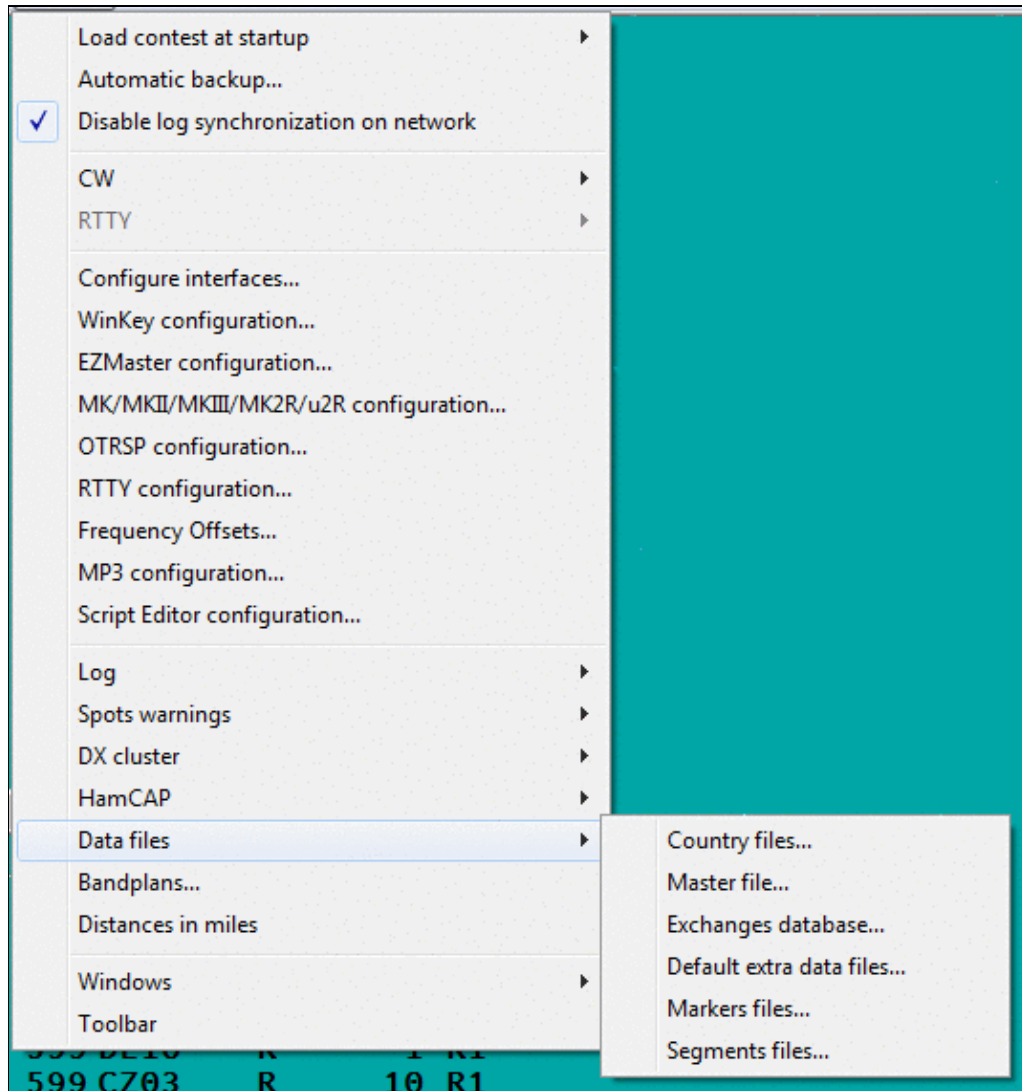

Selecting Options Data files section

## Country files...

Options | Data files | Country files...

Text command shortcut: COUNTRYFILES

This dialog controls which country file to use to identify multipliers. It is also used to calculate and pre-fill ITU and CQ Zones from country prefixes. There are three files to select from.

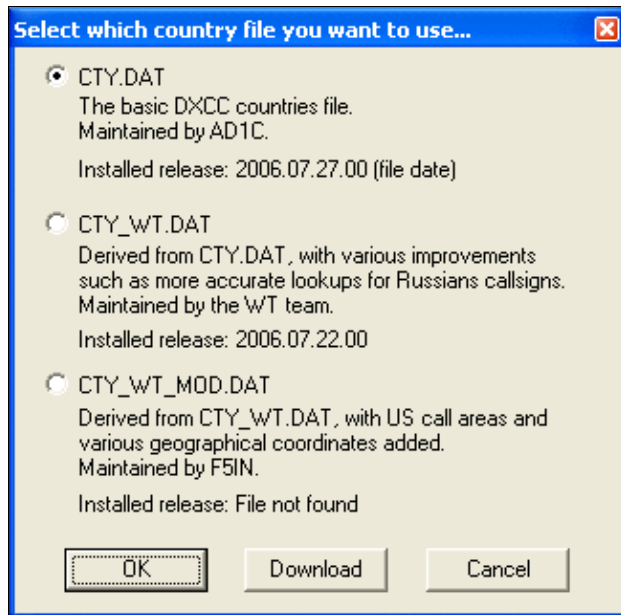

Selecting the appropriate CTY file

Selecting **CTY\_WT\_MOD.DAT** usually gives the most accurate results if you download the latest version. For a description of each file, see [Other Files](#).

You can start an immediate download from the Win-Test web site by selecting a file and clicking the **Download** button. After pressing **OK**, you will be prompted if you want to reload and re-score the log based on the updated country file.

Note that the file ends up in the user's virtual store, if you do not run Win-Test as an Administrator. This may create some confusion which file is actually being used.

## Master file...

Options | Data files | Master File...

Text command shortcut: MASTERFILE, EXCHDATABASE, EXCHFILE or EXCHFILES.

A window, indicating the name of the master file for this contest, what is the file currently used, the total number of records in the file, and release date. A Download button allows you to update directly from the [supercheckpartial.com](http://supercheckpartial.com) web site.

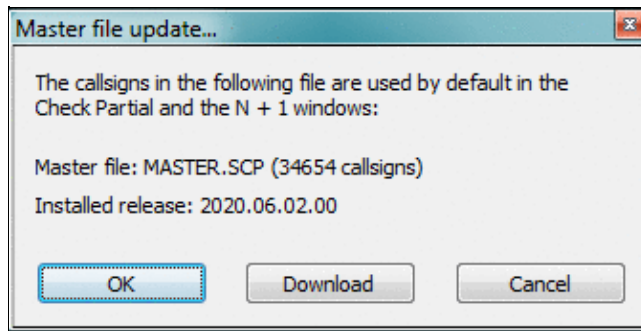

Master file information and update option

Note that the file ends up in the user's virtual store, if you do not run Win-Test as an Administrator. This may create some confusion which file is actually being used.

## Exchanges Database...

Options | Data files | Exchanges database...

Text command shortcut: EXCHDB, EXCHDATABASE, EXCHFILE or EXCHFILES.

A window, indicating the name of the exchanges file for this contest, what is the file currently used, the total number of records of this file, and the number of relevant records (if the DTB is used for different contests). A Download button allows you to update directly from the Win-Test web site.

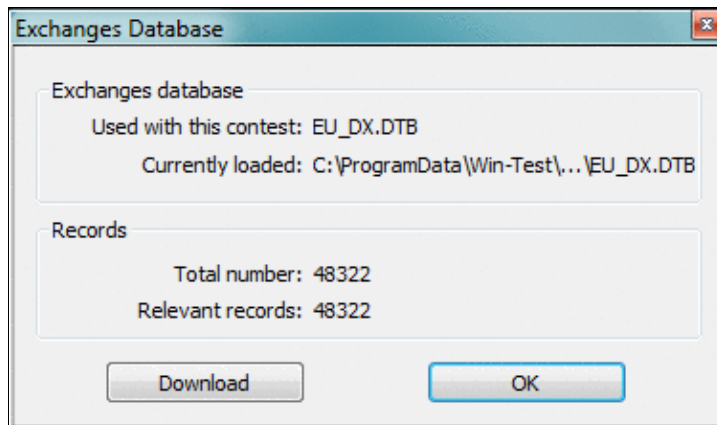

Exchanges database file information and update option

Note that the file ends up in the user's virtual store, if you do not run Win-Test as an Administrator. This may create some confusion which file is actually being used.

## Default extra data files...

Options | Data Files | Default extra data files...

This option will allow to select which EXTRA files WT will use to show specific information (like operator's name, IOTA references, club member names, etc.) in the Extra Information window (see [Menu:Windows Extra Information](#) for more details). When selecting this option a window will pop-up where you can check the files you need. You can see an example in the following picture.

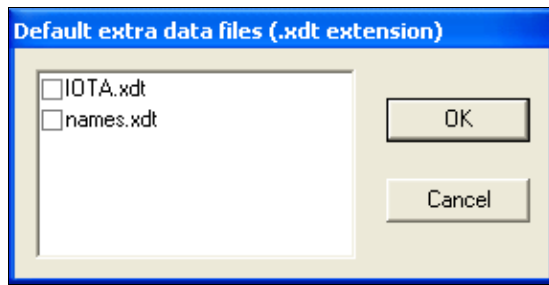

Selecting the Extra data files

## Markers files...

Options | Data Files | Markers files...

This option will allow to select which Markers files WT will use to show the relevant information in the BandMap. Please refer to the description of the band map's [context menu](#) for detailed information on these files. When selecting this option a window will pop up where you can check the files you wish to display information from. You can see an example in the following picture.

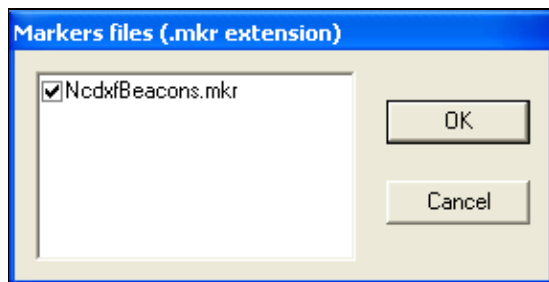

Selecting the Markers files

## Segments files...

Options | Data Files | Segments files...

This option will allow to select which segments files WT will use to show the relevant information in the BandMap. Please refer to the description of the band map's [context menu](#) for detailed information on these files. When selecting this option a window will pop up where you can check the files you wish to activate. You can see an example in the following picture.

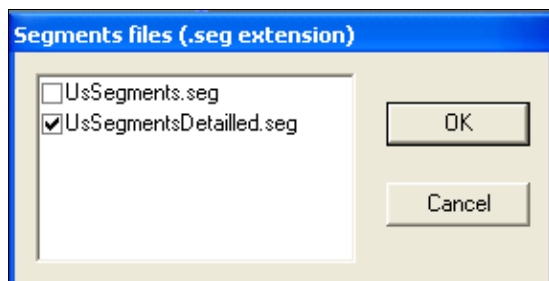

Selecting the Segments files

## Bandplans...

Options | Bandplans...

A flexible and powerful band plan management allows you to specify band boundaries on a permanent basis depending on the mode of operation. We all know, that on 40 m CW, the band goes up to 7100; on RTTY, the band goes from well below 7030 to 7100 etc. etc. Since Win-Test tries to filter incoming DX spots by frequency, this is the way to have Win-Test make the correct decision to drop the spot or display it as needed DX.

**Band plans setup...**

Bandplan: Default

Band: 40

<input checked="" type="checkbox"/> CW	7000.0	to	7040.0	<input checked="" type="checkbox"/> SSB	7040.0	to	7300.0
<input checked="" type="checkbox"/> RTTY	7035.0	to	7045.0	<input type="checkbox"/> FM		to	
<input type="checkbox"/> PSK		to		<input type="checkbox"/> PKT		to	
<input type="checkbox"/> HELL		to		<input type="checkbox"/> SAT		to	

All frequencies must be expressed in kHz

Load

Default Bandplan 1 Bandplan 2 Bandplan 3 Bandplan 4  
Bandplan 5 Bandplan 6 Bandplan 7 Bandplan 8 Bandplan 9

Save as

Default Bandplan 1 Bandplan 2 Bandplan 3 Bandplan 4  
Bandplan 5 Bandplan 6 Bandplan 7 Bandplan 8 Bandplan 9

Shift-click on the buttons above to rename or delete a created bandplan (except the Default one)

Use this current bandplan for the current log

Cancel OK

The Band Plan Manager window

Different band plans can be saved and re-loaded at a later time. It's smart to create a band plan for SSB, another for CW, yet another one for 160 CW etc.

## Windows

Options | Windows

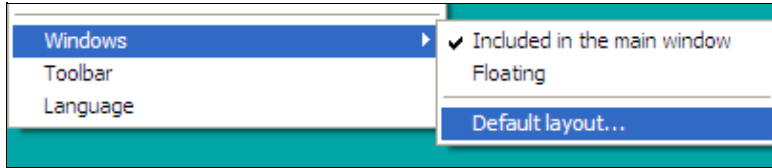

Selecting how child windows are displayed

The child windows of the application can either be included in the main Win-Test window, or float anywhere on the screen, thus allowing the Windows desktop or other running software to remain visible. If your video card and operating system support it, you can display Win-Test windows on more than one monitor.

Win-Test automatically saves the current window layout in the Win-Test binary log file (.wtb) whenever you exit. So, each log file can have a different window layout depending on the contest.

See [Positioning Windows](#) for more information about how to precisely rearrange the window layout to suit your preferences.

Once you have a window layout that you like, select `Default layout . . .` to save it as the default layout that will be used for new Win-Test logs. Win-Test displays the following dialog:

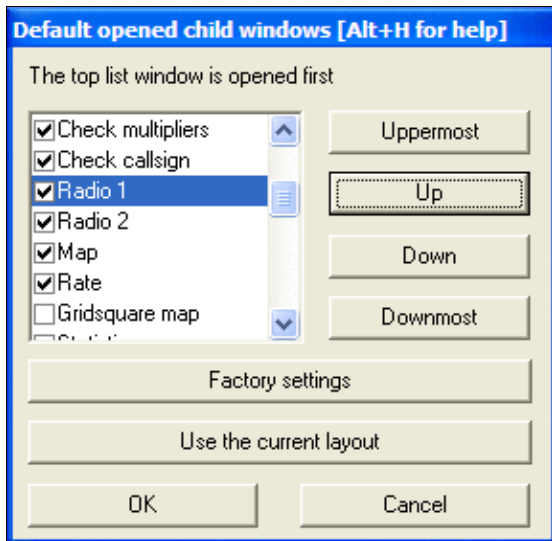

### Changing the default window layout

Updates to this dialog do *not* effect the current log's window layout; they only affect the default window layout to be used for new logs.

If you press [**Use the current layout**], Win-Test updates the list box so that it describes the current Window layout. Generally you'll want to press this button first.

The child windows are listed in the order that they will be *drawn*, so if two windows overlap, the window listed last will appear "on top" of any windows listed earlier.

Use the check boxes to indicate which child windows you want displayed by default.

- [**Uppermost**] - moves the highlighted child window to the top of the list, so that it will be drawn first, and appear *beneath* any windows drawn later.
- [**Up**] - moves the highlighted child window up one spot in the list
- [**Down**] - moves the highlighted child window down one spot in the list
- [**Downmost**] - moves the highlighted child window to the bottom of the list, so that it will be drawn last, and appear *on top of* any windows drawn earlier.
- [**Factory settings**] - restores the default window layout to the Win-Test factory default
- [**Use the current layout**] - updates the list to describe the child window layout being used by the current log
- [**OK**] - saves the displayed window list as the new Win-Test default, and closes the dialog. The layout is saved in the Win-Test initialization file (wt.ini). Pressing this button has *no effect* on the current window layout being used.
- [**Cancel**] - cancels all changes to the default child window layout and closes the dialog.

## Toolbar

Options | Toolbar

If this option is checked, the Icons toolbar is displayed below the menu.



Icon toolbar

Refer to the [Icon bar](#) chapter for a detailed explanation of all the pictorial symbols.

## Language

Options | Language

It is possible to choose the language of the Win-Test user interface. Currently supported languages are English, French, German, Italian and Spanish.



Selecting the Language

Win-Test has to restart when the language is switched.

[Back to Menus](#)

## Namespaces

- [Page](#)
- [Discussion](#)

## Variants

## Views

- [Read](#)
- [View source](#)
- [View history](#)

## More

- This page was last edited on 10 April 2023, at 07:00.
- [Privacy policy](#)
- [About Win-Test Wiki](#)
- [Disclaimers](#)





# Menu:Help

From Win-Test Wiki

[Jump to navigation](#) [Jump to search](#)

## Contents

- [1 Register software](#)
- [2 Use online documentation](#)
- [3 Reference manual](#)
- [4 Display text command tips for menu items](#)
- [5 Win-Test Home Page](#)
- [6 Documentation Wiki Home Page](#)
- [7 About](#)

## Register software

Help | Register Software...

Please refer to the detailed Installation Guides in the [FAQ page](#) for step-by-step instructions on how to use this dialog.

Even with the trial or "demo" version, you can fully use Win-Test. There is only a time restriction that randomly shuts down Win-Test, and exported logs (Cabrillo, Reg I Test) are limited to 50 QSOs.

To register Win-Test, after having purchased a licence, you just need to visit the Win-Test web pages and request a key code, by entering your customer account number and your system's Computer Code which is displayed in this dialog box.

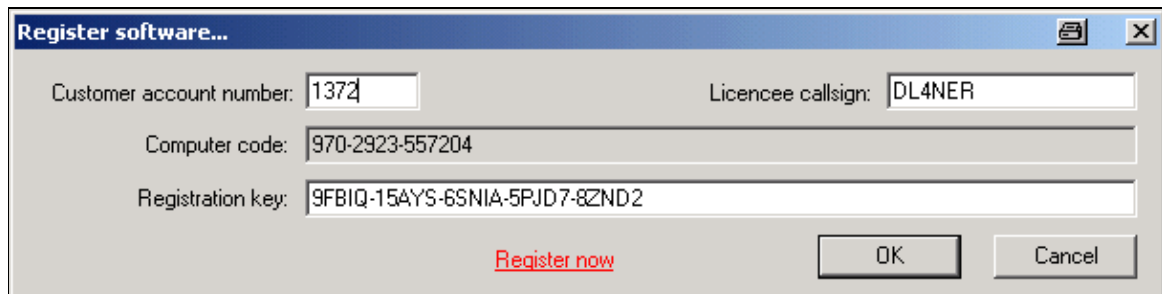

Register software...

Customer account number: 1372      Licencee callsign: DL4NER

Computer code: 970-2923-557204

Registration key: 9FB1Q-15AYS-6SNIA-5PJD7-8ZND2

[Register now](#)      OK      Cancel

Win-Test Registration Window

A license key will be sent to you via email from the license robot. Just copy this key into the correct field and press OK. The limitations will then be disabled and when Win-Test starts up, you will no longer have to press keys 1, 2 or 3.

## Use online documentation

Help | Use online manual

If this option is checked, Win-Test tries to access the reference manual on the web, instead of using the local copy that has been distributed with the installation file.

## Reference manual

Help | Reference Manual or **Alt-H**

Starts a browser and displays the reference manual.

Sometimes, the documentation provided with newer releases of Win-Test are slightly outdated. To use the most current version of the manual, either select the "online" version as shown above or retrieve a copy of the static manual from <http://docs.win-test.com/pdf/static/manual.zip> and unpack it in the Win-Test/docs/en directory (rename or remove the original en-directory first). This will provide you with the most up-to-date documentaion.

## Display text command tips for menu items

Help | Display text commands tips for menu items

This option lets you enable tool tips (small yellow pop-up help text) for menu items. This option is enabled by default. These tool tips display keyboard shortcuts or text commands for the functions selected. Text commands let you perform menu functions without having to use the mouse.

## Win-Test Home Page

Help | Win-Test Home Page

Starts up the system Web browser and directs it to go directly to the Win-Test Home Page <http://www.win-test.com>.

## Documentation Wiki Home Page

Help | Documentation Wiki Home Page

Starts up the system Web browser and directs it to go directly to the Win-Test Documentation Website (Wiki) <http://docs.win-test.com>.

## About

Help | About

Displays the Win-Test version used, and allows a direct access to the Win-Test web pages at [www.win-test.com](http://www.win-test.com).



About Win-Test

[Back to Menu](#)

## Namespaces

- [Page](#)
- [Discussion](#)

## Variants

## Views

- [Read](#)
- [View source](#)
- [View history](#)

## More

- This page was last edited on 11 March 2015, at 20:55.

- [Privacy policy](#)
- [About Win-Test Wiki](#)
- [Disclaimers](#)

-  The logo consists of a small yellow sun icon to the left of the text "Powered By MediaWiki".

# SO2R/Advanced SO2R

From Win-Test Wiki

[Jump to navigation](#) [Jump to search](#)

## Contents

- [1 Using 'advanced SO2R' Mode](#)
  - ◆ [1.1 Required Hardware](#)
  - ◆ [1.2 Understanding basic concepts](#)
  - ◆ [1.3 Moments of a QSO](#)
- [2 Setting up scenarios](#)
- [3 Some typical Variables used in Scenario Settings](#)
- [4 See also](#)
  - ◆ [4.1 External sources](#)

## Using 'advanced SO2R' Mode

Advanced SO2R is a mode that frees the operator from the SO2R control equipment and controls the audio and transmitting of radio1 and radio2 automatically according to pre-defined scenarios and the moment of the QSO.

### Required Hardware

Advanced SO2R mode and setting up scenarios requires external SO2R control equipment communicating with Win-Test via a USB port, COM port DTR/RTS pins, or LPT port pins, such as the Ham Radio Solutions EZMaster, the microHAM MK2R and micro2R, the YCCC OTRSP box, the DX Doubler. See [Supported Accessories - Integrated SO2R Boxes](#) for more details.

### Understanding basic concepts

There are three dimensions that need to be understood:

- Transmission into radio1 or radio2
- Reception of radio1 only; radio2 only; radio1 in left ear and radio2 in right ear at the same time
- Different and automatic transmission and reception control of radio1 and radio2 according to the moment of the QSO.

The last dimension is the reason for calling this the 'advanced SO2R' mode.

### Moments of a QSO

A QSO can be divided into four moments: (1) CQ's and end of QSO's, (2) listening to the pile up, (3) sending call and report to station heard in pile up, (4) getting report from station.

Imagine the following contest CQ between CT3NT and ZD8Z.

- Moment1: TEST CT3NT
- Moment2: zd8z
- Moment3: ZD8Z 59933
- Moment4: tu 59936
- Moment1: TU CT3NT

What are the actions of the operator at CT3NT using Win-Test?

- Moment1 (CQ's) starts when the operator at CT3NT pushes the **F1** key in Win-Test.
- Moment2 starts when Win-Test finishes sending F1
- Moment3 (sending call and report) starts when the operator at CT3NT pushes the **[Insert]** key in Win-Test.
- Moment4 starts when Win-Test finishes sending **[Insert]** key
- Moment1 (end of QSO) starts when the operator at CT3NT pushes the **[+]** key to log the QSO with ZD8Z.

## Setting up scenarios

A standard F1 message contains only the content of what is sent, i.e. F1 = **TEST CT3NT**. When using Advanced SO2R mode the F1 message will have the content plus the scenario to control audio and transmitting. Imagine the following scenario:

**F1 = \$R2R2 \$F1 \$R1R2**

This simple scenario will do the following. When the operator pushes the F1 key, Win-Test will switch the headphones to radio2 only (**\$R2R2**), transmit the content of standard F1 message (**TEST CT3NT**) and when that is over will switch the headphones to left ear on radio1 and right ear on radio2 (**\$R1R2**).

- **\$R2R2 \$F1** set up the audio headphone settings and transmission in moment 1 of the QSO
- **\$R1R2** sets the audio headphone settings for moment 2 of the QSO

Now imagine a more complex scenario:

**F2 = \$R1R1 \$F2 \$R2R2 \$TR2 \$MSG1 \$R1R2**

When the operator pushes the F2 key, Win-Test will switch the headphone to radio1 only, transmit the content of standard F2 message (59933), when that is over switch the headphone to radio2 only, transmit the content of additional message#1 into secondary radio and when that is over switch headphones to left ear on radio1 and right ear on radio2. The above scenario is used when sending a report to a multiplier in the second radio and a quick call in run radio to keep frequency busy.

Now imagine the following SSB scenario:

**F1 = \$RESET \$R2R2 \$F1 \$RESET \$R1R1 \$LATCH**

When the operator pushes the F1 key, Win-Test will reset to automatic control any manual audio setting in case there was one, switch the headphone to radio2 only, transmit the content of the voice keyer F1, reset to automatic control in case any manual audio control while F1 was being sent, and switch the headphones to radio1 only. The latch command sets the Latch Mode in case the operator uses the microphone during the next moment of the QSO, and wants to listen to the secondary radio while talking on the microphone.

The user can configure the scenarios in the menu *Operating | Modify the scenarios*. There is a wizard with five pre-defined scenarios, but the user can change them and use his scenarios according to his skill and his SO2R expertise.

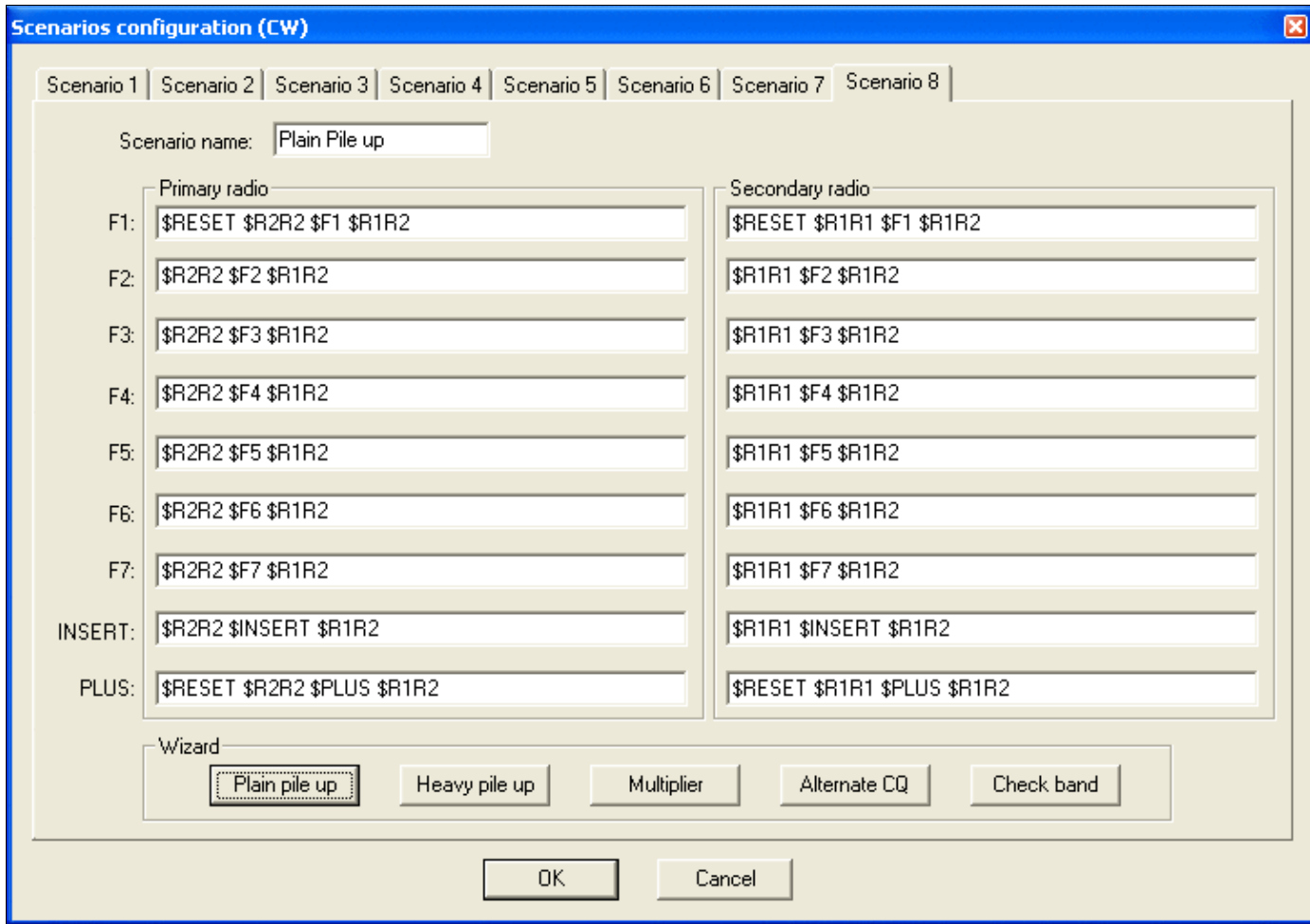

Scenarios configuration window

A fast way to select a specific scenario is **AltGr-1...AltGr-8**.

## Some typical Variables used in Scenario Settings

- **\$GRNR** sends gr/num of the received QTC
- **\$SERIAL** sends QSO #
- **\$LOGGEDCALL** send what's typed in callsign field
- **\$TR1** and **\$TR2** primary radio or secondary radio tx
- **\$GRABSPOT**, which grabs spot on the current frequency
- **\$ZONE** sends zone nr set in contest configuration
- **\$R1R1**, **\$R1R2**, **\$R2R2** which can be entered in the predefined CW messages to set the headphone
- **\$INSERT** and **\$PLUS** send messages behind ins or +
- **\$RESET** cancels any manual change made in the audio control
- **\$ALTERNATECQ** (or **\$ACQ**) swaps primary and secondary radios and send CQ on the secondary radio
- **\$CQ** same as **\$ALTERNATECQ** but does not swap radios
- **\$MSG1...\$MSG12**: additional CW messages (see Alt - C)
- **\$SPACEBAR** works like hitting spacebar-key (move cursor to exchange field)
- **\$TAB** work like hitting tab-key (move cursor to next field)
- **\$GUESSZONE** filling exchange field(s) if possible, but cursor remains in the same edit field
- **\$GUESSEXCH** (or **\$GUESSEXCHANGE**) mimics a space bar hit (filling exchange field(s))
- **\$CR** works like hitting enter-key (log QSO)
- **\$MYCALL** sends callsign set in contest configuration
- **\$REPEAT** Reset the automatic repeat mode interval
- **\$CORRECT** send a call correction, if any
- **\$F1...\$F6** send the message associated with F1 ... F6 function key
- **\$LATCH** sets latch mode
- **\$QSOB4** send QSOB4 message if the current QSO is a dupe

The complete listing of all message variables available can be found [here](#).

## See also

### External sources

- [MicroHAM web site](#)
- [CT1BOH SO2R page](#)
- [CT1BOH Audio page](#)

### Namespaces

- [Page](#)
- [Discussion](#)

### Variants

## Views

- [Read](#)
- [View source](#)
- [View history](#)

## More

- This page was last edited on 14 November 2011, at 07:15.

- [Privacy policy](#)
- [About Win-Test Wiki](#)
- [Disclaimers](#)





# SO2R/Advanced SO2R

From Win-Test Wiki

[Jump to navigation](#) [Jump to search](#)

## Contents

- [1 Using 'advanced SO2R' Mode](#)
  - ◆ [1.1 Required Hardware](#)
  - ◆ [1.2 Understanding basic concepts](#)
  - ◆ [1.3 Moments of a QSO](#)
- [2 Setting up scenarios](#)
- [3 Some typical Variables used in Scenario Settings](#)
- [4 See also](#)
  - ◆ [4.1 External sources](#)

## Using 'advanced SO2R' Mode

Advanced SO2R is a mode that frees the operator from the SO2R control equipment and controls the audio and transmitting of radio1 and radio2 automatically according to pre-defined scenarios and the moment of the QSO.

### Required Hardware

Advanced SO2R mode and setting up scenarios requires external SO2R control equipment communicating with Win-Test via a USB port, COM port DTR/RTS pins, or LPT port pins, such as the Ham Radio Solutions EZMaster, the microHAM MK2R and micro2R, the YCCC OTRSP box, the DX Doubler. See [Supported Accessories - Integrated SO2R Boxes](#) for more details.

### Understanding basic concepts

There are three dimensions that need to be understood:

- Transmission into radio1 or radio2
- Reception of radio1 only; radio2 only; radio1 in left ear and radio2 in right ear at the same time
- Different and automatic transmission and reception control of radio1 and radio2 according to the moment of the QSO.

The last dimension is the reason for calling this the 'advanced SO2R' mode.

### Moments of a QSO

A QSO can be divided into four moments: (1) CQ's and end of QSO's, (2) listening to the pile up, (3) sending call and report to station heard in pile up, (4) getting report from station.

Imagine the following contest CQ between CT3NT and ZD8Z.

- Moment1: TEST CT3NT
- Moment2: zd8z
- Moment3: ZD8Z 59933
- Moment4: tu 59936
- Moment1: TU CT3NT

What are the actions of the operator at CT3NT using Win-Test?

- Moment1 (CQ's) starts when the operator at CT3NT pushes the **F1** key in Win-Test.
- Moment2 starts when Win-Test finishes sending F1
- Moment3 (sending call and report) starts when the operator at CT3NT pushes the **[Insert]** key in Win-Test.
- Moment4 starts when Win-Test finishes sending **[Insert]** key
- Moment1 (end of QSO) starts when the operator at CT3NT pushes the **[+]** key to log the QSO with ZD8Z.

## Setting up scenarios

A standard F1 message contains only the content of what is sent, i.e. F1 = **TEST CT3NT**. When using Advanced SO2R mode the F1 message will have the content plus the scenario to control audio and transmitting. Imagine the following scenario:

**F1 = \$R2R2 \$F1 \$R1R2**

This simple scenario will do the following. When the operator pushes the F1 key, Win-Test will switch the headphones to radio2 only (**\$R2R2**), transmit the content of standard F1 message (**TEST CT3NT**) and when that is over will switch the headphones to left ear on radio1 and right ear on radio2 (**\$R1R2**).

- **\$R2R2 \$F1** set up the audio headphone settings and transmission in moment 1 of the QSO
- **\$R1R2** sets the audio headphone settings for moment 2 of the QSO

Now imagine a more complex scenario:

**F2 = \$R1R1 \$F2 \$R2R2 \$TR2 \$MSG1 \$R1R2**

When the operator pushes the F2 key, Win-Test will switch the headphone to radio1 only, transmit the content of standard F2 message (59933), when that is over switch the headphone to radio2 only, transmit the content of additional message#1 into secondary radio and when that is over switch headphones to left ear on radio1 and right ear on radio2. The above scenario is used when sending a report to a multiplier in the second radio and a quick call in run radio to keep frequency busy.

Now imagine the following SSB scenario:

**F1 = \$RESET \$R2R2 \$F1 \$RESET \$R1R1 \$LATCH**

When the operator pushes the F1 key, Win-Test will reset to automatic control any manual audio setting in case there was one, switch the headphone to radio2 only, transmit the content of the voice keyer F1, reset to automatic control in case any manual audio control while F1 was being sent, and switch the headphones to radio1 only. The latch command sets the Latch Mode in case the operator uses the microphone during the next moment of the QSO, and wants to listen to the secondary radio while talking on the microphone.

The user can configure the scenarios in the menu *Operating | Modify the scenarios*. There is a wizard with five pre-defined scenarios, but the user can change them and use his scenarios according to his skill and his SO2R expertise.

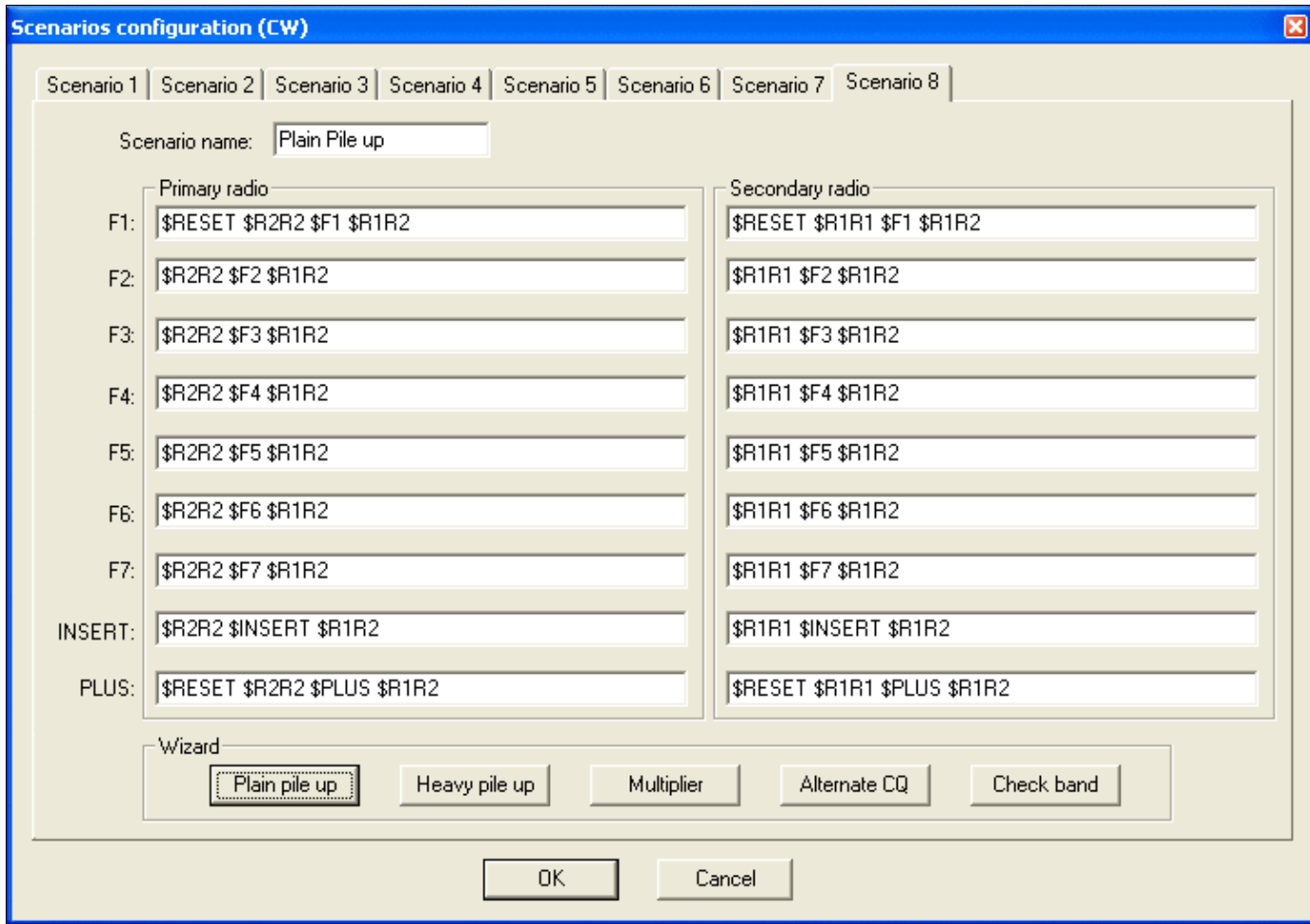

Scenarios configuration window

A fast way to select a specific scenario is **AltGr-1...AltGr-8**.

## Some typical Variables used in Scenario Settings

- **\$GRNR** sends gr/num of the received QTC
- **\$SERIAL** sends QSO #
- **\$LOGGEDCALL** send what's typed in callsign field
- **\$TR1** and **\$TR2** primary radio or secondary radio tx
- **\$GRABSPOT**, which grabs spot on the current frequency
- **\$ZONE** sends zone nr set in contest configuration
- **\$R1R1**, **\$R1R2**, **\$R2R2** which can be entered in the predefined CW messages to set the headphone
- **\$INSERT** and **\$PLUS** send messages behind ins or +
- **\$RESET** cancels any manual change made in the audio control
- **\$ALTERNATECQ** (or **\$ACQ**) swaps primary and secondary radios and send CQ on the secondary radio
- **\$CQ** same as **\$ALTERNATECQ** but does not swap radios
- **\$MSG1...\$MSG12**: additional CW messages (see Alt - C)
- **\$SPACEBAR** works like hitting spacebar-key (move cursor to exchange field)
- **\$TAB** work like hitting tab-key (move cursor to next field)
- **\$GUESSZONE** filling exchange field(s) if possible, but cursor remains in the same edit field
- **\$GUESSEXCH** (or **\$GUESSEXCHANGE**) mimics a space bar hit (filling exchange field(s))
- **\$CR** works like hitting enter-key (log QSO)
- **\$MYCALL** sends callsign set in contest configuration
- **\$REPEAT** Reset the automatic repeat mode interval
- **\$CORRECT** send a call correction, if any
- **\$F1...\$F6** send the message associated with F1 ... F6 function key
- **\$LATCH** sets latch mode
- **\$QSOB4** send QSOB4 message if the current QSO is a dupe

The complete listing of all message variables available can be found [here](#).

## See also

### External sources

- [MicroHAM web site](#)
- [CT1BOH SO2R page](#)
- [CT1BOH Audio page](#)

### Namespaces

- [Page](#)
- [Discussion](#)

### Variants

## Views

- [Read](#)
- [View source](#)
- [View history](#)

## More

- This page was last edited on 14 November 2011, at 07:15.

- [Privacy policy](#)
- [About Win-Test Wiki](#)
- [Disclaimers](#)



# API

From Win-Test Wiki

[Jump to navigation](#) [Jump to search](#)

## Contents

- [1 List of Win-Test API Functions](#)
  - ◆ [1.1 Class wtApp](#)
  - ◆ [1.2 Class wtContest](#)
  - ◆ [1.3 Class wtGab](#)
  - ◆ [1.4 Class wtKeyer](#)
  - ◆ [1.5 Class wtMicroham](#)
  - ◆ [1.6 Class wtOp](#)
  - ◆ [1.7 Class wtOtrsp](#)
  - ◆ [1.8 Class wtOso](#)
  - ◆ [1.9 Class wtRadio\\*](#)
  - ◆ [1.10 Class wtScript](#)
  - ◆ [1.11 Class wtStatus](#)
- [2 Win-Test API Variables](#)
- [3 Win-Test API Constants](#)
  - ◆ [3.1 Child window IDs](#)
  - ◆ [3.2 Supported contest IDs](#)
  - ◆ [3.3 Supported mode IDs](#)
  - ◆ [3.4 Status key IDs](#)
  - ◆ [3.5 Radio Constants](#)
  - ◆ [3.6 Radio Manufacturer Constants](#)
  - ◆ [3.7 Radio Types](#)
  - ◆ [3.8 microHAM Device IDs](#)
- [4 Advanced Programming Examples](#)
  - ◆ [4.1 ESM Script \(embedded into Win-Test\)](#)
  - ◆ [4.2 Alternative ESM Script \(provided by F5VIH/SV3SJ\)](#)
  - ◆ [4.3 Grab next call from partner window](#)
  - ◆ [4.4 Re-map \[Å \] key with /P for Field Day](#)
  - ◆ [4.5 Change background of Main Window depending on RUN/S&P Mode](#)

## List of Win-Test API Functions

Compiled from information found on the WT reflector on October 7, 2009 ([\[1\]](#), [\[2\]](#)).

The most current API documentation from the Win-Test developers may be found at <http://download.win-test.com/v4/lua/LuaApiDoc.txt>.

### Class wtApp

<code>wtApp:AlertBox (Text)</code>	Opens a standard Windows alert box with the specified text and an [OK] button.
<code>wtApp:CallScript (strScript [, arg])</code>	Call a wts script (no extension required in strScript). Can return a number only (or nothing). Optional

## Win-Test Wiki

	argument's value can be accessed via wtArg in the called script.
<code>wtApp: GetAppPath ()</code>	Win-Test installation directory path
<code>wtApp: GetCfgPath ()</code>	\cfg directory path
<code>wtApp: GetCtyPath ()</code>	\countryFiles directory path
<code>wtApp: GetDatabasePath ()</code>	\databases directory path
<code>wtApp: GetExtraPath ()</code>	\extras directory path
<code>wtApp: GetIniFileName ()</code>	Return the name of the current .ini file, including the ".ini" extension. Usually returns "wt.ini" unless overridden via the -i command line argument.
<code>wtApp: GetKeyState ()</code>	Returns the modifiers keys status when the function is called.
<code>wtApp: GetLastError ()</code>	Return the Windows last-error code value when using PostMessage or SendMessage. Can be useful to debug such statements.
<code>wtApp: GetLogFileName ()</code>	Return the name of the current log file, including the ".wt4" extension
<code>wtApp: GetLogPath ()</code>	Current log directory path
<code>wtApp: GetOpPath ()</code>	\ops directory path
<code>wtApp: GetScriptPath ()</code>	\scripts directory path
<code>wtApp: InputInteger (Prompt, Title, Default)</code>	If Prompt is empty, it defaults to "Enter an integer". If Title is empty, it defaults to "Win-Test script". If a default value is specified, the pop-up window is pre-filled with the specified integer value.
<code>wtApp: InputNumber (Prompt, Title, Default)</code>	If Prompt is empty, it defaults to "Enter a number". If Title is empty, it defaults to "Win-Test script". If a default value is specified, the pop-up window is pre-filled with the specified number value. In LUA, a "number" data type may or may not contain a decimal point.
<code>wtApp: InputText (Prompt, Title, Default)</code>	If Prompt is empty, it defaults to "Enter a text". If Title is empty, it defaults to "Win-Test script". If a default value is specified, the pop-up window is pre-filled with the specified text.
<code>wtApp: InputUpperText (Prompt, Title, Default)</code>	Same as wtApp:InputText, but all text is converted to uppercase.
<code>wtApp: IsCapsLock ()</code>	Returns <b>true</b> if the [ <b>Caps Lock</b> ] key is enabled and the secondary radio window is highlighted, otherwise returns <b>false</b> .

<b>wtApp:IsPostKeyProcess ()</b>	Returns <b>true</b> if the current script is being executed after the assigned key has been processed by WT, otherwise returns <b>false</b> .
<b>wtApp:MessageBox (Text, Type, Title)</b>	<p>Display a Message box with the specified text, using the specified type and message box title (shown in the title bar of the message box window). See also wtApp:AlertBox(). Type 0 is an ordinary message box with an [OK] button, type 1 has both an [OK] and a [Cancel] button. The return code indicates the button pressed by the user (which may be ignored). Return code 1 means the [OK] button was pressed, return code 2 means the [Cancel] button was pressed.</p> <p>See the <a href="#">Microsoft Windows MessageBox API documentation</a> for more details about supported message box types and return codes.</p>
<b>wtApp:PostMessage (strTitle, strClass, nMsg, nWParam, nLParam[, strLParam])</b>	<p>Place (post) a message in the message queue associated with the thread that created the specified window and returns without waiting for the thread to process the message.</p> <p>strTitle : Title of the target window  strClass : Specifies the window class name of the child window (must be empty if unused)  nMsg : Message to be posted  nWParam : Additional message-specific information (use 0 if unused)  nLParam : Additional message-specific information (use 0 if unused)  strLParam : String as additional message-specific information</p>
<b>wtApp:ResetCapsLock ()</b>	Disables the <b>[Caps Lock]</b> key. Normally used to change focus to the primary radio window when <u>Caps Lock binds to the secondary radio</u> is enabled
<b>wtApp:SendAltKey (Key)</b>	Key is a letter, a number, or a function key ("F1".. "F12" + "Insert" + "Plus" + "Esc")
<b>wtApp:SendCtrlKey (Key)</b>	Key is a letter, a number, or a function key ("F1".. "F12" + "Insert" + "Plus" + "Esc")
<b>wtApp:SendFKey (Key [, ModifierKeys])</b>	Send Functions keys (and Insert and Plus). Key is one of "F1".. "F12" + "Insert" + "Plus" + "Esc". ModifierKeys (optional) indicates the modifier keys (Ctrl = 4, Alt = 2, Shift = 1, None = 0 - can be combined via addition, e.g., 6 = Ctrl+Alt). If this argument is missing or -1, the current modifier keys are used.



<b>wtApp:SendKey</b> (Key [, ModifiersKeys])	Send key or string. Key is a single character or a string. ModifiersKeys (optional) indicates the modifiers keys (Ctrl = 4, Alt = 2, Shift = 1, None = 0 - can be combined via addition, e.g., 6 = Ctrl+Alt). If this argument is missing or -1, the current modifiers keys are used.
<b>wtApp:SendKeyCode</b> (Code [, ModifierKeys])	<p>Send a key by its ASCII code. Keycode is an ASCII code. ModifierKeys (optional) indicates the modifier keys (Ctrl = 4, Alt = 2, Shift = 1, None = 0 - can be combined via addition, e.g., 6 = Ctrl+Alt). If this argument is missing or -1, the current modifier keys are used.</p> <p>For Windows virtual key codes, add 256 to the key code, e.g. use <code>wtApp:SendKeyCode(265, WT_KEY_CTRL)</code> to simulate pressing <code>[Ctrl]+[TAB]</code>. Refer to the <a href="#">Microsoft Virtual Key Code documentation</a> to obtain code values for <code>VK_TAB (256+9=265)</code>, <code>VK_RETURN (256+13=269)</code>, <code>VK_LEFT (256+37=293)</code>, etc.</p>
<b>wtApp:SendMessage</b> (strTitle, strClass, nMsg, nWParam, nLParam[, strLParam])	<p>Send the specified message to a window. The SendMessage function calls the window procedure for the specified window and does not return until the window procedure has processed the message.</p> <p>strTitle : Title of the target window  strClass : Specifies the window class name of the child window (must be empty if unused)  nMsg : Message to be posted  nWParam : Additional message-specific information (use 0 if unused)  nLParam : Additional message-specific information (use 0 if unused)  strLParam : String as additional message-specific information</p> <p>Return the string "FAIL" if there was a problem or the command timed out. Otherwise, it is set to the numeric result of the message, which might sometimes be a "reply" depending on the nature of the message and its target window.</p>
<b>wtApp:SetCapsLock</b> ()	Enables the <b>[Caps Lock]</b> key. Normally used to change focus to the secondary radio window when <a href="#">Caps Lock binds to the secondary radio</a> is enabled
<b>wtApp:SetWindowColor</b> (ChildWndId, nRed, nGreen, nBlue, nColorIndex)	Set the nColorIndex color of the child window designated by its windowID (see <a href="#">Child window IDs</a> ). If ChildWndId is < 0, it applies to the main window. If nColorIndex is omitted (or set to 0), it applies to the

	background color All colors must be $\leq 255$ .
<code>wtApp: ShowWindow (ChildWndId)</code>	Show the child window designated by its windowID (see <a href="#">Child window IDs</a> )
<code>wtApp: Sleep (Time)</code>	Time expressed in milliseconds.
<code>wtApp: TextCommand (Text)</code>	Send WT text command to application
<code>wtApp: ToggleCapsLock ()</code>	Toggles the [ <b>Caps Lock</b> ] key. Normally used to swap the current focus from the primary or secondary radio window when <u>Caps Lock binds to the secondary radio is enabled</u>
<code>wtApp: ToggleWindow (ChildWndId)</code>	Toggle the child window designated by its windowID (see <a href="#">Child window IDs</a> )
<code>wtApp: WizzWindow (ChildWndId)</code>	"Wizz" (shake or vibrate) the child window designated by its windowID (see <a href="#">Child window IDs</a> ). Can be used to draw attention to a particular window.

**Class wtContest**

<code>wtContest: IsExchangeRequired ()</code>	Return a boolean. True if the current contest requires an exchange (associated with RST)
<code>wtContest: GetCategoryId ()</code>	Return the current CategoryID
<code>wtContest: GetContestId ()</code>	Return the current contestID (see <a href="#">Supported contest IDs</a> )
<code>wtContest: GetModeCategoryId ()</code>	Return the current Mode CategoryID
<code>wtContest: GetMyCallsign ()</code>	Return my callsign set in the startup dialog of the contest
<code>wtContest: GetOverlayId ()</code>	Return the current Overlay Id
<code>wtContest: GetPowerClassId ()</code>	Return the current Power Class Id

**Class wtGab**

<code>wtGab: Send (strText [, strToStation])</code>	Sends a gab strText to strToStation. If strToStation is omitted, the text is sent to the whole network.
---	---

**Class wtKeyer**

<code>wtKeyer: GetCwSpeed ()</code>	Return the CW speed in wpm (return 0 in case of error).
<code>wtKeyer: GrabHighlightedCallsign ()</code>	Works only in RTTY mode and grabs the currently highlighted callsign from the RX window.
<code>wtKeyer: Insert (strMessage)</code>	Works for the CW and RTTY keyers. When used in a synchronous script, it provides a way to "fill-in" or "insert" data into the CW/RTTY message

	stream. It is recommended to be used only in synchronous mode to ensure that the characters are inserted in the right place. WARNING: strMessage can only contain text data (no variables or script calls). It is <i>not</i> interpreted by the CW/RTTY parser (except for +/- speed bursts).
<b>wtKeyer:Play (Message)</b>	Message is a plain string to be played, a saved message ( <b>\$F1</b> etc.) or a variable ( <b>\$xxx</b> ). The word space between the string arguments will be omitted if they end with a "~".
<b>wtKeyer:PlayAdditionalMsg (AdditionalMsgIndex)</b>	Play the additional CW/RTTY messages (Alt-C set)
<b>wtKeyer:SetCwSpeed (Speed)</b>	Set CW speed in wpm.
<b>wtKeyer:Stop ()</b>	Stop the current message

**Class wtMicroham**

<b>wtMicroham:GetDeviceId ()</b>	Return the ID of the microHAM attached device (see <a href="#">microHAM Device IDs</a> ).
<b>wtMicroham:GetFirmwareVersion ()</b>	Return the firmware version string of the microHAM attached device.
<b>wtMicroham:Send (strCommand)</b>	Send a command string to the microHAM attached device. The trailing <CR> character is optional, and is appended if needed.

**Class wtOp**

<b>wtOp:GetCallsign ()</b>	Return the current op callsign
<b>wtOp:GetNick ()</b>	Return the current op nick

**Class wtOtrsp**

<b>wtOtrsp:GetDeviceName ()</b>	Returns the name of the OTRSP attached device.
<b>wtOtrsp:GetFirmwareVersion ()</b>	Returns the firmware version of the OTRSP attached device. NOTE: Some devices do not support this API, and return an empty string.
<b>wtOtrsp:Send (strCommand)</b>	Sends a command string to the OTRSP attached device. The trailing <CR> character is optional, and is appended if needed.

## Class wtQso

<code>wtQso:IsCallsignEmpty()</code>	Return a boolean : True if the callsign field of the active QSO is empty
<code>wtQso:IsCallsignIncomplete()</code>	Return a boolean : True if the callsign field of the active QSO contains a "?"
<code>wtQso:IsExchangeEmpty()</code>	Return a boolean : True if the exchange field of the active QSO is empty
<code>wtQso:IsExchangeSent()</code>	Return a boolean : True if the exchangeSent flag of the active QSO is set
<code>wtQso:IsModeCW()</code>	Return a boolean : True if the mode of active QSO is CW
<code>wtQso:IsModeDigital()</code>	Return a boolean : True if the mode of active QSO is digital
<code>wtQso:SetExchangeSent()</code>	Set the exchangeSent flag of the active QSO (see <code>wtQso:IsExchangeSent()</code> ) - Similar to the use of <b>\$SETEXCHSENT</b>
<code>wtQso:ResetExchangeSent()</code>	Reset the exchangeSent flag of the active QSO (see <code>wtQso:IsExchangeSent()</code> ) - Similar to the use of <b>\$RSTEXCHSENT</b>
<code>wtQso:ClearStatus()</code>	Clear the status flags of the active QSO
<code>wtQso:GetData()</code>	Returns a LUA table object with fields of the current QSO. The current available keys are "time", "band", "mode", "freq", "callsign", "rstSent", "serialSent", "rstReceived", "exchReceived", "miscInfoReceived", "miscInfo2Received", "nQSONum", "stnName" and "stnFlags"; e.g. qsoData = wtQso:GetData(), then wtQso:GetData["time"] returns "17:03" or similar.
<code>wtQso:GetIniFileName()</code>	Returns File Name if INI file.
<code>wtQso:GetLogFileName()</code>	Returns Log File Name.
<code>wtQso:GetModeId()</code>	Return the mode ID of the active QSO (see <a href="#">Supported mode IDs</a> ).
<code>wtQso:IsCallsignRepeated()</code>	Return a boolean. True if the callsign hasn't changed since the last Enter
<code>wtQso:IsOperatingModeRun()</code>	Return a boolean. True if the operating mode of the active QSO is RUN (and False if S&P)
<code>wtQso:IsModePhone()</code>	Return a boolean. True if the mode of the active QSO is Phone (SSB and FM), and False otherwise
<code>wtQso:IsQsoApproved()</code>	Return a boolean. True if all requested fields of the active QSO are filled (contest dependent)

<code>wtQso:IsDupe()</code>	Return a boolean. True if the current callsign is a dupe
<code>wtQso:IsCurrentFieldCallsign()</code>	Return a boolean : True if the current field is the callsign field
<code>wtQso:IsCurrentFieldExchange()</code>	Return a boolean : True if the current field is an exchange field
<code>wtQso:IsCurrentFieldOther()</code>	Return a boolean : True if the current field is not the callsign field or an exchange field
<code>wtQso:IsCurrentFieldEmpty()</code>	Return a boolean : True if the current field is empty (except RST for the exchange field)
<code>wtQso:IsCurrentFieldPrimaryRadio()</code>	Return a boolean : True if the current field is in the primary radio (main log)
<code>wtQso:IsCurrentFieldSecondaryRadio()</code>	Return a boolean : True if the current field is in the secondary radio

**Class wtRadio\***

The following generic functions can be applied to: **wtRadio** (the active one), **wtRadioInactive** (the non-active one), **wtRadioPrimary** (the one that is in the main log wnd) **wtRadioSecondary** (the one that is in the secondary log wnd) **wtRadio1** and **wtRadio2**.

WARNING: Some functions may not work because of the CAT protocol or radio hardware limitations.

<code>wtRadio*:GetFreq()</code>	Return freq of the active VFO of the designated radio freq is expressed in kHz
<code>wtRadio*:GetFreq(NVfo)</code>	Return freq of the designated VFO (0 => VFO A, 1 => VFO B) of the designated radio freq is expressed in kHz
<code>wtRadio*:GetFreqInactiveVfo()</code>	Return freq of the inactive VFO of the designated radio freq is expressed in kHz
<code>wtRadio*:GetTypeId()</code>	Return type of radio (see <a href="#">Radio Types</a> )
<code>wtRadio*:GetManufacturerId()</code>	Return manufacturer of radio (see <a href="#">Radio Manufacturer Constants</a> )
<code>wtRadio*:SetFreq(freq)</code>	Set freq of the active VFO of the designated radio freq is expressed in kHz
<code>wtRadio*:SetFreq(freq, nVfo)</code>	Set freq of the designated VFO (0 => VFO A, 1 => VFO B) of the designated radio freq is expressed in kHz
<code>wtRadio*:SetFreqInactiveVfo(freq)</code>	Set freq of the inactive VFO of the designated radio freq is expressed in kHz
<code>wtRadio*:SetFreqSubVfo(freq)</code>	Set freq of the sub VFO of the designated radio freq is expressed in kHz

<code>wtRadio*:SetSplit(freq)</code>	Set split ON and the split frequency on the designated radio freq is expressed in kHz
<code>wtRadio*:ResetSplit()</code>	Reset split on the designated radio
<code>wtRadio*:IsSplit()</code>	Return false or true whether the split is set or not on the designated radio
<code>wtRadio*:GetRadioId()</code>	Return the radioID (0 => RADIO_1, 1 => RADIO_2) of the designated radio
<code>wtRadio*:Send(catString)</code>	Send the ASCII catString to the designated radio
<code>wtRadio*:SendHex(hexString)</code>	Send the hexString to the designated radio. The hexString must contain only 0-9 and A-F characters and must have an even length. Ex "02DFA8" etc.

NOTE: `wtRadio*:SetFreq(fFreq)` and `wtRadio*:SetFreq(fFreq, nVfo)` ignore the frequency if it is outside of any band, and return with no error message.

### Class wtScript

<code>wtScript:AssignArgument()</code>	function now takes the strings "true" and "false" as boolean arguments. Numeric values do not require double quotes. More details needed.
<code>wtScript:AssignFKey()</code>	assigns a function to an function key. More details needed.
<code>wtScript:AssignKeyCode()</code>	assigns a key code. More details needed.

### Class wtStatus

<code>wtStatus:GetList()</code>	Returns a table with names of the stations in the network
<code>wtStatus:GetStatus(strStation)</code>	returns a table with fields of the status of a given station. Returns nil if this station doesn't exist. The table keys are "band" "mode" "currentRadio" "radio1Freq" "radio2Freq" "radio1IsManual" "radio2IsManual" "passFreq" "type" and "qsyStatusId".
<code>wtStatus:GetFreq(strBand[, strMode])</code>	returns the "best" pass freq for a given band and mode. To determine this frequency, it uses the same algorithm as the \$FREQnn variable
<code>wtStatus:GetMyStation()</code>	returns the station number.

### Win-Test API Variables

- **wtArg**: get the optional argument set in the Script Manager or in a **#SCRIPT(argument)** call. **wtArgument** is also provided for backward compatibility. Both variables are local to the script called.
- **wtCurrentScript**: contains the script name currently executed, without extension
- **wtRootScript**: contains the name of the top-most called script, without extension

## Win-Test API Constants

The most current list of Win-Test API Constants may be found at <http://download.win-test.com/v4/lua/constants.wts>.

Constants are not guaranteed to remain constant in Lua, that is, a program can update these variables. Any constant could be accidentally reassigned to refer to some other object or value. Unfortunately, there is no easy way to generate code that prevents this. You will just have to be careful. Avoid creating variable names starting with WT\_.

### Child window IDs

```

WT_WND_SUMMARY = 0;
WT_WND_GRIDSSQUAREMAP = 1;
WT_WND_CHECKPARTIAL = 2;
WT_WND_RATESHEET = 3;
WT_WND_CLOCK = 4;
WT_WND_VUMETER = 5;
WT_WND_RATE = 6;
WT_WND_GAB = 7;
WT_WND_MAP = 8;
WT_WND_CHECKCOUNTRY = 9;
WT_WND_ZONE = 10;
WT_WND_MULT = 11;
WT_WND_NP1 = 12;
WT_WND_RADIO1 = 13;
WT_WND_RADIO2 = 14;
WT_WND_PACKETCLUSTER = 15;
WT_WND_DXCLUSTERANN = 16;
WT_WND_SOLAR = 17;
WT_WND_PARTNER = 18;
WT_WND_STATUS = 19;
WT_WND_SKED = 20;
WT_WND_CHECKCALL = 21;
WT_WND_SECONDARYRADIO = 22;
WT_WND_RTTY1 = 23;
WT_WND_RTTY2 = 24;
WT_WND_QSYWIZARD = 25;
WT_WND_EXTRAINFO = 26;
WT_WND_ZONE2 = 27;
WT_WND_ROTATORS = 28;
WT_WND_CONTESTRECORDER = 29;

```

### Supported contest IDs

```

WT_CONTEST_IARU_VHF = 1;
WT_CONTEST_IARU_UHF = 2;
WT_CONTEST_IARU_CW = 3;
WT_CONTEST_IARU_HF = 4;
WT_CONTEST_IARU_R1_50MHZ = 5;
WT_CONTEST_REF_THF = 10;
WT_CONTEST_REF_DDFM_50MHZ = 11;
WT_CONTEST_THF_EU = 20;
WT_CONTEST_THF_EU_50_70 = 21;
WT_CONTEST_THF_EU_GRIDSSQUARE = 30;
WT_CONTEST_THF_EU_GRIDSSQUARE_50_70 = 31;
WT_CONTEST_THF_EU_GRIDSSQUARE_NO_DIST = 32;
WT_CONTEST_THF_EU_GRIDSSQUARE_NO_DIST_50_70 = 33;
WT_CONTEST_REF_HF = 100;

```

## Win-Test Wiki

```
WT_CONTEST_ARRL_DX = 101;
WT_CONTEST_ARRL_10 = 102;
WT_CONTEST_ARRL_160 = 103;
WT_CONTEST_ARRL_SWEEPSTAKES = 104;
WT_CONTEST_ARRL_FD = 105;
WT_CONTEST_ARRL_RU = 106;
WT_CONTEST_ARRL_UHF_AUG = 130;
WT_CONTEST_ARRL_VHF_JAN = 131;
WT_CONTEST_ARRL_VHF_JUN = 132;
WT_CONTEST_ARRL_VHF_SEP = 133;
WT_CONTEST_REF_160 = 150;
WT_CONTEST_CQWW_DX = 200;
WT_CONTEST_CQWW_WPX = 201;
WT_CONTEST_CQWW_160 = 202;
WT_CONTEST_CQWW_VHF = 250;
WT_CONTEST_RDXC = 300;
WT_CONTEST_RDAC = 301;
WT_CONTEST_CIS = 302;
WT_CONTEST_R_160 = 303;
WT_CONTEST_RRTC = 304;
WT_CONTEST_RAEM = 305;
WT_CONTEST_DXPEDITION_HF = 400;
WT_CONTEST_DXPEDITION_VHF = 410;
WT_CONTEST_ALL_ASIAN = 500;
WT_CONTEST_SPDXC = 600;
WT_CONTEST_JIDX = 700;
WT_CONTEST_KCJ = 701;
WT_CONTEST_KCJ_TOPBAND = 702;
WT_CONTEST_YUDXC = 800;
WT_CONTEST_CQM = 900;
WT_CONTEST_ARI = 1000;
WT_CONTEST_ARI_SEZIONI = 1001;
WT_CONTEST_ARI_40_80 = 1002;
WT_CONTEST_BALTIC = 1100;
WT_CONTEST_KING_OF_SPAIN = 1200;
WT_CONTEST_IOTA = 1300;
WT_CONTEST_RSGB_160 = 1301;
WT_CONTEST_RSGB_80_CC = 1302;
WT_CONTEST_RSGB_CMW = 1303;
WT_CONTEST_RSGB_15_10 = 1304;
WT_CONTEST_RSGB_AFS = 1305;
WT_CONTEST_WAEDC = 1400;
WT_CONTEST_WAG = 1401;
WT_CONTEST_DARC_XMAS = 1402;
WT_CONTEST_DARC_10 = 1403;
WT_CONTEST_YODXC = 1500;
WT_CONTEST_EU_HF = 1600;
WT_CONTEST_SCC = 1601;
WT_CONTEST_OCDXC = 1700;
WT_CONTEST_TOECC = 1800;
WT_CONTEST_SAC = 1900;
WT_CONTEST_NRAU_BALTIC = 1901;
WT_CONTEST_NAC = 1902;
WT_CONTEST_SARTG = 1903;
WT_CONTEST_QP_TX = 2000;
WT_CONTEST_EU_SPRINT = 2100;
WT_CONTEST_UKDXC = 2200;
WT_CONTEST_OKOMDXC = 2300;
WT_CONTEST_STEW_PERRY = 2400;
WT_CONTEST_GACW_DX = 2401;
WT_CONTEST_NINE_KCC_15 = 2402;
WT_CONTEST_FOC_MARATHON = 2403;
```



## Win-Test Wiki

```
WT_CONTEST_LOTW = 2404;
WT_CONTEST_AP_SPRINT = 2405;
WT_CONTEST_JARTS = 2406;
WT_CONTEST_MARCONI_HF = 2407;
WT_CONTEST_LZDX = 2500;
WT_CONTEST_CROATIAN_CW = 2600;
WT_CONTEST_UBADX = 2700;
WT_CONTEST_UBA_SPRING_80M = 2701;
WT_CONTEST_UBA_SPRING_6M = 2702;
WT_CONTEST_UBA_SPRING_2M = 2703;
WT_CONTEST_ON_80M = 2704;
WT_CONTEST_ON_6M = 2705;
WT_CONTEST_ON_2M = 2706;
WT_CONTEST_RAC_DAY = 2800;
WT_CONTEST_RAC_WINTER = 2801;
WT_CONTEST_PACC = 2900;
WT_CONTEST_HELVETIA = 3000;
WT_CONTEST_HELVETIA_VHF = 3001;
WT_CONTEST_IARU_FD_R1_GENERIC = 3100;
WT_CONTEST_IARU_FD_R1_DARC = 3101;
WT_CONTEST_IARU_FD_R1_RSGB = 3102;
WT_CONTEST_UFT_HF = 3200;
WT_CONTEST_AGCW_HNY = 3300;
WT_CONTEST_HA_DX = 3400;
WT_CONTEST_NAQP = 3500;
WT_CONTEST_NA_SPRINT = 3501;
WT_CONTEST_NCCC_SPRINT = 3600;
WT_CONTEST_CQIR = 3700;
```

### Supported mode IDs

```
WT_MODE_CW = 0;
WT_MODE_SSB = 1;
WT_MODE_RTTY = 2;
WT_MODE_FM = 3;
WT_MODE_PSK = 4;
WT_MODE_PKT = 5;
WT_MODE_HELL = 6;
WT_MODE_SAT = 7;
```

### Status key IDs

```
WT_KEY_NONE = 0;
WT_KEY_SHIFT = 1;
WT_KEY_ALT = 2;
WT_KEY_CTRL = 4;
```

### Radio Constants

```
WT_RADIO_MAX = 2;

WT_RADIO_VFOA = 0;
WT_RADIO_VFOB = 1;

WT_RADIO_1 = 0;
WT_RADIO_2 = 1;
```

## Radio Manufacturer Constants

```

WT_RADIO_MANUFACTURER_UNKNOWN = 0;
WT_RADIO_MANUFACTURER_ICOM = 1;
WT_RADIO_MANUFACTURER_YAESU = 2;
WT_RADIO_MANUFACTURER_KENWOOD = 3;
WT_RADIO_MANUFACTURER_TENTEC = 4;
WT_RADIO_MANUFACTURER_ELECRAFT = 5;
WT_RADIO_MANUFACTURER_FLEXRADIO = 6;

```

## Radio Types

```

WT_RADIO_UNKNOWN = -1;
WT_RADIO_NONE = 0;
WT_RADIO_KENWOOD = 1;
WT_RADIO_IC703 = 1703;
WT_RADIO_IC706 = 1706;
WT_RADIO_IC706MkII = 17061;
WT_RADIO_IC706MkIIG = 17062;
WT_RADIO_IC718 = 1718;
WT_RADIO_IC725 = 1725;
WT_RADIO_IC728 = 1728;
WT_RADIO_IC729 = 1729;
WT_RADIO_IC735 = 1735;
WT_RADIO_IC736 = 1736;
WT_RADIO_IC738 = 1738;
WT_RADIO_IC737 = 1737;
WT_RADIO_IC746 = 1746;
WT_RADIO_IC746Pro = 17761;
WT_RADIO_IC751 = 1751;
WT_RADIO_IC756 = 1756;
WT_RADIO_IC756Pro = 17561;
WT_RADIO_IC756ProII = 17562;
WT_RADIO_IC756ProIII = 17563;
WT_RADIO_IC761 = 1761;
WT_RADIO_IC765 = 1765;
WT_RADIO_IC775 = 1775;
WT_RADIO_IC781 = 1781;
WT_RADIO_IC275 = 1275;
WT_RADIO_IC475 = 1475;
WT_RADIO_IC1275 = 11275;
WT_RADIO_IC910 = 1910;
WT_RADIO_IC7000 = 17000;
WT_RADIO_IC7600 = 17600;
WT_RADIO_IC7700 = 17700;
WT_RADIO_IC7800 = 17800;
WT_RADIO_ICGENERIC = 1000;
WT_RADIO_FT1000MP = 2110;
WT_RADIO_FT1000 = 2100;
WT_RADIO_FT2000 = 2200;
WT_RADIO_FT990 = 2099;
WT_RADIO_FT920 = 2092;
WT_RADIO_FT100 = 2010;
WT_RADIO_FT847 = 20847;
WT_RADIO_FT900 = 2090;
WT_RADIO_FT897 = 20897;
WT_RADIO_FT817 = 20817;
WT_RADIO_FT857 = 20857;
WT_RADIO_FT757GXII = 207572;
WT_RADIO_FTDX9000 = 2900;
WT_RADIO_FT450 = 2450;

```

```

WT_RADIO_FT950 = 2950;
WT_RADIO_ORION = 3000;
WT_RADIO_OMNI6 = 3001;
WT_RADIO_JUPITER = 3002;
WT_RADIO_OMNI7 = 3003;
WT_RADIO_ORION_II = 3004;
WT_RADIO_SDR1000 = 4000;
WT_RADIO_K2 = 5000;
WT_RADIO_K3 = 5001;
WT_RADIO_OMNIRIG = 6000;

```

## microHAM Device IDs

```

WT_MICROHAM_NONE = 0;
WT_MICROHAM_MK = 1;
WT_MICROHAM_MKII = 2;
WT_MICROHAM_MK2R = 10;
WT_MICROHAM_MK2R_PLUS = 11;
WT_MICROHAM_MICRO_2R = 12;

```

## Advanced Programming Examples

### ESM Script (embedded into Win-Test)

For convenience, you can find below the current ESM (Enter Sends Message) embedded script. Note that the real returned values are somewhat different from the ones described above, because of the nature of this script (embedded), but it is a good source of inspiration for your own masterpiece. As Lua is an interpreted language, the good news is that you can edit your script while WT is running. No need to exit WT, enter modifications, and start WT again. Just edit `esm.wts` while WT is running, save it, and try it immediately!

The script assumes the following messages have been programmed into the [Standard CW messages](#) dialog:

---

```

F1 => CQ
F2 => RST + Exchange
F3 => TU
F4 => $MYCALL
F5 => $LOGGED
F7 => ? or Again (Phone)
INSERT => Sends exchange (CW and RTTY)
PLUS => TU and Log the QSO

```

---

Here is the source code for **esm.wts**. To change the behavior, save it in the Win-Test scripts directory (File | Explore | /scripts directory), then edit it.

```

-- v1.2 All variables in messages replaced by keypresses
-- v1.1 Dupes taken into account in the S&P mode
-- v1.0 Initial version

-- Send functions

function sendCq()
    wtQso:ResetExchangeSent();
    wtApp:SendFKey("F1"); -- Always use the function key
end;

```

## Win-Test Wiki

```
function sendExchangeRun()
    wtApp:SendFKey(wtQso:IsModePhone() and "F2" or "INSERT"); -- Ternary Operator
    wtQso:SetExchangeSent();
end;

function sendExchangeAgain()
    if (wtQso:IsModePhone()) then
        wtApp:SendFKey("F2");
    else
        wtApp:SendFKey("F5"); -- $LOGGED
        wtApp:SendFKey("F7"); -- ?
    end;
end;

function sendTu()
    wtApp:SendFKey("PLUS");
    wtQso:ClearStatus();
end;

function sendQuestionMark()
    wtQso:ResetExchangeSent();
    wtApp:SendFKey("F7"); -- Again ?
end;

function sendMyCall()
    wtApp:SendFKey("F4"); -- My call
end;

function sendExchangeSAndP()
    wtApp:SendFKey("F2");
    wtQso:SetExchangeSent();
end;

-- ESM core code

-- Return 0 (or return nothing) if we want the CR
-- to be processed also by WT (ie log QSO) and -1 if not.

if (wtQso:IsOperatingModeRun()) then -- Run
    if (wtContest:IsExchangeRequired()) then -- Usual contests
        if (wtQso:IsExchangeEmpty() or not wtQso:IsQsoApproved()) then
            if (wtQso:IsCallsignEmpty()) then
                sendCq();
            else
                if (wtQso:IsCallsignRepeated()) then
                    sendExchangeAgain();
                else
                    sendExchangeRun();
                end;
            end;
        else
            if (wtQso:IsExchangeSent()) then
                sendTu();
            else
                sendExchangeRun();
            end;
        end;
    else -- DXPed etc.
        if (not wtQso:IsQsoApproved()) then
            if (wtQso:IsCallsignEmpty()) then
                sendCq();
            end;
        end;
    end;
end;
```

## Win-Test Wiki

```
else
    if (wtQso:IsCallsignRepeated()) then
        sendExchangeAgain();
    else
        sendExchangeRun();
    end;
end;
else
    if (wtQso:IsExchangeSent()) then
        sendTu();
    else
        sendExchangeRun();
    end;
end;
end;
else -- S&P : The automatic exchange fill (if enabled) is disabled by WT
    if ( (wtQso:IsExchangeEmpty() and wtContest:IsExchangeRequired())
        or not wtQso:IsQsoApproved() ) then
        if (wtQso:IsCallsignEmpty()) then
            sendQuestionMark();
        else
            if (not wtQso:IsDupe()) then -- Call only if not dupe
                sendMyCall();
            end;
        end;
    else
        if (wtQso:IsExchangeSent()) then
            wtQso:ClearStatus();
            return 0; -- Log it silently
        else
            if (not wtQso:IsDupe()) then -- Sent exchange only if not dupe
                sendExchangeSAndP();
            end;
        end;
    end;
end;
end;
return -1; -- This script overrides the Win-Test CR process
```

### Alternative ESM Script (provided by F5VIH/SV3SJ)

At the top of the script you will find a variable setting:

```
shortcq = false;
```

Setting it to true, it will convert the CQ calling and the TU part of the QSO in short forms (a la 5b4agn) and the exact contents of the messages are defined in the two lines that follow the shortcq setting. I have also added the possibility to have an exchange filled in and no call (in that case the script sends CL?)

I must say I am very impressed by the functionality that WT opens to the users with lua scripts. I would really like to see more API calls made available and WT functions using scripts (programmable keys, even SO2R, etc).

In the mean time if you have suggestions to improve the script let me know. I can easily include them.

```
-----
-- Wintest ESM - Nick, F5VIH/SV3SJ
-- Set "shortCQ to true or false
-----
```

```

shortcq = false;
shortCQ = "$MYCALL";
shortTU = "$CORRECT ++TU-- $CR";

-- Send functions

function sendCq()
  wtQso:ResetExchangeSent();
  if (wtQso:IsModePhone()) then
    wtApp:SendFKey("F1");
  else
    if (shortcq) then
      wtKeyer:Play(shortCQ);
    else
      wtApp:SendFKey("F1"); -- Always use the function key
    end;
  end;
end;

function sendExchangeRun()
  if (wtQso:IsModePhone()) then
    wtApp:SendFKey("F2");
    wtKeyer:Play("$CR");
  else
    wtKeyer:Play("$INSERT");
  end;
  wtQso:SetExchangeSent();
end;

function sendExchangeAgain()
  if (wtQso:IsModePhone()) then
    wtApp:SendFKey("F2");
  else
    wtKeyer:Play("$F5 $F7"); -- $LOGGED ?
  end;
end;

function sendTu()
  if (wtQso:IsModePhone()) then
    if (shortcq) then
      wtKeyer:Play("$CR");
      wtApp:SendFKey("F5");
    else
      wtApp:SendFKey("PLUS");
    end;
  else
    if (shortcq) then
      wtKeyer:Play(shortTU);
    else
      wtKeyer:Play("$PLUS");
    end;
  end;
  wtQso:ClearStatus();
end;

function sendQuestionMark()
  wtQso:ResetExchangeSent();
  if (wtQso:IsModePhone()) then
    wtApp:SendFKey("F7"); -- Again ?
  else
    wtKeyer:Play("$F7");
  end;
end;

```

## Win-Test Wiki

```
end;

function sendMyCall()
  if (wtQso:IsModePhone()) then
    wtApp:SendFKey("F4"); -- My call
  else
    wtKeyer:Play("$F4");
  end;
end;

function sendExchangeSAndP() -- Sends appropriate exchange when in S&P mode
  if (wtQso:IsModePhone()) then
    wtApp:SendFKey("F2"); -- 5NN EXCHANGE
  else
    wtKeyer:Play("$F2");
  end;
  wtQso:SetExchangeSent();
end;

function sendAskForCall()
  if (wtQso:IsModePhone()) then
    wtApp:SendFKey("F7"); -- AGN
  else
    wtKeyer:Play("CL?");
  end;
end;

function askForNumber()
  if (wtQso:IsModePhone()) then
    wtApp:SendFKey("F6"); -- NR AGN
  else
    wtKeyer:Play("$F6");
  end;
end;

function askWithPartialCall()
  if (wtQso:IsModePhone()) then
    wtApp:SendFKey("F7"); -- AGN
  else
    wtKeyer:Play("$F5 ?");
  end;
end;

-- ESM core code

-- Return 0 (or return nothing) if we want the CR
-- to be processed also by WT (ie log QSO) and -1 if not.

if (wtQso:IsOperatingModeRun()) then -- Run Mode
  if (wtContest:IsExchangeRequired()) then -- Usual contests requiring an exchange
    if (wtQso:IsCallsignEmpty()) then
      if (wtQso:IsExchangeEmpty()) then
        sendCq();
      else -- we ve got an exchange but not a call, ask for the call
        sendAskForCall();
      end;
    else -- call is not empty
      if (wtQso:IsExchangeSent()) then -- we have sent the exchange
        if (not wtQso:IsQsoApproved()) then
          if (wtQso:IsCurrentFieldCallsign() and not wtQso:IsExchangeEmpty()) then
            askWithPartialCall();
          end;
        end;
      end;
    end;
  end;
end;
```

## Win-Test Wiki

```
if (wtQso:IsCurrentFieldCallsign() and wtQso:IsExchangeEmpty()) then
  wtQso:ResetExchangeSent();
  sendExchangeRun();
  if (wtQso:IsCurrentFieldCallsign()) then wtKeyer:Play("$SPACEBAR") end;
end;
if (wtQso:IsCurrentFieldExchange() and wtQso:IsExchangeEmpty()) then
  askForNumber();
end;
else -- qso has valid call and exchange
  if (wtQso:IsCurrentFieldExchange()) then
    sendTu();
  else -- current field is not exchange (should be callsign)
    if (wtQso:IsCurrentFieldCallsign()) then
      wtQso:ResetExchangeSent();
      sendExchangeRun();
      if (wtQso:IsCurrentFieldCallsign()) then wtKeyer:Play("$SPACEBAR") end;
    end;
  end;
end;

else -- have not sent exchange and we are in the call field
  sendExchangeRun();
  if (wtQso:IsCurrentFieldCallsign()) then wtKeyer:Play("$SPACEBAR") end;
end;
end;

else -- The contest doesnt require an exchange to be received e.g. DXPed etc.
  if (not wtQso:IsQsoApproved()) then
    if (wtQso:IsCallsignEmpty()) then
      sendCq();
    else
      if (wtQso:IsCallsignRepeated()) then
        sendExchangeAgain();
      else
        sendExchangeRun();
      end;
    end;
  end;
else
  if (wtQso:IsExchangeSent()) then
    sendTu();
  else
    sendExchangeRun();
  end;
end;
end;

else -- S&P : The automatic exchange fill (if enabled) is disabled by WT
  if ( (wtQso:IsExchangeEmpty() and wtContest:IsExchangeRequired()) or not wtQso:IsQsoApproved() )
    if (wtQso:IsCallsignEmpty()) then
      sendQuestionMark();
    else
      if (not wtQso:IsDupe()) then -- Call only if not dupe
        sendMyCall();
      end;
    end;
  end;
else
  if (wtQso:IsExchangeSent()) then
    wtQso:ClearStatus();
    wtKeyer:Play("$CR");
    return -1; -- Log it silently
  else
    if (not wtQso:IsDupe()) then -- Sent exchange only if not dupe
```



```
        sendExchangeSAndP ();
    end;
end;
end;
end;

return -1; -- This script overrides the Win-Test CR process
```

### Grab next call from partner window

The following script was kindly provided by Hank Lonberg, KR7X. It remaps the [~] key to grab the next callsign from the partner window and send an exchange.

```
wtKeyer:Play("$CORRECT TU $CR NOW $GRABPARTNER $NEXT $GUESSEXCH $F2 $13");
```

### Re-map [Ã ] key with /P for Field Day

Practical in Field Day where a lot of stations are signing "/P" - especially with a German keyboard layout.

```
-- add /P to a callsign for Field Day operations
wtApp:SendKeyCode(47);
wtApp:SendKeyCode(112);
```

### Change background of Main Window depeing on RUN/S&P Mode

The idea to this script was provided by GW3NJW. Name this script **RunSPSwitch.wts** and have it assigned to **Ctrl-Tab**

```
if (wtApp:IsPostKeyProcess()) then
    if (wtQso:IsOperatingModeRun()) then
        wtApp:SetWindowColor(-1, 0, 165, 165);
    else
        wtApp:SetWindowColor(-1, 128,128,128);
    end;
else
    return 1; -- Triggers a post key process call
end;
```

## Namespaces

- [Page](#)
- [Discussion](#)

## Variants

## Views

- [Read](#)
- [View source](#)
- [View history](#)

## More

- This page was last edited on 30 December 2021, at 12:51.

- [Privacy policy](#)
- [About Win-Test Wiki](#)
- [Disclaimers](#)



# API

From Win-Test Wiki

[Jump to navigation](#) [Jump to search](#)

## Contents

- [1 List of Win-Test API Functions](#)
  - ◆ [1.1 Class wtApp](#)
  - ◆ [1.2 Class wtContest](#)
  - ◆ [1.3 Class wtGab](#)
  - ◆ [1.4 Class wtKeyer](#)
  - ◆ [1.5 Class wtMicroham](#)
  - ◆ [1.6 Class wtOp](#)
  - ◆ [1.7 Class wtOtrsp](#)
  - ◆ [1.8 Class wtQso](#)
  - ◆ [1.9 Class wtRadio\\*](#)
  - ◆ [1.10 Class wtScript](#)
  - ◆ [1.11 Class wtStatus](#)
- [2 Win-Test API Variables](#)
- [3 Win-Test API Constants](#)
  - ◆ [3.1 Child window IDs](#)
  - ◆ [3.2 Supported contest IDs](#)
  - ◆ [3.3 Supported mode IDs](#)
  - ◆ [3.4 Status key IDs](#)
  - ◆ [3.5 Radio Constants](#)
  - ◆ [3.6 Radio Manufacturer Constants](#)
  - ◆ [3.7 Radio Types](#)
  - ◆ [3.8 microHAM Device IDs](#)
- [4 Advanced Programming Examples](#)
  - ◆ [4.1 ESM Script \(embedded into Win-Test\)](#)
  - ◆ [4.2 Alternative ESM Script \(provided by F5VIH/SV3SJ\)](#)
  - ◆ [4.3 Grab next call from partner window](#)
  - ◆ [4.4 Re-map \[Å \] key with /P for Field Day](#)
  - ◆ [4.5 Change background of Main Window depending on RUN/S&P Mode](#)

## List of Win-Test API Functions

Compiled from information found on the WT reflector on October 7, 2009 ([\[1\]](#), [\[2\]](#)).

The most current API documentation from the Win-Test developers may be found at <http://download.win-test.com/v4/lua/LuaApiDoc.txt>.

### Class wtApp

<code>wtApp:AlertBox (Text)</code>	Opens a standard Windows alert box with the specified text and an [OK] button.
<code>wtApp:CallScript (strScript [, arg])</code>	Call a wts script (no extension required in strScript). Can return a number only (or nothing). Optional

## Win-Test Wiki

	argument's value can be accessed via wtArg in the called script.
<code>wtApp: GetAppPath ()</code>	Win-Test installation directory path
<code>wtApp: GetCfgPath ()</code>	\cfg directory path
<code>wtApp: GetCtyPath ()</code>	\countryFiles directory path
<code>wtApp: GetDatabasePath ()</code>	\databases directory path
<code>wtApp: GetExtraPath ()</code>	\extras directory path
<code>wtApp: GetIniFileName ()</code>	Return the name of the current .ini file, including the ".ini" extension. Usually returns "wt.ini" unless overridden via the -i command line argument.
<code>wtApp: GetKeyState ()</code>	Returns the modifiers keys status when the function is called.
<code>wtApp: GetLastError ()</code>	Return the Windows last-error code value when using PostMessage or SendMessage. Can be useful to debug such statements.
<code>wtApp: GetLogFileName ()</code>	Return the name of the current log file, including the ".wt4" extension
<code>wtApp: GetLogPath ()</code>	Current log directory path
<code>wtApp: GetOpPath ()</code>	\ops directory path
<code>wtApp: GetScriptPath ()</code>	\scripts directory path
<code>wtApp: InputInteger (Prompt, Title, Default)</code>	If Prompt is empty, it defaults to "Enter an integer". If Title is empty, it defaults to "Win-Test script". If a default value is specified, the pop-up window is pre-filled with the specified integer value.
<code>wtApp: InputNumber (Prompt, Title, Default)</code>	If Prompt is empty, it defaults to "Enter a number". If Title is empty, it defaults to "Win-Test script". If a default value is specified, the pop-up window is pre-filled with the specified number value. In LUA, a "number" data type may or may not contain a decimal point.
<code>wtApp: InputText (Prompt, Title, Default)</code>	If Prompt is empty, it defaults to "Enter a text". If Title is empty, it defaults to "Win-Test script". If a default value is specified, the pop-up window is pre-filled with the specified text.
<code>wtApp: InputUpperText (Prompt, Title, Default)</code>	Same as wtApp:InputText, but all text is converted to uppercase.
<code>wtApp: IsCapsLock ()</code>	Returns <b>true</b> if the [ <b>Caps Lock</b> ] key is enabled and the secondary radio window is highlighted, otherwise returns <b>false</b> .

<code>wtApp:IsPostKeyProcess ()</code>	Returns <b>true</b> if the current script is being executed after the assigned key has been processed by WT, otherwise returns <b>false</b> .
<code>wtApp:MessageBox (Text, Type, Title)</code>	<p>Display a Message box with the specified text, using the specified type and message box title (shown in the title bar of the message box window). See also <code>wtApp:AlertBox()</code>. Type 0 is an ordinary message box with an [OK] button, type 1 has both an [OK] and a [Cancel] button. The return code indicates the button pressed by the user (which may be ignored). Return code 1 means the [OK] button was pressed, return code 2 means the [Cancel] button was pressed.</p> <p>See the <a href="#">Microsoft Windows MessageBox API documentation</a> for more details about supported message box types and return codes.</p>
<code>wtApp:PostMessage (strTitle, strClass, nMsg, nWParam, nLParam[, strLParam])</code>	<p>Place (post) a message in the message queue associated with the thread that created the specified window and returns without waiting for the thread to process the message.</p> <p>strTitle : Title of the target window  strClass : Specifies the window class name of the child window (must be empty if unused)  nMsg : Message to be posted  nWParam : Additional message-specific information (use 0 if unused)  nLParam : Additional message-specific information (use 0 if unused)  strLParam : String as additional message-specific information</p>
<code>wtApp:ResetCapsLock ()</code>	Disables the <b>[Caps Lock]</b> key. Normally used to change focus to the primary radio window when <u>Caps Lock binds to the secondary radio</u> is enabled
<code>wtApp:SendAltKey (Key)</code>	Key is a letter, a number, or a function key ("F1".. "F12" + "Insert" + "Plus" + "Esc")
<code>wtApp:SendCtrlKey (Key)</code>	Key is a letter, a number, or a function key ("F1".. "F12" + "Insert" + "Plus" + "Esc")
<code>wtApp:SendFKey (Key [, ModifierKeys])</code>	Send Functions keys (and Insert and Plus). Key is one of "F1".. "F12" + "Insert" + "Plus" + "Esc". ModifierKeys (optional) indicates the modifier keys (Ctrl = 4, Alt = 2, Shift = 1, None = 0 - can be combined via addition, e.g., 6 = Ctrl+Alt). If this argument is missing or -1, the current modifier keys are used.

<b>wtApp:SendKey(Key [, ModifiersKeys])</b>	<p>Send key or string. Key is a single character or a string. ModifiersKeys (optional) indicates the modifiers keys (Ctrl = 4, Alt = 2, Shift = 1, None = 0 - can be combined via addition, e.g., 6 = Ctrl+Alt). If this argument is missing or -1, the current modifiers keys are used.</p>
<b>wtApp:SendKeyCode(Code [, ModifierKeys])</b>	<p>Send a key by its ASCII code. Keycode is an ASCII code. ModifierKeys (optional) indicates the modifier keys (Ctrl = 4, Alt = 2, Shift = 1, None = 0 - can be combined via addition, e.g., 6 = Ctrl+Alt). If this argument is missing or -1, the current modifier keys are used.</p> <p>For Windows virtual key codes, add 256 to the key code, e.g. use <code>wtApp:SendKeyCode(265, WT_KEY_CTRL)</code> to simulate pressing <code>[Ctrl]+[TAB]</code>. Refer to the <a href="#">Microsoft Virtual Key Code documentation</a> to obtain code values for <code>VK_TAB (256+9=265)</code>, <code>VK_RETURN (256+13=269)</code>, <code>VK_LEFT (256+37=293)</code>, etc.</p>
<b>wtApp:SendMessage(strTitle, strClass, nMsg, nWParam, nLParam[, strLParam])</b>	<p>Send the specified message to a window. The SendMessage function calls the window procedure for the specified window and does not return until the window procedure has processed the message.</p> <p>strTitle : Title of the target window  strClass : Specifies the window class name of the child window (must be empty if unused)  nMsg : Message to be posted  nWParam : Additional message-specific information (use 0 if unused)  nLParam : Additional message-specific information (use 0 if unused)  strLParam : String as additional message-specific information</p> <p>Return the string "FAIL" if there was a problem or the command timed out. Otherwise, it is set to the numeric result of the message, which might sometimes be a "reply" depending on the nature of the message and its target window.</p>
<b>wtApp:SetCapsLock()</b>	<p>Enables the <b>[Caps Lock]</b> key. Normally used to change focus to the secondary radio window when <a href="#">Caps Lock binds to the secondary radio</a> is enabled</p>
<b>wtApp:SetWindowColor(ChildWndId, nRed, nGreen, nBlue, nColorIndex)</b>	<p>Set the nColorIndex color of the child window designated by its windowID (see <a href="#">Child window IDs</a>). If ChildWndId is &lt; 0, it applies to the main window. If nColorIndex is omitted (or set to 0), it applies to the</p>

	background color All colors must be $\leq 255$ .
<code>wtApp: ShowWindow (ChildWndId)</code>	Show the child window designated by its windowID (see <a href="#">Child window IDs</a> )
<code>wtApp: Sleep (Time)</code>	Time expressed in milliseconds.
<code>wtApp: TextCommand (Text)</code>	Send WT text command to application
<code>wtApp: ToggleCapsLock ()</code>	Toggles the [ <b>Caps Lock</b> ] key. Normally used to swap the current focus from the primary or secondary radio window when <u>Caps Lock binds to the secondary radio</u> is enabled
<code>wtApp: ToggleWindow (ChildWndId)</code>	Toggle the child window designated by its windowID (see <a href="#">Child window IDs</a> )
<code>wtApp: WizzWindow (ChildWndId)</code>	"Wizz" (shake or vibrate) the child window designated by its windowID (see <a href="#">Child window IDs</a> ). Can be used to draw attention to a particular window.

**Class wtContest**

<code>wtContest: IsExchangeRequired ()</code>	Return a boolean. True if the current contest requires an exchange (associated with RST)
<code>wtContest: GetCategoryId ()</code>	Return the current CategoryID
<code>wtContest: GetContestId ()</code>	Return the current contestID (see <a href="#">Supported contest IDs</a> )
<code>wtContest: GetModeCategoryId ()</code>	Return the current Mode CategoryID
<code>wtContest: GetMyCallsign ()</code>	Return my callsign set in the startup dialog of the contest
<code>wtContest: GetOverlayId ()</code>	Return the current Overlay Id
<code>wtContest: GetPowerClassId ()</code>	Return the current Power Class Id

**Class wtGab**

<code>wtGab: Send (strText [, strToStation])</code>	Sends a gab strText to strToStation. If strToStation is omitted, the text is sent to the whole network.
---	---

**Class wtKeyer**

<code>wtKeyer: GetCwSpeed ()</code>	Return the CW speed in wpm (return 0 in case of error).
<code>wtKeyer: GrabHighlightedCallsign ()</code>	Works only in RTTY mode and grabs the currently highlighted callsign from the RX window.
<code>wtKeyer: Insert (strMessage)</code>	Works for the CW and RTTY keyers. When used in a synchronous script, it provides a way to "fill-in" or "insert" data into the CW/RTTY message

	stream. It is recommended to be used only in synchronous mode to ensure that the characters are inserted in the right place. WARNING: strMessage can only contain text data (no variables or script calls). It is <i>not</i> interpreted by the CW/RTTY parser (except for +/- speed bursts).
<b>wtKeyer:Play (Message)</b>	Message is a plain string to be played, a saved message ( <b>\$F1</b> etc.) or a variable ( <b>\$xxx</b> ). The word space between the string arguments will be omitted if they end with a "~".
<b>wtKeyer:PlayAdditionalMsg (AdditionalMsgIndex)</b>	Play the additional CW/RTTY messages (Alt-C set)
<b>wtKeyer:SetCwSpeed (Speed)</b>	Set CW speed in wpm.
<b>wtKeyer:Stop ()</b>	Stop the current message

**Class wtMicroham**

<b>wtMicroham:GetDeviceId ()</b>	Return the ID of the microHAM attached device (see <a href="#">microHAM Device IDs</a> ).
<b>wtMicroham:GetFirmwareVersion ()</b>	Return the firmware version string of the microHAM attached device.
<b>wtMicroham:Send (strCommand)</b>	Send a command string to the microHAM attached device. The trailing <CR> character is optional, and is appended if needed.

**Class wtOp**

<b>wtOp:GetCallsign ()</b>	Return the current op callsign
<b>wtOp:GetNick ()</b>	Return the current op nick

**Class wtOtrsp**

<b>wtOtrsp:GetDeviceName ()</b>	Returns the name of the OTRSP attached device.
<b>wtOtrsp:GetFirmwareVersion ()</b>	Returns the firmware version of the OTRSP attached device. NOTE: Some devices do not support this API, and return an empty string.
<b>wtOtrsp:Send (strCommand)</b>	Sends a command string to the OTRSP attached device. The trailing <CR> character is optional, and is appended if needed.



## Class wtQso

<code>wtQso:IsCallsignEmpty()</code>	Return a boolean : True if the callsign field of the active QSO is empty
<code>wtQso:IsCallsignIncomplete()</code>	Return a boolean : True if the callsign field of the active QSO contains a "?"
<code>wtQso:IsExchangeEmpty()</code>	Return a boolean : True if the exchange field of the active QSO is empty
<code>wtQso:IsExchangeSent()</code>	Return a boolean : True if the exchangeSent flag of the active QSO is set
<code>wtQso:IsModeCW()</code>	Return a boolean : True if the mode of active QSO is CW
<code>wtQso:IsModeDigital()</code>	Return a boolean : True if the mode of active QSO is digital
<code>wtQso:SetExchangeSent()</code>	Set the exchangeSent flag of the active QSO (see <code>wtQso:IsExchangeSent()</code> ) - Similar to the use of <b>\$SETEXCHSENT</b>
<code>wtQso:ResetExchangeSent()</code>	Reset the exchangeSent flag of the active QSO (see <code>wtQso:IsExchangeSent()</code> ) - Similar to the use of <b>\$RSTEXCHSENT</b>
<code>wtQso:ClearStatus()</code>	Clear the status flags of the active QSO
<code>wtQso:GetData()</code>	Returns a LUA table object with fields of the current QSO. The current available keys are "time", "band", "mode", "freq", "callsign", "rstSent", "serialSent", "rstReceived", "exchReceived", "miscInfoReceived", "miscInfo2Received", "nQSONum", "stnName" and "stnFlags"; e.g. qsoData = wtQso:GetData(), then wtQso:GetData["time"] returns "17:03" or similar.
<code>wtQso:GetIniFileName()</code>	Returns File Name if INI file.
<code>wtQso:GetLogFileName()</code>	Returns Log File Name.
<code>wtQso:GetModeId()</code>	Return the mode ID of the active QSO (see <a href="#">Supported mode IDs</a> ).
<code>wtQso:IsCallsignRepeated()</code>	Return a boolean. True if the callsign hasn't changed since the last Enter
<code>wtQso:IsOperatingModeRun()</code>	Return a boolean. True if the operating mode of the active QSO is RUN (and False if S&P)
<code>wtQso:IsModePhone()</code>	Return a boolean. True if the mode of the active QSO is Phone (SSB and FM), and False otherwise
<code>wtQso:IsQsoApproved()</code>	Return a boolean. True if all requested fields of the active QSO are filled (contest dependent)

<b>wtQso:IsDupe()</b>	Return a boolean. True if the current callsign is a dupe
<b>wtQso:IsCurrentFieldCallsign()</b>	Return a boolean : True if the current field is the callsign field
<b>wtQso:IsCurrentFieldExchange()</b>	Return a boolean : True if the current field is an exchange field
<b>wtQso:IsCurrentFieldOther()</b>	Return a boolean : True if the current field is not the callsign field or an exchange field
<b>wtQso:IsCurrentFieldEmpty()</b>	Return a boolean : True if the current field is empty (except RST for the exchange field)
<b>wtQso:IsCurrentFieldPrimaryRadio()</b>	Return a boolean : True if the current field is in the primary radio (main log)
<b>wtQso:IsCurrentFieldSecondaryRadio()</b>	Return a boolean : True if the current field is in the secondary radio

**Class wtRadio\***

The following generic functions can be applied to: **wtRadio** (the active one), **wtRadioInactive** (the non-active one), **wtRadioPrimary** (the one that is in the main log wnd) **wtRadioSecondary** (the one that is in the secondary log wnd) **wtRadio1** and **wtRadio2**.

WARNING: Some functions may not work because of the CAT protocol or radio hardware limitations.

<b>wtRadio*:GetFreq()</b>	Return freq of the active VFO of the designated radio freq is expressed in kHz
<b>wtRadio*:GetFreq(NVfo)</b>	Return freq of the designated VFO (0 => VFO A, 1 => VFO B) of the designated radio freq is expressed in kHz
<b>wtRadio*:GetFreqInactiveVfo()</b>	Return freq of the inactive VFO of the designated radio freq is expressed in kHz
<b>wtRadio*:GetTypeId()</b>	Return type of radio (see <a href="#">Radio Types</a> )
<b>wtRadio*:GetManufacturerId()</b>	Return manufacturer of radio (see <a href="#">Radio Manufacturer Constants</a> )
<b>wtRadio*:SetFreq(freq)</b>	Set freq of the active VFO of the designated radio freq is expressed in kHz
<b>wtRadio*:SetFreq(freq, nVfo)</b>	Set freq of the designated VFO (0 => VFO A, 1 => VFO B) of the designated radio freq is expressed in kHz
<b>wtRadio*:SetFreqInactiveVfo(freq)</b>	Set freq of the inactive VFO of the designated radio freq is expressed in kHz
<b>wtRadio*:SetFreqSubVfo(freq)</b>	Set freq of the sub VFO of the designated radio freq is expressed in kHz

<code>wtRadio*:SetSplit(freq)</code>	Set split ON and the split frequency on the designated radio freq is expressed in kHz
<code>wtRadio*:ResetSplit()</code>	Reset split on the designated radio
<code>wtRadio*:IsSplit()</code>	Return false or true whether the split is set or not on the designated radio
<code>wtRadio*:GetRadioId()</code>	Return the radioID (0 => RADIO_1, 1 => RADIO_2) of the designated radio
<code>wtRadio*:Send(catString)</code>	Send the ASCII catString to the designated radio
<code>wtRadio*:SendHex(hexString)</code>	Send the hexString to the designated radio. The hexString must contain only 0-9 and A-F characters and must have an even length. Ex "02DFA8" etc.

NOTE: `wtRadio*:SetFreq(fFreq)` and `wtRadio*:SetFreq(fFreq, nVfo)` ignore the frequency if it is outside of any band, and return with no error message.

### Class wtScript

<code>wtScript:AssignArgument()</code>	function now takes the strings "true" and "false" as boolean arguments. Numeric values do not require double quotes. More details needed.
<code>wtScript:AssignFKey()</code>	assigns a function to an function key. More details needed.
<code>wtScript:AssignKeyCode()</code>	assigns a key code. More details needed.

### Class wtStatus

<code>wtStatus:GetList()</code>	Returns a table with names of the stations in the network
<code>wtStatus:GetStatus(strStation)</code>	returns a table with fields of the status of a given station. Returns nil if this station doesn't exist. The table keys are "band" "mode" "currentRadio" "radio1Freq" "radio2Freq" "radio1IsManual" "radio2IsManual" "passFreq" "type" and "qsyStatusId".
<code>wtStatus:GetFreq(strBand[, strMode])</code>	returns the "best" pass freq for a given band and mode. To determine this frequency, it uses the same algorithm as the \$FREQnn variable
<code>wtStatus:GetMyStation()</code>	returns the station number.

### Win-Test API Variables

- **wtArg**: get the optional argument set in the Script Manager or in a **#SCRIPT(argument)** call. **wtArgument** is also provided for backward compatibility. Both variables are local to the script called.
- **wtCurrentScript**: contains the script name currently executed, without extension
- **wtRootScript**: contains the name of the top-most called script, without extension

## Win-Test API Constants

The most current list of Win-Test API Constants may be found at <http://download.win-test.com/v4/lua/constants.wts>.

Constants are not guaranteed to remain constant in Lua, that is, a program can update these variables. Any constant could be accidentally reassigned to refer to some other object or value. Unfortunately, there is no easy way to generate code that prevents this. You will just have to be careful. Avoid creating variable names starting with WT\_.

### Child window IDs

```

WT_WND_SUMMARY = 0;
WT_WND_GRIDSMAP = 1;
WT_WND_CHECKPARTIAL = 2;
WT_WND_RATESHEET = 3;
WT_WND_CLOCK = 4;
WT_WND_VUMETER = 5;
WT_WND_RATE = 6;
WT_WND_GAB = 7;
WT_WND_MAP = 8;
WT_WND_CHECKCOUNTRY = 9;
WT_WND_ZONE = 10;
WT_WND_MULT = 11;
WT_WND_NP1 = 12;
WT_WND_RADIO1 = 13;
WT_WND_RADIO2 = 14;
WT_WND_PACKETCLUSTER = 15;
WT_WND_DXCLUSTERANN = 16;
WT_WND_SOLAR = 17;
WT_WND_PARTNER = 18;
WT_WND_STATUS = 19;
WT_WND_SKED = 20;
WT_WND_CHECKCALL = 21;
WT_WND_SECONDARYRADIO = 22;
WT_WND_RTTY1 = 23;
WT_WND_RTTY2 = 24;
WT_WND_QSYWIZARD = 25;
WT_WND_EXTRAINFO = 26;
WT_WND_ZONE2 = 27;
WT_WND_ROTATORS = 28;
WT_WND_CONTESTRECORDER = 29;

```

### Supported contest IDs

```

WT_CONTEST_IARU_VHF = 1;
WT_CONTEST_IARU_UHF = 2;
WT_CONTEST_IARU_CW = 3;
WT_CONTEST_IARU_HF = 4;
WT_CONTEST_IARU_R1_50MHZ = 5;
WT_CONTEST_REF_THF = 10;
WT_CONTEST_REF_DDFM_50MHZ = 11;
WT_CONTEST_THF_EU = 20;
WT_CONTEST_THF_EU_50_70 = 21;
WT_CONTEST_THF_EU_GRIDSMAP = 30;
WT_CONTEST_THF_EU_GRIDSMAP_50_70 = 31;
WT_CONTEST_THF_EU_GRIDSMAP_NO_DIST = 32;
WT_CONTEST_THF_EU_GRIDSMAP_NO_DIST_50_70 = 33;
WT_CONTEST_REF_HF = 100;

```

## Win-Test Wiki

```
WT_CONTEST_ARRL_DX = 101;
WT_CONTEST_ARRL_10 = 102;
WT_CONTEST_ARRL_160 = 103;
WT_CONTEST_ARRL_SWEEPSTAKES = 104;
WT_CONTEST_ARRL_FD = 105;
WT_CONTEST_ARRL_RU = 106;
WT_CONTEST_ARRL_UHF_AUG = 130;
WT_CONTEST_ARRL_VHF_JAN = 131;
WT_CONTEST_ARRL_VHF_JUN = 132;
WT_CONTEST_ARRL_VHF_SEP = 133;
WT_CONTEST_REF_160 = 150;
WT_CONTEST_CQWW_DX = 200;
WT_CONTEST_CQWW_WPX = 201;
WT_CONTEST_CQWW_160 = 202;
WT_CONTEST_CQWW_VHF = 250;
WT_CONTEST_RDXC = 300;
WT_CONTEST_RDAC = 301;
WT_CONTEST_CIS = 302;
WT_CONTEST_R_160 = 303;
WT_CONTEST_RRTC = 304;
WT_CONTEST_RAEM = 305;
WT_CONTEST_DXPEDITION_HF = 400;
WT_CONTEST_DXPEDITION_VHF = 410;
WT_CONTEST_ALL_ASIAN = 500;
WT_CONTEST_SPDXC = 600;
WT_CONTEST_JIDX = 700;
WT_CONTEST_KCJ = 701;
WT_CONTEST_KCJ_TOPBAND = 702;
WT_CONTEST_YUDXC = 800;
WT_CONTEST_CQM = 900;
WT_CONTEST_ARI = 1000;
WT_CONTEST_ARI_SEZIONI = 1001;
WT_CONTEST_ARI_40_80 = 1002;
WT_CONTEST_BALTIC = 1100;
WT_CONTEST_KING_OF_SPAIN = 1200;
WT_CONTEST_IOTA = 1300;
WT_CONTEST_RSGB_160 = 1301;
WT_CONTEST_RSGB_80_CC = 1302;
WT_CONTEST_RSGB_CMW = 1303;
WT_CONTEST_RSGB_15_10 = 1304;
WT_CONTEST_RSGB_AFS = 1305;
WT_CONTEST_WAEDC = 1400;
WT_CONTEST_WAG = 1401;
WT_CONTEST_DARC_XMAS = 1402;
WT_CONTEST_DARC_10 = 1403;
WT_CONTEST_YODXC = 1500;
WT_CONTEST_EU_HF = 1600;
WT_CONTEST_SCC = 1601;
WT_CONTEST_OCDXC = 1700;
WT_CONTEST_TOECC = 1800;
WT_CONTEST_SAC = 1900;
WT_CONTEST_NRAU_BALTIC = 1901;
WT_CONTEST_NAC = 1902;
WT_CONTEST_SARTG = 1903;
WT_CONTEST_QP_TX = 2000;
WT_CONTEST_EU_SPRINT = 2100;
WT_CONTEST_UKDXC = 2200;
WT_CONTEST_OKOMDXC = 2300;
WT_CONTEST_STEW_PERRY = 2400;
WT_CONTEST_GACW_DX = 2401;
WT_CONTEST_NINE_KCC_15 = 2402;
WT_CONTEST_FOC_MARATHON = 2403;
```

## Win-Test Wiki

```
WT_CONTEST_LOTW = 2404;
WT_CONTEST_AP_SPRINT = 2405;
WT_CONTEST_JARTS = 2406;
WT_CONTEST_MARCONI_HF = 2407;
WT_CONTEST_LZDX = 2500;
WT_CONTEST_CROATIAN_CW = 2600;
WT_CONTEST_UBADX = 2700;
WT_CONTEST_UBA_SPRING_80M = 2701;
WT_CONTEST_UBA_SPRING_6M = 2702;
WT_CONTEST_UBA_SPRING_2M = 2703;
WT_CONTEST_ON_80M = 2704;
WT_CONTEST_ON_6M = 2705;
WT_CONTEST_ON_2M = 2706;
WT_CONTEST_RAC_DAY = 2800;
WT_CONTEST_RAC_WINTER = 2801;
WT_CONTEST_PACC = 2900;
WT_CONTEST_HELVETIA = 3000;
WT_CONTEST_HELVETIA_VHF = 3001;
WT_CONTEST_IARU_FD_R1_GENERIC = 3100;
WT_CONTEST_IARU_FD_R1_DARC = 3101;
WT_CONTEST_IARU_FD_R1_RSGB = 3102;
WT_CONTEST_UFT_HF = 3200;
WT_CONTEST_AGCW_HNY = 3300;
WT_CONTEST_HA_DX = 3400;
WT_CONTEST_NAQP = 3500;
WT_CONTEST_NA_SPRINT = 3501;
WT_CONTEST_NCCC_SPRINT = 3600;
WT_CONTEST_CQIR = 3700;
```

### Supported mode IDs

```
WT_MODE_CW = 0;
WT_MODE_SSB = 1;
WT_MODE_RTTY = 2;
WT_MODE_FM = 3;
WT_MODE_PSK = 4;
WT_MODE_PKT = 5;
WT_MODE_HELL = 6;
WT_MODE_SAT = 7;
```

### Status key IDs

```
WT_KEY_NONE = 0;
WT_KEY_SHIFT = 1;
WT_KEY_ALT = 2;
WT_KEY_CTRL = 4;
```

### Radio Constants

```
WT_RADIO_MAX = 2;

WT_RADIO_VFOA = 0;
WT_RADIO_VFOB = 1;

WT_RADIO_1 = 0;
WT_RADIO_2 = 1;
```

## Radio Manufacturer Constants

```

WT_RADIO_MANUFACTURER_UNKNOWN = 0;
WT_RADIO_MANUFACTURER_ICOM = 1;
WT_RADIO_MANUFACTURER_YAESU = 2;
WT_RADIO_MANUFACTURER_KENWOOD = 3;
WT_RADIO_MANUFACTURER_TENTEC = 4;
WT_RADIO_MANUFACTURER_ELECRAFT = 5;
WT_RADIO_MANUFACTURER_FLEXRADIO = 6;

```

## Radio Types

```

WT_RADIO_UNKNOWN = -1;
WT_RADIO_NONE = 0;
WT_RADIO_KENWOOD = 1;
WT_RADIO_IC703 = 1703;
WT_RADIO_IC706 = 1706;
WT_RADIO_IC706MkII = 17061;
WT_RADIO_IC706MkIIG = 17062;
WT_RADIO_IC718 = 1718;
WT_RADIO_IC725 = 1725;
WT_RADIO_IC728 = 1728;
WT_RADIO_IC729 = 1729;
WT_RADIO_IC735 = 1735;
WT_RADIO_IC736 = 1736;
WT_RADIO_IC738 = 1738;
WT_RADIO_IC737 = 1737;
WT_RADIO_IC746 = 1746;
WT_RADIO_IC746Pro = 17761;
WT_RADIO_IC751 = 1751;
WT_RADIO_IC756 = 1756;
WT_RADIO_IC756Pro = 17561;
WT_RADIO_IC756ProII = 17562;
WT_RADIO_IC756ProIII = 17563;
WT_RADIO_IC761 = 1761;
WT_RADIO_IC765 = 1765;
WT_RADIO_IC775 = 1775;
WT_RADIO_IC781 = 1781;
WT_RADIO_IC275 = 1275;
WT_RADIO_IC475 = 1475;
WT_RADIO_IC1275 = 11275;
WT_RADIO_IC910 = 1910;
WT_RADIO_IC7000 = 17000;
WT_RADIO_IC7600 = 17600;
WT_RADIO_IC7700 = 17700;
WT_RADIO_IC7800 = 17800;
WT_RADIO_ICGENERIC = 1000;
WT_RADIO_FT1000MP = 2110;
WT_RADIO_FT1000 = 2100;
WT_RADIO_FT2000 = 2200;
WT_RADIO_FT990 = 2099;
WT_RADIO_FT920 = 2092;
WT_RADIO_FT100 = 2010;
WT_RADIO_FT847 = 20847;
WT_RADIO_FT900 = 2090;
WT_RADIO_FT897 = 20897;
WT_RADIO_FT817 = 20817;
WT_RADIO_FT857 = 20857;
WT_RADIO_FT757GXII = 207572;
WT_RADIO_FTDX9000 = 2900;
WT_RADIO_FT450 = 2450;

```

```

WT_RADIO_FT950 = 2950;
WT_RADIO_ORION = 3000;
WT_RADIO_OMNI6 = 3001;
WT_RADIO_JUPITER = 3002;
WT_RADIO_OMNI7 = 3003;
WT_RADIO_ORION_II = 3004;
WT_RADIO_SDR1000 = 4000;
WT_RADIO_K2 = 5000;
WT_RADIO_K3 = 5001;
WT_RADIO_OMNIRIG = 6000;

```

## microHAM Device IDs

```

WT_MICROHAM_NONE = 0;
WT_MICROHAM_MK = 1;
WT_MICROHAM_MKII = 2;
WT_MICROHAM_MK2R = 10;
WT_MICROHAM_MK2R_PLUS = 11;
WT_MICROHAM_MICRO_2R = 12;

```

## Advanced Programming Examples

### ESM Script (embedded into Win-Test)

For convenience, you can find below the current ESM (Enter Sends Message) embedded script. Note that the real returned values are somewhat different from the ones described above, because of the nature of this script (embedded), but it is a good source of inspiration for your own masterpiece. As Lua is an interpreted language, the good news is that you can edit your script while WT is running. No need to exit WT, enter modifications, and start WT again. Just edit `esm.wts` while WT is running, save it, and try it immediately!

The script assumes the following messages have been programmed into the [Standard CW messages](#) dialog:

---

```

F1 => CQ
F2 => RST + Exchange
F3 => TU
F4 => $MYCALL
F5 => $LOGGED
F7 => ? or Again (Phone)
INSERT => Sends exchange (CW and RTTY)
PLUS => TU and Log the QSO

```

---

Here is the source code for **esm.wts**. To change the behavior, save it in the Win-Test scripts directory (File | Explore | /scripts directory), then edit it.

```

-- v1.2 All variables in messages replaced by keypresses
-- v1.1 Dupes taken into account in the S&P mode
-- v1.0 Initial version

-- Send functions

function sendCq()
    wtQso:ResetExchangeSent();
    wtApp:SendFKey("F1"); -- Always use the function key
end;

```



## Win-Test Wiki

```
function sendExchangeRun()
    wtApp:SendFKey(wtQso:IsModePhone() and "F2" or "INSERT"); -- Ternary Operator
    wtQso:SetExchangeSent();
end;

function sendExchangeAgain()
    if (wtQso:IsModePhone()) then
        wtApp:SendFKey("F2");
    else
        wtApp:SendFKey("F5"); -- $LOGGED
        wtApp:SendFKey("F7"); -- ?
    end;
end;

function sendTu()
    wtApp:SendFKey("PLUS");
    wtQso:ClearStatus();
end;

function sendQuestionMark()
    wtQso:ResetExchangeSent();
    wtApp:SendFKey("F7"); -- Again ?
end;

function sendMyCall()
    wtApp:SendFKey("F4"); -- My call
end;

function sendExchangeSAndP()
    wtApp:SendFKey("F2");
    wtQso:SetExchangeSent();
end;

-- ESM core code

-- Return 0 (or return nothing) if we want the CR
-- to be processed also by WT (ie log QSO) and -1 if not.

if (wtQso:IsOperatingModeRun()) then -- Run
    if (wtContest:IsExchangeRequired()) then -- Usual contests
        if (wtQso:IsExchangeEmpty() or not wtQso:IsQsoApproved()) then
            if (wtQso:IsCallsignEmpty()) then
                sendCq();
            else
                if (wtQso:IsCallsignRepeated()) then
                    sendExchangeAgain();
                else
                    sendExchangeRun();
                end;
            end;
        else
            if (wtQso:IsExchangeSent()) then
                sendTu();
            else
                sendExchangeRun();
            end;
        end;
    else -- DXPed etc.
        if (not wtQso:IsQsoApproved()) then
            if (wtQso:IsCallsignEmpty()) then
                sendCq();
            end;
        end;
    end;
end;
```

## Win-Test Wiki

```
else
    if (wtQso:IsCallsignRepeated()) then
        sendExchangeAgain();
    else
        sendExchangeRun();
    end;
end;
else
    if (wtQso:IsExchangeSent()) then
        sendTu();
    else
        sendExchangeRun();
    end;
end;
end;
else -- S&P : The automatic exchange fill (if enabled) is disabled by WT
    if ( (wtQso:IsExchangeEmpty() and wtContest:IsExchangeRequired())
        or not wtQso:IsQsoApproved() ) then
        if (wtQso:IsCallsignEmpty()) then
            sendQuestionMark();
        else
            if (not wtQso:IsDupe()) then -- Call only if not dupe
                sendMyCall();
            end;
        end;
    else
        if (wtQso:IsExchangeSent()) then
            wtQso:ClearStatus();
            return 0; -- Log it silently
        else
            if (not wtQso:IsDupe()) then -- Sent exchange only if not dupe
                sendExchangeSAndP();
            end;
        end;
    end;
end;
end;
return -1; -- This script overrides the Win-Test CR process
```

### Alternative ESM Script (provided by F5VIH/SV3SJ)

At the top of the script you will find a variable setting:

```
shortcq = false;
```

Setting it to true, it will convert the CQ calling and the TU part of the QSO in short forms (a la 5b4agn) and the exact contents of the messages are defined in the two lines that follow the shortcq setting. I have also added the possibility to have an exchange filled in and no call (in that case the script sends CL?)

I must say I am very impressed by the functionality that WT opens to the users with lua scripts. I would really like to see more API calls made available and WT functions using scripts (programmable keys, even SO2R, etc).

In the mean time if you have suggestions to improve the script let me know. I can easily include them.

```
-----
-- Wintest ESM - Nick, F5VIH/SV3SJ
-- Set "shortCQ to true or false
-----
```

```

shortcq = false;
shortCQ = "$MYCALL";
shortTU = "$CORRECT ++TU-- $CR";

-- Send functions

function sendCq()
  wtQso:ResetExchangeSent();
  if (wtQso:IsModePhone()) then
    wtApp:SendFKey("F1");
  else
    if (shortcq) then
      wtKeyer:Play(shortCQ);
    else
      wtApp:SendFKey("F1"); -- Always use the function key
    end;
  end;
end;

function sendExchangeRun()
  if (wtQso:IsModePhone()) then
    wtApp:SendFKey("F2");
    wtKeyer:Play("$CR");
  else
    wtKeyer:Play("$INSERT");
  end;
  wtQso:SetExchangeSent();
end;

function sendExchangeAgain()
  if (wtQso:IsModePhone()) then
    wtApp:SendFKey("F2");
  else
    wtKeyer:Play("$F5 $F7"); -- $LOGGED ?
  end;
end;

function sendTu()
  if (wtQso:IsModePhone()) then
    if (shortcq) then
      wtKeyer:Play("$CR");
      wtApp:SendFKey("F5");
    else
      wtApp:SendFKey("PLUS");
    end;
  else
    if (shortcq) then
      wtKeyer:Play(shortTU);
    else
      wtKeyer:Play("$PLUS");
    end;
  end;
  wtQso:ClearStatus();
end;

function sendQuestionMark()
  wtQso:ResetExchangeSent();
  if (wtQso:IsModePhone()) then
    wtApp:SendFKey("F7"); -- Again ?
  else
    wtKeyer:Play("$F7");
  end;
end;

```

```

end;

function sendMyCall()
  if (wtQso:IsModePhone()) then
    wtApp:SendFKey("F4"); -- My call
  else
    wtKeyer:Play("$F4");
  end;
end;

function sendExchangeSAndP() -- Sends appropriate exchange when in S&P mode
  if (wtQso:IsModePhone()) then
    wtApp:SendFKey("F2"); -- 5NN EXCHANGE
  else
    wtKeyer:Play("$F2");
  end;
  wtQso:SetExchangeSent();
end;

function sendAskForCall()
  if (wtQso:IsModePhone()) then
    wtApp:SendFKey("F7"); -- AGN
  else
    wtKeyer:Play("CL?");
  end;
end;

function askForNumber()
  if (wtQso:IsModePhone()) then
    wtApp:SendFKey("F6"); -- NR AGN
  else
    wtKeyer:Play("$F6");
  end;
end;

function askWithPartialCall()
  if (wtQso:IsModePhone()) then
    wtApp:SendFKey("F7"); -- AGN
  else
    wtKeyer:Play("$F5 ?");
  end;
end;

-- ESM core code

-- Return 0 (or return nothing) if we want the CR
-- to be processed also by WT (ie log QSO) and -1 if not.

if (wtQso:IsOperatingModeRun()) then -- Run Mode
  if (wtContest:IsExchangeRequired()) then -- Usual contests requiring an exchange
    if (wtQso:IsCallsignEmpty()) then
      if (wtQso:IsExchangeEmpty()) then
        sendCq();
      else -- we ve got an exchange but not a call, ask for the call
        sendAskForCall();
      end;
    else -- call is not empty
      if (wtQso:IsExchangeSent()) then -- we have sent the exchange
        if (not wtQso:IsQsoApproved()) then
          if (wtQso:IsCurrentFieldCallsign() and not wtQso:IsExchangeEmpty()) then
            askWithPartialCall();
          end;
        end;
      end;
    end;
  end;
end;

```

## Win-Test Wiki

```
if (wtQso:IsCurrentFieldCallsign() and wtQso:IsExchangeEmpty()) then
    wtQso:ResetExchangeSent();
    sendExchangeRun();
    if (wtQso:IsCurrentFieldCallsign()) then wtKeyer:Play("$SPACEBAR") end;
end;
if (wtQso:IsCurrentFieldExchange() and wtQso:IsExchangeEmpty()) then
    askForNumber();
end;
else -- qso has valid call and exchange
    if (wtQso:IsCurrentFieldExchange()) then
        sendTu();
    else -- current field is not exchange (should be callsign)
        if (wtQso:IsCurrentFieldCallsign()) then
            wtQso:ResetExchangeSent();
            sendExchangeRun();
            if (wtQso:IsCurrentFieldCallsign()) then wtKeyer:Play("$SPACEBAR") end;
        end;
    end;
end;

else -- have not sent exchange and we are in the call field
    sendExchangeRun();
    if (wtQso:IsCurrentFieldCallsign()) then wtKeyer:Play("$SPACEBAR") end;
end;
end;

else -- The contest doesnt require an exchange to be received e.g. DXPed etc.
    if (not wtQso:IsQsoApproved()) then
        if (wtQso:IsCallsignEmpty()) then
            sendCq();
        else
            if (wtQso:IsCallsignRepeated()) then
                sendExchangeAgain();
            else
                sendExchangeRun();
            end;
        end;
    end;
else
    if (wtQso:IsExchangeSent()) then
        sendTu();
    else
        sendExchangeRun();
    end;
end;
end;

else -- S&P : The automatic exchange fill (if enabled) is disabled by WT
    if ( (wtQso:IsExchangeEmpty() and wtContest:IsExchangeRequired()) or not wtQso:IsQsoApproved() )
        if (wtQso:IsCallsignEmpty()) then
            sendQuestionMark();
        else
            if (not wtQso:IsDupe()) then -- Call only if not dupe
                sendMyCall();
            end;
        end;
    end;
else
    if (wtQso:IsExchangeSent()) then
        wtQso:ClearStatus();
        wtKeyer:Play("$CR");
        return -1; -- Log it silently
    else
        if (not wtQso:IsDupe()) then -- Sent exchange only if not dupe
```

```
        sendExchangeSAndP ();
    end;
end;
end;
end;

return -1; -- This script overrides the Win-Test CR process
```

### Grab next call from partner window

The following script was kindly provided by Hank Lonberg, KR7X. It remaps the [~] key to grab the next callsign from the partner window and send an exchange.

```
wtKeyer:Play("$CORRECT TU $CR NOW $GRABPARTNER $NEXT $GUESSEXCH $F2 $13");
```

### Re-map [Ã ] key with /P for Field Day

Practical in Field Day where a lot of stations are signing "/P" - especially with a German keyboard layout.

```
-- add /P to a callsign for Field Day operations
wtApp:SendKeyCode(47);
wtApp:SendKeyCode(112);
```

### Change background of Main Window depeing on RUN/S&P Mode

The idea to this script was provided by GW3NJW. Name this script **RunSPSwitch.wts** and have it assigned to **Ctrl-Tab**

```
if (wtApp:IsPostKeyProcess()) then
    if (wtQso:IsOperatingModeRun()) then
        wtApp:SetWindowColor(-1, 0, 165, 165);
    else
        wtApp:SetWindowColor(-1, 128,128,128);
    end;
else
    return 1; -- Triggers a post key process call
end;
```

## Namespaces

- [Page](#)
- [Discussion](#)

## Variants

## Views

- [Read](#)
- [View source](#)
- [View history](#)

## More

- This page was last edited on 30 December 2021, at 12:51.

- [Privacy policy](#)
- [About Win-Test Wiki](#)
- [Disclaimers](#)



# SO1R/Band Map

From Win-Test Wiki

[Jump to navigation](#) [Jump to search](#)

## Band Map

With a single glance, the band map allows us to gather an impression about the activity that could be found on a band, if there are many new stations or mults, if it's worth calling CQ etc.

Even without packet radio, you can feed spots into the band map using **Ctrl-Enter**. Moreover, when you log a station, this callsign will be added to the band map. This way you may fill in holes or add new stations in a multi operator environment to prepare a new band for an upcoming QSY. Win-Test will propagate these band-map spots out to the network so that all the networked stations will have the same band map.

You may also correct or delete spots in the band map by two means:

- **Right-Click** on a callsign spot, then a context menu will open up
- **Ctrl-DoubleClick** on a callsign spot, to delete that spot without the warning window

Spots in the band map stay for 60 minutes (default setting, may be increased up to 99).

Spots have a bandwidth of 1 kHz by default - meaning that if you enter another call within 1 kHz this will overwrite the current "slot". This setting can be changed however, which is important on CW, where up to 3 stations may co-exist within 1 kHz.

There is also a text version of the band map: clicking on the **List** tab you'll see a list of spots sorted in different, user selectable, ways (by callsign, by frequency, etc.) through a contextual menu.

## See also

- [The Radio1, Radio2 Band Map](#)
- [Enabling Exchange Guessing in the band map](#)
- [Manually adding calls to band map](#)
- [WAEDC: OTC information in the Band Map](#)

## Namespaces

- [Page](#)
- [Discussion](#)

## Variants

## Views

- [Read](#)
- [View source](#)
- [View history](#)



## More

- This page was last edited on 13 March 2007, at 14:16.

- [Privacy policy](#)
- [About Win-Test Wiki](#)
- [Disclaimers](#)



# SO1R/Band Map

From Win-Test Wiki

[Jump to navigation](#) [Jump to search](#)

## Band Map

With a single glance, the band map allows us to gather an impression about the activity that could be found on a band, if there are many new stations or mults, if it's worth calling CQ etc.

Even without packet radio, you can feed spots into the band map using **Ctrl-Enter**. Moreover, when you log a station, this callsign will be added to the band map. This way you may fill in holes or add new stations in a multi operator environment to prepare a new band for an upcoming QSY. Win-Test will propagate these band-map spots out to the network so that all the networked stations will have the same band map.

You may also correct or delete spots in the band map by two means:

- **Right-Click** on a callsign spot, then a context menu will open up
- **Ctrl-DoubleClick** on a callsign spot, to delete that spot without the warning window

Spots in the band map stay for 60 minutes (default setting, may be increased up to 99).

Spots have a bandwidth of 1 kHz by default - meaning that if you enter another call within 1 kHz this will overwrite the current "slot". This setting can be changed however, which is important on CW, where up to 3 stations may co-exist within 1 kHz.

There is also a text version of the band map: clicking on the **List** tab you'll see a list of spots sorted in different, user selectable, ways (by callsign, by frequency, etc.) through a contextual menu.

## See also

- [The Radio1, Radio2 Band Map](#)
- [Enabling Exchange Guessing in the band map](#)
- [Manually adding calls to band map](#)
- [WAEDC: OTC information in the Band Map](#)

## Namespaces

- [Page](#)
- [Discussion](#)

## Variants

## Views

- [Read](#)
- [View source](#)
- [View history](#)

## More

- This page was last edited on 13 March 2007, at 14:16.

- [Privacy policy](#)
- [About Win-Test Wiki](#)
- [Disclaimers](#)



# BestPractice10

From Win-Test Wiki

[Jump to navigation](#) [Jump to search](#)

## Contents

- [1 Setting up the ICOM IC-7851 + microKeyer MK III](#)
- [2 ICOM IC-7581](#)
- [3 microHAM MKII](#)
- [4 microHAM USB Device Router](#)
- [5 MMTTY](#)
- [6 Win-Test](#)

## Setting up the ICOM IC-7851 + microKeyer MK III

+++ This article is still under construction +++

This article is a step by step approach describing how to set up an ICOM IC-7851 radio and a microHAM microKeyer III interface. The MK III is a complex device integrating a CW-Keyer, CW and FSK keying, PTT control (including a delayed PTT), radio control and a sound card, a digital voice keyer which allows to control up to ten audio memories and different audio switching scenarios. This article covers the set-up of CW, RTTY and SSB in several steps.

Support for the ICOM IC-7581 implemented WinTest 4.20. Be sure, you are running a current version of WinTest.

[BestPractice1](#) article describes a slightly simpler set-up with the Microham USB Interface II. [BestPractice4](#) article describes a slightly simpler set-up with the microHAM microKeyer. Please see there for background information about RTTY and MMTTY in general.

## ICOM IC-7581

- In the RTTY mode, push [MENU] to display the `M1` screen (Menu 1)
- Push [RTTY](F-4) to display the `RTTY` screen
- Push [SET](F-5) to enter the RTTY Set mode
- Push [Y](F-1) or [Z](F-2) to select the desired item
  - ◆ Set *RTTY Mark Freq* to 1275 (use VFO knob to step through available options)
  - ◆ Set *RTTY Shift Width* to 170 (use VFO knob to step through available options)
  - ◆ Set *Keying Pol* to NORMAL (use VFO knob to step through available options)
- Push [MENU] to save, and return to the `RTTY` screen
- Push [MENU] again to return to the `M1` screen

To test the settings, put the radio to FSK mode, push the MONITOR button, make sure MONI GAIN is set to the 12 o'clock position and then switch the radio to transmit by pressing TRANSMIT. You should now hear a 1275 Hz tone.

**Note:** The built-in RTTY decoder in the IC-7410 only works with High Tones selected. I personally prefer listening to low tones and so this article focusses on 1275 Hz/1445 Hz, but actually it's up to you.

## microHAM MKII

- Connect the MKII to a 12V DC source. Optionally you can feed the MKII via the DB37 cable by setting the jumper inside the MK-II very close to the 13.8 V DC jack.
- Connect a footswitch to the FOOTSW connector of the MKII.
- Connect your microphone or headset to the short RJ45 cable that goes into MIC on the MKII (this connector does also provide the 8V DC voltage on pin 5 for your electret microphone - for ICOM you have to enable this; do not try to use dynamic microphones with ICOM radios, this will fail - audio level is too low).
- Connect the microHAM MKII to your radio and computer.
  - ◆ On the radio side there will be five connections: KEY, RTTY, PACKET, CAT, AF OUT and microphone.
  - ◆ On the computer side there will be only a single connection: USB. I had to use a ferrite core to get rid of RF noise.
- Install the microHAM software if you haven't done so already. There are two steps to it:
  - ◆ Installing the device driver - if you have several microHAM devices you will have to do this once for each of them.
  - ◆ Installing the USB Device Router - this software only needs to be installed once. It is identical on all microHAM products.

**Note:** If you had previously installed the USB Device Router with another microHAM product, it will come up with a new tab for the new hardware connected.

## microHAM USB Device Router

- Set up the Device Router
- Go to the Ports Tab
  - ◆ Create virtual COM ports: COM6, COM7, COM8 and COM9. Note: The absolute port numbers do not matter. The key is consistency - the same port number must be used for a specific function every time it is used.
  - ◆ Configure Radio on COM6
  - ◆ Press the **Set** button to the right of the radio port configuration and select Icom IC-7410. MKII will assign different Audio Routing and PTT scenarios if it knows what frequency and mode the radio is set. This is why we have to do it.
  - ◆ You should now see the current frequency of the radio display in the **Ports** tab
  - ◆ Configure FSK on COM7. Make sure you tick the PTT tag
  - ◆ Configure Winkey COM8 using Winkey default settings
  - ◆ Configure Control on COM9. This will allow controlling the MKII, especially the DVK from Win-Test.

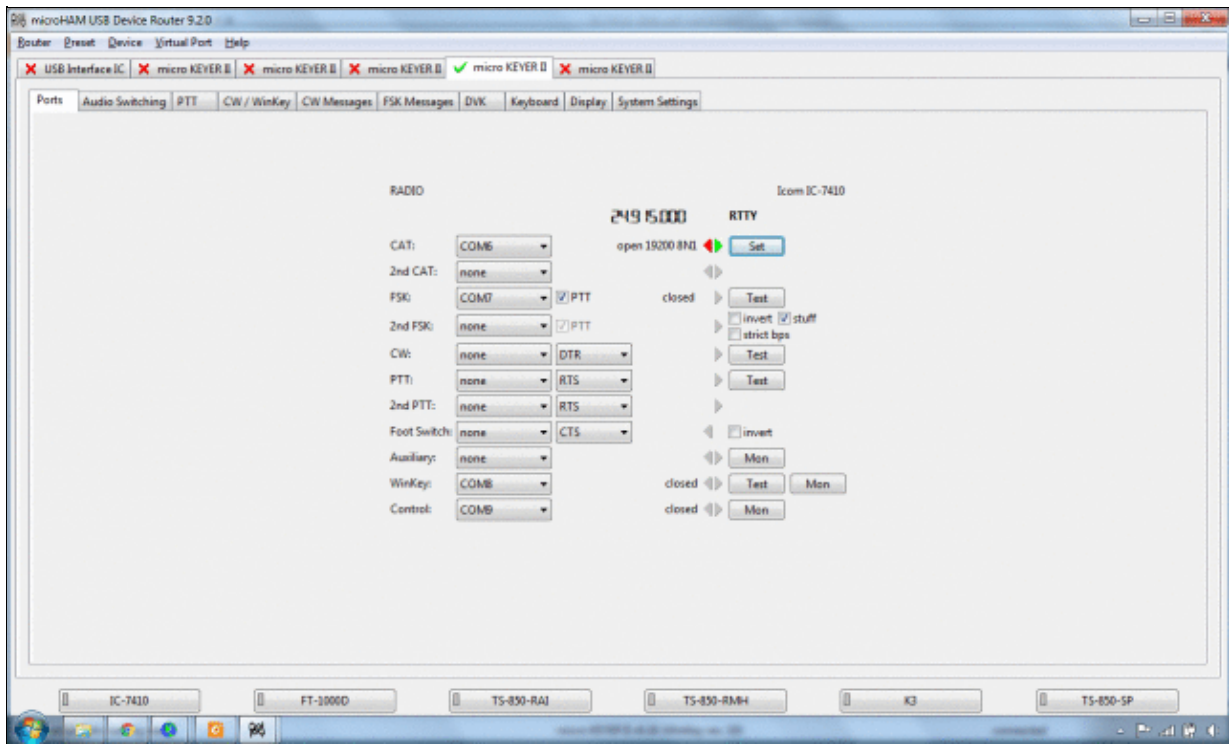

microHAM MKII Ports setup. We use COM6,7,8 and 9 to control different properties of the MKII.

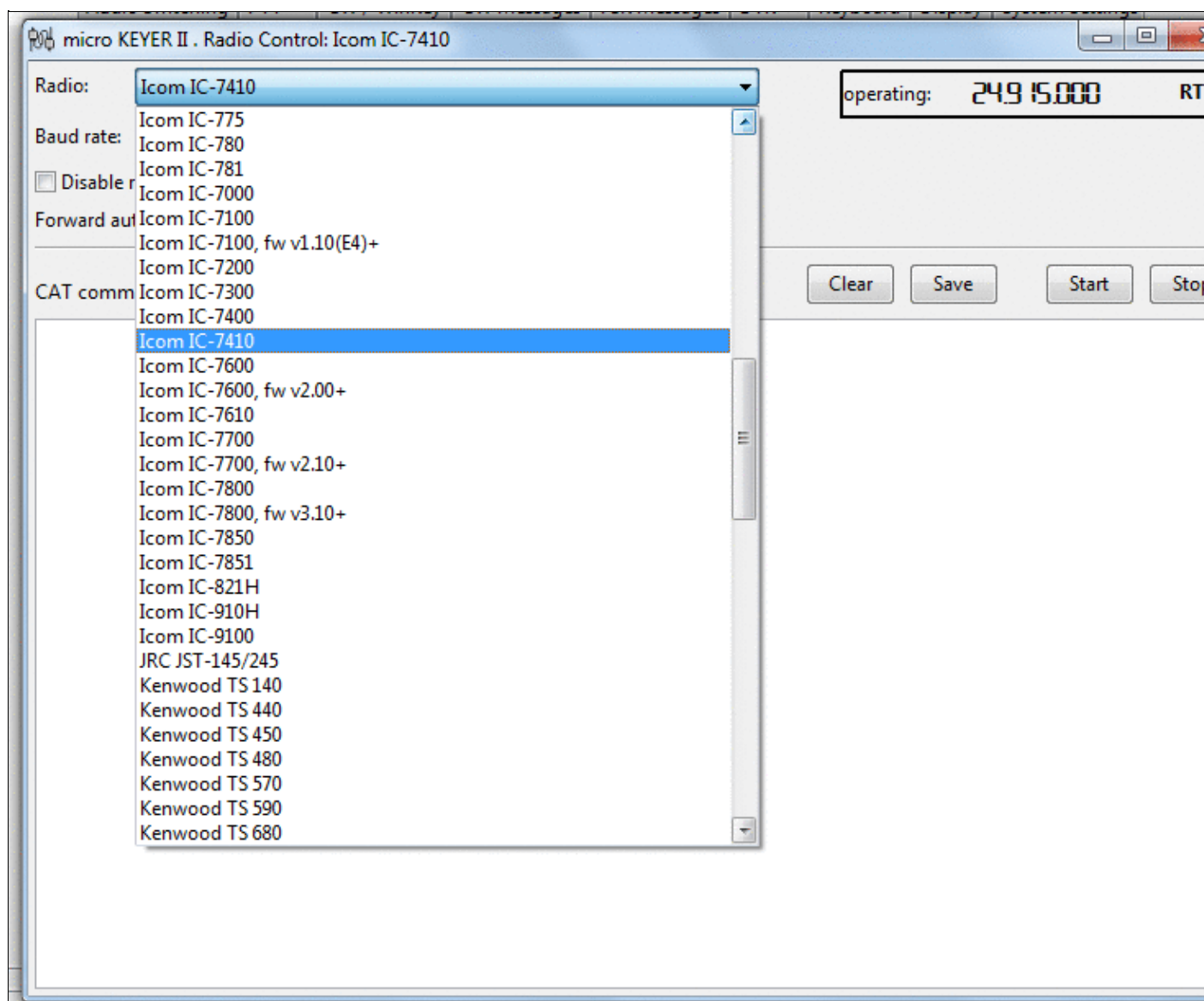

Make sure, the MKII knows about your radio so it can control Audio Switching and PTT depending on the selected mode.

- Go to the Audio Switching Tab
  - ◆ Configure the Audio Switching as shown below.
    - ◇ Have the radio on LSB or USB. Select "Microphone jack, DVK control".
    - ◇ Now switch the radio to FSK mode. Select "line input (rear)".





microHAM MKII Audio Switching setup.

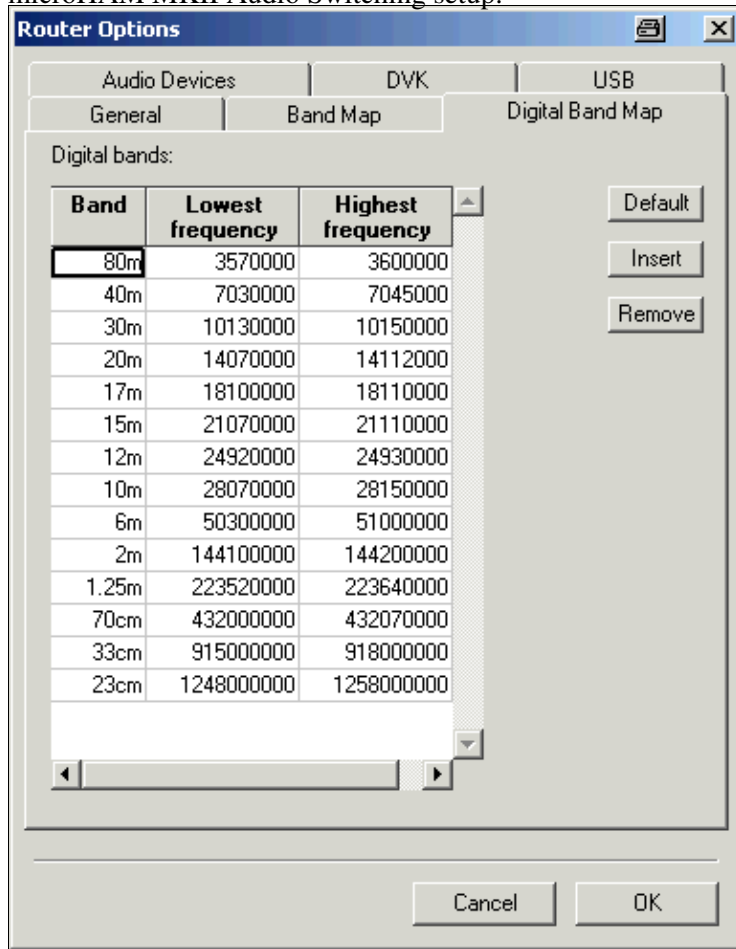

## Win-Test Wiki

This is the digital band map which is used to decide which mode the radio is operating in. With Yaesu radios, MKII retrieves the mode directly from the communication protocol, so this map is not used.

- Go to the Audio Mixing Tab
  - ◆ Select the microHAM CODEC sound device

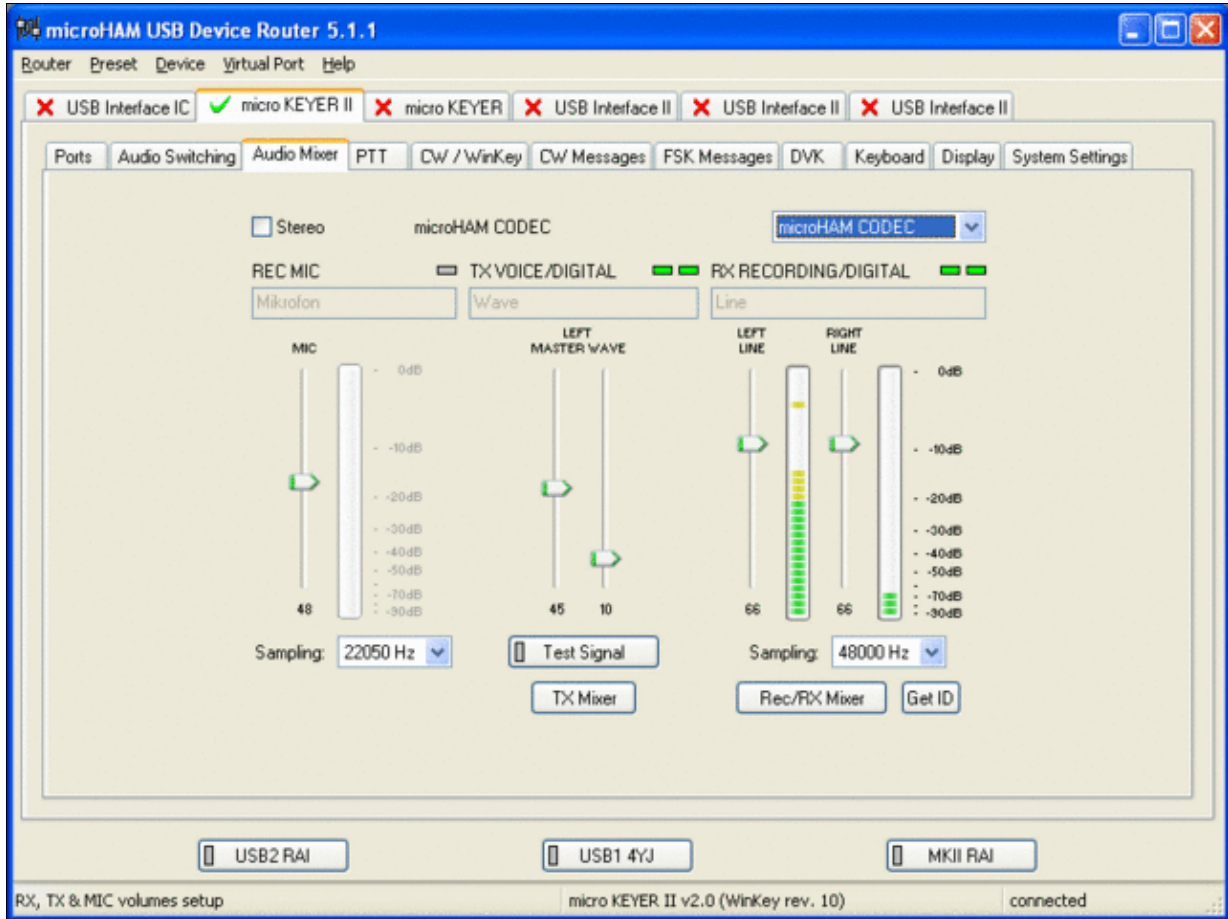

Using the built-in sound card requires selecting it here.

- Go to the PTT Tab
  - ◆ In the PTT selector, select "semi break in" for CW, "PTT1" for Voice and "PTT2" for Digital Modes. This will allow using QSK or VOX operation on CW (which I prefer over the microHAM doing all the switching - but mind hot switching PA relays!). Selecting PTT1 for voice operation will route audio input to the front Mic connector of the radio - avoiding audio level problems.

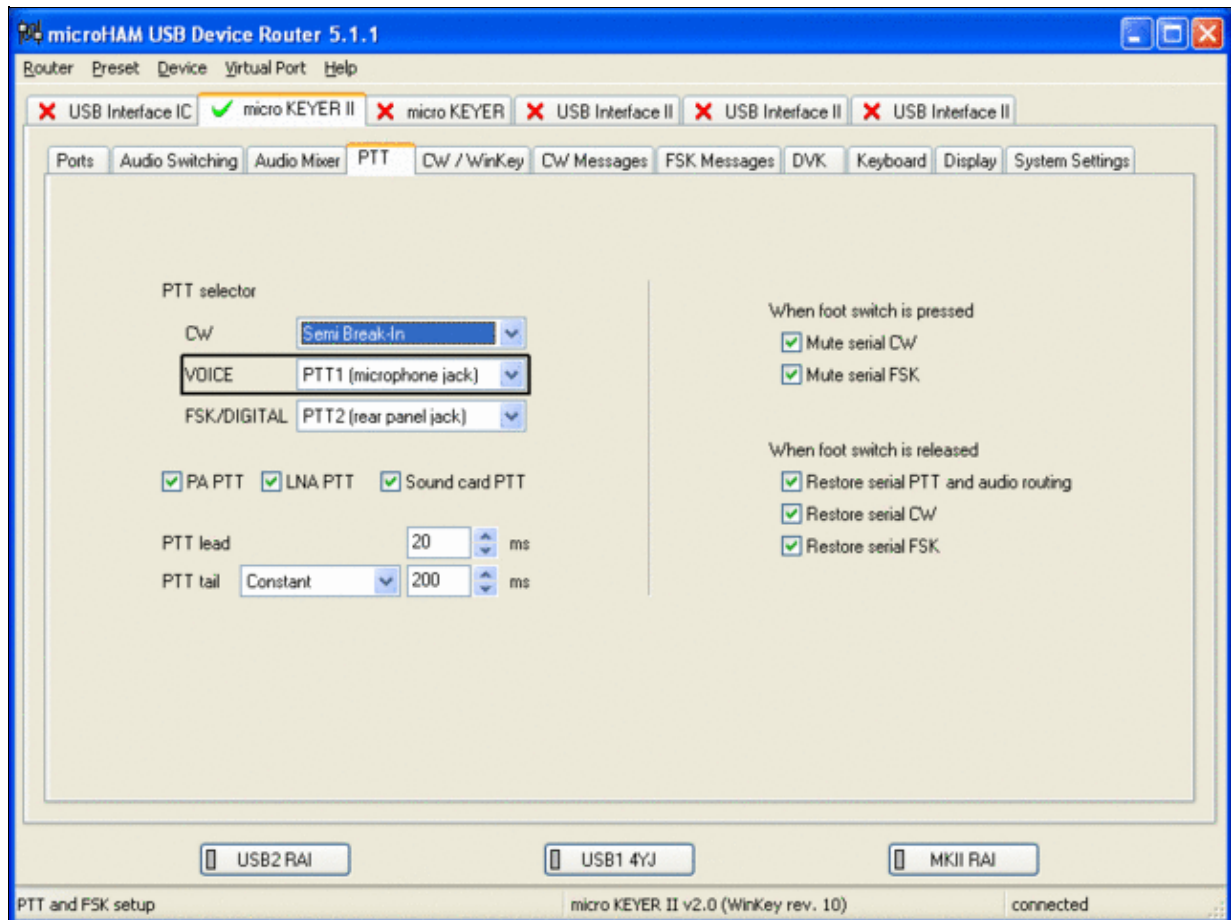

Different PTT settings depending on mode

- Go to the CW/WinKey Tab
  - ◆ My preferred settings are Paddle Mode: Iambic A (Curtis), disable Paddle memory (actually, Dot-Dash-Memory off)



WinKey settings - this is very much depending on your personal preferences

- Testing
  - ◆ Go to a CW frequency, switch the radio to CW and press the VOX button on the radio
  - ◆ Touch the paddle - the radio should switch to transmit without any relay clicking inside the MKII.
  - ◆ The CW/FSK LED on the MKII should flicker with a red light.
  - ◆ Press the Test button on the Winkey port (COM 7) in the Port Tab. The MKII should send **Dah dit dit-dit-dit dah**
  - ◆ Go to a SSB frequency and switch the radio to USB or LSB.
  - ◆ Press the microphone's PTT or the foot switch and say something. The PTT1 LED on the MKII should light up in red color. The radio should go to transmit and produce some output.
  - ◆ Go to the DVK tab, push the RECORD button and say something. Then push the PLAY button. The radio should activate the PTT1 (red light) and transmit your recorded message.
  - ◆ Press the MON button on the radio and listen to the audio. Some audio level adjustments may be required in the Audio Mixer tab.
  - ◆ Go to a RTTY frequency and switch the radio to FSK.
  - ◆ Press the Test button on the FSK port (COM8) in the Port Tab. The radio should switch to transmit, send TEST on RTTY and go back to received.
  - ◆ The CW/FSK LED should flicker with a green light and the PTT2 LED should turn green, while the radio is on transmit.

We are now ready for the next step.

## MMTTY

- Download and Install MMTTY from [here](#).
- Start MMTTY
- Activate the XY Scope by selecting the **View(V)** menu item and tagging **XYScope**

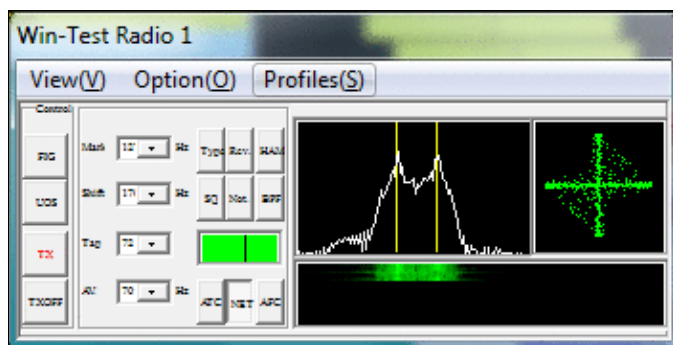

The XY Scope is a practical tuning aid and will help us to visualize the received signals.

- Go to **Option (O) | Setup MMTTY (O) ...**
- Select the Demodulator tab and set it up like in the picture below.



## MMTTY Demodulator settings

- Select the AFC/ATC/PLL tab and make sure AFC is OFF.



MMTTY AFC/ATC/PLL settings. Make sure AFC is off as it will eventually introduce a deviation between TX and RX frequencies.

- Select the TX tab and switch PTT port to COM8. The Radio Command button in this setup screen will allow you to control the radio from within MMTTY. This is not desired in this scenario so make sure it is **not configured** - otherwise Win-Test would not have access to the radio COM port later.



MMTTY Tx settings - PTT is generated by the MKII through COM8

- Select the Misc tab. Since we now have two sound cards - one in the computer, one built into the MKII called microHAM CODEC - we must make sure we're listening on the latter. Switch to the USB router's Audio Mixer Tab and get the device ID by clicking on the button "Get ID" in the lower right corner. This ID must be entered into MMTTY's Device ID field. When listening on the correct device, the LINE LED on the MKII should be lit.
- Also from the Misc tab, select COM-TxD(FSK).



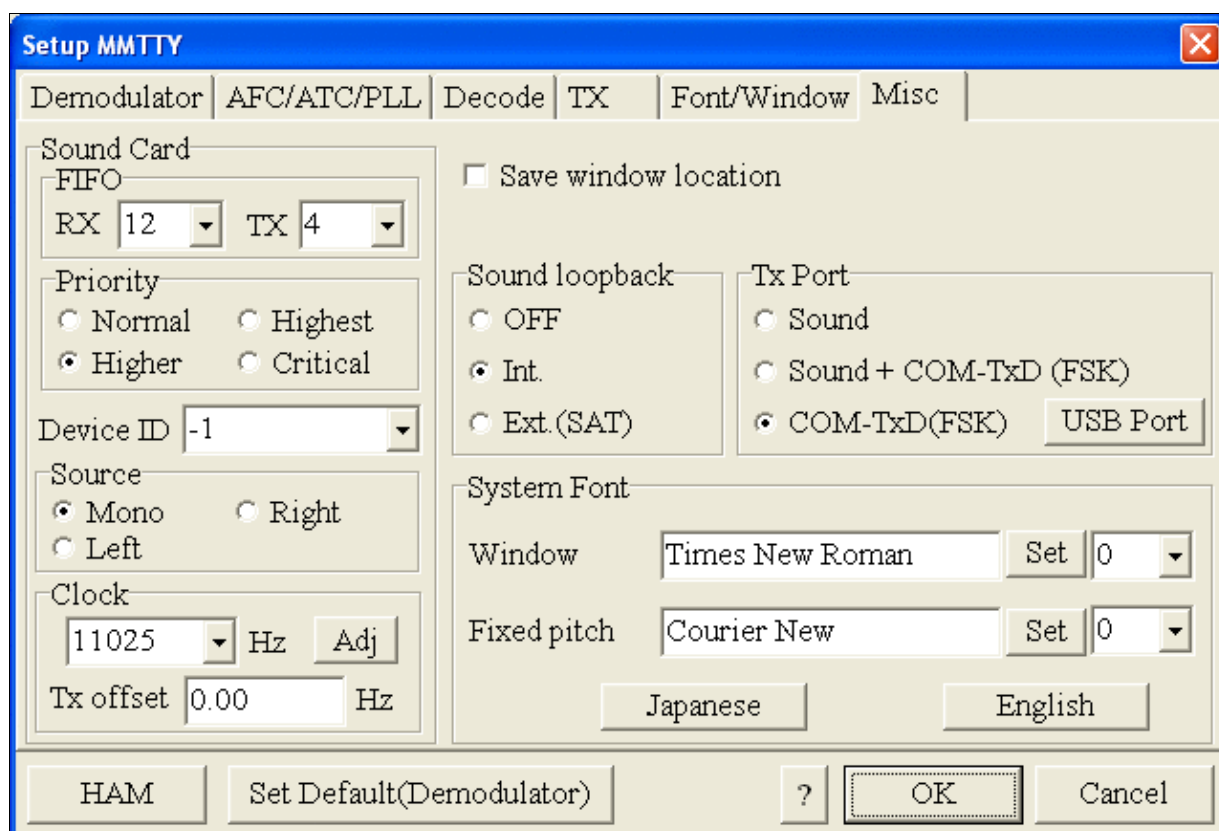

MMTTY Misc settings - FSK is generated via COM8

- Should you have problems generating the FSK signal (especially: keying does work, you hear the RTTY diddle, but no characters are being transmitted), you might have to limit the USB port speed in MMTTY. This setting depends very much on the computer hardware. To limit the USB port speed click on **USB Port** and configure option "C". You can find this setting also in the support documentation of the Microkeyer on the microHAM website.

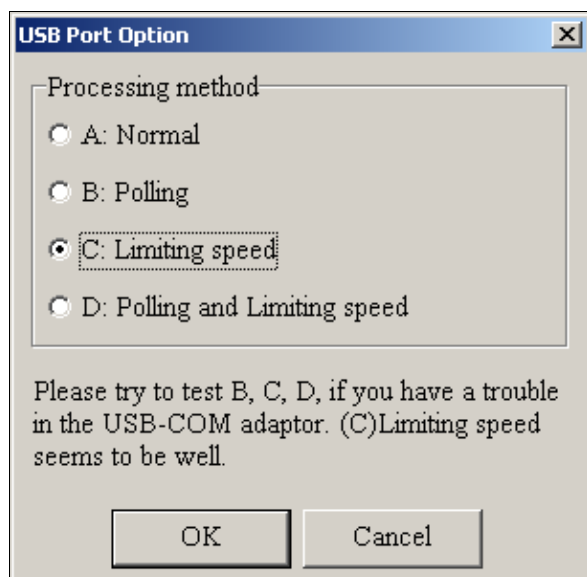

MMTTY USB Port Option - Set only to option C if A does not work for you.

- Exit the Setup screens by pressing the OK button.

We are now ready to do some tests with MMTTY.

- Now take a look at the XY Scope display. It should look like the picture above.
- If you only see a single white point in the middle of the display, this means, that MMTTY gets no audio to process.
  - ◆ Check your cabling. Is your cable connected to Line-in or Mic-in?
  - ◆ Did you select the correct audio device?
  - ◆ Check the level settings for the sound card from the USB Router's Audio Mixer tab. When you move the control up and down you should see an increase and decrease in noise level.

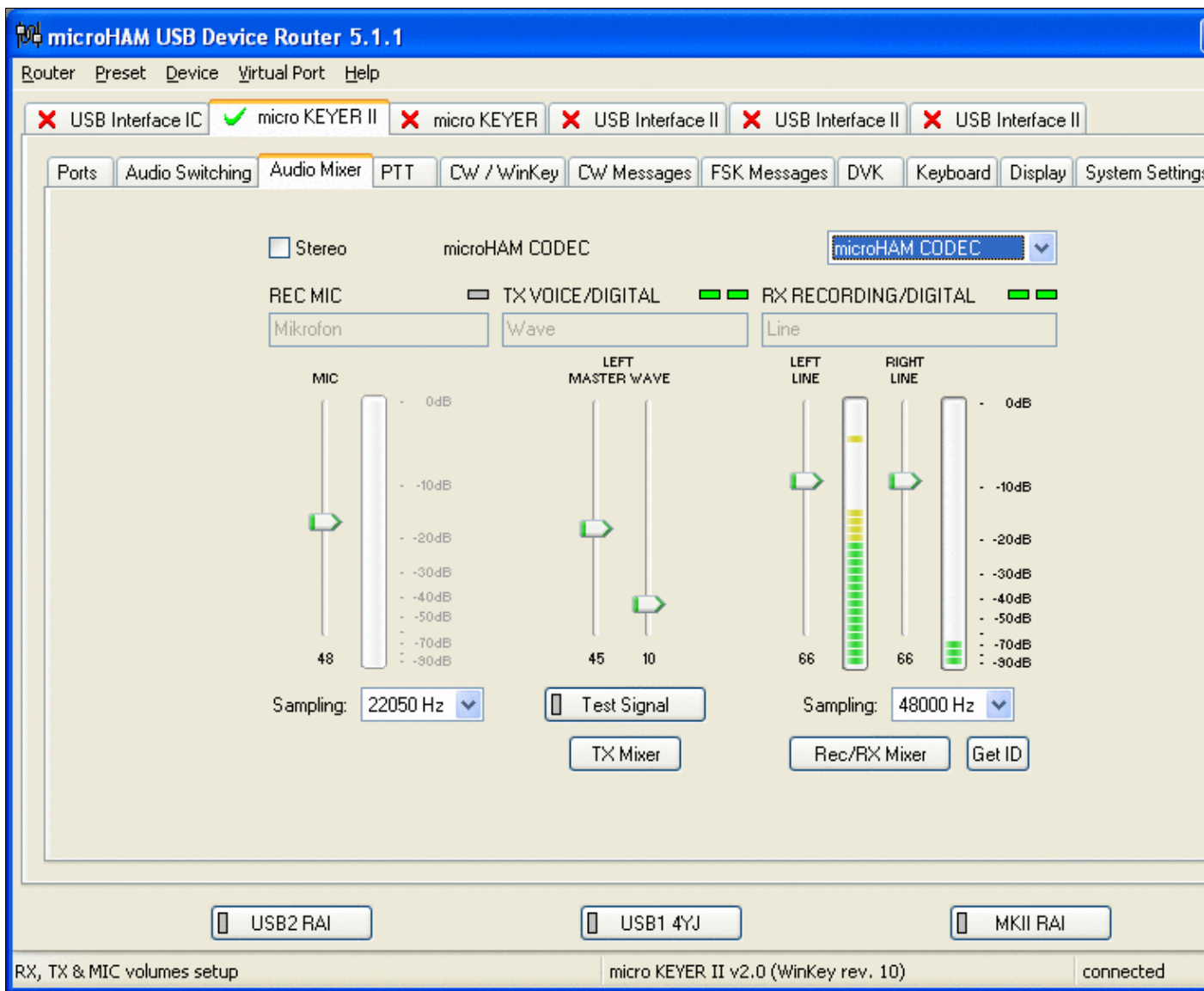

## Win-Test Wiki

Setting the correct audio level on the microHAM CODEC sound card

- Tune across the CW band and check if the XY scope changes when you hear signals. Once you tune across a carrier or CW signal, you should see a vertical ellipse and then a horizontal ellipse or vice versa depending on which direction you tune. The receive section of the screen will show all kinds of clutter.
- Try to find a RTTY signal (not easy on a normal day). Both ellipses should now be perpendicular to each other. See if you can decode RTTY fine. You may have to select proper filters. I use 500 Hz at 8.8 MHz IF and 2.7 kHz at 455 kHz IF.
- Next, press the TX button in the MMTTY application. You should hear the typical RTTY diddle in the monitor of the radio. The XY Scope will also display a clean RTTY signal.
- Type a few characters (including your callsign) and see how they are transmitted.
- Press the TX button one more time to shut off transmission.
- Exit the MMTTY program now.

MMTTY now works perfectly as a stand-alone program. We are now ready for Win-Test.

## Win-Test

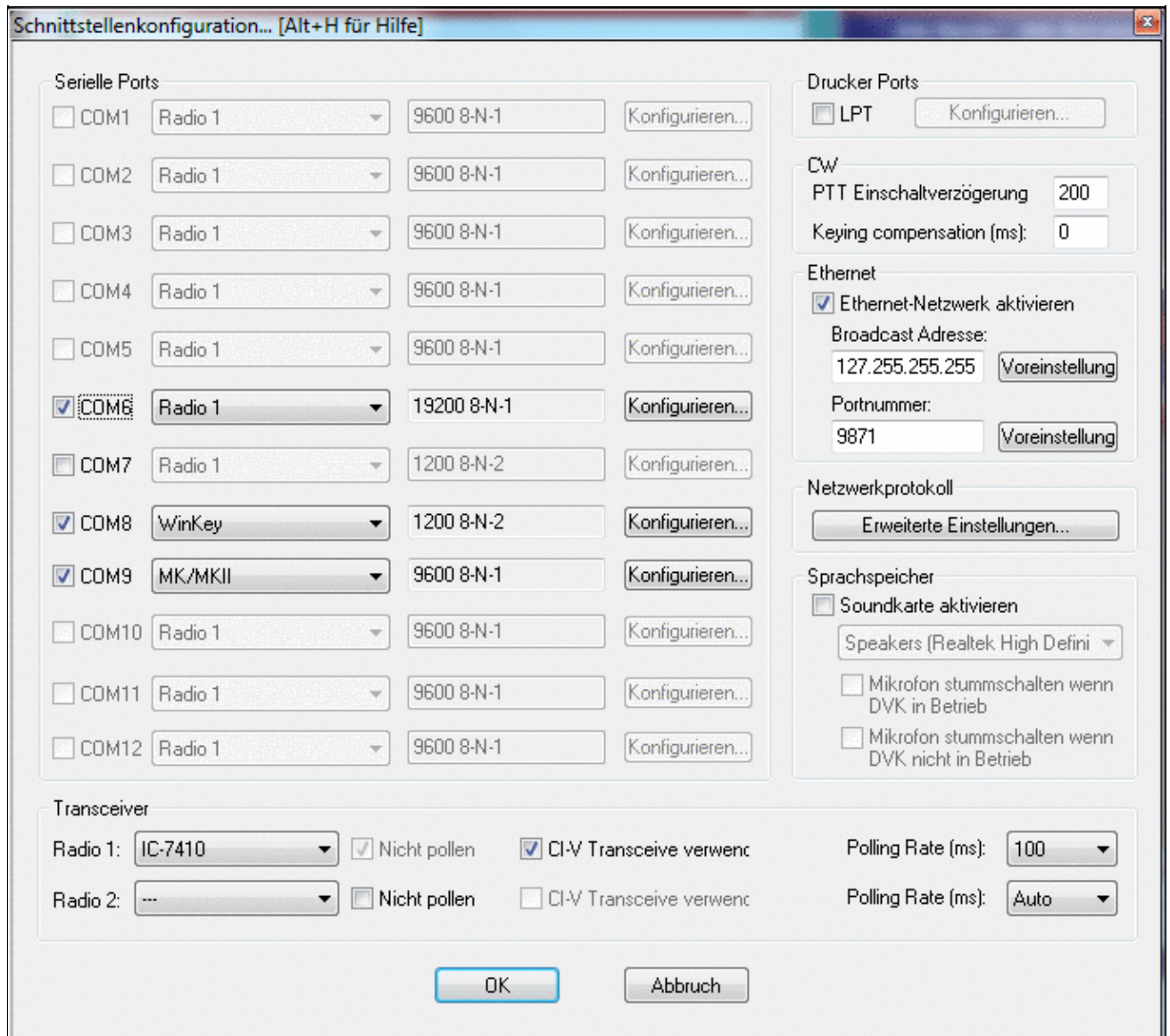

Final steps: Win-Test Interfaces configuration. Note that we only set up three COM ports, no PTT or CW settings are needed as they are all generated/controlled by the MKII.

- Start up Win-Test, create a new Win-Test file for testing.
- Select DXpedition and allow All Modes so you can test all three different modes.
- in the **Options | Configure Interfaces...** menu
  - ◆ configure Radio on COM6
  - ◆ configure Winkey on COM7 using default settings
  - ◆ configure microHAM MK/MKII on COM9
  - ◆ untag Win-Test's internal Voice Keyer
- Go to Configure MMTTY.EXE startup path as described in the [RTTY section of this manual](#) if you are planning for RTTY operation

We are now ready to operate the contest.

## Namespaces

- [Page](#)
- [Discussion](#)

## Variants

## Views

- [Read](#)
- [View source](#)
- [View history](#)

## More

- This page was last edited on 9 June 2022, at 16:27.
- [Privacy policy](#)
- [About Win-Test Wiki](#)
- [Disclaimers](#)



# BestPractice10

From Win-Test Wiki

[Jump to navigation](#) [Jump to search](#)

## Contents

- [1 Setting up the ICOM IC-7851 + microKeyer MK III](#)
- [2 ICOM IC-7581](#)
- [3 microHAM MKII](#)
- [4 microHAM USB Device Router](#)
- [5 MMTTY](#)
- [6 Win-Test](#)

## Setting up the ICOM IC-7851 + microKeyer MK III

+++ This article is still under construction +++

This article is a step by step approach describing how to set up an ICOM IC-7851 radio and a microHAM microKeyer III interface. The MK III is a complex device integrating a CW-Keyer, CW and FSK keying, PTT control (including a delayed PTT), radio control and a sound card, a digital voice keyer which allows to control up to ten audio memories and different audio switching scenarios. This article covers the set-up of CW, RTTY and SSB in several steps.

Support for the ICOM IC-7581 implemented WinTest 4.20. Be sure, you are running a current version of WinTest.

[BestPractice1](#) article describes a slightly simpler set-up with the Microham USB Interface II. [BestPractice4](#) article describes a slightly simpler set-up with the microHAM microKeyer. Please see there for background information about RTTY and MMTTY in general.

## ICOM IC-7581

- In the RTTY mode, push [MENU] to display the `M1` screen (Menu 1)
- Push [RTTY](F-4) to display the `RTTY` screen
- Push [SET](F-5) to enter the RTTY Set mode
- Push [Y](F-1) or [Z](F-2) to select the desired item
  - ◆ Set *RTTY Mark Freq* to 1275 (use VFO knob to step through available options)
  - ◆ Set *RTTY Shift Width* to 170 (use VFO knob to step through available options)
  - ◆ Set *Keying Pol* to NORMAL (use VFO knob to step through available options)
- Push [MENU] to save, and return to the `RTTY` screen
- Push [MENU] again to return to the `M1` screen

To test the settings, put the radio to FSK mode, push the MONITOR button, make sure MONI GAIN is set to the 12 o'clock position and then switch the radio to transmit by pressing TRANSMIT. You should now hear a 1275 Hz tone.

**Note:** The built-in RTTY decoder in the IC-7410 only works with High Tones selected. I personally prefer listening to low tones and so this article focusses on 1275 Hz/1445 Hz, but actually it's up to you.

## microHAM MKII

- Connect the MKII to a 12V DC source. Optionally you can feed the MKII via the DB37 cable by setting the jumper inside the MK-II very close to the 13.8 V DC jack.
- Connect a footswitch to the FOOTSW connector of the MKII.
- Connect your microphone or headset to the short RJ45 cable that goes into MIC on the MKII (this connector does also provide the 8V DC voltage on pin 5 for your electret microphone - for ICOM you have to enable this; do not try to use dynamic microphones with ICOM radios, this will fail - audio level is too low).
- Connect the microHAM MKII to your radio and computer.
  - ◆ On the radio side there will be five connections: KEY, RTTY, PACKET, CAT, AF OUT and microphone.
  - ◆ On the computer side there will be only a single connection: USB. I had to use a ferrite core to get rid of RF noise.
- Install the microHAM software if you haven't done so already. There are two steps to it:
  - ◆ Installing the device driver - if you have several microHAM devices you will have to do this once for each of them.
  - ◆ Installing the USB Device Router - this software only needs to be installed once. It is identical on all microHAM products.

**Note:** If you had previously installed the USB Device Router with another microHAM product, it will come up with a new tab for the new hardware connected.

## microHAM USB Device Router

- Set up the Device Router
- Go to the Ports Tab
  - ◆ Create virtual COM ports: COM6, COM7, COM8 and COM9. Note: The absolute port numbers do not matter. The key is consistency - the same port number must be used for a specific function every time it is used.
  - ◆ Configure Radio on COM6
  - ◆ Press the **Set** button to the right of the radio port configuration and select Icom IC-7410. MKII will assign different Audio Routing and PTT scenarios if it knows what frequency and mode the radio is set. This is why we have to do it.
  - ◆ You should now see the current frequency of the radio display in the **Ports** tab
  - ◆ Configure FSK on COM7. Make sure you tick the PTT tag
  - ◆ Configure Winkey COM8 using Winkey default settings
  - ◆ Configure Control on COM9. This will allow controlling the MKII, especially the DVK from Win-Test.

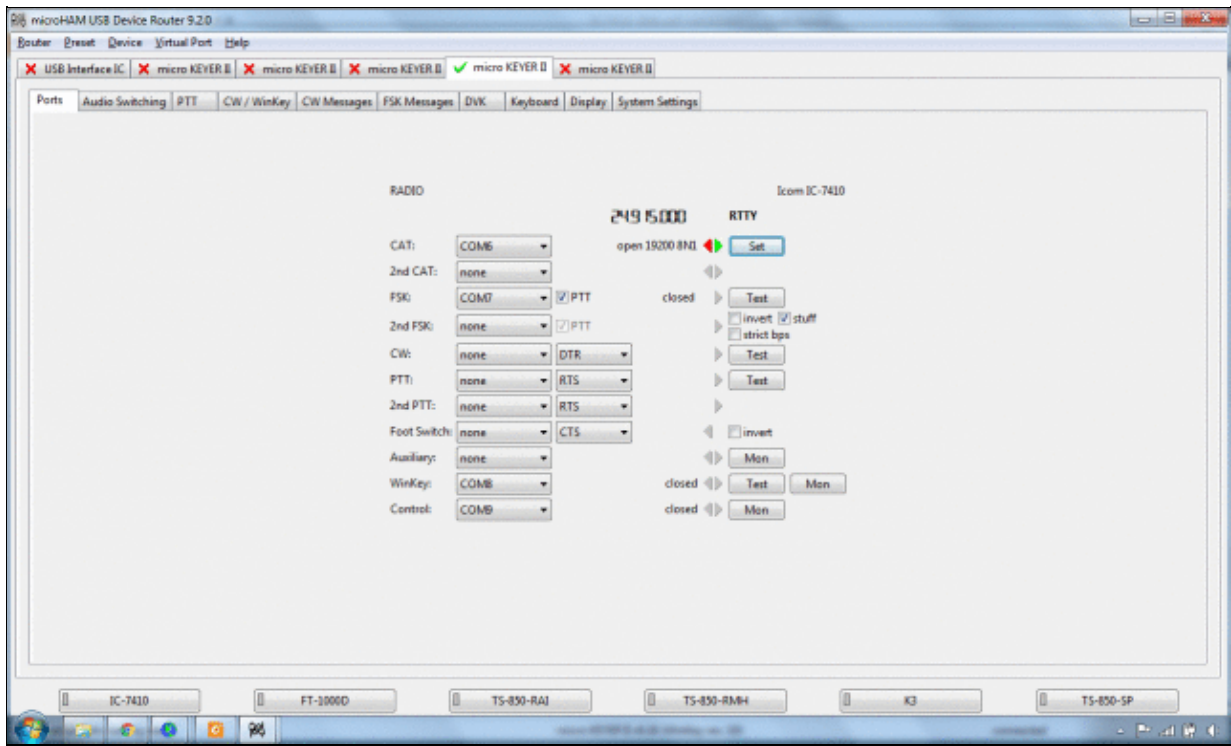

microHAM MKII Ports setup. We use COM6,7,8 and 9 to control different properties of the MKII.



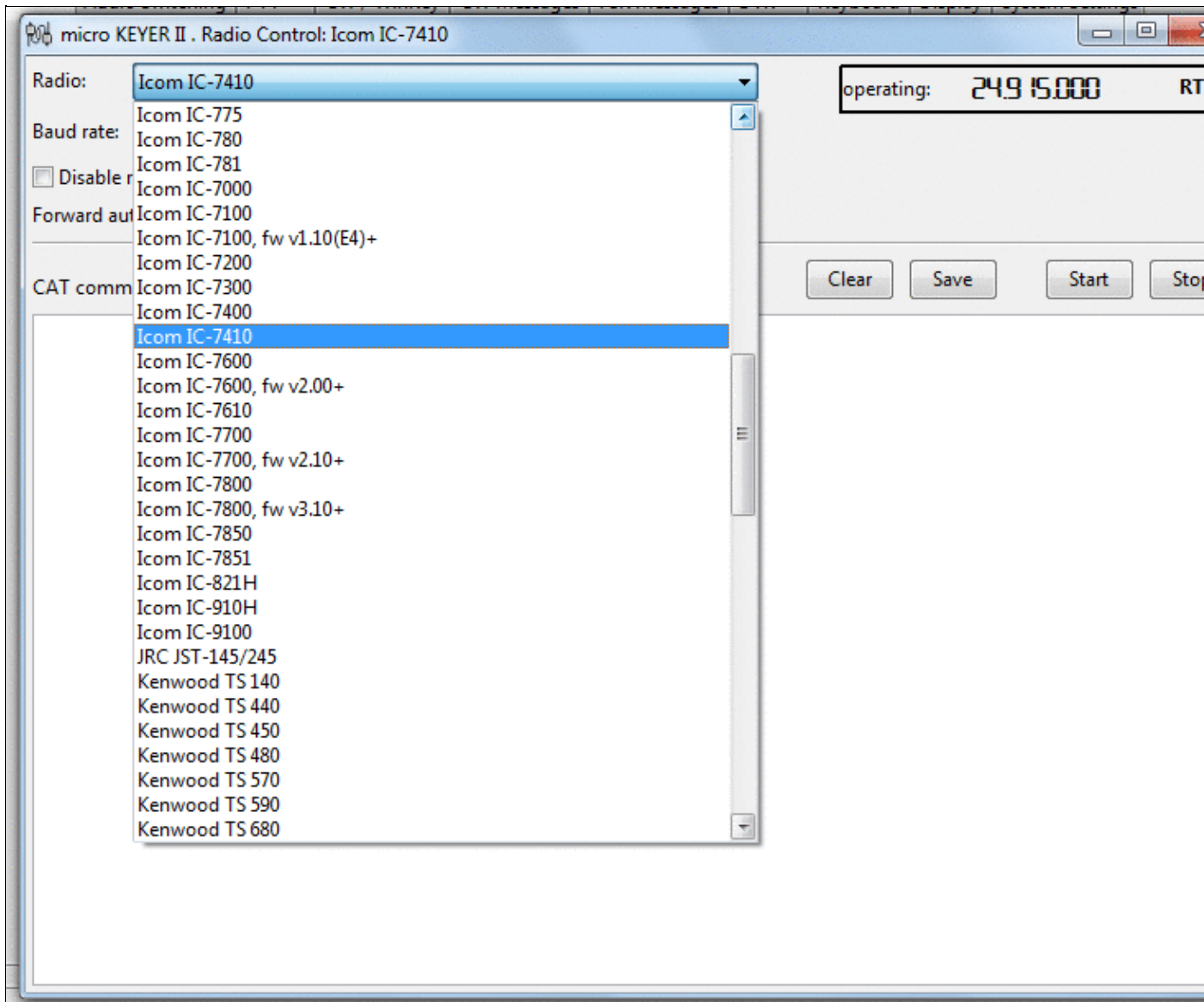

Make sure, the MKII knows about your radio so it can control Audio Switching and PTT depending on the selected mode.

- Go to the Audio Switching Tab
  - ◆ Configure the Audio Switching as shown below.
    - ◇ Have the radio on LSB or USB. Select "Microphone jack, DVK control".
    - ◇ Now switch the radio to FSK mode. Select "line input (rear)".

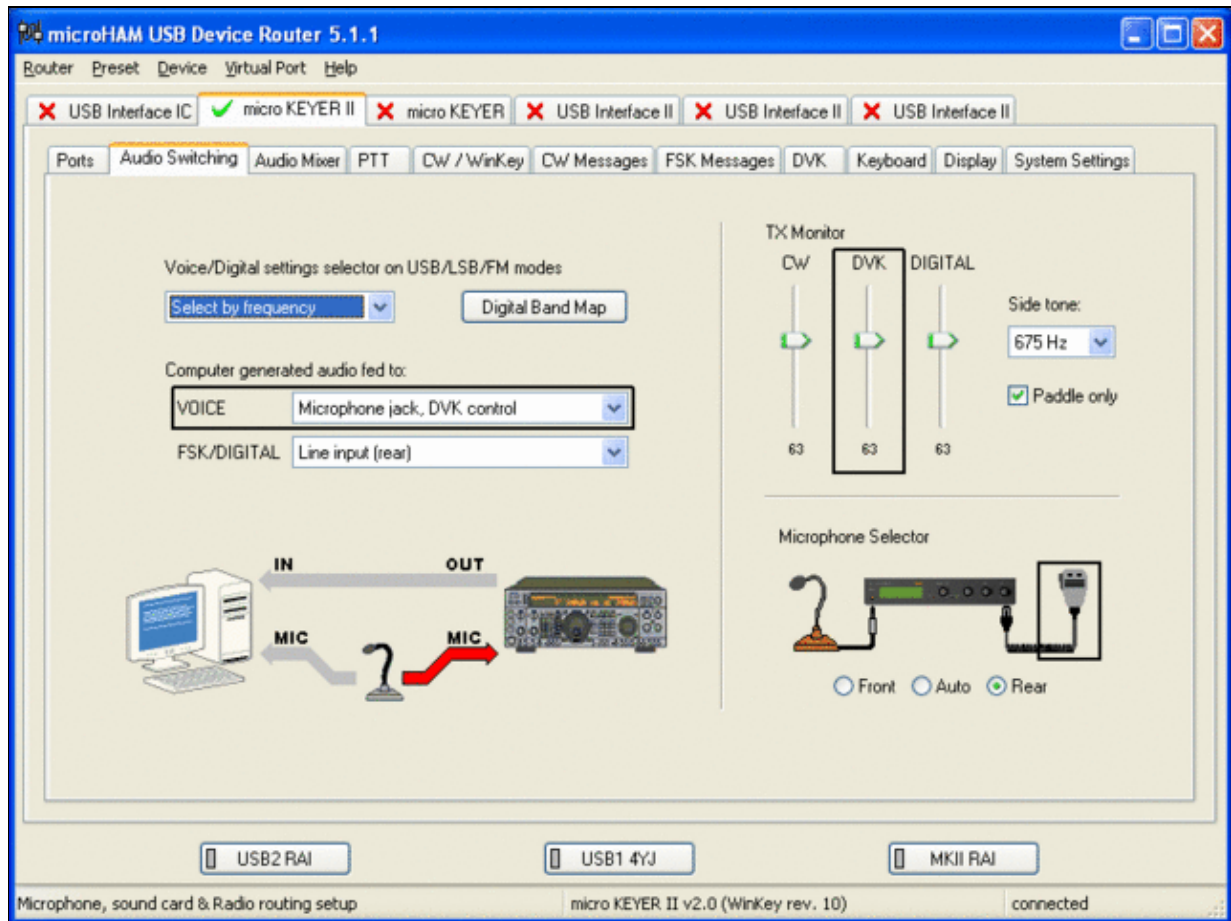

## microHAM MKII Audio Switching setup.

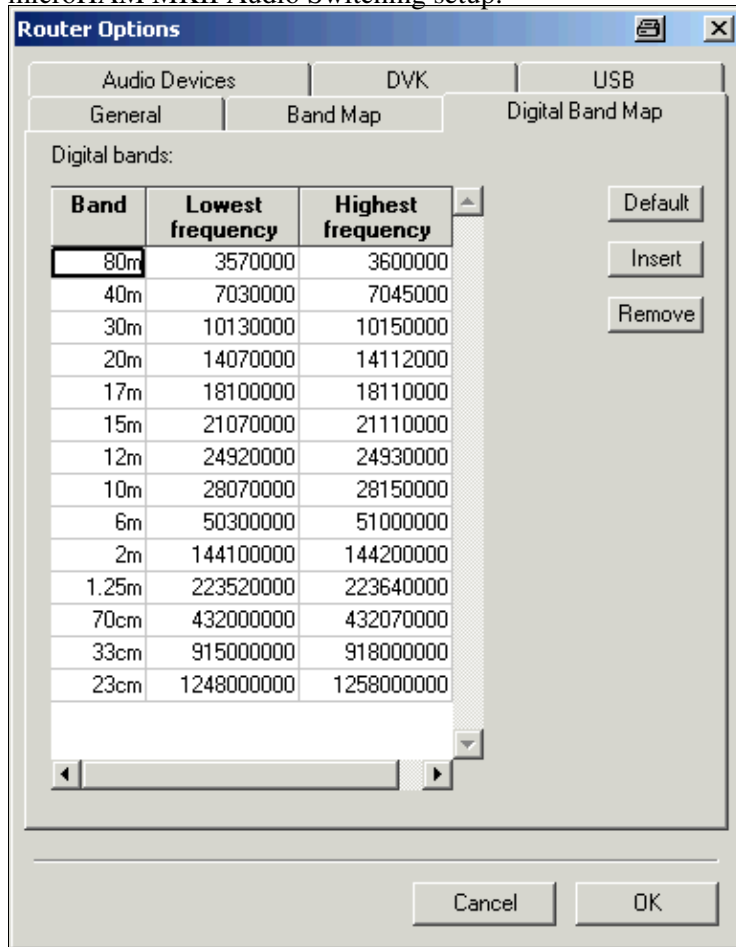

## Win-Test Wiki

This is the digital band map which is used to decide which mode the radio is operating in. With Yaesu radios, MKII retrieves the mode directly from the communication protocol, so this map is not used.

- Go to the Audio Mixing Tab
  - ◆ Select the microHAM CODEC sound device

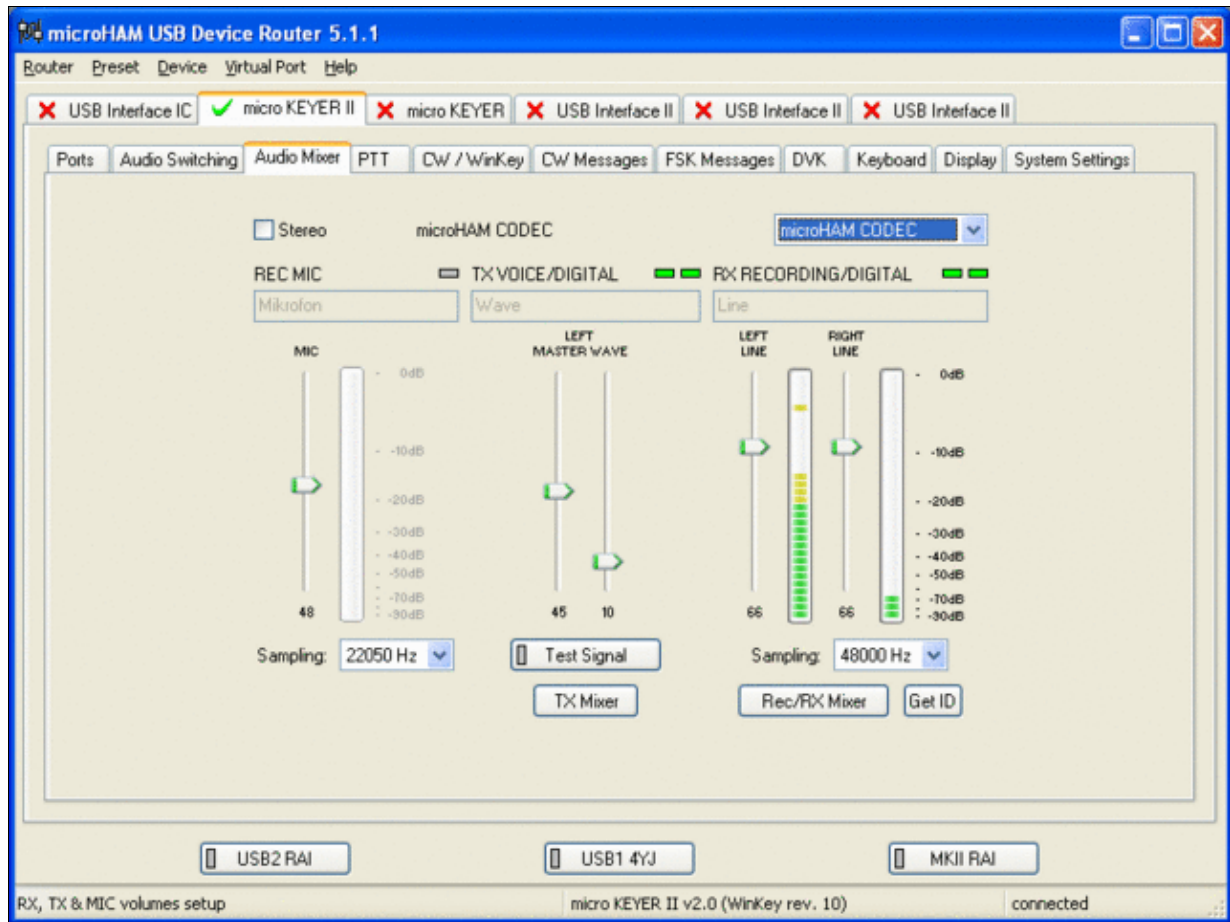

Using the built-in sound card requires selecting it here.

- Go to the PTT Tab
  - ◆ In the PTT selector, select "semi break in" for CW, "PTT1" for Voice and "PTT2" for Digital Modes. This will allow using QSK or VOX operation on CW (which I prefer over the microHAM doing all the switching - but mind hot switching PA relays!). Selecting PTT1 for voice operation will route audio input to the front Mic connector of the radio - avoiding audio level problems.

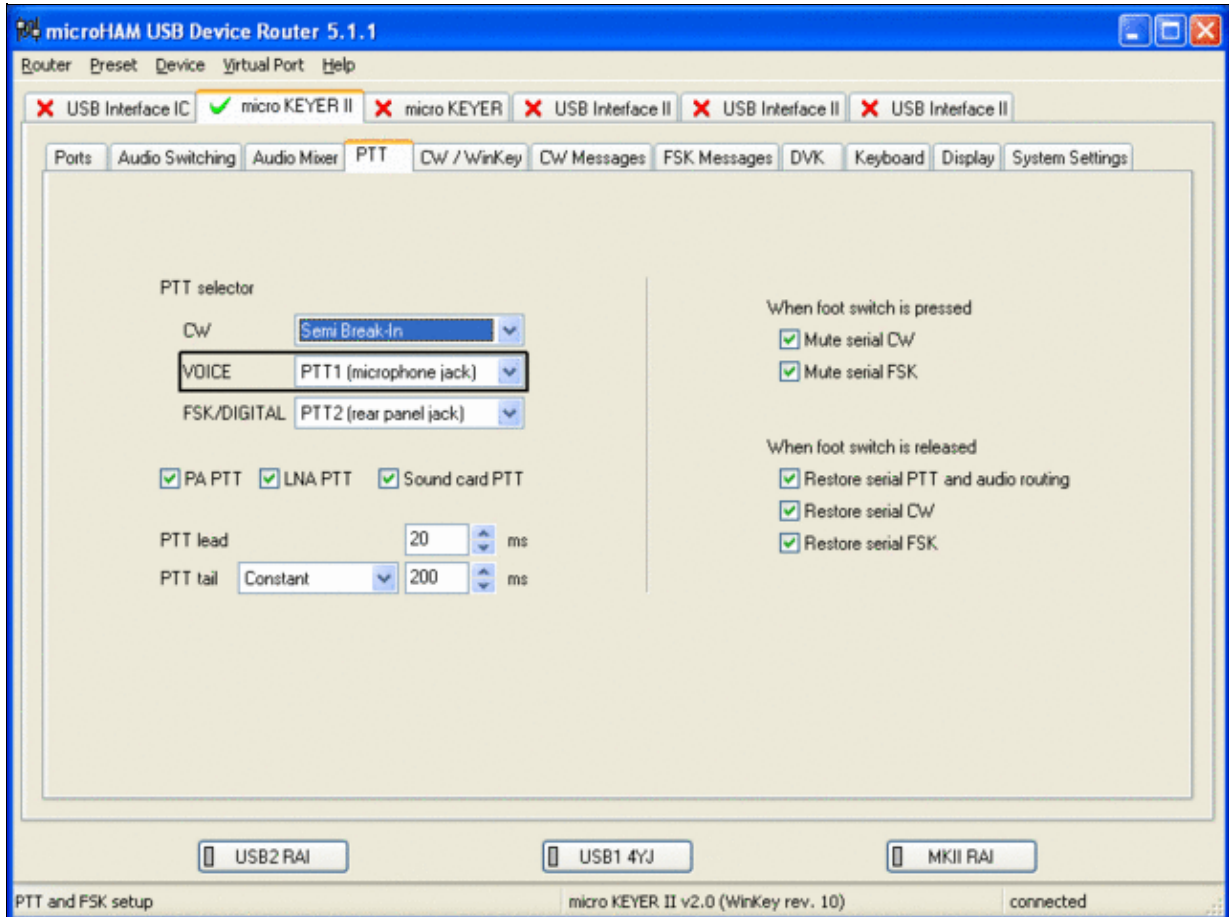

Different PTT settings depending on mode

- Go to the CW/WinKey Tab
  - ◆ My preferred settings are Paddle Mode: Iambic A (Curtis), disable Paddle memory (actually, Dot-Dash-Memory off)

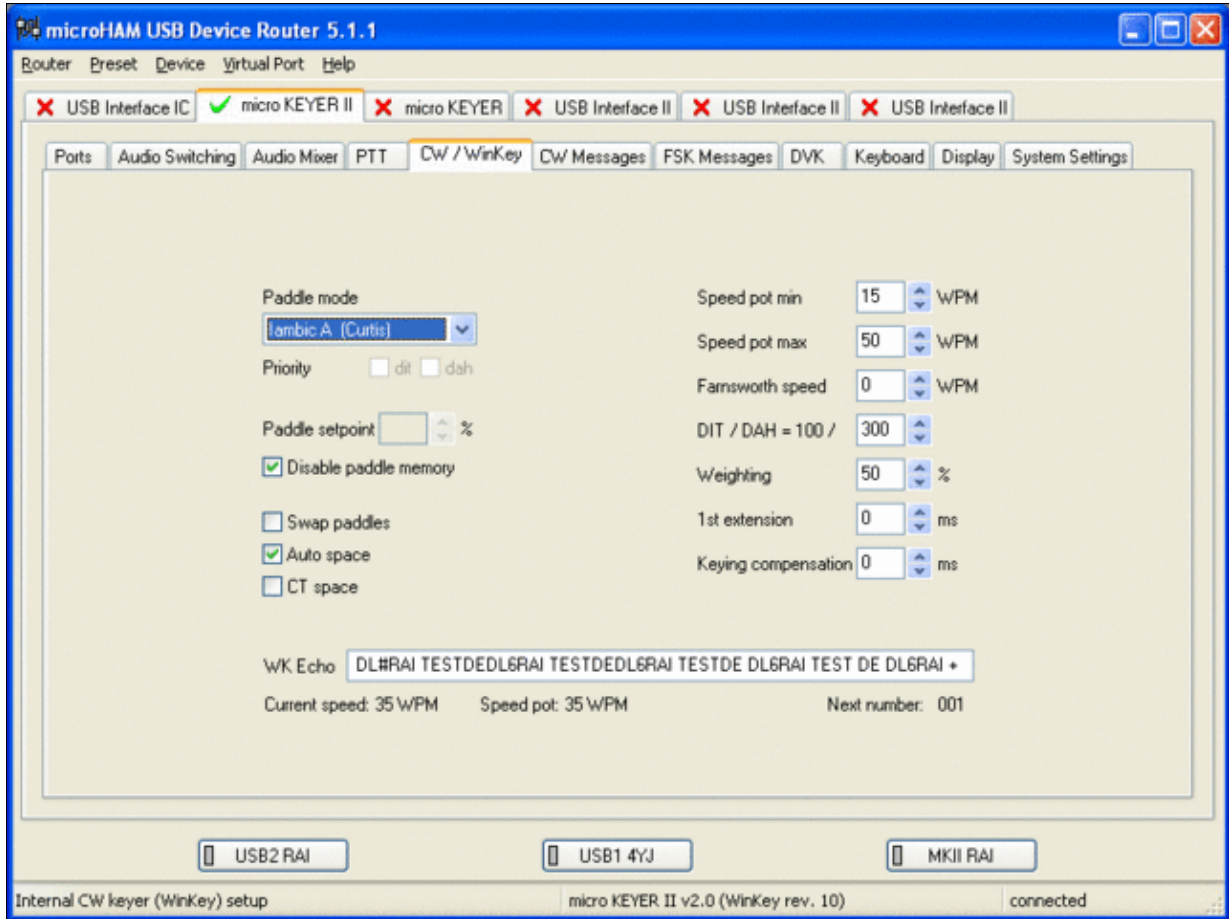

WinKey settings - this is very much depending on your personal preferences

- Testing
  - ◆ Go to a CW frequency, switch the radio to CW and press the VOX button on the radio
  - ◆ Touch the paddle - the radio should switch to transmit without any relay clicking inside the MKII.
  - ◆ The CW/FSK LED on the MKII should flicker with a red light.
  - ◆ Press the Test button on the Winkey port (COM 7) in the Port Tab. The MKII should send **Dah dit dit-dit-dit dah**
  - ◆ Go to a SSB frequency and switch the radio to USB or LSB.
  - ◆ Press the microphone's PTT or the foot switch and say something. The PTT1 LED on the MKII should light up in red color. The radio should go to transmit and produce some output.
  - ◆ Go to the DVK tab, push the RECORD button and say something. Then push the PLAY button. The radio should activate the PTT1 (red light) and transmit your recorded message.
  - ◆ Press the MON button on the radio and listen to the audio. Some audio level adjustments may be required in the Audio Mixer tab.
  - ◆ Go to a RTTY frequency and switch the radio to FSK.
  - ◆ Press the Test button on the FSK port (COM8) in the Port Tab. The radio should switch to transmit, send TEST on RTTY and go back to received.
  - ◆ The CW/FSK LED should flicker with a green light and the PTT2 LED should turn green, while the radio is on transmit.

We are now ready for the next step.

## MMTTY

- Download and Install MMTTY from [here](#).
- Start MMTTY
- Activate the XY Scope by selecting the **View(V)** menu item and tagging **XYScope**

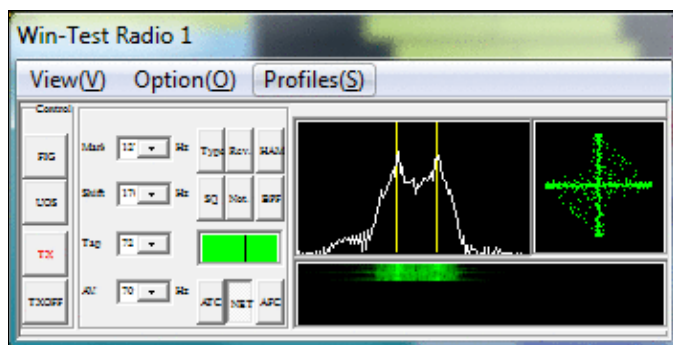

The XY Scope is a practical tuning aid and will help us to visualize the received signals.

- Go to **Option (O) | Setup MMTTY (O) ...**
- Select the Demodulator tab and set it up like in the picture below.

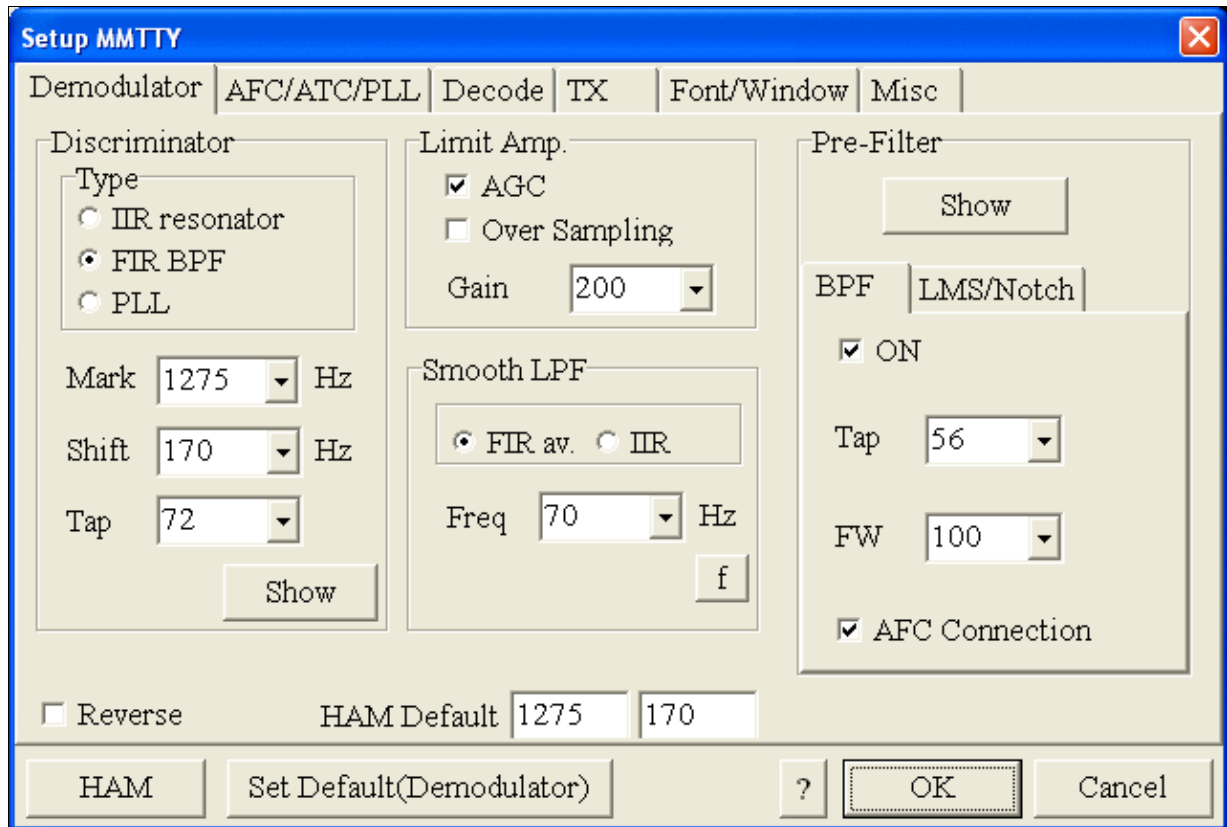



## MMTTY Demodulator settings

- Select the AFC/ATC/PLL tab and make sure AFC is OFF.

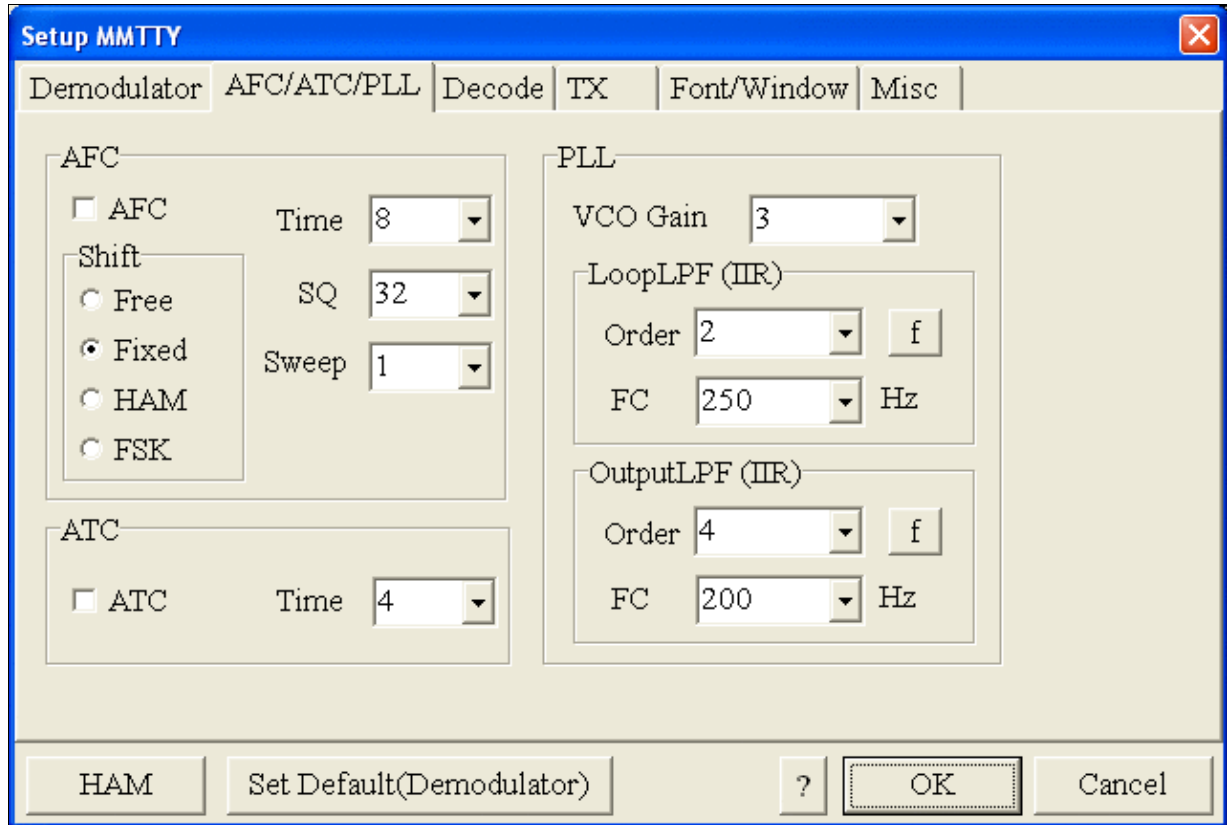

MMTTY AFC/ATC/PLL settings. Make sure AFC is off as it will eventually introduce a deviation between TX and RX frequencies.

- Select the TX tab and switch PTT port to COM8. The Radio Command button in this setup screen will allow you to control the radio from within MMTTY. This is not desired in this scenario so make sure it is **not configured** - otherwise Win-Test would not have access to the radio COM port later.

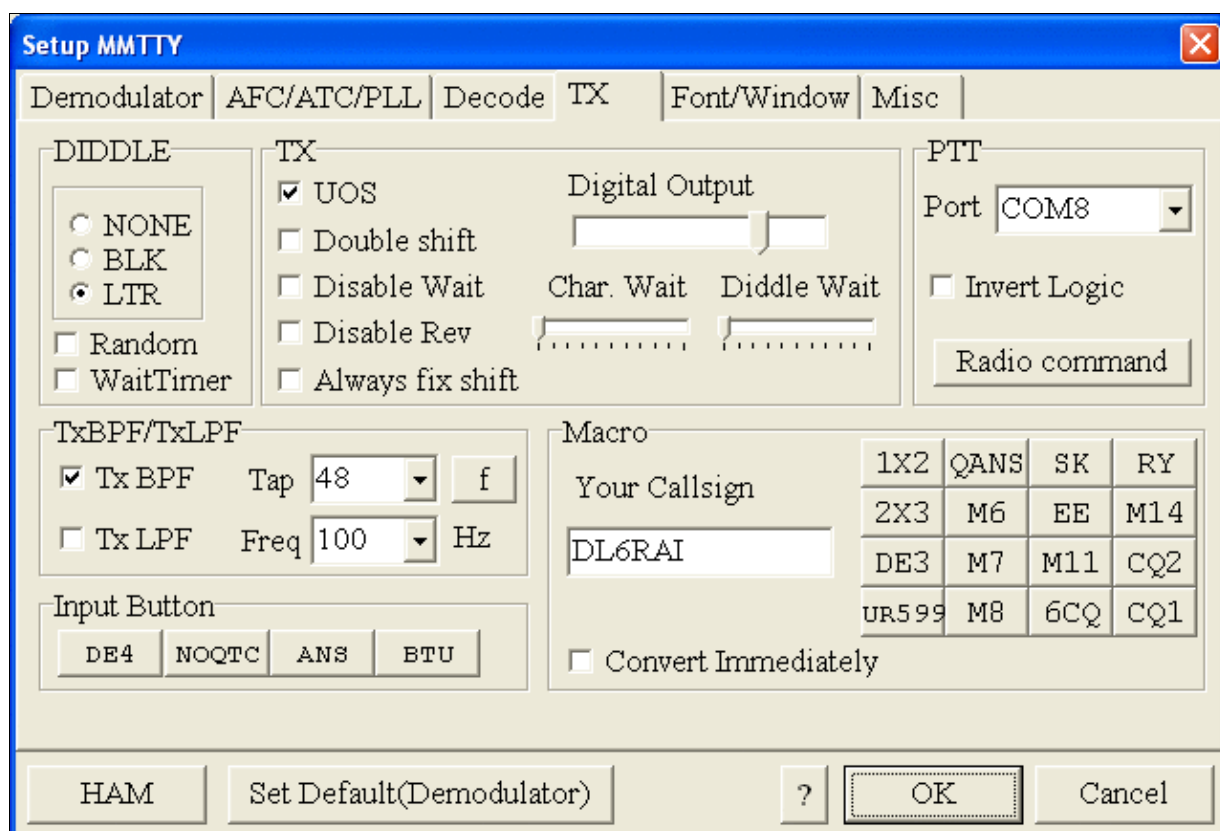

MMTTY Tx settings - PTT is generated by the MKII through COM8

- Select the Misc tab. Since we now have two sound cards - one in the computer, one built into the MKII called microHAM CODEC - we must make sure we're listening on the latter. Switch to the USB router's Audio Mixer Tab and get the device ID by clicking on the button "Get ID" in the lower right corner. This ID must be entered into MMTTY's Device ID field. When listening on the correct device, the LINE LED on the MKII should be lit.
- Also from the Misc tab, select COM-TxD(FSK).

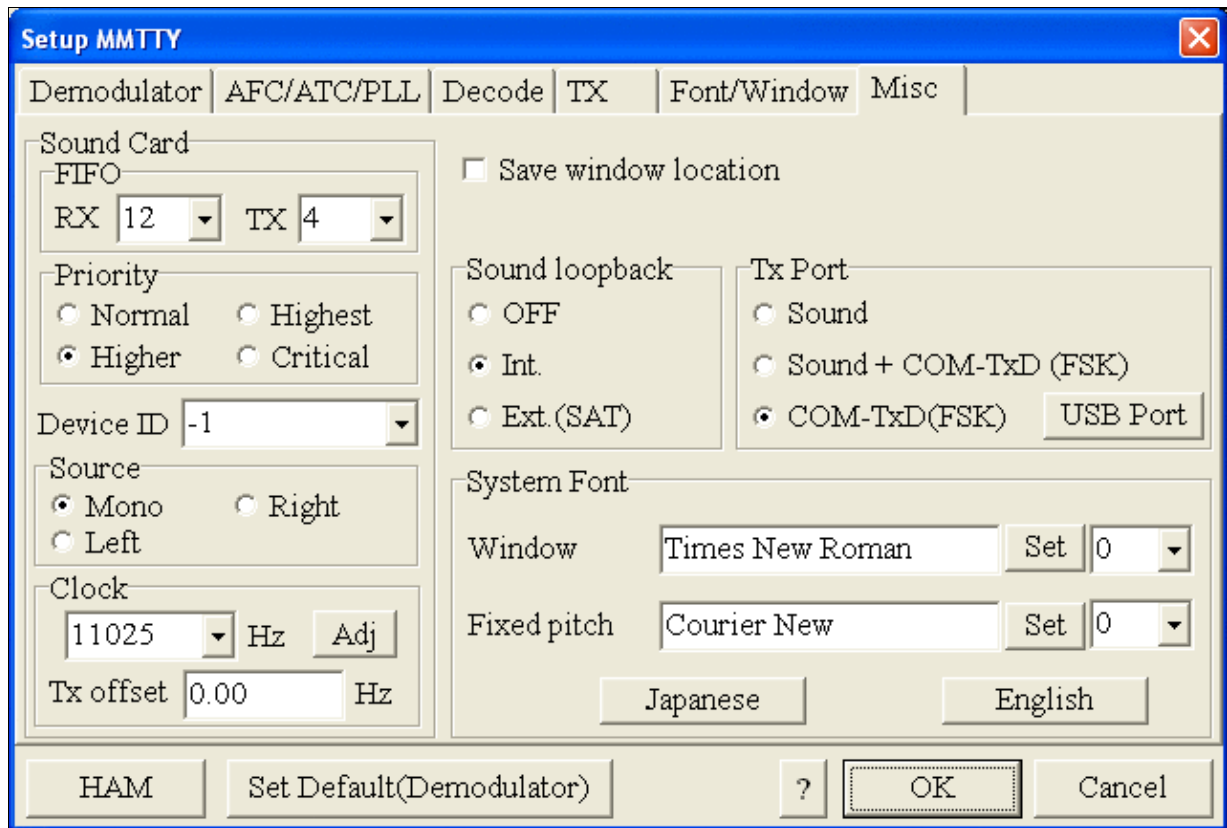

MMTTY Misc settings - FSK is generated via COM8

- Should you have problems generating the FSK signal (especially: keying does work, you hear the RTTY diddle, but no characters are being transmitted), you might have to limit the USB port speed in MMTTY. This setting depends very much on the computer hardware. To limit the USB port speed click on **USB Port** and configure option "C". You can find this setting also in the support documentation of the Microkeyer on the microHAM website.

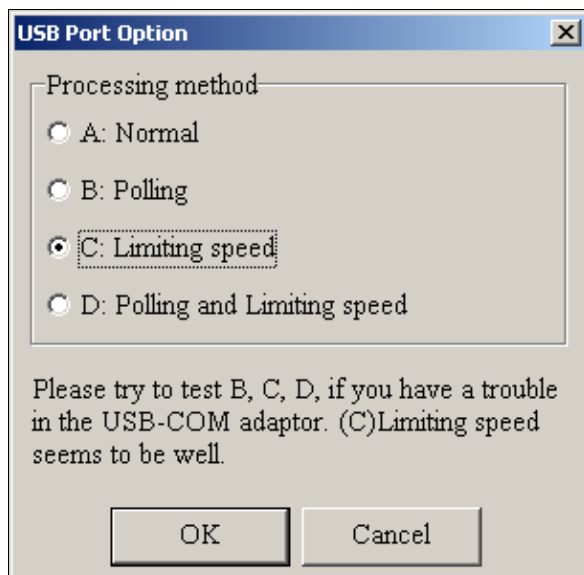

MMTTY USB Port Option - Set only to option C if A does not work for you.

- Exit the Setup screens by pressing the OK button.

We are now ready to do some tests with MMTTY.

- Now take a look at the XY Scope display. It should look like the picture above.
- If you only see a single white point in the middle of the display, this means, that MMTTY gets no audio to process.
  - ◆ Check your cabling. Is your cable connected to Line-in or Mic-in?
  - ◆ Did you select the correct audio device?
  - ◆ Check the level settings for the sound card from the USB Router's Audio Mixer tab. When you move the control up and down you should see an increase and decrease in noise level.

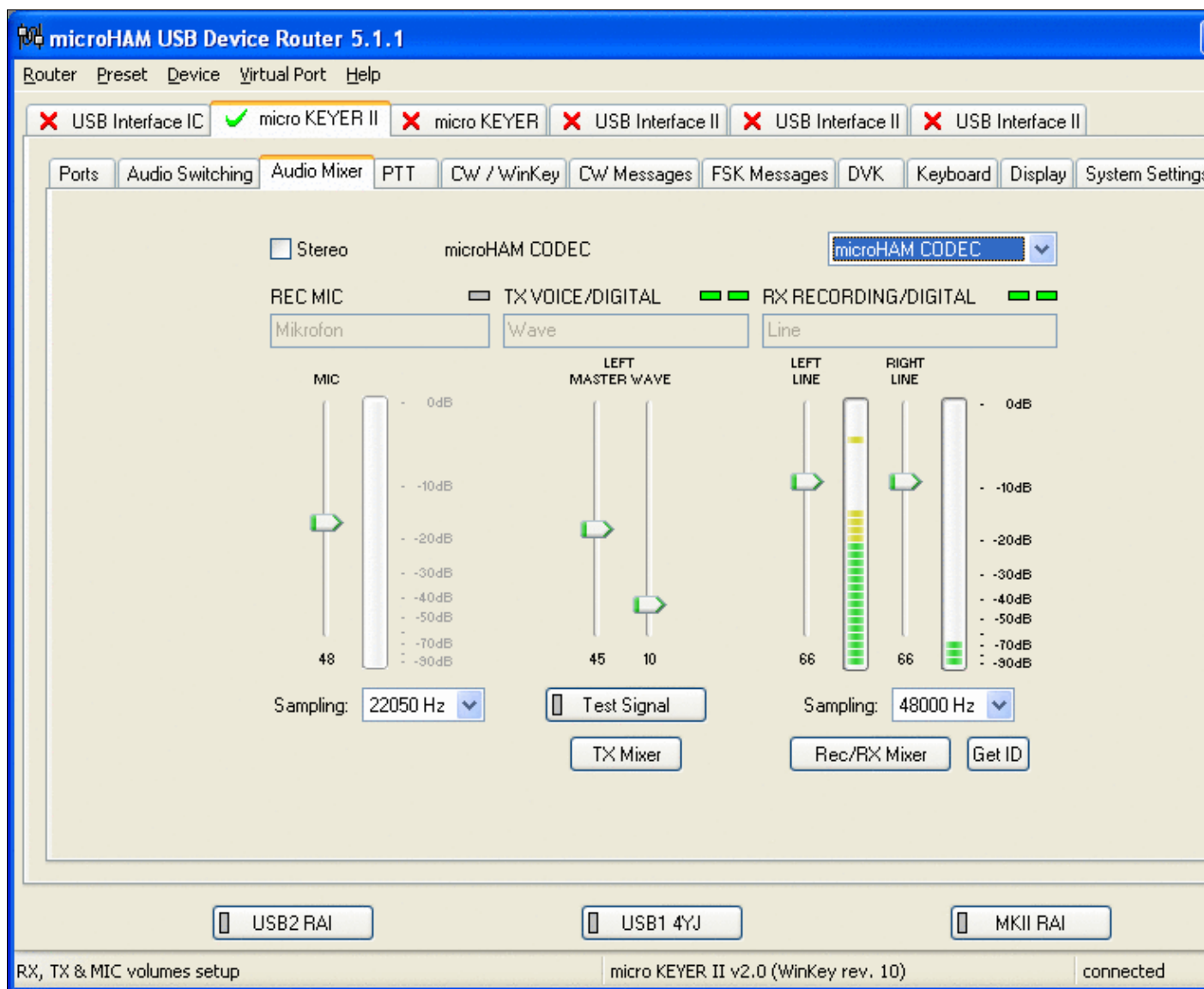

## Win-Test Wiki

Setting the correct audio level on the microHAM CODEC sound card

- Tune across the CW band and check if the XY scope changes when you hear signals. Once you tune across a carrier or CW signal, you should see a vertical ellipse and then a horizontal ellipse or vice versa depending on which direction you tune. The receive section of the screen will show all kinds of clutter.
- Try to find a RTTY signal (not easy on a normal day). Both ellipses should now be perpendicular to each other. See if you can decode RTTY fine. You may have to select proper filters. I use 500 Hz at 8.8 MHz IF and 2.7 kHz at 455 kHz IF.
- Next, press the TX button in the MMTTY application. You should hear the typical RTTY diddle in the monitor of the radio. The XY Scope will also display a clean RTTY signal.
- Type a few characters (including your callsign) and see how they are transmitted.
- Press the TX button one more time to shut off transmission.
- Exit the MMTTY program now.

MMTTY now works perfectly as a stand-alone program. We are now ready for Win-Test.

## Win-Test

Schnittstellenkonfiguration... [Alt+H für Hilfe]

**Serielle Ports**

<input type="checkbox"/>	COM1	Radio 1	9600 8-N-1	Konfigurieren...
<input type="checkbox"/>	COM2	Radio 1	9600 8-N-1	Konfigurieren...
<input type="checkbox"/>	COM3	Radio 1	9600 8-N-1	Konfigurieren...
<input type="checkbox"/>	COM4	Radio 1	9600 8-N-1	Konfigurieren...
<input type="checkbox"/>	COM5	Radio 1	9600 8-N-1	Konfigurieren...
<input checked="" type="checkbox"/>	COM6	Radio 1	19200 8-N-1	Konfigurieren...
<input type="checkbox"/>	COM7	Radio 1	1200 8-N-2	Konfigurieren...
<input checked="" type="checkbox"/>	COM8	WinKey	1200 8-N-2	Konfigurieren...
<input checked="" type="checkbox"/>	COM9	MK/MKII	9600 8-N-1	Konfigurieren...
<input type="checkbox"/>	COM10	Radio 1	9600 8-N-1	Konfigurieren...
<input type="checkbox"/>	COM11	Radio 1	9600 8-N-1	Konfigurieren...
<input type="checkbox"/>	COM12	Radio 1	9600 8-N-1	Konfigurieren...

**Drucker Ports**

LPT Konfigurieren...

**CW**

PTT Einschaltverzögerung: 200

Keying compensation (ms): 0

**Ethernet**

Ethernet-Netzwerk aktivieren

Broadcast Adresse: 127.255.255.255

Portnummer: 9871

**Netzwerkprotokoll**

**Sprachspeicher**

Soundkarte aktivieren

Speakers (Realtek High Defini)

Mikrofon stummschalten wenn DVK in Betrieb

Mikrofon stummschalten wenn DVK nicht in Betrieb

**Transceiver**

Radio 1: IC-7410  Nicht pollen  CI-V Transceiver verwenc

Radio 2: ---  Nicht pollen  CI-V Transceiver verwenc

Polling Rate (ms): 100

Polling Rate (ms): Auto

Final steps: Win-Test Interfaces configuration. Note that we only set up three COM ports, no PTT or CW settings are needed as they are all generated/controlled by the MKII.

- Start up Win-Test, create a new Win-Test file for testing.
- Select DXpedition and allow All Modes so you can test all three different modes.
- in the **Options | Configure Interfaces...** menu
  - ◆ configure Radio on COM6
  - ◆ configure Winkey on COM7 using default settings
  - ◆ configure microHAM MK/MKII on COM9
  - ◆ untag Win-Test's internal Voice Keyer
- Go to Configure MMTTY.EXE startup path as described in the [RTTY section of this manual](#) if you are planning for RTTY operation

We are now ready to operate the contest.

## Namespaces

- [Page](#)
- [Discussion](#)

## Variants

## Views

- [Read](#)
- [View source](#)
- [View history](#)

## More

- This page was last edited on 9 June 2022, at 16:27.
- [Privacy policy](#)
- [About Win-Test Wiki](#)
- [Disclaimers](#)



# BestPractice1

From Win-Test Wiki

[Jump to navigation](#) [Jump to search](#)

## Contents

- [1 Getting ready for a RTTY Contest](#)
- [2 Kenwood TS-850 settings](#)
- [3 Yaesu FT-1000MP settings](#)
- [4 MMTTY settings for FT-1000MP](#)
- [5 microHAM USB Interface II](#)
- [6 mircoHAM USB Device Router](#)
- [7 MMTTY](#)
- [8 Win-Test](#)
- [9 See also](#)

## Getting ready for a RTTY Contest

This article describes how to set up a Kenwood TS-850 or FT-1000MP, a microHAM USB II Interface and accompanying software for use during a RTTY contest. We will use PTT, FSK keying (low tones 1275/1445 Hz) and transceiver control. For details why this makes the best sense please see AA5AU's excellent [tutorial pages](#). Another good [starter article on RTTY](#) comes from G3LDI.

This article should give you some idea on what areas to look at when you are going for this relatively complex scenario. It is a step-by-step approach with a little test at the end of each step to make sure things are working on the lower level before we go up to the next. First we will setup the hardware; next we will set up MMTTY as a stand-alone application; finally we will integrate that into Win-Test. I wrote it down after a number of debug sessions at various locations, where a lot of hair was torn out.

## Kenwood TS-850 settings

- Press and hold the LSB/USB key while you turn the radio on.
- Select menu item 11 and change the setting to ON if necessary. This will set the polarity of MARK and SPACE signals.
- Select menu item 12 and change the setting to 170 if necessary - this is the typical shift used on the HF bands.
- Select menu item 13 and change the setting to 1275 if necessary. This selects the LOW TONES pair.
- Press the CLR button to leave the setup menu.

To test the settings, put the radio to FSK mode, push the MONI button and then switch the radio to transmit by pressing REC/SEND. You should now hear a 1275 Hz tone. If you short the RTTY jacket on the back of the radio you should hear the tone going up to 1445 Hz.

## Yaesu FT-1000MP settings

- Press and hold [FAST] then press [ENT] to access the FT-1000MP menus
- Rotate the MEM/VFO CH knob to select the following menu items
- Select menu 6-1, change the RTTY Polarity to REVERSE (rotate the main tuning knob to change it)
- Select menu 6-2, change the RTTY Tone to LO TONE (Mark = 1275 Hz)



- Select menu 6-3, change the RTTY Frequency Display to OFFSET
- Press [RTTY] until the [LSB] button illuminates indicating RTTY-LSB FSK mode

## MMTTY settings for FT-1000MP

- Select Option, Setup MMTTY, Demodulator tab, set Ham Default to 1275, then press the [Ham] button
- AFC tab, *remove* the check mark from AFC
- Font/Window tab, under XYScope, *check* the Reverse Rotation box
- TX tab, PTT port, select the real or virtual COM port being used for the radio's PTT
- Misc tab, set Device ID to -1 to use the Windows default recording device. Select the Windows Control Panel, Sounds and Audio Devices, Audio Tab, Sound recording, Default Device to change the default, -or-
- Misc tab, set Device ID to the number corresponding to the desired Audio CODEC device. If using a microHAM MK2R+, in the microHAM DEVICE ROUTER program, Audio Mixer tab, on the RX RECORDING/DIGITAL side of the menu, press the GET ID button and use the "WAVE IN" device number displayed in the pop-up message as the MMTTY Device ID.
- Misc tab, under Tx Port, select COM-TxD (FSK)
- Misc tab, click the [USB Port] button, select Processing Method C: Limiting speed
- Press [OK]

## microHAM USB Interface II

- Make sure you have read the user manual and configured the microHAM Interface for Kenwood using the internal jumpers.
- Connect the microHAM USB Interface II to your radio and computer.
  - ◆ On the radio side there will be four connections: CW, RTTY, ACC1 and ACC2,
  - ◆ On the computer side there will be three connections: USB, Line-out and Line-in (or microphone). For FSK operation we can actually skip the Line-out connection.
  - ◆ On my computer, once you connect the Line-in cable, a popup will ask, if this is a microphone or Line-in (see image below). Select Line-in.

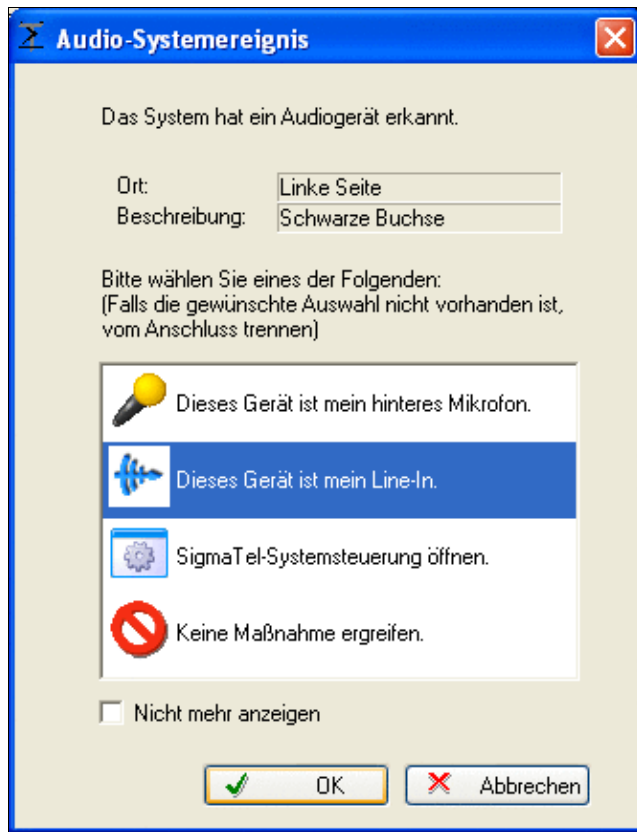

This pop-up comes up on my system every time I connect a cable to the "IN" port

- Install the microHAM software if you haven't done so already. There are two steps to it:
  - ◆ Installing the device driver - if you have several microHAM devices you will have to do this once for each of them.
  - ◆ Installing the USB Device Router - this software only needs to be installed once. It is identical on all microHAM products.

## mircoHAM USB Device Router

- Set up the Device Router
- Create two virtual COM ports. Don't try to use same port for radio control PTT/CW/FSK switching - use two different ones, like COM5 and COM6
  - ◆ Configure Radio on COM5
  - ◆ Configure CW on COM6 DTR
  - ◆ Configure PTT on COM6 RTS
  - ◆ SQL is not needed

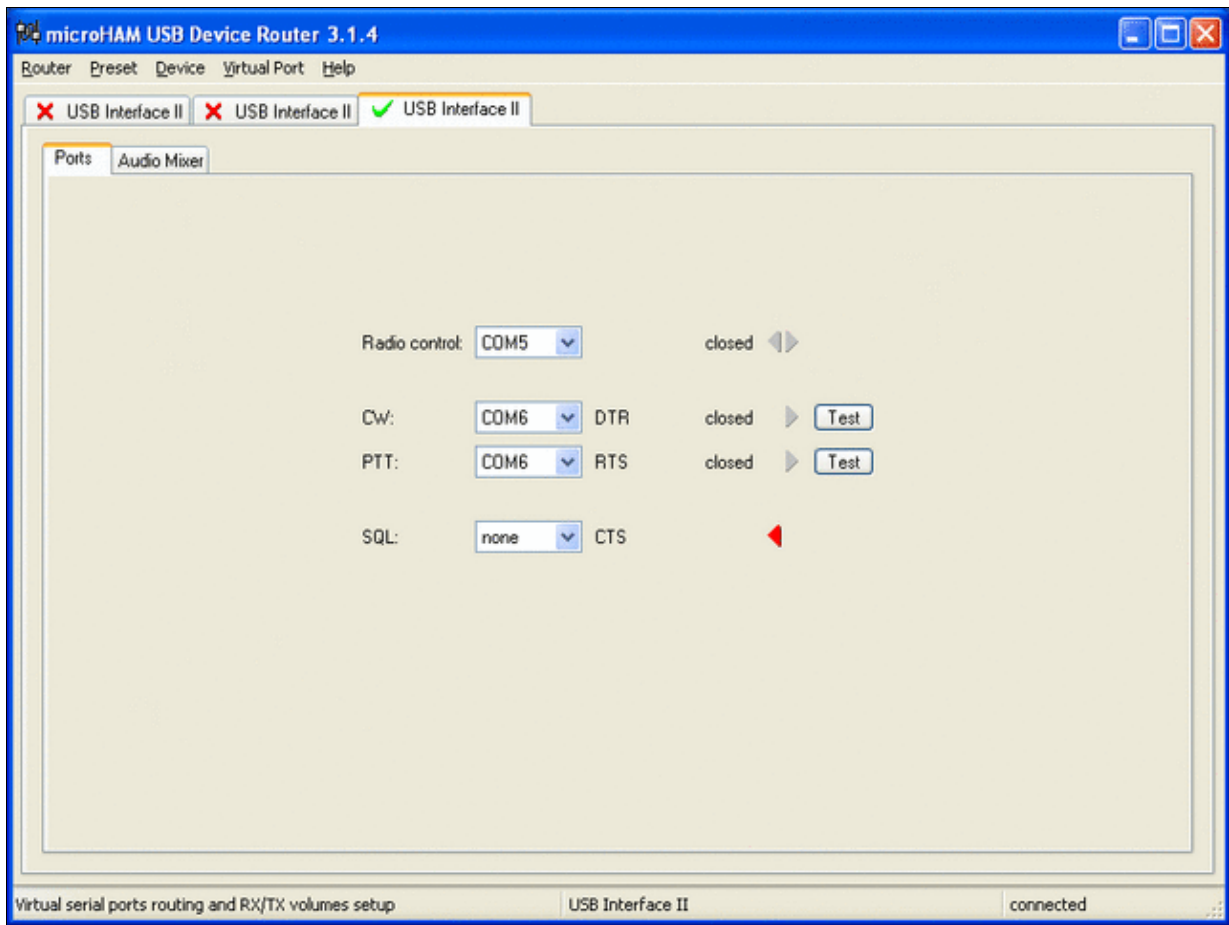

microHAM USB Interface II setup.

- Testing
  - ◆ Press the Test button on the PTT line. The radio should switch to transmit.
  - ◆ Press the Test button on the CW line. The sidetone should be audible now.

## MMTTY

- Download and Install MMTTY from [here](#).
- If you plan to use FSK, also download the [EXTFSK](#) package from there. The ZIP file you are looking for is named [comfsk105.zip](#).
- Extract and copy ExtFSK.dll to the MMTTY directory. There is nothing else to do to install this software.
- Start MMTTY
- Activate the XY Scope by selecting the **View (V)** menu item and tagging **XYScope**

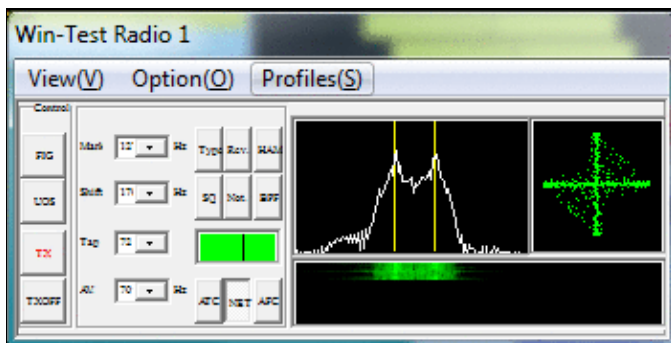

The XY Scope is a practical tuning aid and will help us to visualize the received signals.

- Go to **Option (O) | Setup MMTTY (O) ...**
- Select the Demodulator tab and set it up like in the picture below.

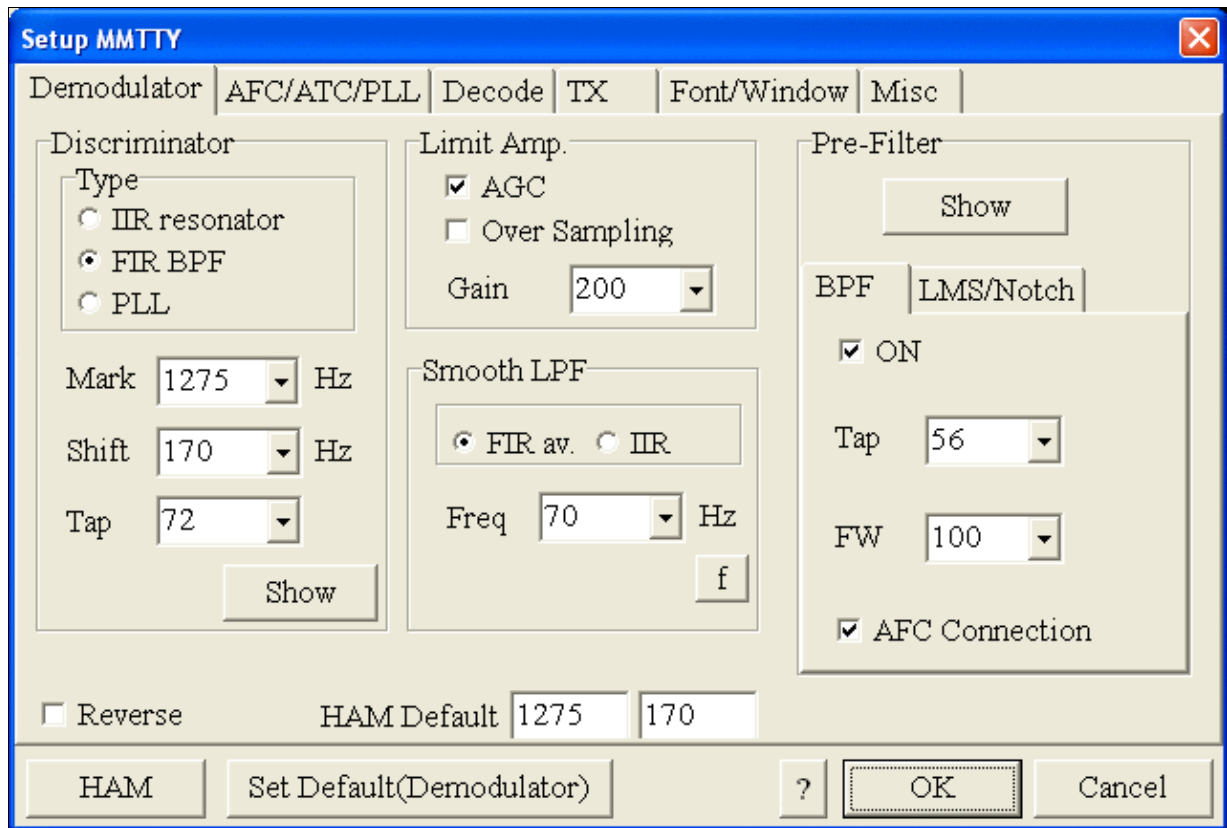

### MMTTY Demodulator settings

- Select the AFC/ATC/PLL tab and make sure AFC is OFF.

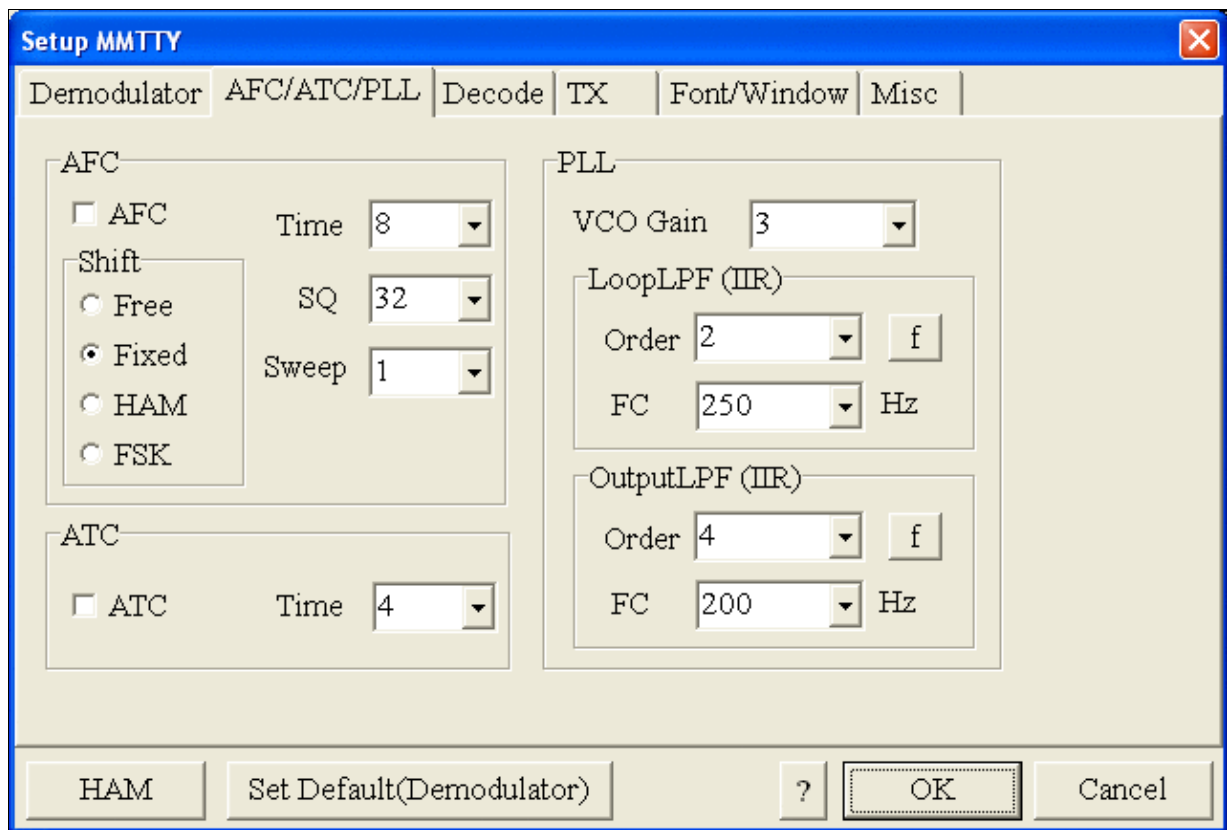

MMTTY AFC/ATC/PLL settings. Make sure AFC is off as it will eventually introduce a deviation between TX and RX frequencies.

- Select the TX tab and switch PTT port to EXTFSK. The Radio Command button in this setup screen will allow you to control the radio from within MMTTY. This is not desired in this scenario so make sure it is not configured - otherwise Win-Test would not have access to the radio COM port later.

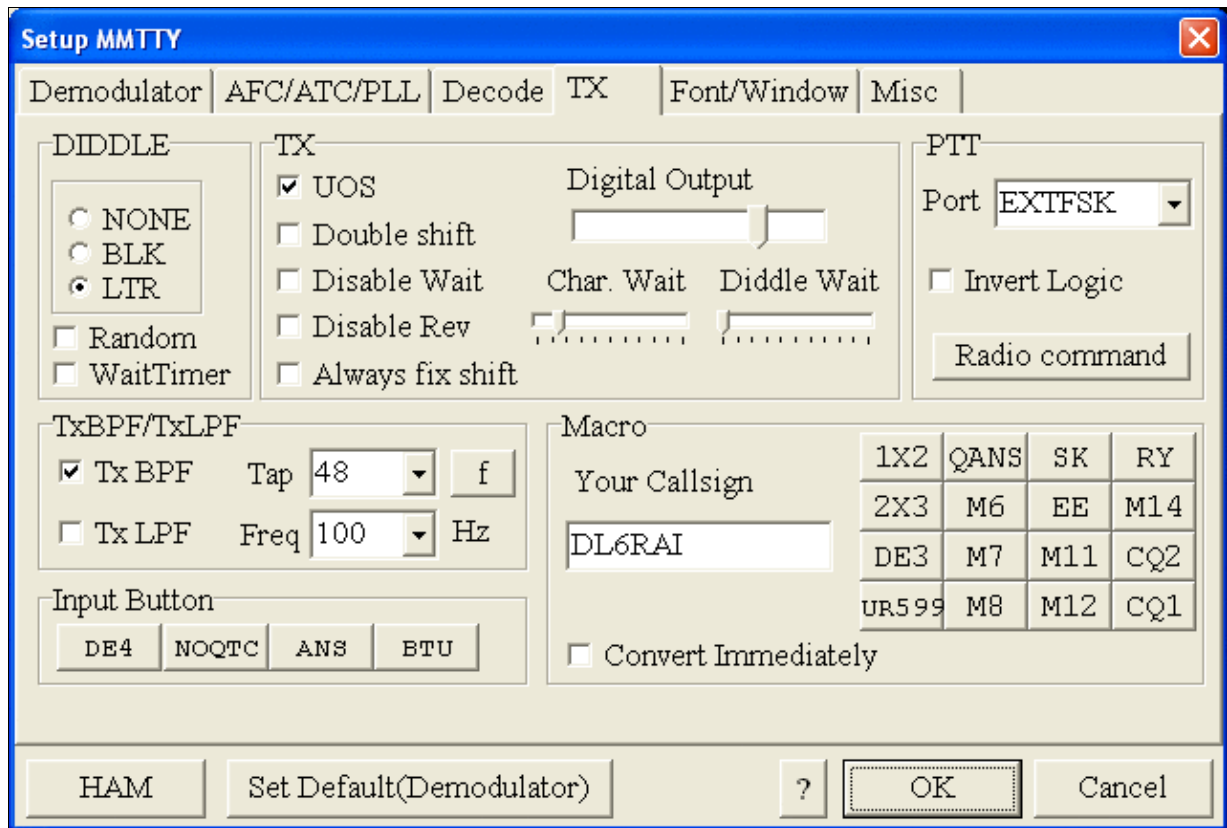

MMTTY Tx settings - most important: keying of the PTT through EXTFSK

- Select the Misc tab and select COM-TxD (FSK) as Tx Port.

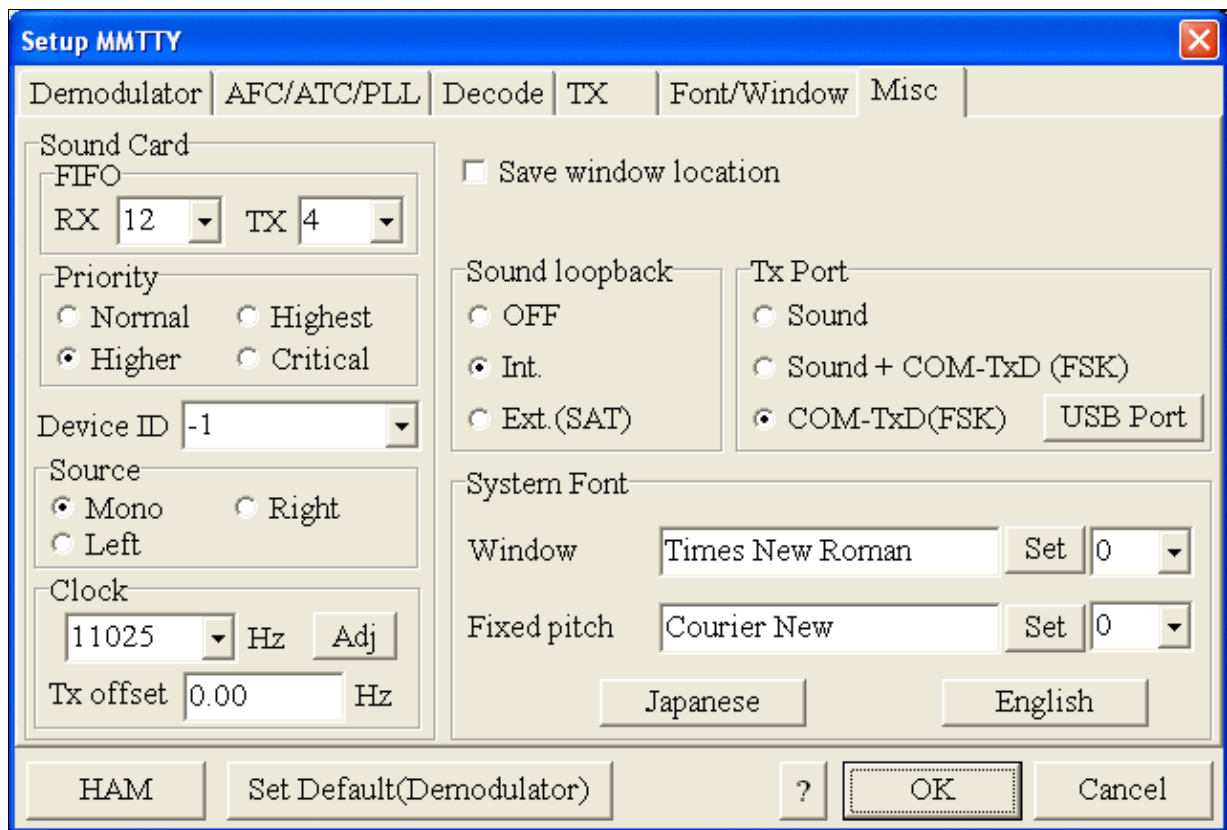

MMTTY Misc settings - this is where we configure TXD to do the FSK keying

- Exit the Setup screens by pressing the OK button.

We are now ready to do some tests with MMTTY.

- Now take a look at the XY Scope display. It should look like the picture above. If you only see a single white point in the middle of the display, this means, that MMTTY gets no audio to process.
- Check your cabling. Is your cable connected to Line-in or Mic-in?
- Check the level setting for your sound card. Open the Sound control (click on the loudspeaker symbol in your task bar), switch to the Recording section and adjust the level for Line-in. When you move the control up and down you should see an increase and decrease in noise level.



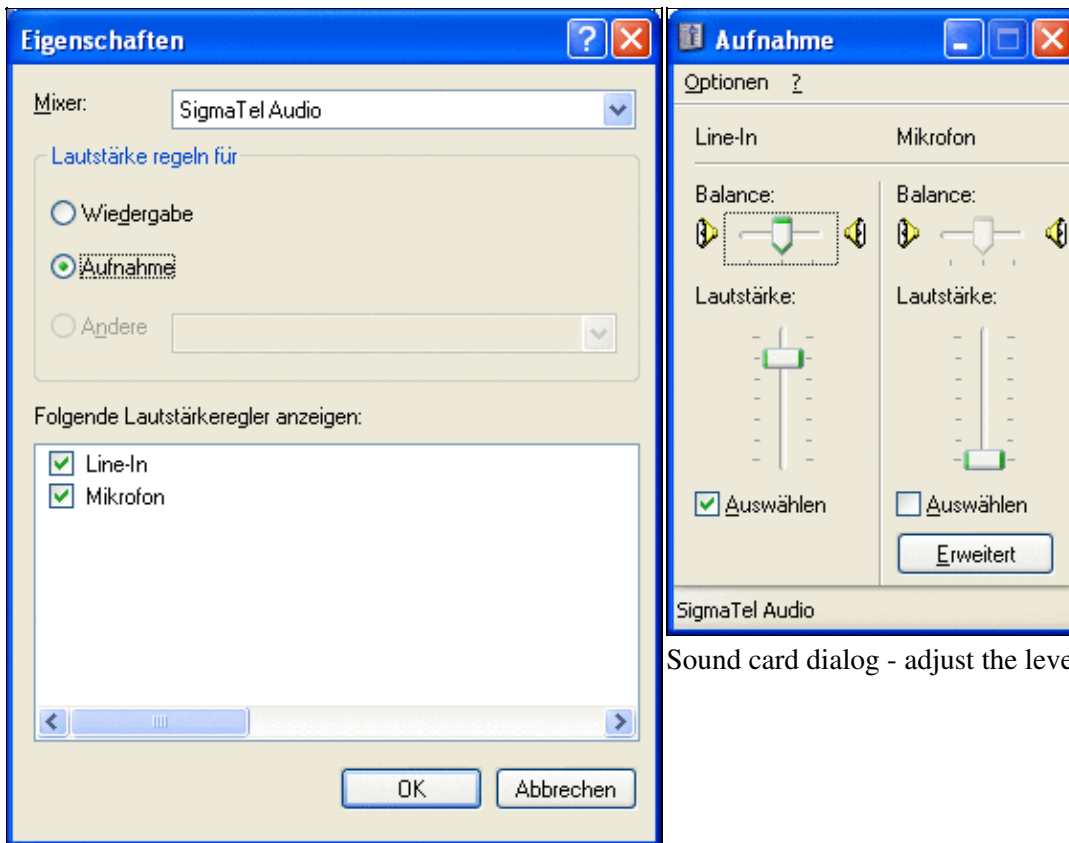

Sound card dialog - adjust the level of Line-in

Sound card dialog - select Recording here

- Tune across the CW band and check if the XY scope changes when you hear signals. Once you tune across a carrier or CW signal, you should see a vertical ellipse and then a horizontal ellipse or vice versa depending on which direction you tune. The receive section of the screen will show all kinds of clutter.
- Try to find a RTTY signal (not easy on a normal day). Both ellipses should now be perpendicular to each other. See if you can decode RTTY fine. You may have to select proper filters. I use 500 Hz at 8.8 MHz IF and 2.7 kHz at 455 kHz IF.
- Next, press the TX button in the MMTTY application. You should hear the typical RTTY diddle in the monitor of the radio. The XY Scope will also display a clean RTTY signal.
- Type a few characters (including your callsign) and see how they are transmitted.
- Press the TX button one more time to shut off transmission.
- Exit the MMTTY program now.

MMTTY now works perfectly as a stand-alone program. We are now ready for Win-Test.

## Win-Test

- Start up Win-Test, create a new Win-Test file for testing.
- Go to Configure MMTTY.EXE startup path as described in [RTTY#Win-Test RTTY configuration](#).

- [Configure Radio Control](#)

We are now ready to operate the contest.

## See also

- Win-Test Manual section on [RTTY](#)

## Namespaces

- [Page](#)
- [Discussion](#)

## Variants

## Views

- [Read](#)
- [View source](#)
- [View history](#)

## More

- This page was last edited on 18 April 2015, at 15:25.
- [Privacy policy](#)
- [About Win-Test Wiki](#)
- [Disclaimers](#)



# Best Practice

From Win-Test Wiki

[Jump to navigation](#) [Jump to search](#)

This article collects a number best practice articles describing a step-by-step configuration instructions for different configurations, mostly involving the complex but very versatile microHam controllers. Feel free to add your own personal set-b-step insruction in a BestPractice article. This maybe helpful for you and for others.

1. [Kenwood TS-850S or FT-1000MP + microHAM MKII setup](#)
2. [Icom IC-736 with the microHAM USB Interface II setup](#)
3. [Icom IC-275H with the microHAM USB Interface IC setup](#)
4. [Kenwood TS-850S with the microHAM microKeyer setup](#)
5. [Kenwood TS-850S with the microHAM MKII](#)
6. [Yaesu FT-1000D with the microHAM MKII](#)
7. [Setting up the Yaesu FTDX-101](#)
8. [Setting up the ICOM IC-7410 + microHAM MKII](#)
9. [Setting up the KX3 only with KXUSB cable](#)
10. [Setting up the ICOM IC-7851 + microHAM MK III](#)

## Namespaces

- [Page](#)
- [Discussion](#)

## Variants

## Views

- [Read](#)
- [View source](#)
- [View history](#)

## More

- This page was last edited on 19 March 2021, at 18:01.

- [Privacy policy](#)
- [About Win-Test Wiki](#)
- [Disclaimers](#)



# BestPractice1

From Win-Test Wiki

[Jump to navigation](#) [Jump to search](#)

## Contents

- [1 Getting ready for a RTTY Contest](#)
- [2 Kenwood TS-850 settings](#)
- [3 Yaesu FT-1000MP settings](#)
- [4 MMTTY settings for FT-1000MP](#)
- [5 microHAM USB Interface II](#)
- [6 mircoHAM USB Device Router](#)
- [7 MMTTY](#)
- [8 Win-Test](#)
- [9 See also](#)

## Getting ready for a RTTY Contest

This article describes how to set up a Kenwood TS-850 or FT-1000MP, a microHAM USB II Interface and accompanying software for use during a RTTY contest. We will use PTT, FSK keying (low tones 1275/1445 Hz) and transceiver control. For details why this makes the best sense please see AA5AU's excellent [tutorial pages](#). Another good [starter article on RTTY](#) comes from G3LDI.

This article should give you some idea on what areas to look at when you are going for this relatively complex scenario. It is a step-by-step approach with a little test at the end of each step to make sure things are working on the lower level before we go up to the next. First we will setup the hardware; next we will set up MMTTY as a stand-alone application; finally we will integrate that into Win-Test. I wrote it down after a number of debug sessions at various locations, where a lot of hair was torn out.

## Kenwood TS-850 settings

- Press and hold the LSB/USB key while you turn the radio on.
- Select menu item 11 and change the setting to ON if necessary. This will set the polarity of MARK and SPACE signals.
- Select menu item 12 and change the setting to 170 if necessary - this is the typical shift used on the HF bands.
- Select menu item 13 and change the setting to 1275 if necessary. This selects the LOW TONES pair.
- Press the CLR button to leave the setup menu.

To test the settings, put the radio to FSK mode, push the MONI button and then switch the radio to transmit by pressing REC/SEND. You should now hear a 1275 Hz tone. If you short the RTTY jacket on the back of the radio you should hear the tone going up to 1445 Hz.

## Yaesu FT-1000MP settings

- Press and hold [FAST] then press [ENT] to access the FT-1000MP menus
- Rotate the MEM/VFO CH knob to select the following menu items
- Select menu 6-1, change the RTTY Polarity to REVERSE (rotate the main tuning knob to change it)
- Select menu 6-2, change the RTTY Tone to LO TONE (Mark = 1275 Hz)

- Select menu 6-3, change the RTTY Frequency Display to OFFSET
- Press [RTTY] until the [LSB] button illuminates indicating RTTY-LSB FSK mode

## MMTTY settings for FT-1000MP

- Select Option, Setup MMTTY, Demodulator tab, set Ham Default to 1275, then press the [Ham] button
- AFC tab, *remove* the check mark from AFC
- Font/Window tab, under XYScope, *check* the Reverse Rotation box
- TX tab, PTT port, select the real or virtual COM port being used for the radio's PTT
- Misc tab, set Device ID to -1 to use the Windows default recording device. Select the Windows Control Panel, Sounds and Audio Devices, Audio Tab, Sound recording, Default Device to change the default, -or-
- Misc tab, set Device ID to the number corresponding to the desired Audio CODEC device. If using a microHAM MK2R+, in the microHAM DEVICE ROUTER program, Audio Mixer tab, on the RX RECORDING/DIGITAL side of the menu, press the GET ID button and use the "WAVE IN" device number displayed in the pop-up message as the MMTTY Device ID.
- Misc tab, under Tx Port, select COM-TxD (FSK)
- Misc tab, click the [USB Port] button, select Processing Method C: Limiting speed
- Press [OK]

## microHAM USB Interface II

- Make sure you have read the user manual and configured the microHAM Interface for Kenwood using the internal jumpers.
- Connect the microHAM USB Interface II to your radio and computer.
  - ◆ On the radio side there will be four connections: CW, RTTY, ACC1 and ACC2,
  - ◆ On the computer side there will be three connections: USB, Line-out and Line-in (or microphone). For FSK operation we can actually skip the Line-out connection.
  - ◆ On my computer, once you connect the Line-in cable, a popup will ask, if this is a microphone or Line-in (see image below). Select Line-in.

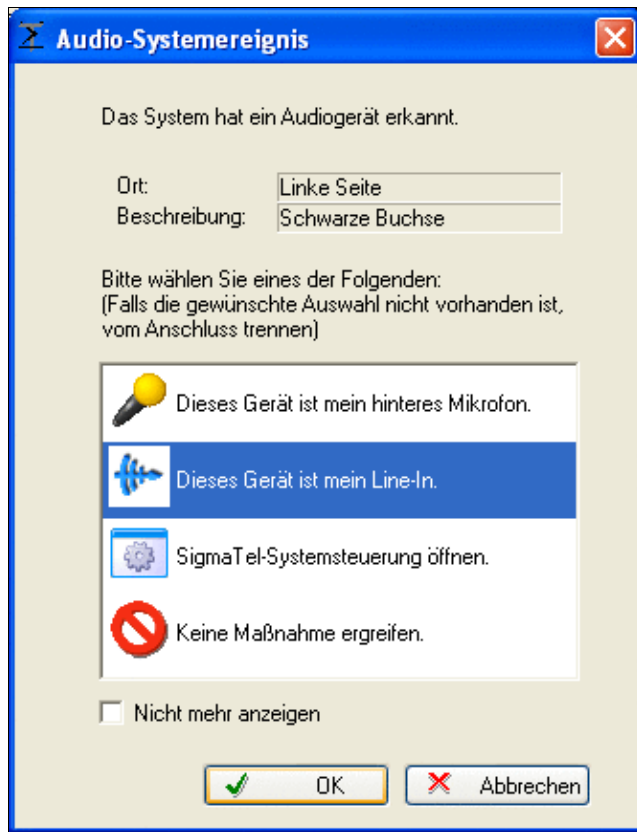

This pop-up comes up on my system every time I connect a cable to the "IN" port

- Install the microHAM software if you haven't done so already. There are two steps to it:
  - ◆ Installing the device driver - if you have several microHAM devices you will have to do this once for each of them.
  - ◆ Installing the USB Device Router - this software only needs to be installed once. It is identical on all microHAM products.

## mircoHAM USB Device Router

- Set up the Device Router
- Create two virtual COM ports. Don't try to use same port for radio control PTT/CW/FSK switching - use two different ones, like COM5 and COM6
  - ◆ Configure Radio on COM5
  - ◆ Configure CW on COM6 DTR
  - ◆ Configure PTT on COM6 RTS
  - ◆ SQL is not needed

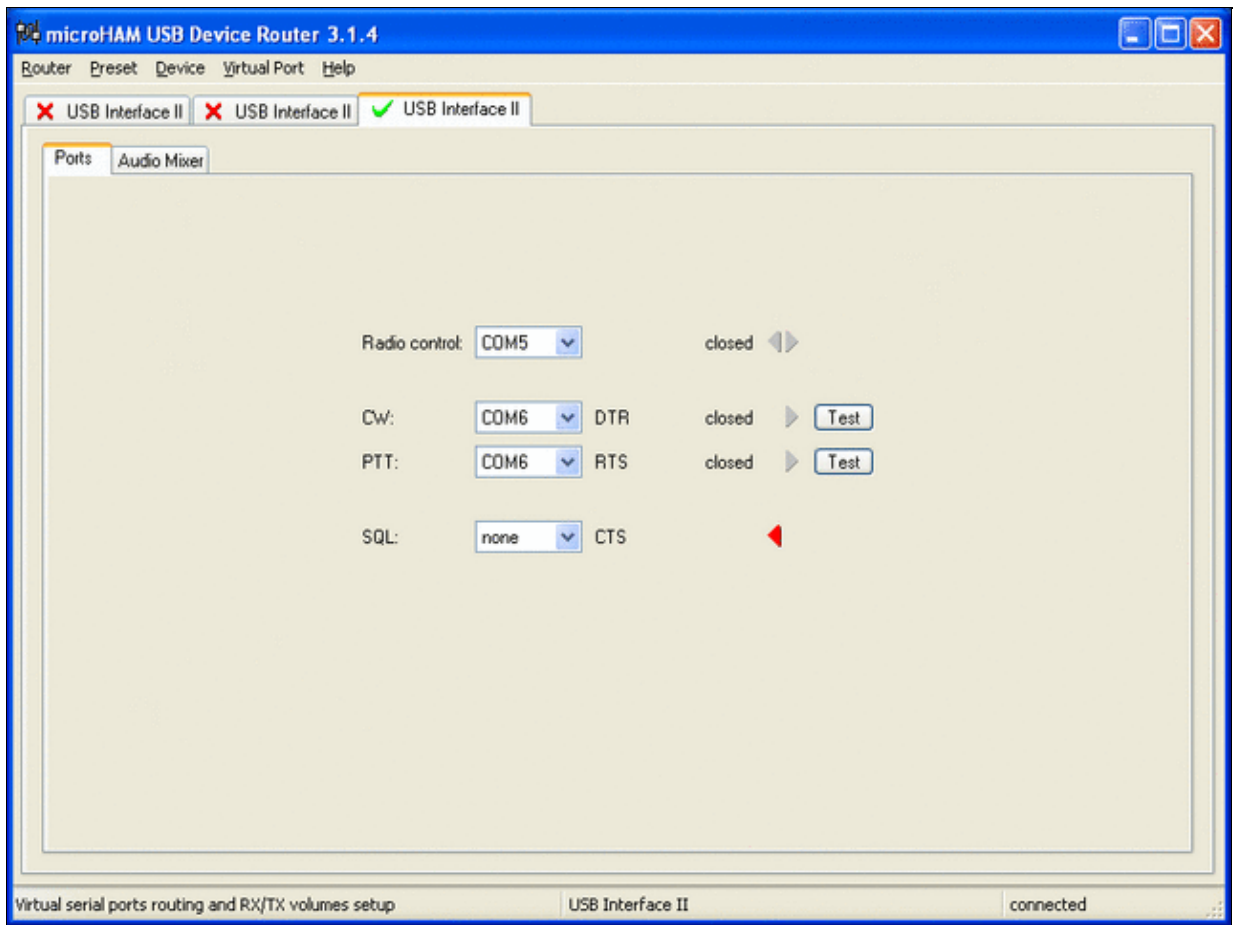

microHAM USB Interface II setup.

- Testing
  - ◆ Press the Test button on the PTT line. The radio should switch to transmit.
  - ◆ Press the Test button on the CW line. The sidetone should be audible now.

## MMTTY

- Download and Install MMTTY from [here](#).
- If you plan to use FSK, also download the [EXTFSK](#) package from there. The ZIP file you are looking for is named [comfsk105.zip](#).
- Extract and copy ExtFSK.dll to the MMTTY directory. There is nothing else to do to install this software.
- Start MMTTY
- Activate the XY Scope by selecting the **View (V)** menu item and tagging **XYScope**

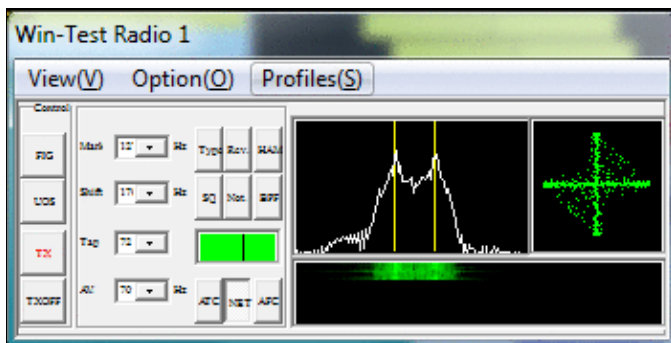

The XY Scope is a practical tuning aid and will help us to visualize the received signals.

- Go to **Option (O) | Setup MMTTY (O) ...**
- Select the Demodulator tab and set it up like in the picture below.



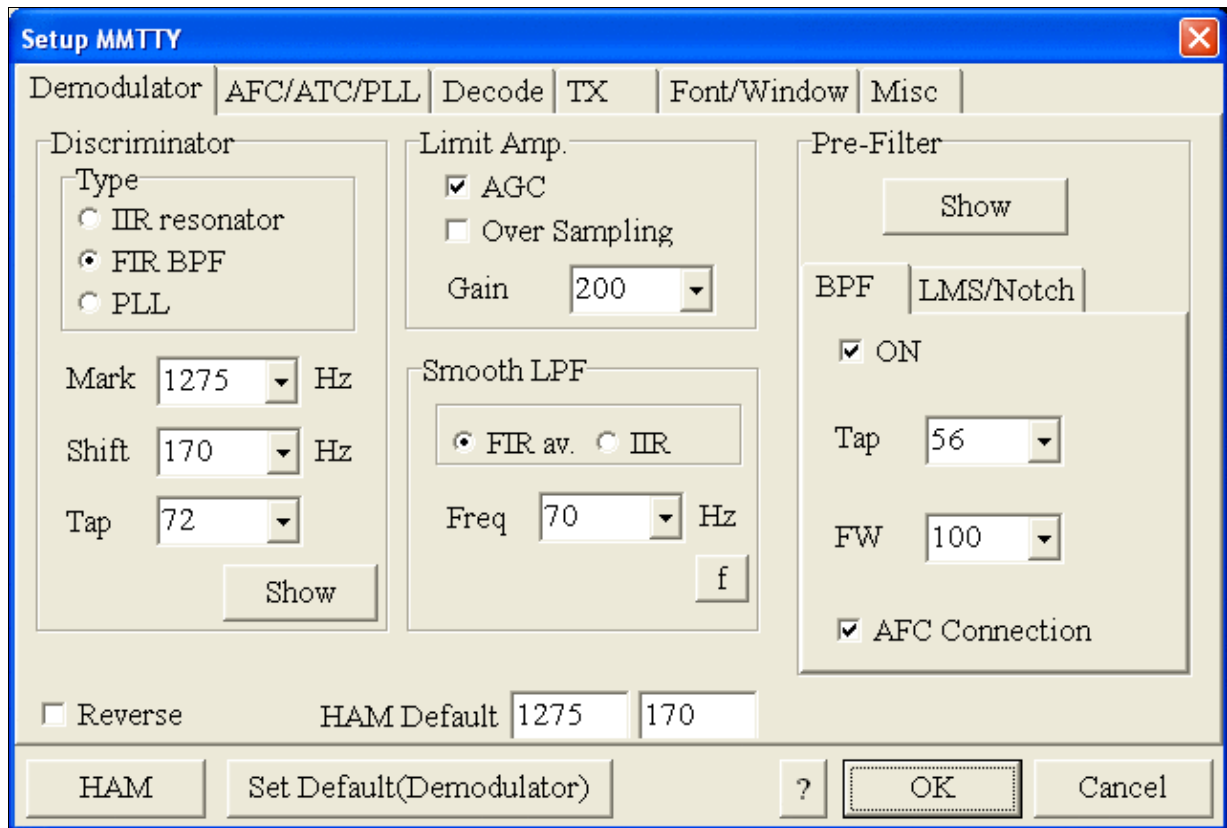

### MMTTY Demodulator settings

- Select the AFC/ATC/PLL tab and make sure AFC is OFF.

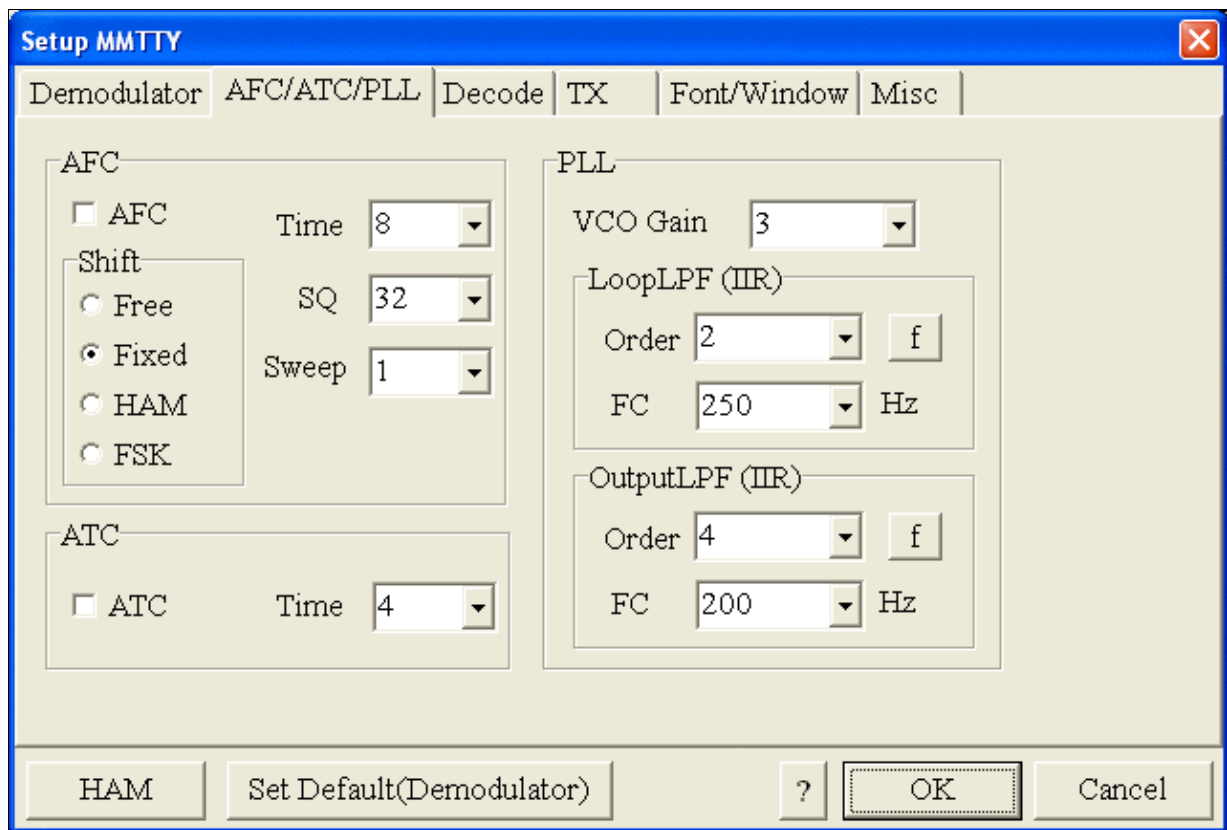

MMTTY AFC/ATC/PLL settings. Make sure AFC is off as it will eventually introduce a deviation between TX and RX frequencies.

- Select the TX tab and switch PTT port to EXTFSK. The Radio Command button in this setup screen will allow you to control the radio from within MMTTY. This is not desired in this scenario so make sure it is not configured - otherwise Win-Test would not have access to the radio COM port later.

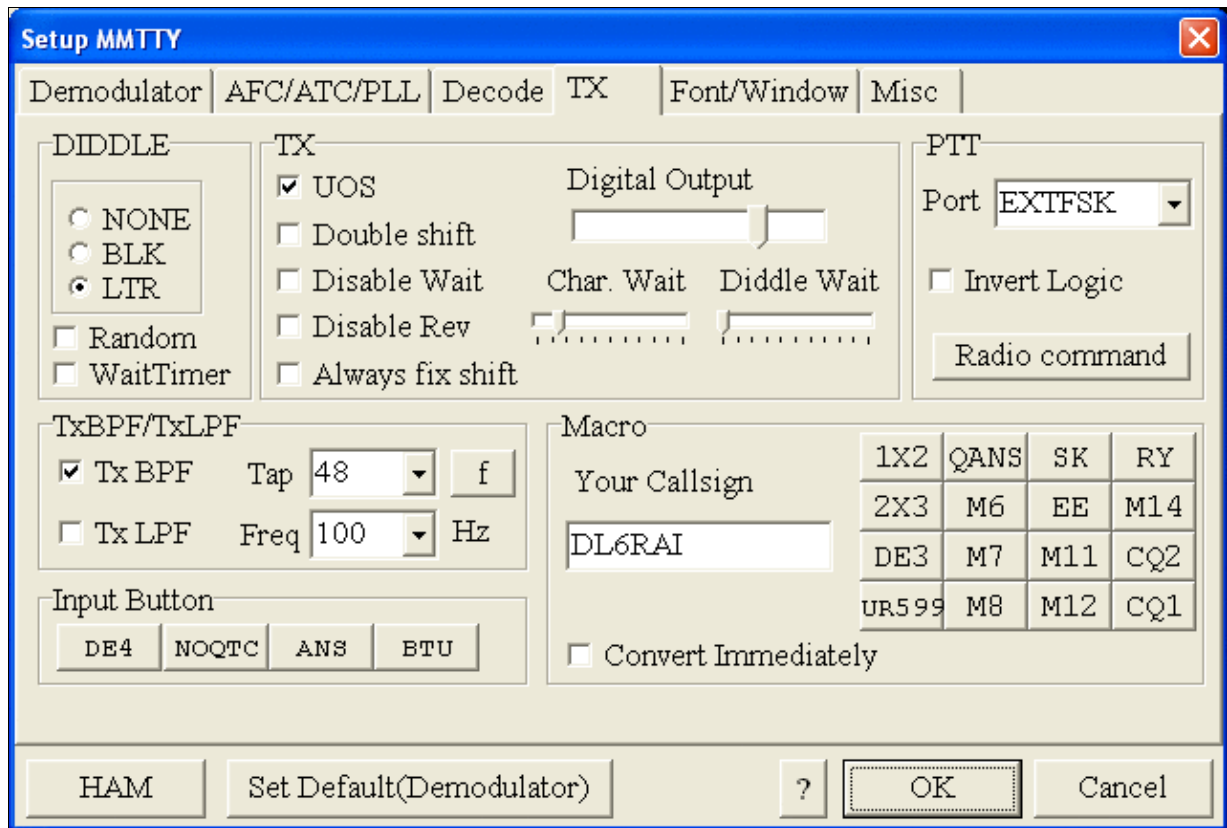

MMTTY Tx settings - most important: keying of the PTT through EXTFSK

- Select the Misc tab and select COM-TxD (FSK) as Tx Port.

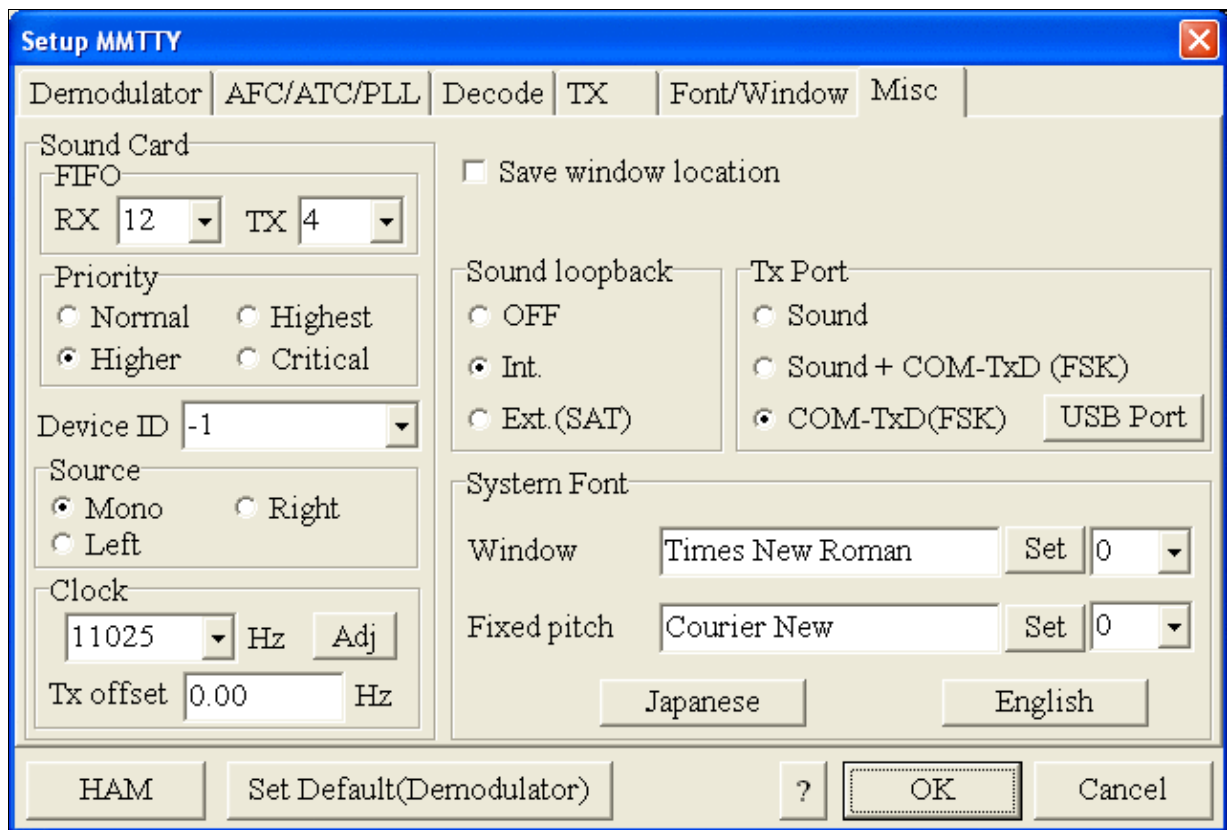

MMTTY Misc settings - this is where we configure TXD to do the FSK keying

- Exit the Setup screens by pressing the OK button.

We are now ready to do some tests with MMTTY.

- Now take a look at the XY Scope display. It should look like the picture above. If you only see a single white point in the middle of the display, this means, that MMTTY gets no audio to process.
- Check your cabling. Is your cable connected to Line-in or Mic-in?
- Check the level setting for your sound card. Open the Sound control (click on the loudspeaker symbol in your task bar), switch to the Recording section and adjust the level for Line-in. When you move the control up and down you should see an increase and decrease in noise level.

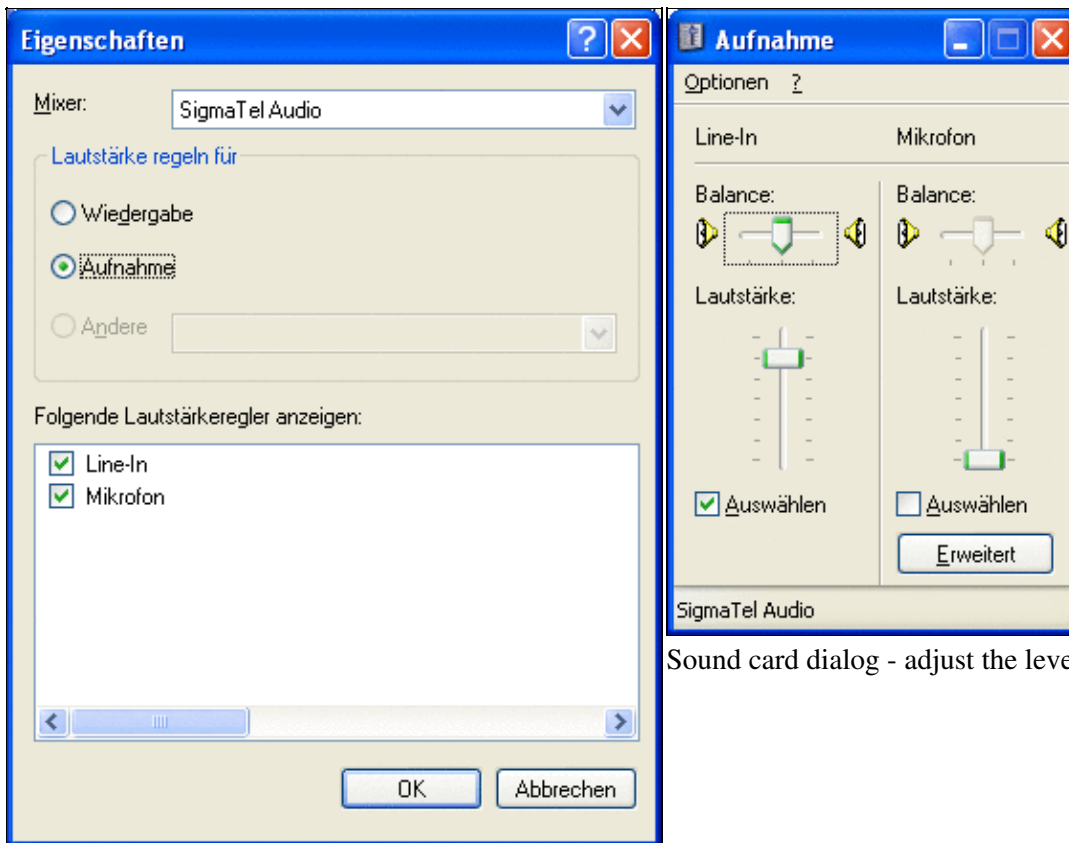

Sound card dialog - adjust the level of Line-in

Sound card dialog - select Recording here

- Tune across the CW band and check if the XY scope changes when you hear signals. Once you tune across a carrier or CW signal, you should see a vertical ellipse and then a horizontal ellipse or vice versa depending on which direction you tune. The receive section of the screen will show all kinds of clutter.
- Try to find a RTTY signal (not easy on a normal day). Both ellipses should now be perpendicular to each other. See if you can decode RTTY fine. You may have to select proper filters. I use 500 Hz at 8.8 MHz IF and 2.7 kHz at 455 kHz IF.
- Next, press the TX button in the MMTTY application. You should hear the typical RTTY diddle in the monitor of the radio. The XY Scope will also display a clean RTTY signal.
- Type a few characters (including your callsign) and see how they are transmitted.
- Press the TX button one more time to shut off transmission.
- Exit the MMTTY program now.

MMTTY now works perfectly as a stand-alone program. We are now ready for Win-Test.

## Win-Test

- Start up Win-Test, create a new Win-Test file for testing.
- Go to Configure MMTTY.EXE startup path as described in [RTTY#Win-Test RTTY configuration](#).

- [Configure Radio Control](#)

We are now ready to operate the contest.

## See also

- Win-Test Manual section on [RTTY](#)

## Namespaces

- [Page](#)
- [Discussion](#)

## Variants

## Views

- [Read](#)
- [View source](#)
- [View history](#)

## More

- This page was last edited on 18 April 2015, at 15:25.
- [Privacy policy](#)
- [About Win-Test Wiki](#)
- [Disclaimers](#)



# BestPractice2

From Win-Test Wiki

[Jump to navigation](#) [Jump to search](#)

## Contents

- [1 Setting up an Icom IC-736 with the microHAM USB Interface II](#)
- [2 Icom IC-736 settings](#)
- [3 microHAM USB Interface II](#)
- [4 mircoHAM USB Device Router](#)
- [5 Win-Test](#)
- [6 See also](#)

## Setting up an Icom IC-736 with the microHAM USB Interface II

This article is a step by step approach describing how to set up an Icom IC-736 and a microHAM USB II Interface. In the end, we will be using PTT, CW keying and transceiver control.

### Icom IC-736 settings

- Press and hold the **FREQ-INP** and **ENT** keys while you power on the radio. This will allow you to set up some important parameters of your radio.
- Select menu item 12 and make sure the setting is at **44h**, the default address for this radio.
- Select menu item 13 and change the setting to **1200** if necessary. This selects 1200 Baud data rate.
- Select menu item 14 and change the setting to **On** if necessary. This selects the CI-V mode.
- Select menu item 15 and change the setting to **Off**. This sets the data length to five bytes.
- Now power off the radio to exit the menu. After that, power it back on.

### microHAM USB Interface II

- Make sure you have read the user manual and configured the microHAM Interface for Icom using the internal jumpers.
- Connect the microHAM USB Interface II to your radio and computer.
  - ◆ On the radio side there will be three connections: CW, Remote and ACC1.
  - ◆ On the computer side there will be three connections: USB, Line-out and Line-in (or microphone).
- Install the microHAM software if you haven't done so already. There are two steps to it:
  - ◆ Installing the device driver - if you have several microHAM devices you will have to do this once for each of them.
  - ◆ Installing the USB Device Router - this software only needs to be installed once. It is identical on all microHAM products.

### mircoHAM USB Device Router

- Set up the Device Router
- Create two virtual COM ports. Don't try to use same port for radio control PTT/CW/FSK switching - use two different ones, like COM5 and COM6
  - ◆ Configure the Radio on COM5

- ◆ Configure CW on COM6 DTR
- ◆ Configure PTT on COM6 RTS
- ◆ SQL is not needed
- Testing
  - ◆ Press the Test button on the PTT line. The radio should switch to transmit.
  - ◆ Press the Test button on the CW line. The sidetone should be audible now.

## Win-Test

- Start up Win-Test, create a new Win-Test file for testing.
- Go to the Configures Interfaces Menu.
  - ◆ Configure COM5 for **Radio1** at 1200 Baud, 8-N-1.
  - ◆ Configure COM6 as **Other Interface . . .** and select CW on the DTR line and PTT on the RTS line.
  - ◆ In the lower left corner of the interfaces configuration menu, select IC-736 as **Radio 1** and tick the **Use CI-V Interface** option. The **Don't Poll** option will be greyed out automatically.
  - ◆ Exit the Configure Interfaces menu by pressing the **OK** button.
- Testing
  - ◆ Test radio control by entering a frequency in the callsign field. The radio should jump to that frequency.
  - ◆ Open up the Band Map (Radio 1 Window) in Win-Test and tune the VFO. Watch the center of the band map move along with the frequency.
  - ◆ Press **[F1]** (radio set to CW) and listen to the CQ message.

We are now ready to operate the contest.

## See also

- The Icom [IC-736 manual](#)
- The [microHAM](#) Web Pages containing a link to the PDF version of the manual

## Namespaces

- [Page](#)
- [Discussion](#)

## Variants

## Views

- [Read](#)
- [View source](#)
- [View history](#)

## More

- This page was last edited on 1 February 2007, at 13:55.



## Win-Test Wiki

- [Privacy policy](#)
- [About Win-Test Wiki](#)
- [Disclaimers](#)



# BestPractice2

From Win-Test Wiki

[Jump to navigation](#) [Jump to search](#)

## Contents

- [1 Setting up an Icom IC-736 with the microHAM USB Interface II](#)
- [2 Icom IC-736 settings](#)
- [3 microHAM USB Interface II](#)
- [4 mircoHAM USB Device Router](#)
- [5 Win-Test](#)
- [6 See also](#)

## Setting up an Icom IC-736 with the microHAM USB Interface II

This article is a step by step approach describing how to set up an Icom IC-736 and a microHAM USB II Interface. In the end, we will be using PTT, CW keying and transceiver control.

### Icom IC-736 settings

- Press and hold the **FREQ-INP** and **ENT** keys while you power on the radio. This will allow you to set up some important parameters of your radio.
- Select menu item 12 and make sure the setting is at **44h**, the default address for this radio.
- Select menu item 13 and change the setting to **1200** if necessary. This selects 1200 Baud data rate.
- Select menu item 14 and change the setting to **On** if necessary. This selects the CI-V mode.
- Select menu item 15 and change the setting to **Off**. This sets the data length to five bytes.
- Now power off the radio to exit the menu. After that, power it back on.

### microHAM USB Interface II

- Make sure you have read the user manual and configured the microHAM Interface for Icom using the internal jumpers.
- Connect the microHAM USB Interface II to your radio and computer.
  - ◆ On the radio side there will be three connections: CW, Remote and ACC1.
  - ◆ On the computer side there will be three connections: USB, Line-out and Line-in (or microphone).
- Install the microHAM software if you haven't done so already. There are two steps to it:
  - ◆ Installing the device driver - if you have several microHAM devices you will have to do this once for each of them.
  - ◆ Installing the USB Device Router - this software only needs to be installed once. It is identical on all microHAM products.

### mircoHAM USB Device Router

- Set up the Device Router
- Create two virtual COM ports. Don't try to use same port for radio control PTT/CW/FSK switching - use two different ones, like COM5 and COM6
  - ◆ Configure the Radio on COM5

- ◆ Configure CW on COM6 DTR
- ◆ Configure PTT on COM6 RTS
- ◆ SQL is not needed
- Testing
  - ◆ Press the Test button on the PTT line. The radio should switch to transmit.
  - ◆ Press the Test button on the CW line. The sidetone should be audible now.

## Win-Test

- Start up Win-Test, create a new Win-Test file for testing.
- Go to the Configures Interfaces Menu.
  - ◆ Configure COM5 for **Radio1** at 1200 Baud, 8-N-1.
  - ◆ Configure COM6 as **Other Interface . . .** and select CW on the DTR line and PTT on the RTS line.
  - ◆ In the lower left corner of the interfaces configuration menu, select IC-736 as **Radio 1** and tick the **Use CI-V Interface** option. The **Don't Poll** option will be greyed out automatically.
  - ◆ Exit the Configure Interfaces menu by pressing the **OK** button.
- Testing
  - ◆ Test radio control by entering a frequency in the callsign field. The radio should jump to that frequency.
  - ◆ Open up the Band Map (Radio 1 Window) in Win-Test and tune the VFO. Watch the center of the band map move along with the frequency.
  - ◆ Press **[F1]** (radio set to CW) and listen to the CQ message.

We are now ready to operate the contest.

## See also

- The Icom [IC-736 manual](#)
- The [microHAM](#) Web Pages containing a link to the PDF version of the manual

## Namespaces

- [Page](#)
- [Discussion](#)

## Variants

## Views

- [Read](#)
- [View source](#)
- [View history](#)

## More

- This page was last edited on 1 February 2007, at 13:55.

## Win-Test Wiki

- [Privacy policy](#)
- [About Win-Test Wiki](#)
- [Disclaimers](#)



# BestPractice3

From Win-Test Wiki

[Jump to navigation](#) [Jump to search](#)

## Contents

- [1 Setting up an Icom IC-275H with the microHAM USB Interface IC](#)
- [2 Icom IC-275 settings](#)
- [3 microHAM USB Interface IC](#)
- [4 mircoHAM USB Device Router](#)
- [5 Win-Test](#)
- [6 See also](#)

## Setting up an Icom IC-275H with the microHAM USB Interface IC

This article is a step by step approach describing how to set up an Icom IC-275H and a microHAM USB IC Interface. The USB IC interface is a predecessor of the USB II Interface and it does provide transceiver control, CW and PTT - but no audio isolation transformers, which are not needed in this scenario.

In the end, we will be using PTT, CW keying and transceiver control on the IC-275H, making it ready for the VHF contest.

### Icom IC-275 settings

My IC-275H came with the following settings 1200 Baud, 8 data bits, no parity, 1 stop bit. The hex address of the radio is not known but Win-Test offers the radio in the selection menu.

### microHAM USB Interface IC

The USB Interface IC is a little device no longer in production.



It is similar to its successor, the USB II interface — but it has no audio connectors and thus cannot be used for the digital modes. However, it requires no external power and is a small and handy CAT interface that can be driven by Win-Test.

- Connect the microHAM USB Interface IC to your radio and computer.
  - ◆ On the radio side there will be three connections: CW, Remote and ACC(1).
  - ◆ On the computer side there is only one connection: The USB port.
- Install the microHAM software if you haven't done so already. There are two steps to it:
  - ◆ Installing the device driver - if you have several microHAM devices you will have to do this once for each of them.
  - ◆ Installing the USB Device Router - this software only needs to be installed once. It is identical on all microHAM products.

**Note:** The microHAM USB IC interface hardware driver is identical with the USB II driver. If you had previously installed software for the USB II interface, you can install the driver directly from **C:\Windows\System32\Drivers\FTD2XX.sys**.

### microHAM USB Device Router

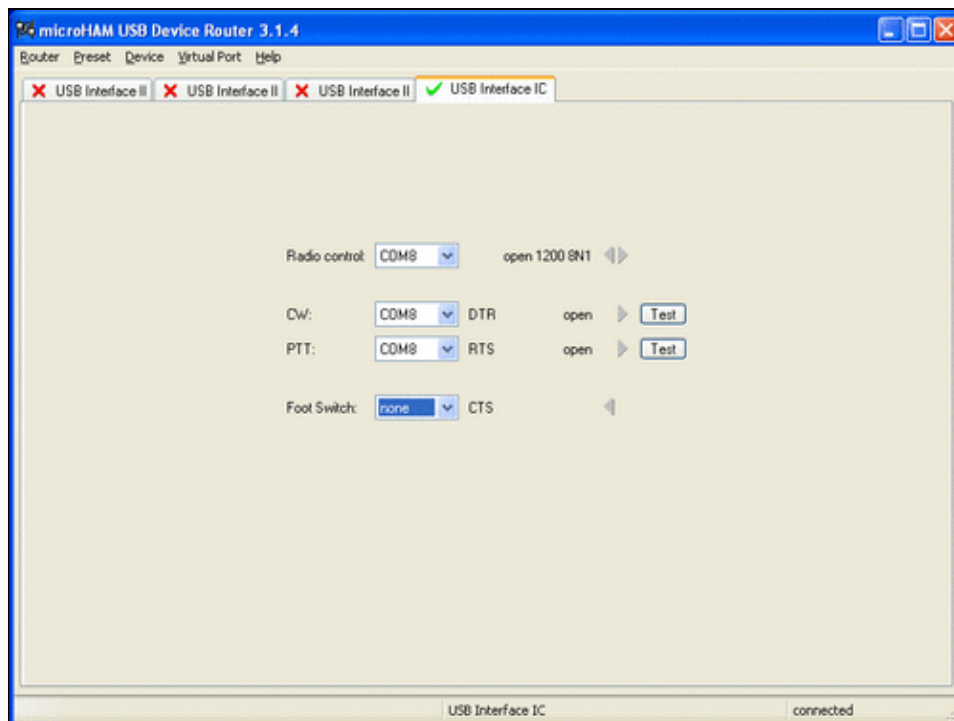

## Win-Test Wiki

microHAM USB Device Router with the USB IC interface installed and set up for COM8. Please note the other three tabs representing USB II interfaces that were also connected to this computer before.

- Set up the Device Router
  - ◆ Create a new virtual port COM8. Since there is only one virtual COM port available, we have to use it for both radio control and PTT/CW switching.
  - ◆ Configure the Radio on COM8
  - ◆ Configure CW on COM8 DTR
  - ◆ Configure PTT on COM8 RTS
- Testing
  - ◆ Press the Test button on the PTT line. The radio should switch to transmit.
  - ◆ Press the Test button on the CW line. The sidetone should be audible now.

## Win-Test

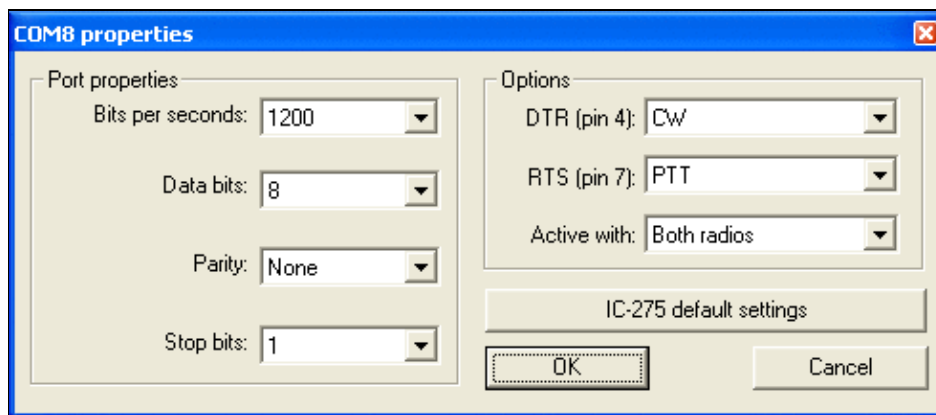

COM settings for the IC-275H

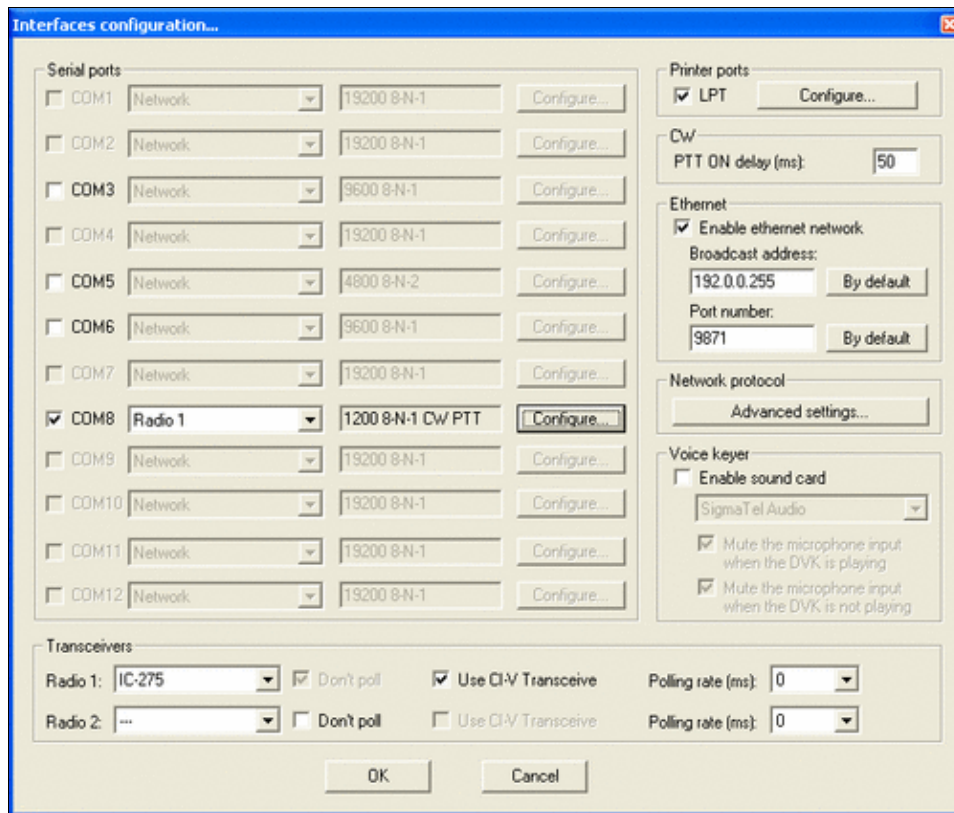

Win-Test settings for the IC-275H

- Start up Win-Test, create a new Win-Test file for testing.
- Go to the Configures Interfaces Menu.
  - ◆ Configure COM8 for **Radio1** at 1200 Baud, 8-N-1 and select CW on the DTR line and PTT on the RTS line.
  - ◆ In the lower left corner of the interfaces configuration menu, select IC-275 as **Radio 1** and tick the **Use CI-V Interface** option. The **Don't Poll** option will be greyed out automatically.
  - ◆ Exit the Configure Interfaces menu by pressing the **OK** button.
- Testing
  - ◆ Test radio control by entering a frequency in the callsign field. The radio should jump to that frequency.
  - ◆ Open up the Band Map (Radio 1 Window) in Win-Test and tune the VFO. Watch the center of the band map move along with the frequency.
  - ◆ Set radio to CW, press [**F1**] and listen to the CQ message.

We are now ready to operate the contest.

## See also

- The Icom [IC-275 manual](#)
- The [microHAM](#) Web Pages containing a link to the PDF version of the manual



## Namespaces

- [Page](#)
- [Discussion](#)

## Variants

## Views

- [Read](#)
- [View source](#)
- [View history](#)

## More

- This page was last edited on 19 December 2009, at 18:56.
- [Privacy policy](#)
- [About Win-Test Wiki](#)
- [Disclaimers](#)



# BestPractice3

From Win-Test Wiki

[Jump to navigation](#) [Jump to search](#)

## Contents

- [1 Setting up an Icom IC-275H with the microHAM USB Interface IC](#)
- [2 Icom IC-275 settings](#)
- [3 microHAM USB Interface IC](#)
- [4 mircoHAM USB Device Router](#)
- [5 Win-Test](#)
- [6 See also](#)

## Setting up an Icom IC-275H with the microHAM USB Interface IC

This article is a step by step approach describing how to set up an Icom IC-275H and a microHAM USB IC Interface. The USB IC interface is a predecessor of the USB II Interface and it does provide transceiver control, CW and PTT - but no audio isolation transformers, which are not needed in this scenario.

In the end, we will be using PTT, CW keying and transceiver control on the IC-275H, making it ready for the VHF contest.

### Icom IC-275 settings

My IC-275H came with the following settings 1200 Baud, 8 data bits, no parity, 1 stop bit. The hex address of the radio is not known but Win-Test offers the radio in the selection menu.

### microHAM USB Interface IC

The USB Interface IC is a little device no longer in production.



It is similar to its successor, the USB II interface — but it has no audio connectors and thus cannot be used for the digital modes. However, it requires no external power and is a small and handy CAT interface that can be driven by Win-Test.

- Connect the microHAM USB Interface IC to your radio and computer.
  - ◆ On the radio side there will be three connections: CW, Remote and ACC(1).
  - ◆ On the computer side there is only one connection: The USB port.
- Install the microHAM software if you haven't done so already. There are two steps to it:
  - ◆ Installing the device driver - if you have several microHAM devices you will have to do this once for each of them.
  - ◆ Installing the USB Device Router - this software only needs to be installed once. It is identical on all microHAM products.

**Note:** The microHAM USB IC interface hardware driver is identical with the USB II driver. If you had previously installed software for the USB II interface, you can install the driver directly from **C:\Windows\System32\Drivers\FTD2XX.sys**.

## mircoHAM USB Device Router

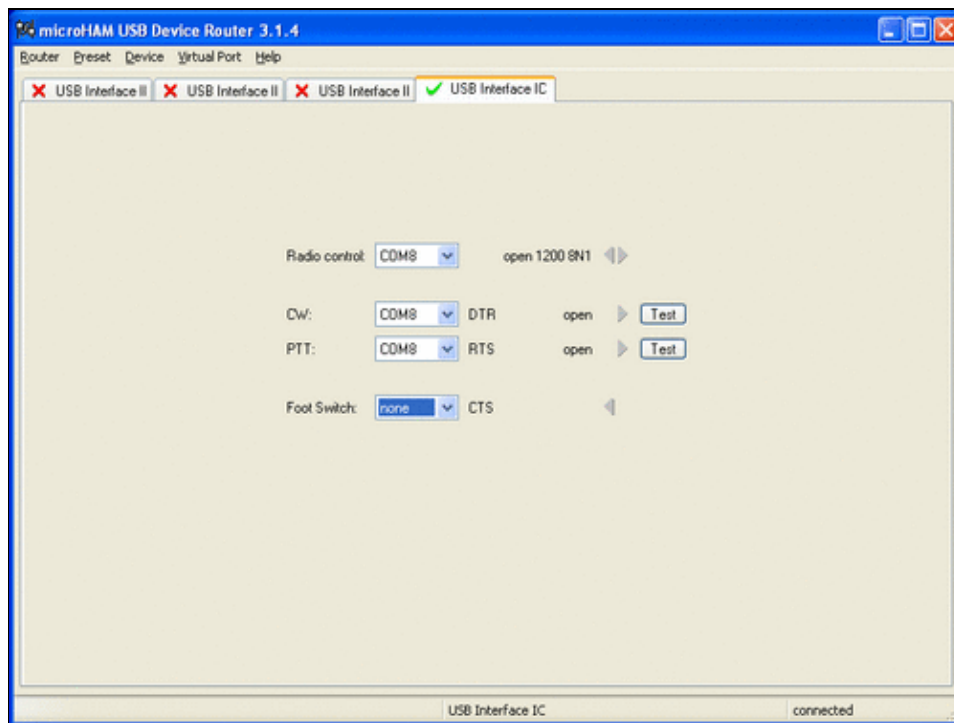

## Win-Test Wiki

microHAM USB Device Router with the USB IC interface installed and set up for COM8. Please note the other three tabs representing USB II interfaces that were also connected to this computer before.

- Set up the Device Router
  - ◆ Create a new virtual port COM8. Since there is only one virtual COM port available, we have to use it for both radio control and PTT/CW switching.
  - ◆ Configure the Radio on COM8
  - ◆ Configure CW on COM8 DTR
  - ◆ Configure PTT on COM8 RTS
- Testing
  - ◆ Press the Test button on the PTT line. The radio should switch to transmit.
  - ◆ Press the Test button on the CW line. The sidetone should be audible now.

## Win-Test

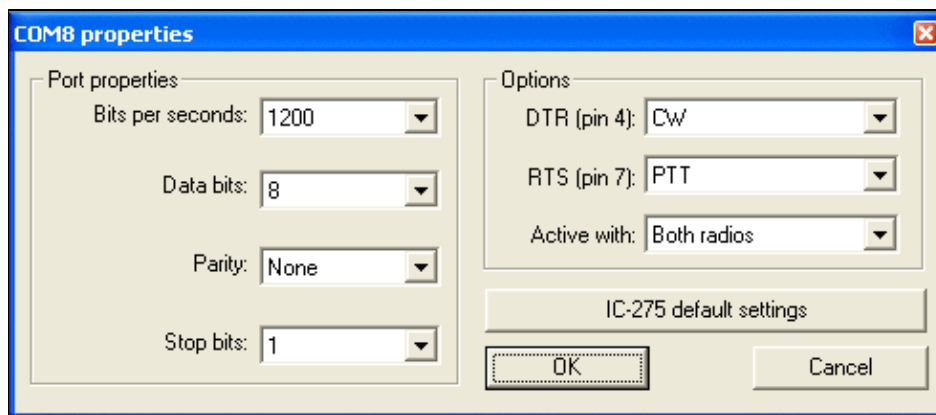

COM settings for the IC-275H

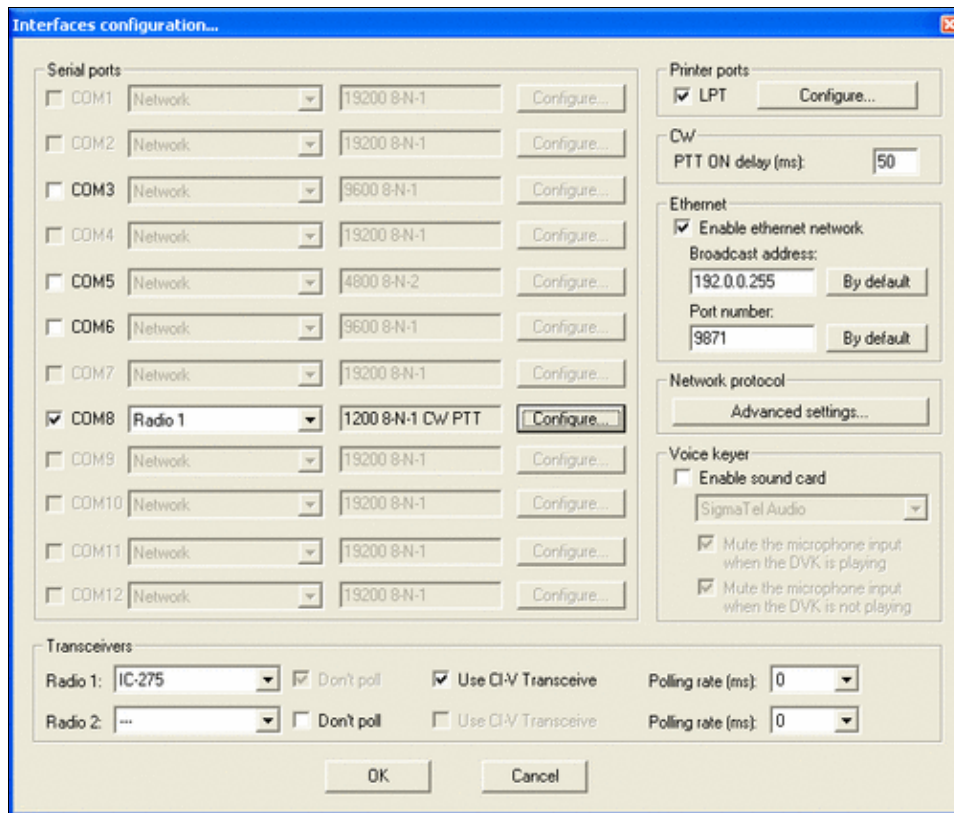

Win-Test settings for the IC-275H

- Start up Win-Test, create a new Win-Test file for testing.
- Go to the Configures Interfaces Menu.
  - ◆ Configure COM8 for **Radio1** at 1200 Baud, 8-N-1 and select CW on the DTR line and PTT on the RTS line.
  - ◆ In the lower left corner of the interfaces configuration menu, select IC-275 as **Radio 1** and tick the **Use CI-V Interface** option. The **Don't Poll** option will be greyed out automatically.
  - ◆ Exit the Configure Interfaces menu by pressing the **OK** button.
- Testing
  - ◆ Test radio control by entering a frequency in the callsign field. The radio should jump to that frequency.
  - ◆ Open up the Band Map (Radio 1 Window) in Win-Test and tune the VFO. Watch the center of the band map move along with the frequency.
  - ◆ Set radio to CW, press **[F1]** and listen to the CQ message.

We are now ready to operate the contest.

## See also

- The Icom [IC-275 manual](#)
- The [microHAM](#) Web Pages containing a link to the PDF version of the manual

## Namespaces

- [Page](#)
- [Discussion](#)

## Variants

## Views

- [Read](#)
- [View source](#)
- [View history](#)

## More

- This page was last edited on 19 December 2009, at 18:56.
- [Privacy policy](#)
- [About Win-Test Wiki](#)
- [Disclaimers](#)



# BestPractice4

From Win-Test Wiki

[Jump to navigation](#) [Jump to search](#)

## Contents

- [1 Setting up an Kenwood TS-850S with the microHAM microKeyer](#)
- [2 Kenwood TS-850 settings](#)
- [3 microHAM micro Keyer](#)
- [4 microHAM USB Device Router](#)
- [5 MMTTY](#)
- [6 Win-Test](#)

## Setting up an Kenwood TS-850S with the microHAM microKeyer

This article is a step by step approach describing how to set up an Kenwood TS-850S radio and a microHAM microKeyer interface. The microKeyer is a complex device integrating a CW-Keyer, CW and FSK keying, PTT control (including a delayed PTT), radio control and a sound interface which allows to control up to seven audio memories and different audio switching scenarios. This article covers the set-up of CW, RTTY and SSB in several steps.

[BestPractice1](#) article describes a slightly simpler set-up with the Microham USB Interface II. Please see there for background information about RTTY and MMTTY in general.

## Kenwood TS-850 settings

- Press and hold the LSB/USB key while you turn the radio on.
- Select menu item 11 (by turning the the M.CH/VFO.CH knob) and change the setting to ON (by pressing the arrow up/down buttons) if necessary. This will set the polarity of MARK and SPACE signals.
- Select menu item 12 and change the setting to 170 if necessary - this is the typical shift used on the HF bands.
- Select menu item 13 and change the setting to 1275 if necessary. This selects the LOW TONES pair.
- Press the CLR button to leave the setup menu.

To test the settings, put the radio to FSK mode, push the MONI button and then switch the radio to transmit by pressing REC/SEND. You should now hear a 1275 Hz tone. If you short the RTTY jacket on the back of the radio you should hear the tone going up to 1445 Hz.

## microHAM micro Keyer

- Make sure you have configured the microHAM Interface for Kenwood using the internal jumpers (see microHAM manual).
- Connect the microHAM micro Keyer to your radio and computer.
  - ◆ On the radio side there will be five connections: CW, RTTY, ACC1, ACC2 and microphone
  - ◆ On the computer side there will be three connections: USB, Line-out and Line-in (or microphone). For FSK operation only we can actually leave out the Line-out connection.
  - ◆ On my computer, once you connect something to the combined Mic/Line-in jack, a pop-up will ask, if this is a microphone or Line-in (see image below). Select Line-in.

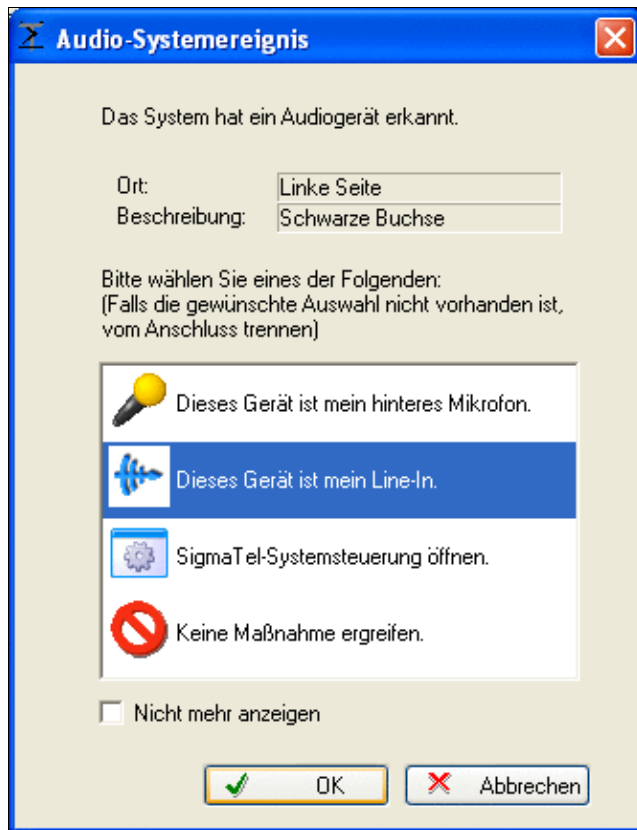

This pop-up comes up on my system every time I connect a cable to the "IN" port

- Install the microHAM software if you haven't done so already. There are two steps to it:
  - ◆ Installing the device driver - if you have several microHAM devices you will have to do this once for each of them.
  - ◆ Installing the USB Device Router - this software only needs to be installed once. It is identical on all microHAM products.

**Note:** If you had previously installed the USB Device Router with another microHAM product, it will come up with a new tab for the hardware connected.

## microHAM USB Device Router

- Set up the Device Router
- Go to the Ports Tab
  - ◆ Create three virtual COM ports: COM5, COM7, COM8 and COM9. Note: The absolute port numbers do not matter. The key is consistency - the same port number must be used for a specific function every time it is used.
  - ◆ Configure Radio on COM5
  - ◆ Press the **Set** button to the right of the radio port configuration and select TS-850. microKeyer will assign different Audio Routing and PTT scenarios if it knows what frequency and mode the radio is set. This is why we have to do it.
  - ◆ You should now see the current frequency of the radio display in the **Ports** tab
  - ◆ Configure Winkey COM7 using Winkey default settings
  - ◆ Configure FSK on COM8. Make sure you tick the PTT tag
  - ◆ Configure Control on COM9. This will allow controlling the microKeyer from Win-Test.



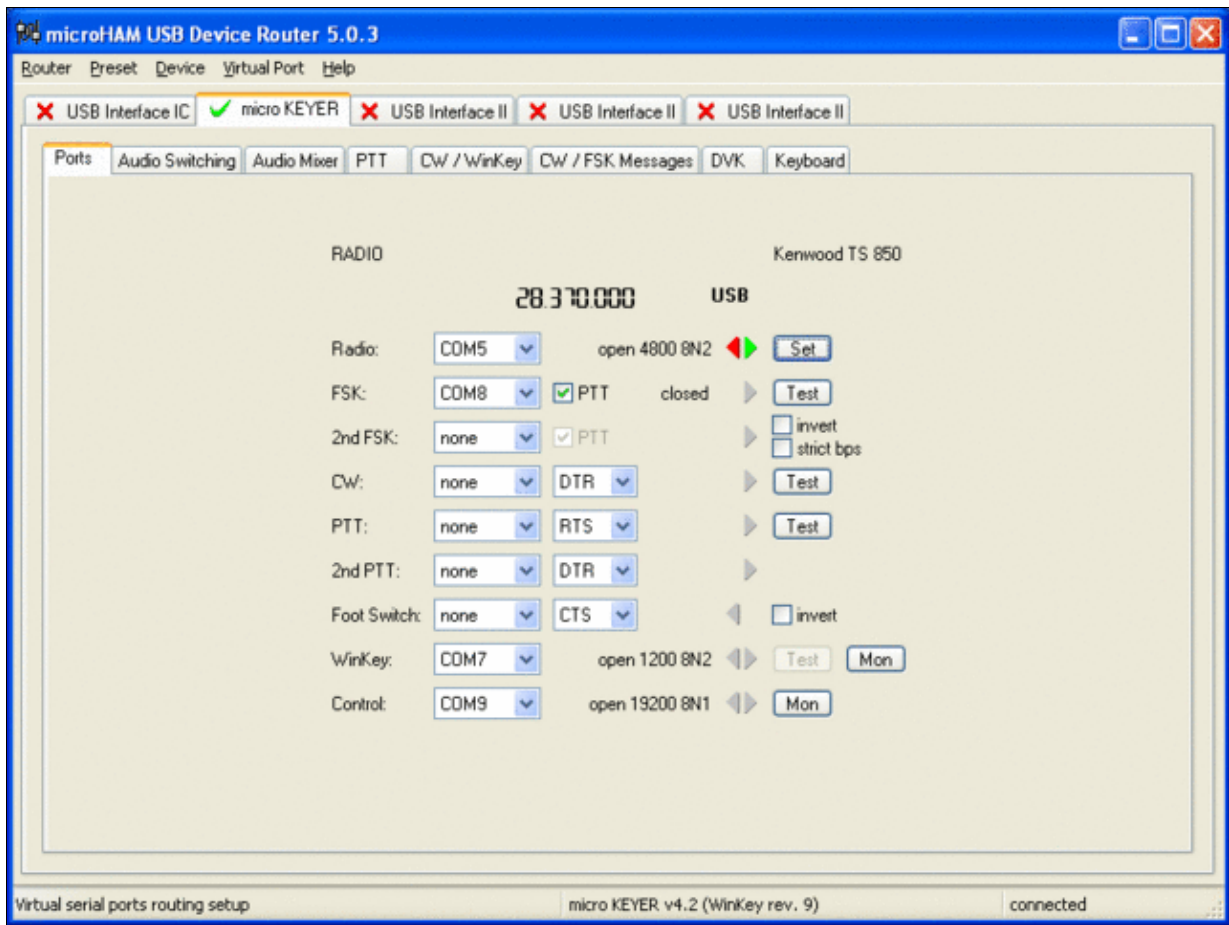

microHAM microKeyer Ports setup. We use COM5,7,8 and 9 to control different properties of the microKeyer.

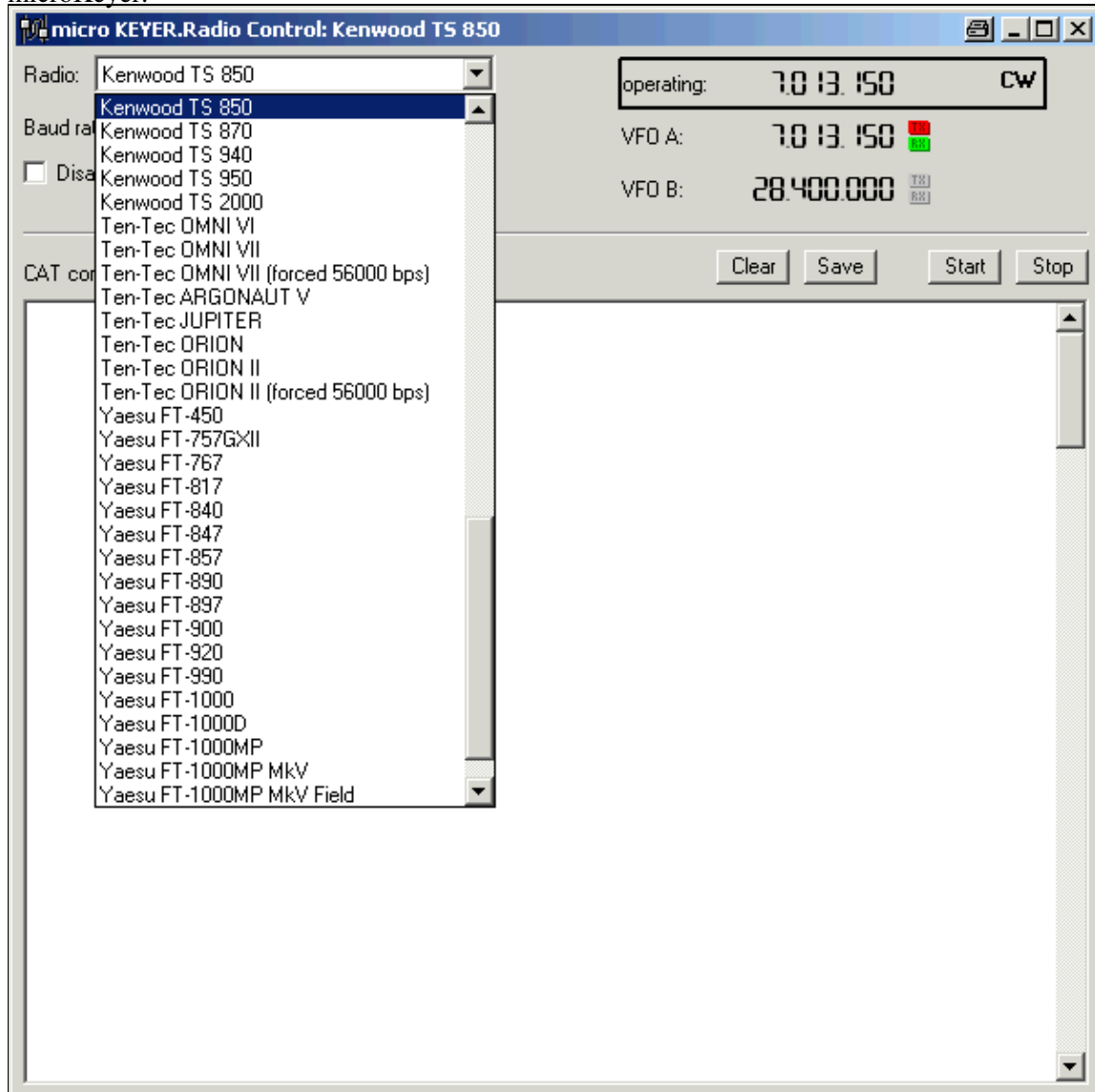

Make sure, the mircoKeyer knows about your radio so it can control Audio Switching and PTT depending on the selected mode.

- Go to the Audio Switching Tab
  - ◆ Configure the Audio Switching as shown below.
    - ◇ The top picture is for receive mode and VOX controlled operation.
    - ◇ The middle pictures shows the scenario when PTT is activated via one of the COM ports for digital modes or voice recorder play.
    - ◇ The bottom picture finally shows the situation for foot switch or manually activated PTT.
    - ◇ In each of the thee scenarios you wish to select a different audio switching, depending on the mode selected. So in all, you can select nine different settings. The most sensible for me is AAA/CBA/BBB, which means: don't care on CW; on SSB route microphone to sound card for recording (no PTT), mute microphone when playing a recorded voice message and route microphone directly to radio when PTT or foot switch is pressed; on digi modes, always mute microphone.

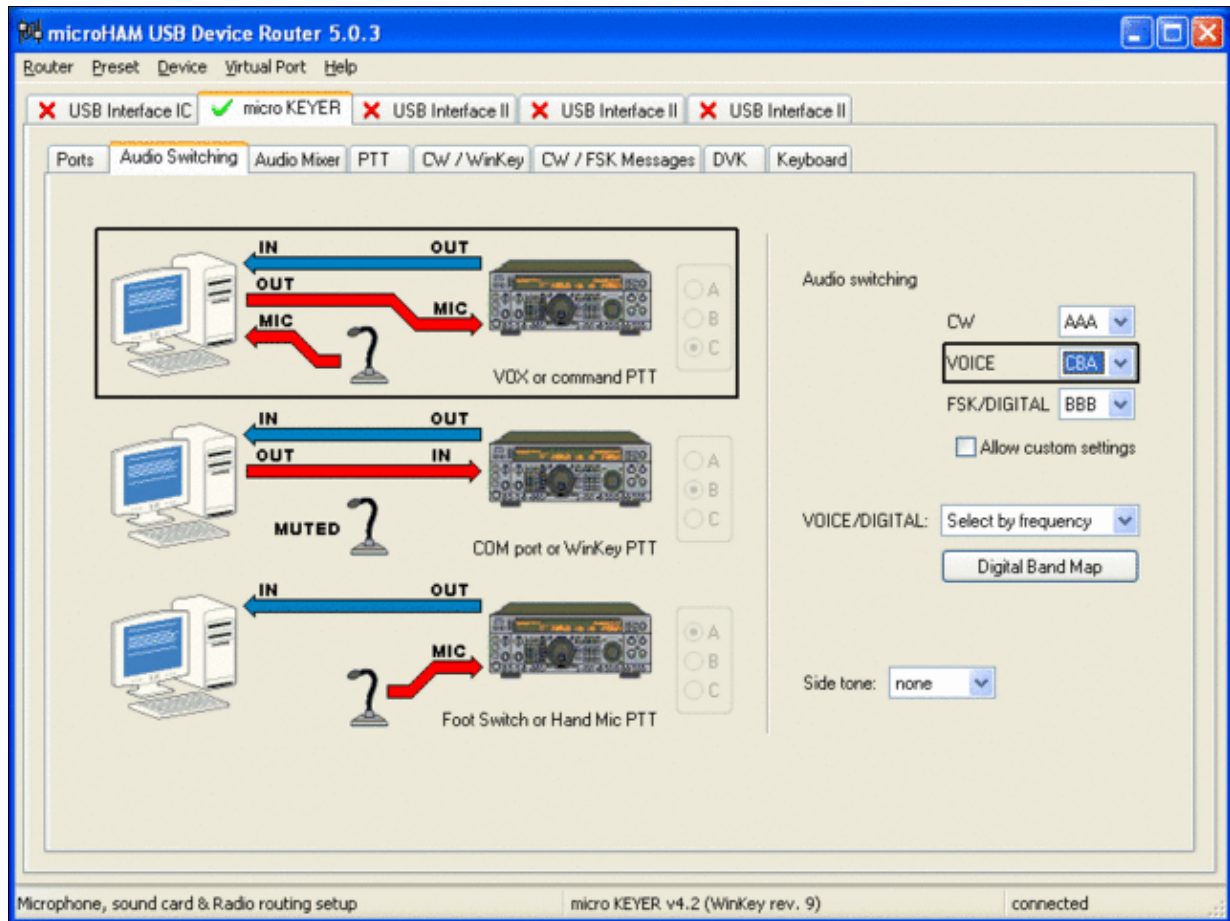

microHAM microKeyer Audio Switching setup.

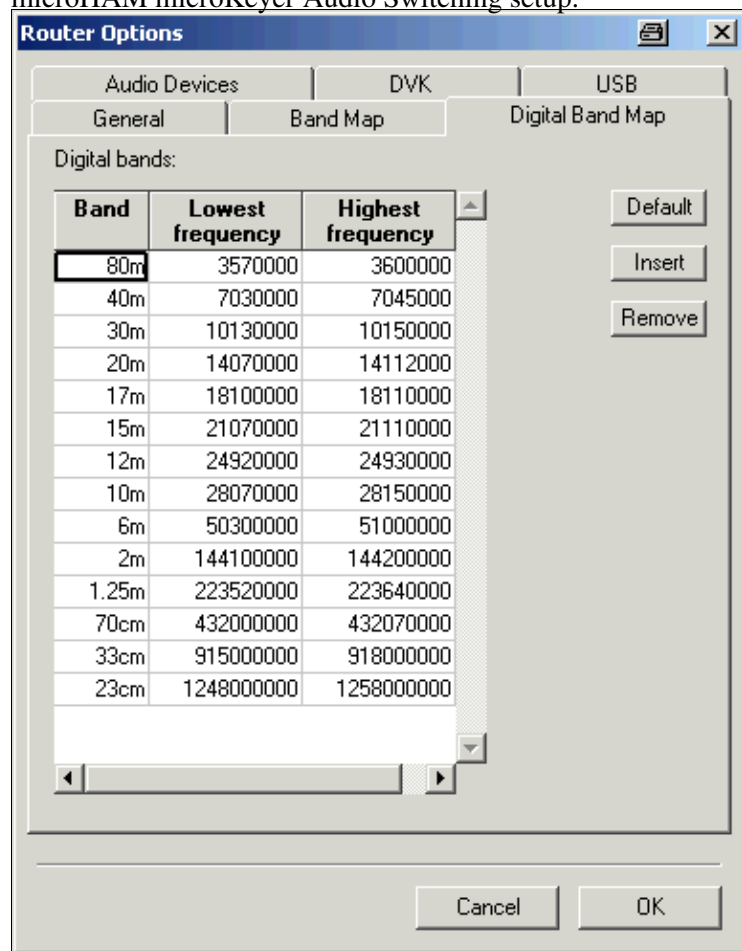

## Win-Test Wiki

This is the digital band map which is used to decide which mode the radio is operating in. With Kenwood radios, microKeyer retrieves the mode directly from the communication protocol, so this map is not used.

- Go to the PTT Tab
  - ◆ In the PTT selector, select QSK for CW, PTT1 for Voice and PTT2 for Digital Modes. This will allow using QSK or VOX operation on CW (which I prefer over the microHAM doing all the switching - but mind hot switching PA relays!)

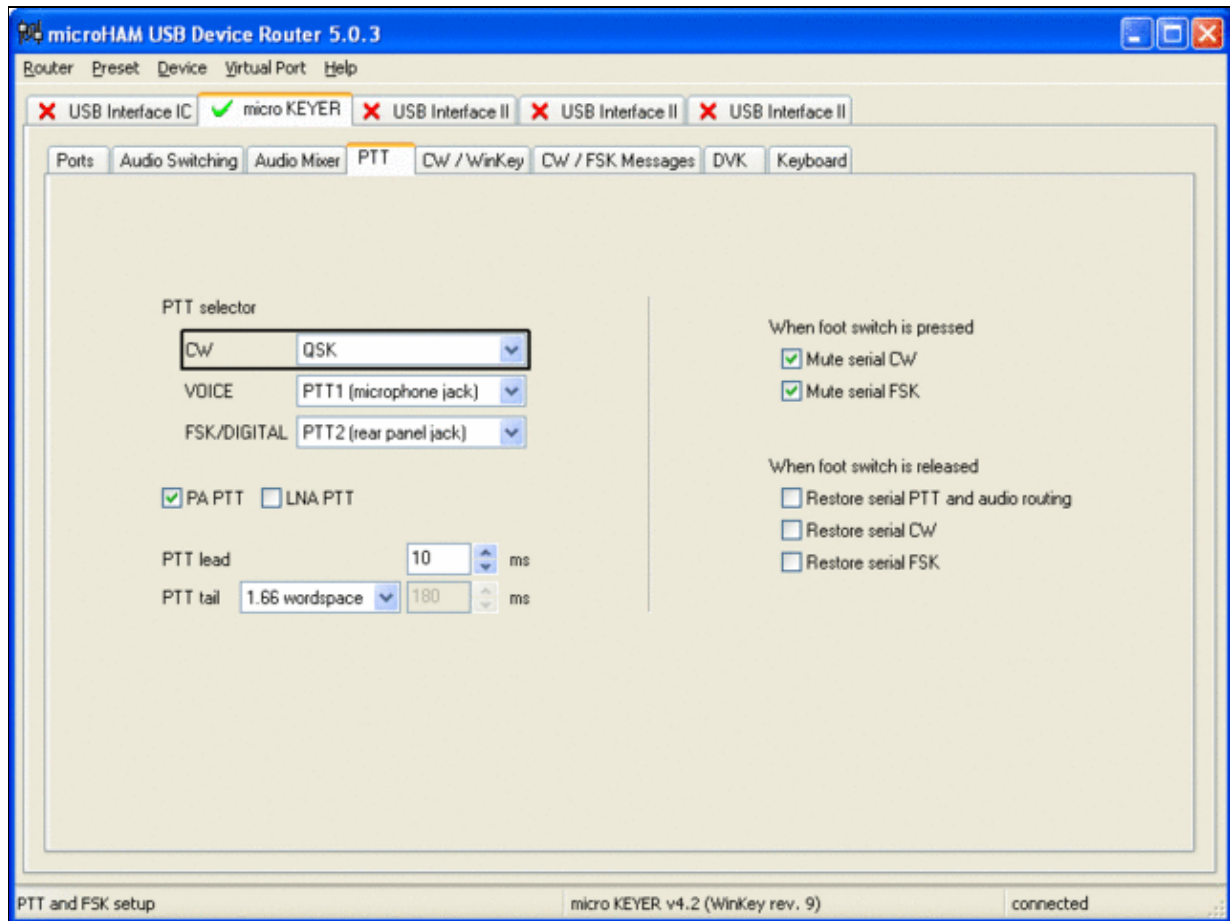

Different PTT settings depending on mode

- Go to the CW/WinKey Tab
  - ◆ My preferred settings are Paddle Mode: Iambic A (Curtis), disable Paddle memory (actually, Dot-Dash-Memory off)

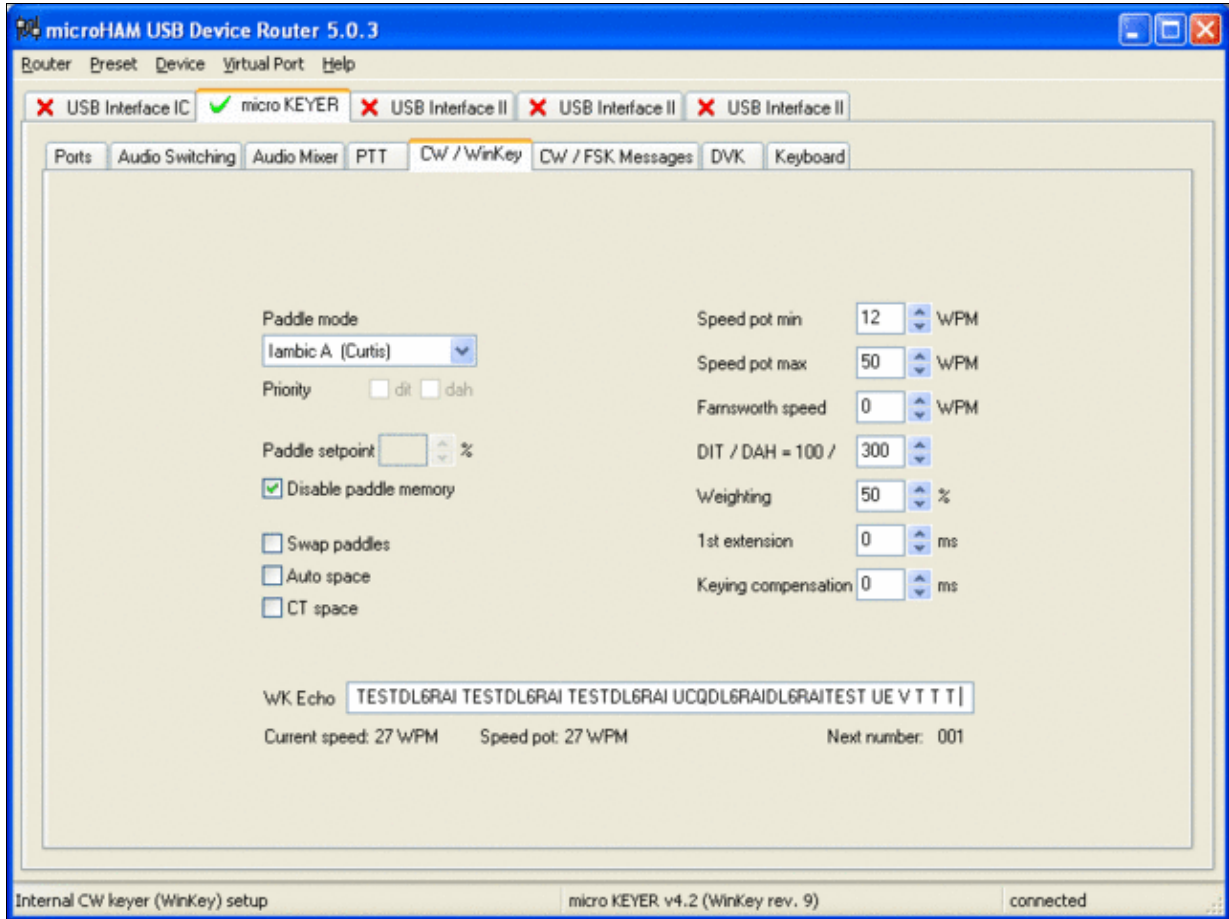

WinKey settings - this is very much depending on your personal preferences

- Testing
  - ◆ Go to a CW frequency, switch the radio to CW and press the VOX button on the radio (you may even wish to additionally select the FULL button just right to the VOX button on the TS-850 to have full QSK)
  - ◆ Touch the paddle - the radio should switch to transmit without any relay clicking in the microKeyer
  - ◆ The CW/FSK LED on the microKeyer should flicker with a red light
  - ◆ Press the Test button on the Winkey port (COM 7) in the Port Tab. The microKeyer should send **Dah dit dit-dit-dit dah**
  - ◆ Go to a SSB frequency and switch the radio to USB or LSB
  - ◆ Press the microphone's PTT and say something. The PTT1/PTT2 LED on the microKeyer should light up in red color. The radio should go to transmit and produce some output
  - ◆ Go to the DVK tab, push the RECORD button and say something. Then push the PLAY button. The radio should activate the PTT1/PTT2 (red light) and transmit your recorded message.
  - ◆ Press the MON button on the radio and listen to the audio. Some audio level adjustments may be required in the Audio Mixer tab.
  - ◆ Go to a RTTY frequency and switch the radio to FSK
  - ◆ Press the Test button on the FSK port (COM8) in the Port Tab. The radio should switch to transmit, send TEST on RTTY and go back to received
  - ◆ The CW/FSK LED should flicker with a green light and the PTT1/PTT2 LED should turn green, while the radio is on transmit

We are now ready for the next step.

## MMTTY

- Download and Install MMTTY from [here](#).
- Start MMTTY
- Activate the XY Scope by selecting the **View (V)** menu item and tagging **XYScope**

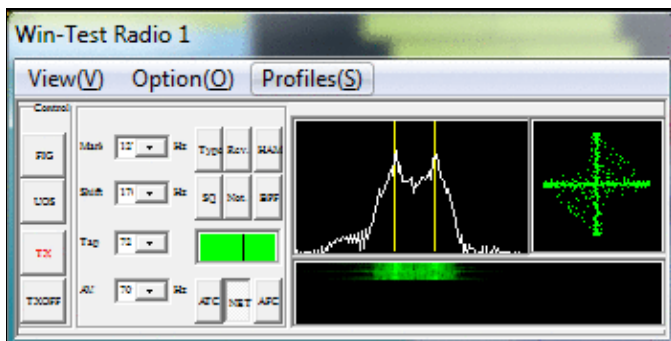

The XY Scope is a practical tuning aid and will help us to visualize the received signals.

- Go to **Option (O) | Setup MMTTY (O) ...**
- Select the Demodulator tab and set it up like in the picture below.

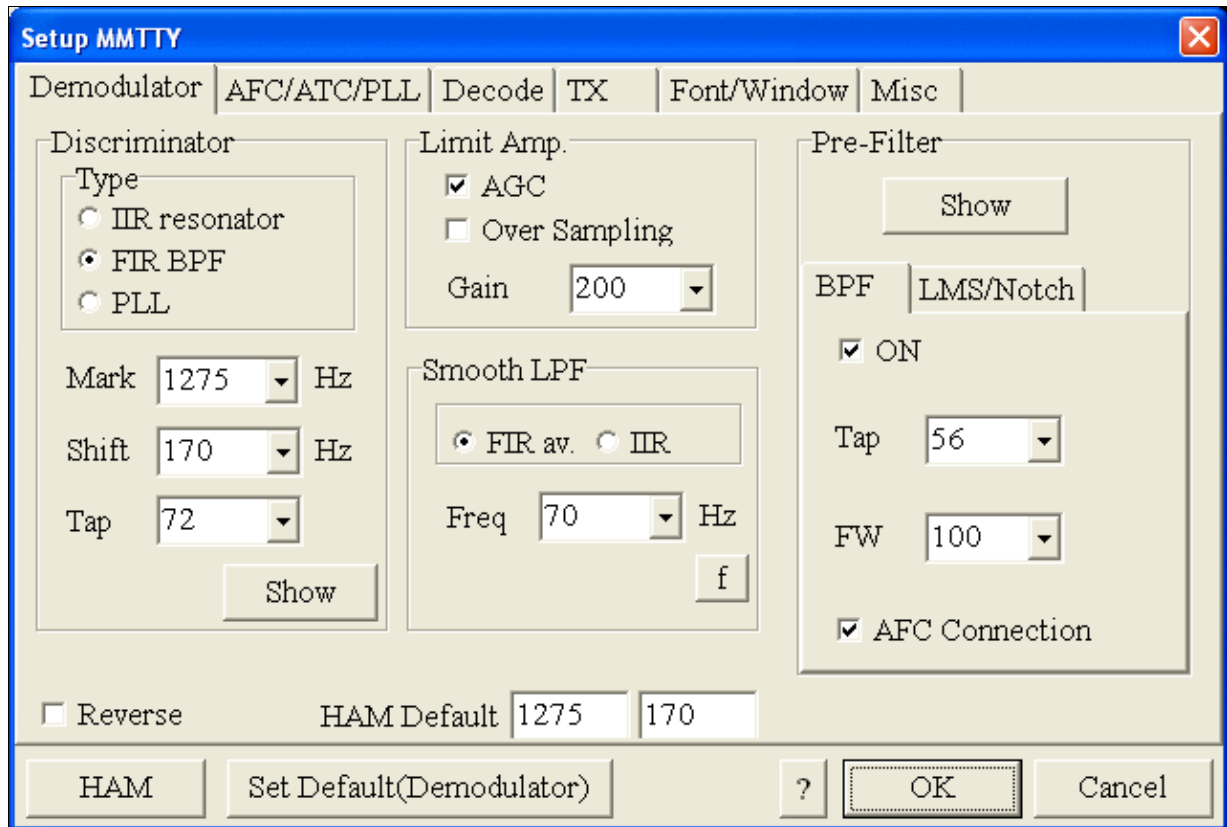



## MMTTY Demodulator settings

- Select the AFC/ATC/PLL tab and make sure AFC is OFF.

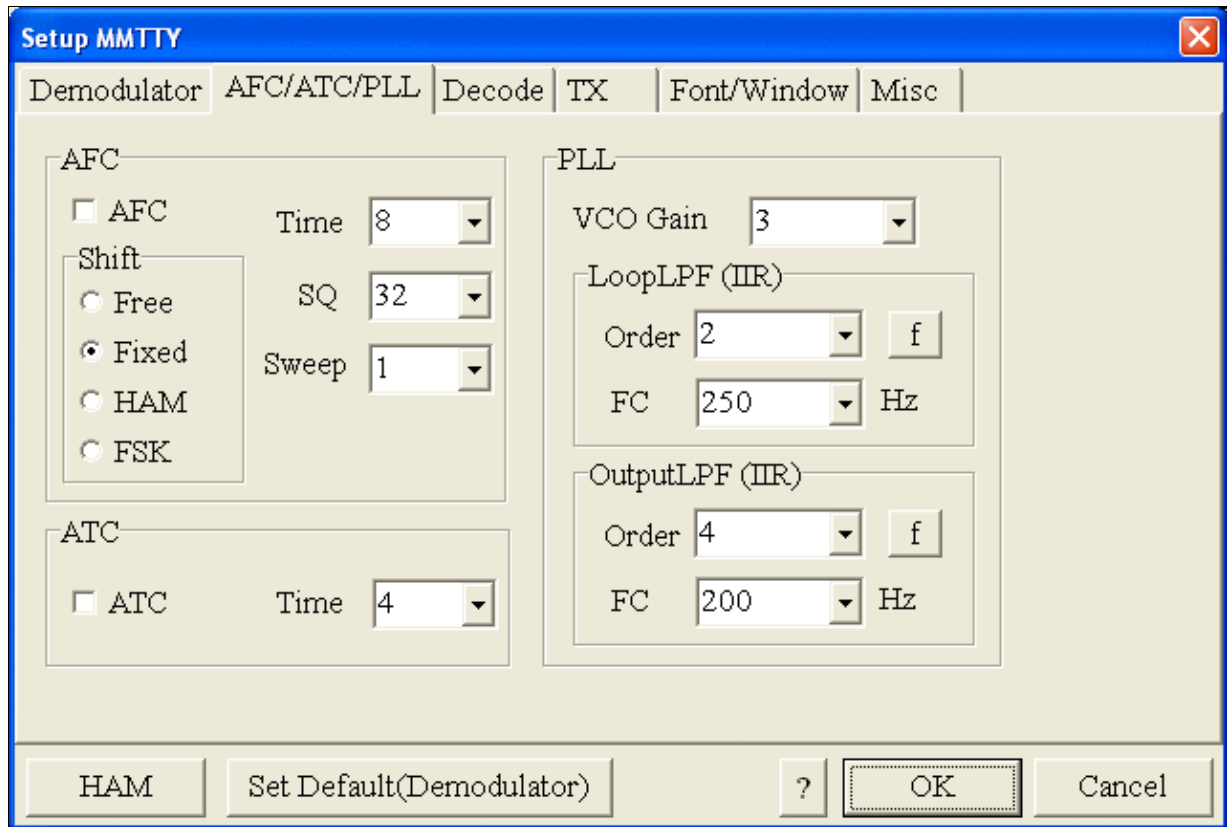

MMTTY AFC/ATC/PLL settings. Make sure AFC is off as it will eventually introduce a deviation between TX and RX frequencies.

- Select the TX tab and switch PTT port to COM8. The Radio Command button in this setup screen will allow you to control the radio from within MMTTY. This is not desired in this scenario so make sure it is **not configured** - otherwise Win-Test would not have access to the radio COM port later.

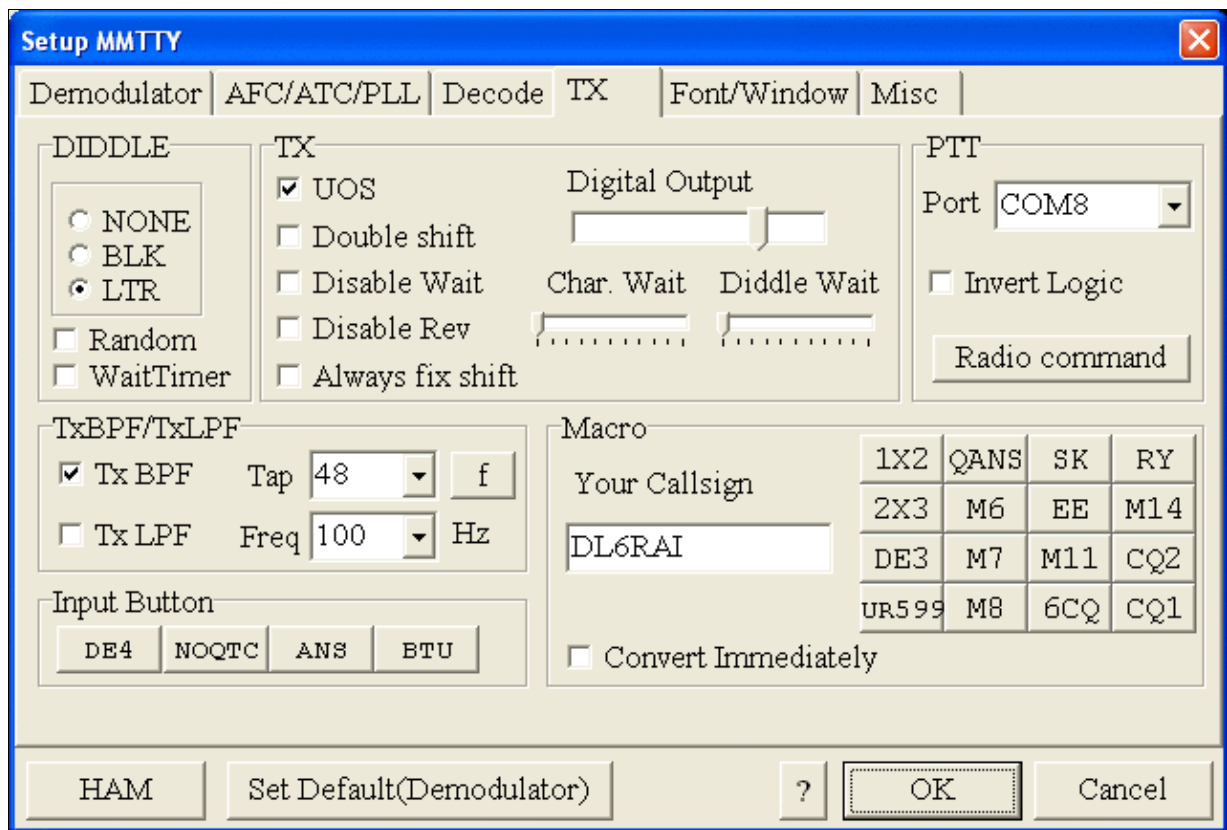

MMTTY Tx settings - PTT is generated by the microKeyer through COM8

- Select the Misc tab and select COM-TxD(FSK).

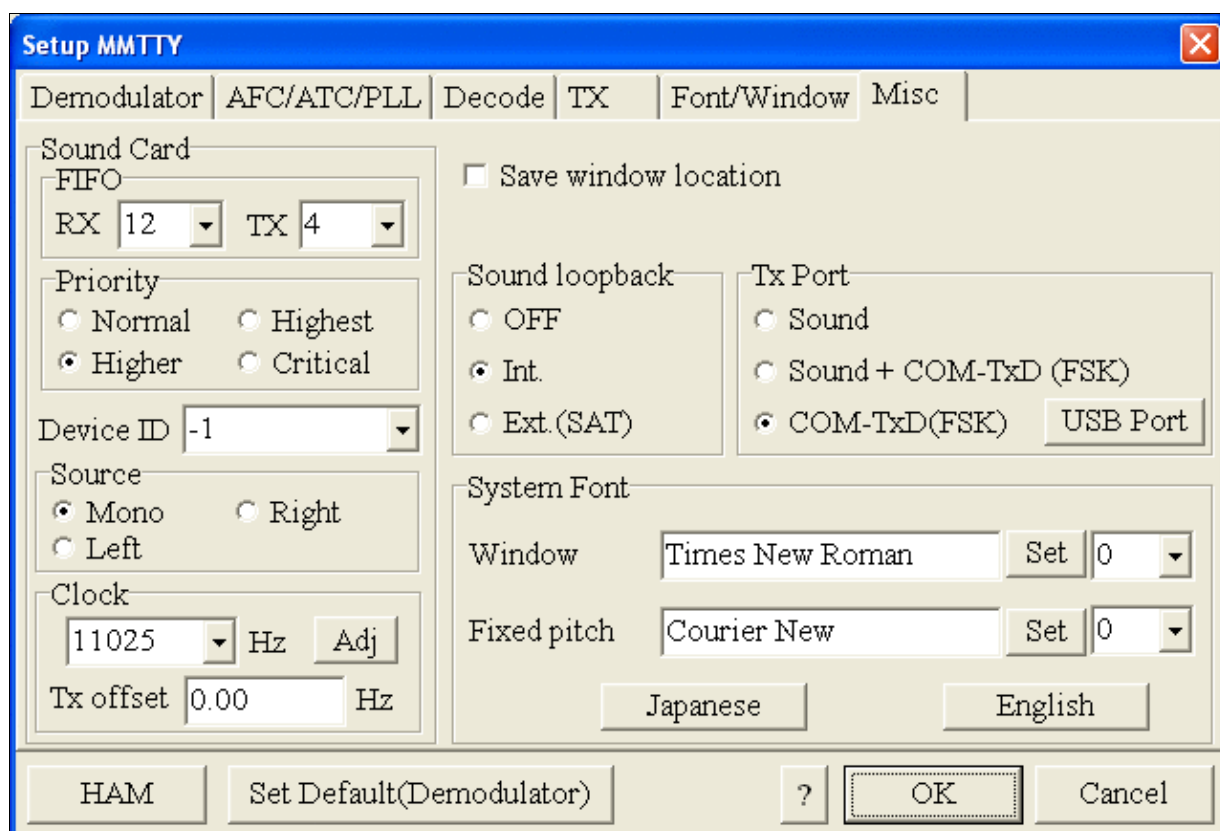

MMTTY Misc settings - FSK is generated via COM8

- If you see problems the FSK signal (especially: keying does work, you hear the RTTY diddle, but chars won't be sent), you might have to limit the USB port speed in MMTTY. This setting depends very much on the computer hardware. To limit the USB port speed click on **USB Port** and configure option "C". You can find this setting also in the support documentation of the Microkeyer on the microHAM website.

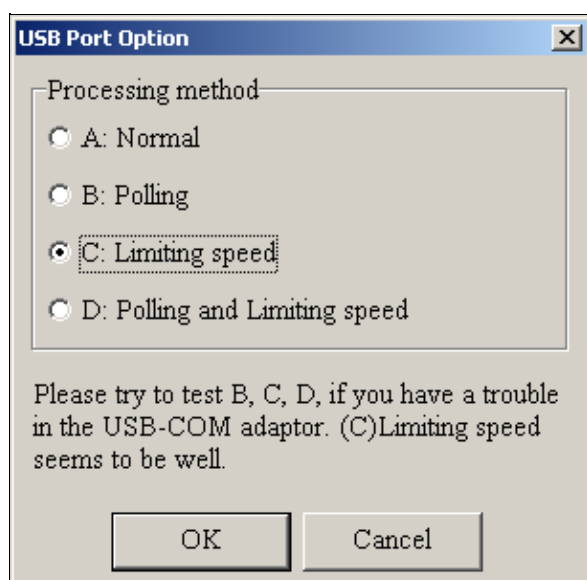

MMTTY USB Port Option - Set only to option C if A does not work for you.

- Exit the Setup screens by pressing the OK button.

We are now ready to do some tests with MMTTY.

- Now take a look at the XY Scope display. It should look like the picture above.
- If you only see a single white point in the middle of the display, this means, that MMTTY gets no audio to process.
  - ◆ Check your cabling. Is your cable connected to Line-in or Mic-in?
- ◆ Check the level setting for your sound card. Open the Sound control (click on the loudspeaker symbol in your task bar), switch to the Recording section and adjust the level for Line-in. When you move the control up and down you should see an increase and decrease in noise level.

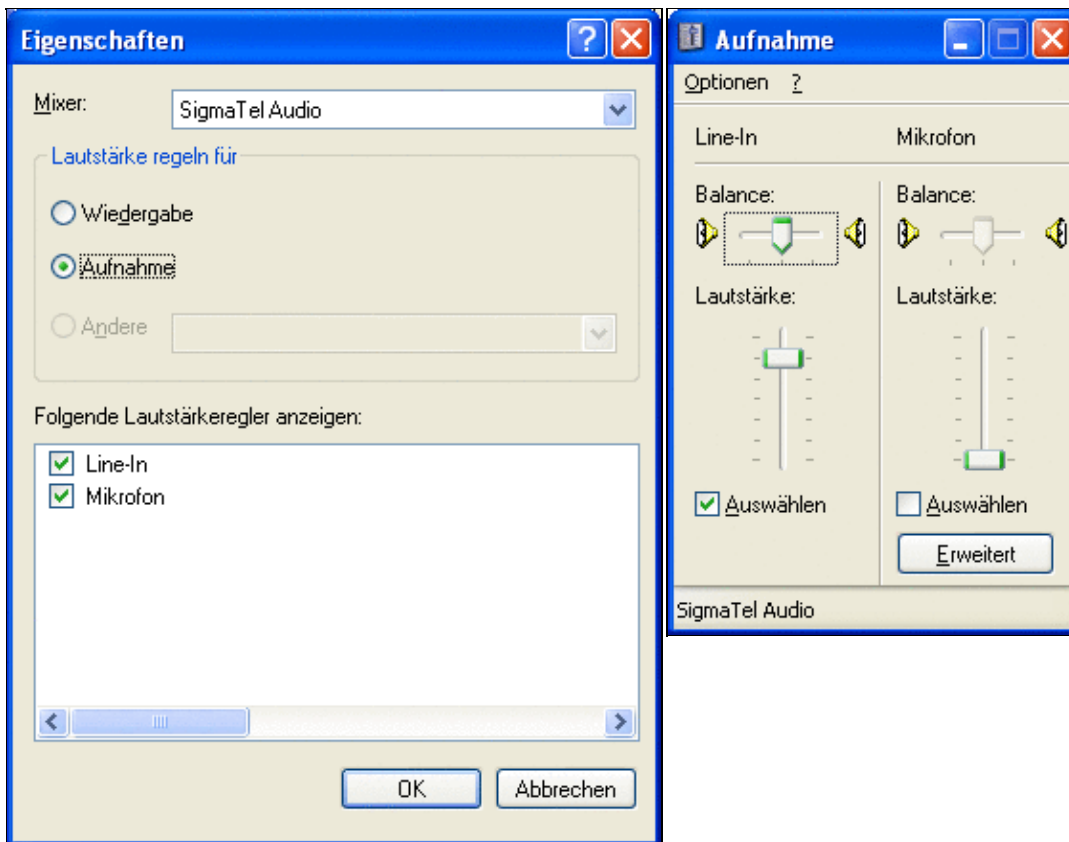

Sound card dialog - select Recording here

Sound card dialog - adjust the level of Line-in

- Tune across the CW band and check if the XY scope changes when you hear signals. Once you tune across a carrier or CW signal, you should see a vertical ellipse and then a horizontal ellipse or vice versa depending on which direction you tune. The receive section of the screen will show all kinds of clutter.
- Try to find a RTTY signal (not easy on a normal day). Both ellipses should now be perpendicular to each other. See if you can decode RTTY fine. You may have to select proper filters. I use 500 Hz at 8.8 MHz IF and 2.7 kHz at 455 kHz IF.
- Next, press the TX button in the MMTTY application. You should hear the typical RTTY diddle in the monitor of the radio. The XY Scope will also display a clean RTTY signal.
- Type a few characters (including your callsign) and see how they are transmitted.
- Press the TX button one more time to shut off transmission.
- Exit the MMTTY program now.

MMTTY now works perfectly as a stand-alone program. We are now ready for Win-Test.

## Win-Test

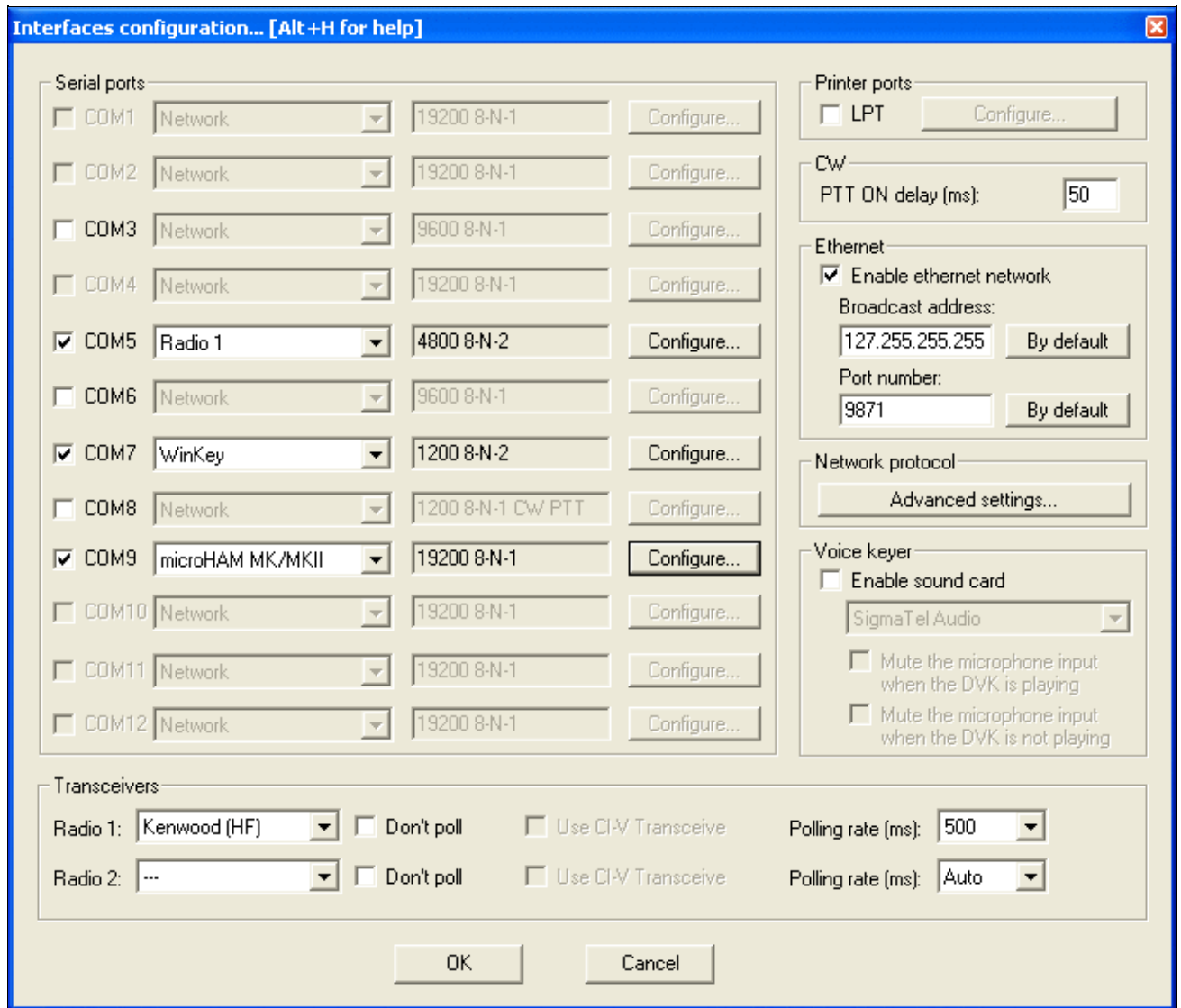

Final steps: Win-Test Interfaces configuration. Note that we only set up three COM ports, no PTT or CW settings are needed as they are all generated/controlled from the microKeyer.

- Start up Win-Test, create a new Win-Test file for testing.
- Select DXpedition and allow All Modes so you can test all three different modes.
- in the **Options | Configure Interfaces...** menu
  - ◆ configure Radio on COM5
  - ◆ configure Winkey on COM7 using default settings
  - ◆ configure microHAM MK/MKII on COM9
  - ◆ untag Win-Test's internal Voice Keyer
- Go to Configure MMTTY.EXE startup path as described in the [RTTY section of this manual](#) if you are planning for RTTY operation

We are now ready to operate the contest.

## Namespaces

- [Page](#)
- [Discussion](#)

## Variants

## Views

- [Read](#)
- [View source](#)
- [View history](#)

## More

- This page was last edited on 19 December 2009, at 18:56.
- [Privacy policy](#)
- [About Win-Test Wiki](#)
- [Disclaimers](#)



# BestPractice4

From Win-Test Wiki

[Jump to navigation](#) [Jump to search](#)

## Contents

- [1 Setting up an Kenwood TS-850S with the microHAM microKeyer](#)
- [2 Kenwood TS-850 settings](#)
- [3 microHAM micro Keyer](#)
- [4 microHAM USB Device Router](#)
- [5 MMTTY](#)
- [6 Win-Test](#)

## Setting up an Kenwood TS-850S with the microHAM microKeyer

This article is a step by step approach describing how to set up an Kenwood TS-850S radio and a microHAM microKeyer interface. The microKeyer is a complex device integrating a CW-Keyer, CW and FSK keying, PTT control (including a delayed PTT), radio control and a sound interface which allows to control up to seven audio memories and different audio switching scenarios. This article covers the set-up of CW, RTTY and SSB in several steps.

[BestPractice1](#) article describes a slightly simpler set-up with the Microham USB Interface II. Please see there for background information about RTTY and MMTTY in general.

## Kenwood TS-850 settings

- Press and hold the LSB/USB key while you turn the radio on.
- Select menu item 11 (by turning the the M.CH/VFO.CH knob) and change the setting to ON (by pressing the arrow up/down buttons) if necessary. This will set the polarity of MARK and SPACE signals.
- Select menu item 12 and change the setting to 170 if necessary - this is the typical shift used on the HF bands.
- Select menu item 13 and change the setting to 1275 if necessary. This selects the LOW TONES pair.
- Press the CLR button to leave the setup menu.

To test the settings, put the radio to FSK mode, push the MONI button and then switch the radio to transmit by pressing REC/SEND. You should now hear a 1275 Hz tone. If you short the RTTY jacket on the back of the radio you should hear the tone going up to 1445 Hz.

## microHAM micro Keyer

- Make sure you have configured the microHAM Interface for Kenwood using the internal jumpers (see microHAM manual).
- Connect the microHAM micro Keyer to your radio and computer.
  - ◆ On the radio side there will be five connections: CW, RTTY, ACC1, ACC2 and microphone
  - ◆ On the computer side there will be three connections: USB, Line-out and Line-in (or microphone). For FSK operation only we can actually leave out the Line-out connection.
  - ◆ On my computer, once you connect something to the combined Mic/Line-in jack, a pop-up will ask, if this is a microphone or Line-in (see image below). Select Line-in.



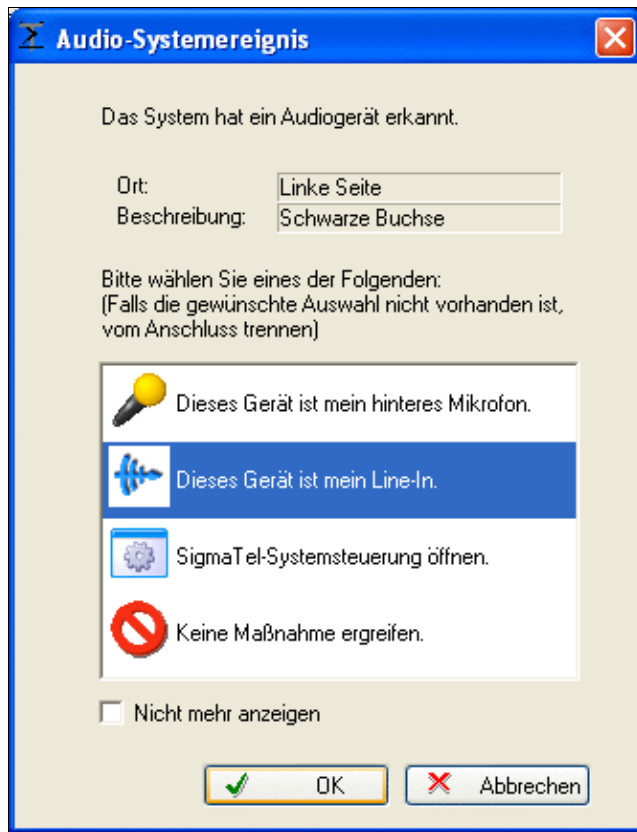

This pop-up comes up on my system every time I connect a cable to the "IN" port

- Install the microHAM software if you haven't done so already. There are two steps to it:
  - ◆ Installing the device driver - if you have several microHAM devices you will have to do this once for each of them.
  - ◆ Installing the USB Device Router - this software only needs to be installed once. It is identical on all microHAM products.

**Note:** If you had previously installed the USB Device Router with another microHAM product, it will come up with a new tab for the hardware connected.

## microHAM USB Device Router

- Set up the Device Router
- Go to the Ports Tab
  - ◆ Create three virtual COM ports: COM5, COM7, COM8 and COM9. Note: The absolute port numbers do not matter. The key is consistency - the same port number must be used for a specific function every time it is used.
  - ◆ Configure Radio on COM5
  - ◆ Press the **Set** button to the right of the radio port configuration and select TS-850. microKeyer will assign different Audio Routing and PTT scenarios if it knows what frequency and mode the radio is set. This is why we have to do it.
  - ◆ You should now see the current frequency of the radio display in the **Ports** tab
  - ◆ Configure Winkey COM7 using Winkey default settings
  - ◆ Configure FSK on COM8. Make sure you tick the PTT tag
  - ◆ Configure Control on COM9. This will allow controlling the microKeyer from Win-Test.

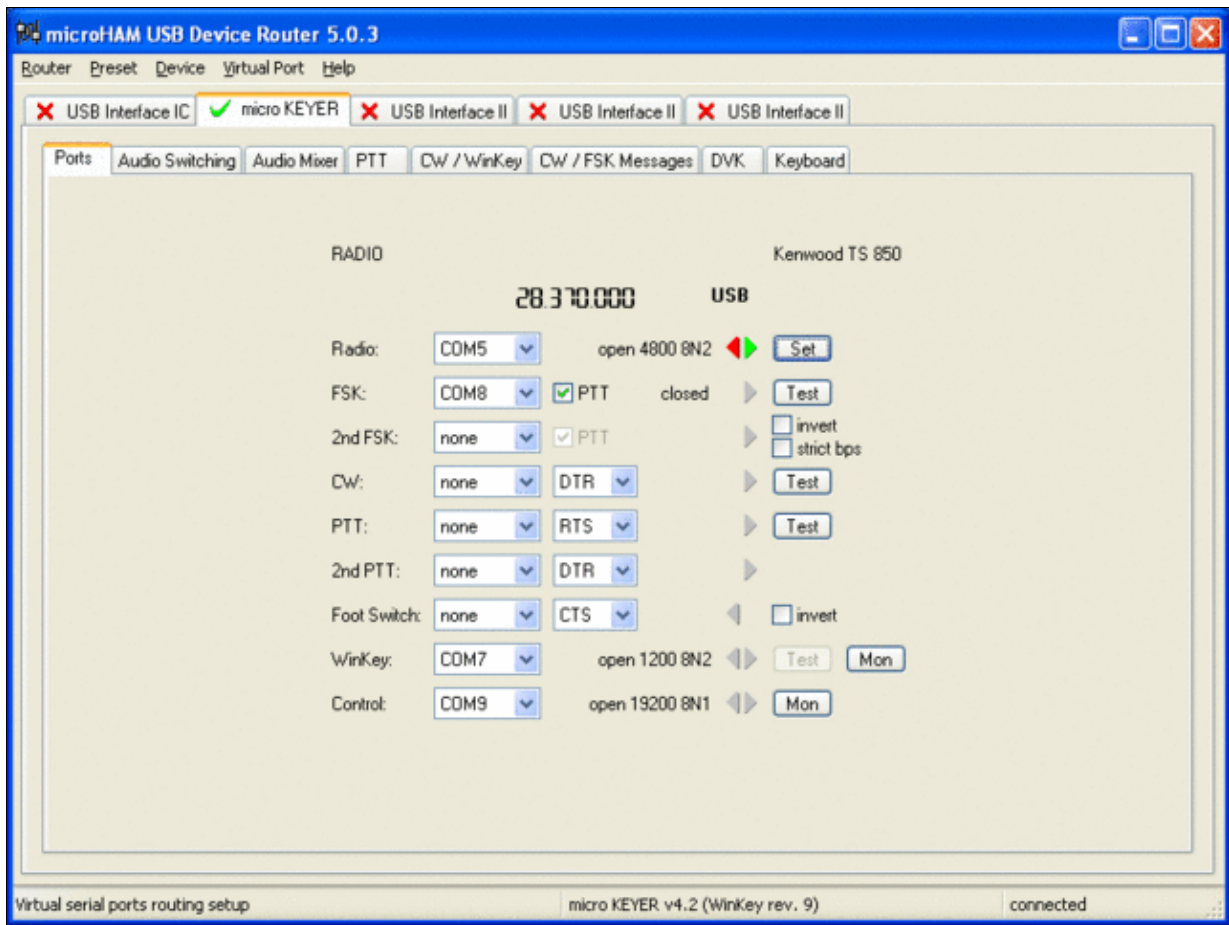

microHAM microKeyer Ports setup. We use COM5,7,8 and 9 to control different properties of the microKeyer.

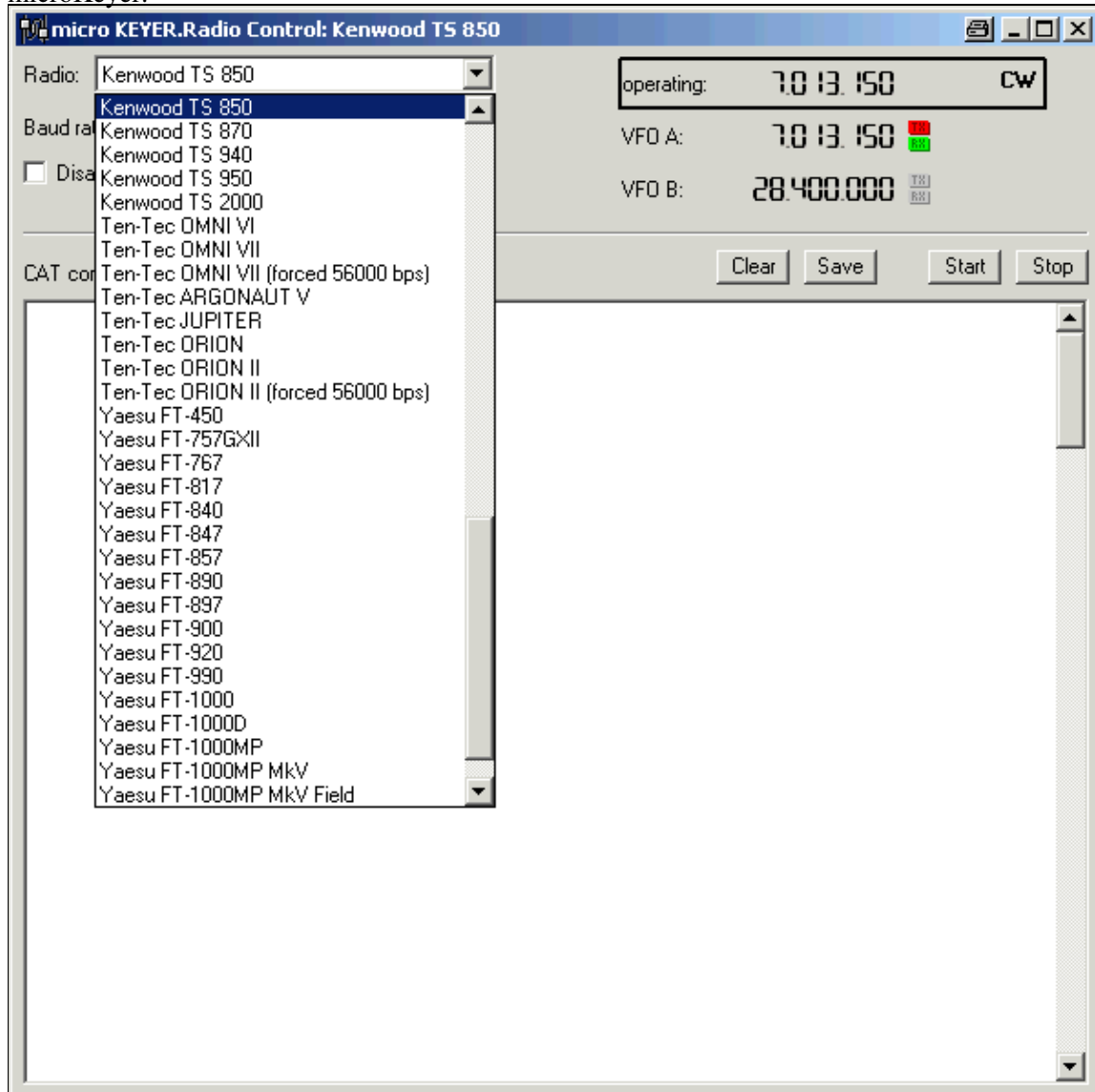

Make sure, the mircoKeyer knows about your radio so it can control Audio Switching and PTT depending on the selected mode.

- Go to the Audio Switching Tab
  - ◆ Configure the Audio Switching as shown below.
    - ◇ The top picture is for receive mode and VOX controlled operation.
    - ◇ The middle pictures shows the scenario when PTT is activated via one of the COM ports for digital modes or voice recorder play.
    - ◇ The bottom picture finally shows the situation for foot switch or manually activated PTT.
    - ◇ In each of the thee scenarios you wish to select a different audio switching, depending on the mode selected. So in all, you can select nine different settings. The most sensible for me is AAA/CBA/BBB, which means: don't care on CW; on SSB route microphone to sound card for recording (no PTT), mute microphone when playing a recorded voice message and route microphone directly to radio when PTT or foot switch is pressed; on digi modes, always mute microphone.

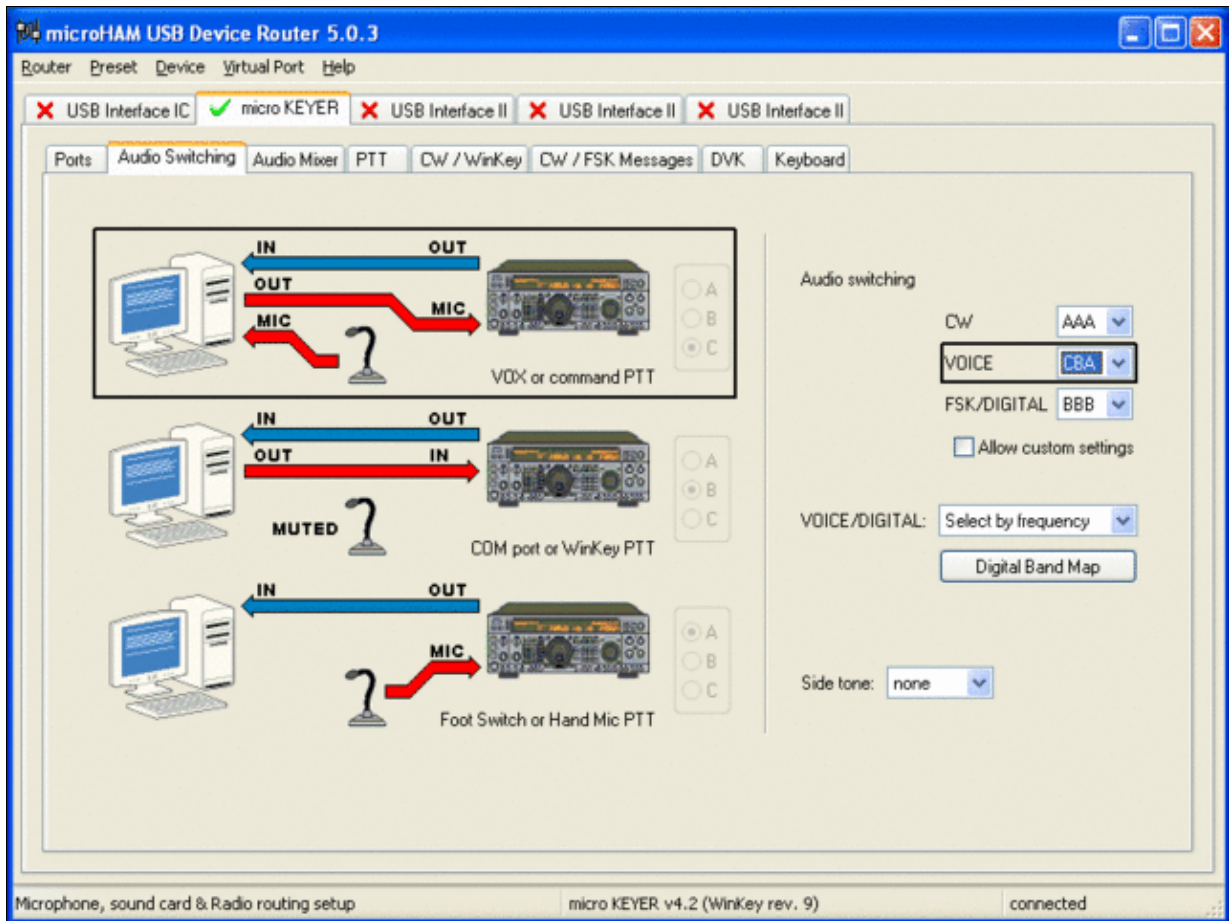

## microHAM microKeyer Audio Switching setup.

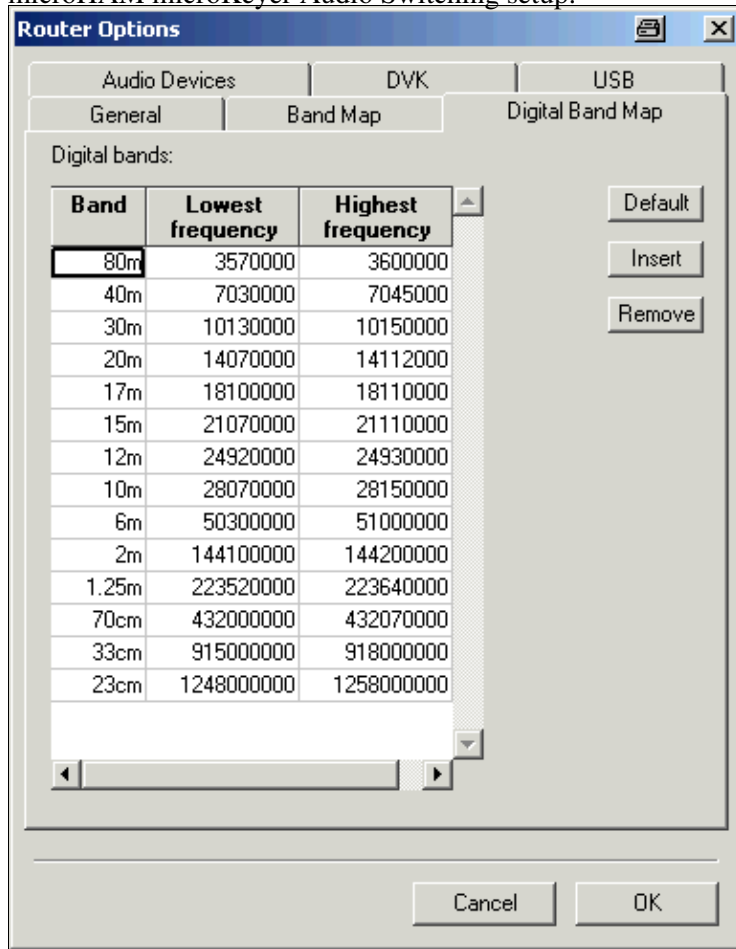

## Win-Test Wiki

This is the digital band map which is used to decide which mode the radio is operating in. With Kenwood radios, microKeyer retrieves the mode directly from the communication protocol, so this map is not used.

- Go to the PTT Tab
  - ◆ In the PTT selector, select QSK for CW, PTT1 for Voice and PTT2 for Digital Modes. This will allow using QSK or VOX operation on CW (which I prefer over the microHAM doing all the switching - but mind hot switching PA relays!)

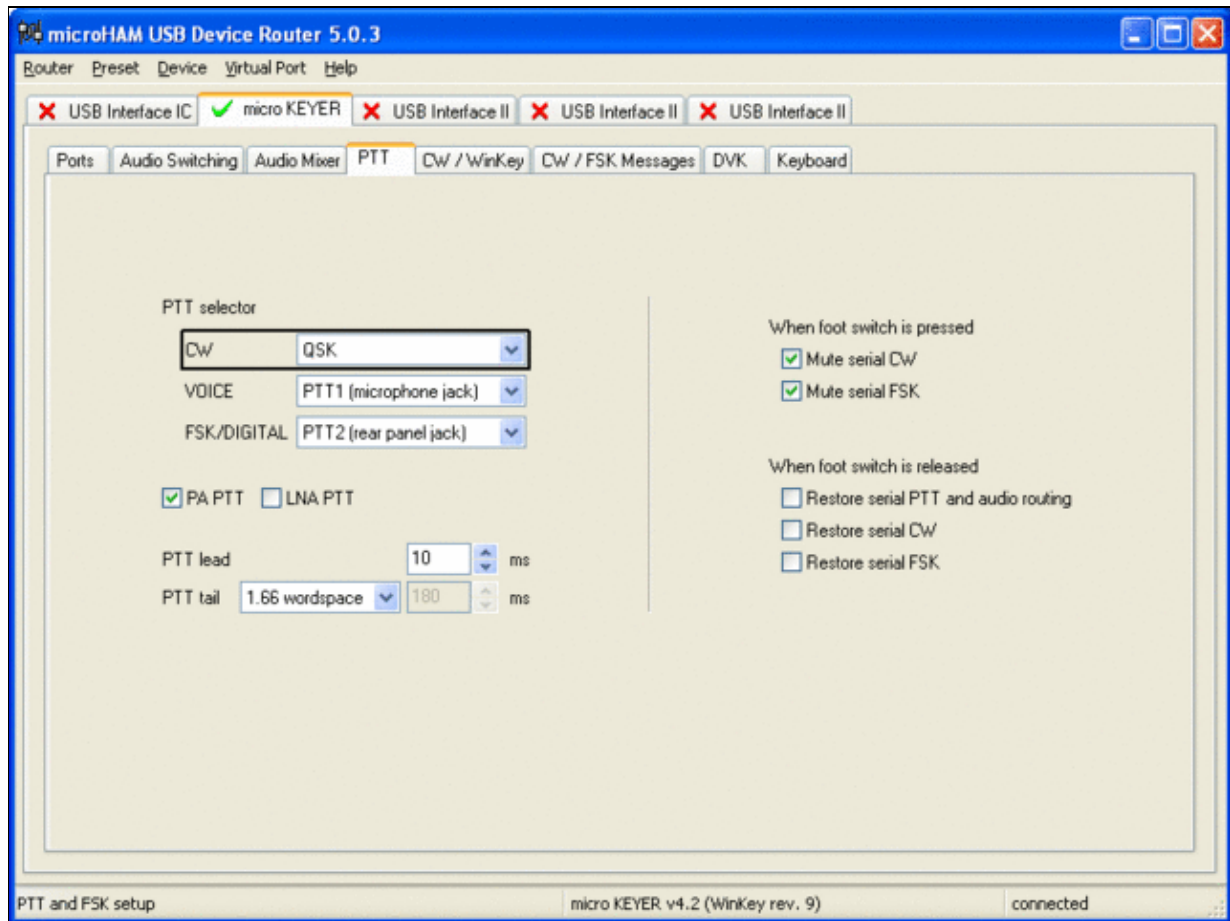

Different PTT settings depending on mode

- Go to the CW/WinKey Tab
  - ◆ My preferred settings are Paddle Mode: Iambic A (Curtis), disable Paddle memory (actually, Dot-Dash-Memory off)

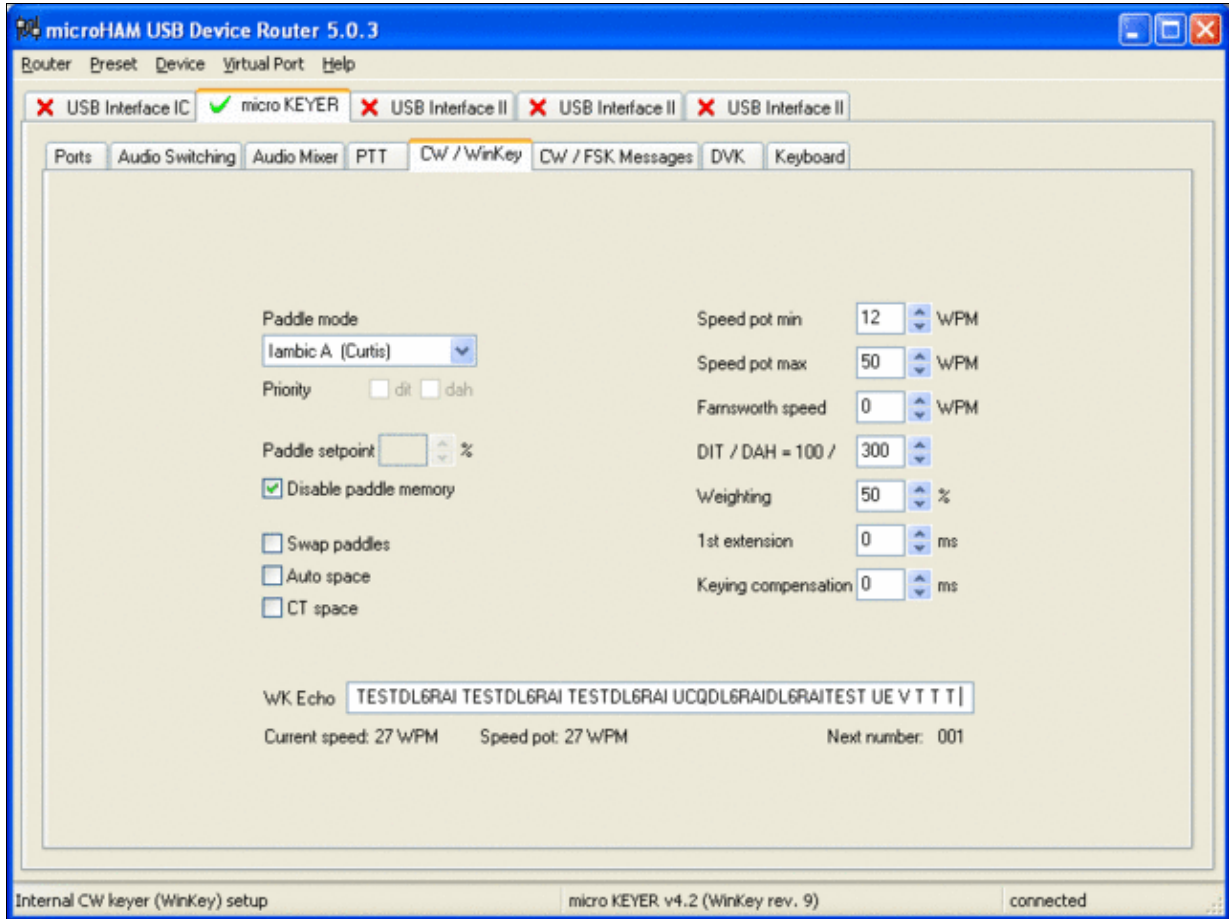

WinKey settings - this is very much depending on your personal preferences

- Testing
  - ◆ Go to a CW frequency, switch the radio to CW and press the VOX button on the radio (you may even wish to additionally select the FULL button just right to the VOX button on the TS-850 to have full QSK)
  - ◆ Touch the paddle - the radio should switch to transmit without any relay clicking in the microKeyer
  - ◆ The CW/FSK LED on the microKeyer should flicker with a red light
  - ◆ Press the Test button on the Winkey port (COM 7) in the Port Tab. The microKeyer should send **Dah dit dit-dit-dit dah**
  - ◆ Go to a SSB frequency and switch the radio to USB or LSB
  - ◆ Press the microphone's PTT and say something. The PTT1/PTT2 LED on the microKeyer should light up in red color. The radio should go to transmit and produce some output
  - ◆ Go to the DVK tab, push the RECORD button and say something. Then push the PLAY button. The radio should activate the PTT1/PTT2 (red light) and transmit your recorded message.
  - ◆ Press the MON button on the radio and listen to the audio. Some audio level adjustments may be required in the Audio Mixer tab.
  - ◆ Go to a RTTY frequency and switch the radio to FSK
  - ◆ Press the Test button on the FSK port (COM8) in the Port Tab. The radio should switch to transmit, send TEST on RTTY and go back to received
  - ◆ The CW/FSK LED should flicker with a green light and the PTT1/PTT2 LED should turn green, while the radio is on transmit

We are now ready for the next step.

## MMTTY

- Download and Install MMTTY from [here](#).
- Start MMTTY
- Activate the XY Scope by selecting the **View (V)** menu item and tagging **XYScope**

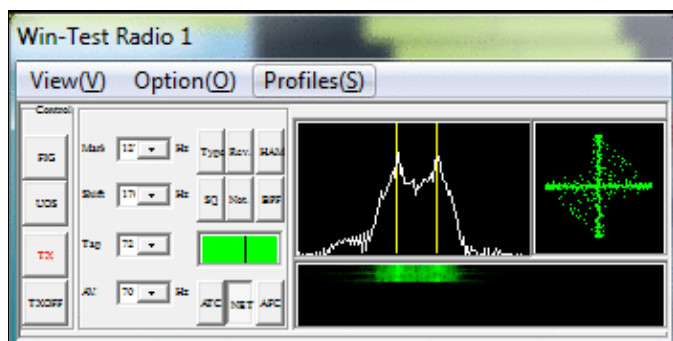



The XY Scope is a practical tuning aid and will help us to visualize the received signals.

- Go to **Option (O) | Setup MMTTY (O) ...**
- Select the Demodulator tab and set it up like in the picture below.



## MMTTY Demodulator settings

- Select the AFC/ATC/PLL tab and make sure AFC is OFF.



MMTTY AFC/ATC/PLL settings. Make sure AFC is off as it will eventually introduce a deviation between TX and RX frequencies.

- Select the TX tab and switch PTT port to COM8. The Radio Command button in this setup screen will allow you to control the radio from within MMTTY. This is not desired in this scenario so make sure it is **not configured** - otherwise Win-Test would not have access to the radio COM port later.

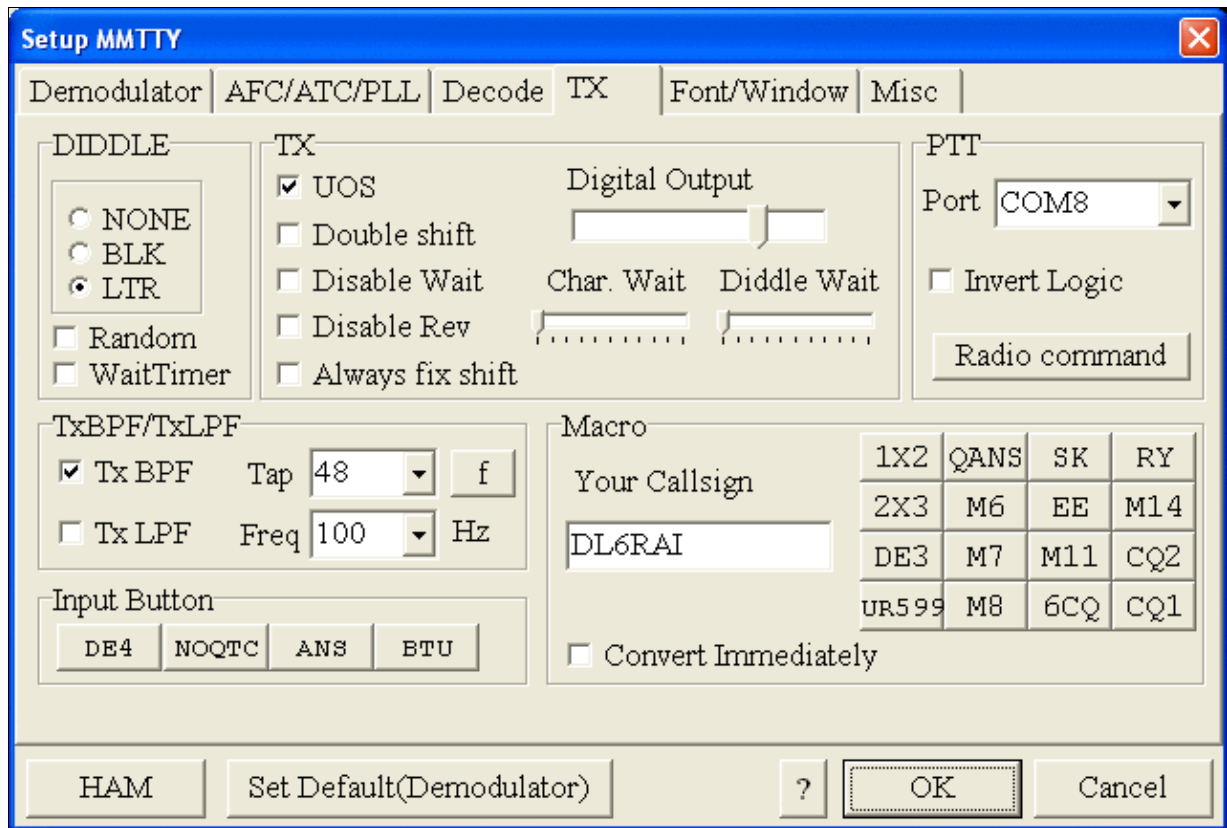

MMTTY Tx settings - PTT is generated by the microKeyer through COM8

- Select the Misc tab and select COM-TxD(FSK).

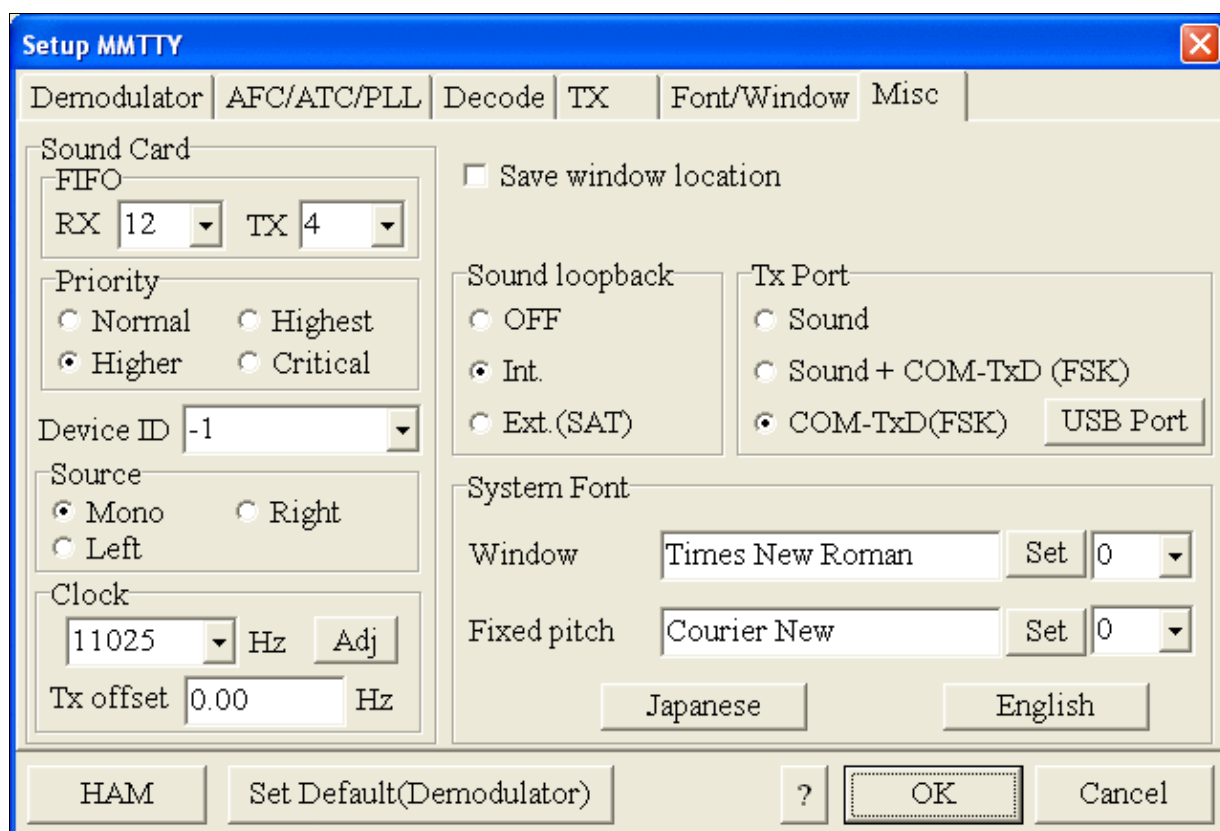

MMTTY Misc settings - FSK is generated via COM8

- If you see problems the FSK signal (especially: keying does work, you hear the RTTY diddle, but chars won't be sent), you might have to limit the USB port speed in MMTTY. This setting depends very much on the computer hardware. To limit the USB port speed click on **USB Port** and configure option "C". You can find this setting also in the support documentation of the Microkeyer on the microHAM website.

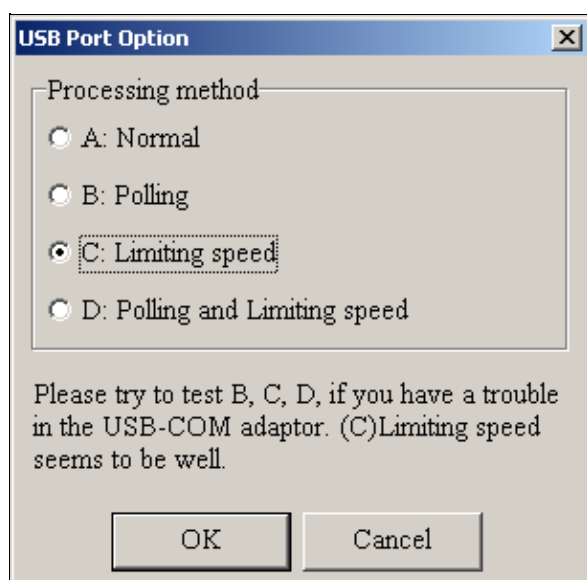

MMTTY USB Port Option - Set only to option C if A does not work for you.

- Exit the Setup screens by pressing the OK button.

We are now ready to do some tests with MMTTY.

- Now take a look at the XY Scope display. It should look like the picture above.
- If you only see a single white point in the middle of the display, this means, that MMTTY gets no audio to process.
  - ◆ Check your cabling. Is your cable connected to Line-in or Mic-in?
- ◆ Check the level setting for your sound card. Open the Sound control (click on the loudspeaker symbol in your task bar), switch to the Recording section and adjust the level for Line-in. When you move the control up and down you should see an increase and decrease in noise level.

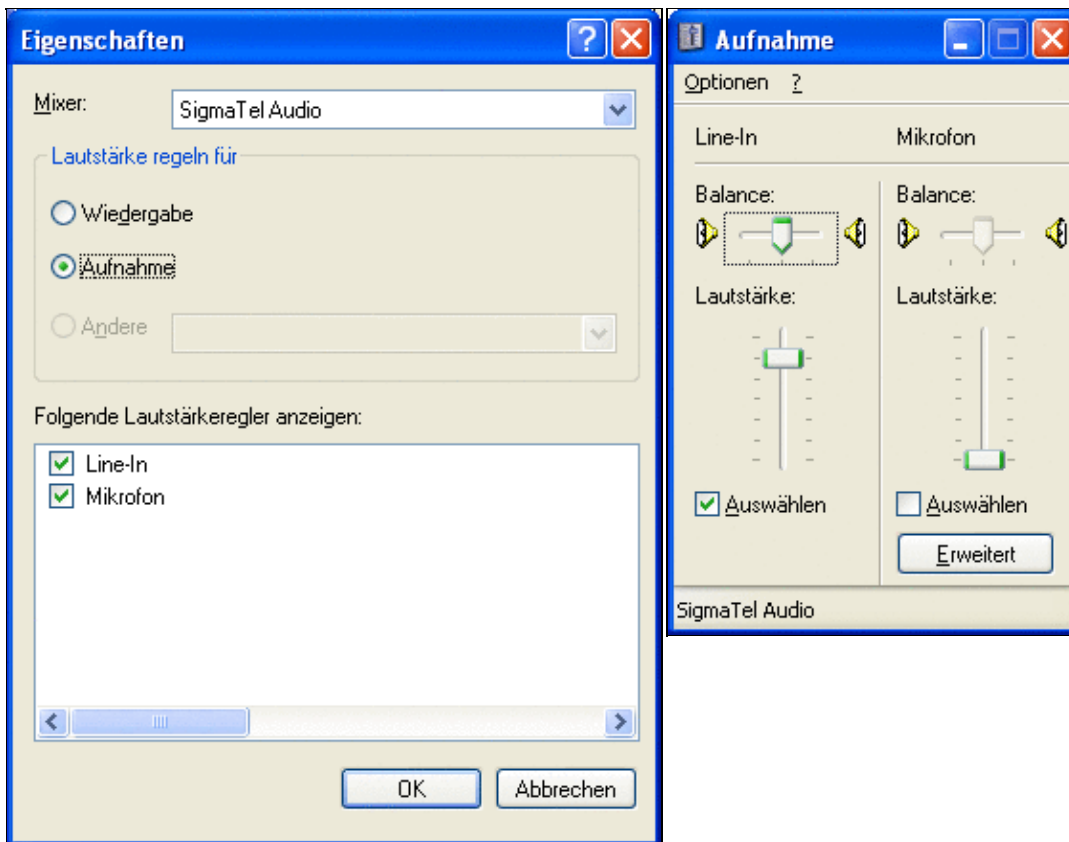

## Win-Test Wiki

Sound card dialog - select Recording here

Sound card dialog - adjust the level of Line-in

- Tune across the CW band and check if the XY scope changes when you hear signals. Once you tune across a carrier or CW signal, you should see a vertical ellipse and then a horizontal ellipse or vice versa depending on which direction you tune. The receive section of the screen will show all kinds of clutter.
- Try to find a RTTY signal (not easy on a normal day). Both ellipses should now be perpendicular to each other. See if you can decode RTTY fine. You may have to select proper filters. I use 500 Hz at 8.8 MHz IF and 2.7 kHz at 455 kHz IF.
- Next, press the TX button in the MMTTY application. You should hear the typical RTTY diddle in the monitor of the radio. The XY Scope will also display a clean RTTY signal.
- Type a few characters (including your callsign) and see how they are transmitted.
- Press the TX button one more time to shut off transmission.
- Exit the MMTTY program now.

MMTTY now works perfectly as a stand-alone program. We are now ready for Win-Test.

## Win-Test

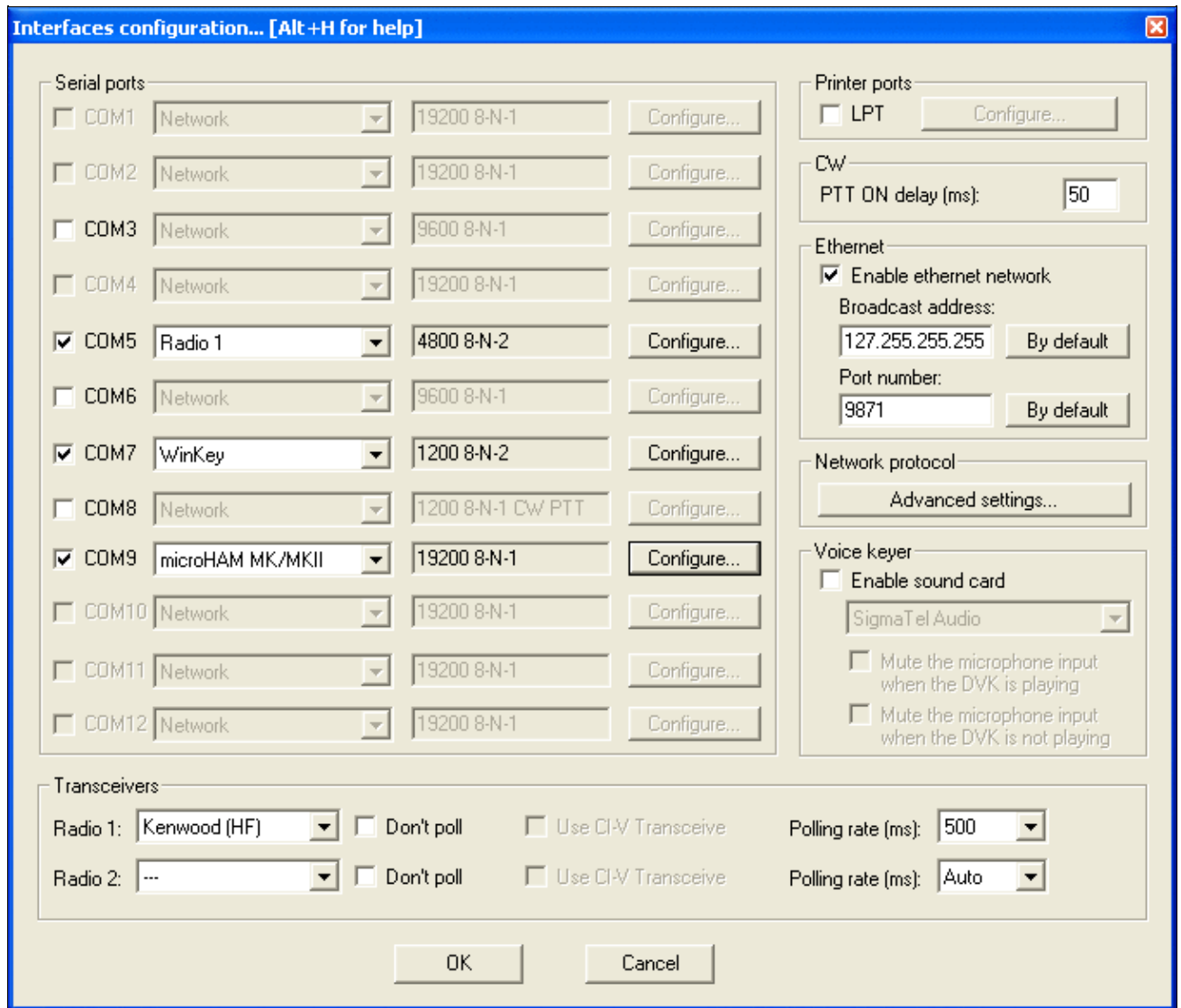

Final steps: Win-Test Interfaces configuration. Note that we only set up three COM ports, no PTT or CW settings are needed as they are all generated/controlled from the microKeyer.

- Start up Win-Test, create a new Win-Test file for testing.
- Select DXpedition and allow All Modes so you can test all three different modes.
- in the **Options | Configure Interfaces...** menu
  - ◆ configure Radio on COM5
  - ◆ configure Winkey on COM7 using default settings
  - ◆ configure microHAM MK/MKII on COM9
  - ◆ untag Win-Test's internal Voice Keyer
- Go to Configure MMTTY.EXE startup path as described in the [RTTY section of this manual](#) if you are planning for RTTY operation

We are now ready to operate the contest.

## Namespaces

- [Page](#)
- [Discussion](#)

## Variants

## Views

- [Read](#)
- [View source](#)
- [View history](#)

## More

- This page was last edited on 19 December 2009, at 18:56.
- [Privacy policy](#)
- [About Win-Test Wiki](#)
- [Disclaimers](#)





# BestPractice5

From Win-Test Wiki

[Jump to navigation](#) [Jump to search](#)

## Contents

- [1 Setting up a Kenwood TS-850S with the microHAM microKeyer II](#)
- [2 Kenwood TS-850 settings](#)
- [3 microHAM MKII](#)
- [4 microHAM USB Device Router](#)
- [5 MMTTY](#)
- [6 Win-Test](#)

## Setting up a Kenwood TS-850S with the microHAM microKeyer II

This article is a step by step approach describing how to set up an Kenwood TS-850S radio and a microHAM microKeyer II interface. The MKII is a complex device integrating a CW-Keyer, CW and FSK keying, PTT control (including a delayed PTT), radio control and a sound card, a digital voice keyer which allows to control up to ten audio memories and different audio switching scenarios. This article covers the set-up of CW, RTTY and SSB in several steps.

[BestPractice1](#) article describes a slightly simpler set-up with the Microham USB Interface II. Please see there for background information about RTTY and MMTTY in general. [BestPractice4](#) article describes a slightly simpler set-up with the microHAM microKeyer. Please see there for background information about RTTY and MMTTY in general.

## Kenwood TS-850 settings

- Press and hold the LSB/USB key while you turn the radio on.
- Select menu item 11 (by turning the the M.CH/VFO.CH knob) and change the setting to ON (by pressing the arrow up/down buttons) if necessary. This will set the polarity of MARK and SPACE signals.
- Select menu item 12 and change the setting to 170 if necessary - this is the typical shift used on the HF bands.
- Select menu item 13 and change the setting to 1275 if necessary. This selects the LOW TONES pair.
- Press the CLR button to leave the setup menu.

To test the settings, put the radio to FSK mode, push the MONI button and then switch the radio to transmit by pressing REC/SEND. You should now hear a 1275 Hz tone. If you short the RTTY jacket on the back of the radio you should hear the tone going up to 1445 Hz.

## microHAM MKII

- Connect the MKII to a 12V DC source.
- Connect a footswitch to the FOOTSW connector of the MKII.
- Connect your microphone or headset to the short RJ45 cable that goes into MIC on the MKII (this connector does also provide the 8V DC voltage on pin 5 for your electret microphone).
- Connect the microHAM MKII to your radio and computer.
  - ◆ On the radio side there will be five connections: CW, RTTY, ACC1, ACC2 and microphone

- ◆ On the computer side there will be only a single connection: USB. I had to use a ferrite core to get rid of RF noise.
- Install the microHAM software if you haven't done so already. There are two steps to it:
  - ◆ Installing the device driver - if you have several microHAM devices you will have to do this once for each of them.
  - ◆ Installing the USB Device Router - this software only needs to be installed once. It is identical on all microHAM products.

**Note:** If you had previously installed the USB Device Router with another microHAM product, it will come up with a new tab for the new hardware connected.

**Note:** The cable stub labeled "13.8 VDC" coming out of the DB37 connector is *not* to be connected to the power source. Rather than that, you will need to prepare a cable that fits into the DC socket on the back of the MKII. In order to avoid ground loops, I had to make a cable that only connects to the plus side.

**Note:** To get rid of noise and RF feedback, I had to change VR18 on the IF board of my TS-850 to the 9 o'clock position. Additionally, I installed a capacitor as described in [\[1\]](#) and [\[2\]](#) Support

### microHAM USB Device Router

- Set up the Device Router
- Go to the Ports Tab
  - ◆ Create three virtual COM ports: COM5, COM7, COM8 and COM9. Note: The absolute port numbers do not matter. The key is consistency - the same port number must be used for a specific function every time it is used.
  - ◆ Configure Radio on COM5
  - ◆ Press the **Set** button to the right of the radio port configuration and select TS-850. MKII will assign different Audio Routing and PTT scenarios if it knows what frequency and mode the radio is set. This is why we have to do it.
  - ◆ You should now see the current frequency of the radio display in the **Ports** tab
  - ◆ Configure Winkey COM7 using Winkey default settings
  - ◆ Configure FSK on COM8. Make sure you tick the PTT tag
  - ◆ Configure Control on COM9. This will allow controlling the MKII, especially the DVK from Win-Test.

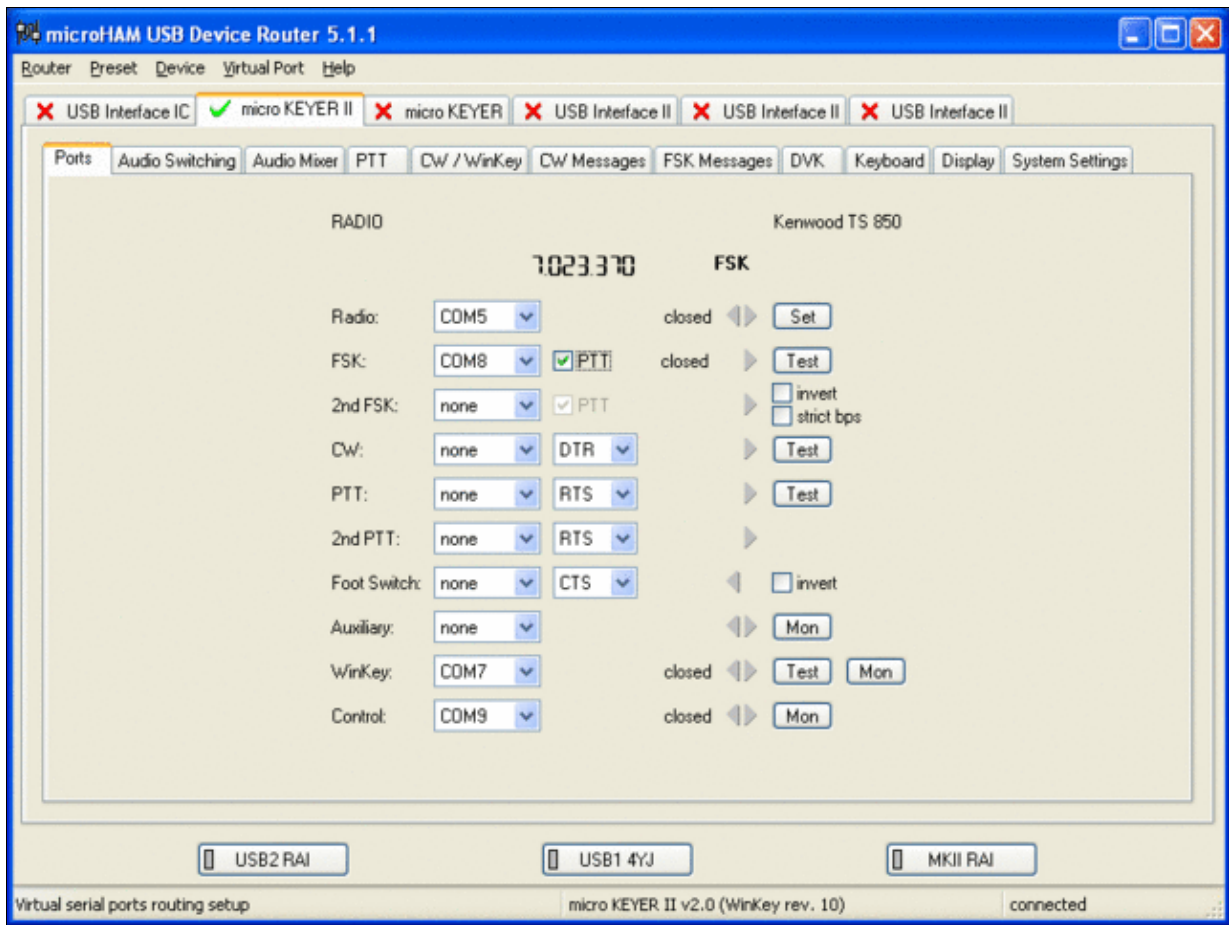

microHAM MKII Ports setup. We use COM5,7,8 and 9 to control different properties of the MKII.

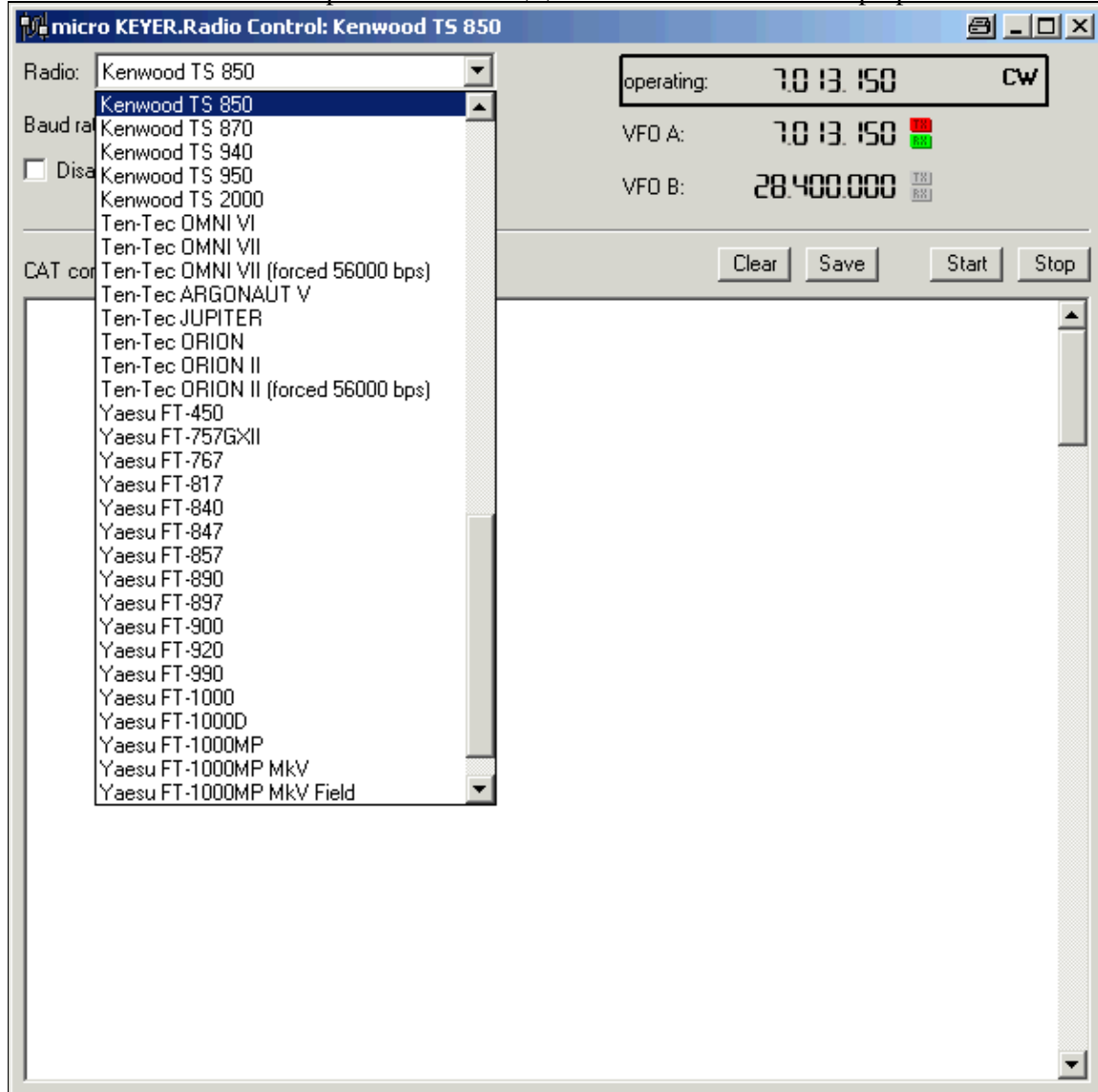

Make sure, the MKII knows about your radio so it can control Audio Switching and PTT depending on the selected mode.

- Go to the Audio Switching Tab
  - ◆ Configure the Audio Switching as shown below.
    - ◇ Have the radio on LSB or USB. Select "Microphone jack, DVK control".
    - ◇ Now switch the radio to FSK mode. Select "line input (rear)".

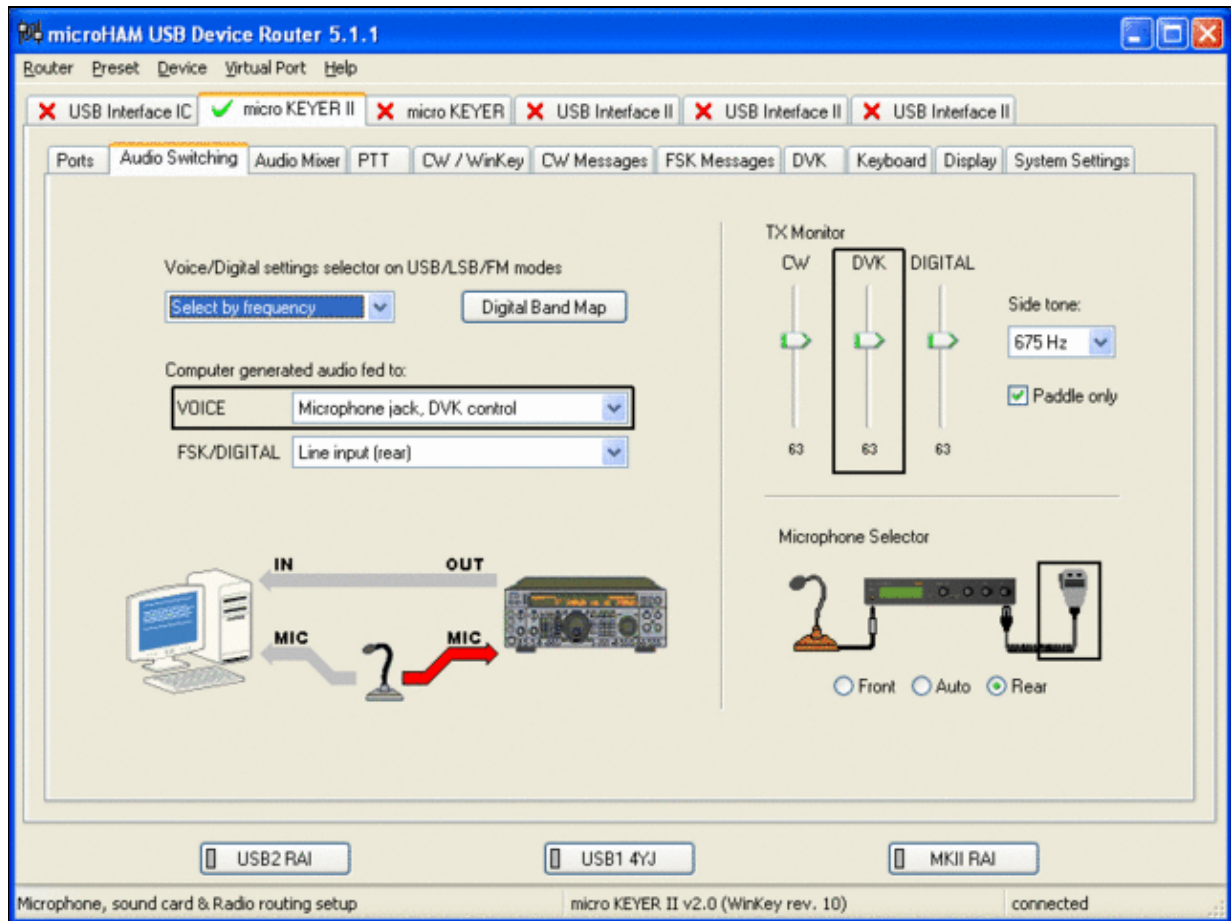

microHAM MKII Audio Switching setup.

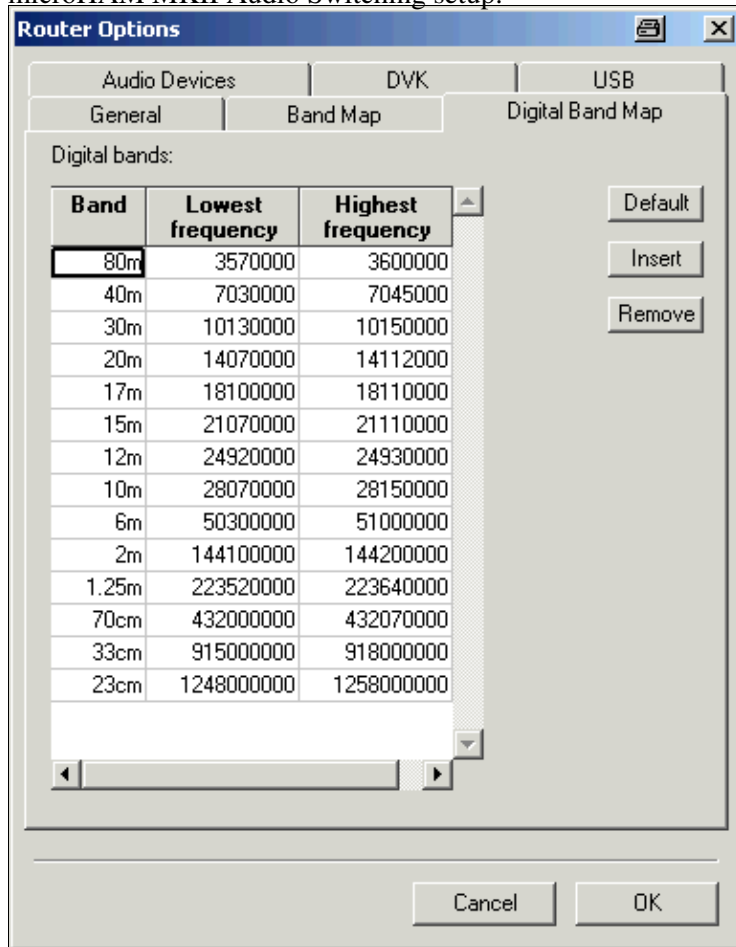

## Win-Test Wiki

This is the digital band map which is used to decide which mode the radio is operating in. With Kenwood radios, MKII retrieves the mode directly from the communication protocol, so this map is not used.

- Go to the Audio Mixing Tab
  - ◆ Select the microHAM CODEC sound device

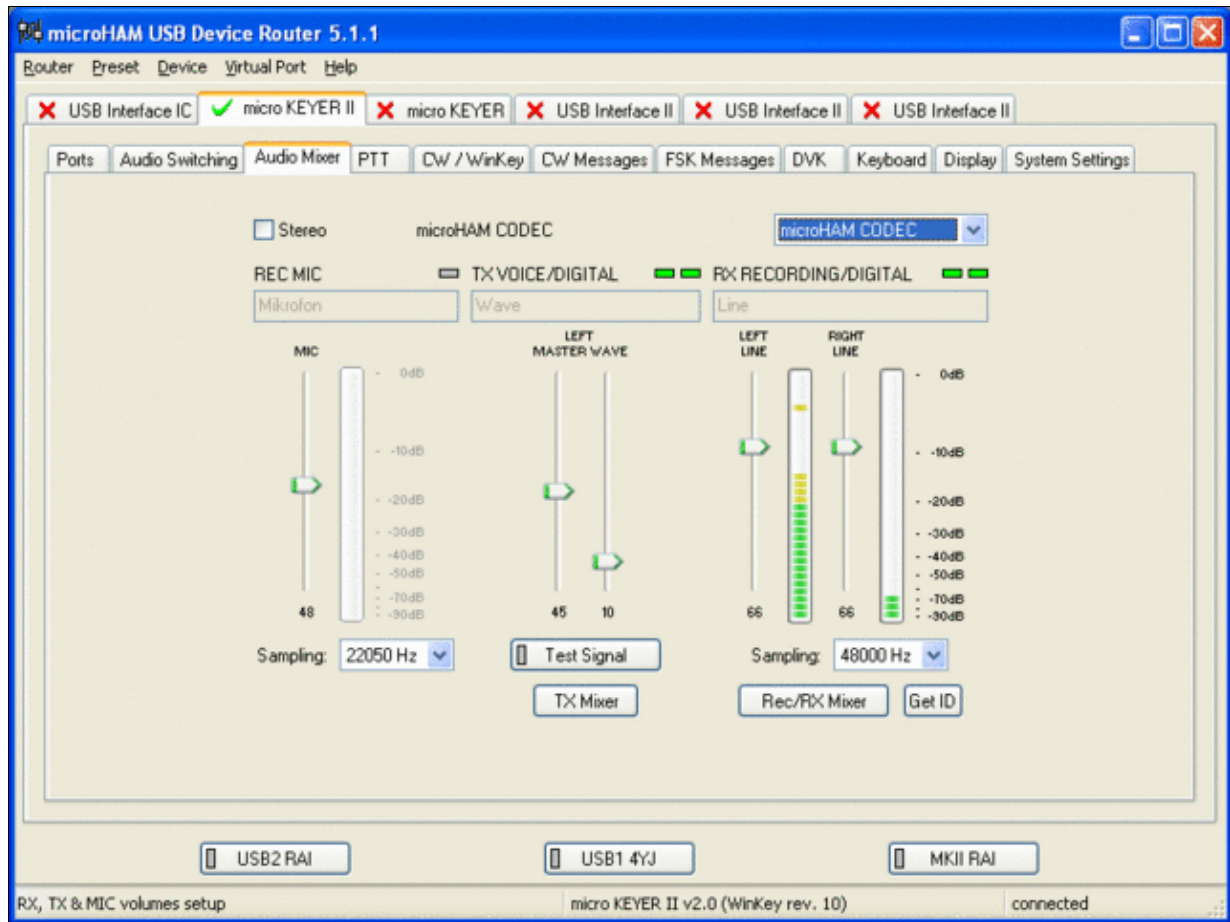

Using the built-in sound card requires selecting it here.

- Go to the PTT Tab
  - ◆ In the PTT selector, select "semi break in" for CW, "PTT1" for Voice and "PTT2" for Digital Modes. This will allow using QSK or VOX operation on CW (which I prefer over the microHAM doing all the switching - but mind hot switching PA relays!). Selecting PTT1 for voice operation will route audio input to the front Mic connector of the radio - avoiding audio level problems.

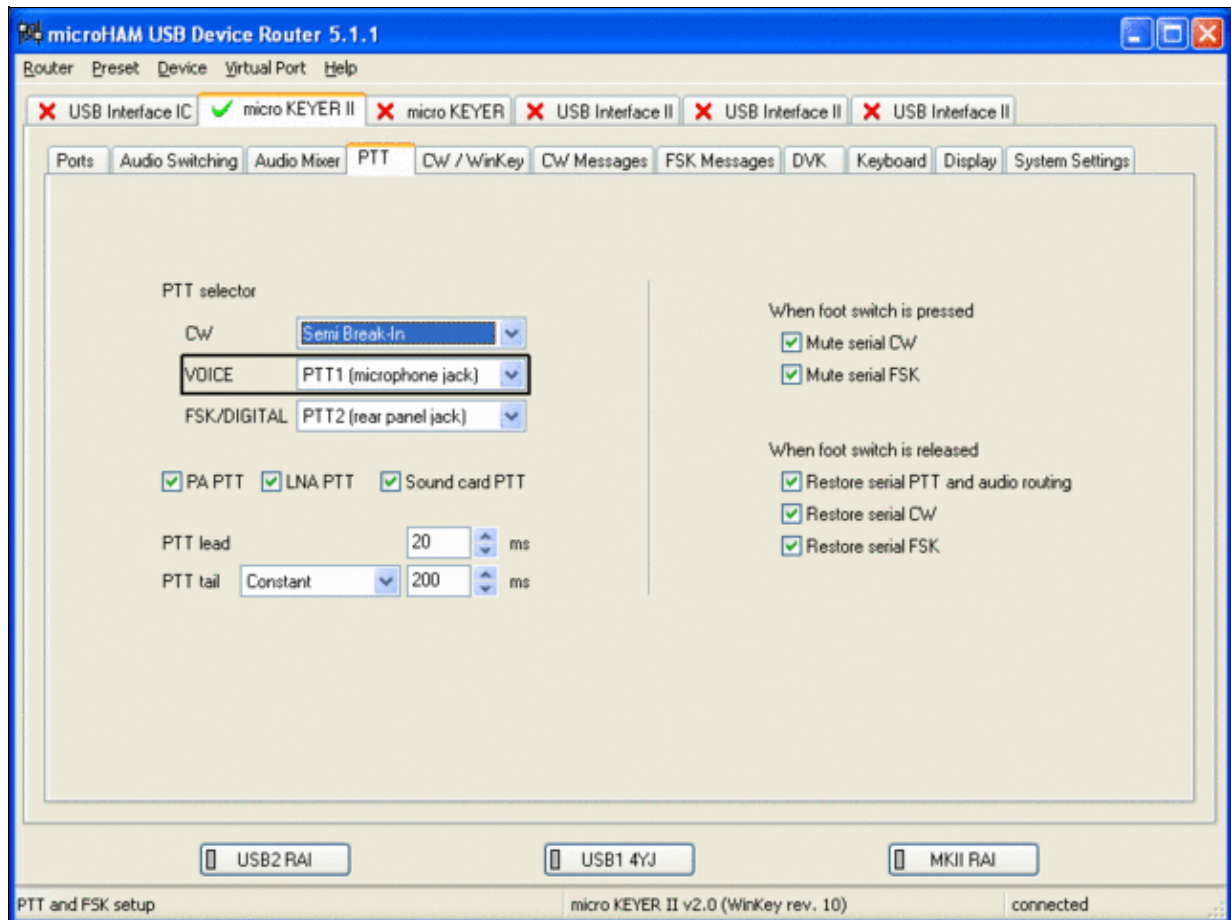



Different PTT settings depending on mode

- Go to the CW/WinKey Tab
  - ◆ My preferred settings are Paddle Mode: Iambic A (Curtis), disable Paddle memory (actually, Dot-Dash-Memory off)

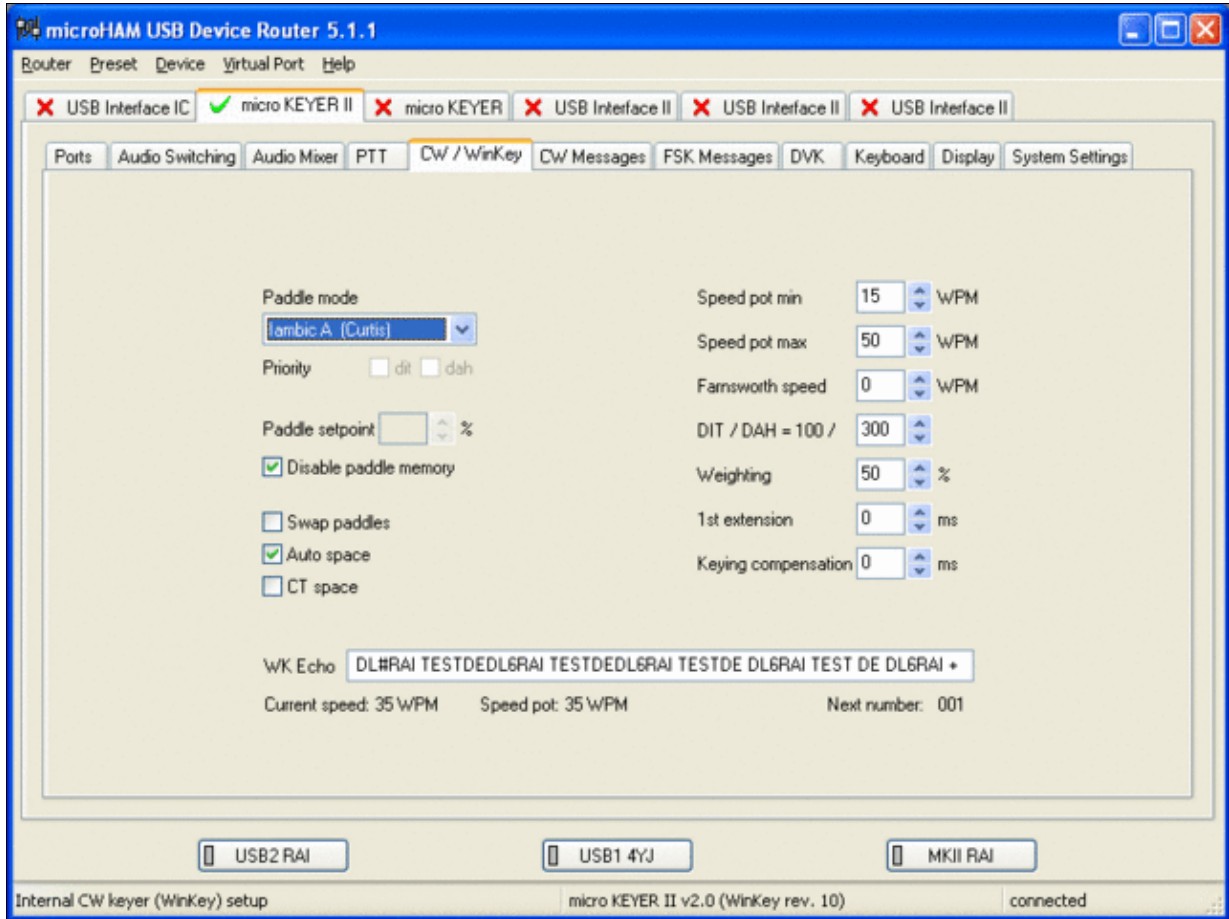

WinKey settings - this is very much depending on your personal preferences

- Testing
  - ◆ Go to a CW frequency, switch the radio to CW and press the VOX button on the radio (you may even wish to additionally select the FULL button just right to the VOX button on the TS-850 to have full QSK)
  - ◆ Touch the paddle - the radio should switch to transmit without any relay clicking inside the MKII.
  - ◆ The CW/FSK LED on the MKII should flicker with a red light.
  - ◆ Press the Test button on the Winkey port (COM 7) in the Port Tab. The MKII should send **Dah dit dit-dit-dit dah**
  - ◆ Go to a SSB frequency and switch the radio to USB or LSB.
  - ◆ Press the microphone's PTT or the foot switch and say something. The PTT1 LED on the MKII should light up in red color. The radio should go to transmit and produce some output.
  - ◆ Go to the DVK tab, push the RECORD button and say something. Then push the PLAY button. The radio should activate the PTT1 (red light) and transmit your recorded message.
  - ◆ Press the MON button on the radio and listen to the audio. Some audio level adjustments may be required in the Audio Mixer tab.
  - ◆ Go to a RTTY frequency and switch the radio to FSK.
  - ◆ Press the Test button on the FSK port (COM8) in the Port Tab. The radio should switch to transmit, send TEST on RTTY and go back to received.
  - ◆ The CW/FSK LED should flicker with a green light and the PTT2 LED should turn green, while the radio is on transmit.

We are now ready for the next step.

## MMTTY

- Download and Install MMTTY from [here](#).
- Start MMTTY
- Activate the XY Scope by selecting the **View(V)** menu item and tagging **XYScope**

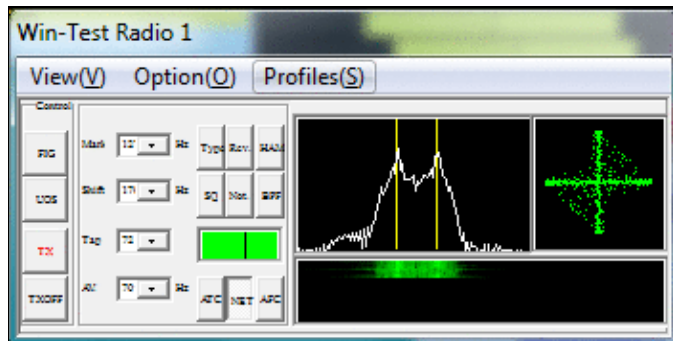

The XY Scope is a practical tuning aid and will help us to visualize the received signals.

- Go to **Option (O) | Setup MMTTY (O) ...**
- Select the Demodulator tab and set it up like in the picture below.



## MMTTY Demodulator settings

- Select the AFC/ATC/PLL tab and make sure AFC is OFF.



MMTTY AFC/ATC/PLL settings. Make sure AFC is off as it will eventually introduce a deviation between TX and RX frequencies.

- Select the TX tab and switch PTT port to COM8. The Radio Command button in this setup screen will allow you to control the radio from within MMTTY. This is not desired in this scenario so make sure it is **not configured** - otherwise Win-Test would not have access to the radio COM port later.

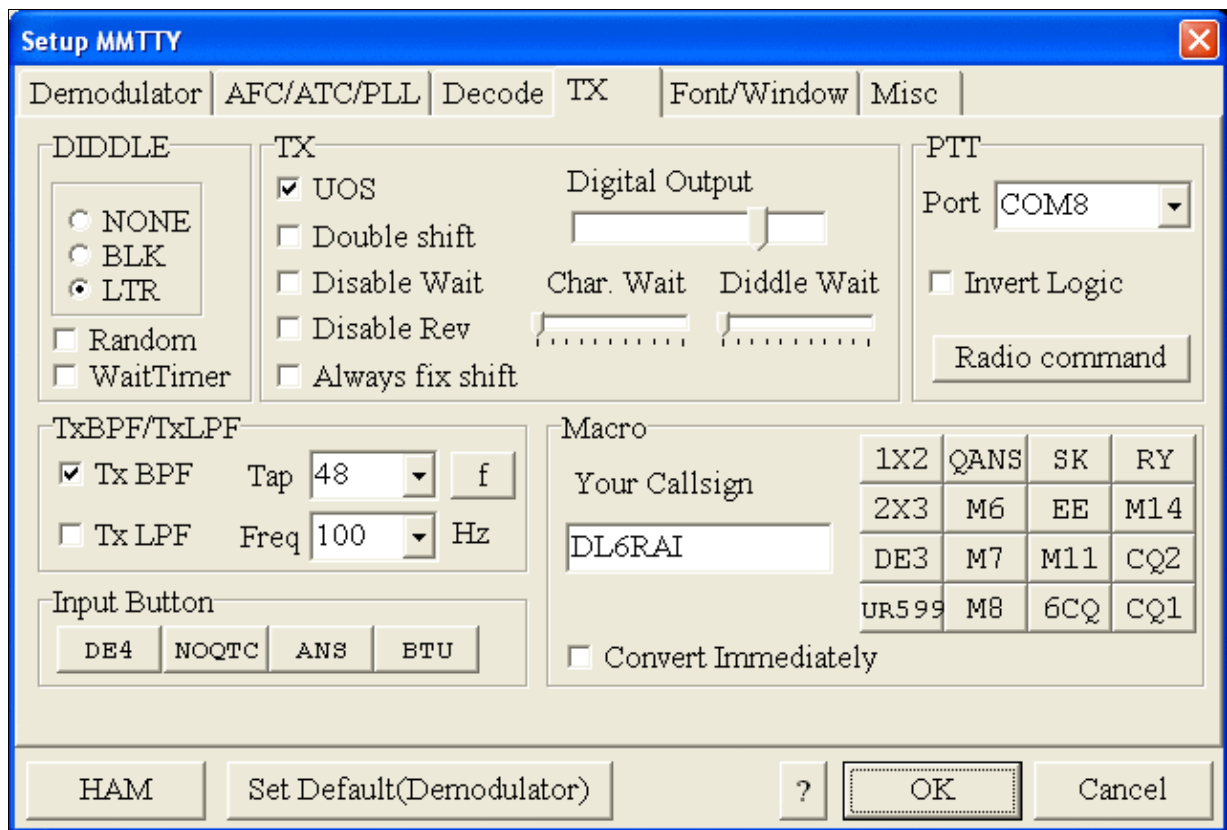

MMTTY Tx settings - PTT is generated by the MKII through COM8

- Select the Misc tab. Since we now have two sound cards - one in the computer, one built into the MKII called microHAM CODEC - we must make sure we're listening on the latter. Switch to the USB router's Audio Mixer Tab and get the device ID by clicking on the button "Get ID" in the lower right corner. This ID must be entered into MMTTY's Device ID field. When listening on the correct device, the LINE LED on the MKII should be lit.
- Also from the Misc tab, select COM-TxD(FSK).

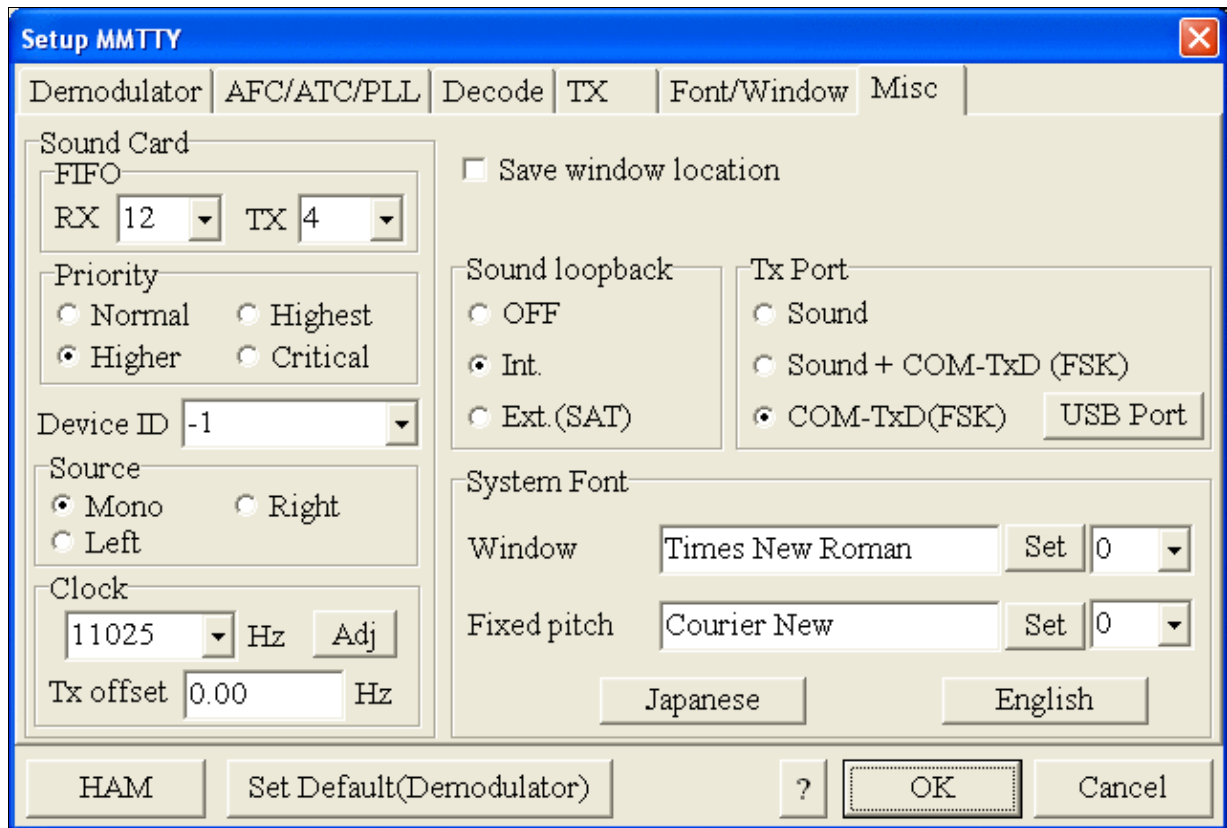

MMTTY Misc settings - FSK is generated via COM8

- Should you have problems generating the FSK signal (especially: keying does work, you hear the RTTY diddle, but no characters are being transmitted), you might have to limit the USB port speed in MMTTY. This setting depends very much on the computer hardware. To limit the USB port speed click on **USB Port** and configure option "C". You can find this setting also in the support documentation of the Microkeyer on the microHAM website.

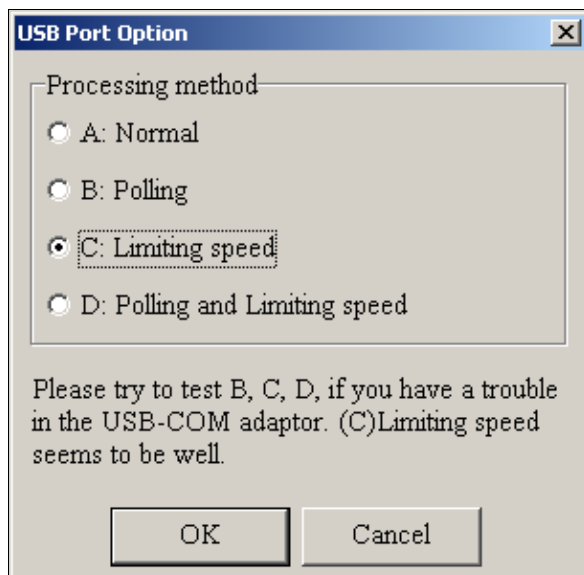

MMTTY USB Port Option - Set only to option C if A does not work for you.

- Exit the Setup screens by pressing the OK button.

We are now ready to do some tests with MMTTY.

- Now take a look at the XY Scope display. It should look like the picture above.
- If you only see a single white point in the middle of the display, this means, that MMTTY gets no audio to process.
  - ◆ Check your cabling. Is your cable connected to Line-in or Mic-in?
  - ◆ Did you select the correct audio device?
  - ◆ Check the level settings for the sound card from the USB Router's Audio Mixer tab. When you move the control up and down you should see an increase and decrease in noise level.

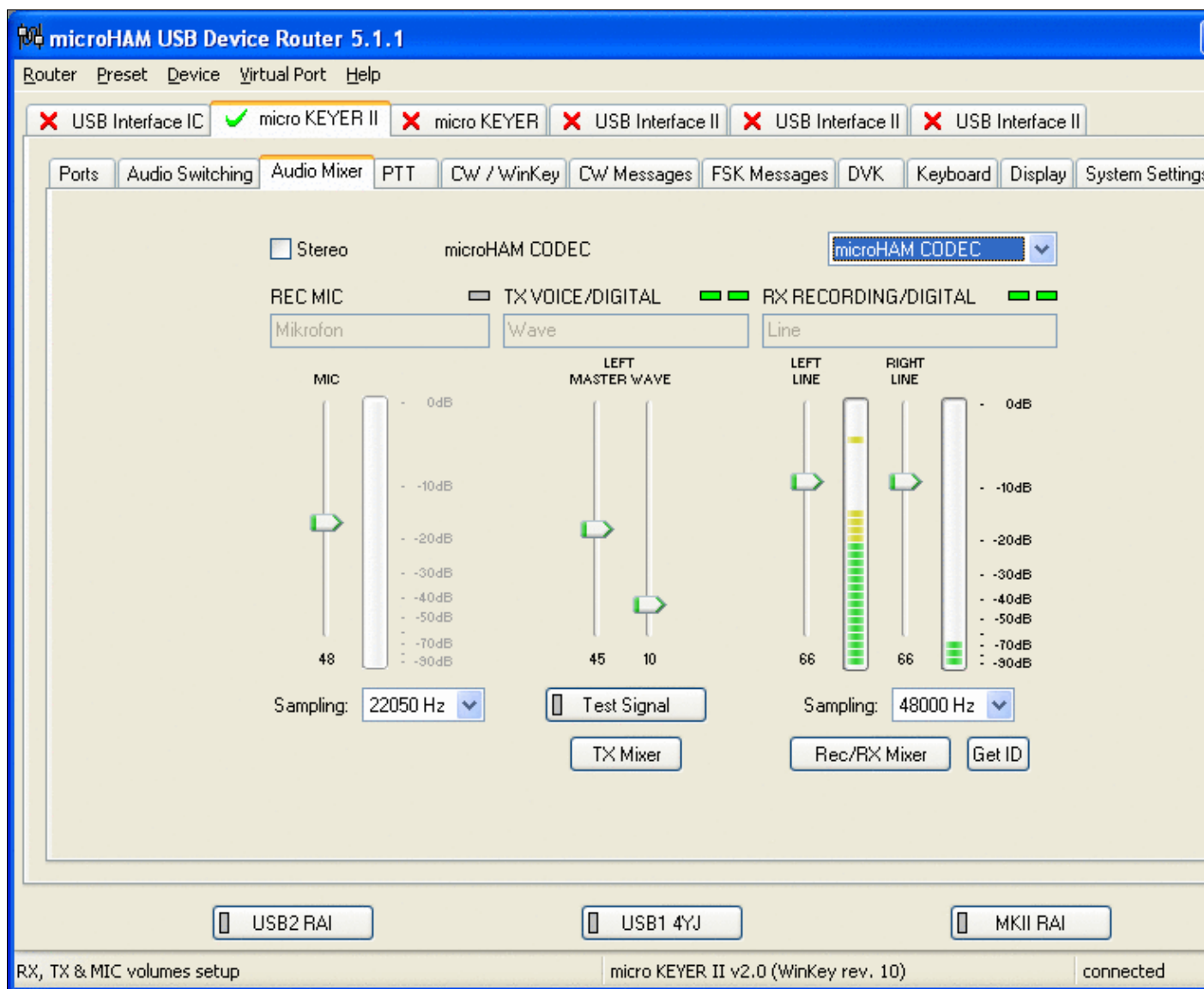

## Win-Test Wiki

Setting the correct audio level on the microHAM CODEC sound card

- Tune across the CW band and check if the XY scope changes when you hear signals. Once you tune across a carrier or CW signal, you should see a vertical ellipse and then a horizontal ellipse or vice versa depending on which direction you tune. The receive section of the screen will show all kinds of clutter.
- Try to find a RTTY signal (not easy on a normal day). Both ellipses should now be perpendicular to each other. See if you can decode RTTY fine. You may have to select proper filters. I use 500 Hz at 8.8 MHz IF and 2.7 kHz at 455 kHz IF.
- Next, press the TX button in the MMTTY application. You should hear the typical RTTY diddle in the monitor of the radio. The XY Scope will also display a clean RTTY signal.
- Type a few characters (including your callsign) and see how they are transmitted.
- Press the TX button one more time to shut off transmission.
- Exit the MMTTY program now.

MMTTY now works perfectly as a stand-alone program. We are now ready for Win-Test.

## Win-Test



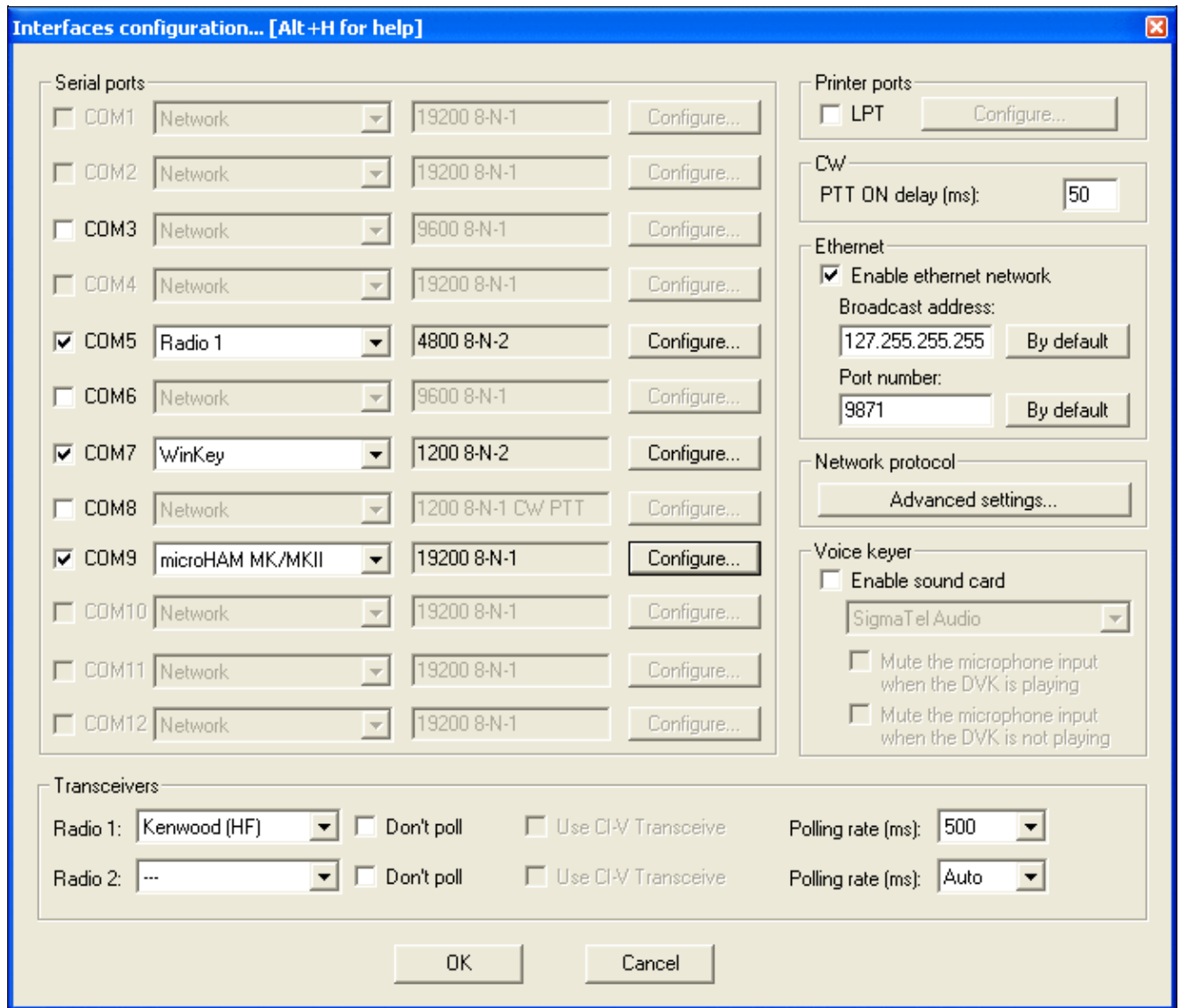

Final steps: Win-Test Interfaces configuration. Note that we only set up three COM ports, no PTT or CW settings are needed as they are all generated/controlled by the MKII.

- Start up Win-Test, create a new Win-Test file for testing.
- Select DXpedition and allow All Modes so you can test all three different modes.
- in the **Options | Configure Interfaces...** menu
  - ◆ configure Radio on COM5
  - ◆ configure Winkey on COM7 using default settings
  - ◆ configure microHAM MK/MKII on COM9
  - ◆ untag Win-Test's internal Voice Keyer
- Go to Configure MMTTY.EXE startup path as described in the [RTTY section of this manual](#) if you are planning for RTTY operation

We are now ready to operate the contest.

## Namespaces

- [Page](#)
- [Discussion](#)

## Variants

## Views

- [Read](#)
- [View source](#)
- [View history](#)

## More

- This page was last edited on 18 April 2015, at 15:32.
- [Privacy policy](#)
- [About Win-Test Wiki](#)
- [Disclaimers](#)



# BestPractice5

From Win-Test Wiki

[Jump to navigation](#) [Jump to search](#)

## Contents

- [1 Setting up a Kenwood TS-850S with the microHAM microKeyer II](#)
- [2 Kenwood TS-850 settings](#)
- [3 microHAM MKII](#)
- [4 microHAM USB Device Router](#)
- [5 MMTTY](#)
- [6 Win-Test](#)

## Setting up a Kenwood TS-850S with the microHAM microKeyer II

This article is a step by step approach describing how to set up an Kenwood TS-850S radio and a microHAM microKeyer II interface. The MKII is a complex device integrating a CW-Keyer, CW and FSK keying, PTT control (including a delayed PTT), radio control and a sound card, a digital voice keyer which allows to control up to ten audio memories and different audio switching scenarios. This article covers the set-up of CW, RTTY and SSB in several steps.

[BestPractice1](#) article describes a slightly simpler set-up with the Microham USB Interface II. Please see there for background information about RTTY and MMTTY in general. [BestPractice4](#) article describes a slightly simpler set-up with the microHAM microKeyer. Please see there for background information about RTTY and MMTTY in general.

## Kenwood TS-850 settings

- Press and hold the LSB/USB key while you turn the radio on.
- Select menu item 11 (by turning the the M.CH/VFO.CH knob) and change the setting to ON (by pressing the arrow up/down buttons) if necessary. This will set the polarity of MARK and SPACE signals.
- Select menu item 12 and change the setting to 170 if necessary - this is the typical shift used on the HF bands.
- Select menu item 13 and change the setting to 1275 if necessary. This selects the LOW TONES pair.
- Press the CLR button to leave the setup menu.

To test the settings, put the radio to FSK mode, push the MONI button and then switch the radio to transmit by pressing REC/SEND. You should now hear a 1275 Hz tone. If you short the RTTY jacket on the back of the radio you should hear the tone going up to 1445 Hz.

## microHAM MKII

- Connect the MKII to a 12V DC source.
- Connect a footswitch to the FOOTSW connector of the MKII.
- Connect your microphone or headset to the short RJ45 cable that goes into MIC on the MKII (this connector does also provide the 8V DC voltage on pin 5 for your electret microphone).
- Connect the microHAM MKII to your radio and computer.
  - ◆ On the radio side there will be five connections: CW, RTTY, ACC1, ACC2 and microphone

- ◆ On the computer side there will be only a single connection: USB. I had to use a ferrite core to get rid of RF noise.
- Install the microHAM software if you haven't done so already. There are two steps to it:
  - ◆ Installing the device driver - if you have several microHAM devices you will have to do this once for each of them.
  - ◆ Installing the USB Device Router - this software only needs to be installed once. It is identical on all microHAM products.

**Note:** If you had previously installed the USB Device Router with another microHAM product, it will come up with a new tab for the new hardware connected.

**Note:** The cable stub labeled "13.8 VDC" coming out of the DB37 connector is *not* to be connected to the power source. Rather than that, you will need to prepare a cable that fits into the DC socket on the back of the MKII. In order to avoid ground loops, I had to make a cable that only connects to the plus side.

**Note:** To get rid of noise and RF feedback, I had to change VR18 on the IF board of my TS-850 to the 9 o'clock position. Additionally, I installed a capacitor as described in [\[1\]](#) and [\[2\]](#) Support

### microHAM USB Device Router

- Set up the Device Router
- Go to the Ports Tab
  - ◆ Create three virtual COM ports: COM5, COM7, COM8 and COM9. Note: The absolute port numbers do not matter. The key is consistency - the same port number must be used for a specific function every time it is used.
  - ◆ Configure Radio on COM5
  - ◆ Press the **Set** button to the right of the radio port configuration and select TS-850. MKII will assign different Audio Routing and PTT scenarios if it knows what frequency and mode the radio is set. This is why we have to do it.
  - ◆ You should now see the current frequency of the radio display in the **Ports** tab
  - ◆ Configure Winkey COM7 using Winkey default settings
  - ◆ Configure FSK on COM8. Make sure you tick the PTT tag
  - ◆ Configure Control on COM9. This will allow controlling the MKII, especially the DVK from Win-Test.

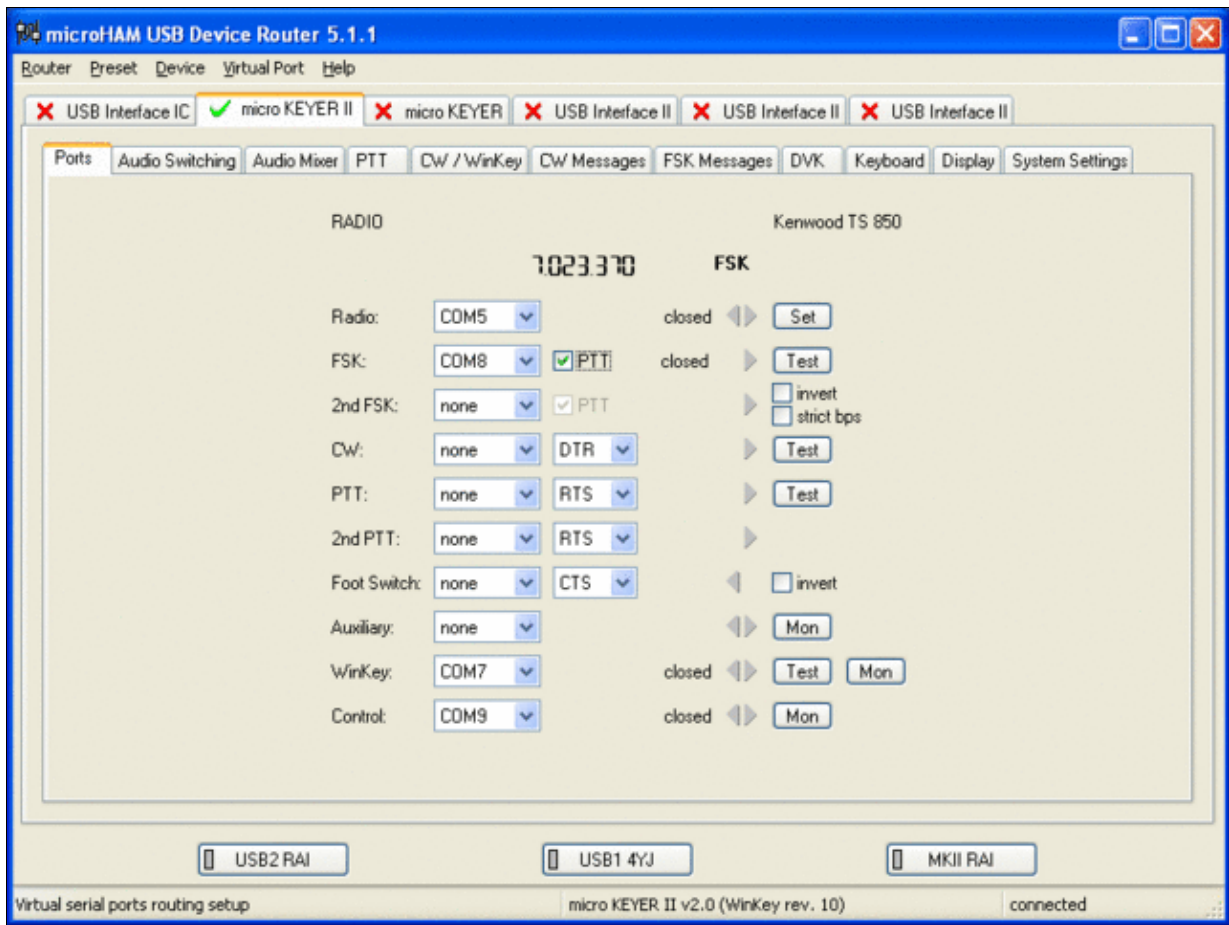

microHAM MKII Ports setup. We use COM5,7,8 and 9 to control different properties of the MKII.

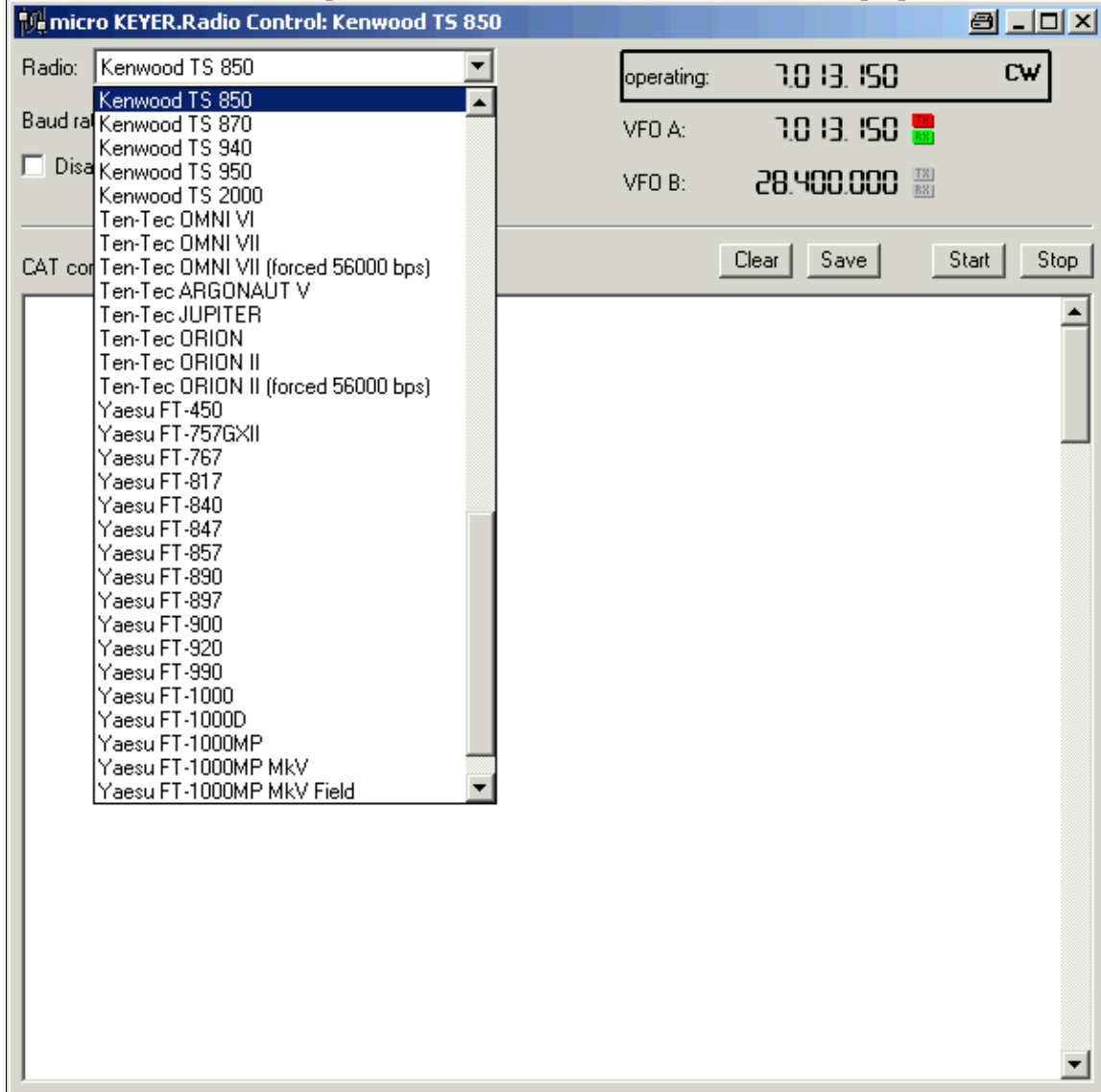

Make sure, the MKII knows about your radio so it can control Audio Switching and PTT depending on the selected mode.

- Go to the Audio Switching Tab
  - ◆ Configure the Audio Switching as shown below.
    - ◇ Have the radio on LSB or USB. Select "Microphone jack, DVK control".
    - ◇ Now switch the radio to FSK mode. Select "line input (rear)".

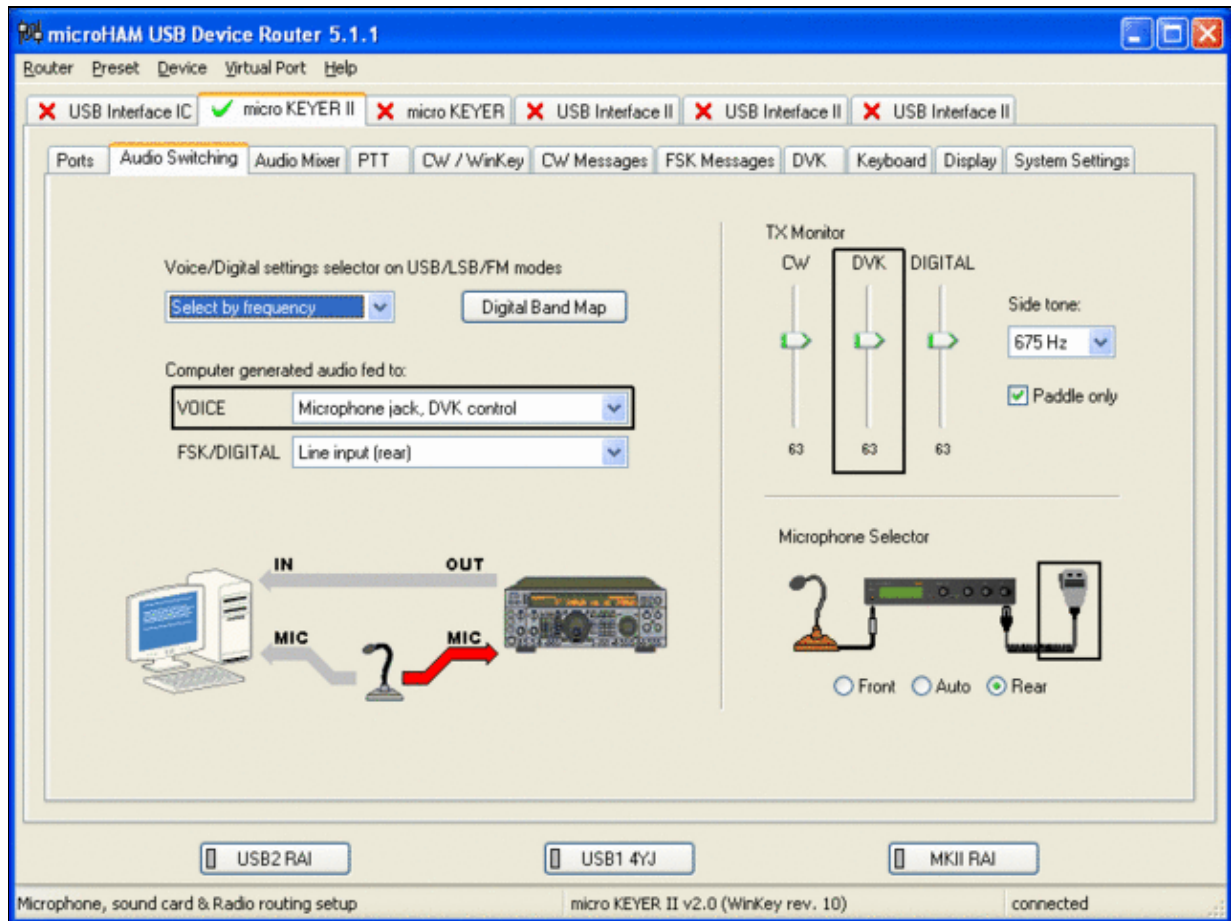

microHAM MKII Audio Switching setup.

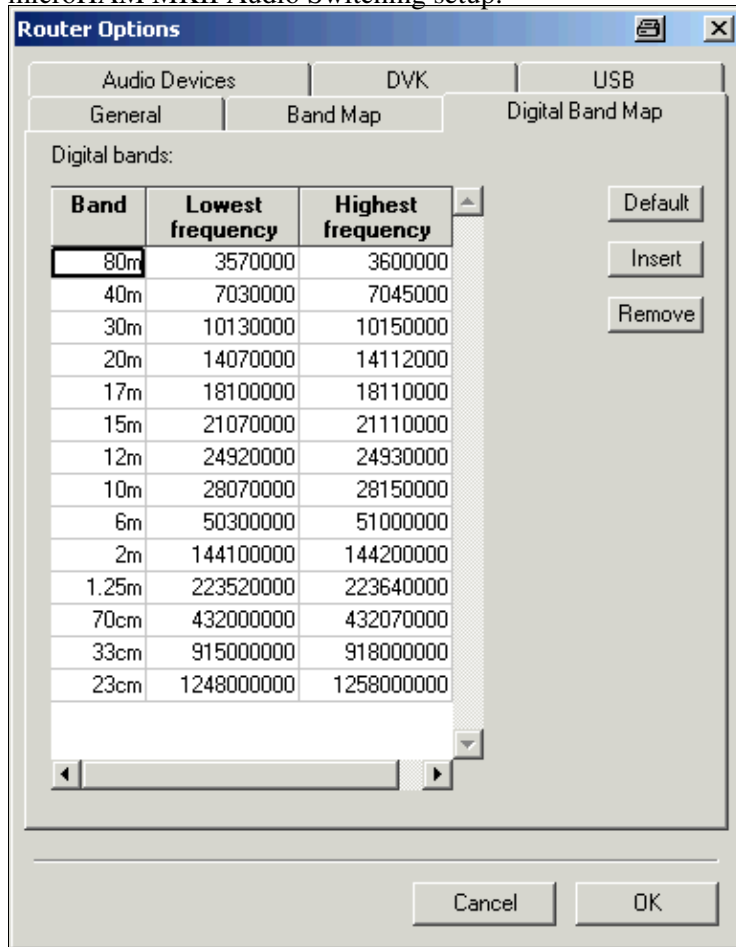



## Win-Test Wiki

This is the digital band map which is used to decide which mode the radio is operating in. With Kenwood radios, MKII retrieves the mode directly from the communication protocol, so this map is not used.

- Go to the Audio Mixing Tab
  - ◆ Select the microHAM CODEC sound device

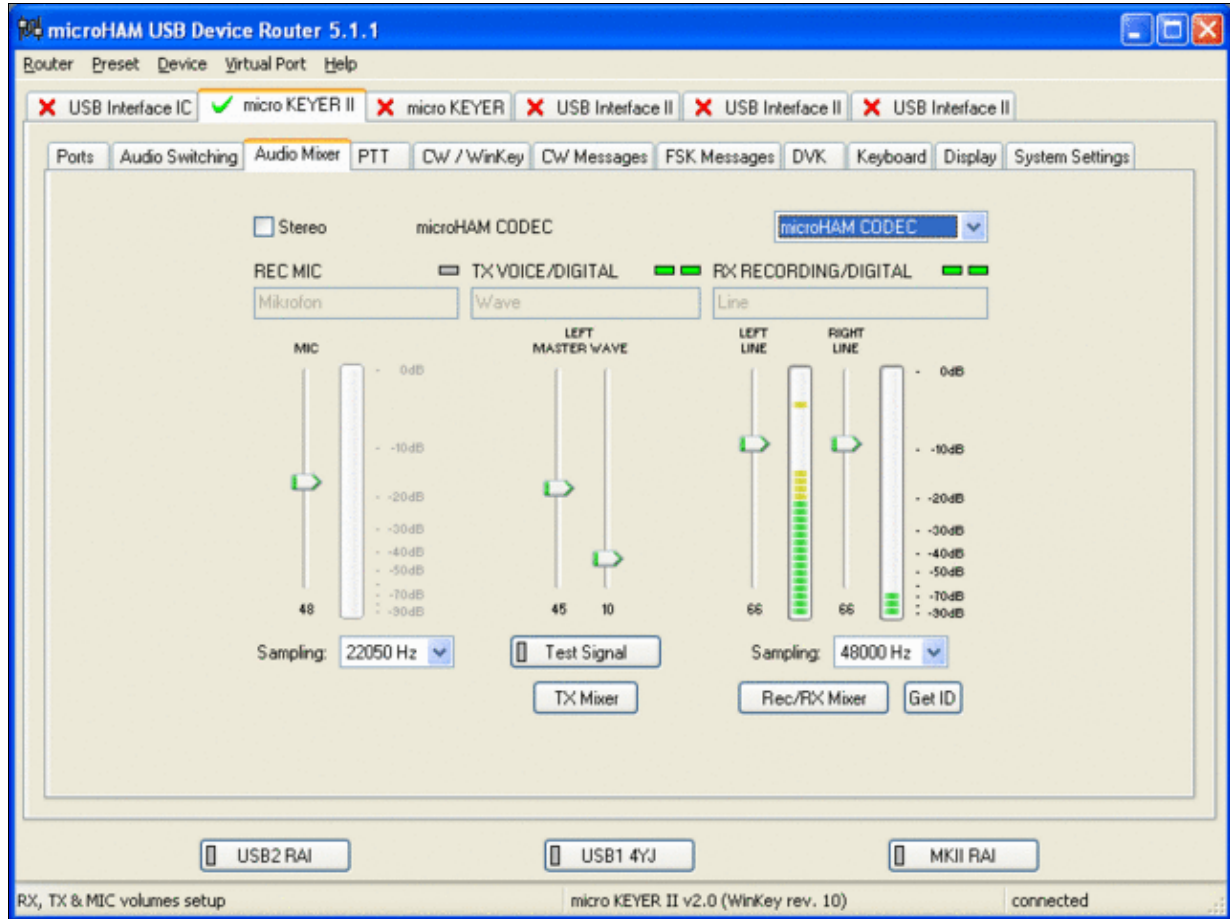

Using the built-in sound card requires selecting it here.

- Go to the PTT Tab
  - ◆ In the PTT selector, select "semi break in" for CW, "PTT1" for Voice and "PTT2" for Digital Modes. This will allow using QSK or VOX operation on CW (which I prefer over the microHAM doing all the switching - but mind hot switching PA relays!). Selecting PTT1 for voice operation will route audio input to the front Mic connector of the radio - avoiding audio level problems.

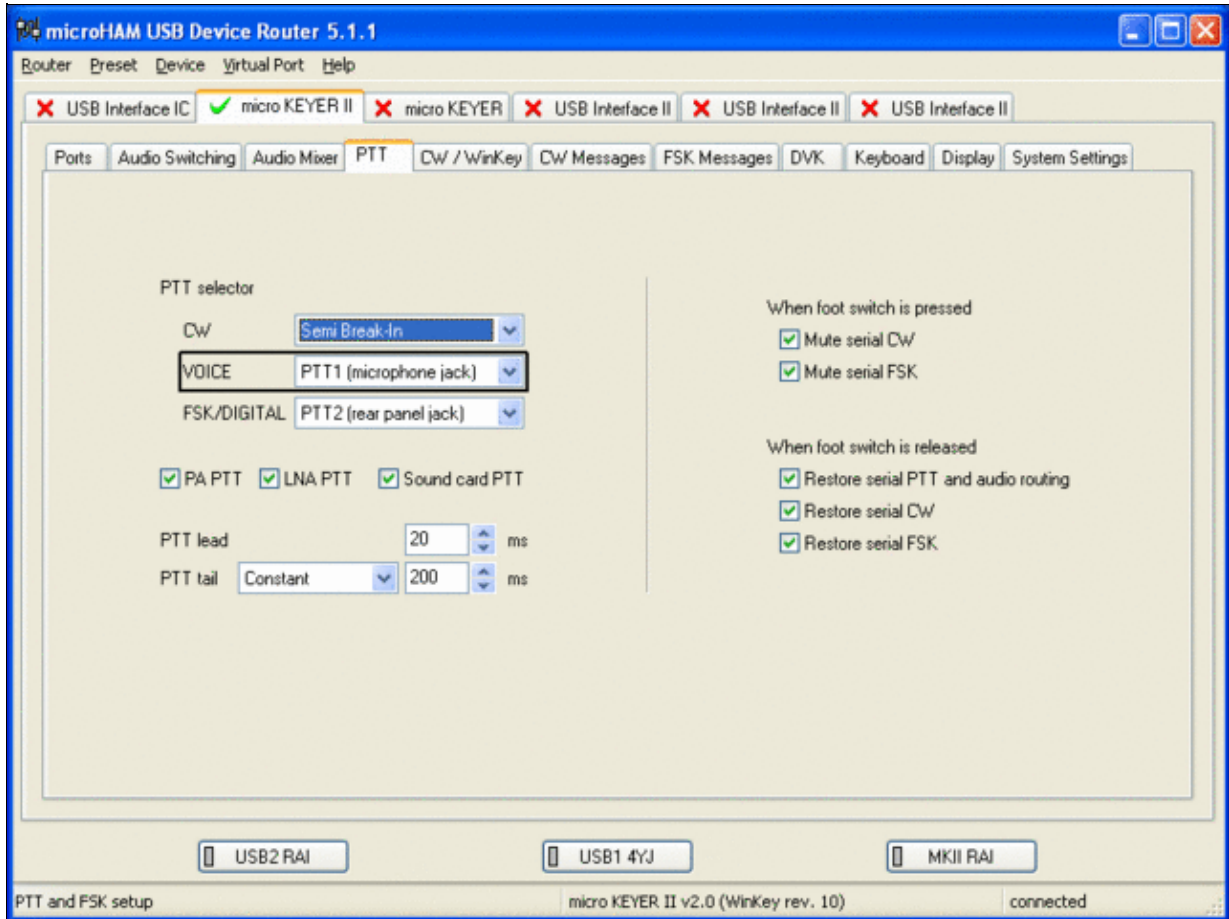

Different PTT settings depending on mode

- Go to the CW/WinKey Tab
  - ◆ My preferred settings are Paddle Mode: Iambic A (Curtis), disable Paddle memory (actually, Dot-Dash-Memory off)

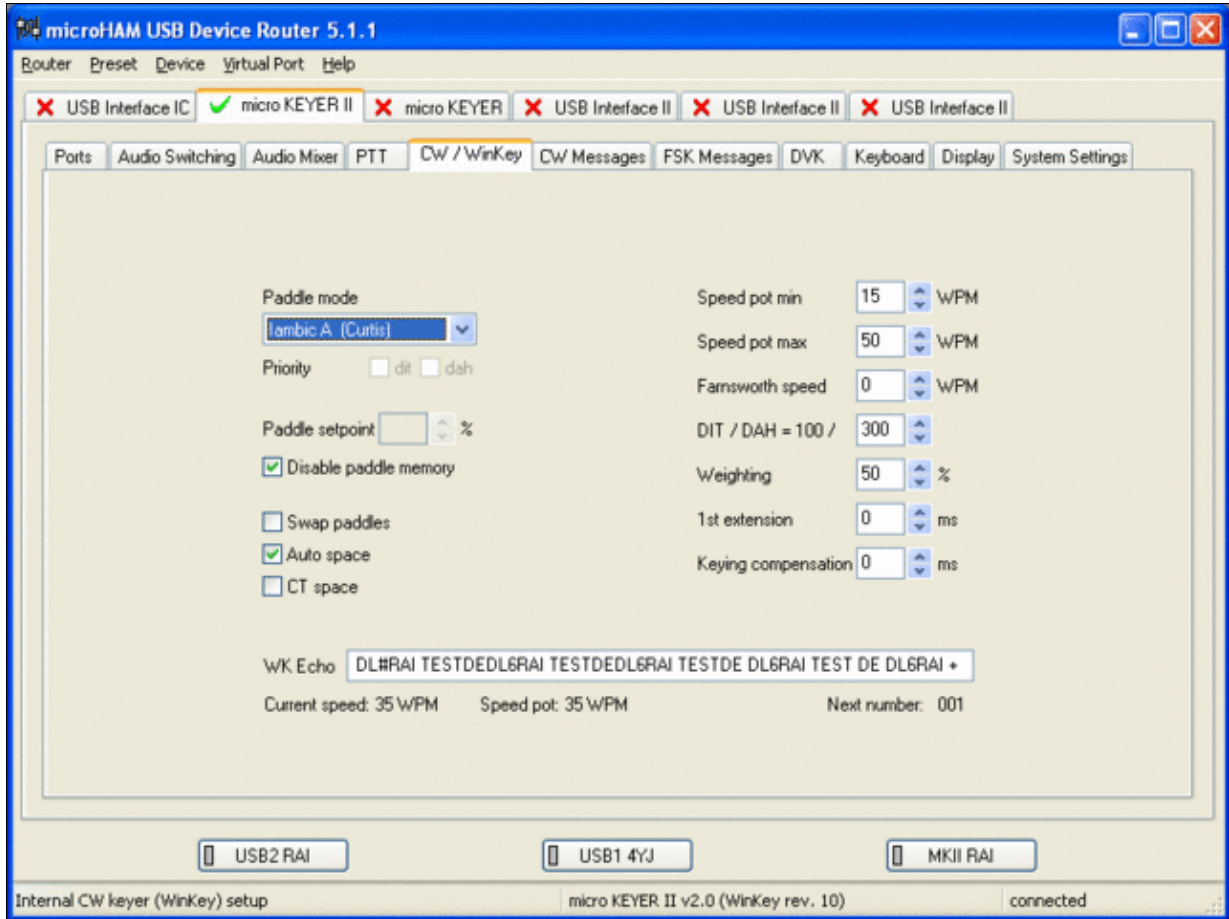

WinKey settings - this is very much depending on your personal preferences

- Testing
  - ◆ Go to a CW frequency, switch the radio to CW and press the VOX button on the radio (you may even wish to additionally select the FULL button just right to the VOX button on the TS-850 to have full QSK)
  - ◆ Touch the paddle - the radio should switch to transmit without any relay clicking inside the MKII.
  - ◆ The CW/FSK LED on the MKII should flicker with a red light.
  - ◆ Press the Test button on the Winkey port (COM 7) in the Port Tab. The MKII should send **Dah dit dit-dit-dit dah**
  - ◆ Go to a SSB frequency and switch the radio to USB or LSB.
  - ◆ Press the microphone's PTT or the foot switch and say something. The PTT1 LED on the MKII should light up in red color. The radio should go to transmit and produce some output.
  - ◆ Go to the DVK tab, push the RECORD button and say something. Then push the PLAY button. The radio should activate the PTT1 (red light) and transmit your recorded message.
  - ◆ Press the MON button on the radio and listen to the audio. Some audio level adjustments may be required in the Audio Mixer tab.
  - ◆ Go to a RTTY frequency and switch the radio to FSK.
  - ◆ Press the Test button on the FSK port (COM8) in the Port Tab. The radio should switch to transmit, send TEST on RTTY and go back to received.
  - ◆ The CW/FSK LED should flicker with a green light and the PTT2 LED should turn green, while the radio is on transmit.

We are now ready for the next step.

## MMTTY

- Download and Install MMTTY from [here](#).
- Start MMTTY
- Activate the XY Scope by selecting the **View(V)** menu item and tagging **XYScope**

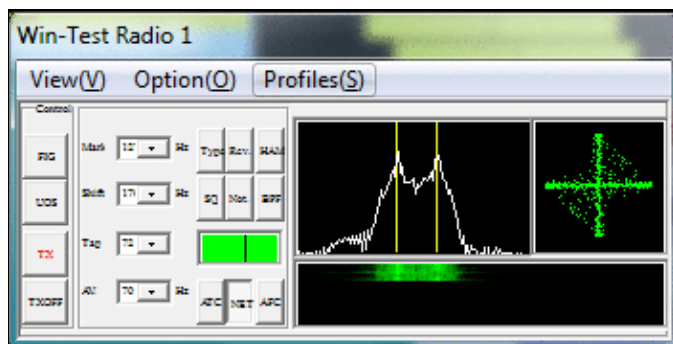

The XY Scope is a practical tuning aid and will help us to visualize the received signals.

- Go to **Option (O) | Setup MMTTY (O) ...**
- Select the Demodulator tab and set it up like in the picture below.



## MMTTY Demodulator settings

- Select the AFC/ATC/PLL tab and make sure AFC is OFF.



MMTTY AFC/ATC/PLL settings. Make sure AFC is off as it will eventually introduce a deviation between TX and RX frequencies.

- Select the TX tab and switch PTT port to COM8. The Radio Command button in this setup screen will allow you to control the radio from within MMTTY. This is not desired in this scenario so make sure it is **not configured** - otherwise Win-Test would not have access to the radio COM port later.

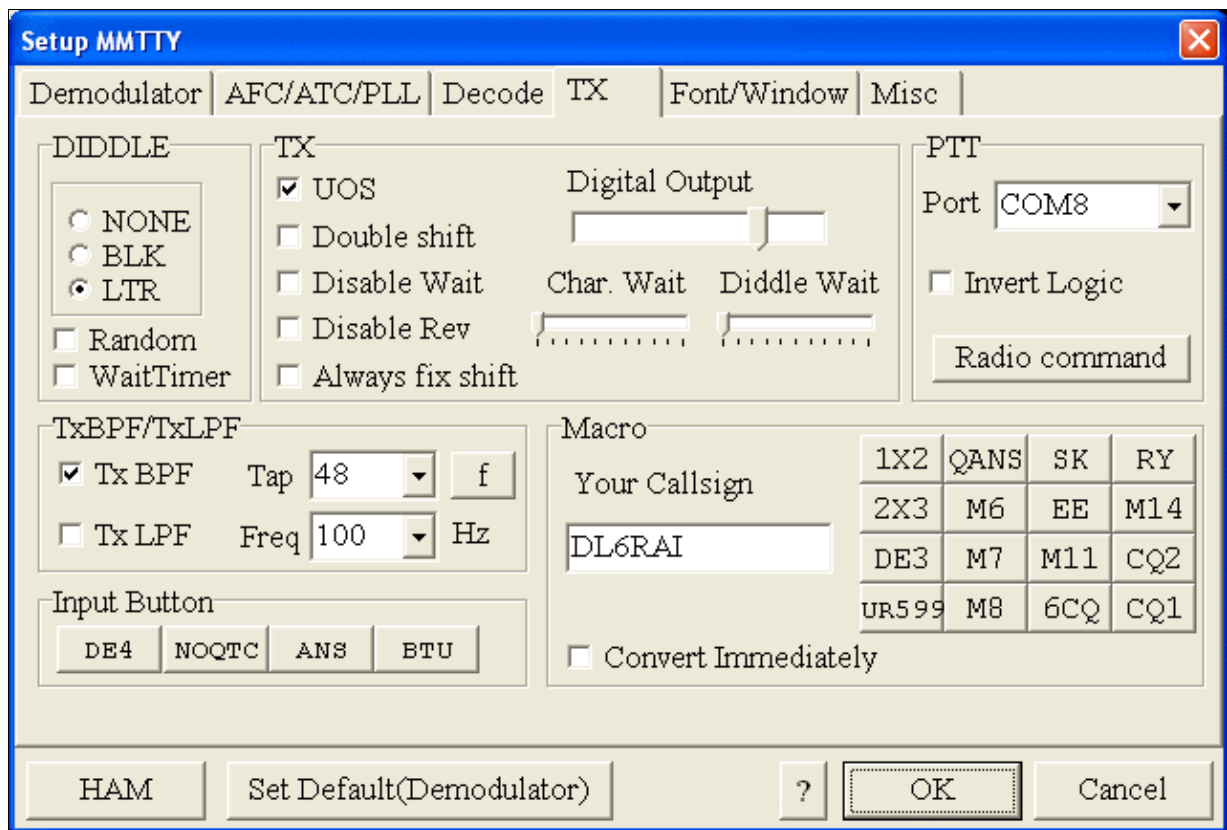

MMTTY Tx settings - PTT is generated by the MKII through COM8

- Select the Misc tab. Since we now have two sound cards - one in the computer, one built into the MKII called microHAM CODEC - we must make sure we're listening on the latter. Switch to the USB router's Audio Mixer Tab and get the device ID by clicking on the button "Get ID" in the lower right corner. This ID must be entered into MMTTY's Device ID field. When listening on the correct device, the LINE LED on the MKII should be lit.
- Also from the Misc tab, select COM-TxD(FSK).

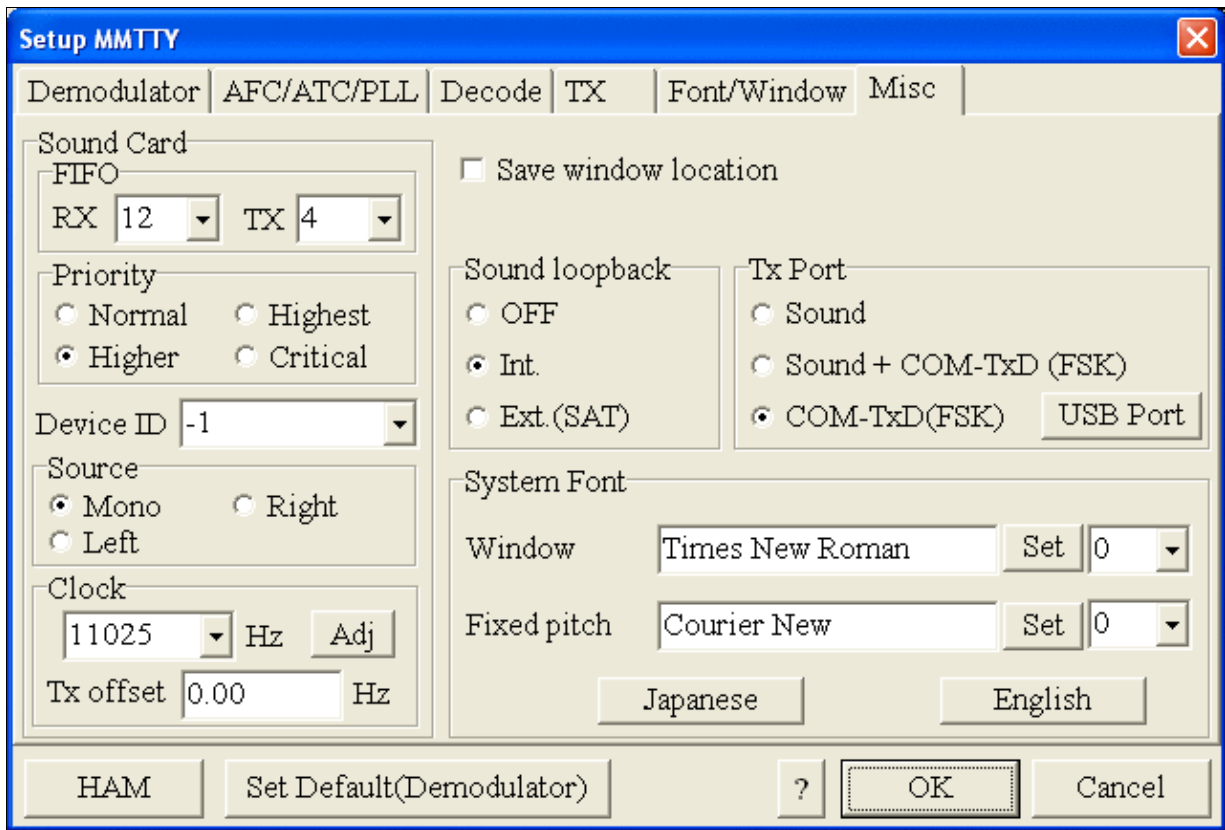

MMTTY Misc settings - FSK is generated via COM8

- Should you have problems generating the FSK signal (especially: keying does work, you hear the RTTY diddle, but no characters are being transmitted), you might have to limit the USB port speed in MMTTY. This setting depends very much on the computer hardware. To limit the USB port speed click on **USB Port** and configure option "C". You can find this setting also in the support documentation of the Microkeyer on the microHAM website.

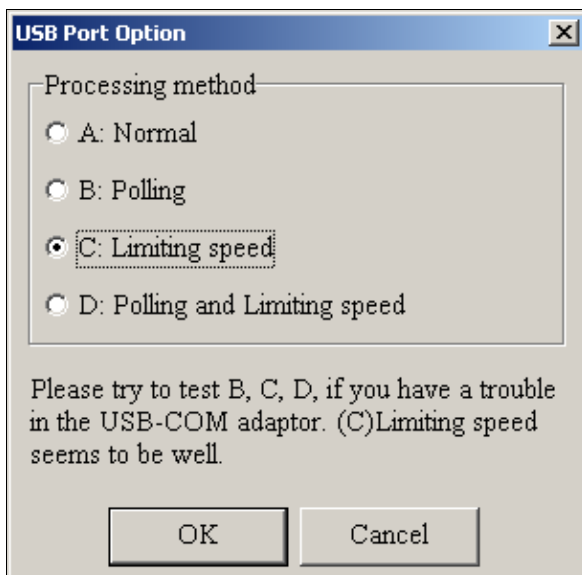



MMTTY USB Port Option - Set only to option C if A does not work for you.

- Exit the Setup screens by pressing the OK button.

We are now ready to do some tests with MMTTY.

- Now take a look at the XY Scope display. It should look like the picture above.
- If you only see a single white point in the middle of the display, this means, that MMTTY gets no audio to process.
  - ◆ Check your cabling. Is your cable connected to Line-in or Mic-in?
  - ◆ Did you select the correct audio device?
  - ◆ Check the level settings for the sound card from the USB Router's Audio Mixer tab. When you move the control up and down you should see an increase and decrease in noise level.



## Win-Test Wiki

Setting the correct audio level on the microHAM CODEC sound card

- Tune across the CW band and check if the XY scope changes when you hear signals. Once you tune across a carrier or CW signal, you should see a vertical ellipse and then a horizontal ellipse or vice versa depending on which direction you tune. The receive section of the screen will show all kinds of clutter.
- Try to find a RTTY signal (not easy on a normal day). Both ellipses should now be perpendicular to each other. See if you can decode RTTY fine. You may have to select proper filters. I use 500 Hz at 8.8 MHz IF and 2.7 kHz at 455 kHz IF.
- Next, press the TX button in the MMTTY application. You should hear the typical RTTY diddle in the monitor of the radio. The XY Scope will also display a clean RTTY signal.
- Type a few characters (including your callsign) and see how they are transmitted.
- Press the TX button one more time to shut off transmission.
- Exit the MMTTY program now.

MMTTY now works perfectly as a stand-alone program. We are now ready for Win-Test.

## Win-Test

**Interfaces configuration... [Alt+H for help]**

**Serial ports**

<input type="checkbox"/> COM1	Network	19200 8-N-1	Configure...
<input type="checkbox"/> COM2	Network	19200 8-N-1	Configure...
<input type="checkbox"/> COM3	Network	9600 8-N-1	Configure...
<input type="checkbox"/> COM4	Network	19200 8-N-1	Configure...
<input checked="" type="checkbox"/> COM5	Radio 1	4800 8-N-2	Configure...
<input type="checkbox"/> COM6	Network	9600 8-N-1	Configure...
<input checked="" type="checkbox"/> COM7	WinKey	1200 8-N-2	Configure...
<input type="checkbox"/> COM8	Network	1200 8-N-1 CW PTT	Configure...
<input checked="" type="checkbox"/> COM9	microHAM MK/MKII	19200 8-N-1	Configure...
<input type="checkbox"/> COM10	Network	19200 8-N-1	Configure...
<input type="checkbox"/> COM11	Network	19200 8-N-1	Configure...
<input type="checkbox"/> COM12	Network	19200 8-N-1	Configure...

**Printer ports**

LPT Configure...

**CW**

PTT ON delay (ms):

**Ethernet**

Enable ethernet network

Broadcast address:  By default

Port number:  By default

**Network protocol**

Advanced settings...

**Voice key**

Enable sound card

Mute the microphone input when the DVK is playing

Mute the microphone input when the DVK is not playing

**Transceivers**

Radio 1:   Don't poll  Use CI-V Transceive Polling rate (ms):

Radio 2:   Don't poll  Use CI-V Transceive Polling rate (ms):

OK Cancel

Final steps: Win-Test Interfaces configuration. Note that we only set up three COM ports, no PTT or CW settings are needed as they are all generated/controlled by the MKII.

- Start up Win-Test, create a new Win-Test file for testing.
- Select DXpedition and allow All Modes so you can test all three different modes.
- in the **Options | Configure Interfaces...** menu
  - ◆ configure Radio on COM5
  - ◆ configure Winkey on COM7 using default settings
  - ◆ configure microHAM MK/MKII on COM9
  - ◆ untag Win-Test's internal Voice Keyer
- Go to Configure MMTTY.EXE startup path as described in the [RTTY section of this manual](#) if you are planning for RTTY operation

We are now ready to operate the contest.

## Namespaces

- [Page](#)
- [Discussion](#)

## Variants

## Views

- [Read](#)
- [View source](#)
- [View history](#)

## More

- This page was last edited on 18 April 2015, at 15:32.
- [Privacy policy](#)
- [About Win-Test Wiki](#)
- [Disclaimers](#)



# BestPractice6

From Win-Test Wiki

[Jump to navigation](#) [Jump to search](#)

## Contents

- [1 Setting up a Yaesu FT-1000D with the microHAM microKeyer II](#)
- [2 Yaesu FT-1000D](#)
- [3 microHAM MKII](#)
- [4 microHAM USB Device Router](#)
- [5 MMTTY](#)
- [6 Win-Test](#)

## Setting up a Yaesu FT-1000D with the microHAM microKeyer II

This article is a step by step approach describing how to set up an Yaesu FT-1000D radio and a microHAM microKeyer II interface. The MKII is a complex device integrating a CW-Keyer, CW and FSK keying, PTT control (including a delayed PTT), radio control and a sound card, a digital voice keyer which allows to control up to ten audio memories and different audio switching scenarios. This article covers the set-up of CW, RTTY and SSB in several steps.

[BestPractice1](#) article describes a slightly simpler set-up with the Microham USB Interface II. [BestPractice4](#) article describes a slightly simpler set-up with the microHAM microKeyer. Please see there for background information about RTTY and MMTTY in general.

## Yaesu FT-1000D

- Open the lid of the top access panel and check the settings for the four RTTY dip switches. Switches 3-5 should be down and switch 6 should be up. This selects the low tone pair for FSK, a shift of 170 Hz and normal polarity of MARK and SPACE. For further reference, see the FT-1000D operating manual, page 16.

To test the settings, put the radio to FSK mode, push the MONI button and then switch the radio to transmit by pressing MOX. You should now hear a 1275 Hz tone. If you connect Pin4 and Pin1 of the 5 pole DIN connector named "RTTY" on the back of the radio you should hear the tone going up to 1445 Hz.

## microHAM MKII

- Connect the MKII to a 12V DC source. The built-in power source of the FT-1000D is not enough to power the MK-II (500 mA required).
- Connect a footswitch to the FOOTSW connector of the MKII.
- Connect your microphone or headset to the short RJ45 cable that goes into MIC on the MKII (this connector does also provide the 8V DC voltage on pin 5 for your electret microphone).
- Connect the microHAM MKII to your radio and computer.
  - ◆ On the radio side there will be five connections: KEY, RTTY, PACKET, CAT, AF OUT and microphone.
  - ◆ On the computer side there will be only a single connection: USB. I had to use a ferrite core to get rid of RF noise.
- Install the microHAM software if you haven't done so already. There are two steps to it:

- ◆ Installing the device driver - if you have several microHAM devices you will have to do this once for each of them.
- ◆ Installing the USB Device Router - this software only needs to be installed once. It is identical on all microHAM products.

**Note:** If you had previously installed the USB Device Router with another microHAM product, it will come up with a new tab for the new hardware connected.

## microHAM USB Device Router

- Set up the Device Router
- Go to the Ports Tab
  - ◆ Create three virtual COM ports: COM6, COM7, COM8 and COM9. Note: The absolute port numbers do not matter. The key is consistency - the same port number must be used for a specific function every time it is used.
  - ◆ Configure Radio on COM6
  - ◆ Press the **Set** button to the right of the radio port configuration and select FT-1000D. MKII will assign different Audio Routing and PTT scenarios if it knows what frequency and mode the radio is set. This is why we have to do it.
  - ◆ You should now see the current frequency of the radio display in the **Ports** tab
  - ◆ Configure Winkey COM7 using Winkey default settings
  - ◆ Configure FSK on COM8. Make sure you tick the PTT tag
  - ◆ Configure Control on COM9. This will allow controlling the MKII, especially the DVK from Win-Test.

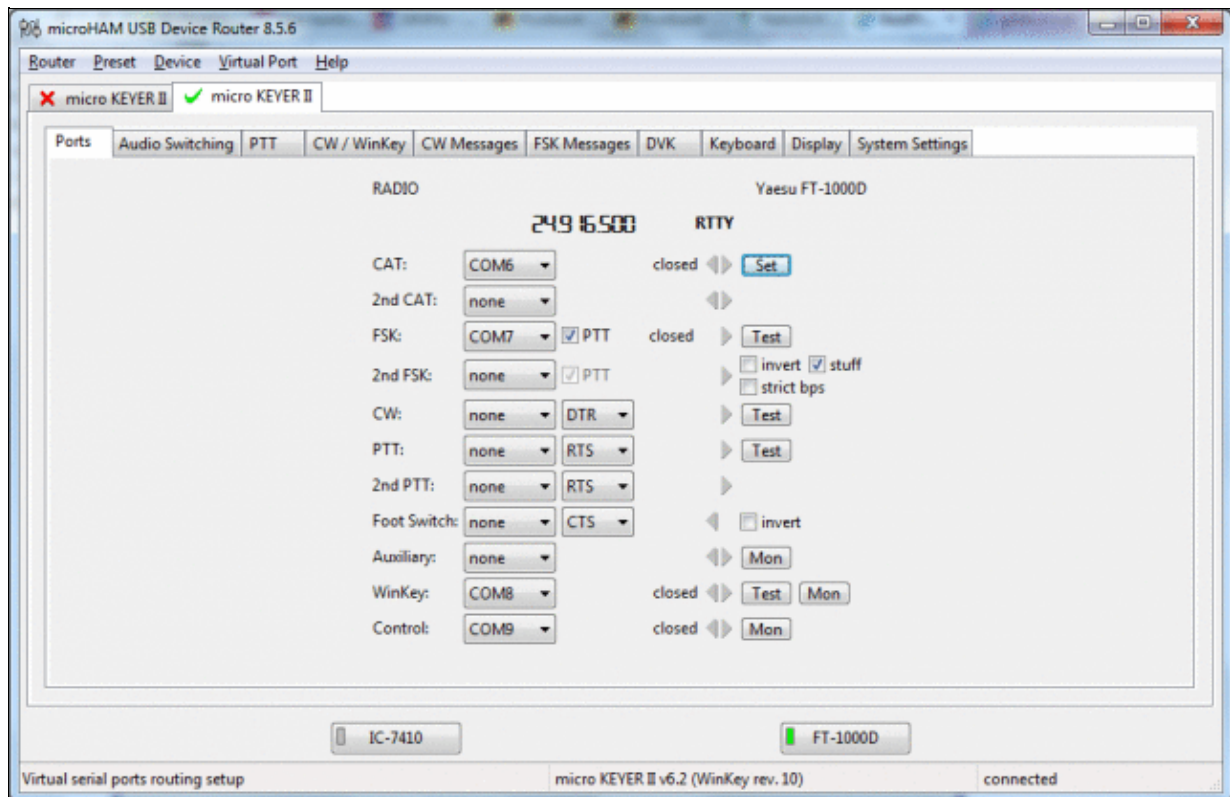

microHAM MKII Ports setup. We use COM6,7,8 and 9 to control different properties of the MKII.

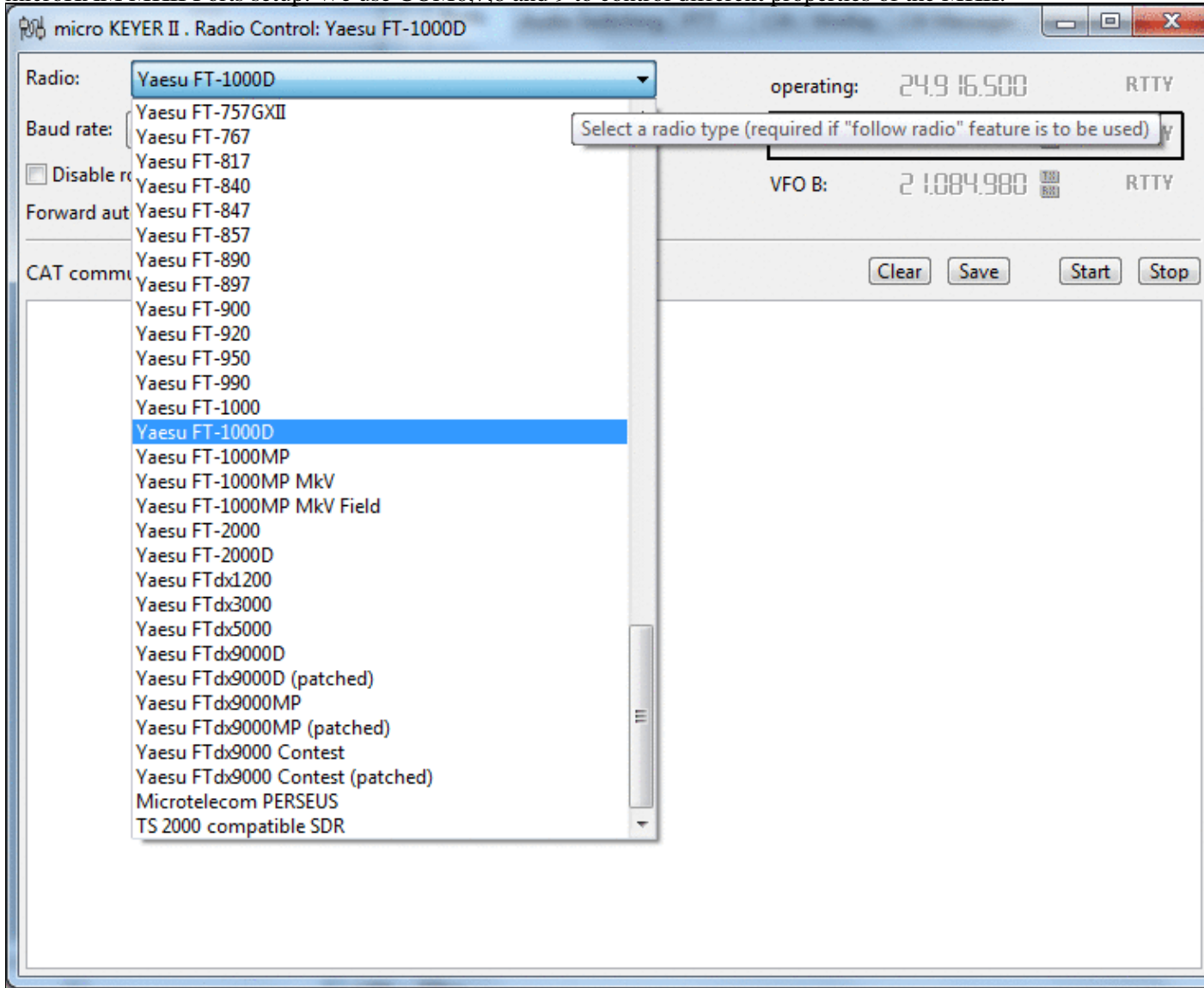

Make sure, the MKII knows about your radio so it can control Audio Switching and PTT depending on the selected mode.

- Go to the Audio Switching Tab
  - ◆ Configure the Audio Switching as shown below.
    - ◇ Have the radio on LSB or USB. Select "Microphone jack, DVK control".
    - ◇ Now switch the radio to FSK mode. Select "line input (rear)".





microHAM MKII Audio Switching setup.

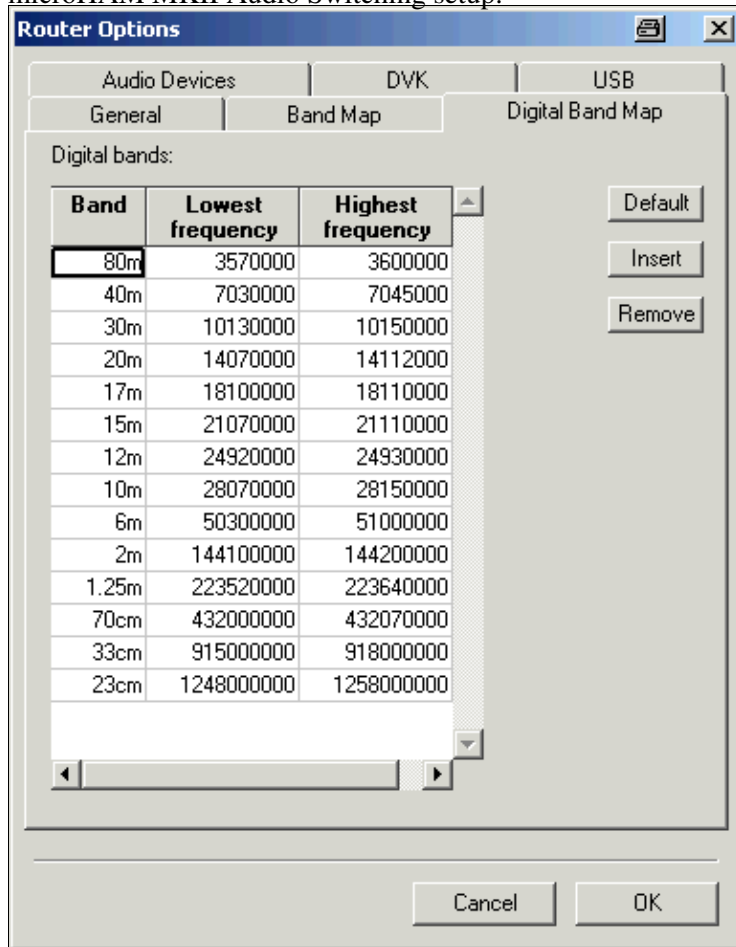

## Win-Test Wiki

This is the digital band map which is used to decide which mode the radio is operating in. With Yaesu radios, MKII retrieves the mode directly from the communication protocol, so this map is not used.

- Go to the Audio Mixing Tab
  - ◆ Select the microHAM CODEC sound device

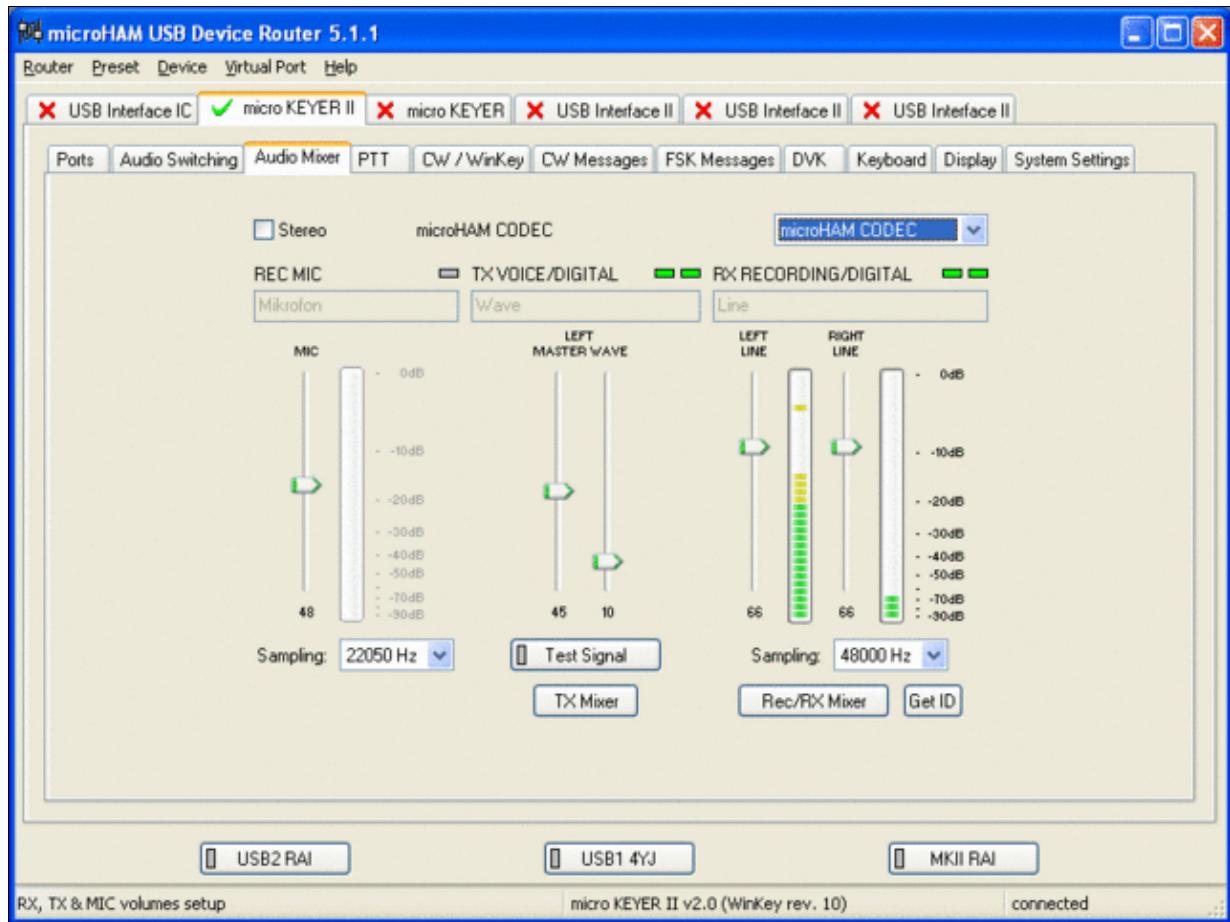

Using the built-in sound card requires selecting it here.

- Go to the PTT Tab
  - ◆ In the PTT selector, select "semi break in" for CW, "PTT1" for Voice and "PTT2" for Digital Modes. This will allow using QSK or VOX operation on CW (which I prefer over the microHAM doing all the switching - but mind hot switching PA relays!). Selecting PTT1 for voice operation will route audio input to the front Mic connector of the radio - avoiding audio level problems.

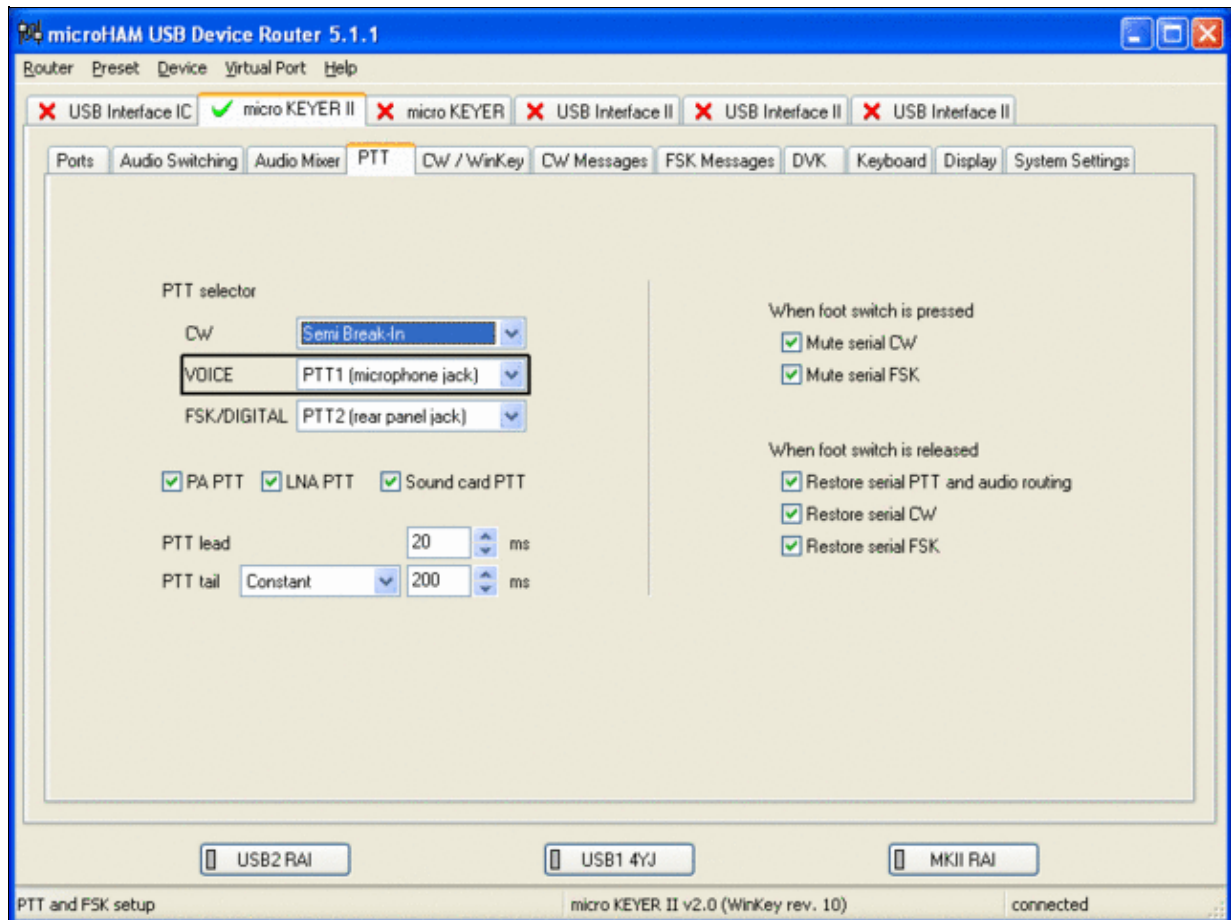

Different PTT settings depending on mode

- Go to the CW/WinKey Tab
  - ◆ My preferred settings are Paddle Mode: Iambic A (Curtis), disable Paddle memory (actually, Dot-Dash-Memory off)



WinKey settings - this is very much depending on your personal preferences

- Testing
  - ◆ Go to a CW frequency, switch the radio to CW and press the VOX button on the radio
  - ◆ Touch the paddle - the radio should switch to transmit without any relay clicking inside the MKII.
  - ◆ The CW/FSK LED on the MKII should flicker with a red light.
  - ◆ Press the Test button on the Winkey port (COM 7) in the Port Tab. The MKII should send **Dah dit dit-dit-dit dah**
  - ◆ Go to a SSB frequency and switch the radio to USB or LSB.
  - ◆ Press the microphone's PTT or the foot switch and say something. The PTT1 LED on the MKII should light up in red color. The radio should go to transmit and produce some output.
  - ◆ Go to the DVK tab, push the RECORD button and say something. Then push the PLAY button. The radio should activate the PTT1 (red light) and transmit your recorded message.
  - ◆ Press the MON button on the radio and listen to the audio. Some audio level adjustments may be required in the Audio Mixer tab.
  - ◆ Go to a RTTY frequency and switch the radio to FSK.
  - ◆ Press the Test button on the FSK port (COM8) in the Port Tab. The radio should switch to transmit, send TEST on RTTY and go back to received.
  - ◆ The CW/FSK LED should flicker with a green light and the PTT2 LED should turn green, while the radio is on transmit.

We are now ready for the next step.

## MMTTY

- Download and Install MMTTY from [here](#).
- Start MMTTY
- Activate the XY Scope by selecting the **View(V)** menu item and tagging **XYScope**

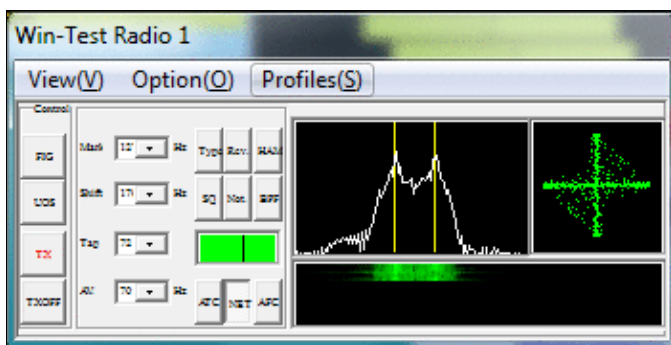

The XY Scope is a practical tuning aid and will help us to visualize the received signals.

- Go to **Option (O) | Setup MMTTY (O) ...**
- Select the Demodulator tab and set it up like in the picture below.



## MMTTY Demodulator settings

- Select the AFC/ATC/PLL tab and make sure AFC is OFF.



MMTTY AFC/ATC/PLL settings. Make sure AFC is off as it will eventually introduce a deviation between TX and RX frequencies.

- Select the TX tab and switch PTT port to COM8. The Radio Command button in this setup screen will allow you to control the radio from within MMTTY. This is not desired in this scenario so make sure it is **not configured** - otherwise Win-Test would not have access to the radio COM port later.



MMTTY Tx settings - PTT is generated by the MKII through COM8

- Select the Misc tab. Since we now have two sound cards - one in the computer, one built into the MKII called microHAM CODEC - we must make sure we're listening on the latter. Switch to the USB router's Audio Mixer Tab and get the device ID by clicking on the button "Get ID" in the lower right corner. This ID must be entered into MMTTY's Device ID field. When listening on the correct device, the LINE LED on the MKII should be lit.
- Also from the Misc tab, select COM-TxD(FSK).



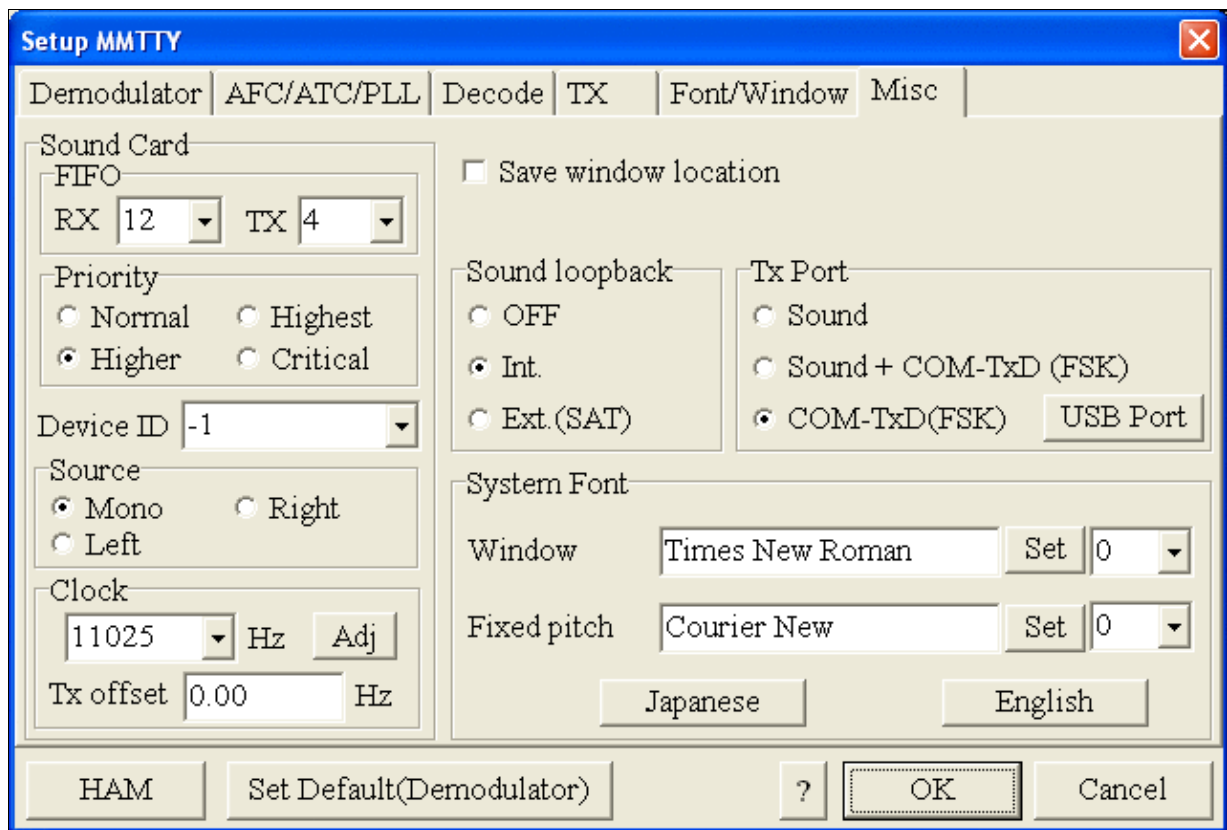

MMTTY Misc settings - FSK is generated via COM8

- Should you have problems generating the FSK signal (especially: keying does work, you hear the RTTY diddle, but no characters are being transmitted), you might have to limit the USB port speed in MMTTY. This setting depends very much on the computer hardware. To limit the USB port speed click on **USB Port** and configure option "C". You can find this setting also in the support documentation of the Microkeyer on the microHAM website.

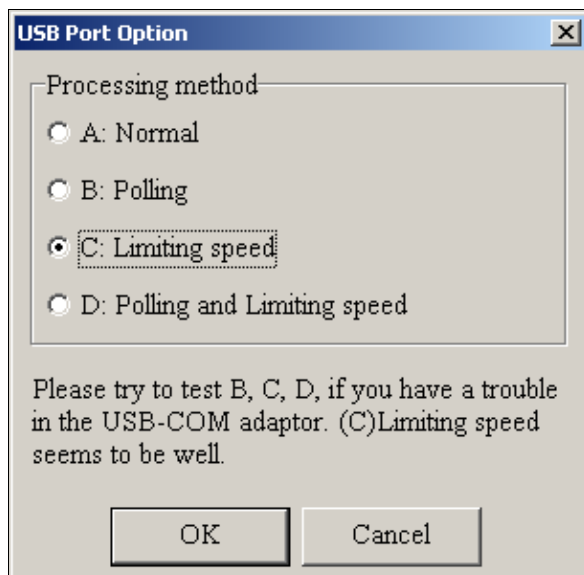

MMTTY USB Port Option - Set only to option C if A does not work for you.

- Exit the Setup screens by pressing the OK button.

We are now ready to do some tests with MMTTY.

- Now take a look at the XY Scope display. It should look like the picture above.
- If you only see a single white point in the middle of the display, this means, that MMTTY gets no audio to process.
  - ◆ Check your cabling. Is your cable connected to Line-in or Mic-in?
  - ◆ Did you select the correct audio device?
  - ◆ Check the level settings for the sound card from the USB Router's Audio Mixer tab. When you move the control up and down you should see an increase and decrease in noise level.



## Win-Test Wiki

Setting the correct audio level on the microHAM CODEC sound card

- Tune across the CW band and check if the XY scope changes when you hear signals. Once you tune across a carrier or CW signal, you should see a vertical ellipse and then a horizontal ellipse or vice versa depending on which direction you tune. The receive section of the screen will show all kinds of clutter.
- Try to find a RTTY signal (not easy on a normal day). Both ellipses should now be perpendicular to each other. See if you can decode RTTY fine. You may have to select proper filters. I use 500 Hz at 8.8 MHz IF and 2.7 kHz at 455 kHz IF.
- Next, press the TX button in the MMTTY application. You should hear the typical RTTY diddle in the monitor of the radio. The XY Scope will also display a clean RTTY signal.
- Type a few characters (including your callsign) and see how they are transmitted.
- Press the TX button one more time to shut off transmission.
- Exit the MMTTY program now.

MMTTY now works perfectly as a stand-alone program. We are now ready for Win-Test.

## Win-Test

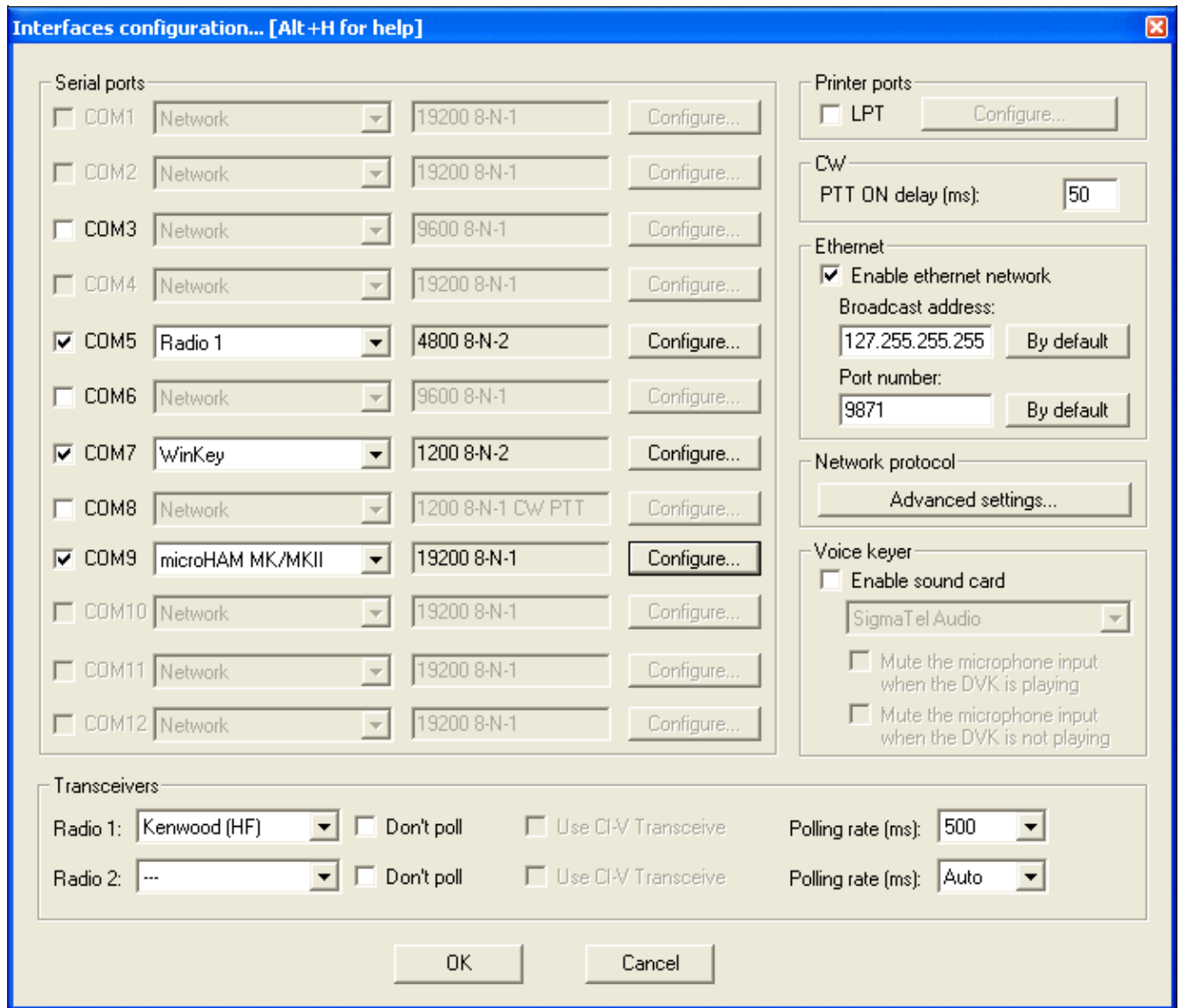

Final steps: Win-Test Interfaces configuration. Note that we only set up three COM ports, no PTT or CW settings are needed as they are all generated/controlled by the MKII.

- Start up Win-Test, create a new Win-Test file for testing.
- Select DXpedition and allow All Modes so you can test all three different modes.
- in the **Options | Configure Interfaces...** menu
  - ◆ configure Radio on COM6
  - ◆ configure Winkey on COM7 using default settings
  - ◆ configure microHAM MK/MKII on COM9
  - ◆ untag Win-Test's internal Voice Keyer
- Go to Configure MMTTY.EXE startup path as described in the [RTTY section of this manual](#) if you are planning for RTTY operation

We are now ready to operate the contest.

## Namespaces

- [Page](#)
- [Discussion](#)

## Variants

## Views

- [Read](#)
- [View source](#)
- [View history](#)

## More

- This page was last edited on 21 September 2015, at 22:27.
- [Privacy policy](#)
- [About Win-Test Wiki](#)
- [Disclaimers](#)



# BestPractice6

From Win-Test Wiki

[Jump to navigation](#) [Jump to search](#)

## Contents

- [1 Setting up a Yaesu FT-1000D with the microHAM microKeyer II](#)
- [2 Yaesu FT-1000D](#)
- [3 microHAM MKII](#)
- [4 microHAM USB Device Router](#)
- [5 MMTTY](#)
- [6 Win-Test](#)

## Setting up a Yaesu FT-1000D with the microHAM microKeyer II

This article is a step by step approach describing how to set up an Yaesu FT-1000D radio and a microHAM microKeyer II interface. The MKII is a complex device integrating a CW-Keyer, CW and FSK keying, PTT control (including a delayed PTT), radio control and a sound card, a digital voice keyer which allows to control up to ten audio memories and different audio switching scenarios. This article covers the set-up of CW, RTTY and SSB in several steps.

[BestPractice1](#) article describes a slightly simpler set-up with the Microham USB Interface II. [BestPractice4](#) article describes a slightly simpler set-up with the microHAM microKeyer. Please see there for background information about RTTY and MMTTY in general.

## Yaesu FT-1000D

- Open the lid of the top access panel and check the settings for the four RTTY dip switches. Switches 3-5 should be down and switch 6 should be up. This selects the low tone pair for FSK, a shift of 170 Hz and normal polarity of MARK and SPACE. For further reference, see the FT-1000D operating manual, page 16.

To test the settings, put the radio to FSK mode, push the MONI button and then switch the radio to transmit by pressing MOX. You should now hear a 1275 Hz tone. If you connect Pin4 and Pin1 of the 5 pole DIN connector named "RTTY" on the back of the radio you should hear the tone going up to 1445 Hz.

## microHAM MKII

- Connect the MKII to a 12V DC source. The built-in power source of the FT-1000D is not enough to power the MK-II (500 mA required).
- Connect a footswitch to the FOOTSW connector of the MKII.
- Connect your microphone or headset to the short RJ45 cable that goes into MIC on the MKII (this connector does also provide the 8V DC voltage on pin 5 for your electret microphone).
- Connect the microHAM MKII to your radio and computer.
  - ◆ On the radio side there will be five connections: KEY, RTTY, PACKET, CAT, AF OUT and microphone.
  - ◆ On the computer side there will be only a single connection: USB. I had to use a ferrite core to get rid of RF noise.
- Install the microHAM software if you haven't done so already. There are two steps to it:

- ◆ Installing the device driver - if you have several microHAM devices you will have to do this once for each of them.
- ◆ Installing the USB Device Router - this software only needs to be installed once. It is identical on all microHAM products.

**Note:** If you had previously installed the USB Device Router with another microHAM product, it will come up with a new tab for the new hardware connected.

## microHAM USB Device Router

- Set up the Device Router
- Go to the Ports Tab
  - ◆ Create three virtual COM ports: COM6, COM7, COM8 and COM9. Note: The absolute port numbers do not matter. The key is consistency - the same port number must be used for a specific function every time it is used.
  - ◆ Configure Radio on COM6
  - ◆ Press the **Set** button to the right of the radio port configuration and select FT-1000D. MKII will assign different Audio Routing and PTT scenarios if it knows what frequency and mode the radio is set. This is why we have to do it.
  - ◆ You should now see the current frequency of the radio display in the **Ports** tab
  - ◆ Configure Winkey COM7 using Winkey default settings
  - ◆ Configure FSK on COM8. Make sure you tick the PTT tag
  - ◆ Configure Control on COM9. This will allow controlling the MKII, especially the DVK from Win-Test.

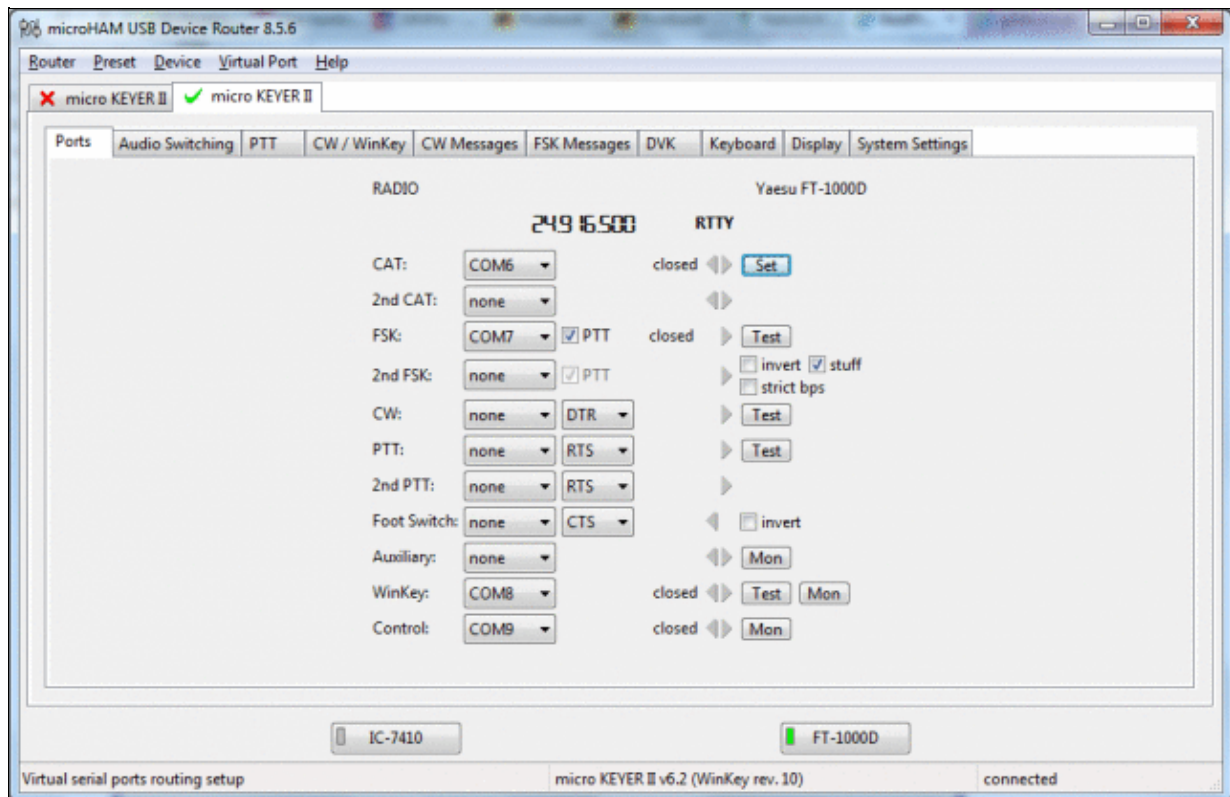

microHAM MKII Ports setup. We use COM6,7,8 and 9 to control different properties of the MKII.

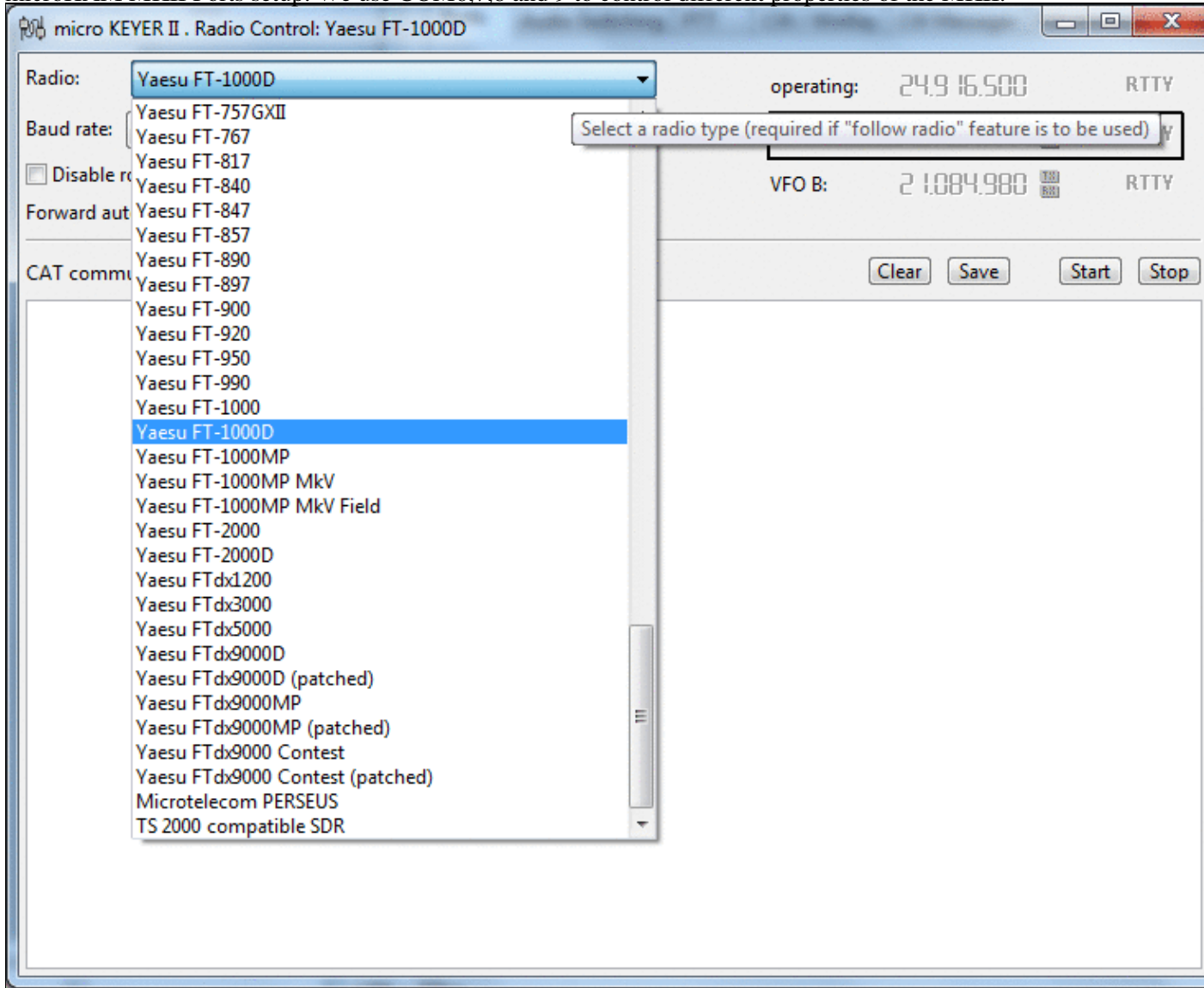



Make sure, the MKII knows about your radio so it can control Audio Switching and PTT depending on the selected mode.

- Go to the Audio Switching Tab
  - ◆ Configure the Audio Switching as shown below.
    - ◇ Have the radio on LSB or USB. Select "Microphone jack, DVK control".
    - ◇ Now switch the radio to FSK mode. Select "line input (rear)".

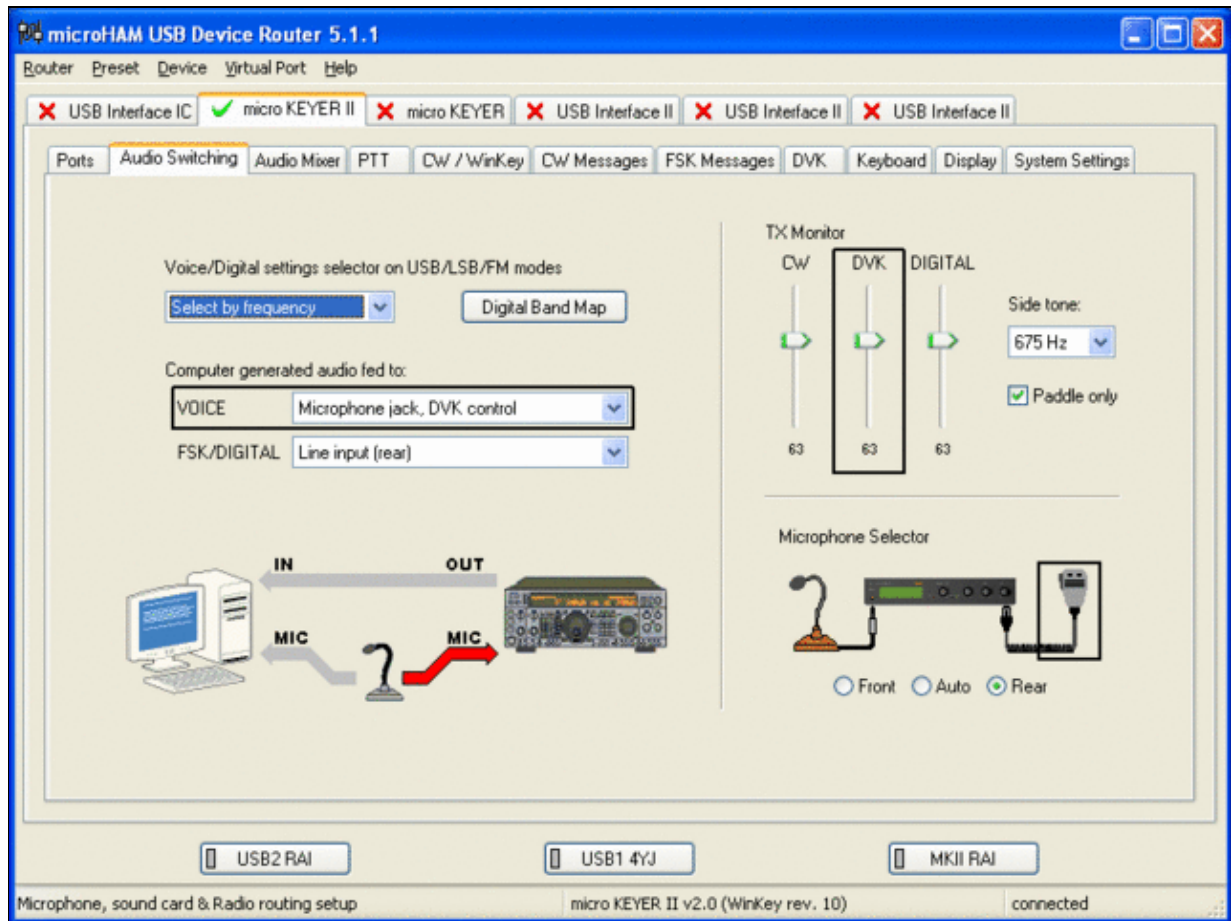

microHAM MKII Audio Switching setup.

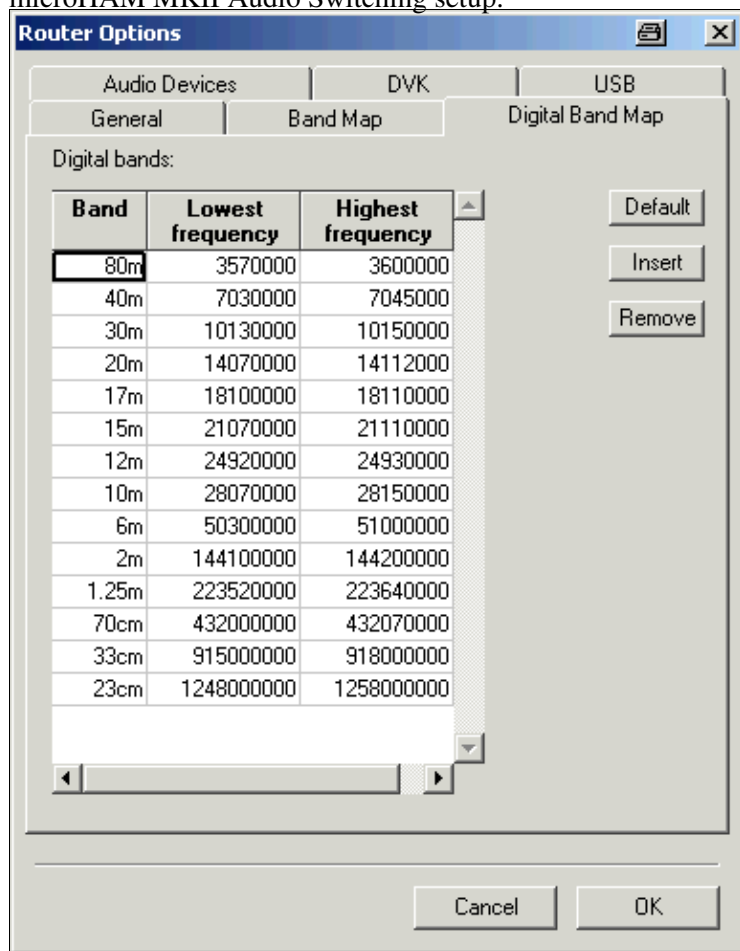

## Win-Test Wiki

This is the digital band map which is used to decide which mode the radio is operating in. With Yaesu radios, MKII retrieves the mode directly from the communication protocol, so this map is not used.

- Go to the Audio Mixing Tab
  - ◆ Select the microHAM CODEC sound device

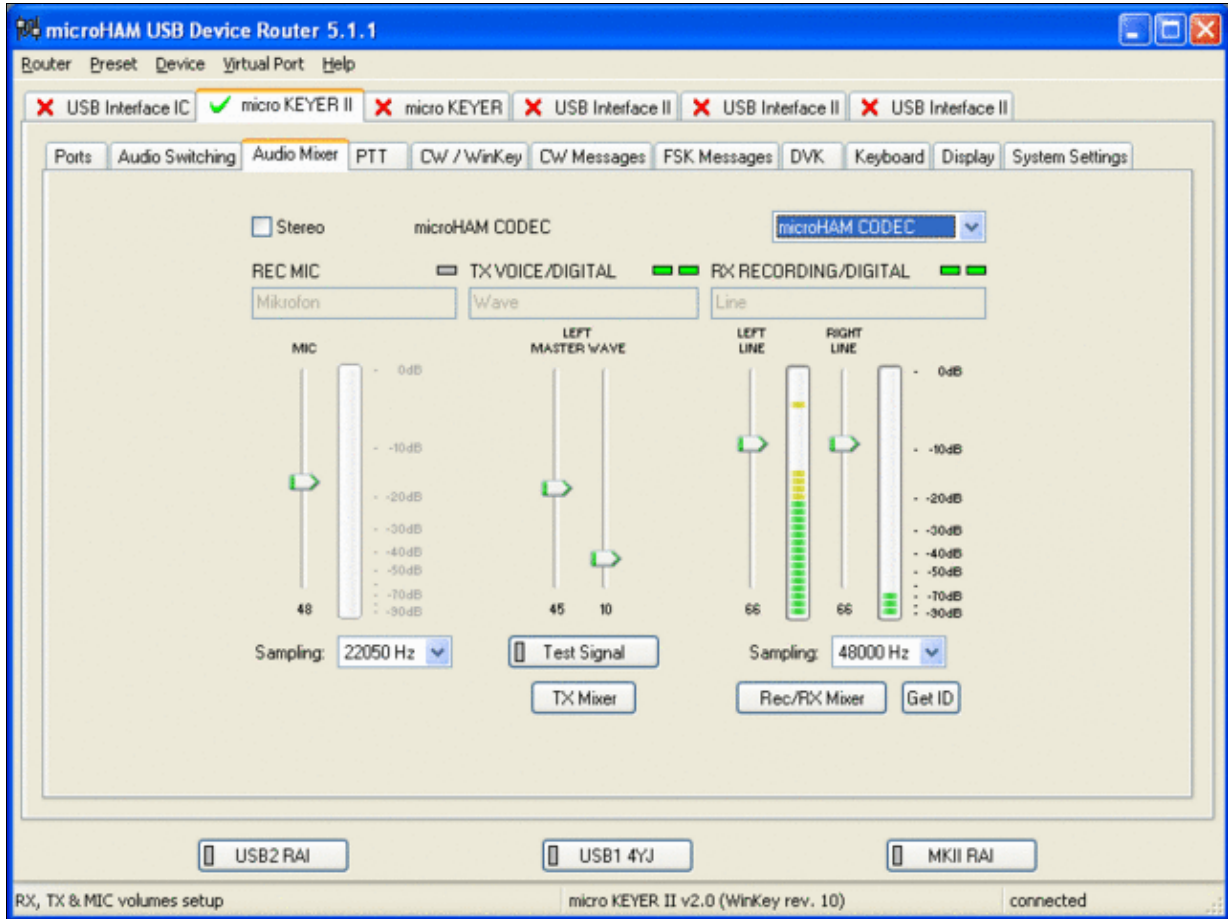

Using the built-in sound card requires selecting it here.

- Go to the PTT Tab
  - ◆ In the PTT selector, select "semi break in" for CW, "PTT1" for Voice and "PTT2" for Digital Modes. This will allow using QSK or VOX operation on CW (which I prefer over the microHAM doing all the switching - but mind hot switching PA relays!). Selecting PTT1 for voice operation will route audio input to the front Mic connector of the radio - avoiding audio level problems.

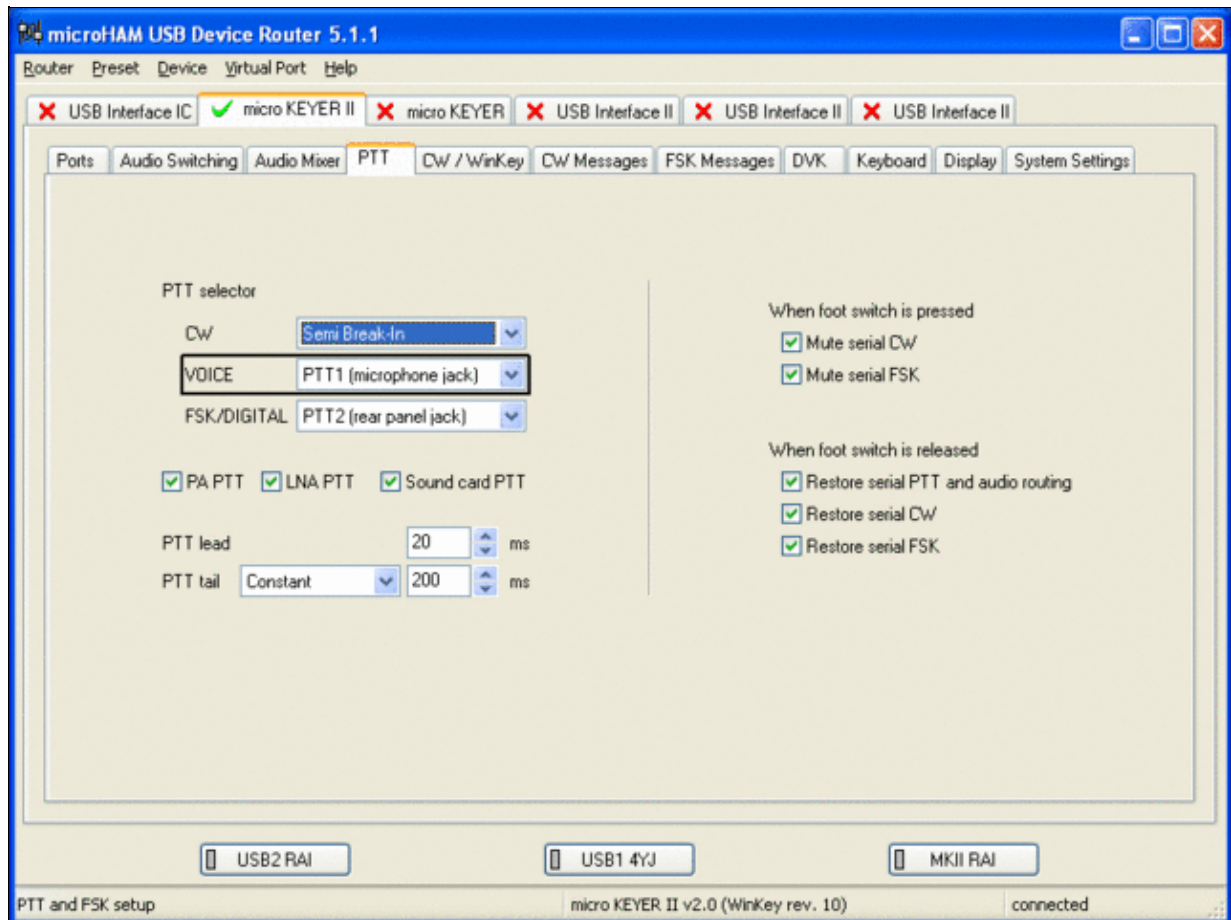

Different PTT settings depending on mode

- Go to the CW/WinKey Tab
  - ◆ My preferred settings are Paddle Mode: Iambic A (Curtis), disable Paddle memory (actually, Dot-Dash-Memory off)

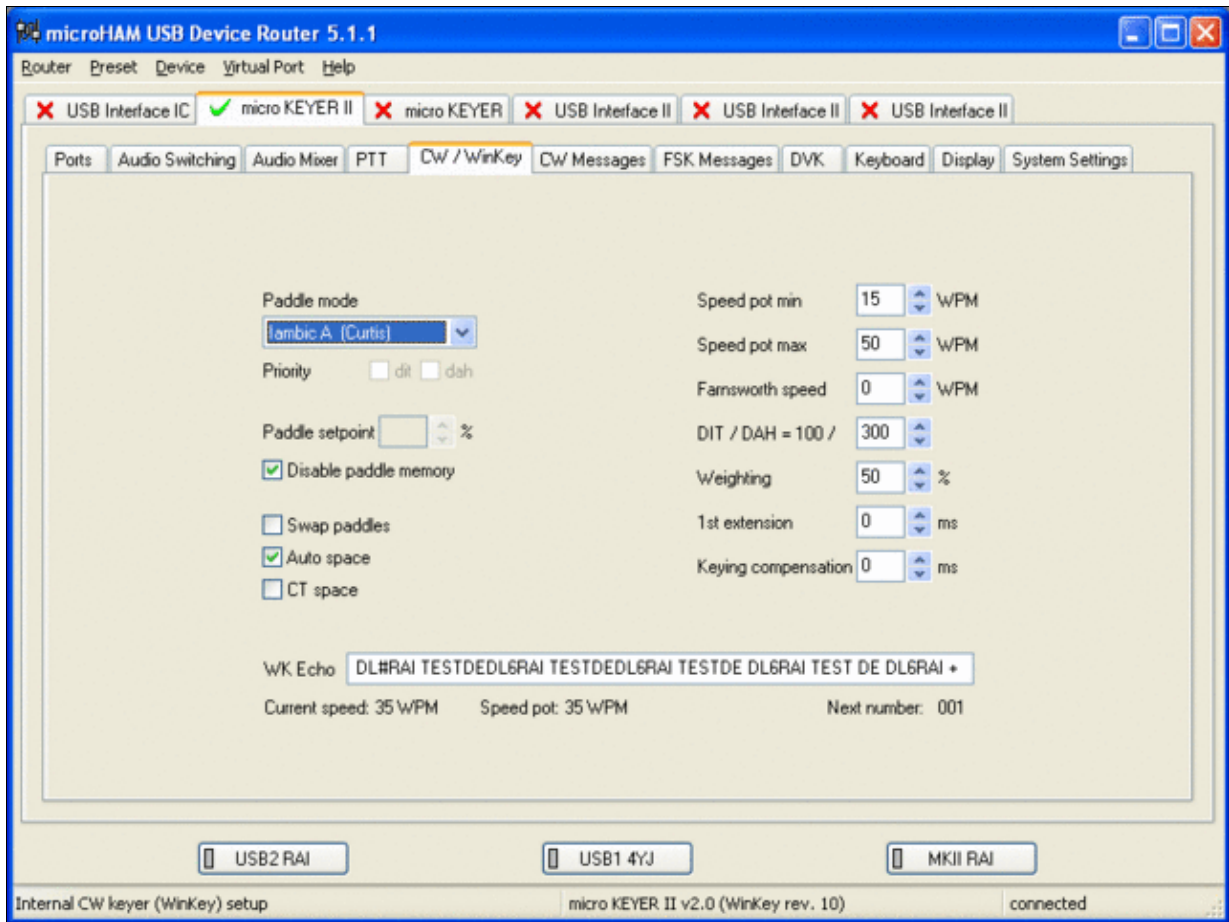

WinKey settings - this is very much depending on your personal preferences

- Testing
  - ◆ Go to a CW frequency, switch the radio to CW and press the VOX button on the radio
  - ◆ Touch the paddle - the radio should switch to transmit without any relay clicking inside the MKII.
  - ◆ The CW/FSK LED on the MKII should flicker with a red light.
  - ◆ Press the Test button on the Winkey port (COM 7) in the Port Tab. The MKII should send **Dah dit dit-dit-dit dah**
  - ◆ Go to a SSB frequency and switch the radio to USB or LSB.
  - ◆ Press the microphone's PTT or the foot switch and say something. The PTT1 LED on the MKII should light up in red color. The radio should go to transmit and produce some output.
  - ◆ Go to the DVK tab, push the RECORD button and say something. Then push the PLAY button. The radio should activate the PTT1 (red light) and transmit your recorded message.
  - ◆ Press the MON button on the radio and listen to the audio. Some audio level adjustments may be required in the Audio Mixer tab.
  - ◆ Go to a RTTY frequency and switch the radio to FSK.
  - ◆ Press the Test button on the FSK port (COM8) in the Port Tab. The radio should switch to transmit, send TEST on RTTY and go back to received.
  - ◆ The CW/FSK LED should flicker with a green light and the PTT2 LED should turn green, while the radio is on transmit.

We are now ready for the next step.

## MMTTY

- Download and Install MMTTY from [here](#).
- Start MMTTY
- Activate the XY Scope by selecting the **View(V)** menu item and tagging **XYScope**

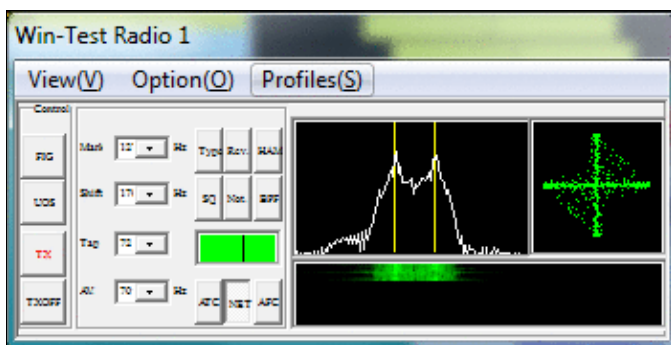

The XY Scope is a practical tuning aid and will help us to visualize the received signals.

- Go to **Option (O) | Setup MMTTY (O) ...**
- Select the Demodulator tab and set it up like in the picture below.



## MMTTY Demodulator settings

- Select the AFC/ATC/PLL tab and make sure AFC is OFF.



MMTTY AFC/ATC/PLL settings. Make sure AFC is off as it will eventually introduce a deviation between TX and RX frequencies.

- Select the TX tab and switch PTT port to COM8. The Radio Command button in this setup screen will allow you to control the radio from within MMTTY. This is not desired in this scenario so make sure it is **not configured** - otherwise Win-Test would not have access to the radio COM port later.



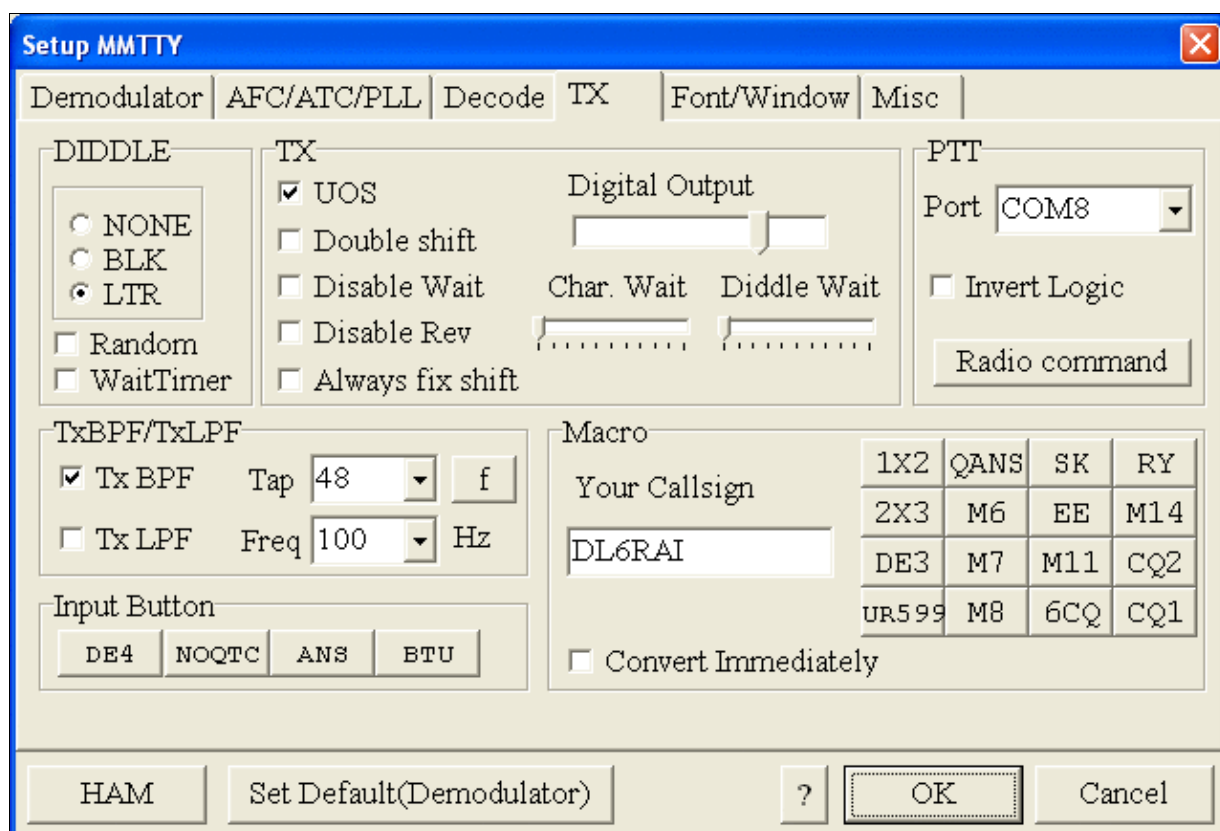

MMTTY Tx settings - PTT is generated by the MKII through COM8

- Select the Misc tab. Since we now have two sound cards - one in the computer, one built into the MKII called microHAM CODEC - we must make sure we're listening on the latter. Switch to the USB router's Audio Mixer Tab and get the device ID by clicking on the button "Get ID" in the lower right corner. This ID must be entered into MMTTY's Device ID field. When listening on the correct device, the LINE LED on the MKII should be lit.
- Also from the Misc tab, select COM-TxD(FSK).

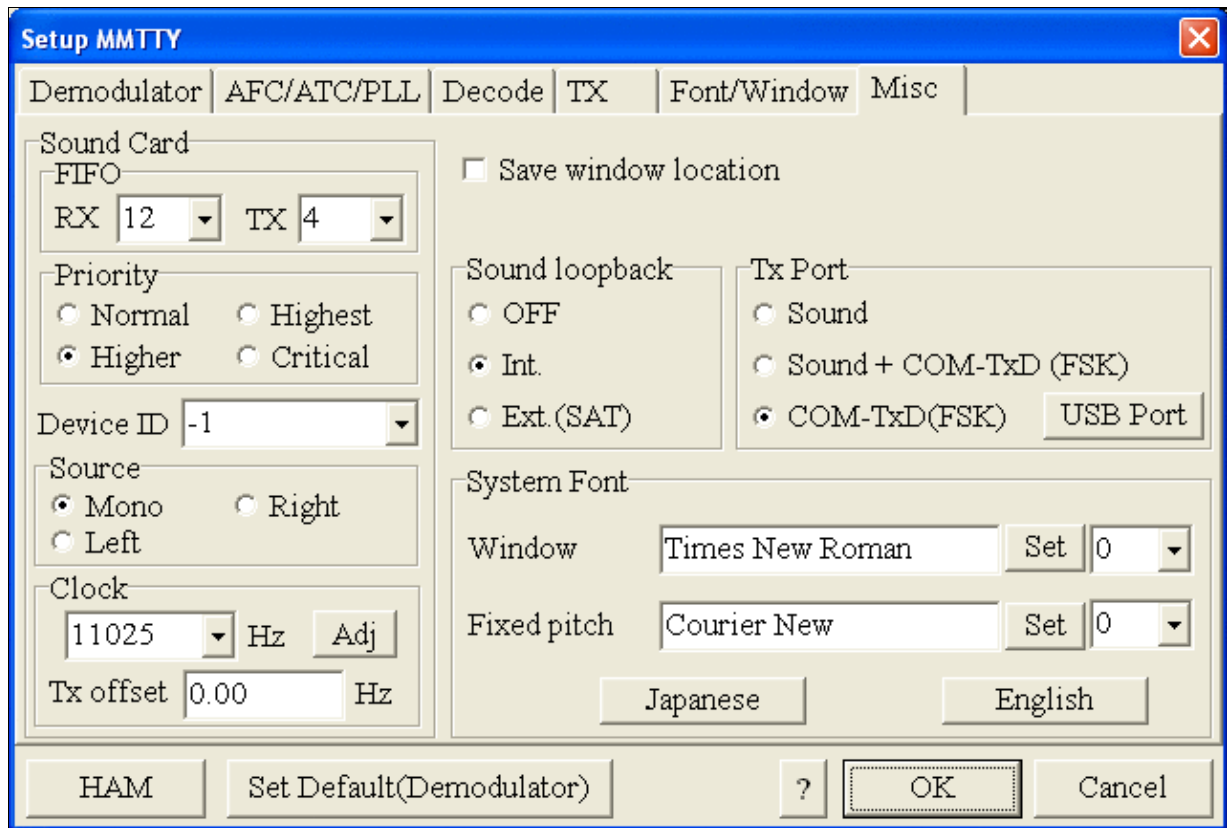

MMTTY Misc settings - FSK is generated via COM8

- Should you have problems generating the FSK signal (especially: keying does work, you hear the RTTY diddle, but no characters are being transmitted), you might have to limit the USB port speed in MMTTY. This setting depends very much on the computer hardware. To limit the USB port speed click on **USB Port** and configure option "C". You can find this setting also in the support documentation of the Microkeyer on the microHAM website.

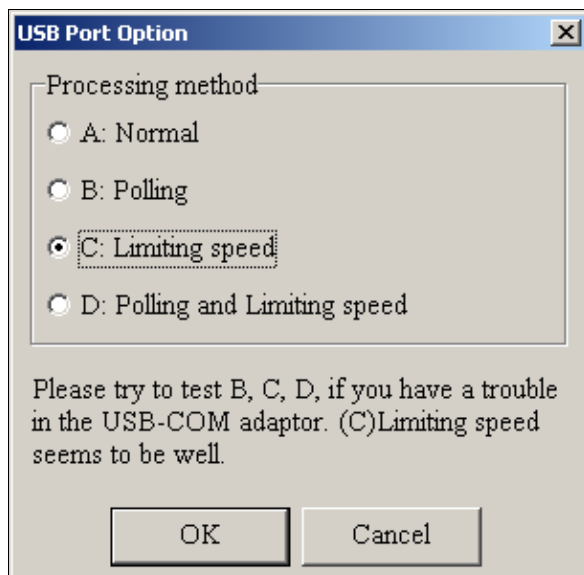

MMTTY USB Port Option - Set only to option C if A does not work for you.

- Exit the Setup screens by pressing the OK button.

We are now ready to do some tests with MMTTY.

- Now take a look at the XY Scope display. It should look like the picture above.
- If you only see a single white point in the middle of the display, this means, that MMTTY gets no audio to process.
  - ◆ Check your cabling. Is your cable connected to Line-in or Mic-in?
  - ◆ Did you select the correct audio device?
  - ◆ Check the level settings for the sound card from the USB Router's Audio Mixer tab. When you move the control up and down you should see an increase and decrease in noise level.



## Win-Test Wiki

Setting the correct audio level on the microHAM CODEC sound card

- Tune across the CW band and check if the XY scope changes when you hear signals. Once you tune across a carrier or CW signal, you should see a vertical ellipse and then a horizontal ellipse or vice versa depending on which direction you tune. The receive section of the screen will show all kinds of clutter.
- Try to find a RTTY signal (not easy on a normal day). Both ellipses should now be perpendicular to each other. See if you can decode RTTY fine. You may have to select proper filters. I use 500 Hz at 8.8 MHz IF and 2.7 kHz at 455 kHz IF.
- Next, press the TX button in the MMTTY application. You should hear the typical RTTY diddle in the monitor of the radio. The XY Scope will also display a clean RTTY signal.
- Type a few characters (including your callsign) and see how they are transmitted.
- Press the TX button one more time to shut off transmission.
- Exit the MMTTY program now.

MMTTY now works perfectly as a stand-alone program. We are now ready for Win-Test.

## Win-Test

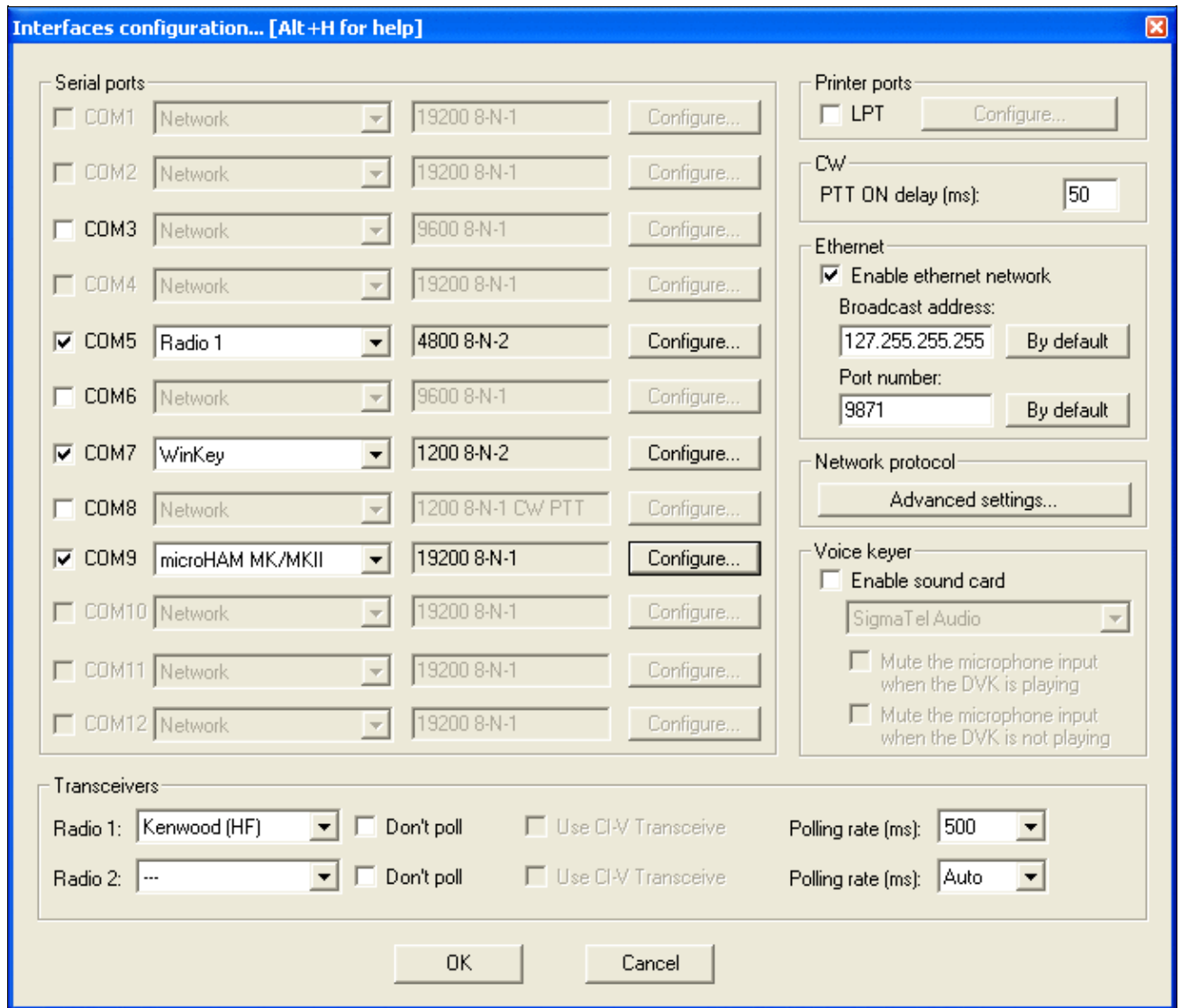

Final steps: Win-Test Interfaces configuration. Note that we only set up three COM ports, no PTT or CW settings are needed as they are all generated/controlled by the MKII.

- Start up Win-Test, create a new Win-Test file for testing.
- Select DXpedition and allow All Modes so you can test all three different modes.
- in the **Options | Configure Interfaces...** menu
  - ◆ configure Radio on COM6
  - ◆ configure Winkey on COM7 using default settings
  - ◆ configure microHAM MK/MKII on COM9
  - ◆ untag Win-Test's internal Voice Keyer
- Go to Configure MMTTY.EXE startup path as described in the [RTTY section of this manual](#) if you are planning for RTTY operation

We are now ready to operate the contest.

## Namespaces

- [Page](#)
- [Discussion](#)

## Variants

## Views

- [Read](#)
- [View source](#)
- [View history](#)

## More

- This page was last edited on 21 September 2015, at 22:27.
- [Privacy policy](#)
- [About Win-Test Wiki](#)
- [Disclaimers](#)



# BestPractice7

From Win-Test Wiki

[Jump to navigation](#) [Jump to search](#)

## Contents

- [1 Setting up the Yaesu FTDX-101](#)
- [2 Yaesu FTDX-101](#)
- [3 MMTTY Setup](#)
- [4 MMTTY Test](#)
- [5 Win-Test](#)

## Setting up the Yaesu FTDX-101

This article is a step by step approach describing how to set up an Yaesu FTDX-101 using the built-in USB interface. This article covers the set-up of CW and RTTY operation in several steps.

Support for the Yaesu FTDX-101 was implemented WinTest 4.30. Be sure, you are running a current version of WinTest.

First set up the FTDX-101 for CAT communication and CW operation:

- Press the [FUNC] key
- Use touch and [MULTI] knob to select
- Press the [FUNC] key to save changes
- Press the [FUNC] key to exit the menu

Check and if necessary change these values in the GENERAL menu

- CAT RATE -> 38400bps
- CAT TIME OUT TIMER -> 1000ms
- CAT RTS -> OFF
- RS232C RATE -> 38400bps

Check and if necessary, change these values in the CW SETTING menu

- CW AUTO MODE -> OFF
- CW BK-IN TYPE -> SEMI
- PC KEYING -> DTR

OPERATION SETTING	
<b>GENERAL</b>	<b>GENERAL</b>
RX DSP	TUNER SELECT <input type="button" value="INT"/>
TX AUDIO	232C RATE <input type="text" value="38400bps"/>
TX GENERAL	232C TIME OUT TIMER <input type="text" value="10msec"/>
TUNING	CAT RATE <input type="text" value="38400bps"/>
	CAT TIME OUT TIMER <input type="text" value="1000msec"/>
	CAT RTS <input type="button" value="OFF"/> <input type="button" value="ON"/>
	QMB CH <input type="button" value="5ch"/> <input type="text" value="10ch"/>
<b>BACK</b>	



General settings needed for CAT communication

CW SETTING	
<b>MODE CW</b>	<b>MODE CW</b>
KEYER	CW AUTO MODE <input type="button" value="OFF"/> 50M <input type="button" value="ON"/>
DECODE CW	CW BK-IN TYPE <input type="button" value="SEMI"/> <input type="button" value="FULL"/>
	CW BK-IN DELAY <input type="text" value="200msec"/>
	CW WAVE SHAPE <input type="text" value="4msec"/>
	CW FREQ DISPLAY <input type="text" value="PITCH OFFSET"/>
	PC KEYING <input type="text" value="DTR"/>
	QSK DELAY TIME <input type="text" value="15msec"/>
<b>BACK</b>	

CW settings menu

Next, set up the FTDX-101 for RTTY operation:

Check and if necessary change these values

- RTTY OUT SELECT -> MAIN
- RPTT SELECT -> RTS
- POLARITY TX -> NOR
- MARK FREQUENCY -> 1275Hz
- SHIFT FREQUENCY -> 170Hz

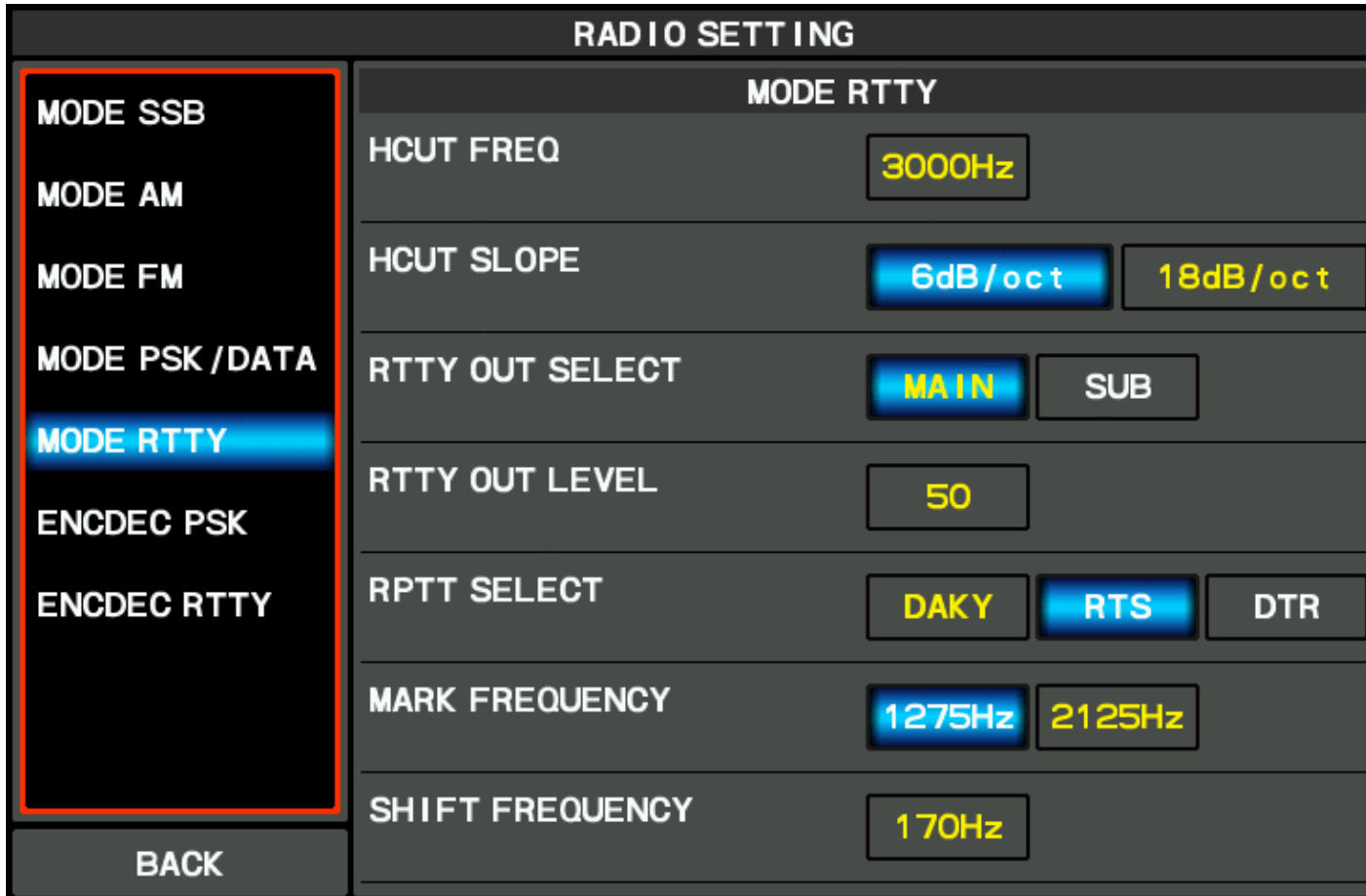

Menu settings needed for RTTY operation



RTTY signals look like this on the FTDX-101

## Yaesu FTDX-101

- Download and install the Yaesu FTDX-101 driver **FTDX101D/MP USB Driver (Virtual COM Port Driver)** from the Yaesu Home Page on your computer. This driver will create virtual COM ports to control the radio and a virtual sound card.
- After installing the driver, you will find two new COM ports COM15 and COM16 on your computer. You need to change them (via the properties context menu) to lower numbers as MMTTY does not "see" these high COM ports. In this case COM3 and COM4 were free so these numbers were chosen, COM3 to be used for CAT control, COM4 for PTT and FSK keying.

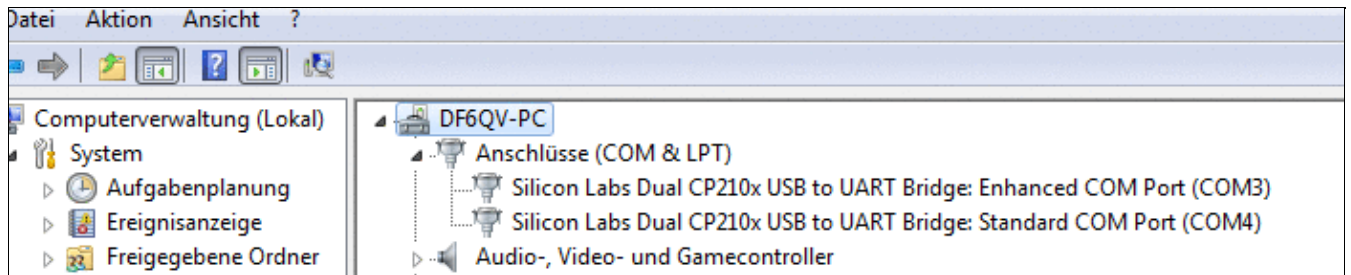

Device Manager displays the new COM 3 and 4 ports after installing the YAESU driver

## MMTTY Setup

- Download and Install MMTTY from [here](#).
- Also download the [EXTFSK](#) package from there. The ZIP file you are looking for is named **ExtFSK106.zip**.
- Extract and copy **ExtFSK.dll** to the MMTTY directory. There is nothing else to do to install this software.
- Start MMTTY
- Activate the XY Scope by selecting the **View (V)** menu item and tagging **XYScope**

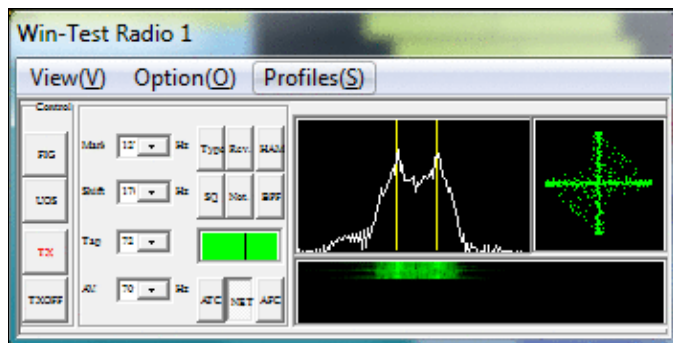

The XY Scope is a practical tuning aid and helps us to visualize the received signals.

- Go to **Option (O) | Setup MMTTY (O) ...**
- Select the Demodulator tab and set it up like in the picture below.



## MMTTY Demodulator settings

- Select the AFC/ATC/PLL tab and make sure AFC is OFF.



MMTTY AFC/ATC/PLL settings. Make sure AFC is off as it will eventually introduce a deviation between TX and RX frequencies.

- Select the TX tab and switch PTT port to EXTFSK. The Radio Command button in this setup screen will allow you to control the radio from within MMTTY. This is not desired in this scenario so make sure it is **not configured** - otherwise Win-Test would not have access to the radio COM port later.

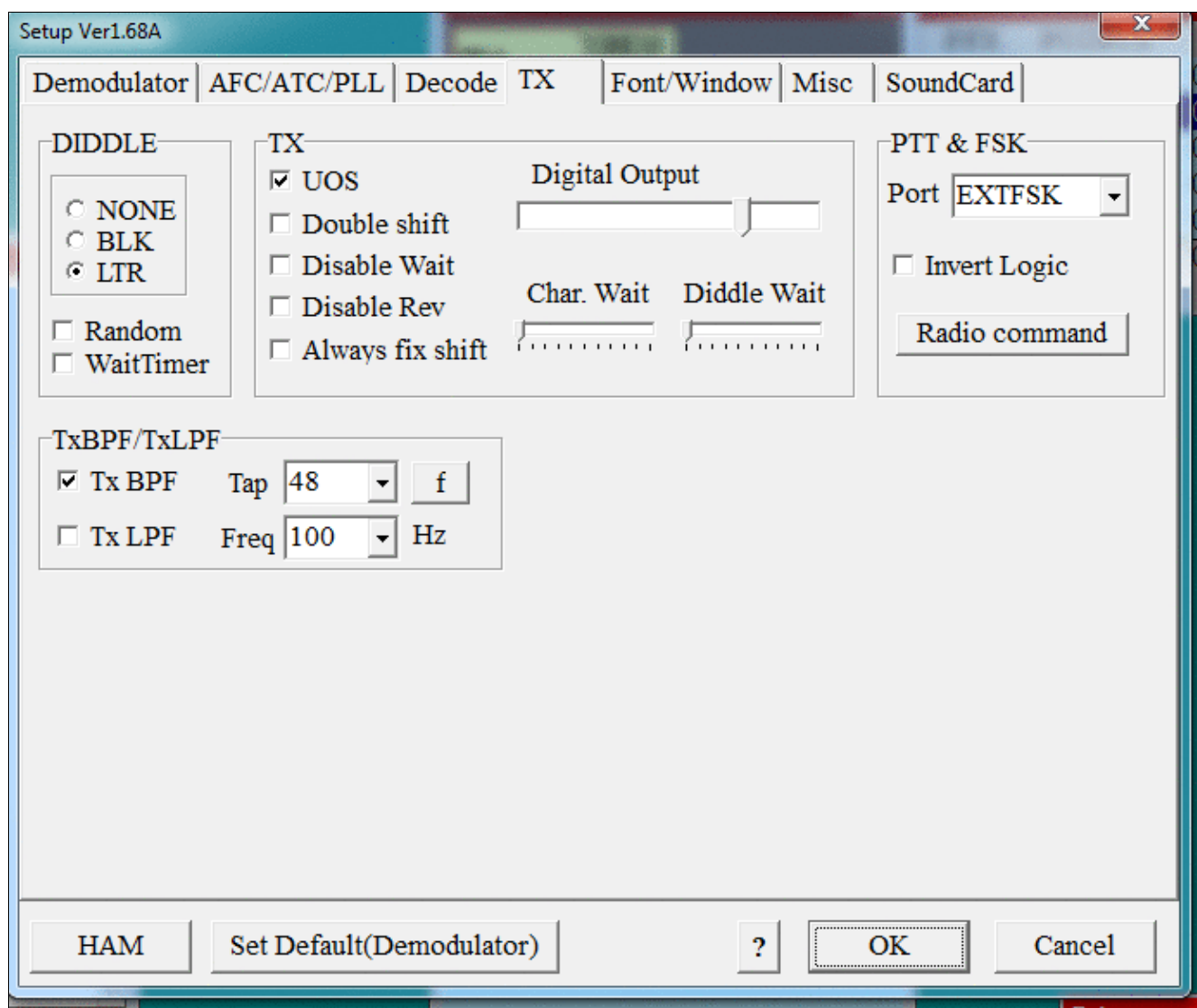

MMTTY Tx settings - FSK and PTT are generated by EXTFSK.dll COM4

- Setup EXTFSK to key COM4, DTR is used for FSK, RTS is used for PTT.

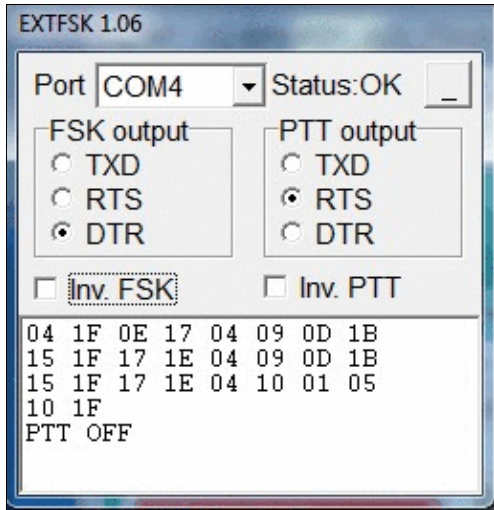

MMTTY Tx settings - FSK and PTT are generated by EXTFSK.dll COM4

- From the Misc tab, select COM-TxD(FSK).



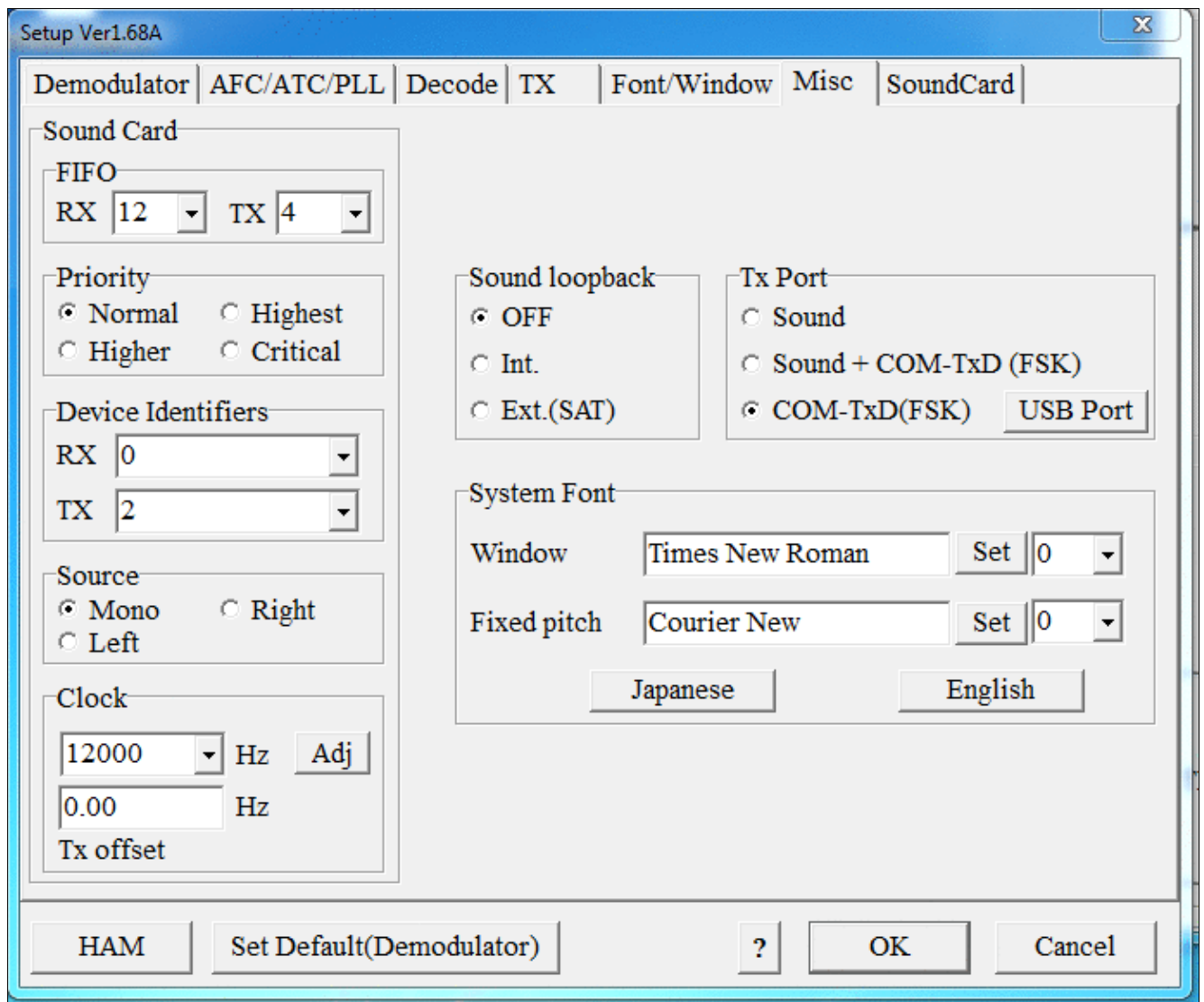

MMTTY Misc settings - FSK is generated by EXTFSK.dll

- Select the SoundCard tab. Since we now have more than one (virtual) sound cards we must make sure we're receiving on the right device. The transmit side is irrelevant here, since we do not transmit through the sound card.

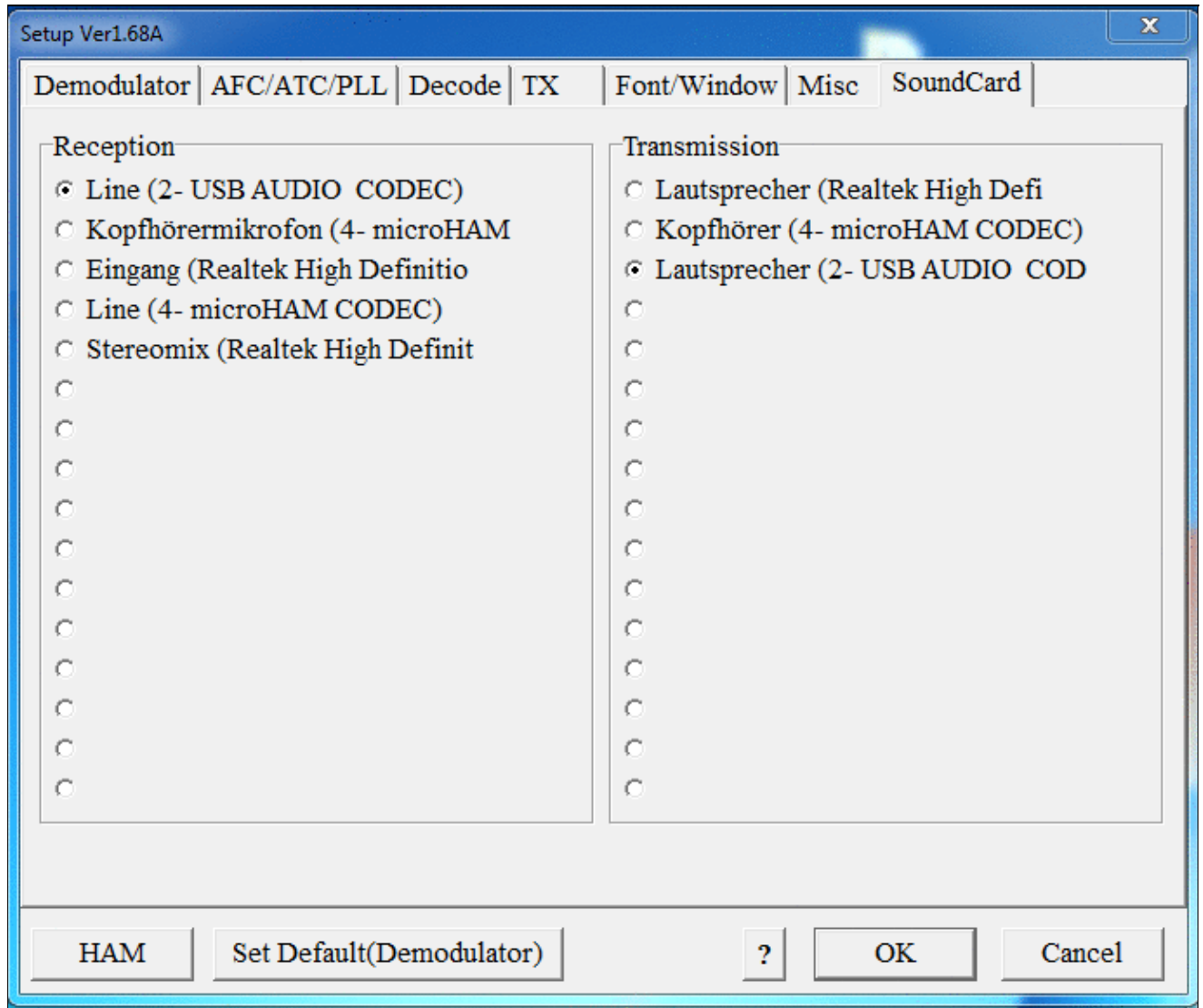

Select the correct sound device for reception. You may see five devices listed depending on the number of sound cards. Only one is the correct card. You may have to experiment a bit.

- Exit the Setup screens by pressing the OK button.

### MMTTY Test

We are now ready to do some tests with MMTTY - still without WinTest being started.

- Set filter bandwidth to 250..500 Hz.
- Now take a look at the XY Scope display. It should look like the picture above.
- If you only see a single white point in the middle of the display, this means, that MMTTY gets no receive audio to process.
  - ◆ Did you select the correct audio device?
- Tune across the CW band and check if the XY scope changes when you hear signals, carriers are best for this test. Once you tune across a carrier or CW signal, you should see a vertical ellipse and then a horizontal ellipse or vice versa depending on which direction you tune. The receive section of the screen will show all kinds of clutter.
  - ◆ Make sure you are not accidentally receiving on your computer's built-in microphone. Clap your hands or whistle to make sure MMTTY does not hear you.
- Try to find a RTTY signal (not easy on a normal day). Both ellipses should now be perpendicular to each other. See if you can decode RTTY fine. You may have to select proper filters. Use the 600 Hz roofing filter at 9 MHz IF and 250 Hz or less on the digital end.
- Next, press the TX button in the MMTTY application. You should hear the typical RTTY diddle in the monitor of the radio. The XY Scope will also display a clean RTTY signal.
- Type a few characters (including your callsign) and see how they are transmitted.
- Press the TX button one more time to shut off transmission.
- Exit the MMTTY program now.

MMTTY now works perfectly as a stand-alone program. We are now ready for Win-Test.

### Win-Test

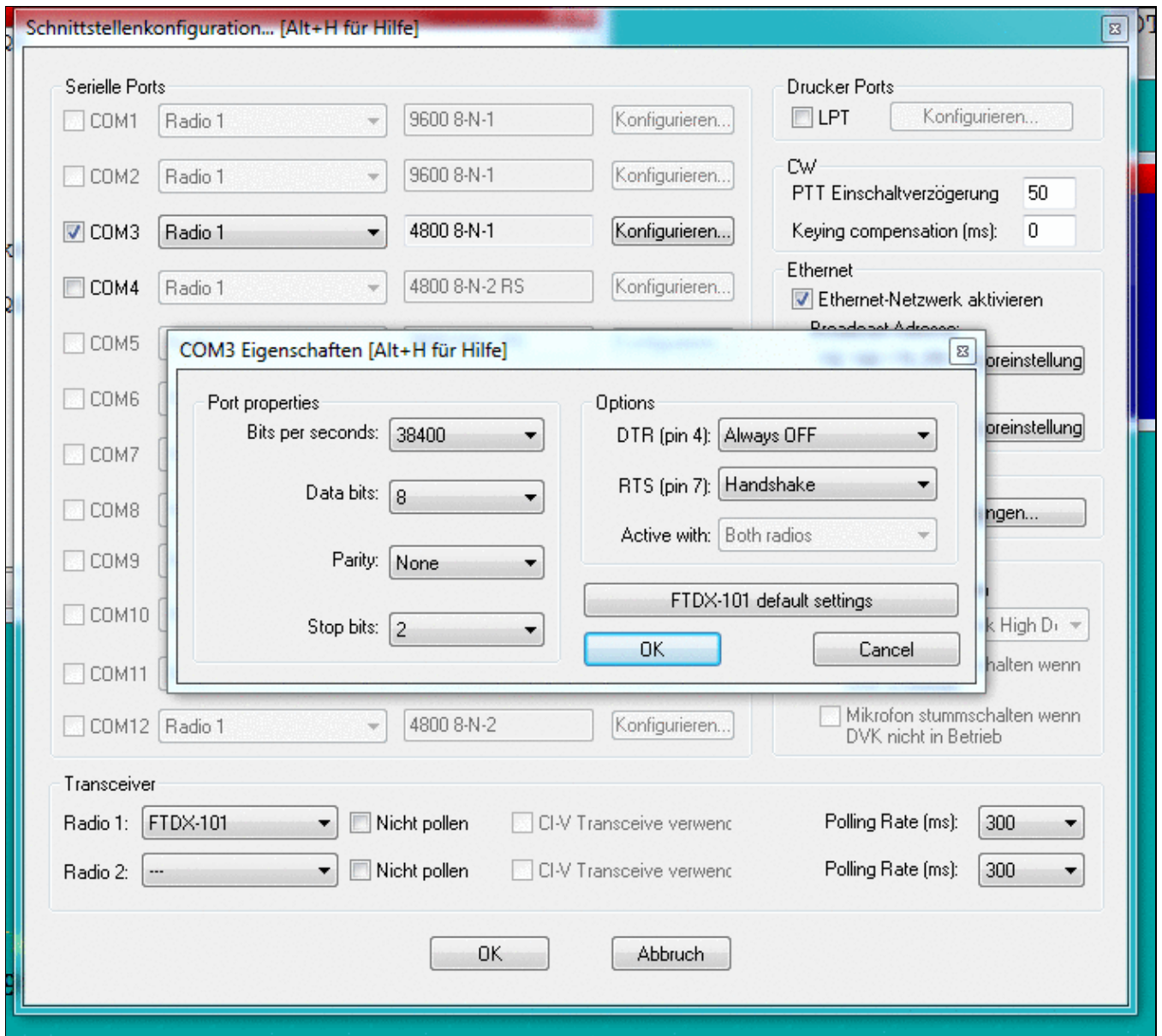

## Win-Test Wiki

Final steps: Win-Test Interfaces configuration. Note that we only set up one COM port, no PTT or FSK settings are needed as they are all generated/controlled by EXTFSK.

- Start up Win-Test, create a new Win-Test file for testing.
- Select DXpedition and allow All Modes so you can test all three different modes.
- in the **Options | Configure Interfaces...** menu
  - ◆ configure Radio on COM3
  - ◆ configure CW on COM4, use DTR for CW keying
- Go to Configure MMTTY.EXE startup path as described in the [RTTY section of this manual](#) if you are planning for RTTY operation

We are now ready to operate the contest.

## Namespaces

- [Page](#)
- [Discussion](#)

## Variants

## Views

- [Read](#)
- [View source](#)
- [View history](#)

## More

- This page was last edited on 6 June 2020, at 08:10.

- [Privacy policy](#)
- [About Win-Test Wiki](#)
- [Disclaimers](#)

-  The logo consists of a small yellow sun icon to the left of the text "Powered By MediaWiki".

# BestPractice7

From Win-Test Wiki

[Jump to navigation](#) [Jump to search](#)

## Contents

- [1 Setting up the Yaesu FTDX-101](#)
- [2 Yaesu FTDX-101](#)
- [3 MMTTY Setup](#)
- [4 MMTTY Test](#)
- [5 Win-Test](#)

## Setting up the Yaesu FTDX-101

This article is a step by step approach describing how to set up an Yaesu FTDX-101 using the built-in USB interface. This article covers the set-up of CW and RTTY operation in several steps.

Support for the Yaesu FTDX-101 was implemented WinTest 4.30. Be sure, you are running a current version of WinTest.

First set up the FTDX-101 for CAT communication and CW operation:

- Press the [FUNC] key
- Use touch and [MULTI] knob to select
- Press the [FUNC] key to save changes
- Press the [FUNC] key to exit the menu

Check and if necessary change these values in the GENERAL menu

- CAT RATE -> 38400bps
- CAT TIME OUT TIMER -> 1000ms
- CAT RTS -> OFF
- RS232C RATE -> 38400bps

Check and if necessary, change these values in the CW SETTING menu

- CW AUTO MODE -> OFF
- CW BK-IN TYPE -> SEMI
- PC KEYING -> DTR

**OPERATION SETTING**

GENERAL	
<b>GENERAL</b>	TUNER SELECT <span style="float: right;"><b>INT</b></span>
RX DSP	232C RATE <span style="float: right;">38400bps</span>
TX AUDIO	232C TIME OUT TIMER <span style="float: right;"><b>10msec</b></span>
TX GENERAL	CAT RATE <span style="float: right;">38400bps</span>
TUNING	CAT TIME OUT TIMER <span style="float: right;">1000msec</span>
	CAT RTS <span style="float: right;"><b>OFF</b> <b>ON</b></span>
	QMB CH <span style="float: right;"><b>5ch</b> 10ch</span>

**BACK**

General settings needed for CAT communication

CW SETTING	
<b>MODE CW</b>	<b>MODE CW</b>
KEYER	CW AUTO MODE <input type="button" value="OFF"/> 50M <input type="button" value="ON"/>
DECODE CW	CW BK-IN TYPE <input type="button" value="SEMI"/> <input type="button" value="FULL"/>
	CW BK-IN DELAY <input type="text" value="200msec"/>
	CW WAVE SHAPE <input type="text" value="4msec"/>
	CW FREQ DISPLAY <input type="text" value="PITCH OFFSET"/>
	PC KEYING <input type="text" value="DTR"/>
	QSK DELAY TIME <input type="text" value="15msec"/>
<b>BACK</b>	



CW settings menu

Next, set up the FTDX-101 for RTTY operation:

Check and if necessary change these values

- RTTY OUT SELECT -> MAIN
- RPTT SELECT -> RTS
- POLARITY TX -> NOR
- MARK FREQUENCY -> 1275Hz
- SHIFT FREQUENCY -> 170Hz

RADIO SETTING	
MODE SSB MODE AM MODE FM MODE PSK / DATA <b>MODE RTTY</b> ENCDEC PSK ENCDEC RTTY BACK	<b>MODE RTTY</b> HCUT FREQ <span style="float: right;">3000Hz</span>
	HCUT SLOPE <span style="float: right;">6dB/oct</span> <span style="float: right;">18dB/oct</span>
	RTTY OUT SELECT <span style="float: right;">MAIN</span> <span style="float: right;">SUB</span>
	RTTY OUT LEVEL <span style="float: right;">50</span>
	RPTT SELECT <span style="float: right;">DAKY</span> <span style="float: right;">RTS</span> <span style="float: right;">DTR</span>
	MARK FREQUENCY <span style="float: right;">1275Hz</span> <span style="float: right;">2125Hz</span>
	SHIFT FREQUENCY <span style="float: right;">170Hz</span>

Menu settings needed for RTTY operation



RTTY signals look like this on the FTDX-101

## Yaesu FTDX-101

- Download and install the Yaesu FTDX-101 driver **FTDX101D/MP USB Driver (Virtual COM Port Driver)** from the Yaesu Home Page on your computer. This driver will create virtual COM ports to control the radio and a virtual sound card.
- After installing the driver, you will find two new COM ports COM15 and COM16 on your computer. You need to change them (via the properties context menu) to lower numbers as MMTTY does not "see" these high COM ports. In this case COM3 and COM4 were free so these numbers were chosen, COM3 to be used for CAT control, COM4 for PTT and FSK keying.

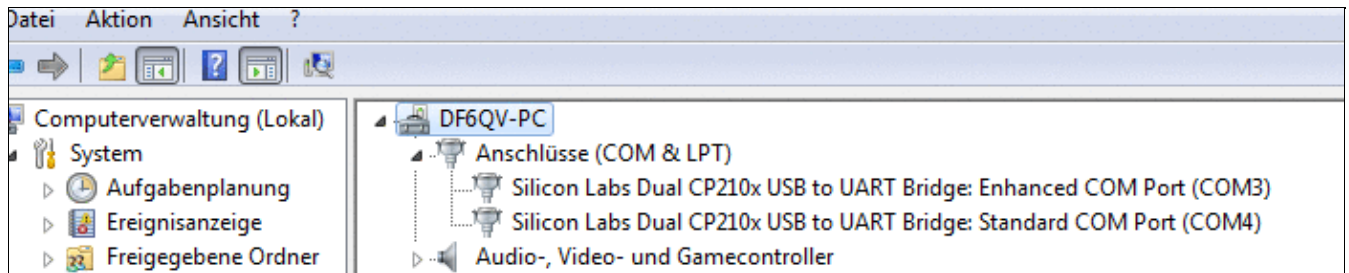

Device Manager displays the new COM 3 and 4 ports after installing the YAESU driver

## MMTTY Setup

- Download and Install MMTTY from [here](#).
- Also download the [EXTFSK](#) package from there. The ZIP file you are looking for is named **ExtFSK106.zip**.
- Extract and copy **ExtFSK.dll** to the MMTTY directory. There is nothing else to do to install this software.
- Start MMTTY
- Activate the XY Scope by selecting the **View (V)** menu item and tagging **XYScope**

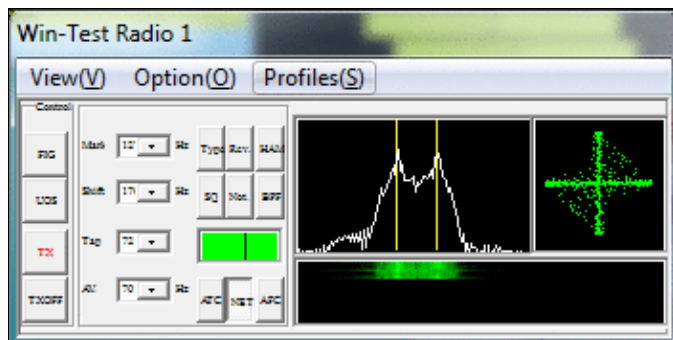

The XY Scope is a practical tuning aid and helps us to visualize the received signals.

- Go to **Option (O) | Setup MMTTY (O) ...**
- Select the Demodulator tab and set it up like in the picture below.



## MMTTY Demodulator settings

- Select the AFC/ATC/PLL tab and make sure AFC is OFF.

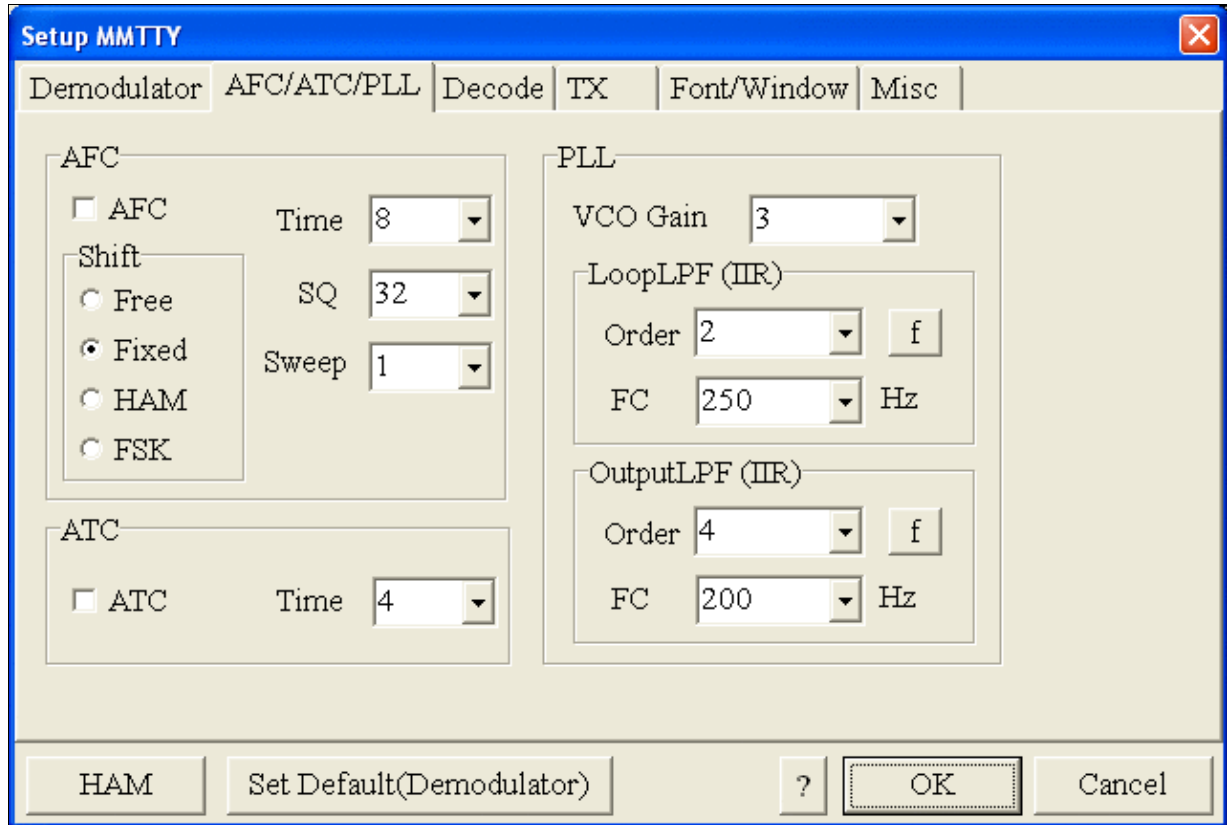

MMTTY AFC/ATC/PLL settings. Make sure AFC is off as it will eventually introduce a deviation between TX and RX frequencies.

- Select the TX tab and switch PTT port to EXTFSK. The Radio Command button in this setup screen will allow you to control the radio from within MMTTY. This is not desired in this scenario so make sure it is **not configured** - otherwise Win-Test would not have access to the radio COM port later.

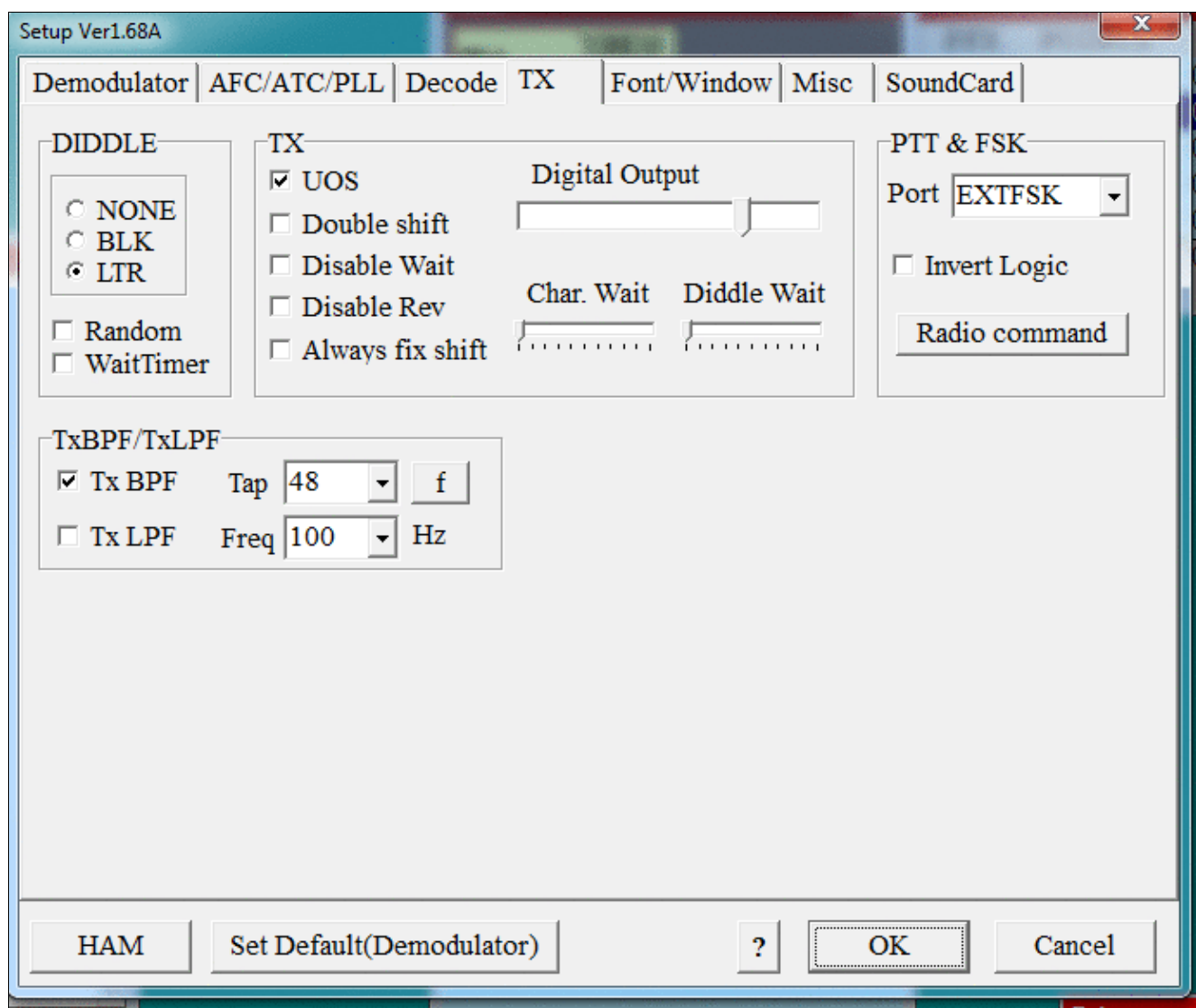

MMTTY Tx settings - FSK and PTT are generated by EXTFSK.dll COM4

- Setup EXTFSK to key COM4, DTR is used for FSK, RTS is used for PTT.

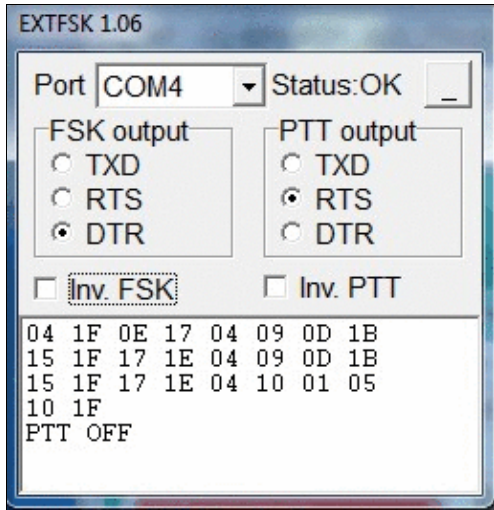

MMTTY Tx settings - FSK and PTT are generated by EXTFSK.dll COM4

- From the Misc tab, select COM-TxD(FSK).

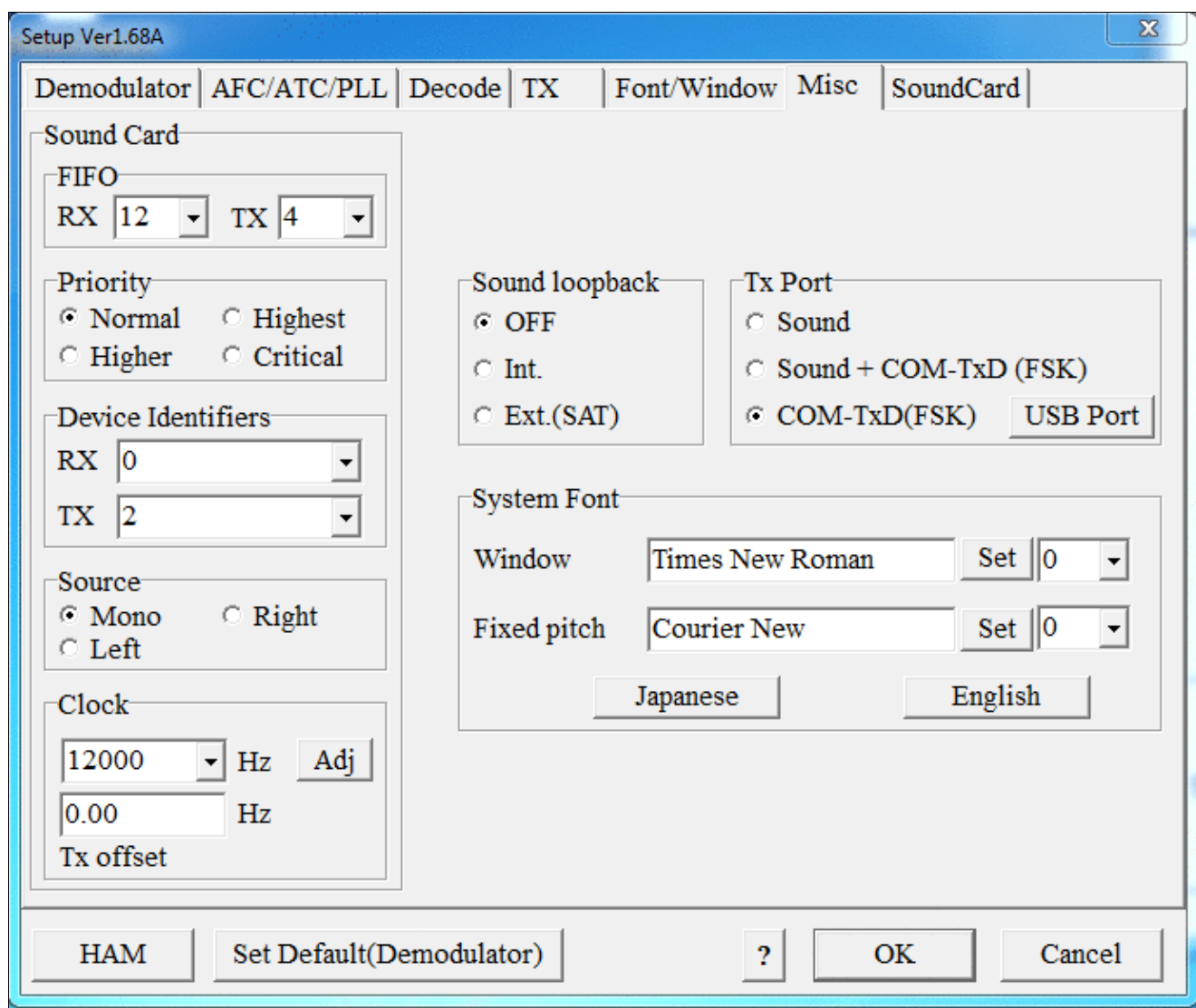



MMTTY Misc settings - FSK is generated by EXTFSK.dll

- Select the SoundCard tab. Since we now have more than one (virtual) sound cards we must make sure we're receiving on the right device. The transmit side is irrelevant here, since we do not transmit through the sound card.

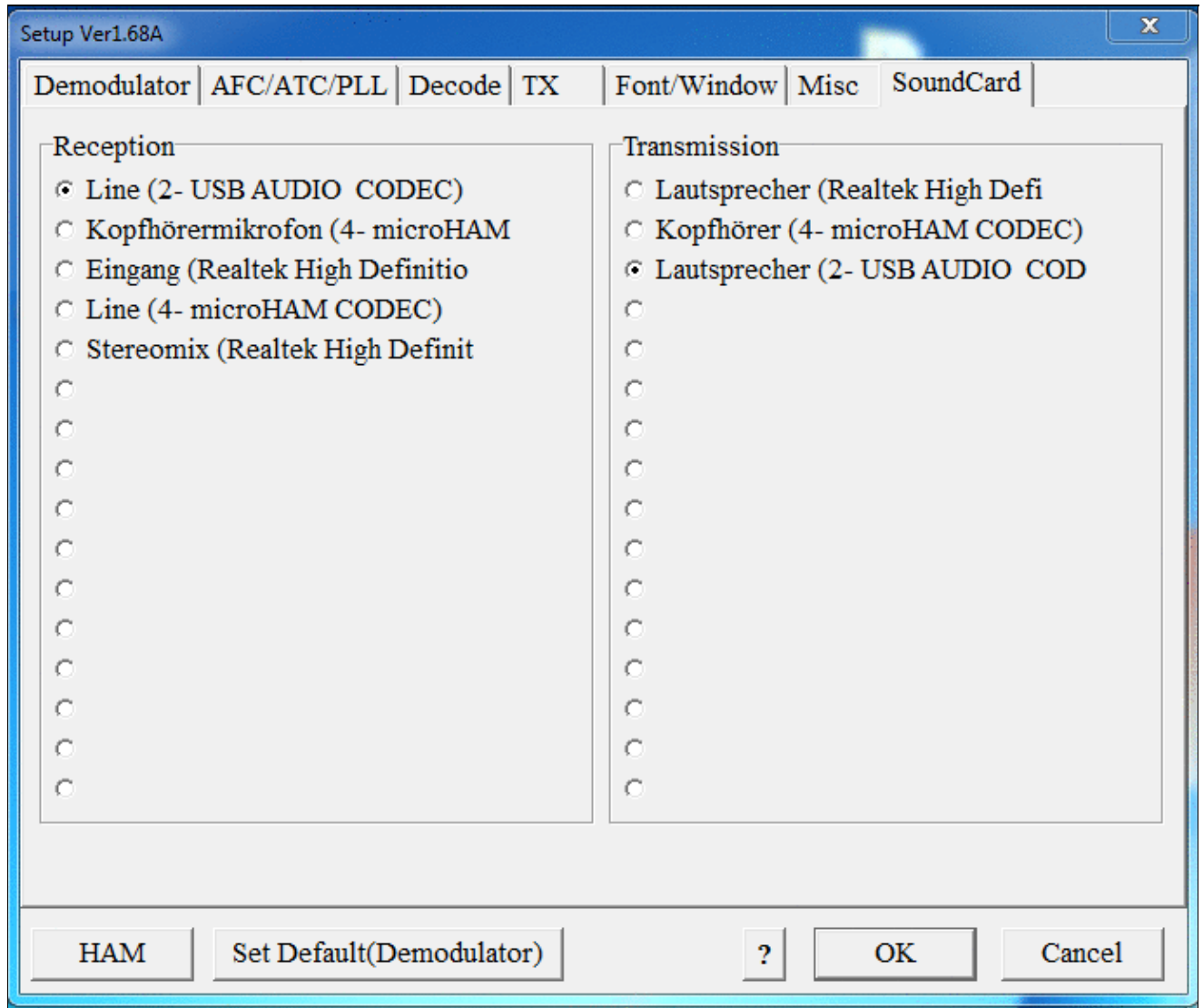

Select the correct sound device for reception. You may see five devices listed depending on the number of sound cards. Only one is the correct card. You may have to experiment a bit.

- Exit the Setup screens by pressing the OK button.

### MMTTY Test

We are now ready to do some tests with MMTTY - still without WinTest being started.

- Set filter bandwidth to 250..500 Hz.
- Now take a look at the XY Scope display. It should look like the picture above.
- If you only see a single white point in the middle of the display, this means, that MMTTY gets no receive audio to process.
  - ◆ Did you select the correct audio device?
- Tune across the CW band and check if the XY scope changes when you hear signals, carriers are best for this test. Once you tune across a carrier or CW signal, you should see a vertical ellipse and then a horizontal ellipse or vice versa depending on which direction you tune. The receive section of the screen will show all kinds of clutter.
  - ◆ Make sure you are not accidentally receiving on your computer's built-in microphone. Clap your hands or whistle to make sure MMTTY does not hear you.
- Try to find a RTTY signal (not easy on a normal day). Both ellipses should now be perpendicular to each other. See if you can decode RTTY fine. You may have to select proper filters. Use the 600 Hz roofing filter at 9 MHz IF and 250 Hz or less on the digital end.
- Next, press the TX button in the MMTTY application. You should hear the typical RTTY diddle in the monitor of the radio. The XY Scope will also display a clean RTTY signal.
- Type a few characters (including your callsign) and see how they are transmitted.
- Press the TX button one more time to shut off transmission.
- Exit the MMTTY program now.

MMTTY now works perfectly as a stand-alone program. We are now ready for Win-Test.

### Win-Test

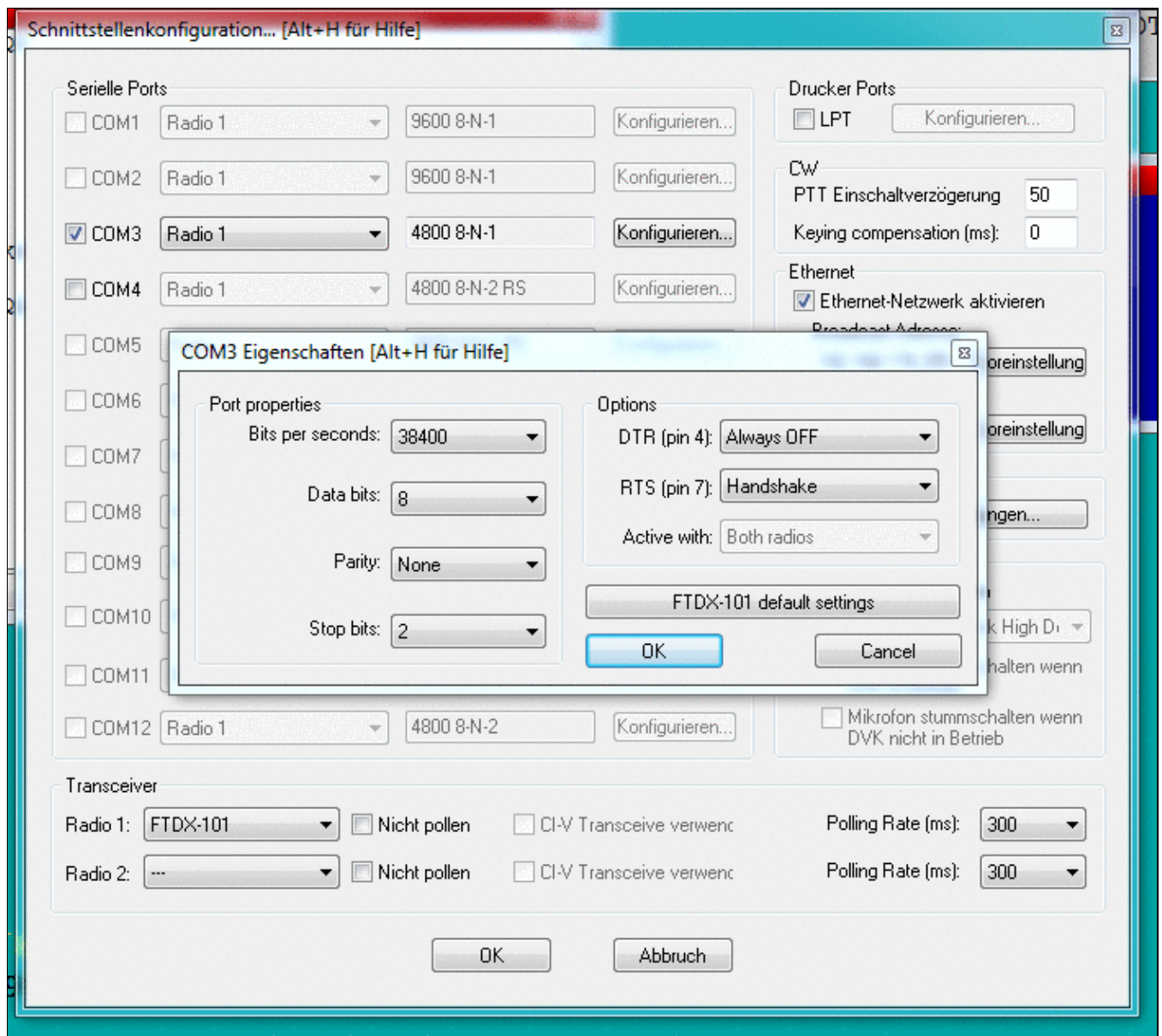

## Win-Test Wiki

Final steps: Win-Test Interfaces configuration. Note that we only set up one COM port, no PTT or FSK settings are needed as they are all generated/controlled by EXTFSK.

- Start up Win-Test, create a new Win-Test file for testing.
- Select DXpedition and allow All Modes so you can test all three different modes.
- in the **Options | Configure Interfaces...** menu
  - ◆ configure Radio on COM3
  - ◆ configure CW on COM4, use DTR for CW keying
- Go to Configure MMTTY.EXE startup path as described in the [RTTY section of this manual](#) if you are planning for RTTY operation

We are now ready to operate the contest.

## Namespaces

- [Page](#)
- [Discussion](#)

## Variants

## Views

- [Read](#)
- [View source](#)
- [View history](#)

## More

- This page was last edited on 6 June 2020, at 08:10.

- [Privacy policy](#)
- [About Win-Test Wiki](#)
- [Disclaimers](#)

-  The logo consists of a blue square with a white sun icon on the left, followed by the text "Powered By" in a small font and "MediaWiki" in a larger font, all within a thin black border.

# BestPractice8

From Win-Test Wiki

[Jump to navigation](#) [Jump to search](#)

## Contents

- [1 Setting up the ICOM IC-7410 + microKeyer MKII](#)
- [2 ICOM IC-7410](#)
- [3 microHAM MKII](#)
- [4 microHAM USB Device Router](#)
- [5 MMTTY](#)
- [6 Win-Test](#)

## Setting up the ICOM IC-7410 + microKeyer MKII

This article is a step by step approach describing how to set up an ICOM IC-7410 radio and a microHAM microKeyer II interface. The MKII is a complex device integrating a CW-Keyer, CW and FSK keying, PTT control (including a delayed PTT), radio control and a sound card, a digital voice keyer which allows to control up to ten audio memories and different audio switching scenarios. This article covers the set-up of CW, RTTY and SSB in several steps.

Support for the ICOM IC-7410 implemented WinTest 4.12. Be sure, you are running a current version of WinTest.

[BestPractice1](#) article describes a slightly simpler set-up with the Microham USB Interface II. [BestPractice4](#) article describes a slightly simpler set-up with the microHAM microKeyer. Please see there for background information about RTTY and MMTTY in general.

## ICOM IC-7410

- In the RTTY mode, push [MENU] to display the `M1` screen (Menu 1)
- Push [RTTY](F-4) to display the `RTTY` screen
- Push [SET](F-5) to enter the RTTY Set mode
- Push [Y](F-1) or [Z](F-2) to select the desired item
  - ◆ Set *RTTY Mark Freq* to 1275 (use VFO knob to step through available options)
  - ◆ Set *RTTY Shift Width* to 170 (use VFO knob to step through available options)
  - ◆ Set Keying Pol to NORMAL (use VFO knob to step through available options)
- Push [MENU] to save, and return to the `RTTY` screen
- Push [MENU] again to return to the `M1` screen

To test the settings, put the radio to FSK mode, push the MONITOR button, make sure MONI GAIN is set to the 12 o'clock position and then switch the radio to transmit by pressing TRANSMIT. You should now hear a 1275 Hz tone.

**Note:** The built-in RTTY decoder in the IC-7410 only works with High Tones selected. I personally prefer listening to low tones and so this article focusses on 1275 Hz/1445 Hz, but actually it's up to you.

## microHAM MKII

- Connect the MKII to a 12V DC source. Optionally you can feed the MKII via the DB37 cable by setting the jumper inside the MK-II very close to the 13.8 V DC jack.
- Connect a footswitch to the FOOTSW connector of the MKII.
- Connect your microphone or headset to the short RJ45 cable that goes into MIC on the MKII (this connector does also provide the 8V DC voltage on pin 5 for your electret microphone - for ICOM you have to enable this; do not try to use dynamic microphones with ICOM radios, this will fail - audio level is too low).
- Connect the microHAM MKII to your radio and computer.
  - ◆ On the radio side there will be five connections: KEY, RTTY, PACKET, CAT, AF OUT and microphone.
  - ◆ On the computer side there will be only a single connection: USB. I had to use a ferrite core to get rid of RF noise.
- Install the microHAM software if you haven't done so already. There are two steps to it:
  - ◆ Installing the device driver - if you have several microHAM devices you will have to do this once for each of them.
  - ◆ Installing the USB Device Router - this software only needs to be installed once. It is identical on all microHAM products.

**Note:** If you had previously installed the USB Device Router with another microHAM product, it will come up with a new tab for the new hardware connected.

## microHAM USB Device Router

- Set up the Device Router
- Go to the Ports Tab
  - ◆ Create four virtual COM ports: COM6, COM7, COM8 and COM9. Note: The absolute port numbers do not matter. The key is consistency - the same port number must be used for a specific function every time it is used.
  - ◆ Configure Radio on COM6
  - ◆ Press the **Set** button to the right of the radio port configuration and select Icom IC-7410. MKII will assign different Audio Routing and PTT scenarios if it knows what frequency and mode the radio is set. This is why we have to do it.
  - ◆ You should now see the current frequency of the radio display in the **Ports** tab
  - ◆ Configure Winkey COM7 using Winkey default settings
  - ◆ Configure FSK on COM8. Make sure you tick the PTT tag
  - ◆ Configure Control on COM9. This will allow controlling the MKII, especially the built-in DVK from Win-Test.

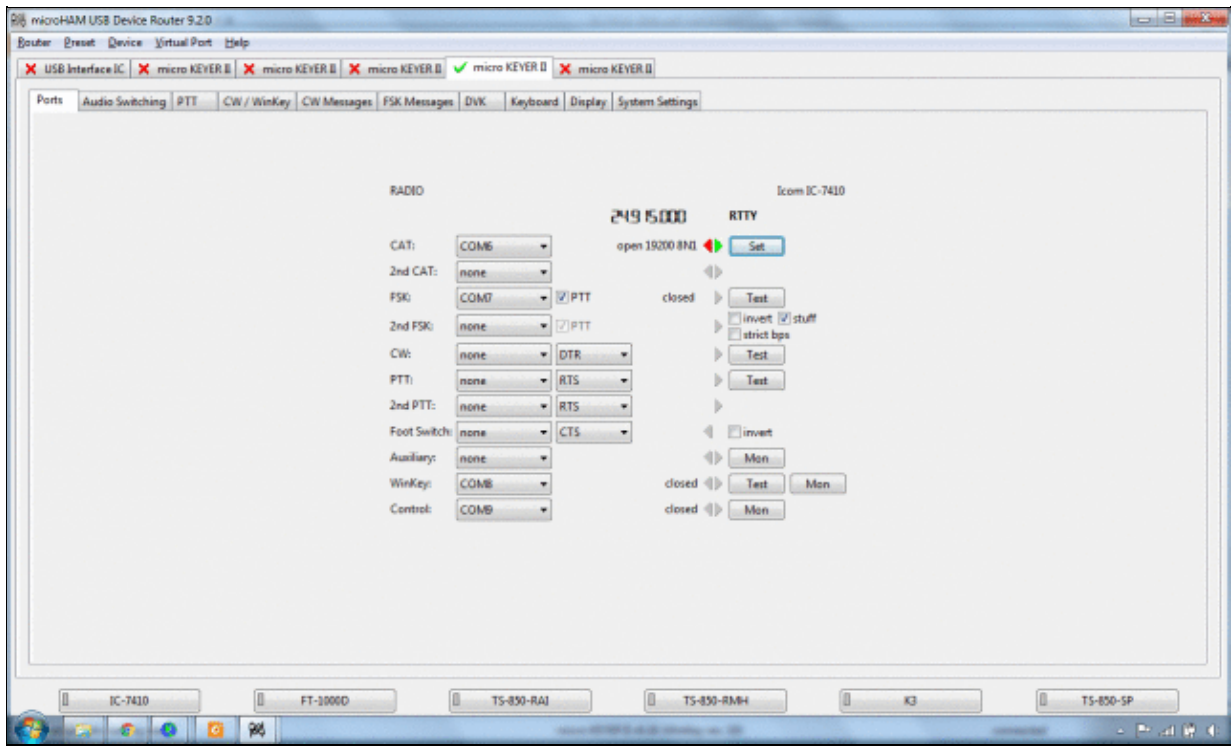

microHAM MKII Ports setup. We use COM6, 7, 8 and 9 to control different properties of the MKII.

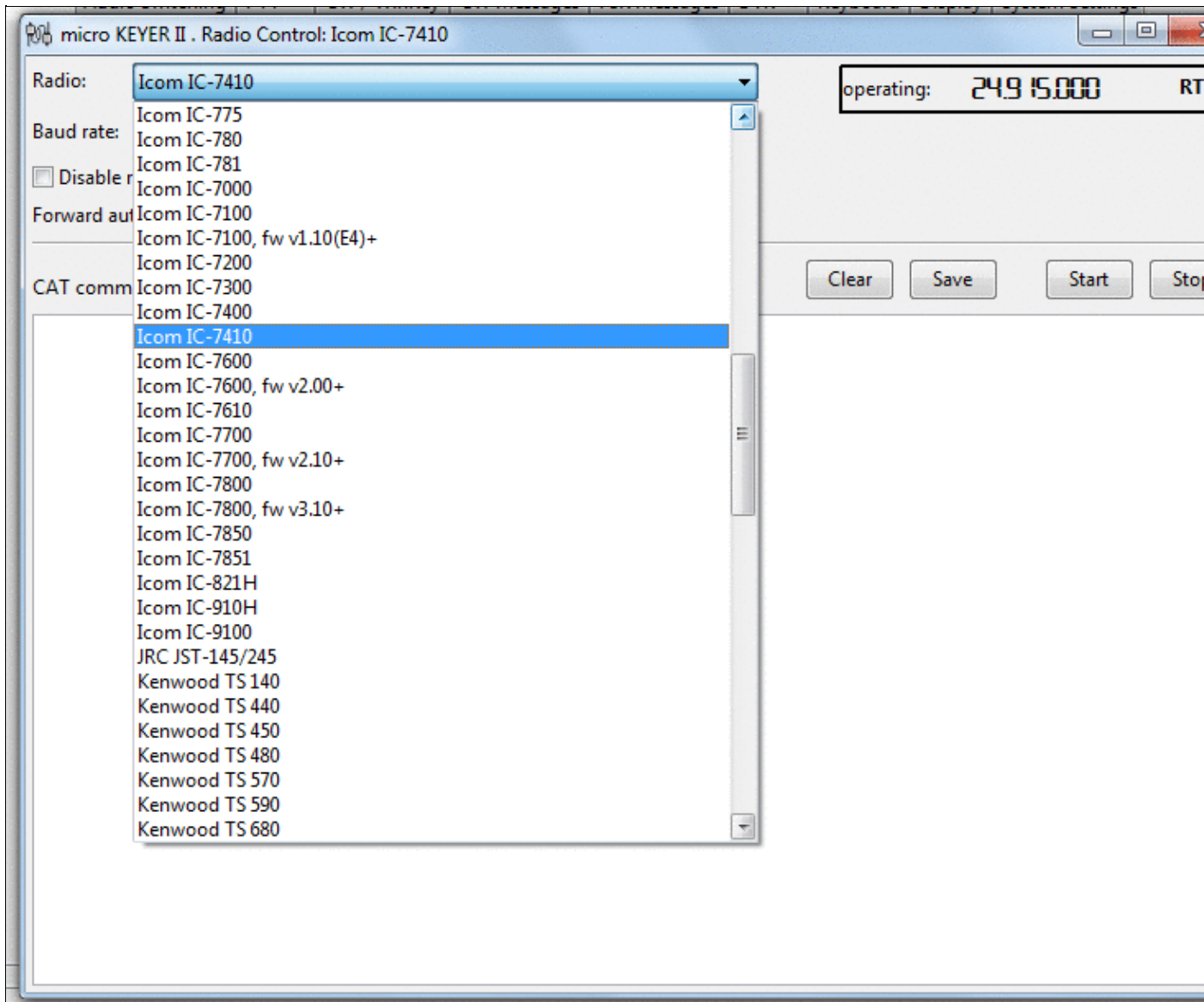



Make sure, the MKII knows about your radio so it can control Audio Switching and PTT depending on the selected mode.

- Go to the Audio Switching Tab
  - ◆ Configure the Audio Switching as shown below.
    - ◇ Have the radio on LSB or USB. Select "Microphone jack, DVK control".
    - ◇ Now switch the radio to FSK mode. Select "line input (rear)".

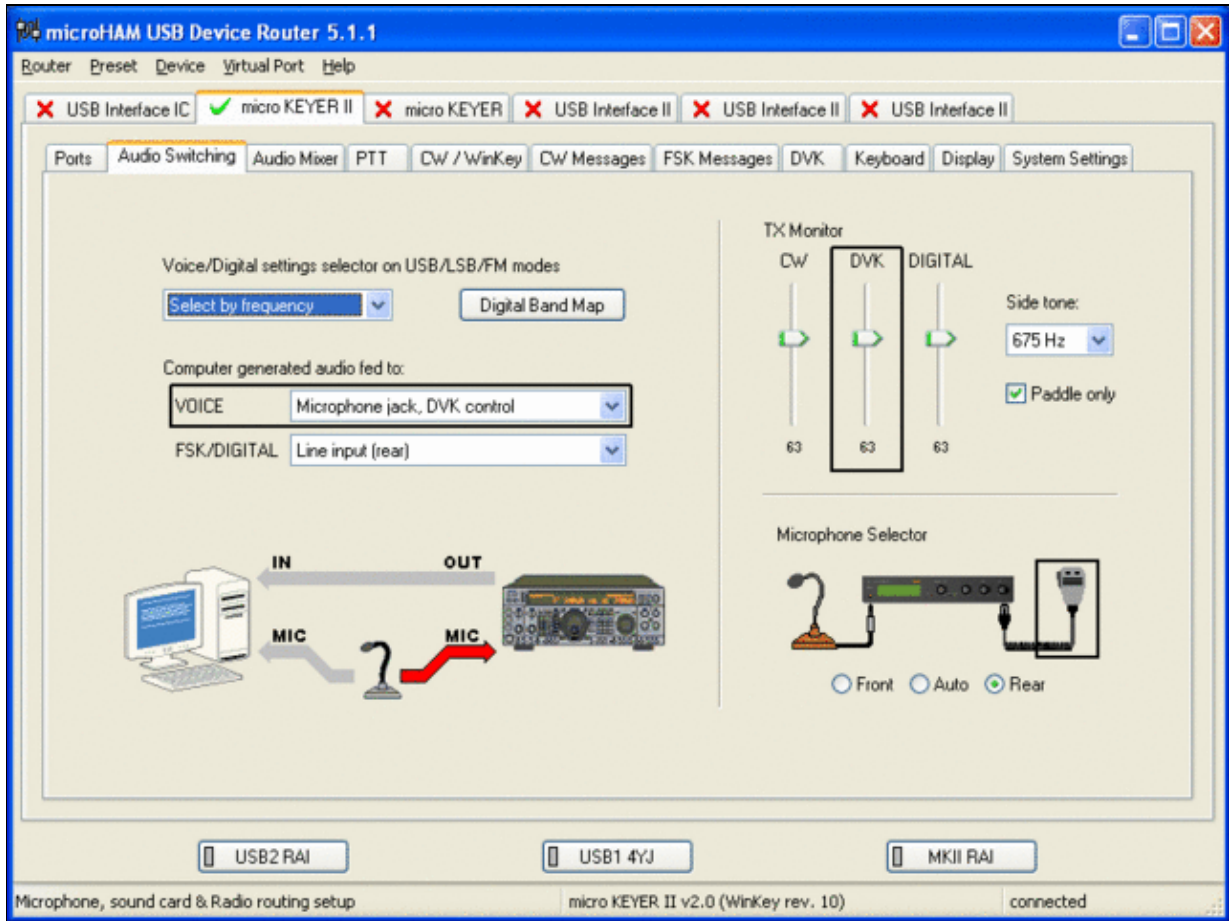

## microHAM MKII Audio Switching setup.

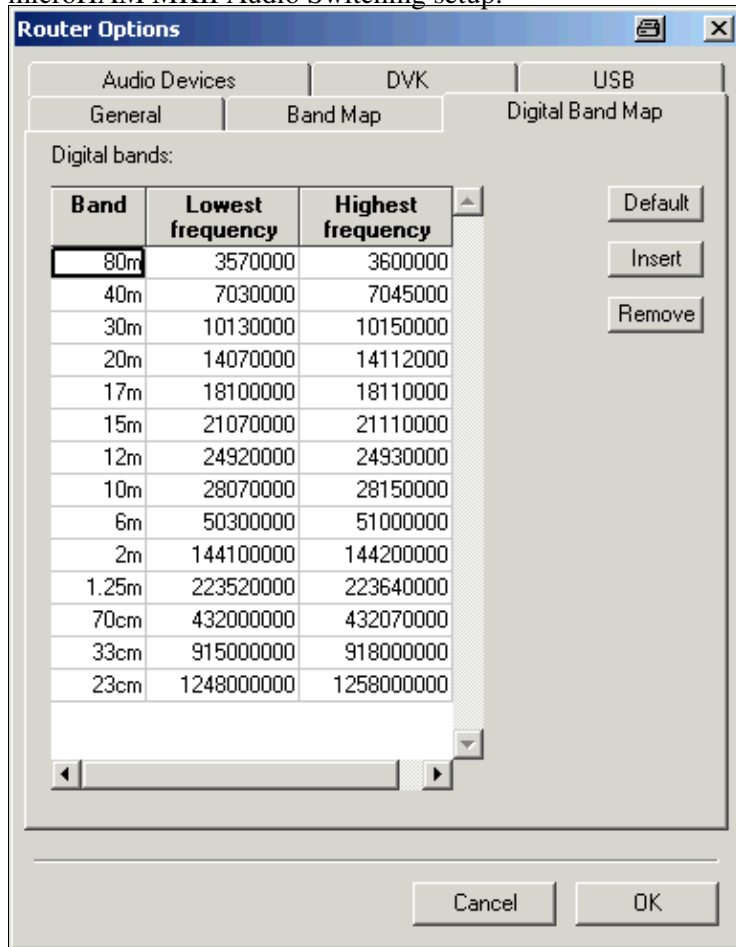

## Win-Test Wiki

This is the digital band map which is used to decide which mode the radio is operating in. With Yaesu radios, MKII retrieves the mode directly from the communication protocol, so this map is not used.

- Go to the Audio Mixing Tab
  - ◆ Select the microHAM CODEC sound device

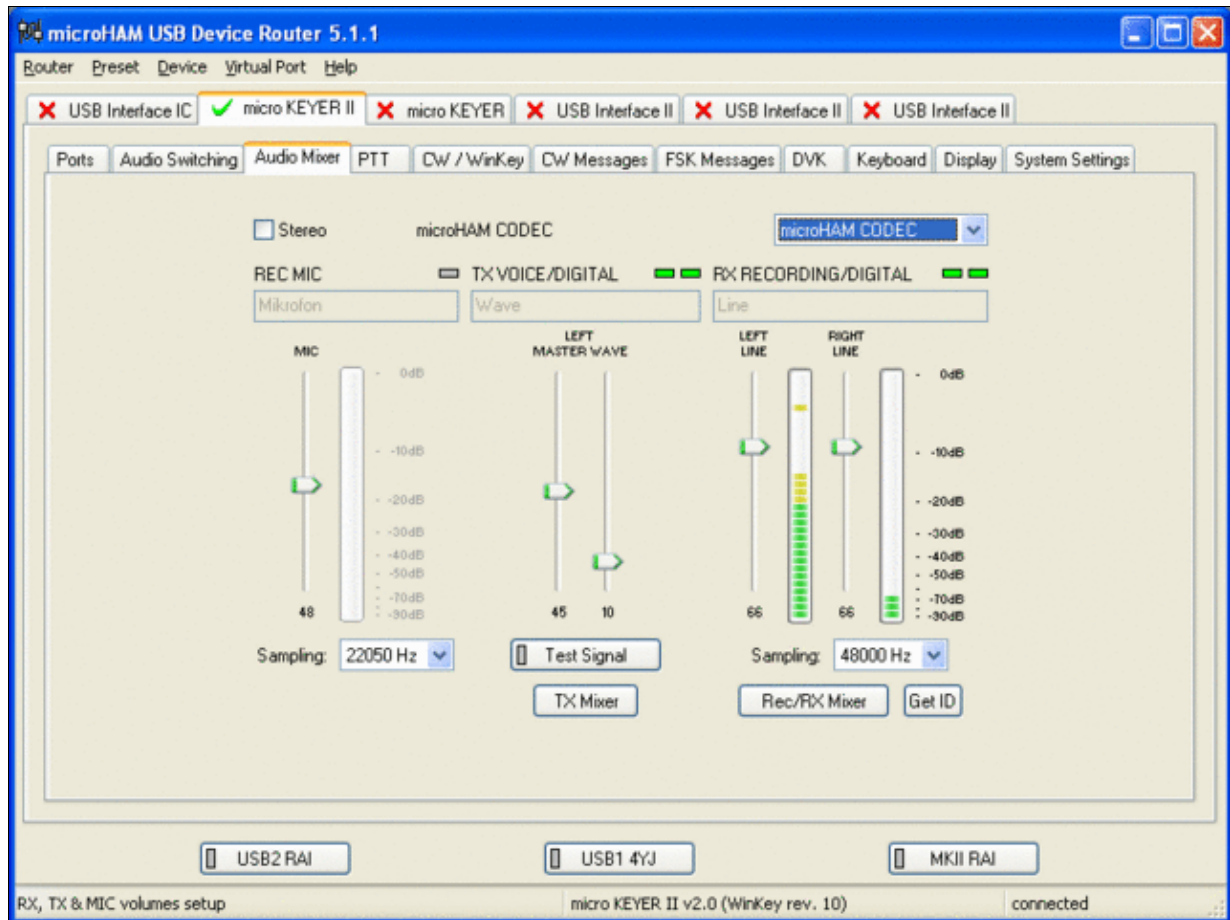

Using the built-in sound card requires selecting it here.

- Go to the PTT Tab
  - ◆ In the PTT selector, select "semi break in" for CW, "PTT1" for Voice and "PTT2" for Digital Modes. This will allow using QSK or VOX operation on CW (which I prefer over the microHAM doing all the switching - but mind hot switching PA relays!). Selecting PTT1 for voice operation will route audio input to the front Mic connector of the radio - avoiding audio level problems.

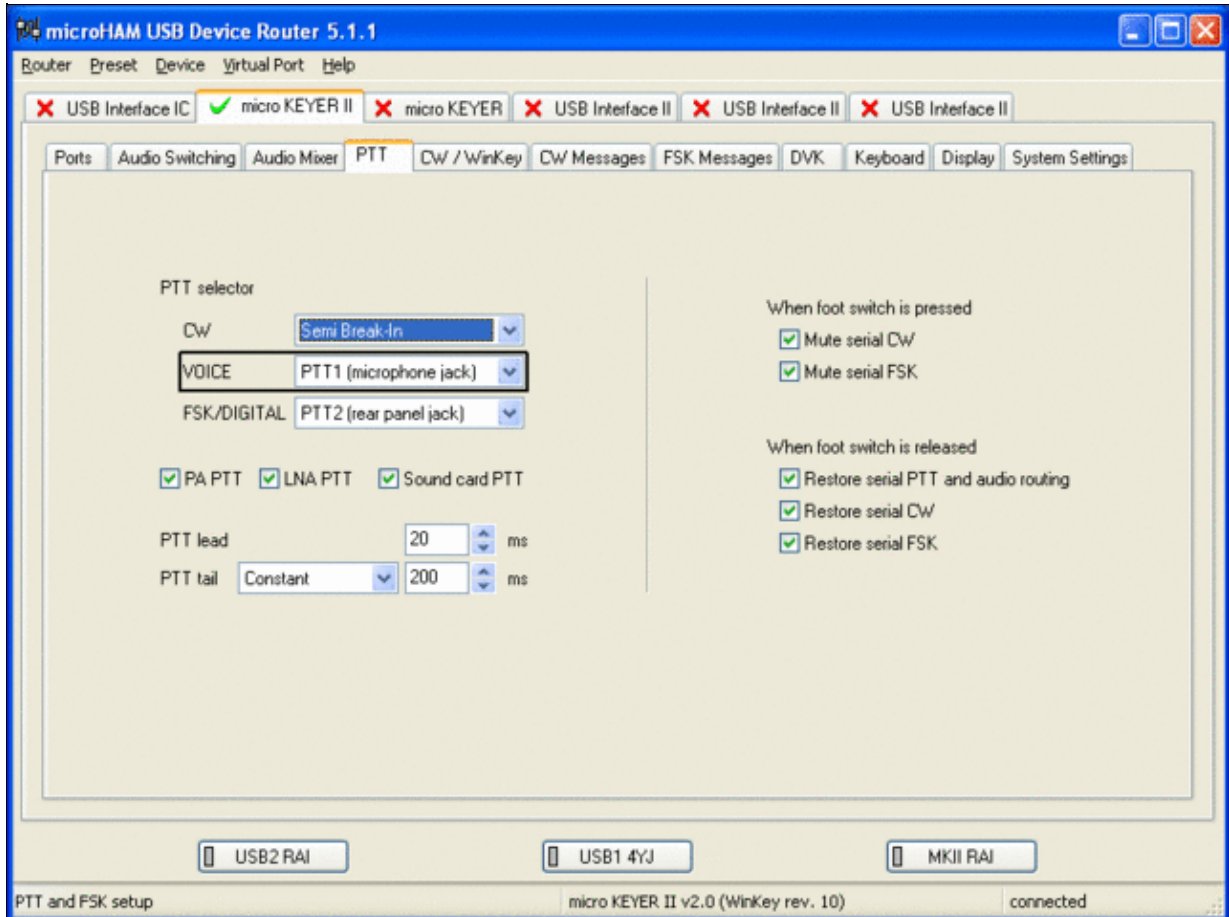

Different PTT settings depending on mode

- Go to the CW/WinKey Tab
  - ◆ My preferred settings are Paddle Mode: Iambic A (Curtis), disable Paddle memory (actually, Dot-Dash-Memory off)

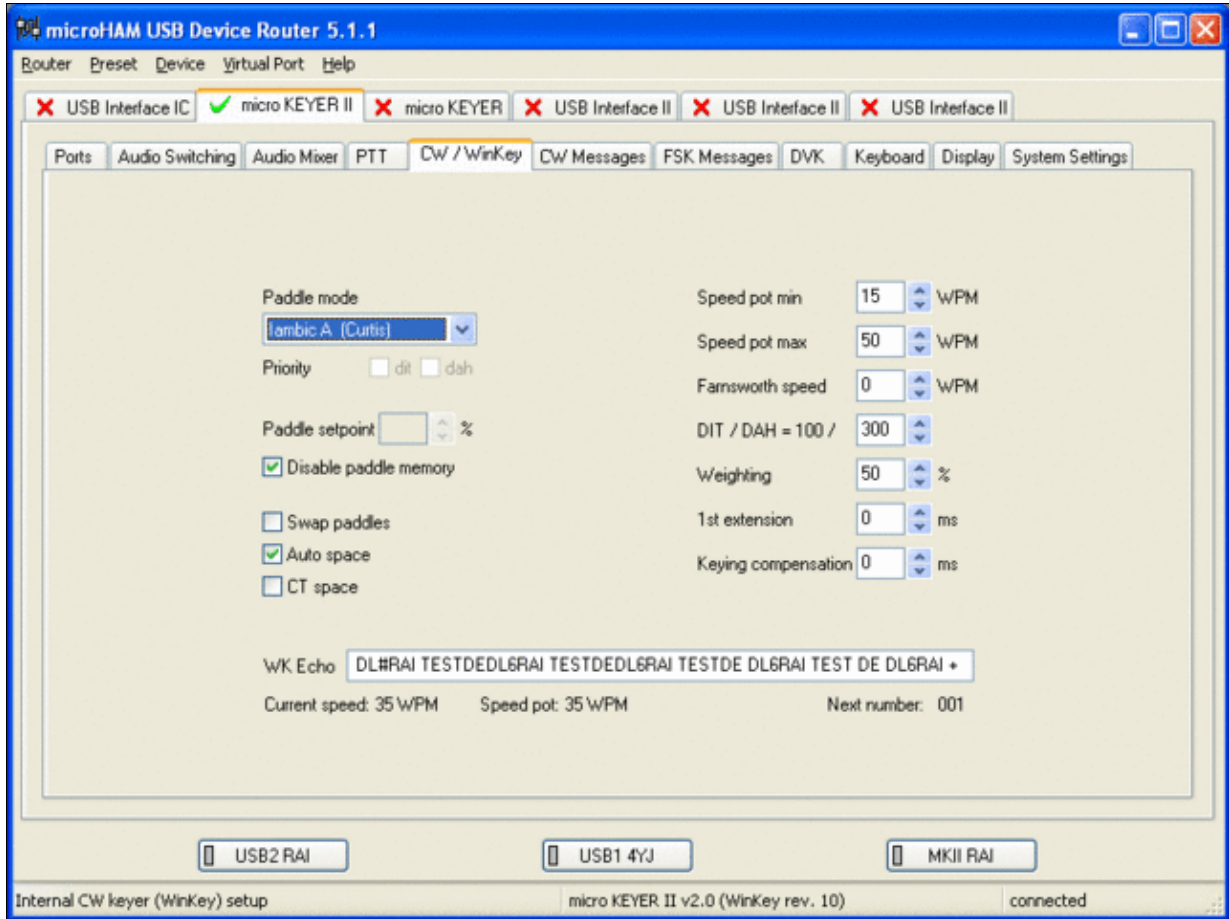

WinKey settings - this is very much depending on your personal preferences

- Testing
  - ◆ Go to a CW frequency, switch the radio to CW and press the VOX button on the radio
  - ◆ Touch the paddle - the radio should switch to transmit without any relay clicking inside the MKII.
  - ◆ The CW/FSK LED on the MKII should flicker with a red light.
  - ◆ Press the Test button on the Winkey port (COM 7) in the Port Tab. The MKII should send **Dah dit dit-dit-dit dah**
  - ◆ Go to a SSB frequency and switch the radio to USB or LSB.
  - ◆ Press the microphone's PTT or the foot switch and say something. The PTT1 LED on the MKII should light up in red color. The radio should go to transmit and produce some output.
  - ◆ Go to the DVK tab, push the RECORD button and say something. Then push the PLAY button. The radio should activate the PTT1 (red light) and transmit your recorded message.
  - ◆ Press the MON button on the radio and listen to the audio. Some audio level adjustments may be required in the Audio Mixer tab.
  - ◆ Go to a RTTY frequency and switch the radio to FSK.
  - ◆ Press the Test button on the FSK port (COM8) in the Port Tab. The radio should switch to transmit, send TEST on RTTY and go back to received.
  - ◆ The CW/FSK LED should flicker with a green light and the PTT2 LED should turn green, while the radio is on transmit.

We are now ready for the next step.

## MMTTY

- Download and Install MMTTY from [here](#).
- Start MMTTY
- Activate the XY Scope by selecting the **View(V)** menu item and tagging **XYScope**

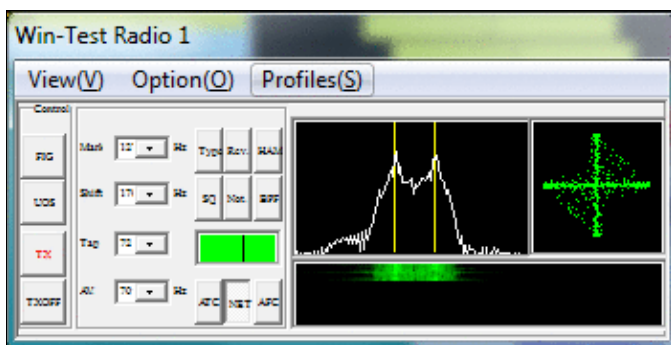

The XY Scope is a practical tuning aid and will help us to visualize the received signals.

- Go to **Option (O) | Setup MMTTY (O) ...**
- Select the Demodulator tab and set it up like in the picture below.



## MMTTY Demodulator settings

- Select the AFC/ATC/PLL tab and make sure AFC is OFF.



MMTTY AFC/ATC/PLL settings. Make sure AFC is off as it will eventually introduce a deviation between TX and RX frequencies.

- Select the TX tab and switch PTT port to COM7 (ignore the COM8 shown in the picture, in our case FSK port is COM7). The Radio Command button in this setup screen will allow you to control the radio from within MMTTY. This is not desired in this scenario so make sure it is **not configured** - otherwise Win-Test would not have access to the radio COM port later.



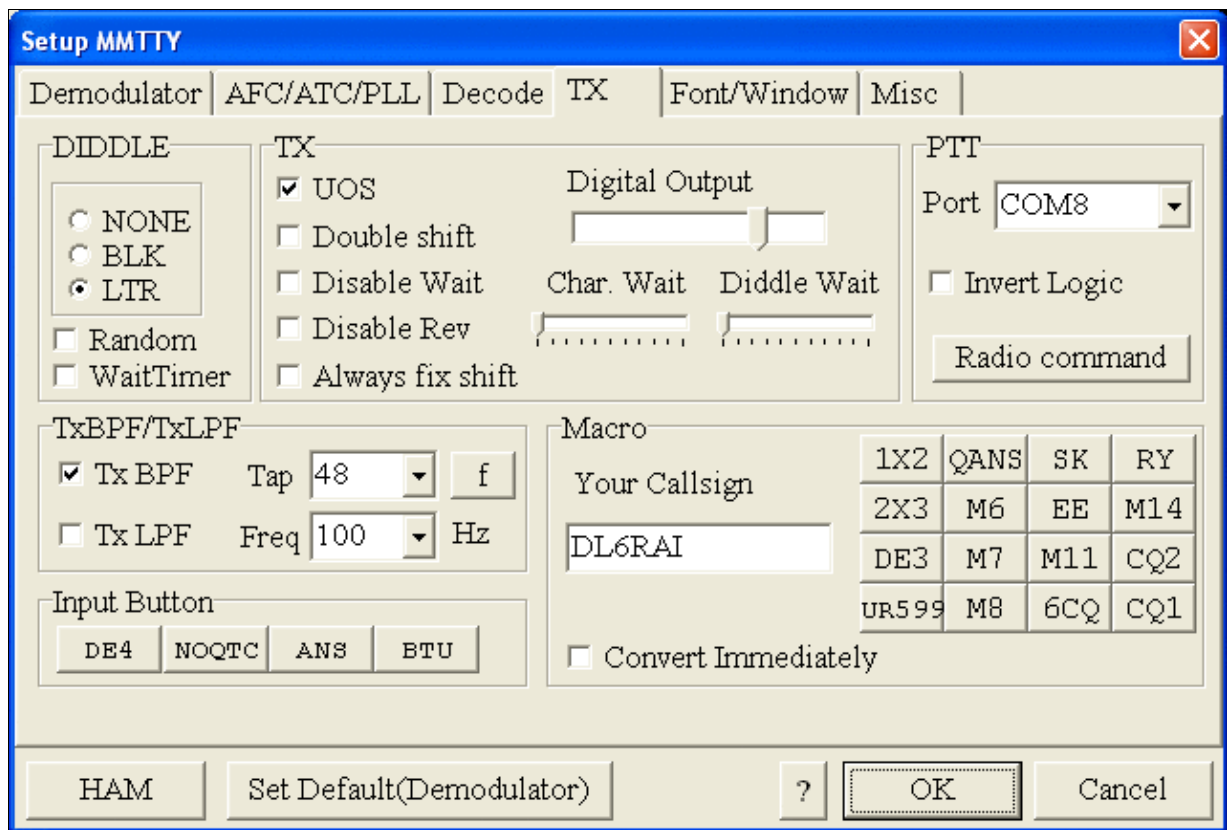

MMTTY Tx settings - PTT is generated by the MKII through COM8

- Select the Misc tab. Since we now have two sound cards - one in the computer, one built into the MKII called microHAM CODEC - we must make sure we're listening on the latter. Switch to the USB router's Audio Mixer Tab and get the device ID by clicking on the button "Get ID" in the lower right corner. This ID must be entered into MMTTY's Device ID field. When listening on the correct device, the LINE LED on the MKII should be lit.
- Also from the Misc tab, select COM-TxD(FSK).

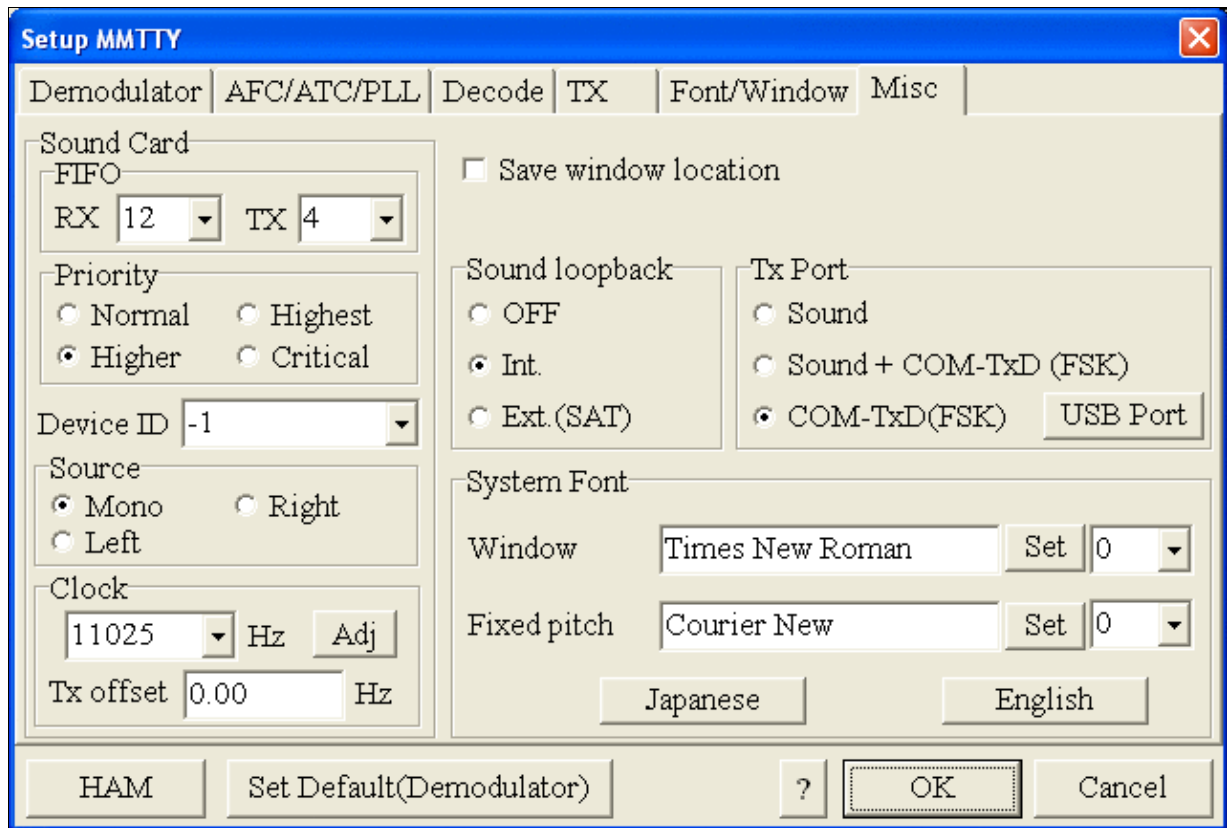

MMTTY Misc settings - FSK is generated via COM7

- Should you have problems generating the FSK signal (especially: keying does work, you hear the RTTY diddle, but no characters are being transmitted), you might have to limit the USB port speed in MMTTY. This setting depends very much on the computer hardware. To limit the USB port speed click on **USB Port** and configure option "C". You can find this setting also in the support documentation of the Microkeyer on the microHAM website.

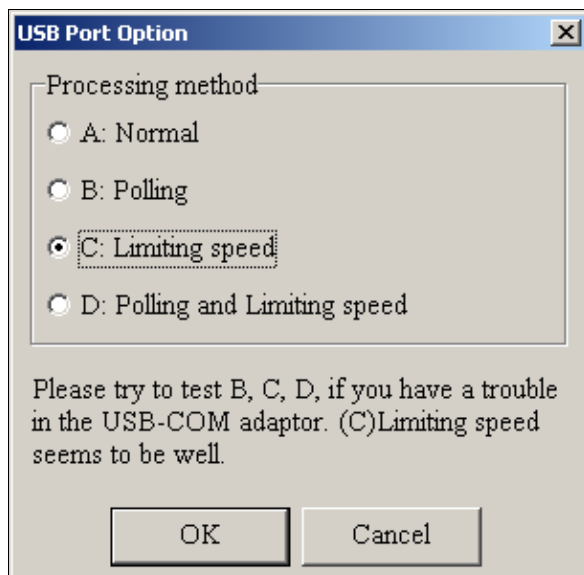

MMTTY USB Port Option - Set only to option C if A does not work for you.

- Exit the Setup screens by pressing the OK button.

We are now ready to do some tests with MMTTY.

- Now take a look at the XY Scope display. It should look like the picture above.
- If you only see a single white point in the middle of the display, this means, that MMTTY gets no audio to process.
  - ◆ Check your cabling. Is your cable connected to Line-in or Mic-in?
  - ◆ Did you select the correct audio device?
  - ◆ Check the level settings for the sound card from the USB Router's Audio Mixer tab. When you move the control up and down you should see an increase and decrease in noise level.



## Win-Test Wiki

Setting the correct audio level on the microHAM CODEC sound card

- Tune across the CW band and check if the XY scope changes when you hear signals. Once you tune across a carrier or CW signal, you should see a vertical ellipse and then a horizontal ellipse or vice versa depending on which direction you tune. The receive section of the screen will show all kinds of clutter.
- Try to find a RTTY signal (not easy on a normal day). Both ellipses should now be perpendicular to each other. See if you can decode RTTY fine. You may have to select proper filters. I use 500 Hz at 8.8 MHz IF and 2.7 kHz at 455 kHz IF.
- Next, press the TX button in the MMTTY application. You should hear the typical RTTY diddle in the monitor of the radio. The XY Scope will also display a clean RTTY signal.
- Type a few characters (including your callsign) and see how they are transmitted.
- Press the TX button one more time to shut off transmission.
- Exit the MMTTY program now.

MMTTY now works perfectly as a stand-alone program. We are now ready for Win-Test.

## Win-Test

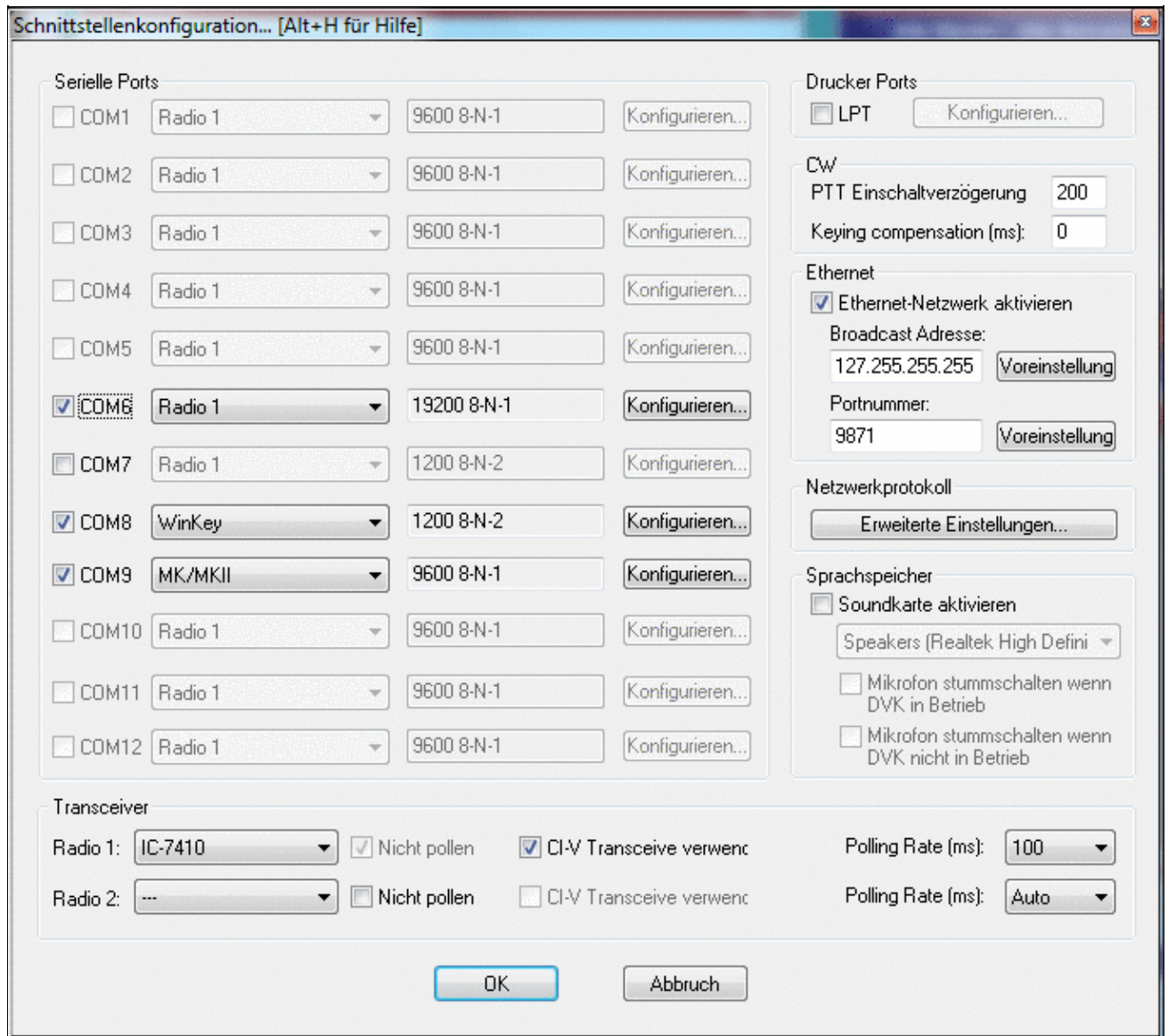

Final steps: Win-Test Interfaces configuration. Note that we only set up three COM ports, no PTT or CW settings are needed as they are all generated/controlled by the MKII.

- Start up Win-Test, create a new Win-Test file for testing.
- Select DXpedition and allow All Modes so you can test all three different modes.
- in the **Options | Configure Interfaces...** menu
  - ◆ configure Radio on COM6
  - ◆ configure Winkey on COM8 using default settings
  - ◆ configure microHAM MK/MKII on COM9
  - ◆ untag Win-Test's internal Voice Keyer
- Go to Configure MMTTY.EXE startup path as described in the [RTTY section of this manual](#) if you are planning for RTTY operation

We are now ready to operate the contest.

## Namespaces

- [Page](#)
- [Discussion](#)

## Variants

## Views

- [Read](#)
- [View source](#)
- [View history](#)

## More

- This page was last edited on 9 June 2022, at 16:24.
- [Privacy policy](#)
- [About Win-Test Wiki](#)
- [Disclaimers](#)



# BestPractice8

From Win-Test Wiki

[Jump to navigation](#) [Jump to search](#)

## Contents

- [1 Setting up the ICOM IC-7410 + microKeyer MKII](#)
- [2 ICOM IC-7410](#)
- [3 microHAM MKII](#)
- [4 microHAM USB Device Router](#)
- [5 MMTTY](#)
- [6 Win-Test](#)

## Setting up the ICOM IC-7410 + microKeyer MKII

This article is a step by step approach describing how to set up an ICOM IC-7410 radio and a microHAM microKeyer II interface. The MKII is a complex device integrating a CW-Keyer, CW and FSK keying, PTT control (including a delayed PTT), radio control and a sound card, a digital voice keyer which allows to control up to ten audio memories and different audio switching scenarios. This article covers the set-up of CW, RTTY and SSB in several steps.

Support for the ICOM IC-7410 implemented WinTest 4.12. Be sure, you are running a current version of WinTest.

[BestPractice1](#) article describes a slightly simpler set-up with the Microham USB Interface II. [BestPractice4](#) article describes a slightly simpler set-up with the microHAM microKeyer. Please see there for background information about RTTY and MMTTY in general.

## ICOM IC-7410

- In the RTTY mode, push [MENU] to display the `M1` screen (Menu 1)
- Push [RTTY](F-4) to display the `RTTY` screen
- Push [SET](F-5) to enter the RTTY Set mode
- Push [Y](F-1) or [Z](F-2) to select the desired item
  - ◆ Set *RTTY Mark Freq* to 1275 (use VFO knob to step through available options)
  - ◆ Set *RTTY Shift Width* to 170 (use VFO knob to step through available options)
  - ◆ Set Keying Pol to NORMAL (use VFO knob to step through available options)
- Push [MENU] to save, and return to the `RTTY` screen
- Push [MENU] again to return to the `M1` screen

To test the settings, put the radio to FSK mode, push the MONITOR button, make sure MONI GAIN is set to the 12 o'clock position and then switch the radio to transmit by pressing TRANSMIT. You should now hear a 1275 Hz tone.

**Note:** The built-in RTTY decoder in the IC-7410 only works with High Tones selected. I personally prefer listening to low tones and so this article focusses on 1275 Hz/1445 Hz, but actually it's up to you.

## microHAM MKII

- Connect the MKII to a 12V DC source. Optionally you can feed the MKII via the DB37 cable by setting the jumper inside the MK-II very close to the 13.8 V DC jack.
- Connect a footswitch to the FOOTSW connector of the MKII.
- Connect your microphone or headset to the short RJ45 cable that goes into MIC on the MKII (this connector does also provide the 8V DC voltage on pin 5 for your electret microphone - for ICOM you have to enable this; do not try to use dynamic microphones with ICOM radios, this will fail - audio level is too low).
- Connect the microHAM MKII to your radio and computer.
  - ◆ On the radio side there will be five connections: KEY, RTTY, PACKET, CAT, AF OUT and microphone.
  - ◆ On the computer side there will be only a single connection: USB. I had to use a ferrite core to get rid of RF noise.
- Install the microHAM software if you haven't done so already. There are two steps to it:
  - ◆ Installing the device driver - if you have several microHAM devices you will have to do this once for each of them.
  - ◆ Installing the USB Device Router - this software only needs to be installed once. It is identical on all microHAM products.

**Note:** If you had previously installed the USB Device Router with another microHAM product, it will come up with a new tab for the new hardware connected.

## microHAM USB Device Router

- Set up the Device Router
- Go to the Ports Tab
  - ◆ Create four virtual COM ports: COM6, COM7, COM8 and COM9. Note: The absolute port numbers do not matter. The key is consistency - the same port number must be used for a specific function every time it is used.
  - ◆ Configure Radio on COM6
  - ◆ Press the **Set** button to the right of the radio port configuration and select Icom IC-7410. MKII will assign different Audio Routing and PTT scenarios if it knows what frequency and mode the radio is set. This is why we have to do it.
  - ◆ You should now see the current frequency of the radio display in the **Ports** tab
  - ◆ Configure Winkey COM7 using Winkey default settings
  - ◆ Configure FSK on COM8. Make sure you tick the PTT tag
  - ◆ Configure Control on COM9. This will allow controlling the MKII, especially the built-in DVK from Win-Test.



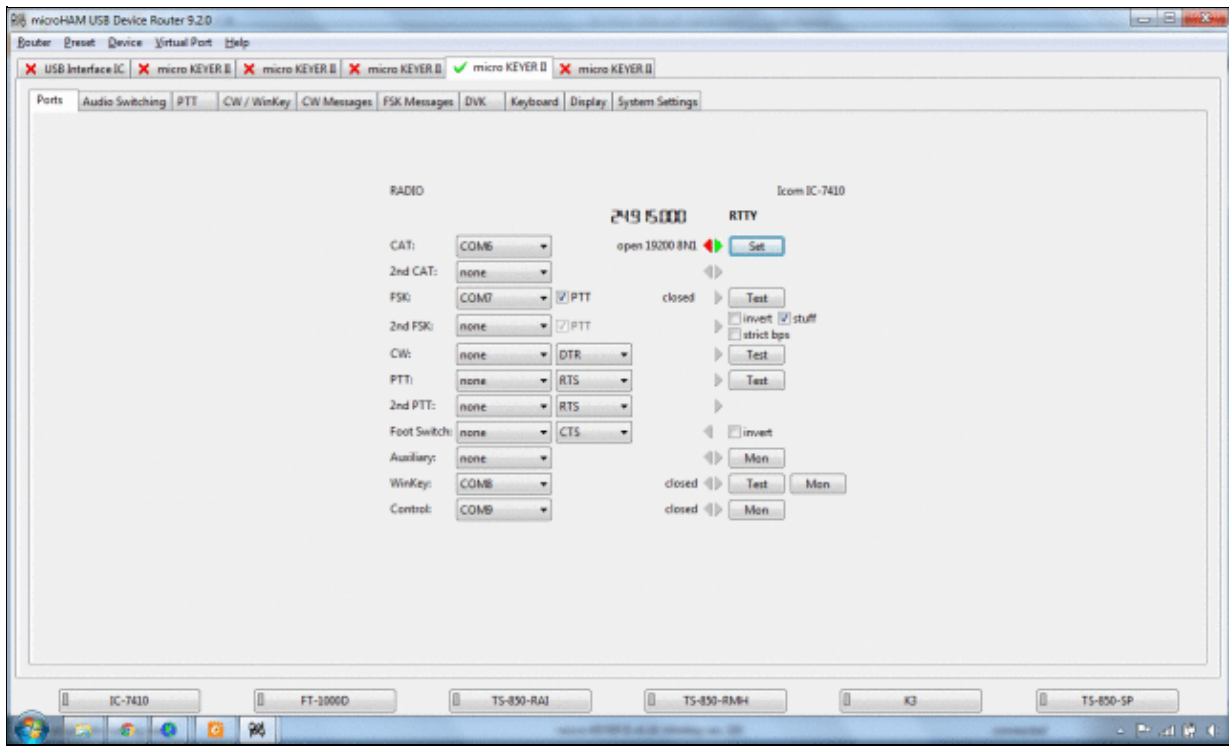

microHAM MKII Ports setup. We use COM6, 7, 8 and 9 to control different properties of the MKII.

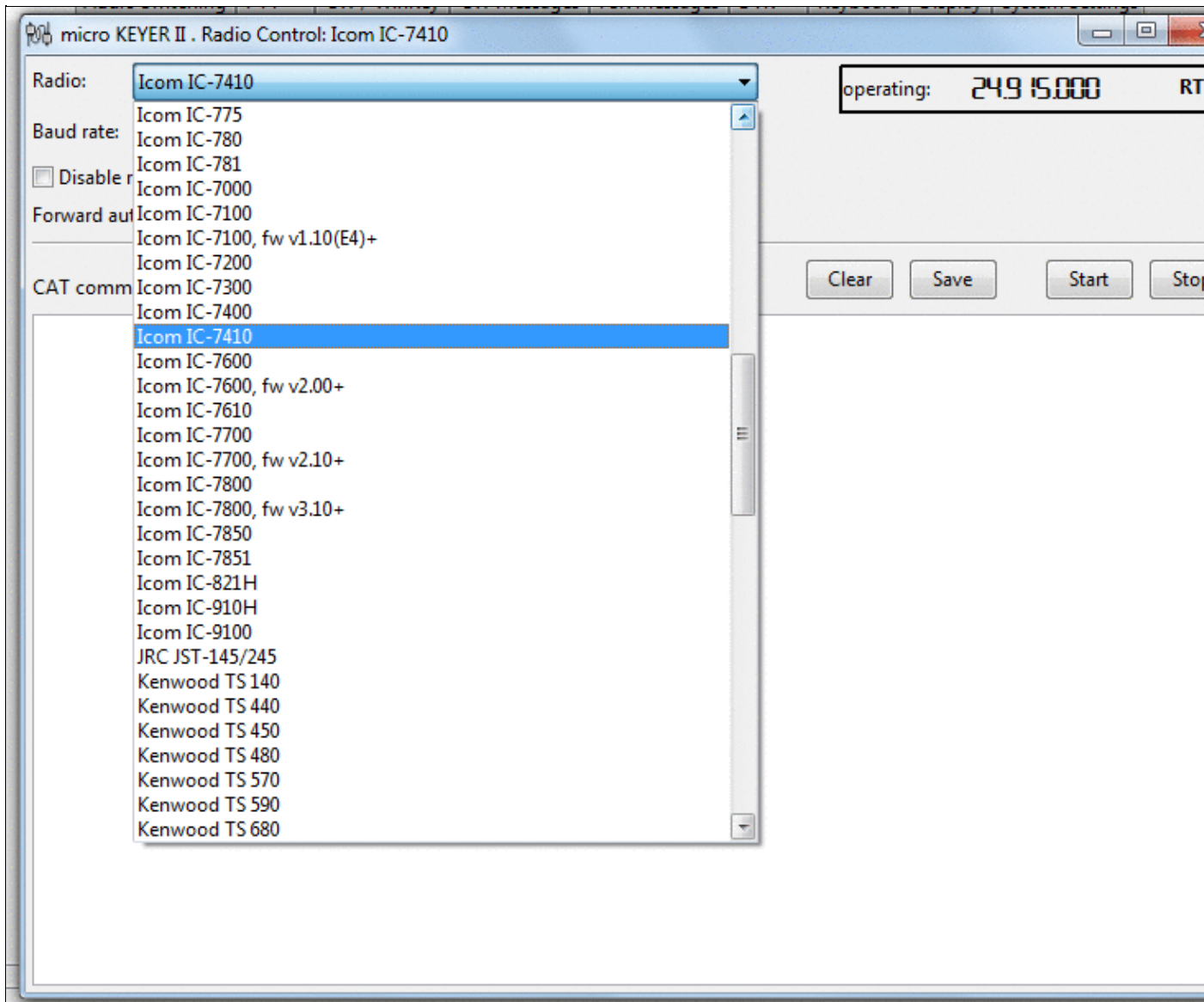

Make sure, the MKII knows about your radio so it can control Audio Switching and PTT depending on the selected mode.

- Go to the Audio Switching Tab
  - ◆ Configure the Audio Switching as shown below.
    - ◇ Have the radio on LSB or USB. Select "Microphone jack, DVK control".
    - ◇ Now switch the radio to FSK mode. Select "line input (rear)".

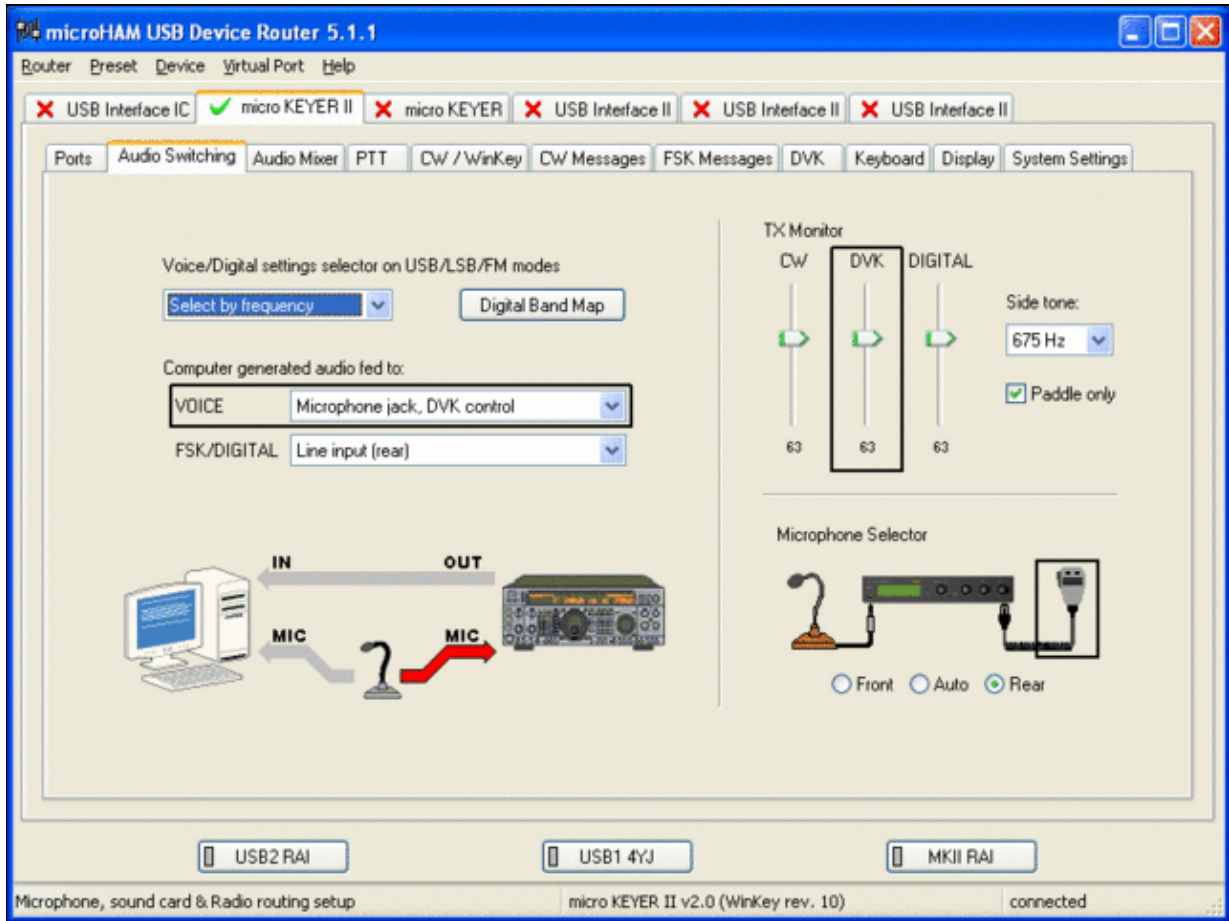

microHAM MKII Audio Switching setup.

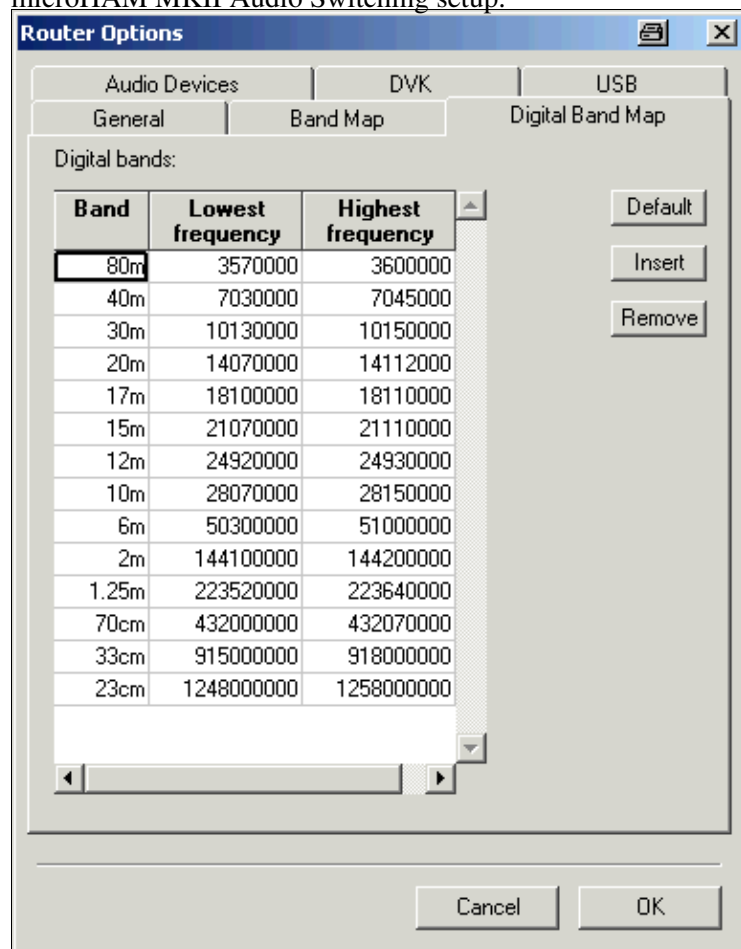

## Win-Test Wiki

This is the digital band map which is used to decide which mode the radio is operating in. With Yaesu radios, MKII retrieves the mode directly from the communication protocol, so this map is not used.

- Go to the Audio Mixing Tab
  - ◆ Select the microHAM CODEC sound device

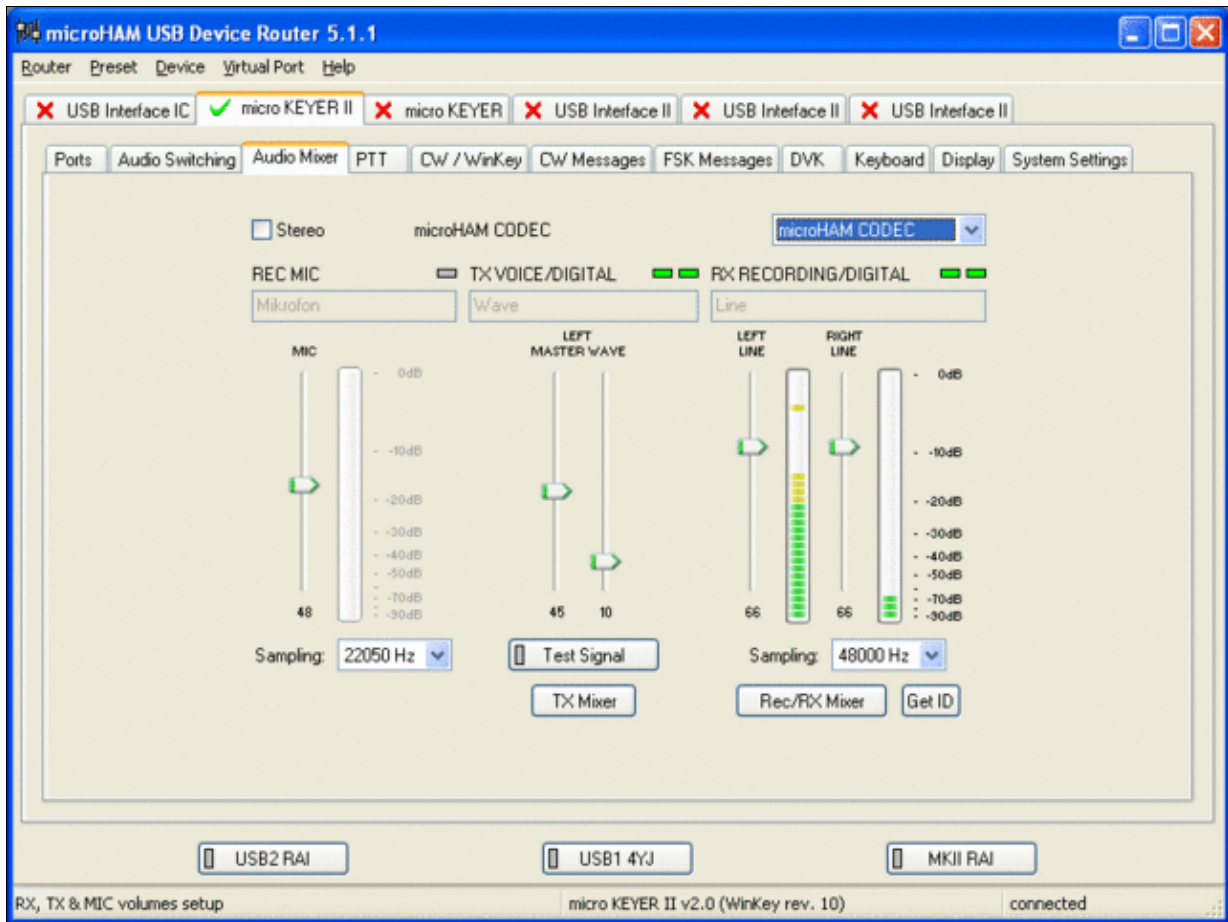

Using the built-in sound card requires selecting it here.

- Go to the PTT Tab
  - ◆ In the PTT selector, select "semi break in" for CW, "PTT1" for Voice and "PTT2" for Digital Modes. This will allow using QSK or VOX operation on CW (which I prefer over the microHAM doing all the switching - but mind hot switching PA relays!). Selecting PTT1 for voice operation will route audio input to the front Mic connector of the radio - avoiding audio level problems.

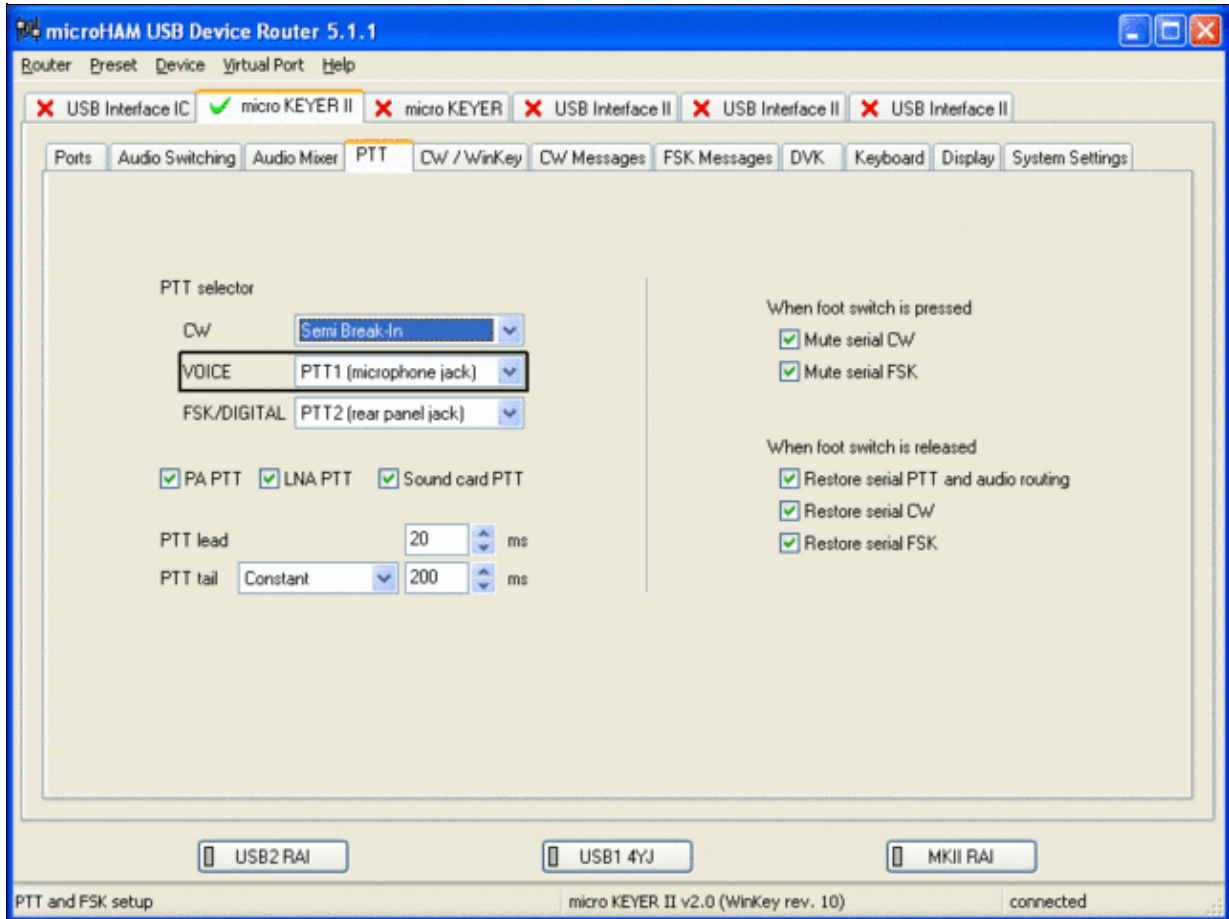

Different PTT settings depending on mode

- Go to the CW/WinKey Tab
  - ◆ My preferred settings are Paddle Mode: Iambic A (Curtis), disable Paddle memory (actually, Dot-Dash-Memory off)

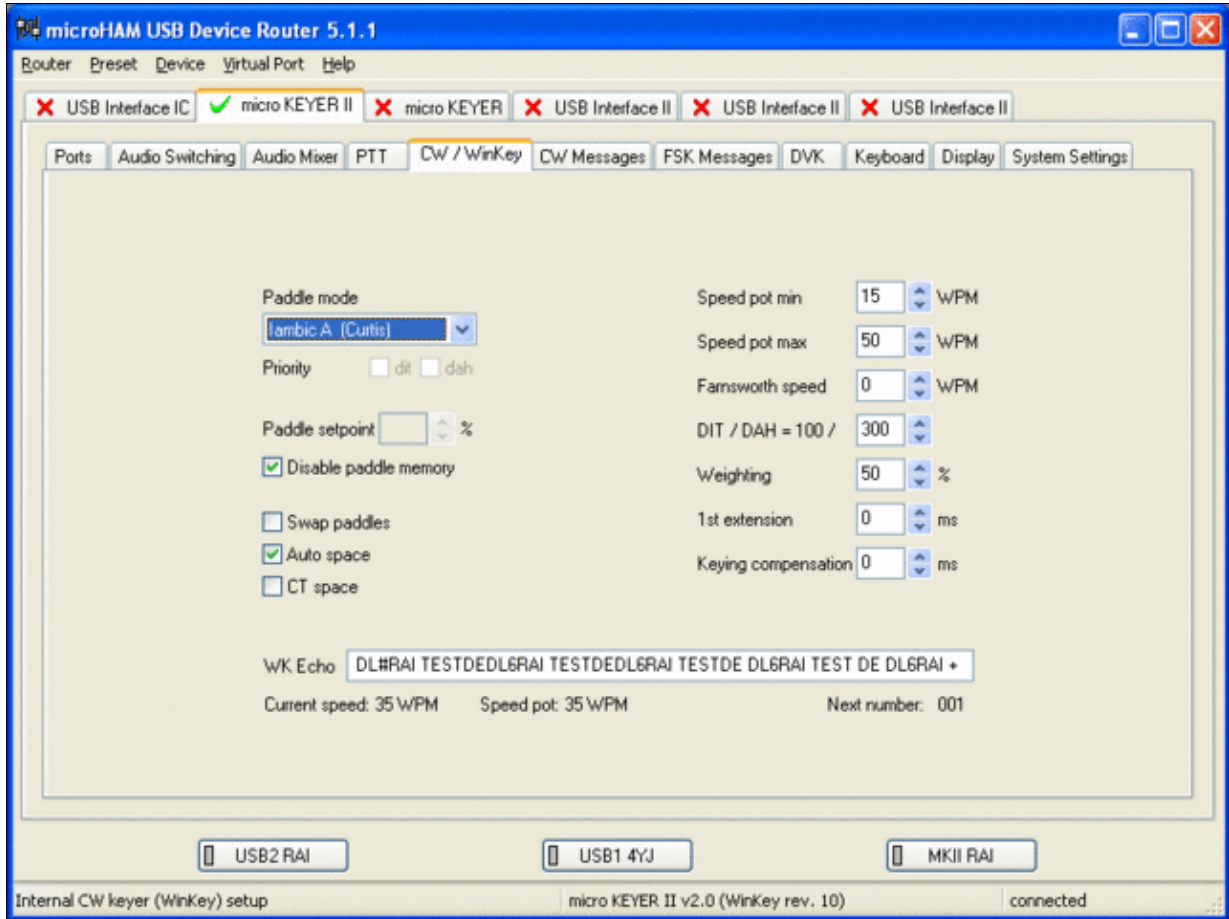

WinKey settings - this is very much depending on your personal preferences

- Testing
  - ◆ Go to a CW frequency, switch the radio to CW and press the VOX button on the radio
  - ◆ Touch the paddle - the radio should switch to transmit without any relay clicking inside the MKII.
  - ◆ The CW/FSK LED on the MKII should flicker with a red light.
  - ◆ Press the Test button on the Winkey port (COM 7) in the Port Tab. The MKII should send **Dah dit dit-dit-dit dah**
  - ◆ Go to a SSB frequency and switch the radio to USB or LSB.
  - ◆ Press the microphone's PTT or the foot switch and say something. The PTT1 LED on the MKII should light up in red color. The radio should go to transmit and produce some output.
  - ◆ Go to the DVK tab, push the RECORD button and say something. Then push the PLAY button. The radio should activate the PTT1 (red light) and transmit your recorded message.
  - ◆ Press the MON button on the radio and listen to the audio. Some audio level adjustments may be required in the Audio Mixer tab.
  - ◆ Go to a RTTY frequency and switch the radio to FSK.
  - ◆ Press the Test button on the FSK port (COM8) in the Port Tab. The radio should switch to transmit, send TEST on RTTY and go back to received.
  - ◆ The CW/FSK LED should flicker with a green light and the PTT2 LED should turn green, while the radio is on transmit.

We are now ready for the next step.

## MMTTY

- Download and Install MMTTY from [here](#).
- Start MMTTY
- Activate the XY Scope by selecting the **View(V)** menu item and tagging **XYScope**

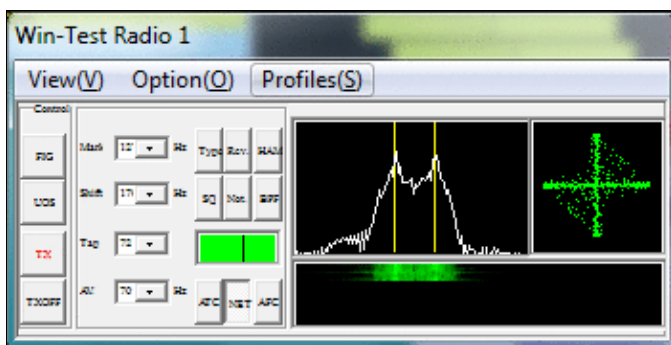



The XY Scope is a practical tuning aid and will help us to visualize the received signals.

- Go to **Option (O) | Setup MMTTY (O) ...**
- Select the Demodulator tab and set it up like in the picture below.



## MMTTY Demodulator settings

- Select the AFC/ATC/PLL tab and make sure AFC is OFF.



MMTTY AFC/ATC/PLL settings. Make sure AFC is off as it will eventually introduce a deviation between TX and RX frequencies.

- Select the TX tab and switch PTT port to COM7 (ignore the COM8 shown in the picture, in our case FSK port is COM7). The Radio Command button in this setup screen will allow you to control the radio from within MMTTY. This is not desired in this scenario so make sure it is **not configured** - otherwise Win-Test would not have access to the radio COM port later.

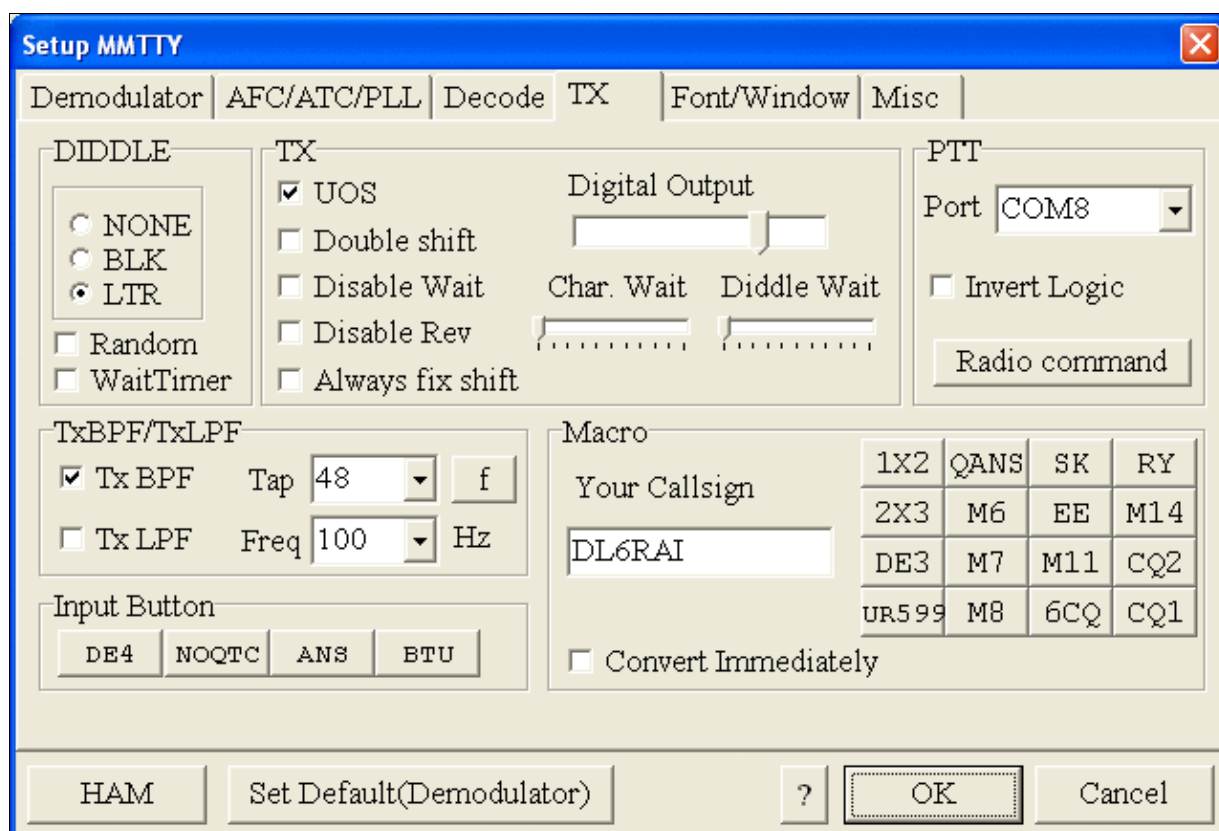

MMTTY Tx settings - PTT is generated by the MKII through COM8

- Select the Misc tab. Since we now have two sound cards - one in the computer, one built into the MKII called microHAM CODEC - we must make sure we're listening on the latter. Switch to the USB router's Audio Mixer Tab and get the device ID by clicking on the button "Get ID" in the lower right corner. This ID must be entered into MMTTY's Device ID field. When listening on the correct device, the LINE LED on the MKII should be lit.
- Also from the Misc tab, select COM-TxD(FSK).

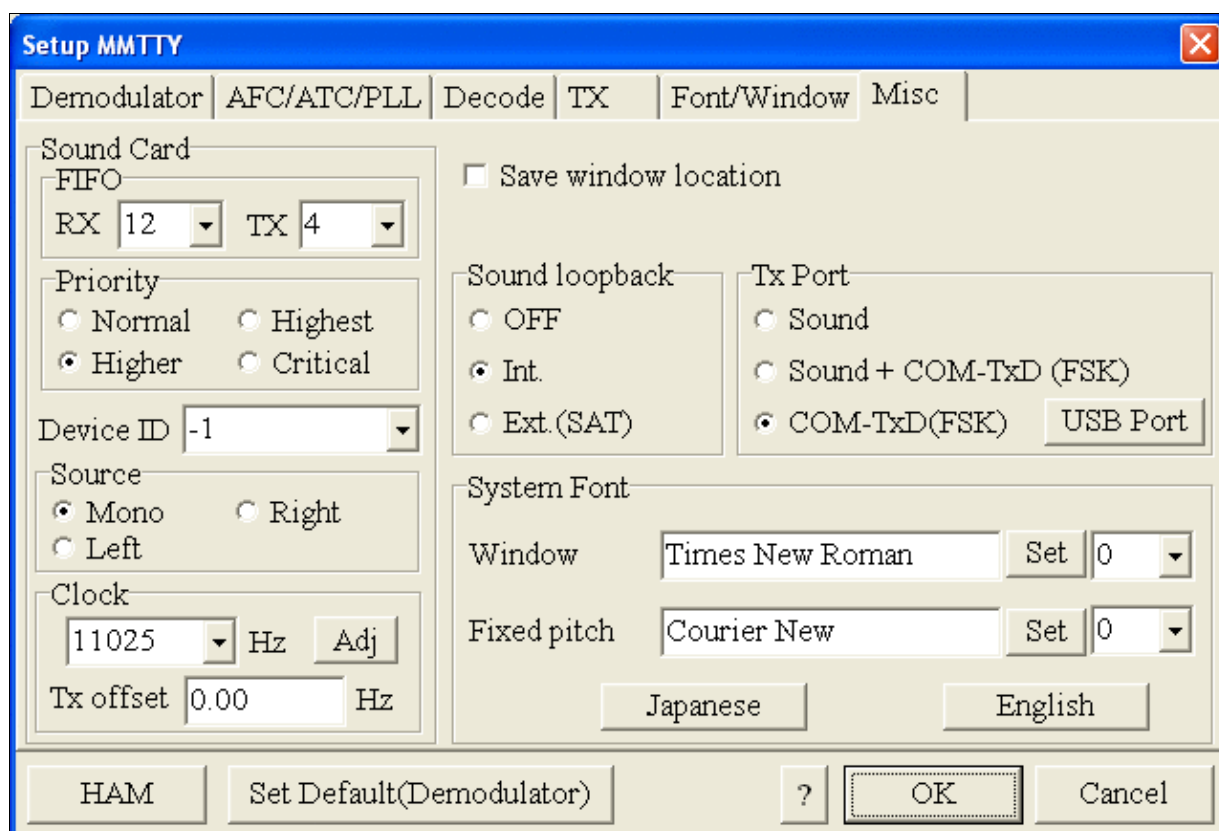

MMTTY Misc settings - FSK is generated via COM7

- Should you have problems generating the FSK signal (especially: keying does work, you hear the RTTY diddle, but no characters are being transmitted), you might have to limit the USB port speed in MMTTY. This setting depends very much on the computer hardware. To limit the USB port speed click on **USB Port** and configure option "C". You can find this setting also in the support documentation of the Microkeyer on the microHAM website.

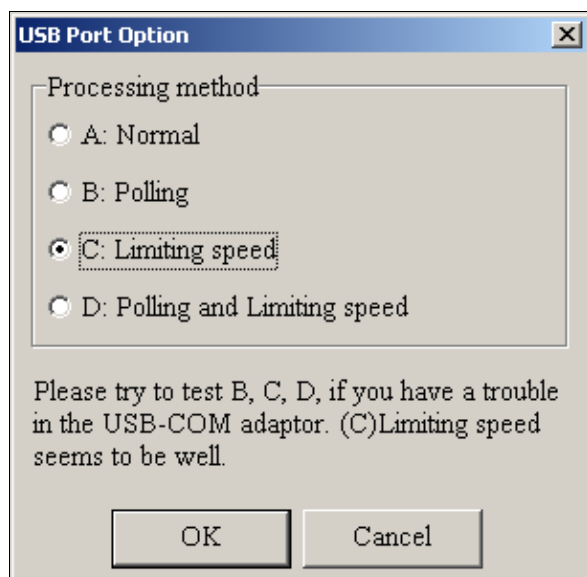

MMTTY USB Port Option - Set only to option C if A does not work for you.

- Exit the Setup screens by pressing the OK button.

We are now ready to do some tests with MMTTY.

- Now take a look at the XY Scope display. It should look like the picture above.
- If you only see a single white point in the middle of the display, this means, that MMTTY gets no audio to process.
  - ◆ Check your cabling. Is your cable connected to Line-in or Mic-in?
  - ◆ Did you select the correct audio device?
  - ◆ Check the level settings for the sound card from the USB Router's Audio Mixer tab. When you move the control up and down you should see an increase and decrease in noise level.

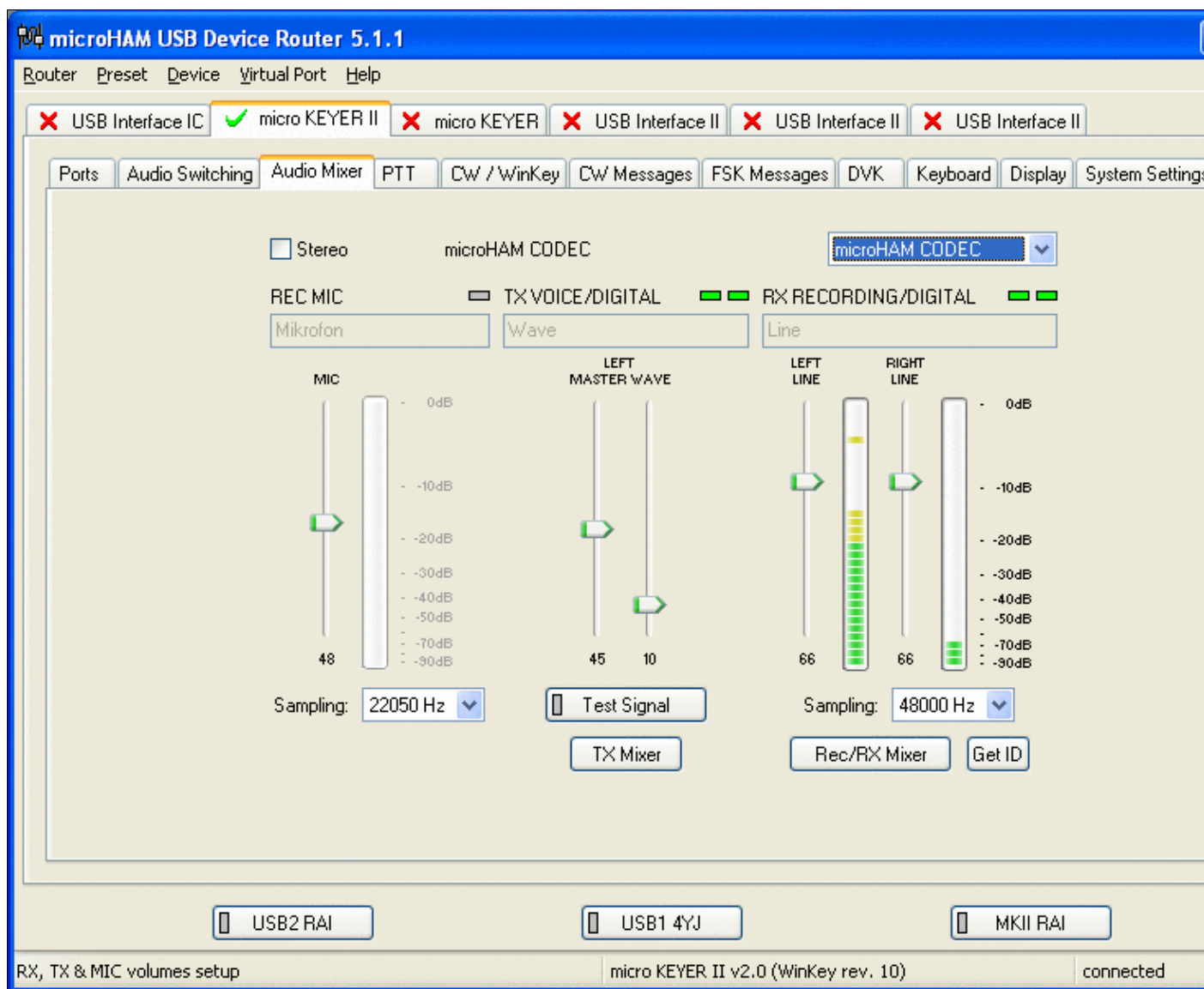

## Win-Test Wiki

Setting the correct audio level on the microHAM CODEC sound card

- Tune across the CW band and check if the XY scope changes when you hear signals. Once you tune across a carrier or CW signal, you should see a vertical ellipse and then a horizontal ellipse or vice versa depending on which direction you tune. The receive section of the screen will show all kinds of clutter.
- Try to find a RTTY signal (not easy on a normal day). Both ellipses should now be perpendicular to each other. See if you can decode RTTY fine. You may have to select proper filters. I use 500 Hz at 8.8 MHz IF and 2.7 kHz at 455 kHz IF.
- Next, press the TX button in the MMTTY application. You should hear the typical RTTY diddle in the monitor of the radio. The XY Scope will also display a clean RTTY signal.
- Type a few characters (including your callsign) and see how they are transmitted.
- Press the TX button one more time to shut off transmission.
- Exit the MMTTY program now.

MMTTY now works perfectly as a stand-alone program. We are now ready for Win-Test.

## Win-Test

Schnittstellenkonfiguration... [Alt+H für Hilfe]

**Serielle Ports**

<input type="checkbox"/>	COM1	Radio 1	9600 8-N-1	Konfigurieren...
<input type="checkbox"/>	COM2	Radio 1	9600 8-N-1	Konfigurieren...
<input type="checkbox"/>	COM3	Radio 1	9600 8-N-1	Konfigurieren...
<input type="checkbox"/>	COM4	Radio 1	9600 8-N-1	Konfigurieren...
<input type="checkbox"/>	COM5	Radio 1	9600 8-N-1	Konfigurieren...
<input checked="" type="checkbox"/>	COM6	Radio 1	19200 8-N-1	Konfigurieren...
<input type="checkbox"/>	COM7	Radio 1	1200 8-N-2	Konfigurieren...
<input checked="" type="checkbox"/>	COM8	WinKey	1200 8-N-2	Konfigurieren...
<input checked="" type="checkbox"/>	COM9	MK/MKII	9600 8-N-1	Konfigurieren...
<input type="checkbox"/>	COM10	Radio 1	9600 8-N-1	Konfigurieren...
<input type="checkbox"/>	COM11	Radio 1	9600 8-N-1	Konfigurieren...
<input type="checkbox"/>	COM12	Radio 1	9600 8-N-1	Konfigurieren...

**Drucker Ports**

LPT Konfigurieren...

**CW**

PTT Einschaltverzögerung: 200

Keying compensation (ms): 0

**Ethernet**

Ethernet-Netzwerk aktivieren

Broadcast Adresse: 127.255.255.255 Voreinstellung

Portnummer: 9871 Voreinstellung

**Netzwerkprotokoll**

Erweiterte Einstellungen...

**Sprachspeicher**

Soundkarte aktivieren

Speakers (Realtek High Defini)

Mikrofon stummschalten wenn DVK in Betrieb

Mikrofon stummschalten wenn DVK nicht in Betrieb

**Transceiver**

Radio 1: IC-7410  Nicht pollen  CI-V Transceiver verwenc

Radio 2: ---  Nicht pollen  CI-V Transceiver verwenc

Polling Rate (ms): 100

Polling Rate (ms): Auto

OK Abbruch

Final steps: Win-Test Interfaces configuration. Note that we only set up three COM ports, no PTT or CW settings are needed as they are all generated/controlled by the MKII.

- Start up Win-Test, create a new Win-Test file for testing.
- Select DXpedition and allow All Modes so you can test all three different modes.
- in the **Options | Configure Interfaces...** menu
  - ◆ configure Radio on COM6
  - ◆ configure Winkey on COM8 using default settings
  - ◆ configure microHAM MK/MKII on COM9
  - ◆ untag Win-Test's internal Voice Keyer
- Go to Configure MMTTY.EXE startup path as described in the [RTTY section of this manual](#) if you are planning for RTTY operation

We are now ready to operate the contest.

## Namespaces

- [Page](#)
- [Discussion](#)

## Variants

## Views

- [Read](#)
- [View source](#)
- [View history](#)

## More

- This page was last edited on 9 June 2022, at 16:24.
- [Privacy policy](#)
- [About Win-Test Wiki](#)
- [Disclaimers](#)





# BestPractice9

From Win-Test Wiki

[Jump to navigation](#) [Jump to search](#)

## Setting up the KX3 for CW Operation

HB9AMO describes on his personal web page] how to interface Win-Test and the Elecraft KX3 using only the KXUSB cable between the two devices, enabling to send CAT commands and pre-recorded CW messages with the F1 to F7 keys.

These are the basic points:

- Get an FTDI driver for your Windows system
- Set the radio's RS-232 parameters to 38400 baud
- Configure the KX3 in Win-Test on COM3
- COM3 will also be used to make the radio send CW. For this the N6TV K3 scripts need to be installed.
- Setup CW messages F1..F7 using #PLAY ("CQ CQ DE HB9AMO...") type messages

A detailed discription can be found here: <http://www.hb9amo.net/wt-kx3.php>.

## Namespaces

- [Page](#)
- [Discussion](#)

## Variants

## Views

- [Read](#)
- [View source](#)
- [View history](#)

## More

- This page was last edited on 22 May 2020, at 14:40.

- [Privacy policy](#)
- [About Win-Test Wiki](#)
- [Disclaimers](#)



# BestPractice9

From Win-Test Wiki

[Jump to navigation](#) [Jump to search](#)

## Setting up the KX3 for CW Operation

HB9AMO describes on his personal web page] how to interface Win-Test and the Elecraft KX3 using only the KXUSB cable between the two devices, enabling to send CAT commands and pre-recorded CW messages with the F1 to F7 keys.

These are the basic points:

- Get an FTDI driver for your Windows system
- Set the radio's RS-232 parameters to 38400 baud
- Configure the KX3 in Win-Test on COM3
- COM3 will also be used to make the radio send CW. For this the N6TV K3 scripts need to be installed.
- Setup CW messages F1..F7 using `#PLAY ("CQ CQ DE HB9AMO...")` type messages

A detailed discription can be found here: <http://www.hb9amo.net/wt-kx3.php>.

## Namespaces

- [Page](#)
- [Discussion](#)

## Variants

## Views

- [Read](#)
- [View source](#)
- [View history](#)

## More

- This page was last edited on 22 May 2020, at 14:40.

- [Privacy policy](#)
- [About Win-Test Wiki](#)
- [Disclaimers](#)



# Best Practice

From Win-Test Wiki

[Jump to navigation](#) [Jump to search](#)

This article collects a number best practice articles describing a step-by-step configuration instructions for different configurations, mostly involving the complex but very versatile microHam controllers. Feel free to add your own personal set-b-step insruction in a BestPractice article. This maybe helpful for you and for others.

1. [Kenwood TS-850S or FT-1000MP + microHAM MKII setup](#)
2. [Icom IC-736 with the microHAM USB Interface II setup](#)
3. [Icom IC-275H with the microHAM USB Interface IC setup](#)
4. [Kenwood TS-850S with the microHAM microKeyer setup](#)
5. [Kenwood TS-850S with the microHAM MKII](#)
6. [Yaesu FT-1000D with the microHAM MKII](#)
7. [Setting up the Yaesu FTDX-101](#)
8. [Setting up the ICOM IC-7410 + microHAM MKII](#)
9. [Setting up the KX3 only with KXUSB cable](#)
10. [Setting up the ICOM IC-7851 + microHAM MK III](#)

## Namespaces

- [Page](#)
- [Discussion](#)

## Variants

## Views

- [Read](#)
- [View source](#)
- [View history](#)

## More

- This page was last edited on 19 March 2021, at 18:01.

- [Privacy policy](#)
- [About Win-Test Wiki](#)
- [Disclaimers](#)



# SO2R/Caps Lock bind to the secondary radio

From Win-Test Wiki

[Jump to navigation](#) [Jump to search](#)

When operating SO2R the contestor has two radios, two amplifiers, two sets of antennas, but only one computer to log all the QSOs. How to tell the program when typing a call that it belongs to radio1 or to radio2 is the question.

Using the **[Shift]** key to signal to what radio the callsign belongs to is one solution but it requires re-defining the numbers above the letters in the keyboard and keep pushing the **[Shift]** key while typing the call to go to the secondary radio. Another way to bind calls to the secondary window is to use the **[Caps Lock]** key. While the **[Caps Lock]** key is activated what you type into the keyboard goes to the secondary radio window.

This option does not require redefining the number above the letters in the keyboard.

To select this option go to the menu `Operating | Caps Lock binds to the secondary radio`.

Pressing the **[Caps Lock]** key will switch the keyboard focus to the secondary radio window only while nothing happens to the active radio. To switch the active radio use the **[\*]** key on the numeric keypad instead. (see also [Keys Radio Control](#) on this manual).

## Namespaces

- [Page](#)
- [Discussion](#)

## Variants

## Views

- [Read](#)
- [View source](#)
- [View history](#)

## More

- This page was last edited on 31 March 2007, at 21:18.
- [Privacy policy](#)
- [About Win-Test Wiki](#)
- [Disclaimers](#)



# SO2R/Caps Lock bind to the secondary radio

From Win-Test Wiki

[Jump to navigation](#) [Jump to search](#)

When operating SO2R the contester has two radios, two amplifiers, two sets of antennas, but only one computer to log all the QSOs. How to tell the program when typing a call that it belongs to radio1 or to radio2 is the question.

Using the **[Shift]** key to signal to what radio the callsign belongs to is one solution but it requires re-defining the numbers above the letters in the keyboard and keep pushing the **[Shift]** key while typing the call to go to the secondary radio. Another way to bind calls to the secondary window is to use the **[Caps Lock]** key. While the **[Caps Lock]** key is activated what you type into the keyboard goes to the secondary radio window.

This option does not require redefining the number above the letters in the keyboard.

To select this option go to the menu `Operating | Caps Lock binds to the secondary radio`.

Pressing the **[Caps Lock]** key will switch the keyboard focus to the secondary radio window only while nothing happens to the active radio. To switch the active radio use the **[\*]** key on the numeric keypad instead. (see also [Keys Radio Control](#) on this manual).

## Namespaces

- [Page](#)
- [Discussion](#)

## Variants

## Views



















- [Read](#)
- [View source](#)
- [View history](#)

## More

- This page was last edited on 31 March 2007, at 21:18.
- [Privacy policy](#)
- [About Win-Test Wiki](#)
- [Disclaimers](#)



# Index of /pdf/daily



<u>Name</u>	<u>Last modified</u>	<u>Size</u>	<u>Description</u>
 <a href="#">Parent Directory</a>		-	
 <a href="#">NEW win-test.pdf</a>	2024-03-30 01:05	9.8M	
 <a href="#">win-test-20240229.pdf</a>	2024-02-29 01:04	49M	
 <a href="#">win-test-20240301.pdf</a>	2024-03-01 01:06	49M	
 <a href="#">win-test-20240302.pdf</a>	2024-03-02 01:04	49M	
 <a href="#">win-test-20240303.pdf</a>	2024-03-03 01:05	49M	
 <a href="#">win-test-20240304.pdf</a>	2024-03-04 01:04	49M	
 <a href="#">win-test-20240305.pdf</a>	2024-03-05 01:05	49M	
 <a href="#">win-test-20240306.pdf</a>	2024-03-06 01:05	49M	
 <a href="#">win-test-20240307.pdf</a>	2024-03-07 01:05	49M	
 <a href="#">win-test-20240308.pdf</a>	2024-03-08 01:05	49M	
 <a href="#">win-test-20240309.pdf</a>	2024-03-09 01:05	49M	
 <a href="#">win-test-20240310.pdf</a>	2024-03-10 01:05	49M	
 <a href="#">win-test-20240311.pdf</a>	2024-03-11 01:05	49M	
 <a href="#">win-test-20240312.pdf</a>	2024-03-12 01:05	49M	
 <a href="#">win-test-20240313.pdf</a>	2024-03-13 01:05	49M	
 <a href="#">win-test-20240314.pdf</a>	2024-03-14 01:05	49M	
 <a href="#">win-test-20240315.pdf</a>	2024-03-15 01:05	49M	
 <a href="#">win-test-20240316.pdf</a>	2024-03-16 01:05	49M	
 <a href="#">win-test-20240317.pdf</a>	2024-03-17 01:05	49M	
 <a href="#">win-test-20240318.pdf</a>	2024-03-18 01:04	49M	
 <a href="#">win-test-20240319.pdf</a>	2024-03-19 01:05	49M	
 <a href="#">win-test-20240320.pdf</a>	2024-03-20 01:04	49M	
 <a href="#">win-test-20240321.pdf</a>	2024-03-21 01:05	49M	
 <a href="#">win-test-20240322.pdf</a>	2024-03-22 01:04	49M	
 <a href="#">win-test-20240323.pdf</a>	2024-03-23 01:05	49M	
 <a href="#">win-test-20240324.pdf</a>	2024-03-24 01:05	49M	
 <a href="#">win-test-20240325.pdf</a>	2024-03-25 01:05	49M	
 <a href="#">win-test-20240326.pdf</a>	2024-03-26 01:05	49M	
 <a href="#">win-test-20240327.pdf</a>	2024-03-27 01:05	49M	
 <a href="#">win-test-20240328.pdf</a>	2024-03-28 01:05	49M	
 <a href="#">win-test-20240329.pdf</a>	2024-03-29 01:05	49M	

<u>Name</u>	<u>Last modified</u>	<u>Size</u>	<u>Description</u>
 <a href="#">win-test-20240330.pdf</a>	2024-03-30 01:05	49M	

---

Apache/2.4.41 Server at docs.win-test.com Port 80



# Index of /pdf/downloads

<u>Name</u>	<u>Last modified</u>	<u>Size</u>	<u>Description</u>
 <a href="#">Parent Directory</a>		-	
 <a href="#">manual.pdf</a>	2024-03-30 01:05	49M	

Apache/2.4.41 Server at docs.win-test.com Port 80









# Index of /pdf

<u>Name</u>	<u>Last modified</u>	<u>Size</u>	<u>Description</u>
 <a href="#">Parent Directory</a>			-
 <a href="#">daily/</a>	2024-03-30 01:05		-
 <a href="#">downloads/</a>	2024-03-30 01:05		-

Apache/2.4.41 Server at docs.win-test.com Port 80

# Index of /pdf/daily



<u>Name</u>	<u>Last modified</u>	<u>Size</u>	<u>Description</u>
 <a href="#">Parent Directory</a>		-	
 <a href="#">win-test-20240330.pdf</a>	2024-03-30 01:05	49M	
 <a href="#">win-test-20240329.pdf</a>	2024-03-29 01:05	49M	
 <a href="#">win-test-20240328.pdf</a>	2024-03-28 01:05	49M	
 <a href="#">win-test-20240327.pdf</a>	2024-03-27 01:05	49M	
 <a href="#">win-test-20240326.pdf</a>	2024-03-26 01:05	49M	
 <a href="#">win-test-20240325.pdf</a>	2024-03-25 01:05	49M	
 <a href="#">win-test-20240324.pdf</a>	2024-03-24 01:05	49M	
 <a href="#">win-test-20240323.pdf</a>	2024-03-23 01:05	49M	
 <a href="#">win-test-20240322.pdf</a>	2024-03-22 01:04	49M	
 <a href="#">win-test-20240321.pdf</a>	2024-03-21 01:05	49M	
 <a href="#">win-test-20240320.pdf</a>	2024-03-20 01:04	49M	
 <a href="#">win-test-20240319.pdf</a>	2024-03-19 01:05	49M	
 <a href="#">win-test-20240318.pdf</a>	2024-03-18 01:04	49M	
 <a href="#">win-test-20240317.pdf</a>	2024-03-17 01:05	49M	
 <a href="#">win-test-20240316.pdf</a>	2024-03-16 01:05	49M	
 <a href="#">win-test-20240315.pdf</a>	2024-03-15 01:05	49M	
 <a href="#">win-test-20240314.pdf</a>	2024-03-14 01:05	49M	
 <a href="#">win-test-20240313.pdf</a>	2024-03-13 01:05	49M	
 <a href="#">win-test-20240312.pdf</a>	2024-03-12 01:05	49M	
 <a href="#">win-test-20240311.pdf</a>	2024-03-11 01:05	49M	
 <a href="#">win-test-20240310.pdf</a>	2024-03-10 01:05	49M	
 <a href="#">win-test-20240309.pdf</a>	2024-03-09 01:05	49M	
 <a href="#">win-test-20240308.pdf</a>	2024-03-08 01:05	49M	
 <a href="#">win-test-20240307.pdf</a>	2024-03-07 01:05	49M	
 <a href="#">win-test-20240306.pdf</a>	2024-03-06 01:05	49M	
 <a href="#">win-test-20240305.pdf</a>	2024-03-05 01:05	49M	
 <a href="#">win-test-20240304.pdf</a>	2024-03-04 01:04	49M	
 <a href="#">win-test-20240303.pdf</a>	2024-03-03 01:05	49M	
 <a href="#">win-test-20240302.pdf</a>	2024-03-02 01:04	49M	
 <a href="#">win-test-20240301.pdf</a>	2024-03-01 01:06	49M	
 <a href="#">win-test-20240229.pdf</a>	2024-02-29 01:04	49M	

<u>Name</u>	<u>Last modified</u>	<u>Size</u>	<u>Description</u>
 <a href="#">NEW_win-test.pdf</a>	2024-03-30 01:05	9.8M	

---



Apache/2.4.41 Server at docs.win-test.com Port 80

# Index of /pdf/downloads

<u>Name</u>	<u>Last modified</u>	<u>Size</u>	<u>Description</u>
 <a href="#">Parent Directory</a>		-	
 <a href="#">manual.pdf</a>	2024-03-30 01:05	49M	

Apache/2.4.41 Server at docs.win-test.com Port 80

# Index of /pdf

<u>Name</u>	<u>Last modified</u>	<u>Size</u>	<u>Description</u>
 <a href="#">Parent Directory</a>			-
 <a href="#">downloads/</a>	2024-03-30 01:05		-
 <a href="#">daily/</a>	2024-03-30 01:05		-

Apache/2.4.41 Server at docs.win-test.com Port 80

# Check Partial and Np1 Files

From Win-Test Wiki

[Jump to navigation](#) [Jump to search](#)

The [Check Partial Window](#) displays callsigns whenever 2 or 3 characters are entered in the callsign field, based on the contents of certain files.

## Contents

- [1 Check Partial and N+1 Files](#)
  - ◆ [1.1 Location](#)
    - ◇ [1.1.1 Virtual Store](#)
    - ◇ [1.1.2 Viewing hidden files and folders](#)
      - [1.1.2.1 Windows XP](#)
      - [1.1.2.2 Windows Vista, Windows 7 and 10](#)
  - ◆ [1.2 Naming Convention](#)
  - ◆ [1.3 Search order](#)
  - ◆ [1.4 Files names list](#)

## Check Partial and N+1 Files

Pre version 3.3.5, Win-Test used a native database format for Check Partial and N+1 checking, called the DTB database file format which was mostly associated with a specific contest.

With that version, both the SCP and the DTA formats are additionally supported by Win-Test.

- Win-Test accepts SCP plain text files. SCP stands for Super Check Partial. The structure of the file is simple, one callsign per line, no ordering required. SCP is the preferred format for Win-Test.
- Secondly CT compatible binary DTA files (MASTER.DTA) are supported by Win-Test. These files are usually available before the major contest.
  - ◆ <http://www.supercheckpartial.com> this is the main reference site for SCP and DTA files. Fully updated.
  - ◆ <http://www.qsl.net/k1tr/master.htm> this site maintain a MASTER.DTA file for North American VHF/UHF Contests
  - ◆ <http://www.datomonline.com/suppfiles.html> this site was used by NA users (actually outdated!)
- Finally, DTB files are supported for backward compatibility.

Win-Test now accepts specialized Check Partial files, separated by band and by mode for any given contest. This should improve log accuracy and QSO rate. To get more details on how to name these files so that they can be found by Win-Test in the right situation, see [Naming Convention](#) below, or read [http://download.win-test.com/files/checkPartial/READ\\_ME.TXT](http://download.win-test.com/files/checkPartial/READ_ME.TXT).

**Note:** If a contest-specific check partial file or database (.dtb) file is present in the Win-Test directory shown below, it will be used as the default file for partial and N+1 checks *instead of* **MASTER.SCP**. To override this, use the file name **DEFAULT.SCP** or **DEFAULT.DTA** instead of **MASTER.SCP** or **MASTER.DTA**.

## Location

These files must be located in the appropriate directory:

For Win-Test version 4, save check partial files in:

- Windows XP: **C:\Documents and Settings\All Users\Application Data\Win-Test\databases\**
- Windows Vista, Windows 7 or 10: **C:\ProgramData\Win-Test\databases\**

**Note:** When renaming or saving **MASTER.SCP**, **DEFAULT.SCP** etc. make sure that the file name is not **MASTER.SCP.SCP**, or **DEFAULT.SCP.txt**, which will prevent these files from loading. See instructions below explaining how to make the full file name visible in Windows.

For Win-Test version 3:

- **C:\Program Files\Win-Test\** (or the Win-Test installation directory)

## Virtual Store

If you do not or can not run Win-test as Administrator, downloaded **.SCP**, **.dat** and **.DTB** files may end up in a so-called **Virtual Store** in `%LOCALAPPDATA%\VirtualStore\ProgramData\Win-Test\...` or `countryFiles`.

Win-Test's priority is to search the Virtual Store first and then in the standard directory. So if you find that Win-Test is not loading your updated **.DTA**, **.dat**, **.DTA** or **.SCP** file, check the Virtual Store and delete older instances of these files.

## Viewing hidden files and folders

By default, Windows hides some of these directories, making them invisible. You can view them via [File | Explore | /databases directory](#), or even better, make all hidden folders visible, and make all file extensions (.SCP, .DTA, etc.) visible too.

To display hidden files and folders and extensions:

### Windows XP

1. Open **Folder Options** in the Windows **Control Panel**.
  1. Click **Start**, and then click **Control Panel**.
  2. Double-click **Folder Options**.
2. On the **View** tab, under **Hidden files and folders**, click **Show hidden files and folders**.
3. *Remove* the check mark next to **Hide extensions for known file types**.
4. Click **OK**.

### Windows Vista, Windows 7 and 10

1. Open Folder Options by clicking the **Start** button, clicking **Control Panel**, clicking **Appearance and Personalization**, and then clicking **Folder Options**.
2. Click the **View** tab.

3. Under **Advanced settings**, click **Show hidden files, folders, and drives**.
4. *Remove* the check mark next to **Hide extensions for known file types**.
5. Click **OK**.

## Naming Convention

Win-Test allows the usage of 3 different formats :

- **SCP** files : Plain textual - One capitalized callsign per line. No ordering required.
- **DTA** files : Binary CT format - You can use MEdit (<http://dxatlas.com/MEdit/Files/MEdit.zip>) to work on these files
- **DTB** files : Binary WT format - Kept for backward compatibility.

Note that the "compact" DTA format offered by MEdit is accepted by WT.

The preferred format is SCP.

From version 3.3.0, WT allows one file per band, mode and contest.

This means that one can build specialized files for a specific contest, and even for one band and/or mode in that contest.

The naming convention of the check partial files are (where \* stands for SCP or DTA or DTB) :

- fileName\_band\_mode.\*
- fileName\_mode.\*
- fileName\_band.\*
- fileName.\*

## Search order

The first matching file is used for check partial searches

1. DEFAULT.\*
2. fileName\_band\_mode.\*
3. fileName\_mode.\*
4. fileName\_band.\*
5. fileName.\*
6. MASTER.\*
7. HF.\* or VHF.\*

If more than one type of file exists with the same name, the search order is based on the file extension:

1. \*.DTA
2. \*.SCP
3. \*.DTB

So if both MASTER.DTA and MASTER.SCP exist, but no other files, MASTER.DTA will be used.



If Win-Test does not find a specialized file for the current contest, it will use the MASTER.\* files, or if that is not found, the HF.\* and VHF.\* files.

To see which file is actually being used, right click on the Check Partial Window and select **Used files list...**:

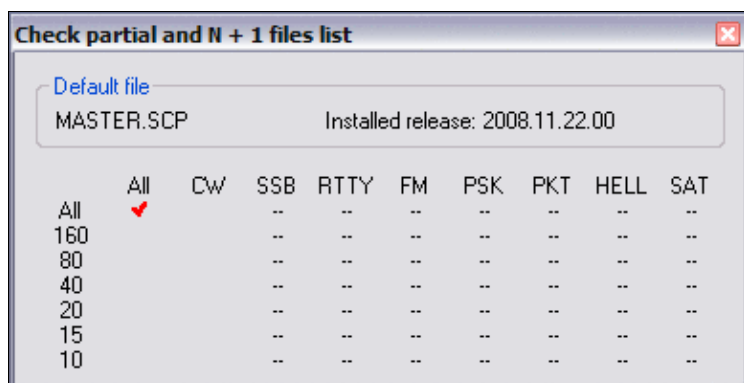

Right click on Check Partial window and select Used files list... to determine which file is being used for super check

## Files names list

```

9KCC15      : 9K CC contest
AGCW_HNY    : AGCW Happy New Year contest
AA_DX       : All Asian contest - DX side
AA_AA       : All Asian contest - Asian side
ARI_DX      : ARI contest - DX side
ARI_I       : ARI contest - Italian side
ARI_SEZIONI : ARI Sezioni contest
ARRL_10_DX  : ARRL 10m contest - DX side
ARRL_10_USVE : ARRL 10m contest - K/VE side
ARRL_160_DX : ARRL 160m contest - DX side
ARRL_160_USVE : ARRL 160m contest - K/VE side
ARRL_DX_DX  : ARRL DX contest - DX side
ARRL_DX_USVE : ARRL DX contest - K/VE side
ARRL_FD     : ARRL Field Day
ARRL_SS     : ARRL SweepStakes
BALTIK      : Baltic contest
CIS         : CIS contest
CQM         : CQ-M contest
CQWW_160M   : CQWW DX 160m contest
CQWW        : CQWW DX contest
WPX         : CQWW WPX contest
CROATIAN    : Croatian contest
DARC_10     : DARC 10m contest
DARC_XMAS   : DARC X-Mas contest
EU_HF       : EU HF Championship
EU_SPRINT   : EU Sprint
FOC_MARATHON : FOC Marathon
GACW        : GACW DX contest
HADX        : HA DX contest
HELVETIA_DX : Helvatia contest (DX side)
HELVETIA_HB : Helvetia contest (HB side)
IARU_FD_R1  : IARU Field Day Rgn 1
IARU_HF     : IARU HF championships
IOTA        : IOTA contest
JIDX_DX     : JIDX contest (DX side)
JIDX_JA     : JIDX contest (JA side)
    
```

## Win-Test Wiki

KCJ : KCJ contest  
KCJ\_160 : KCJ Top band contest  
KOS : King Of Spain contest  
LZ\_DX : LZ DX contest  
LOTW : LOTW contest  
NA\_SPRINT : North American Sprint  
NAQP : North American QSO Party  
NRAU\_BALTIC : NRAU Baltic contest  
OC\_DX\_DX : Oceania DX contest (DX side)  
OC\_DX\_OC : Oceania DX contest (Oceania side)  
OKOM\_DX\_DX : OK/OM DX contest (DX side)  
OKOM\_DX\_OKOM : OK/OM DX contest (OK/OM side)  
PACC\_DX : PACC contest (DX side)  
PACC\_PA : PACC contest (PA side)  
TX\_QP : TX QSO Party  
RAC : RAC Canaday Day and RAC Canada Winter contests  
RDAC\_DX : RDA contest (DX side)  
RDAC\_UA : RDA contest (Russian side)  
RDXC : Russian DX contest  
REF\_HF\_DX : REF HF (DX side)  
REF\_HF\_F : REF HF (F side)  
REF\_160\_DX : REF 160m (DX side)  
REF\_160\_F : REF 160m (F side)  
RSGB\_1510\_DX : RSGB 15/10 (DX side)  
RSGB\_1510\_UK : RSGB 15/10 (UK side)  
RSGB\_160\_DX : RSGB 160m (DX side)  
RSGB\_160\_UK : RSGB 160m (UK side)  
RSGB\_80\_CC : RSGB 80 CC contest  
RSGB\_AFS : RSGB AFS  
RSGB\_CMW : RSGB Commonwealth  
R\_160\_DX : Russian 160 (DX side)  
R\_160\_UA : Russian 160 (UA side)  
SAC\_DX : SAC (DX side)  
SAC\_SC : SAC (Scandinavian side)  
SP\_DX\_DX : SP DX contest (DX side)  
SP\_DX\_SP : SP DX contest (SP side)  
STEW\_PERRY : Stew Perry Challenge  
TOEC : TOE contest  
UBA\_DX : UBA DX contest  
UBA\_SPRING\_DX : UBA Spring (DX side)  
UBA\_SPRING\_ON : UBA Spring (ON side)  
UFT\_HF : UFT HF contest  
UK\_DX : Ukranian DX contest  
WAE\_DX : WAE contest (DX side)  
WAE\_EU : WAE contest (EU side)  
WAG\_DX : WAG (DX side)  
WAG\_DL : WAG (DL side)  
YO\_DX\_DX : YO DX contest (DX side)  
YO\_DX\_YO : YO DX contest (YO side)  
YU\_DX : YU DX contest

For example, if you want to use a specific ARRL DX (DX side) for 80m you must name it :

ARRL\_DX\_DX\_80.\* (where \* stands for SCP or DTA or DTB)

## Namespaces

- [Page](#)
- [Discussion](#)

## Variants

## Views

- [Read](#)
- [View source](#)
- [View history](#)

## More

- This page was last edited on 2 January 2022, at 08:50.

- [Privacy policy](#)
- [About Win-Test Wiki](#)
- [Disclaimers](#)



# Check Partial and Np1 Files

From Win-Test Wiki

[Jump to navigation](#) [Jump to search](#)

The [Check Partial Window](#) displays callsigns whenever 2 or 3 characters are entered in the callsign field, based on the contents of certain files.

## Contents

- [1 Check Partial and N+1 Files](#)
  - ◆ [1.1 Location](#)
    - ◇ [1.1.1 Virtual Store](#)
    - ◇ [1.1.2 Viewing hidden files and folders](#)
      - [1.1.2.1 Windows XP](#)
      - [1.1.2.2 Windows Vista, Windows 7 and 10](#)
  - ◆ [1.2 Naming Convention](#)
  - ◆ [1.3 Search order](#)
  - ◆ [1.4 Files names list](#)

## Check Partial and N+1 Files

Pre version 3.3.5, Win-Test used a native database format for Check Partial and N+1 checking, called the DTB database file format which was mostly associated with a specific contest.

With that version, both the SCP and the DTA formats are additionally supported by Win-Test.

- Win-Test accepts SCP plain text files. SCP stands for Super Check Partial. The structure of the file is simple, one callsign per line, no ordering required. SCP is the preferred format for Win-Test.
- Secondly CT compatible binary DTA files (MASTER.DTA) are supported by Win-Test. These files are usually available before the major contest.
  - ◆ <http://www.supercheckpartial.com> this is the main reference site for SCP and DTA files. Fully updated.
  - ◆ <http://www.qsl.net/k1tr/master.htm> this site maintain a MASTER.DTA file for North American VHF/UHF Contests
  - ◆ <http://www.datomonline.com/suppfiles.html> this site was used by NA users (actually outdated!)
- Finally, DTB files are supported for backward compatibility.

Win-Test now accepts specialized Check Partial files, separated by band and by mode for any given contest. This should improve log accuracy and QSO rate. To get more details on how to name these files so that they can be found by Win-Test in the right situation, see [Naming Convention](#) below, or read [http://download.win-test.com/files/checkPartial/READ\\_ME.TXT](http://download.win-test.com/files/checkPartial/READ_ME.TXT).

**Note:** If a contest-specific check partial file or database (.dtb) file is present in the Win-Test directory shown below, it will be used as the default file for partial and N+1 checks *instead of* **MASTER.SCP**. To override this, use the file name **DEFAULT.SCP** or **DEFAULT.DTA** instead of **MASTER.SCP** or **MASTER.DTA**.

## Location

These files must be located in the appropriate directory:

For Win-Test version 4, save check partial files in:

- Windows XP: **C:\Documents and Settings\All Users\Application Data\Win-Test\databases\**
- Windows Vista, Windows 7 or 10: **C:\ProgramData\Win-Test\databases\**

**Note:** When renaming or saving **MASTER.SCP**, **DEFAULT.SCP** etc. make sure that the file name is not **MASTER.SCP.SCP**, or **DEFAULT.SCP.txt**, which will prevent these files from loading. See instructions below explaining how to make the full file name visible in Windows.

For Win-Test version 3:

- **C:\Program Files\Win-Test\** (or the Win-Test installation directory)

## Virtual Store

If you do not or can not run Win-test as Administrator, downloaded **.SCP**, **.dat** and **.DTB** files may end up in a so-called **Virtual Store** in `%LOCALAPPDATA%\VirtualStore\ProgramData\Win-Test\...` or `countryFiles`.

Win-Test's priority is to search the Virtual Store first and then in the standard directory. So if you find that Win-Test is not loading your updated **.DTA**, **.dat**, **.DTA** or **.SCP** file, check the Virtual Store and delete older instances of these files.

## Viewing hidden files and folders

By default, Windows hides some of these directories, making them invisible. You can view them via [File | Explore | /databases directory](#), or even better, make all hidden folders visible, and make all file extensions (.SCP, .DTA, etc.) visible too.

To display hidden files and folders and extensions:

### Windows XP

1. Open **Folder Options** in the Windows **Control Panel**.
  1. Click **Start**, and then click **Control Panel**.
  2. Double-click **Folder Options**.
2. On the **View** tab, under **Hidden files and folders**, click **Show hidden files and folders**.
3. *Remove* the check mark next to **Hide extensions for known file types**.
4. Click **OK**.

### Windows Vista, Windows 7 and 10

1. Open Folder Options by clicking the **Start** button, clicking **Control Panel**, clicking **Appearance and Personalization**, and then clicking **Folder Options**.
2. Click the **View** tab.

3. Under **Advanced settings**, click **Show hidden files, folders, and drives**.
4. *Remove* the check mark next to **Hide extensions for known file types**.
5. Click **OK**.

## Naming Convention

Win-Test allows the usage of 3 different formats :

- **SCP** files : Plain textual - One capitalized callsign per line. No ordering required.
- **DTA** files : Binary CT format - You can use MEdit (<http://dxatlas.com/MEdit/Files/MEdit.zip>) to work on these files
- **DTB** files : Binary WT format - Kept for backward compatibility.

Note that the "compact" DTA format offered by MEdit is accepted by WT.

The preferred format is SCP.

From version 3.3.0, WT allows one file per band, mode and contest.

This means that one can build specialized files for a specific contest, and even for one band and/or mode in that contest.

The naming convention of the check partial files are (where \* stands for SCP or DTA or DTB) :

- fileName\_band\_mode.\*
- fileName\_mode.\*
- fileName\_band.\*
- fileName.\*

## Search order

The first matching file is used for check partial searches

1. DEFAULT.\*
2. fileName\_band\_mode.\*
3. fileName\_mode.\*
4. fileName\_band.\*
5. fileName.\*
6. MASTER.\*
7. HF.\* or VHF.\*

If more than one type of file exists with the same name, the search order is based on the file extension:

1. \*.DTA
2. \*.SCP
3. \*.DTB

So if both MASTER.DTA and MASTER.SCP exist, but no other files, MASTER.DTA will be used.

If Win-Test does not find a specialized file for the current contest, it will use the MASTER.\* files, or if that is not found, the HF.\* and VHF.\* files.

To see which file is actually being used, right click on the Check Partial Window and select **Used files list...**:

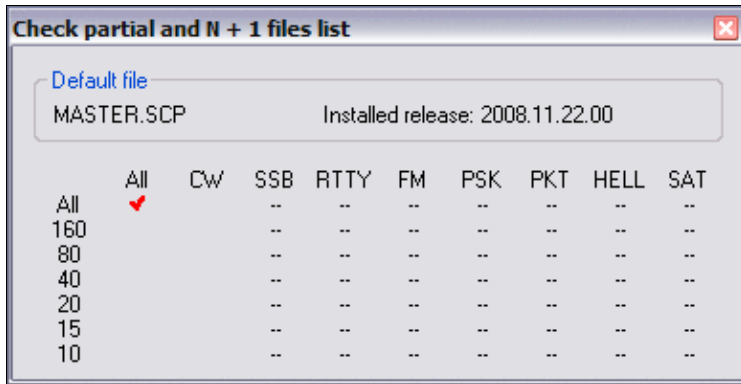

Right click on Check Partial window and select Used files list... to determine which file is being used for super check

## Files names list

```

9KCC15      : 9K CC contest
AGCW_HNY    : AGCW Happy New Year contest
AA_DX       : All Asian contest - DX side
AA_AA       : All Asian contest - Asian side
ARI_DX      : ARI contest - DX side
ARI_I       : ARI contest - Italian side
ARI_SEZIONI : ARI Sezioni contest
ARRL_10_DX  : ARRL 10m contest - DX side
ARRL_10_USVE : ARRL 10m contest - K/VE side
ARRL_160_DX : ARRL 160m contest - DX side
ARRL_160_USVE : ARRL 160m contest - K/VE side
ARRL_DX_DX  : ARRL DX contest - DX side
ARRL_DX_USVE : ARRL DX contest - K/VE side
ARRL_FD     : ARRL Field Day
ARRL_SS     : ARRL SweepStakes
BALTIK     : Baltic contest
CIS        : CIS contest
CQM        : CQ-M contest
CQWW_160M  : CQWW DX 160m contest
CQWW       : CQWW DX contest
WPX        : CQWW WPX contest
CROATIAN   : Croatian contest
DARC_10    : DARC 10m contest
DARC_XMAS  : DARC X-Mas contest
EU_HF      : EU HF Championship
EU_SPRINT  : EU Sprint
FOC_MARATHON : FOC Marathon
GACW       : GACW DX contest
HADX       : HA DX contest
HELVETIA_DX : Helvatia contest (DX side)
HELVETIA_HB : Helvetia contest (HB side)
IARU_FD_R1 : IARU Field Day Rgn 1
IARU_HF    : IARU HF championships
IOTA       : IOTA contest
JIDX_DX    : JIDX contest (DX side)
JIDX_JA    : JIDX contest (JA side)
    
```

## Win-Test Wiki

KCJ : KCJ contest  
KCJ\_160 : KCJ Top band contest  
KOS : King Of Spain contest  
LZ\_DX : LZ DX contest  
LOTW : LOTW contest  
NA\_SPRINT : North American Sprint  
NAQP : North American QSO Party  
NRAU\_BALTIC : NRAU Baltic contest  
OC\_DX\_DX : Oceania DX contest (DX side)  
OC\_DX\_OC : Oceania DX contest (Oceania side)  
OKOM\_DX\_DX : OK/OM DX contest (DX side)  
OKOM\_DX\_OKOM : OK/OM DX contest (OK/OM side)  
PACC\_DX : PACC contest (DX side)  
PACC\_PA : PACC contest (PA side)  
TX\_QP : TX QSO Party  
RAC : RAC Canaday Day and RAC Canada Winter contests  
RDAC\_DX : RDA contest (DX side)  
RDAC\_UA : RDA contest (Russian side)  
RDXC : Russian DX contest  
REF\_HF\_DX : REF HF (DX side)  
REF\_HF\_F : REF HF (F side)  
REF\_160\_DX : REF 160m (DX side)  
REF\_160\_F : REF 160m (F side)  
RSGB\_1510\_DX : RSGB 15/10 (DX side)  
RSGB\_1510\_UK : RSGB 15/10 (UK side)  
RSGB\_160\_DX : RSGB 160m (DX side)  
RSGB\_160\_UK : RSGB 160m (UK side)  
RSGB\_80\_CC : RSGB 80 CC contest  
RSGB\_AFS : RSGB AFS  
RSGB\_CMW : RSGB Commonwealth  
R\_160\_DX : Russian 160 (DX side)  
R\_160\_UA : Russian 160 (UA side)  
SAC\_DX : SAC (DX side)  
SAC\_SC : SAC (Scandinavian side)  
SP\_DX\_DX : SP DX contest (DX side)  
SP\_DX\_SP : SP DX contest (SP side)  
STEW\_PERRY : Stew Perry Challenge  
TOEC : TOE contest  
UBA\_DX : UBA DX contest  
UBA\_SPRING\_DX : UBA Spring (DX side)  
UBA\_SPRING\_ON : UBA Spring (ON side)  
UFT\_HF : UFT HF contest  
UK\_DX : Ukranian DX contest  
WAE\_DX : WAE contest (DX side)  
WAE\_EU : WAE contest (EU side)  
WAG\_DX : WAG (DX side)  
WAG\_DL : WAG (DL side)  
YO\_DX\_DX : YO DX contest (DX side)  
YO\_DX\_YO : YO DX contest (YO side)  
YU\_DX : YU DX contest

For example, if you want to use a specific ARRL DX (DX side) for 80m you must name it :

ARRL\_DX\_DX\_80.\* (where \* stands for SCP or DTA or DTB)

## Namespaces

- [Page](#)
- [Discussion](#)



## Variants

## Views

- [Read](#)
- [View source](#)
- [View history](#)

## More

- This page was last edited on 2 January 2022, at 08:50.

- [Privacy policy](#)
- [About Win-Test Wiki](#)
- [Disclaimers](#)



# Multi-op/Clearing all logs before the start

From Win-Test Wiki

[Jump to navigation](#) [Jump to search](#)

Often in a multi-operator networked environment, QSOs are logged before the actual start of the contest for practice purposes, and also to test the network for RFI issues. How do you remove these QSOs from all logs right before the start of the contest?

It is possible to do this without having to exit Win-Test, rename files, etc.

## Saving the Practice Log

First, to save the practice log, one machine should make a copy of the `.wt4` file beforehand, using Windows Explorer, or the `copy` command in a Windows Command Prompt window. You may also use the **SAVELOG** text command to back up the practice log provided Automatic Backup has been properly configured. Or use the **COPYLOG** text command that duplicates the current log file (`.wt4`) in the current log directory with a timestamp (to the nearest second) added in its name.

## Using the Remote Commands dialog to clear the log on all networked machines

To clear all logs on all machines, enter the **REMOTE** text command on a single "control" machine. This displays the Remote commands dialog. This dialog lets one machine run a single text command on all networked machines and the local machine, simultaneously.

Run the following text commands in this order to clear all QSOs from all logs:

1. **NOSYNC** -- disables log synchronization. You cannot delete QSOs without doing this first.
2. **CLEARLOGNOW** -- this removes all QSOs without asking for confirmation. **Use with caution!** This may take some time to complete. Watch the gab window for confirmation before executing the next command.
3. **SYNC** -- enables log synchronization to resume

You will need to use the Remote Commands dialog three times to send all three commands. Each time, be sure to press **[A11]** to select all remote PCs, then check "Apply this command also locally", then type the command and press **[OK]**.

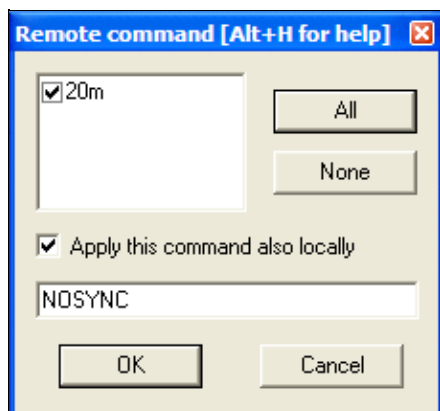

The **REMOTE** dialog sends the NOSYNC command to the local PC and to all networked PCs. After each command executes, the Gab window will display a message confirming that the command has been executed remotely.

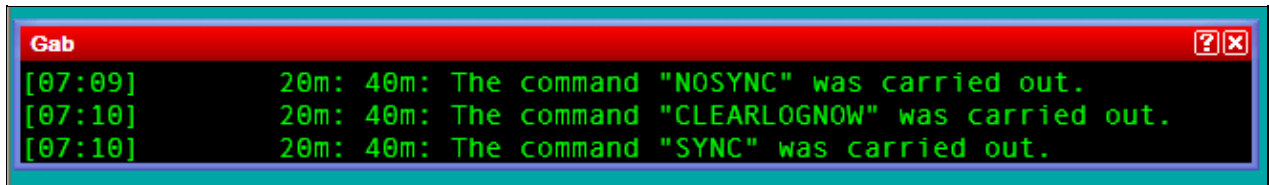
A screenshot of a window titled "Gab" with a red title bar and a black background. The window contains three lines of green text: "[07:09] 20m: 40m: The command 'NOSYNC' was carried out.", "[07:10] 20m: 40m: The command 'CLEARLOGNOW' was carried out.", and "[07:10] 20m: 40m: The command 'SYNC' was carried out." The window has standard Windows window controls (minimize, maximize, close) in the top right corner.

```
Gab
[07:09] 20m: 40m: The command "NOSYNC" was carried out.
[07:10] 20m: 40m: The command "CLEARLOGNOW" was carried out.
[07:10] 20m: 40m: The command "SYNC" was carried out.
```

The gab window confirms that each remote command has been executed. After completing this procedure, all networked machines should be cleared to zero QSOs, and you are ready to start the contest.

## See also

- [Automatic backup](#)
- [Remote commands dialog](#)
- [Disable log synchronization on network](#)
- [Deleting all QSOs](#)
- [Multi-op contesting](#)

## Namespaces

- [Page](#)
- [Discussion](#)

## Variants

## Views

- [Read](#)
- [View source](#)
- [View history](#)

## More

- This page was last edited on 30 December 2021, at 13:14.
- [Privacy policy](#)
- [About Win-Test Wiki](#)
- [Disclaimers](#)



# Multi-op/Clearing all logs before the start

From Win-Test Wiki

[Jump to navigation](#) [Jump to search](#)

Often in a multi-operator networked environment, QSOs are logged before the actual start of the contest for practice purposes, and also to test the network for RFI issues. How do you remove these QSOs from all logs right before the start of the contest?

It is possible to do this without having to exit Win-Test, rename files, etc.

## Saving the Practice Log

First, to save the practice log, one machine should make a copy of the `.wt4` file beforehand, using Windows Explorer, or the `copy` command in a Windows Command Prompt window. You may also use the **SAVELOG** text command to back up the practice log provided Automatic Backup has been properly configured. Or use the **COPYLOG** text command that duplicates the current log file (`.wt4`) in the current log directory with a timestamp (to the nearest second) added in its name.

## Using the Remote Commands dialog to clear the log on all networked machines

To clear all logs on all machines, enter the **REMOTE** text command on a single "control" machine. This displays the Remote commands dialog. This dialog lets one machine run a single text command on all networked machines and the local machine, simultaneously.

Run the following text commands in this order to clear all QSOs from all logs:

1. **NOSYNC** -- disables log synchronization. You cannot delete QSOs without doing this first.
2. **CLEARLOGNOW** -- this removes all QSOs without asking for confirmation. **Use with caution!** This may take some time to complete. Watch the gab window for confirmation before executing the next command.
3. **SYNC** -- enables log synchronization to resume

You will need to use the Remote Commands dialog three times to send all three commands. Each time, be sure to press **[A11]** to select all remote PCs, then check "Apply this command also locally", then type the command and press **[OK]**.

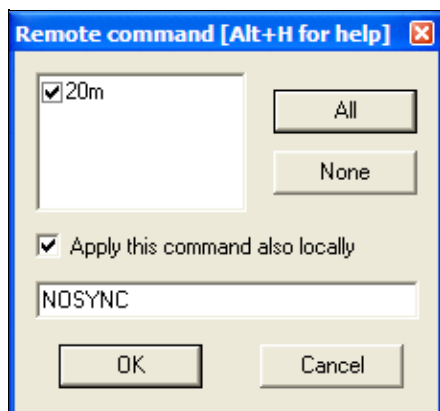

The **REMOTE** dialog sends the NOSYNC command to the local PC and to all networked PCs. After each command executes, the Gab window will display a message confirming that the command has been executed remotely.

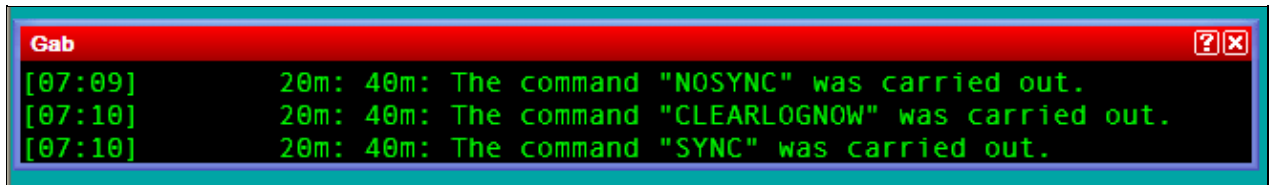
A screenshot of a window titled "Gab" with a red title bar and a black background. The window contains three lines of green text: "[07:09] 20m: 40m: The command 'NOSYNC' was carried out.", "[07:10] 20m: 40m: The command 'CLEARLOGNOW' was carried out.", and "[07:10] 20m: 40m: The command 'SYNC' was carried out." The window has a standard Windows-style border with a question mark and close button in the top right corner.

```
Gab
[07:09] 20m: 40m: The command "NOSYNC" was carried out.
[07:10] 20m: 40m: The command "CLEARLOGNOW" was carried out.
[07:10] 20m: 40m: The command "SYNC" was carried out.
```

The gab window confirms that each remote command has been executed. After completing this procedure, all networked machines should be cleared to zero QSOs, and you are ready to start the contest.

## See also

- [Automatic backup](#)
- [Remote commands dialog](#)
- [Disable log synchronization on network](#)
- [Deleting all QSOs](#)
- [Multi-op contesting](#)

## Namespaces

- [Page](#)
- [Discussion](#)

## Variants

## Views

- [Read](#)
- [View source](#)
- [View history](#)

## More

- This page was last edited on 30 December 2021, at 13:14.

- [Privacy policy](#)
- [About Win-Test Wiki](#)
- [Disclaimers](#)



# SO1R/Cluster

From Win-Test Wiki

[Jump to navigation](#) [Jump to search](#)

## Contents

- [1 Use of Cluster Spots](#)
  - ◆ [1.1 New Multipliers](#)
  - ◆ [1.2 New Stations](#)
  - ◆ [1.3 Orientation](#)

## Use of Cluster Spots

Win-Test allows you to establish a DX Cluster connection, either through a regular packet link (using a TNC) or through the Internet by using the wtDxTelnet application. DX Spots you receive from the cluster can be filtered by Win-Test and be lined up in a way that does not distract you from the contest operation.

There are several uses of Packet spots:

- New multipliers on the same band or different bands
- New stations
- Orientation for S&P operation

Once you have DX-Cluster set up, open up the Announce Window (**Alt-A**) and let the spots roll in.

## New Multipliers

New multipliers are the biggest attraction on the DX Cluster. They are displayed in green color or even in blue color, if they are double mults. Simply double-click on a spot and the radio will jump to that spot within a few milliseconds. Work the new mult. Now **Alt-F4** will bring you back to the original frequency.

Learn how to better use this feature and you will be able to leave your CQ frequency alone for a few seconds, work the new mult and return so that nobody even notices you were away.

## New Stations

In the course of the contest, all mults have been worked and CQs bring little results. Now is the right time to go after these spots which are not new mults but at least new stations. Since you have learnt how to quickly jump back and forth, why not use the same strategy to work a new station every once in a while?

## Orientation

Even if you have worked almost everything on the band, the cluster spots come in handy when you are in search and pounce mode. With the band map activated, the spots will save you time when trying to identify stations or sometimes even to find a clear spot on a band to call CQ.

## Namespaces

- [Page](#)
- [Discussion](#)

## Variants

## Views

- [Read](#)
- [View source](#)
- [View history](#)

## More

- This page was last edited on 6 June 2007, at 08:18.

- [Privacy policy](#)
- [About Win-Test Wiki](#)
- [Disclaimers](#)



# SO1R/Cluster

From Win-Test Wiki

[Jump to navigation](#) [Jump to search](#)

## Contents

- [1 Use of Cluster Spots](#)
  - ◆ [1.1 New Multipliers](#)
  - ◆ [1.2 New Stations](#)
  - ◆ [1.3 Orientation](#)

## Use of Cluster Spots

Win-Test allows you to establish a DX Cluster connection, either through a regular packet link (using a TNC) or through the Internet by using the wtDxTelnet application. DX Spots you receive from the cluster can be filtered by Win-Test and be lined up in a way that does not distract you from the contest operation.

There are several uses of Packet spots:

- New multipliers on the same band or different bands
- New stations
- Orientation for S&P operation

Once you have DX-Cluster set up, open up the Announce Window (**Alt-A**) and let the spots roll in.

## New Multipliers

New multipliers are the biggest attraction on the DX Cluster. They are displayed in green color or even in blue color, if they are double mults. Simply double-click on a spot and the radio will jump to that spot within a few milliseconds. Work the new mult. Now **Alt-F4** will bring you back to the original frequency.

Learn how to better use this feature and you will be able to leave your CQ frequency alone for a few seconds, work the new mult and return so that nobody even notices you were away.

## New Stations

In the course of the contest, all mults have been worked and CQs bring little results. Now is the right time to go after these spots which are not new mults but at least new stations. Since you have learnt how to quickly jump back and forth, why not use the same strategy to work a new station every once in a while?

## Orientation

Even if you have worked almost everything on the band, the cluster spots come in handy when you are in search and pounce mode. With the band map activated, the spots will save you time when trying to identify stations or sometimes even to find a clear spot on a band to call CQ.



## Namespaces

- [Page](#)
- [Discussion](#)

## Variants

## Views

- [Read](#)
- [View source](#)
- [View history](#)



























## More

- This page was last edited on 6 June 2007, at 08:18.

- [Privacy policy](#)
- [About Win-Test Wiki](#)
- [Disclaimers](#)



# Index of /pdf/daily



<u>Name</u>	<u>Last modified</u>	<u>Size</u>	<u>Description</u>
 <a href="#">Parent Directory</a>		-	
 <a href="#">win-test-20240229.pdf</a>	2024-02-29 01:04	49M	
 <a href="#">win-test-20240301.pdf</a>	2024-03-01 01:06	49M	
 <a href="#">win-test-20240302.pdf</a>	2024-03-02 01:04	49M	
 <a href="#">win-test-20240303.pdf</a>	2024-03-03 01:05	49M	
 <a href="#">win-test-20240304.pdf</a>	2024-03-04 01:04	49M	
 <a href="#">win-test-20240305.pdf</a>	2024-03-05 01:05	49M	
 <a href="#">win-test-20240306.pdf</a>	2024-03-06 01:05	49M	
 <a href="#">win-test-20240307.pdf</a>	2024-03-07 01:05	49M	
 <a href="#">win-test-20240308.pdf</a>	2024-03-08 01:05	49M	
 <a href="#">win-test-20240309.pdf</a>	2024-03-09 01:05	49M	
 <a href="#">win-test-20240310.pdf</a>	2024-03-10 01:05	49M	
 <a href="#">win-test-20240311.pdf</a>	2024-03-11 01:05	49M	
 <a href="#">win-test-20240312.pdf</a>	2024-03-12 01:05	49M	
 <a href="#">win-test-20240313.pdf</a>	2024-03-13 01:05	49M	
 <a href="#">win-test-20240314.pdf</a>	2024-03-14 01:05	49M	
 <a href="#">win-test-20240315.pdf</a>	2024-03-15 01:05	49M	
 <a href="#">win-test-20240316.pdf</a>	2024-03-16 01:05	49M	
 <a href="#">win-test-20240317.pdf</a>	2024-03-17 01:05	49M	
 <a href="#">win-test-20240318.pdf</a>	2024-03-18 01:04	49M	
 <a href="#">win-test-20240319.pdf</a>	2024-03-19 01:05	49M	
 <a href="#">win-test-20240320.pdf</a>	2024-03-20 01:04	49M	
 <a href="#">win-test-20240321.pdf</a>	2024-03-21 01:05	49M	
 <a href="#">win-test-20240322.pdf</a>	2024-03-22 01:04	49M	
 <a href="#">win-test-20240323.pdf</a>	2024-03-23 01:05	49M	
 <a href="#">win-test-20240324.pdf</a>	2024-03-24 01:05	49M	
 <a href="#">win-test-20240325.pdf</a>	2024-03-25 01:05	49M	
 <a href="#">win-test-20240326.pdf</a>	2024-03-26 01:05	49M	
 <a href="#">win-test-20240327.pdf</a>	2024-03-27 01:05	49M	
 <a href="#">win-test-20240328.pdf</a>	2024-03-28 01:05	49M	
 <a href="#">win-test-20240329.pdf</a>	2024-03-29 01:05	49M	
 <a href="#">NEW win-test.pdf</a>	2024-03-30 01:05	9.8M	

<u>Name</u>	<u>Last modified</u>	<u>Size</u>	<u>Description</u>
 <a href="#">win-test-20240330.pdf</a>	2024-03-30 01:05	49M	

---



Apache/2.4.41 Server at docs.win-test.com Port 80

# Index of /pdf/downloads

<u>Name</u>	<u>Last modified</u>	<u>Size</u>	<u>Description</u>
 <a href="#">Parent Directory</a>		-	
 <a href="#">manual.pdf</a>	2024-03-30 01:05	49M	



Apache/2.4.41 Server at docs.win-test.com Port 80

# Index of /pdf

<u>Name</u>	<u>Last modified</u>	<u>Size</u>	<u>Description</u>
 <a href="#">Parent Directory</a>		-	
 <a href="#">downloads/</a>	2024-03-30 01:05	-	
 <a href="#">daily/</a>	2024-03-30 01:05	-	



Apache/2.4.41 Server at docs.win-test.com Port 80

# Index of /pdf/downloads

<u>Name</u>	<u>Last modified</u>	<u>Size</u>	<u>Description</u>
 <a href="#">Parent Directory</a>		-	
 <a href="#">manual.pdf</a>	2024-03-30 01:05	49M	































Apache/2.4.41 Server at docs.win-test.com Port 80

# Index of /pdf

<u>Name</u>	<u>Last modified</u>	<u>Size</u>	<u>Description</u>
 <a href="#">Parent Directory</a>		-	
 <a href="#">daily/</a>	2024-03-30 01:05	-	
 <a href="#">downloads/</a>	2024-03-30 01:05	-	

Apache/2.4.41 Server at docs.win-test.com Port 80

# Index of /pdf/daily

<u>Name</u>	<u>Last modified</u>	<u>Size</u>	<u>Description</u>
 <a href="#">Parent Directory</a>		-	
 <a href="#">win-test-20240330.pdf</a>	2024-03-30 01:05	49M	
 <a href="#">NEW win-test.pdf</a>	2024-03-30 01:05	9.8M	
 <a href="#">win-test-20240329.pdf</a>	2024-03-29 01:05	49M	
 <a href="#">win-test-20240328.pdf</a>	2024-03-28 01:05	49M	
 <a href="#">win-test-20240327.pdf</a>	2024-03-27 01:05	49M	
 <a href="#">win-test-20240326.pdf</a>	2024-03-26 01:05	49M	
 <a href="#">win-test-20240325.pdf</a>	2024-03-25 01:05	49M	
 <a href="#">win-test-20240324.pdf</a>	2024-03-24 01:05	49M	
 <a href="#">win-test-20240323.pdf</a>	2024-03-23 01:05	49M	
 <a href="#">win-test-20240322.pdf</a>	2024-03-22 01:04	49M	
 <a href="#">win-test-20240321.pdf</a>	2024-03-21 01:05	49M	
 <a href="#">win-test-20240320.pdf</a>	2024-03-20 01:04	49M	
 <a href="#">win-test-20240319.pdf</a>	2024-03-19 01:05	49M	
 <a href="#">win-test-20240318.pdf</a>	2024-03-18 01:04	49M	
 <a href="#">win-test-20240317.pdf</a>	2024-03-17 01:05	49M	
 <a href="#">win-test-20240316.pdf</a>	2024-03-16 01:05	49M	
 <a href="#">win-test-20240315.pdf</a>	2024-03-15 01:05	49M	
 <a href="#">win-test-20240314.pdf</a>	2024-03-14 01:05	49M	
 <a href="#">win-test-20240313.pdf</a>	2024-03-13 01:05	49M	
 <a href="#">win-test-20240312.pdf</a>	2024-03-12 01:05	49M	
 <a href="#">win-test-20240311.pdf</a>	2024-03-11 01:05	49M	
 <a href="#">win-test-20240310.pdf</a>	2024-03-10 01:05	49M	
 <a href="#">win-test-20240309.pdf</a>	2024-03-09 01:05	49M	
 <a href="#">win-test-20240308.pdf</a>	2024-03-08 01:05	49M	
 <a href="#">win-test-20240307.pdf</a>	2024-03-07 01:05	49M	
 <a href="#">win-test-20240306.pdf</a>	2024-03-06 01:05	49M	
 <a href="#">win-test-20240305.pdf</a>	2024-03-05 01:05	49M	
 <a href="#">win-test-20240304.pdf</a>	2024-03-04 01:04	49M	
 <a href="#">win-test-20240303.pdf</a>	2024-03-03 01:05	49M	
 <a href="#">win-test-20240302.pdf</a>	2024-03-02 01:04	49M	
 <a href="#">win-test-20240301.pdf</a>	2024-03-01 01:06	49M	



























<u>Name</u>	<u>Last modified</u>	<u>Size</u>	<u>Description</u>
 <a href="#">win-test-20240229.pdf</a>	2024-02-29 01:04	49M	

---

Apache/2.4.41 Server at docs.win-test.com Port 80

# Index of /pdf/daily



<u>Name</u>	<u>Last modified</u>	<u>Size</u>	<u>Description</u>
 <a href="#">Parent Directory</a>		-	
 <a href="#">NEW win-test.pdf</a>	2024-03-30 01:05	9.8M	
 <a href="#">win-test-20240229.pdf</a>	2024-02-29 01:04	49M	
 <a href="#">win-test-20240301.pdf</a>	2024-03-01 01:06	49M	
 <a href="#">win-test-20240302.pdf</a>	2024-03-02 01:04	49M	
 <a href="#">win-test-20240303.pdf</a>	2024-03-03 01:05	49M	
 <a href="#">win-test-20240304.pdf</a>	2024-03-04 01:04	49M	
 <a href="#">win-test-20240305.pdf</a>	2024-03-05 01:05	49M	
 <a href="#">win-test-20240306.pdf</a>	2024-03-06 01:05	49M	
 <a href="#">win-test-20240307.pdf</a>	2024-03-07 01:05	49M	
 <a href="#">win-test-20240308.pdf</a>	2024-03-08 01:05	49M	
 <a href="#">win-test-20240309.pdf</a>	2024-03-09 01:05	49M	
 <a href="#">win-test-20240310.pdf</a>	2024-03-10 01:05	49M	
 <a href="#">win-test-20240311.pdf</a>	2024-03-11 01:05	49M	
 <a href="#">win-test-20240312.pdf</a>	2024-03-12 01:05	49M	
 <a href="#">win-test-20240313.pdf</a>	2024-03-13 01:05	49M	
 <a href="#">win-test-20240314.pdf</a>	2024-03-14 01:05	49M	
 <a href="#">win-test-20240315.pdf</a>	2024-03-15 01:05	49M	
 <a href="#">win-test-20240316.pdf</a>	2024-03-16 01:05	49M	
 <a href="#">win-test-20240317.pdf</a>	2024-03-17 01:05	49M	
 <a href="#">win-test-20240318.pdf</a>	2024-03-18 01:04	49M	
 <a href="#">win-test-20240319.pdf</a>	2024-03-19 01:05	49M	
 <a href="#">win-test-20240320.pdf</a>	2024-03-20 01:04	49M	
 <a href="#">win-test-20240321.pdf</a>	2024-03-21 01:05	49M	
 <a href="#">win-test-20240322.pdf</a>	2024-03-22 01:04	49M	
 <a href="#">win-test-20240323.pdf</a>	2024-03-23 01:05	49M	
 <a href="#">win-test-20240324.pdf</a>	2024-03-24 01:05	49M	
 <a href="#">win-test-20240325.pdf</a>	2024-03-25 01:05	49M	
 <a href="#">win-test-20240326.pdf</a>	2024-03-26 01:05	49M	
 <a href="#">win-test-20240327.pdf</a>	2024-03-27 01:05	49M	
 <a href="#">win-test-20240328.pdf</a>	2024-03-28 01:05	49M	
 <a href="#">win-test-20240329.pdf</a>	2024-03-29 01:05	49M	

<u>Name</u>	<u>Last modified</u>	<u>Size</u>	<u>Description</u>
 <a href="#">win-test-20240330.pdf</a>	2024-03-30 01:05	49M	

---



Apache/2.4.41 Server at docs.win-test.com Port 80

# Index of /pdf/downloads

<u>Name</u>	<u>Last modified</u>	<u>Size</u>	<u>Description</u>
 <a href="#">Parent Directory</a>		-	
 <a href="#">manual.pdf</a>	2024-03-30 01:05	49M	





Apache/2.4.41 Server at docs.win-test.com Port 80

# Index of /pdf

<u>Name</u>	<u>Last modified</u>	<u>Size</u>	<u>Description</u>
 <a href="#">Parent Directory</a>			-
 <a href="#">daily/</a>	2024-03-30 01:05		-
 <a href="#">downloads/</a>	2024-03-30 01:05		-

Apache/2.4.41 Server at docs.win-test.com Port 80

# Index of /pdf/daily



<u>Name</u>	<u>Last modified</u>	<u>Size</u>	<u>Description</u>
 <a href="#">Parent Directory</a>		-	
 <a href="#">win-test-20240330.pdf</a>	2024-03-30 01:05	49M	
 <a href="#">win-test-20240329.pdf</a>	2024-03-29 01:05	49M	
 <a href="#">win-test-20240328.pdf</a>	2024-03-28 01:05	49M	
 <a href="#">win-test-20240327.pdf</a>	2024-03-27 01:05	49M	
 <a href="#">win-test-20240326.pdf</a>	2024-03-26 01:05	49M	
 <a href="#">win-test-20240325.pdf</a>	2024-03-25 01:05	49M	
 <a href="#">win-test-20240324.pdf</a>	2024-03-24 01:05	49M	
 <a href="#">win-test-20240323.pdf</a>	2024-03-23 01:05	49M	
 <a href="#">win-test-20240322.pdf</a>	2024-03-22 01:04	49M	
 <a href="#">win-test-20240321.pdf</a>	2024-03-21 01:05	49M	
 <a href="#">win-test-20240320.pdf</a>	2024-03-20 01:04	49M	
 <a href="#">win-test-20240319.pdf</a>	2024-03-19 01:05	49M	
 <a href="#">win-test-20240318.pdf</a>	2024-03-18 01:04	49M	
 <a href="#">win-test-20240317.pdf</a>	2024-03-17 01:05	49M	
 <a href="#">win-test-20240316.pdf</a>	2024-03-16 01:05	49M	
 <a href="#">win-test-20240315.pdf</a>	2024-03-15 01:05	49M	
 <a href="#">win-test-20240314.pdf</a>	2024-03-14 01:05	49M	
 <a href="#">win-test-20240313.pdf</a>	2024-03-13 01:05	49M	
 <a href="#">win-test-20240312.pdf</a>	2024-03-12 01:05	49M	
 <a href="#">win-test-20240311.pdf</a>	2024-03-11 01:05	49M	
 <a href="#">win-test-20240310.pdf</a>	2024-03-10 01:05	49M	
 <a href="#">win-test-20240309.pdf</a>	2024-03-09 01:05	49M	
 <a href="#">win-test-20240308.pdf</a>	2024-03-08 01:05	49M	
 <a href="#">win-test-20240307.pdf</a>	2024-03-07 01:05	49M	
 <a href="#">win-test-20240306.pdf</a>	2024-03-06 01:05	49M	
 <a href="#">win-test-20240305.pdf</a>	2024-03-05 01:05	49M	
 <a href="#">win-test-20240304.pdf</a>	2024-03-04 01:04	49M	
 <a href="#">win-test-20240303.pdf</a>	2024-03-03 01:05	49M	
 <a href="#">win-test-20240302.pdf</a>	2024-03-02 01:04	49M	
 <a href="#">win-test-20240301.pdf</a>	2024-03-01 01:06	49M	
 <a href="#">win-test-20240229.pdf</a>	2024-02-29 01:04	49M	

<u>Name</u>	<u>Last modified</u>	<u>Size</u>	<u>Description</u>
 <a href="#">NEW_win-test.pdf</a>	2024-03-30 01:05	9.8M	

---

Apache/2.4.41 Server at docs.win-test.com Port 80



# Index of /pdf/downloads

<u>Name</u>	<u>Last modified</u>	<u>Size</u>	<u>Description</u>
 <a href="#">Parent Directory</a>		-	
 <a href="#">manual.pdf</a>	2024-03-30 01:05	49M	

Apache/2.4.41 Server at docs.win-test.com Port 80



# Index of /pdf

<u>Name</u>	<u>Last modified</u>	<u>Size</u>	<u>Description</u>
 <a href="#">Parent Directory</a>			-
 <a href="#">downloads/</a>	2024-03-30 01:05		-
 <a href="#">daily/</a>	2024-03-30 01:05		-

Apache/2.4.41 Server at docs.win-test.com Port 80

# Configuration

From Win-Test Wiki

[Jump to navigation](#) [Jump to search](#)

Articles on how to configure Win-Test...

## One-time configuration

Some of Win-Test's configuration only needs to be done once and is saved for future contests. This includes:

### Interface configuration

*How to control your rig, CW keyer, DVK, SO2R interfaces etc.*

### DX Cluster configuration

*How to connect Win-Test to DX Clusters, CW Skimmer, or TNCs using **wtDxTelnet***

### Rotator configuration

*How to connect Win-Test to your rotators using **wtRotators***

### RTTY configuration

*How to set up Win-Test for RTTY*

### Networking

*How to set up Win-Test networking in a multi-op environment*

### Win-Test Initialization file

*Changing Win-Test default parameters in WT.INI file*

## Pre-contest configuration

A description of what one needs to do prior to the start of each contest with Win-Test:

1. Create a new log for the contest - *Also describes how to re-open an existing log and how enable automatic loading of a log when Win-Test starts*
2. Download the latest country file - Select CTY\_WT\_MOD.DAT instead of CTY.DAT for best results
3. Install the latest super-check partial file (MASTER.SCP)
4. Set up DX cluster access
  1. Via telnet
  2. Via packet radio (TNC)
5. Program Digital Voice Keyer (DVK), CW and RTTY messages
6. Position windows and set fonts
7. Install contest-specific databases for exchange guessing (optional)
8. Load contest objectives (optional)
9. Interface HamCAP (optional)

## Namespaces

- [Page](#)
- [Discussion](#)

## Variants

## Views

- [Read](#)
- [View source](#)
- [View history](#)

## More

- This page was last edited on 9 December 2016, at 23:43.

- [Privacy policy](#)
- [About Win-Test Wiki](#)
- [Disclaimers](#)



# Contest specific behaviour

From Win-Test Wiki

[Jump to navigation](#) [Jump to search](#)

Different contests have different rules and exchanges, so sometimes it is important to know some specific features for that contest. Win-Test will display some specialised options and menus only when the correct contest has been selected. So, for example, you will not find the RTTY menu when you select a SSB contest.

Most important is always to fill the **Exchange (Zone, ..)** field in the **Contest configuration** window that pops up after opening a contest. This field is sometimes to recognize the multpliers, for example.

The screenshot shows the 'Contest configuration' dialog box with the following fields and values:

- Station**
  - Callsign: DP4N
  - Locator: JN43XT
  - Exchange (zone, ...): 14
  - Name: Werner Maier
  - Address: Richard-Strauss-Str. 9
  - Address: 97074 Wuerzburg
  - Address: (empty)
  - Club: Bavarian Contest Club (BCC)
- Contest**
  - Contest: CQWW DX
  - Category: Multioperator, two transmitter
  - Mode: PHONE
  - Power: 750
  - Class: High power
  - Operators: DL4NER
  - Contests of the month
- Network**
  - Station name: ERAGON
  - Enable time distribution across the network

Buttons: OK, Cancel

## Win-Test Wiki

Selection of the Contest and Mode may bring up menu options, which are not visible otherwise.  
Now let's go to a real contest specific behaviour:

- [Worked All Europe DX Contest](#)
- [RTTY Contests](#)
- [ARRL Sweepstakes](#)
- [Sprint Exchange Logic](#) for the Sprint Contest Family
- [ARRL North American QSO Party](#)
- [Win-Test on a DX Pediton](#)

## Namespaces

- [Page](#)
- [Discussion](#)

## Variants

## Views

- [Read](#)
- [View source](#)
- [View history](#)

## More

- This page was last edited on 12 April 2009, at 17:35.

- [Privacy policy](#)
- [About Win-Test Wiki](#)
- [Disclaimers](#)



# Contest specific behaviour

From Win-Test Wiki

[Jump to navigation](#) [Jump to search](#)

Different contests have different rules and exchanges, so sometimes it is important to know some specific features for that contest. Win-Test will display some specialised options and menus only when the correct contest has been selected. So, for example, you will not find the RTTY menu when you select a SSB contest.

Most important is always to fill the **Exchange (Zone, ..)** field in the **Contest configuration** window that pops up after opening a contest. This field is sometimes to recognize the multpliers, for example.

**Contest configuration**

Station

Callsign: DP4N    Locator: JN43XT    Exchange (zone, ...): 14

Name: Werner Maier

Address: Richard-Strauss-Str. 9

Address: 97074 Wuerzburg

Address:

Club: Bavarian Contest Club (BCC)

Contest

Contest: CQWW DX     Contests of the month

Category: Multioperator, two transmitter    Mode: PHONE

Overlay: ---    Power: 750

Class: High power

Operators: DL4NER

Network

Station name: ERAGON     Enable time distribution across the network

OK    Cancel

## Win-Test Wiki

Selection of the Contest and Mode may bring up menu options, which are not visible otherwise.  
Now let's go to a real contest specific behaviour:

- [Worked All Europe DX Contest](#)
- [RTTY Contests](#)
- [ARRL Sweepstakes](#)
- [Sprint Exchange Logic](#) for the Sprint Contest Family
- [ARRL North American QSO Party](#)
- [Win-Test on a DX Pediton](#)

## Namespaces

- [Page](#)
- [Discussion](#)

## Variants

## Views

- [Read](#)
- [View source](#)
- [View history](#)

## More

- This page was last edited on 12 April 2009, at 17:35.

- [Privacy policy](#)
- [About Win-Test Wiki](#)
- [Disclaimers](#)



# Creating

From Win-Test Wiki

[Jump to navigation](#) [Jump to search](#)

## Contents

- [1 Creating](#)
  - ◆ [1.1 Cabrillo](#)
  - ◆ [1.2 Reg1Test](#)
  - ◆ [1.3 ADIF](#)
  - ◆ [1.4 LogSearch](#)
  - ◆ [1.5 Text and CSV Files](#)

## Creating

Creating the output files for log submission and further processing has become an easy task. Win-Test supports Cabrillo files for most HF contest submissions, Reg1Test for VHF/UHF submissions, ADIF for transferring the log to your personal log and two generic ASCII formats if everything else fails.

To open up the following dialog, go to the top menu and then select **File | Create log files...**, or you can type the **MAKELOG** text command in the callsign entry field.

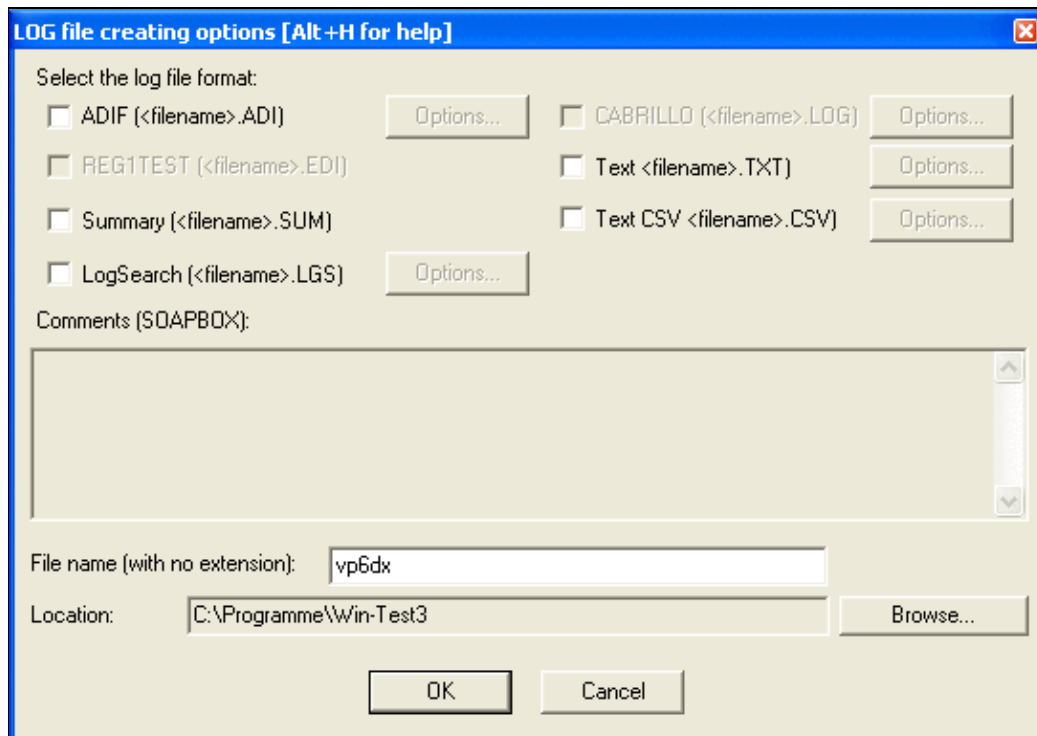



The "Create Log Files..." dialog box

Most HF contest sponsors require your log to be sent in the Cabrillo format that was defined by N5KO in the late 1990's.

**Note:** Contest sponsors generally are **not** happy with ADIF files.

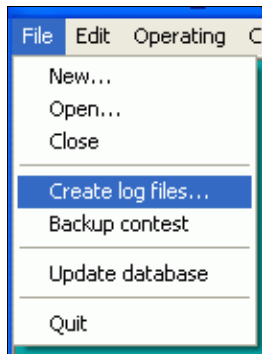

Open the Create logs dialog; this menu option is visible only when a Win-Test file is open

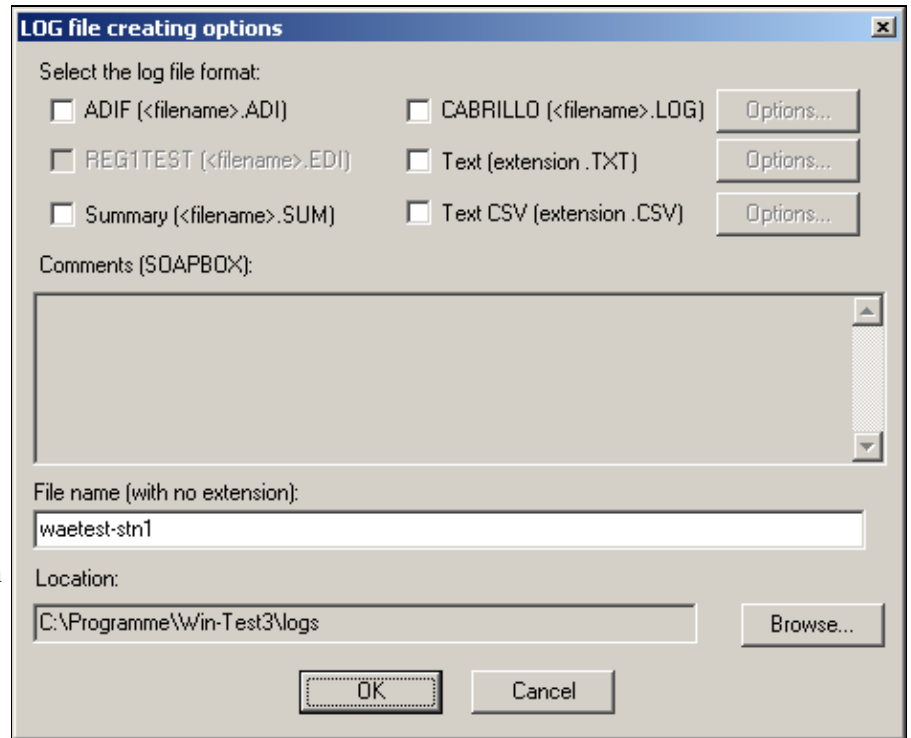

The "Create Log Files..." dialog box

## Cabrillo

**Cabrillo** is the de-facto standard log submission file today. All of the major HF contest sponsors accept entries in the Cabrillo format. Please find details on Cabrillo in <http://www.kkn.net/~trey/cabrillo>. The Cabrillo file for the CQ WPX, CQ WW DX, NAQP and NA Sprint Contests are created after the v3 specification, all others in v2. Other contests to follow.

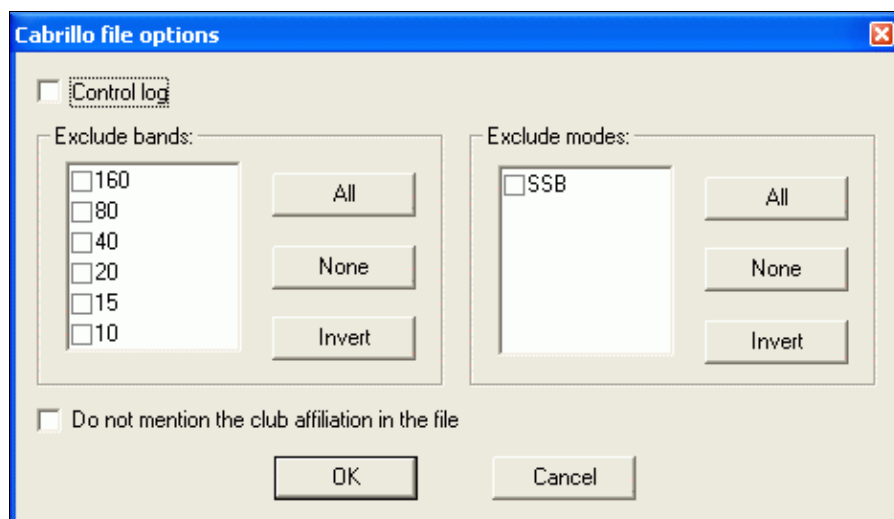

Cabrillo options available before creating the log

In the Cabrillo file you may choose to create the log as a check log (tick the control log item), export only a specific band, or suppress the club header line in order to avoid problems with the ARRL log robot (ARRL does not accept Cabrillo files which mention clubs not affiliated to ARRL).

**Note:** Win-Test cannot create a Cabrillo file, when it has not been specified by the contest sponsor. So for example, since there is no Cabrillo definition for DXpedition type logs, Cabrillo output is not available here.

Win-Test also allows **importing** Cabrillo files so that old log files may still be loaded and used as a reference or to create a target file. Please look [here](#) for further information.

In CQ WW and CQ WPX Multi-Single, Win-Test uses an indicator (0/1) depending on if the QSO was made by the RUN or by the MULT station.

## Reg1Test

**REG1TEST** is the format proposed by the IARU Region I VHF Committee (mainly driven by EDR) and has been widely adopted by national amateur radio organizations. REF, DARC and probably others fully accept electronic logs in this format for all of their contests above 30 MHz. Before creating the file, you will have to fill in some information like equipment used, location, antenna height etc.

For further details on Reg1Test see <http://vkzvavody.moravany.com/EDI.TXT> on the WEB.

**Needed data for the REG1TEST format**

**Band: 144 MHz**

Information about the station and the contest	Station owner
Contest name: Marconi Memorial Contest	Name: Bernhard Buettner
Station address: Schmidweg 17	Callsign: DL6RAI
Station address: 85609 Dornach	Address: Schmidweg 17
Club of affiliation: U08	Address:
RX equipment: TS-850 + LT2S	Postal code: 85609
TX equipment: TS-850 + LT2S + PA	City: Dornach
Antennas: 4 x 17el M <sup>2</sup>	Country: Fed. Rep. of Germany
Power (in watts): 750	Phone num: +49 89 943 663
Antenna height: 12	E-mail / BBS: ben@dl6rai.muc.de
Station altitude: 510	

OK Cancel

Additional information for the Reg1Test

## ADIF

**ADIF** (Amateur Data Interface Format) is used as a way to exchange amateur radio logging data between different applications. Most logging software will accept and can create this format.

For further details see the ADIF WEB site <http://www.hosenose.com/adif>.

**ADIF options**

Include the contest name in the <NOTES> field of every QSO record

OK Cancel

Options for creating ADIF files

With the ADIF files you may select to include the contest name or transmitter power with every record for later reference. Include the contest name into the INFO field of the ADIF file.

## LogSearch

LogSearch format to comply with 5B4WN log search php script. Useful for DXpeditions who wish to provide online logs during the expedition.

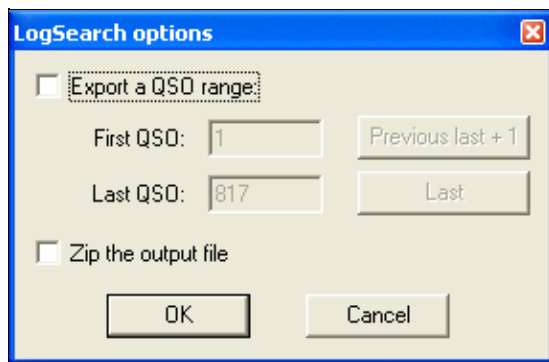

Options for creating Logsearch files

In the options dialog, you can specify a range of QSOs to be exported, and zip the output file (so its name will be "blahblah.LGS.ZIP").

## Text and CSV Files

These formats are the last resort when nothing else is available. For the text and CSV file type you may select or unselect columns, different date formats and have a choice to add empty fields to the output. You can open the Text version of the output in any Editor like Notepad or Wordpad, or even MS-Excel, since it is a fixed column format. The CSV format is designed to open the file in MS-Excel.

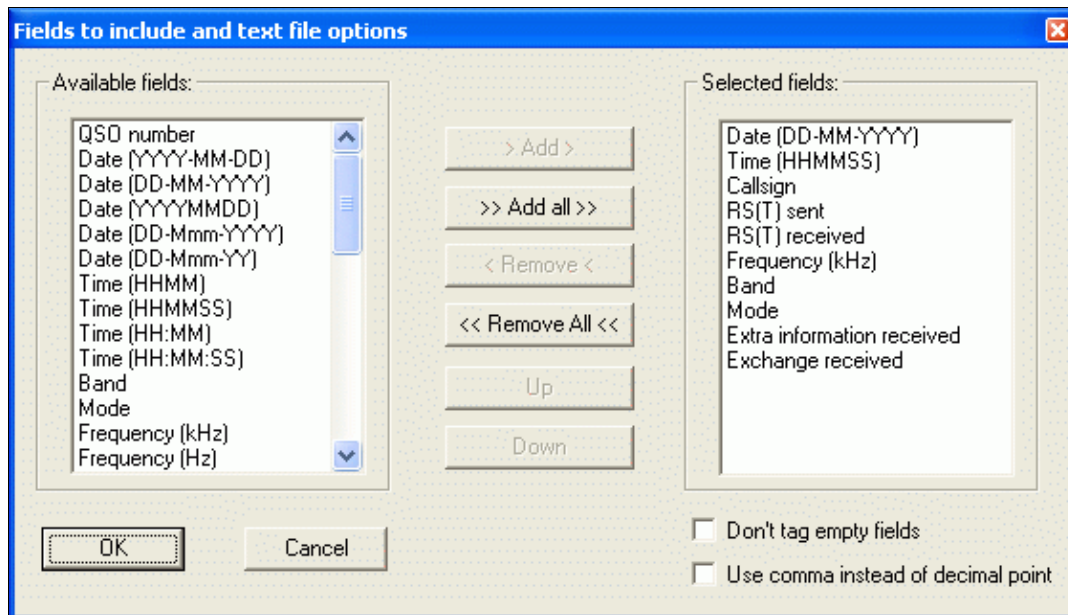

Options for creating Text files

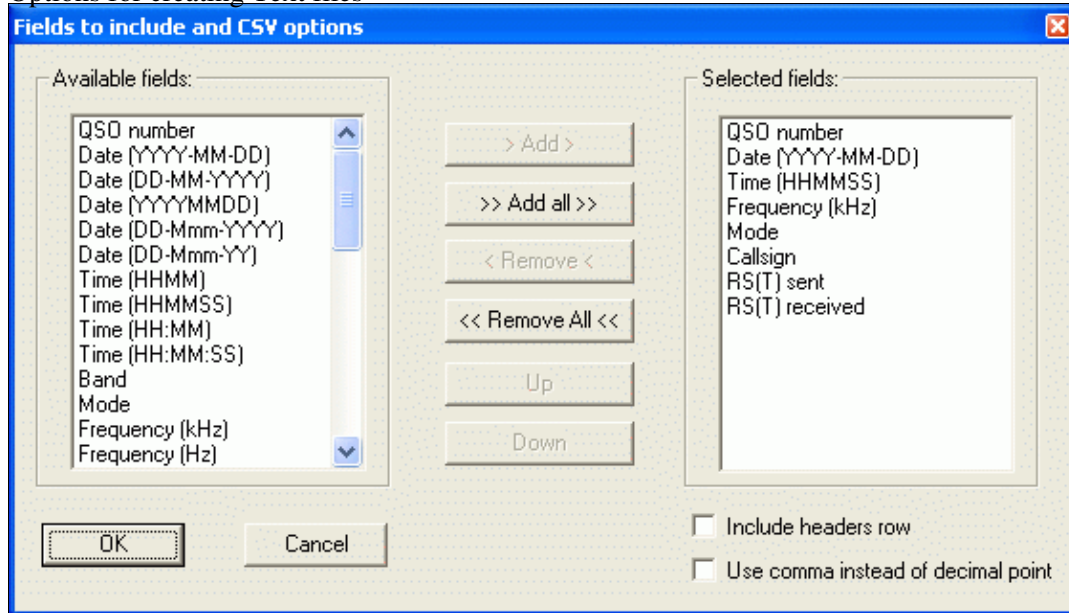

Options for creating CSV files

## Namespaces

- [Page](#)
- [Discussion](#)

## Variants

## Views

- [Read](#)
- [View source](#)
- [View history](#)

## More

- This page was last edited on 19 December 2009, at 18:59.

- [Privacy policy](#)
- [About Win-Test Wiki](#)
- [Disclaimers](#)



# Creating

From Win-Test Wiki

[Jump to navigation](#) [Jump to search](#)

## Contents

- [1 Creating](#)
  - ◆ [1.1 Cabrillo](#)
  - ◆ [1.2 Reg1Test](#)
  - ◆ [1.3 ADIF](#)
  - ◆ [1.4 LogSearch](#)
  - ◆ [1.5 Text and CSV Files](#)

## Creating

Creating the output files for log submission and further processing has become an easy task. Win-Test supports Cabrillo files for most HF contest submissions, Reg1Test for VHF/UHF submissions, ADIF for transferring the log to your personal log and two generic ASCII formats if everything else fails.

To open up the following dialog, go to the top menu and then select **File | Create log files...**, or you can type the **MAKELOG** text command in the callsign entry field.

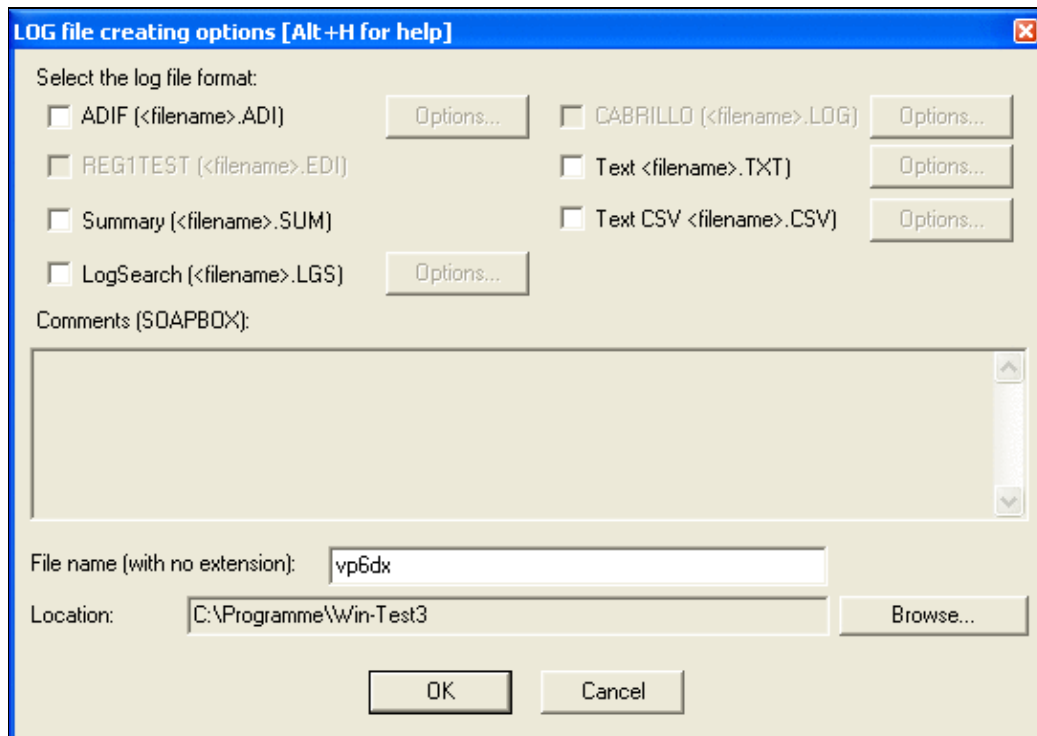

The "Create Log Files..." dialog box

Most HF contest sponsors require your log to be sent in the Cabrillo format that was defined by N5KO in the late 1990's.

**Note:** Contest sponsors generally are **not** happy with ADIF files.

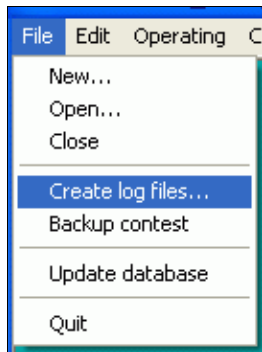

Open the Create logs dialog; this menu option is visible only when a Win-Test file is open

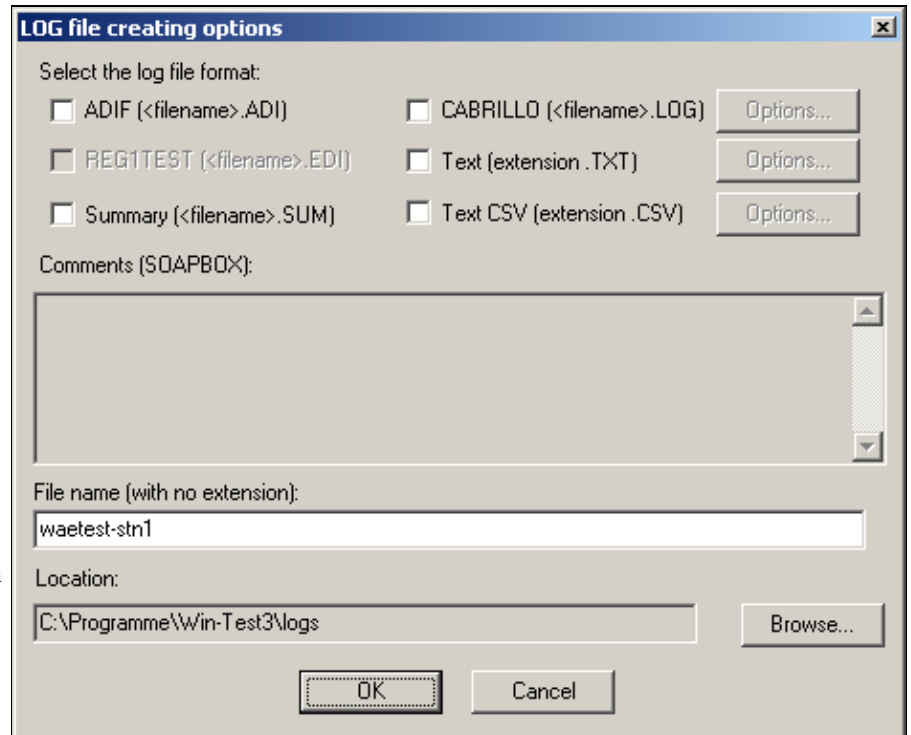

The "Create Log Files..." dialog box

## Cabrillo

**Cabrillo** is the de-facto standard log submission file today. All of the major HF contest sponsors accept entries in the Cabrillo format. Please find details on Cabrillo in <http://www.kkn.net/~trey/cabrillo>. The Cabrillo file for the CQ WPX, CQ WW DX, NAQP and NA Sprint Contests are created after the v3 specification, all others in v2. Other contests to follow.

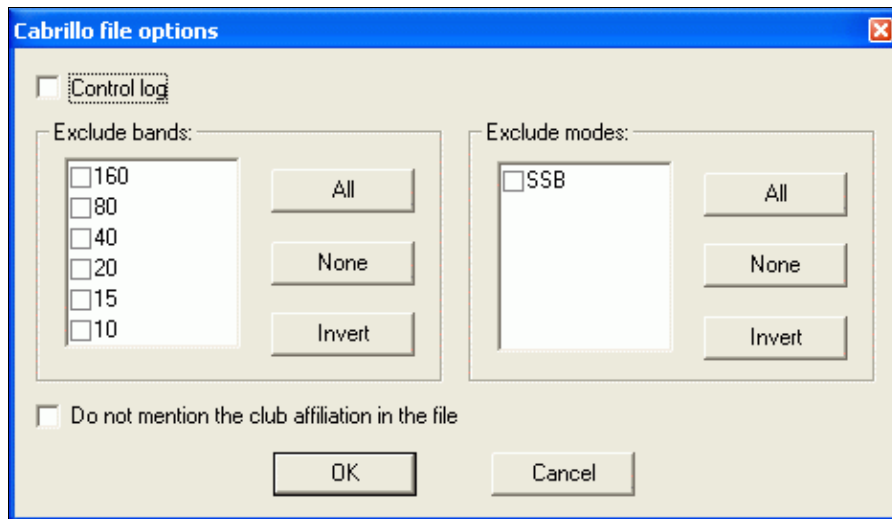

Cabrillo options available before creating the log

In the Cabrillo file you may choose to create the log as a check log (tick the control log item), export only a specific band, or suppress the club header line in order to avoid problems with the ARRL log robot (ARRL does not accept Cabrillo files which mention clubs not affiliated to ARRL).

**Note:** Win-Test cannot create a Cabrillo file, when it has not been specified by the contest sponsor. So for example, since there is no Cabrillo definition for DXpedition type logs, Cabrillo output is not available here.

Win-Test also allows **importing** Cabrillo files so that old log files may still be loaded and used as a reference or to create a target file. Please look [here](#) for further information.

In CQ WW and CQ WPX Multi-Single, Win-Test uses an indicator (0/1) depending on if the QSO was made by the RUN or by the MULT station.

## Reg1Test

**REG1TEST** is the format proposed by the IARU Region I VHF Committee (mainly driven by EDR) and has been widely adopted by national amateur radio organizations. REF, DARC and probably others fully accept electronic logs in this format for all of their contests above 30 MHz. Before creating the file, you will have to fill in some information like equipment used, location, antenna height etc.

For further details on Reg1Test see <http://vkzvavody.moravany.com/EDI.TXT> on the WEB.



**Needed data for the REG1TEST format**

**Band: 144 MHz**

Information about the station and the contest	Station owner
Contest name: Marconi Memorial Contest	Name: Bernhard Buettner
Station address: Schmidweg 17	Callsign: DL6RAI
Station address: 85609 Dornach	Address: Schmidweg 17
Club of affiliation: U08	Address:
RX equipment: TS-850 + LT2S	Postal code: 85609
TX equipment: TS-850 + LT2S + PA	City: Dornach
Antennas: 4 x 17el M <sup>2</sup>	Country: Fed. Rep. of Germany
Power (in watts): 750	Phone num: +49 89 943 663
Antenna height: 12	E-mail / BBS: ben@dl6rai.muc.de
Station altitude: 510	

OK Cancel

Additional information for the Reg1Test

## ADIF

**ADIF** (Amateur Data Interface Format) is used as a way to exchange amateur radio logging data between different applications. Most logging software will accept and can create this format.

For further details see the ADIF WEB site <http://www.hosenose.com/adif>.

**ADIF options**

Include the contest name in the <NOTES> field of every QSO record

OK Cancel

Options for creating ADIF files

With the ADIF files you may select to include the contest name or transmitter power with every record for later reference. Include the contest name into the INFO field of the ADIF file.

## LogSearch

LogSearch format to comply with 5B4WN log search php script. Useful for DXpeditions who wish to provide online logs during the expedition.

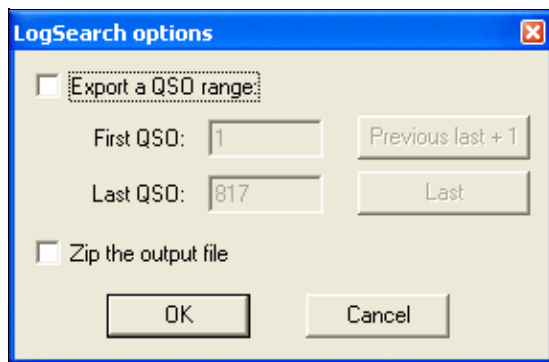

Options for creating Logsearch files

In the options dialog, you can specify a range of QSOs to be exported, and zip the output file (so its name will be "blahblah.LGS.ZIP").

## Text and CSV Files

These formats are the last resort when nothing else is available. For the text and CSV file type you may select or unselect columns, different date formats and have a choice to add empty fields to the output. You can open the Text version of the output in any Editor like Notepad or Wordpad, or even MS-Excel, since it is a fixed column format. The CSV format is designed to open the file in MS-Excel.

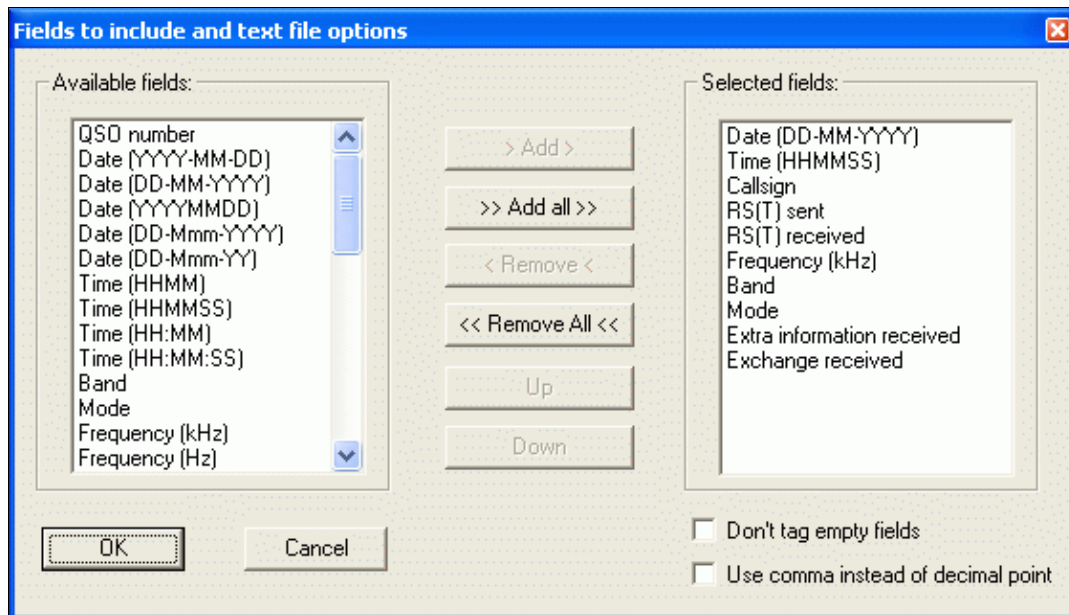

Options for creating Text files

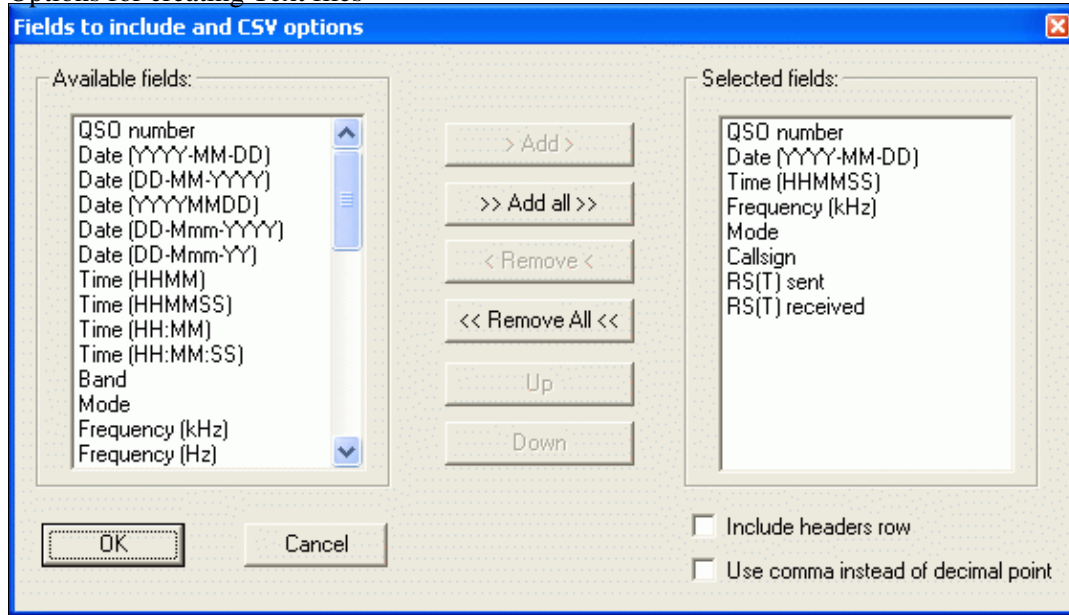

Options for creating CSV files

## Namespaces

- [Page](#)
- [Discussion](#)

## Variants

## Views

- [Read](#)
- [View source](#)
- [View history](#)























## More

- This page was last edited on 19 December 2009, at 18:59.

- [Privacy policy](#)
- [About Win-Test Wiki](#)
- [Disclaimers](#)



# Index of /pdf/daily



<u>Name</u>	<u>Last modified</u>	<u>Size</u>	<u>Description</u>
 <a href="#">Parent Directory</a>		-	
 <a href="#">NEW win-test.pdf</a>	2024-03-30 01:05	9.8M	
 <a href="#">win-test-20240302.pdf</a>	2024-03-02 01:04	49M	
 <a href="#">win-test-20240301.pdf</a>	2024-03-01 01:06	49M	
 <a href="#">win-test-20240304.pdf</a>	2024-03-04 01:04	49M	
 <a href="#">win-test-20240229.pdf</a>	2024-02-29 01:04	49M	
 <a href="#">win-test-20240306.pdf</a>	2024-03-06 01:05	49M	
 <a href="#">win-test-20240319.pdf</a>	2024-03-19 01:05	49M	
 <a href="#">win-test-20240330.pdf</a>	2024-03-30 01:05	49M	
 <a href="#">win-test-20240329.pdf</a>	2024-03-29 01:05	49M	
 <a href="#">win-test-20240322.pdf</a>	2024-03-22 01:04	49M	
 <a href="#">win-test-20240307.pdf</a>	2024-03-07 01:05	49M	
 <a href="#">win-test-20240318.pdf</a>	2024-03-18 01:04	49M	
 <a href="#">win-test-20240308.pdf</a>	2024-03-08 01:05	49M	
 <a href="#">win-test-20240321.pdf</a>	2024-03-21 01:05	49M	
 <a href="#">win-test-20240315.pdf</a>	2024-03-15 01:05	49M	
 <a href="#">win-test-20240328.pdf</a>	2024-03-28 01:05	49M	
 <a href="#">win-test-20240323.pdf</a>	2024-03-23 01:05	49M	
 <a href="#">win-test-20240320.pdf</a>	2024-03-20 01:04	49M	
 <a href="#">win-test-20240313.pdf</a>	2024-03-13 01:05	49M	
 <a href="#">win-test-20240314.pdf</a>	2024-03-14 01:05	49M	
 <a href="#">win-test-20240312.pdf</a>	2024-03-12 01:05	49M	
 <a href="#">win-test-20240324.pdf</a>	2024-03-24 01:05	49M	
 <a href="#">win-test-20240309.pdf</a>	2024-03-09 01:05	49M	
 <a href="#">win-test-20240326.pdf</a>	2024-03-26 01:05	49M	
 <a href="#">win-test-20240311.pdf</a>	2024-03-11 01:05	49M	
 <a href="#">win-test-20240310.pdf</a>	2024-03-10 01:05	49M	
 <a href="#">win-test-20240327.pdf</a>	2024-03-27 01:05	49M	
 <a href="#">win-test-20240325.pdf</a>	2024-03-25 01:05	49M	
 <a href="#">win-test-20240305.pdf</a>	2024-03-05 01:05	49M	
 <a href="#">win-test-20240303.pdf</a>	2024-03-03 01:05	49M	
 <a href="#">win-test-20240316.pdf</a>	2024-03-16 01:05	49M	

<u>Name</u>	<u>Last modified</u>	<u>Size</u>	<u>Description</u>
 <a href="#">win-test-20240317.pdf</a>	2024-03-17 01:05	49M	

---



Apache/2.4.41 Server at docs.win-test.com Port 80

# Index of /pdf/downloads

<u>Name</u>	<u>Last modified</u>	<u>Size</u>	<u>Description</u>
 <a href="#">Parent Directory</a>		-	
 <a href="#">manual.pdf</a>	2024-03-30 01:05	49M	



Apache/2.4.41 Server at docs.win-test.com Port 80

# Index of /pdf

<u>Name</u>	<u>Last modified</u>	<u>Size</u>	<u>Description</u>
 <a href="#">Parent Directory</a>			-
 <a href="#">daily/</a>	2024-03-30 01:05		-
 <a href="#">downloads/</a>	2024-03-30 01:05		-

Apache/2.4.41 Server at docs.win-test.com Port 80

































# Index of /pdf

<u>Name</u>	<u>Last modified</u>	<u>Size</u>	<u>Description</u>
 <a href="#">Parent Directory</a>			-
 <a href="#">downloads/</a>	2024-03-30 01:05		-
 <a href="#">daily/</a>	2024-03-30 01:05		-

Apache/2.4.41 Server at docs.win-test.com Port 80



# Index of /pdf/daily



<u>Name</u>	<u>Last modified</u>	<u>Size</u>	<u>Description</u>
 <a href="#">Parent Directory</a>		-	
 <a href="#">win-test-20240317.pdf</a>	2024-03-17 01:05	49M	
 <a href="#">win-test-20240316.pdf</a>	2024-03-16 01:05	49M	
 <a href="#">win-test-20240303.pdf</a>	2024-03-03 01:05	49M	
 <a href="#">win-test-20240305.pdf</a>	2024-03-05 01:05	49M	
 <a href="#">win-test-20240325.pdf</a>	2024-03-25 01:05	49M	
 <a href="#">win-test-20240327.pdf</a>	2024-03-27 01:05	49M	
 <a href="#">win-test-20240310.pdf</a>	2024-03-10 01:05	49M	
 <a href="#">win-test-20240311.pdf</a>	2024-03-11 01:05	49M	
 <a href="#">win-test-20240326.pdf</a>	2024-03-26 01:05	49M	
 <a href="#">win-test-20240309.pdf</a>	2024-03-09 01:05	49M	
 <a href="#">win-test-20240324.pdf</a>	2024-03-24 01:05	49M	
 <a href="#">win-test-20240312.pdf</a>	2024-03-12 01:05	49M	
 <a href="#">win-test-20240314.pdf</a>	2024-03-14 01:05	49M	
 <a href="#">win-test-20240313.pdf</a>	2024-03-13 01:05	49M	
 <a href="#">win-test-20240320.pdf</a>	2024-03-20 01:04	49M	
 <a href="#">win-test-20240323.pdf</a>	2024-03-23 01:05	49M	
 <a href="#">win-test-20240328.pdf</a>	2024-03-28 01:05	49M	
 <a href="#">win-test-20240315.pdf</a>	2024-03-15 01:05	49M	
 <a href="#">win-test-20240321.pdf</a>	2024-03-21 01:05	49M	
 <a href="#">win-test-20240308.pdf</a>	2024-03-08 01:05	49M	
 <a href="#">win-test-20240318.pdf</a>	2024-03-18 01:04	49M	
 <a href="#">win-test-20240307.pdf</a>	2024-03-07 01:05	49M	
 <a href="#">win-test-20240322.pdf</a>	2024-03-22 01:04	49M	
 <a href="#">win-test-20240329.pdf</a>	2024-03-29 01:05	49M	
 <a href="#">win-test-20240330.pdf</a>	2024-03-30 01:05	49M	
 <a href="#">win-test-20240319.pdf</a>	2024-03-19 01:05	49M	
 <a href="#">win-test-20240306.pdf</a>	2024-03-06 01:05	49M	
 <a href="#">win-test-20240229.pdf</a>	2024-02-29 01:04	49M	
 <a href="#">win-test-20240304.pdf</a>	2024-03-04 01:04	49M	
 <a href="#">win-test-20240301.pdf</a>	2024-03-01 01:06	49M	
 <a href="#">win-test-20240302.pdf</a>	2024-03-02 01:04	49M	

<u>Name</u>	<u>Last modified</u>	<u>Size</u>	<u>Description</u>
 <a href="#">NEW_win-test.pdf</a>	2024-03-30 01:05	9.8M	

---

Apache/2.4.41 Server at docs.win-test.com Port 80

# Index of /pdf/downloads

<u>Name</u>	<u>Last modified</u>	<u>Size</u>	<u>Description</u>
 <a href="#">Parent Directory</a>		-	
 <a href="#">manual.pdf</a>	2024-03-30 01:05	49M	

Apache/2.4.41 Server at docs.win-test.com Port 80

# SO1R/CW Voice Keyer

From Win-Test Wiki

[Jump to navigation](#) [Jump to search](#)

## Contents

- [1 SO1R/CW and Voice Keyer](#)
  - ◆ [1.1 Automated CW Keying](#)
    - ◇ [1.1.1 Internal or external](#)
    - ◇ [1.1.2 How to use](#)
  - ◆ [1.2 Voice Keyer](#)
    - ◇ [1.2.1 Sound Card](#)
    - ◇ [1.2.2 External Voice Keyers](#)
    - ◇ [1.2.3 How to use](#)
  - ◆ [1.3 RTTY Keying](#)
  - ◆ [1.4 The Autorepeat Function](#)

## SO1R/CW and Voice Keyer

So you got Win-Test installed on your computer - stand alone. Now it's time to think about connecting your computer to the radio. The point in doing that is that automated CW and voice messaging will give you valuable time to do other things, while the message is being sent - probably finishing to edit the last QSO, turning the antenna, taking a little break ("micro nap") or tuning a secondary radio.

A major factor of contesting is efficiency. If you manage to work stations more efficiently means a better final score. The first step in this direction is automating CW, a second one using pre-recorded voice messages for routine tasks like calling CQ or breaking the pileups.

### Automated CW Keying

#### Internal or external

Win-Test allows you to generate CW in two different ways.

- Win-Test generated CW

The easiest way is using the internal CW generator of Win-Test to key your radio through COM or LPT ports. Typically, you will need some kind of hardware inbetween, as described elsewhere in this manual ([COM Port CW keying](#), [LPT Port CW keying](#)). Win-Test will then generate dots and dashes and key one of the signals lines like DTR, RTS or Pin 17 on the LPT interface.

There is a minor but important detail: Activating the PTT of your radio through that line will prevent you from hot switching and burnt relay contacts in the amplifier. You should definitely give it some consideration over VOX-based transmit control.

In some cases you will want to have a manual keyer at your station to handle specific situations or just to be on the safe side. If your manual keyer is normally connected to the built-in electronic keyer of your radio, you have a problem. The only way out is to use an external electronic keyer.

- WinKey by K1EL, USB micro Keyer or the W5XD Multi-Keyer key

The other way is using a programmable external keyer, which is connected to your computer by USB or COM. These devices are fully stand-alone but can be controlled by software. In this application Win-Test actually sends commands and characters down the line (not dots or dashes) and the telegraphy is created by that device, allowing you to adjust speed by a control on the device.

### How to use

So how do we use these capabilities? Calling CQ is a very common task. Pressing **F1** will just do that for you. If you wish to change the contents of the CQ register, press **Shift-F1** and you will be able to change it at your will.

Next, working a station that comes back to our CQ is another (hopefully) common task. Enter his call into the callsign entry field and press the **[INS]** key. Win-Test will now send the callsign and the exchange specific to the contest selected. Again, if you're not happy with the default contents of this register, change them by pressing **Shift-INS**.

Please note that you can push **[INS]** even when you have not yet finished typing the callsign. After having started the exchange message, complete the callsign and Win-Test will gather the rest of the callsign too. The reason is that you do have to come back to the called immediately (within 1 second) otherwise you risk that he will repeat his callsign (loss of time).

Typically, when you've received the report from the other station, you will want to send **TU** and sign your call. Additionally you will want to log the contact by pressing **[Enter]**. Pressing the **[+]** instead will do both for you.

Note that you may probably want to use the large **[INS]** and **[+]** keys on the numeric keypad because they are easy to reach (well, not on a notebook, but on a regular keyboard).

One of the most important keys here is the **[ESC]** key. Pushing Escape will stop CW generation immediately. This is very important if you have inadvertently started the wrong message.

Now that we know the basics, there are a few more keys we can use. Actually, all of the function keys **F1..F8** have their own message. Please see the [Keys chapter](#) for further details. Keep in mind that you may change the contents of these function keys at your will (Please refer to the [DVK CW RTTY Messaging](#) chapter for more details).

Finally, note that pressing **Alt-K** will switch you into keyboard mode, which will allow you to type text that will be transmitted on CW. This is perfect for blind typists. Note that in keyboard mode, all the special keys like **F4**, **F5** continue to work as expected.

### Voice Keyer

In a similar fashion, it is also possible to automate transmission on voice modes. Again, there are two options; you can either use the internal sound device of your computer to record and play messages or you may control an external device like the MFJ-432, DVK-100 or the built in speech memory of some radios like the Kenwood TS-850, TS-950 series.

## Sound Card

To use your computer's sound device, you will need hardware to connect the audio output to the AF input of your radio. Additionally, you will have to connect the microphone to the audio input of your sound card and/or alternatively to the AF input of your radio. Some prefer to use a switch to route the audio to the sound card or to the radio. Also you will need a PTT signal so that your transmitter gets keyed when the message starts.

It is essential to accept that you will not be able to live with pre-recorded messages. You will definitely want to change voice messages on the fly, during the contest. Just think of the typical split operation on 40 meters phone where you continue to change the RX frequency when it gets too crowded up there near 7.239.

For hardware details, please see the [interfaces section](#) of this document.

To record a message to the **F1** memory, simply press **Shift-F1**. The same is true for **F2...F7**.

For more details on how to configure your DVK or record your messages, please refer to the [Configuring DVK messages](#) chapter in this manual.

## External Voice Keyers

As an alternative, Win-Test also allows you to control external voice keyers from the computer. This is a way to avoid the typical problems with hum, different audio levels etc. that you might face with sound cards. On the other hand, most of the time it is another box on the table. So it's up to you to decide which solution is the best for you.

These devices can be controlled via the LPT port of your computer. Typically, there are separate pins for message#1...message#4 and another one to stop the message. For details, please look in the [interfaces section](#) of this document.

## How to use

Similar to CW, **F1** is the most used function key in SSB contests. This key is used to send the CQ message. While you cannot really automate the QSO, you may wish to put a long CQ into the **F2** memory and a "Thank you, QRZ" message into **F3**. This saves you from a lot of routine talk in SSB contests.

There is not much more you can do here. Win-Test does not support storing single characters so that you could fully run the QSOs from the computer like with CT using the specially designed DVP card.

## RTTY Keying

Operating a RTTY contest is very similar to operating CW when using generated CW messages. All of the keys have the same functionality on RTTY, including the keyboard mode, the **[ESC]** key etc. The difference is that decoding RTTY is done by the machine and not by your brain (well, not normally). Using the mouse, you will be able to select call signs and reports received from the RTTY window but the keys you use to conduct the QSO are essentially the same like on CW.

## The Autorepeat Function

There is a function that is helpful on CW, SSB and RTTY: Autorepeat. This feature comes in handy during slow times, when you get few replies to your CQs. When activated, the **F1** message will repeat as long as you do not enter characters into the callsign field. If you do, it stops immediately, lets you complete the QSO and when done, pressing **F1** again re-activates the auto CQ. The timing of the CQ message has to be set up appropriately. Please see the [Tools](#) menu for more details.

### Namespaces

- [Page](#)
- [Discussion](#)

### Variants

### Views

- [Read](#)
- [View source](#)
- [View history](#)

### More

- This page was last edited on 1 February 2007, at 14:04.
- [Privacy policy](#)
- [About Win-Test Wiki](#)
- [Disclaimers](#)



# SO1R/CW Voice Keyer

From Win-Test Wiki

[Jump to navigation](#) [Jump to search](#)

## Contents

- [1 SO1R/CW and Voice Keyer](#)
  - ◆ [1.1 Automated CW Keying](#)
    - ◇ [1.1.1 Internal or external](#)
    - ◇ [1.1.2 How to use](#)
  - ◆ [1.2 Voice Keyer](#)
    - ◇ [1.2.1 Sound Card](#)
    - ◇ [1.2.2 External Voice Keyers](#)
    - ◇ [1.2.3 How to use](#)
  - ◆ [1.3 RTTY Keying](#)
  - ◆ [1.4 The Autorepeat Function](#)

## SO1R/CW and Voice Keyer

So you got Win-Test installed on your computer - stand alone. Now it's time to think about connecting your computer to the radio. The point in doing that is that automated CW and voice messaging will give you valuable time to do other things, while the message is being sent - probably finishing to edit the last QSO, turning the antenna, taking a little break ("micro nap") or tuning a secondary radio.

A major factor of contesting is efficiency. If you manage to work stations more efficiently means a better final score. The first step in this direction is automating CW, a second one using pre-recorded voice messages for routine tasks like calling CQ or breaking the pileups.

### Automated CW Keying

#### Internal or external

Win-Test allows you to generate CW in two different ways.

- Win-Test generated CW

The easiest way is using the internal CW generator of Win-Test to key your radio through COM or LPT ports. Typically, you will need some kind of hardware inbetween, as described elsewhere in this manual ([COM Port CW keying](#), [LPT Port CW keying](#)). Win-Test will then generate dots and dashes and key one of the signals lines like DTR, RTS or Pin 17 on the LPT interface.

There is a minor but important detail: Activating the PTT of your radio through that line will prevent you from hot switching and burnt relay contacts in the amplifier. You should definitely give it some consideration over VOX-based transmit control.

In some cases you will want to have a manual keyer at your station to handle specific situations or just to be on the safe side. If your manual keyer is normally connected to the built-in electronic keyer of your radio, you have a problem. The only way out is to use an external electronic keyer.



- WinKey by K1EL, USB micro Keyer or the W5XD Multi-Keyer key

The other way is using a programmable external keyer, which is connected to your computer by USB or COM. These devices are fully stand-alone but can be controlled by software. In this application Win-Test actually sends commands and characters down the line (not dots or dashes) and the telegraphy is created by that device, allowing you to adjust speed by a control on the device.

### How to use

So how do we use these capabilities? Calling CQ is a very common task. Pressing **F1** will just do that for you. If you wish to change the contents of the CQ register, press **Shift-F1** and you will be able to change it at your will.

Next, working a station that comes back to our CQ is another (hopefully) common task. Enter his call into the callsign entry field and press the **[INS]** key. Win-Test will now send the callsign and the exchange specific to the contest selected. Again, if you're not happy with the default contents of this register, change them by pressing **Shift-INS**.

Please note that you can push **[INS]** even when you have not yet finished typing the callsign. After having started the exchange message, complete the callsign and Win-Test will gather the rest of the callsign too. The reason is that you do have to come back to the called immediately (within 1 second) otherwise you risk that he will repeat his callsign (loss of time).

Typically, when you've received the report from the other station, you will want to send **TU** and sign your call. Additionally you will want to log the contact by pressing **[Enter]**. Pressing the **[+]** instead will do both for you.

Note that you may probably want to use the large **[INS]** and **[+]** keys on the numeric keypad because they are easy to reach (well, not on a notebook, but on a regular keyboard).

One of the most important keys here is the **[ESC]** key. Pushing Escape will stop CW generation immediately. This is very important if you have inadvertently started the wrong message.

Now that we know the basics, there are a few more keys we can use. Actually, all of the function keys **F1..F8** have their own message. Please see the [Keys chapter](#) for further details. Keep in mind that you may change the contents of these function keys at your will (Please refer to the [DVK CW RTTY Messaging](#) chapter for more details).

Finally, note that pressing **Alt-K** will switch you into keyboard mode, which will allow you to type text that will be transmitted on CW. This is perfect for blind typists. Note that in keyboard mode, all the special keys like **F4**, **F5** continue to work as expected.

### Voice Keyer

In a similar fashion, it is also possible to automate transmission on voice modes. Again, there are two options; you can either use the internal sound device of your computer to record and play messages or you may control an external device like the MFJ-432, DVK-100 or the built in speech memory of some radios like the Kenwood TS-850, TS-950 series.

## Sound Card

To use your computer's sound device, you will need hardware to connect the audio output to the AF input of your radio. Additionally, you will have to connect the microphone to the audio input of your sound card and/or alternatively to the AF input of your radio. Some prefer to use a switch to route the audio to the sound card or to the radio. Also you will need a PTT signal so that your transmitter gets keyed when the message starts.

It is essential to accept that you will not be able to live with pre-recorded messages. You will definitely want to change voice messages on the fly, during the contest. Just think of the typical split operation on 40 meters phone where you continue to change the RX frequency when it gets too crowded up there near 7.239.

For hardware details, please see the [interfaces section](#) of this document.

To record a message to the **F1** memory, simply press **Shift-F1**. The same is true for **F2...F7**.

For more details on how to configure your DVK or record your messages, please refer to the [Configuring DVK messages](#) chapter in this manual.

## External Voice Keyers

As an alternative, Win-Test also allows you to control external voice keyers from the computer. This is a way to avoid the typical problems with hum, different audio levels etc. that you might face with sound cards. On the other hand, most of the time it is another box on the table. So it's up to you to decide which solution is the best for you.

These devices can be controlled via the LPT port of your computer. Typically, there are separate pins for message#1...message#4 and another one to stop the message. For details, please look in the [interfaces section](#) of this document.

## How to use

Similar to CW, **F1** is the most used function key in SSB contests. This key is used to send the CQ message. While you cannot really automate the QSO, you may wish to put a long CQ into the **F2** memory and a "Thank you, QRZ" message into **F3**. This saves you from a lot of routine talk in SSB contests.

There is not much more you can do here. Win-Test does not support storing single characters so that you could fully run the QSOs from the computer like with CT using the specially designed DVP card.

## RTTY Keying

Operating a RTTY contest is very similar to operating CW when using generated CW messages. All of the keys have the same functionality on RTTY, including the keyboard mode, the **[ESC]** key etc. The difference is that decoding RTTY is done by the machine and not by your brain (well, not normally). Using the mouse, you will be able to select call signs and reports received from the RTTY window but the keys you use to conduct the QSO are essentially the same like on CW.

## The Autorepeat Function

There is a function that is helpful on CW, SSB and RTTY: Autorepeat. This feature comes in handy during slow times, when you get few replies to your CQs. When activated, the **F1** message will repeat as long as you do not enter characters into the callsign field. If you do, it stops immediately, lets you complete the QSO and when done, pressing **F1** again re-activates the auto CQ. The timing of the CQ message has to be set up appropriately. Please see the [Tools](#) menu for more details.

### Namespaces

- [Page](#)
- [Discussion](#)

### Variants

### Views

































- [Read](#)
- [View source](#)
- [View history](#)

### More

- This page was last edited on 1 February 2007, at 14:04.
- [Privacy policy](#)
- [About Win-Test Wiki](#)
- [Disclaimers](#)



# Index of /pdf/daily

<u>Name</u>	<u>Last modified</u>	<u>Size</u>	<u>Description</u>
 <a href="#">Parent Directory</a>		-	
 <a href="#">NEW win-test.pdf</a>	2024-03-30 01:05	9.8M	
 <a href="#">win-test-20240229.pdf</a>	2024-02-29 01:04	49M	
 <a href="#">win-test-20240301.pdf</a>	2024-03-01 01:06	49M	
 <a href="#">win-test-20240302.pdf</a>	2024-03-02 01:04	49M	
 <a href="#">win-test-20240303.pdf</a>	2024-03-03 01:05	49M	
 <a href="#">win-test-20240304.pdf</a>	2024-03-04 01:04	49M	
 <a href="#">win-test-20240305.pdf</a>	2024-03-05 01:05	49M	
 <a href="#">win-test-20240306.pdf</a>	2024-03-06 01:05	49M	
 <a href="#">win-test-20240307.pdf</a>	2024-03-07 01:05	49M	
 <a href="#">win-test-20240308.pdf</a>	2024-03-08 01:05	49M	
 <a href="#">win-test-20240309.pdf</a>	2024-03-09 01:05	49M	
 <a href="#">win-test-20240310.pdf</a>	2024-03-10 01:05	49M	
 <a href="#">win-test-20240311.pdf</a>	2024-03-11 01:05	49M	
 <a href="#">win-test-20240312.pdf</a>	2024-03-12 01:05	49M	
 <a href="#">win-test-20240313.pdf</a>	2024-03-13 01:05	49M	
 <a href="#">win-test-20240314.pdf</a>	2024-03-14 01:05	49M	
 <a href="#">win-test-20240315.pdf</a>	2024-03-15 01:05	49M	
 <a href="#">win-test-20240316.pdf</a>	2024-03-16 01:05	49M	
 <a href="#">win-test-20240317.pdf</a>	2024-03-17 01:05	49M	
 <a href="#">win-test-20240318.pdf</a>	2024-03-18 01:04	49M	
 <a href="#">win-test-20240319.pdf</a>	2024-03-19 01:05	49M	
 <a href="#">win-test-20240320.pdf</a>	2024-03-20 01:04	49M	
 <a href="#">win-test-20240321.pdf</a>	2024-03-21 01:05	49M	
 <a href="#">win-test-20240322.pdf</a>	2024-03-22 01:04	49M	
 <a href="#">win-test-20240323.pdf</a>	2024-03-23 01:05	49M	
 <a href="#">win-test-20240324.pdf</a>	2024-03-24 01:05	49M	
 <a href="#">win-test-20240325.pdf</a>	2024-03-25 01:05	49M	
 <a href="#">win-test-20240326.pdf</a>	2024-03-26 01:05	49M	
 <a href="#">win-test-20240327.pdf</a>	2024-03-27 01:05	49M	
 <a href="#">win-test-20240328.pdf</a>	2024-03-28 01:05	49M	
 <a href="#">win-test-20240329.pdf</a>	2024-03-29 01:05	49M	

<u>Name</u>	<u>Last modified</u>	<u>Size</u>	<u>Description</u>
 <a href="#">win-test-20240330.pdf</a>	2024-03-30 01:05	49M	

---

Apache/2.4.41 Server at docs.win-test.com Port 80

# Database Files

From Win-Test Wiki

[Jump to navigation](#) [Jump to search](#)

Win-Test has a feature called 'exchange guessing', which aims to fill in the exchange for a specific callsign by searching a database of known testers' callsigns and their usual exchanges in a database file.

These database files are available from <http://download.win-test.com/databases>.

This directory contains 3 types of files:

- Countries / Mult files
- Mult equivalence files
- Exchange Databases

Some of them are zipped to save space and bandwidth on our server.

## Contents

- [1 Country Files/Mult Files](#)
- [2 Mult Equivalence Files](#)
- [3 Exchange Databases](#)
- [4 Installing a Database file](#)
  - ◆ [4.1 Downloading](#)
  - ◆ [4.2 Installing](#)
  - ◆ [4.3 Updating](#)
- [5 Exchange Guessing](#)
  - ◆ [5.1 Setting up Exchange Guessing in Win-Test](#)
  - ◆ [5.2 Exchange Guessing in VHF/UHF/SHF Contests](#)
  - ◆ [5.3 A note about Exchange Guessing](#)
- [6 Brewing your own Database file](#)
- [7 See also](#)

## Country Files/Mult Files

These files are used by WT to maintain countries or multipliers lists. The default country files (**CTY\*.DAT**) are now in this directory:

<http://download.win-test.com/files/country/>

Mult lists files, specific to some contests:

AGCW.DAT	AGCW Happy New Year contest, Maintained by Lothar DJ8EW (Lothar _at_ Sac)
ARISEC.DAT	ARI Sezioni contest
DOK.DAT	DARC WAG contest
DOK_XMAS.DAT	DARC Xmas contest
IOTA.DAT	RSGB IOTA contest
RDA.DAT	RDA contest

UFT.DAT                    UFT HF contest

## Mult Equivalence Files

These files are useful to substitute entered exchanges with official ones.

ARIPROV.DAT                ARI Contest  
 OBLASTS.DAT               Russian DX contest  
 STATES.DAT                ARRL 10m, ARRL DX (DX side) and CQWW 160m contests  
 VEPROV.DAT                RAC Canada Day and Canada Winter contests

## Exchange Databases

The WT databases are used, if possible, to "guess" the received exchanges. These are binary files and are not editable with a text editor.

VHF.DTB is used for all VHF+ EU contests.

Note: **VHF\_USA.DTB** (inside in **VHF\_USA.ZIP**) must be used for US VHF+ contests and VHF DXPed (US callsigns and 4-chars locators). This file is maintained by Dave W9ZRX (zephhd\_at\_indy.rr.com) To use the **VHF\_USA.DTB** file, download it, and rename it **VHF.DTB**

Other databases are adapted for some contests:

AGCW_DTC.DTB	AGCW DTC
AGCW_HNY.DTB	AGCW Happy New Year contest
ARI.DTB	ARI and ARI 40/80 contest
ARI_SEZIONI.DTB	ARI Sezioni Contest
ARRL_10M.DTB	ARRL 10m (contains US/VE/XE stations only)
ARRL_160M.DTB	ARRL 160 m and ARRL Sweepstakes (contains US/VE/XE stations only)
ARRL-ALL.DTB	NAQP, NA Sprint
ARRL-DX.DTB	ARRL DX contest (use if you are inside US/VE)
ARRL-USVE.DTB	ARRL DX contest, ARRL RTTY Roundup, CQWW 160m, CQWW DX RTTY, RAC Day and
CQWW.DTB	CQWW DX, GACW and JIDX contests (JA side)
EU_DX.DTB	EU-DX contest
EU_HF.DTB	EU HF contest
FOC_MARATHON.DTB	FOC Marathon
HADX.DTB	HADX contest
HELVETIA_DX.DTB	Helvetia DX
ITU.DTB	IARU HF contest and LZ DX contest (LZ side) and RRTC
IOTA.DTB	IOTA contest (Islands activities)
JIDX.DTB	JIDX contest (DX side)
KCJ.DTB	KCJ (Keyman's Club of Japan) contest
KOS.DTB	King Of Spain contest
LZDX.DTB	LZ DX contest (DX side)
NCCC.DTB	NCCC Sprint
NRAU_BALTIC.DTB	NRAU Baltic contest
OKOMDX.DTB	OK OM DX contest
PACC_DX.DTB	PACC contest (DX side)
RAEM.DTB	RAEM contest
RDAC.DTB	RDA contest
RDXC.DTB	Russian DX contest
REFHF.DTB	REF HF contest
RSGB.DTB	RSGB 160 m and RSGB 21/28 (DX side) contests
SCC.DTB	SCC RTTY Championship
SPDX.DTB	SP DX contest (DX side)
STEW-PERRY.DTB	Stew Perry contest

## Win-Test Wiki

UBADX.DTB	UBA DX contest
UBA_SPRING.DTB	UBA Spring contests
UFT_HF.DTB	UFT HF contest
UK_EI.DTB	UK/EI contest
UKDX.DTB	Ukrainian DX contest
WAG_DL.DTB	WAG, DARC XMas and DARC 10m contest
YODX.DTB	YO DX Contest (DX side)
YUDX.DTB	YU DX contest

For more details, please look at the [READ\\_ME.TXT](#) file in the database site directory.

## Installing a Database file

### Downloading

Win-Test database files come in a binary format (.DTB). The Win-Test Team provides several of these files at <http://download.win-test.com/databases>. Look for the .DTB or .ZIP files (larger database files are collected in .ZIP archives).

### Installing

After downloading, the corresponding .DTB files need to be copied to the Win-Test 3 installation directory or the Win-Test 4 application data directory. Zip files have to be unpacked before they can be used by Win-Test (which loads .DTB files only).

For Win-Test version 4, save database files in:

- Windows XP: **C:\Documents and Settings\All Users\Application Data\Win-Test\databases\**
- Windows Vista, Windows 7 and 10: **C:\ProgramData\Win-Test\databases\**

Please see also the note about Win-Test's [Virtual Store](#).

For Win-Test version 3, save database files in:

- **C:\Program Files\Win-Test\** (or the Win-Test installation directory)

See [Check Partial and Np1 Files - Location](#) for more info on how to view these often-hidden directories.

Win-Test will then load automatically, at start-up, the corresponding database file (according to the actual selected contest), if those files are available.

### Updating

Data in .DTB files may be updated with more recent exchange data from your own logs. Simply open a log file, or import a Cabrillo file for any particular contest, and select **File | Update database** from the Win-Test menu. To see which .DTB file was updated, select **File | Explore | /databases directory**, View Details, and click "Date Modified" to sort the list by date. See also [Brewing your own Database file](#).

**Warning:** If a contest-specific database file such as **cqww.dtb** is available, it will also be used by the Check Partial windows *instead of* **master.scp**, which may not be wanted. To override this, use file name **default.scp** instead of **master.scp**.



## Exchange Guessing

Other than the Super Check Partial and N+1 functions in Win-Test, exchange guessing helps the operator to "know what to expect" in the course of a contest QSO. Many contests come with a fixed exchange, be it a county or regional identifier, a QTH locator or a callsign specific identifier. This type of information can be "guessed" by the software so that the operator only has to confirm or correct this information.

Please note that this feature is different from the Super Check Partial database (MASTER.SCP, DEFAULT.SCP, HF.DTB, VHF.DTB) and also different from the [Extra data files](#) (XDT). See [Check Partial and Np1 Files](#).

### Setting up Exchange Guessing in Win-Test

After the database files have been installed, we need to activate the exchange guessing.

To do this, select **Tools | Data entry | Exchange guessing** from the Top Menu.

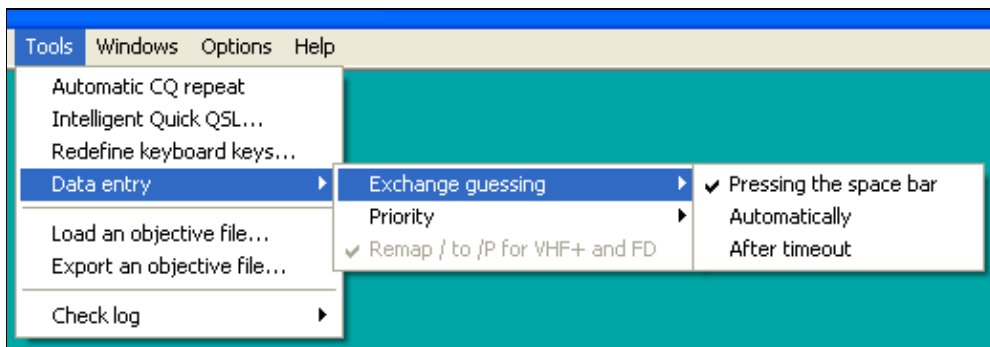

Activate Exchange Guessing

Three options are available:

- `Pressing the spacebar` - this will fill in the exchange upon entering a callsign and hitting spacebar to move the entry cursor to the report field. This is the default setting.
- `Automatically` - this will fill in the exchange as soon as you have entered the last character of the callsign and Win-Test has found an entry for it in the database file. Since this is a more resource intensive operation than the 'Pressing the spacebar' option, it is not recommended for slow, or low-end, computers.
- `After timeout` - this option will fill in the exchange after a certain amount of time has elapsed without changes to the callsign.

Now, when you enter a callsign in the log entry area, the pre-guessed report will automatically come up. Also, the Check Partial window can show the same information, if it has been enabled by checking the **Display exchange** option in the context menu.

## Win-Test Wiki

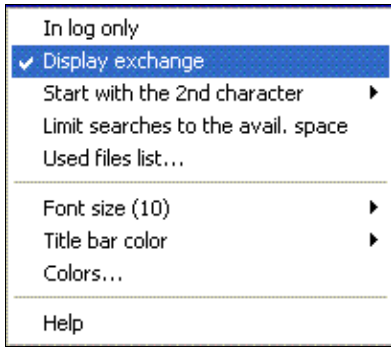

The Check Partial Context menu allows you to see pre-guessed report information - this information is in brackets right to the callsign.

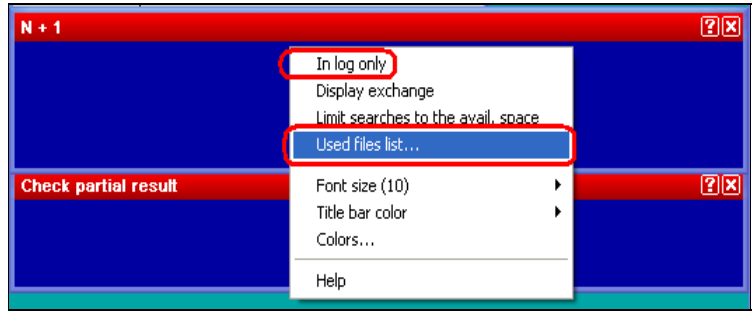

Make sure you have loaded the correct version of the DTB file. This window is brought up via the context menu of the Check Partial window by selecting "Used files list...".

Moreover, you can also verify which are the loaded database files through the **Used files list...** option, in the context menu (see above).

Also the Band Map can show the guessed exchange information and highlight the stations accordingly, if the **Display options | Exchange** has been checked in its context menu.

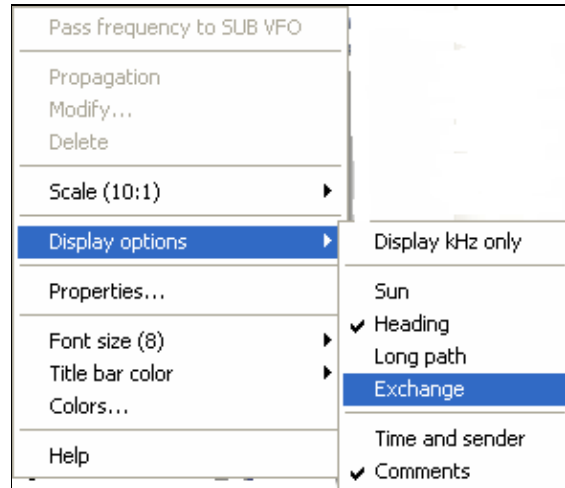

Exchange Guessing enabling context menu

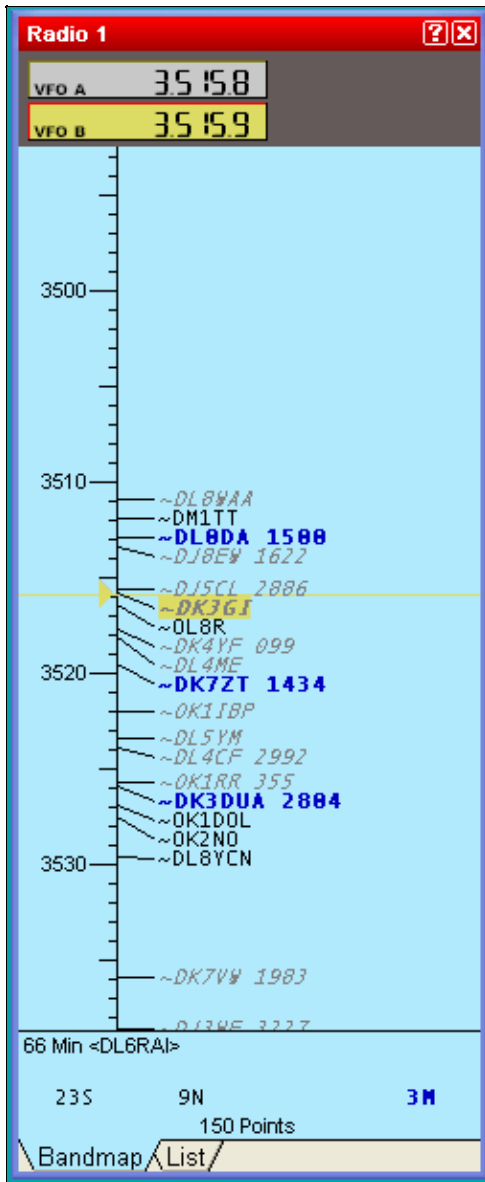

Band map with Exchange Guessing enabled

## Exchange Guessing in VHF/UHF/SHF Contests

In VHF+ contests logs, you can enter a partial callsign (in the callsign field) and/or a partial locator/grid (in the grid square field) to refine searches in the Check Partial windows (F12). The minimum number of characters to start the search for the callsign field is set by the contextual menu (3 by default), and set to 2 characters for the locator.

In both fields you can also use wildcard characters '?' to represent a character. Ex: **JN?8EQ** will search for all callsigns with locator **JN08EQ, JN18EQ, JN28EQ, ... JN98EQ**.

The resulting matches are displayed in the Check Partial window.

### A note about Exchange Guessing

Exchange guessing is provided as a feature, that is, to assist the operator. It is NOT recommend to be used as a replacement for your ears! :) . You should always try to hear the exchange sent from the station you are working as there can be discrepancies in the database files.

## Brewing your own Database file

**Beware:** This section is for the brave and experienced programmer and power user!

Win-Test's .DTB files come in a binary format and - by default - are not editable with a simple tool like a text editor or a word processor. Having some programming expertise, you can still successfully create/replace an existing .DTB file with your own version. Remember, however, that you can not make Win-Test load a database it doesn't know.

The file structure of the database files is straightforward and simple: As an example, take a look at the first bytes of the WAG\_DL.DTB file used for looking up DOKs:

```
00000000  44 41 30 41  41 00 00 00  00 00 00 00  00 00 52 31  DA0AA.....R1
00000010  37 00 00 00  00 00 00 00  00 00 44 41  30 42 41 59  7.....DA0BAY
00000020  00 00 00 00  00 00 00 00  42 30 36 00  00 00 00 00  .....B06.....
00000030  00 00 00 00  44 41 30 43  42 00 00 00  00 00 00 00  ....DA0CB.....
00000040  00 00 59 32  34 00 00 00  00 00 00 00  00 00 44 41  ..Y24.....DA
00000050  30 43 57 00  00 00 00 00  00 00 00 00  55 32 33 00  0CW.....U23.
00000060  00 00 00 00  00 00 00 00  44 41 30 44  49 47 00 00  .....DA0DIG..
[...]
```

From that hex dump we can see that the file consists of records of equal length of 26 bytes. The callsign is stored as a null-padded string in the first 14 bytes, the corresponding information (the DOK) is contained in the following 12 bytes, also null-padded.

As another example, let's take a look at the file VHF.DTB, which contains stations active on the VHF/UHF bands and their corresponding QTH locators:

```
00000000  34 4E 31 42  00 00 00 00  00 00 00 00  00 00 4B 4E  4N1B.....KN
00000010  30 35 43 52  00 30 31 39  35 00 39 41  31 42 00 00  05CR.0195.9A1B..
00000020  00 00 00 00  00 00 00 00  4A 4E 38 35  4A 58 00 30  .....JN85JX.0
00000030  31 39 35 00  39 41 31 42  20 00 00 00  00 00 00 00  195.9A1B .....
```

## Win-Test Wiki

```
00000040 00 00 4A 4E 38 35 4F 56 00 30 31 39 35 00 39 41 ..JN85OV.0195.9A
00000050 31 43 43 55 00 00 00 00 00 00 00 00 4A 4E 38 35 1CCU.....JN85
00000060 4C 49 00 30 31 39 35 00 39 41 31 43 45 51 00 00 LI.0195.9A1CEQ..
[...]
```

Here you can basically see the same file structure with the exception that the information field is actually split in two fields, one containing the information to display, and another one which contains information about the content itself - namely when this very piece of information was verified last - here "0195" meaning "January 1995".

Using a programming environment like Perl, you can create a simple application that will do the job for you. Here is a sample. Please feel free to copy and adapt to your needs.

The program processes a number of .db plaintext files (line 3). To work around duplicate information (e.g. one station is listed with several different locators), a space character is appended to the callsign (line 11). True duplicates are simply eliminated (line 7). Once the data collection process is finished, a new .dtb file is created (line 21) and - using Perl's pack() function, the records are created (line 23) and written to the file (line 24). The date information is left at 0195 for simplicity. This could certainly be elaborated to some detail.

The final product has to be renamed to VHF.DTB before Win-Test will start using it.

```
1 #!/usr/bin/perl
2
3 foreach $f (<*.db>) {
4     open(IN,$f);
5     while(<IN>) {
6         ($c,$q) = split;
7         goto DONE if (length($c) < 1);
8         if (defined($m{$c})) {
9             goto DONE if ($m{$c} eq $q);
10            while (defined($m{$c})) {
11                $c .= ' ';
12                goto DONE if ($m{$c} eq $q);
13            }
14        }
15        $m{$c} = $q;
16        DONE:
17    }
18    close(IN);
19 }
20
21 open(OUT,"> vhf_new.dtb");
22 foreach (sort keys %m) {
23     $r = pack("a14a6xa4x", $_, $m{$_}, "0195");
24     print OUT $r;
25 }
26 close(OUT);
```

After all, if you can contribute updated .DTB files of reasonably good quality, the Win-Test team will be happy to incorporate them into their distribution which is available for free on the internet.

## See also

Some other methods, to create/update DTB-Files, have been described by F6FVY in the WT Support forum (see: <http://lists.f5mzn.org/pipermail/support/2007-January/072867.html>).

## Namespaces

- [Page](#)
- [Discussion](#)

## Variants

## Views

- [Read](#)
- [View source](#)
- [View history](#)

## More

- This page was last edited on 10 February 2021, at 23:35.

- [Privacy policy](#)
- [About Win-Test Wiki](#)
- [Disclaimers](#)



# Database Files

From Win-Test Wiki

[Jump to navigation](#) [Jump to search](#)

Win-Test has a feature called 'exchange guessing', which aims to fill in the exchange for a specific callsign by searching a database of known contesters' callsigns and their usual exchanges in a database file.

These database files are available from <http://download.win-test.com/databases>.

This directory contains 3 types of files:

- Countries / Mult files
- Mult equivalence files
- Exchange Databases

Some of them are zipped to save space and bandwidth on our server.

## Contents

- [1 Country Files/Mult Files](#)
- [2 Mult Equivalence Files](#)
- [3 Exchange Databases](#)
- [4 Installing a Database file](#)
  - ◆ [4.1 Downloading](#)
  - ◆ [4.2 Installing](#)
  - ◆ [4.3 Updating](#)
- [5 Exchange Guessing](#)
  - ◆ [5.1 Setting up Exchange Guessing in Win-Test](#)
  - ◆ [5.2 Exchange Guessing in VHF/UHF/SHF Contests](#)
  - ◆ [5.3 A note about Exchange Guessing](#)
- [6 Brewing your own Database file](#)
- [7 See also](#)

## Country Files/Mult Files

These files are used by WT to maintain countries or multipliers lists. The default country files (**CTY\*.DAT**) are now in this directory:

<http://download.win-test.com/files/country/>

Mult lists files, specific to some contests:

AGCW.DAT	AGCW Happy New Year contest, Maintained by Lothar DJ8EW (Lothar _at_ Sac)
ARISEC.DAT	ARI Sezioni contest
DOK.DAT	DARC WAG contest
DOK_XMAS.DAT	DARC Xmas contest
IOTA.DAT	RSGB IOTA contest
RDA.DAT	RDA contest

UFT.DAT                    UFT HF contest

## Mult Equivalence Files

These files are useful to substitute entered exchanges with official ones.

ARIPROV.DAT                ARI Contest  
 OBLASTS.DAT               Russian DX contest  
 STATES.DAT                ARRL 10m, ARRL DX (DX side) and CQWW 160m contests  
 VEPROV.DAT                RAC Canada Day and Canada Winter contests

## Exchange Databases

The WT databases are used, if possible, to "guess" the received exchanges. These are binary files and are not editable with a text editor.

VHF.DTB is used for all VHF+ EU contests.

Note: **VHF\_USA.DTB** (inside in **VHF\_USA.ZIP**) must be used for US VHF+ contests and VHF DXPed (US callsigns and 4-chars locators). This file is maintained by Dave W9ZRX (zephhd\_at\_indy.rr.com) To use the **VHF\_USA.DTB** file, download it, and rename it **VHF.DTB**

Other databases are adapted for some contests:

AGCW_DTC.DTB	AGCW DTC
AGCW_HNY.DTB	AGCW Happy New Year contest
ARI.DTB	ARI and ARI 40/80 contest
ARI_SEZIONI.DTB	ARI Sezioni Contest
ARRL_10M.DTB	ARRL 10m (contains US/VE/XE stations only)
ARRL_160M.DTB	ARRL 160 m and ARRL Sweepstakes (contains US/VE/XE stations only)
ARRL-ALL.DTB	NAQP, NA Sprint
ARRL-DX.DTB	ARRL DX contest (use if you are inside US/VE)
ARRL-USVE.DTB	ARRL DX contest, ARRL RTTY Roundup, CQWW 160m, CQWW DX RTTY, RAC Day and
CQWW.DTB	CQWW DX, GACW and JIDX contests (JA side)
EU_DX.DTB	EU-DX contest
EU_HF.DTB	EU HF contest
FOC_MARATHON.DTB	FOC Marathon
HADX.DTB	HADX contest
HELVETIA_DX.DTB	Helvetia DX
ITU.DTB	IARU HF contest and LZ DX contest (LZ side) and RRTC
IOTA.DTB	IOTA contest (Islands activities)
JIDX.DTB	JIDX contest (DX side)
KCJ.DTB	KCJ (Keyman's Club of Japan) contest
KOS.DTB	King Of Spain contest
LZDX.DTB	LZ DX contest (DX side)
NCCC.DTB	NCCC Sprint
NRAU_BALTIC.DTB	NRAU Baltic contest
OKOMDX.DTB	OK OM DX contest
PACC_DX.DTB	PACC contest (DX side)
RAEM.DTB	RAEM contest
RDAC.DTB	RDA contest
RDXC.DTB	Russian DX contest
REFHF.DTB	REF HF contest
RSGB.DTB	RSGB 160 m and RSGB 21/28 (DX side) contests
SCC.DTB	SCC RTTY Championship
SPDX.DTB	SP DX contest (DX side)
STEW-PERRY.DTB	Stew Perry contest



## Win-Test Wiki

UBADX.DTB	UBA DX contest
UBA_SPRING.DTB	UBA Spring contests
UFT_HF.DTB	UFT HF contest
UK_EI.DTB	UK/EI contest
UKDX.DTB	Ukrainian DX contest
WAG_DL.DTB	WAG, DARC XMas and DARC 10m contest
YODX.DTB	YO DX Contest (DX side)
YUDX.DTB	YU DX contest

For more details, please look at the [READ\\_ME.TXT](#) file in the database site directory.

## Installing a Database file

### Downloading

Win-Test database files come in a binary format (.DTB). The Win-Test Team provides several of these files at <http://download.win-test.com/databases>. Look for the .DTB or .ZIP files (larger database files are collected in .ZIP archives).

### Installing

After downloading, the corresponding .DTB files need to be copied to the Win-Test 3 installation directory or the Win-Test 4 application data directory. Zip files have to be unpacked before they can be used by Win-Test (which loads .DTB files only).

For Win-Test version 4, save database files in:

- Windows XP: **C:\Documents and Settings\All Users\Application Data\Win-Test\databases\**
- Windows Vista, Windows 7 and 10: **C:\ProgramData\Win-Test\databases\**

Please see also the note about Win-Test's [Virtual Store](#).

For Win-Test version 3, save database files in:

- **C:\Program Files\Win-Test\** (or the Win-Test installation directory)

See [Check Partial and Np1 Files - Location](#) for more info on how to view these often-hidden directories.

Win-Test will then load automatically, at start-up, the corresponding database file (according to the actual selected contest), if those files are available.

### Updating

Data in .DTB files may be updated with more recent exchange data from your own logs. Simply open a log file, or import a Cabrillo file for any particular contest, and select **File | Update database** from the Win-Test menu. To see which .DTB file was updated, select **File | Explore | /databases directory**, View Details, and click "Date Modified" to sort the list by date. See also [Brewing your own Database file](#).

**Warning:** If a contest-specific database file such as **cqww.dtb** is available, it will also be used by the Check Partial windows *instead of* **master.scp**, which may not be wanted. To override this, use file name **default.scp** instead of **master.scp**.

## Exchange Guessing

Other than the Super Check Partial and N+1 functions in Win-Test, exchange guessing helps the operator to "know what to expect" in the course of a contest QSO. Many contests come with a fixed exchange, be it a county or regional identifier, a QTH locator or a callsign specific identifier. This type of information can be "guessed" by the software so that the operator only has to confirm or correct this information.

Please note that this feature is different from the Super Check Partial database (MASTER.SCP, DEFAULT.SCP, HF.DTB, VHF.DTB) and also different from the [Extra data files](#) (XDT). See [Check Partial and Np1 Files](#).

### Setting up Exchange Guessing in Win-Test

After the database files have been installed, we need to activate the exchange guessing.

To do this, select **Tools | Data entry | Exchange guessing** from the Top Menu.

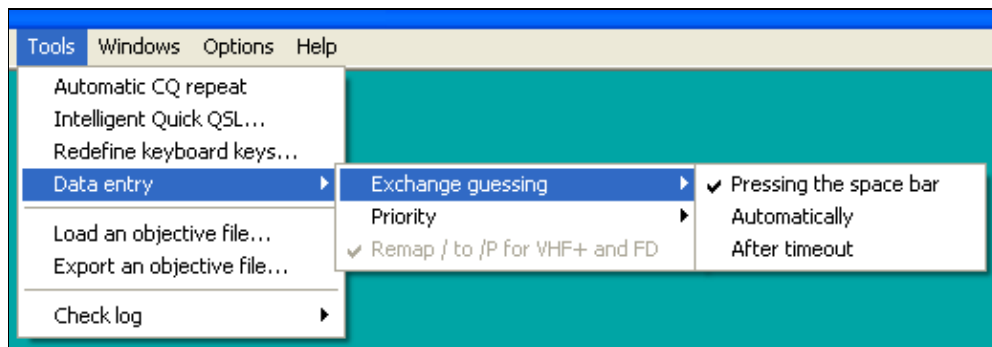

Activate Exchange Guessing

Three options are available:

- `Pressing the spacebar` - this will fill in the exchange upon entering a callsign and hitting spacebar to move the entry cursor to the report field. This is the default setting.
- `Automatically` - this will fill in the exchange as soon as you have entered the last character of the callsign and Win-Test has found an entry for it in the database file. Since this is a more resource intensive operation than the 'Pressing the spacebar' option, it is not recommended for slow, or low-end, computers.
- `After timeout` - this option will fill in the exchange after a certain amount of time has elapsed without changes to the callsign.

Now, when you enter a callsign in the log entry area, the pre-guessed report will automatically come up. Also, the Check Partial window can show the same information, if it has been enabled by checking the **Display exchange** option in the context menu.

## Win-Test Wiki

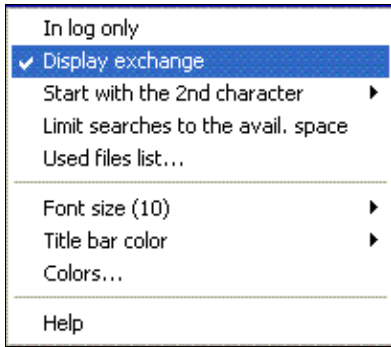

The Check Partial Context menu allows you to see pre-guessed report information - this information is in brackets right to the callsign.

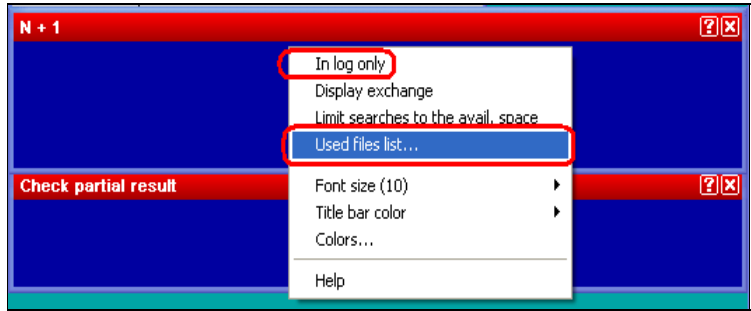

Make sure you have loaded the correct version of the DTB file. This window is brought up via the context menu of the Check Partial window by selecting "Used files list...".

Moreover, you can also verify which are the loaded database files through the **Used files list...** option, in the context menu (see above).

Also the Band Map can show the guessed exchange information and highlight the stations accordingly, if the **Display options | Exchange** has been checked in its context menu.

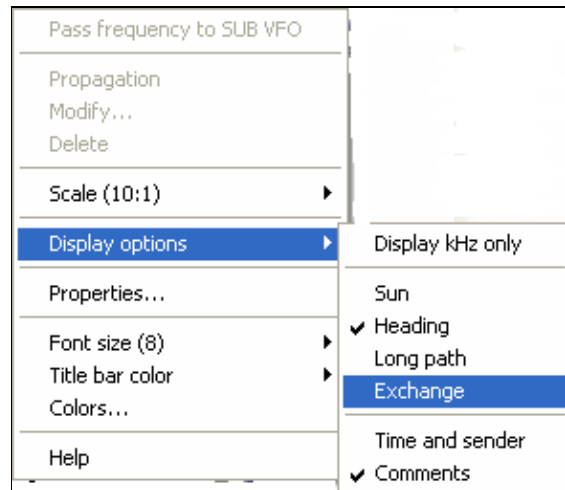

Exchange Guessing enabling context menu

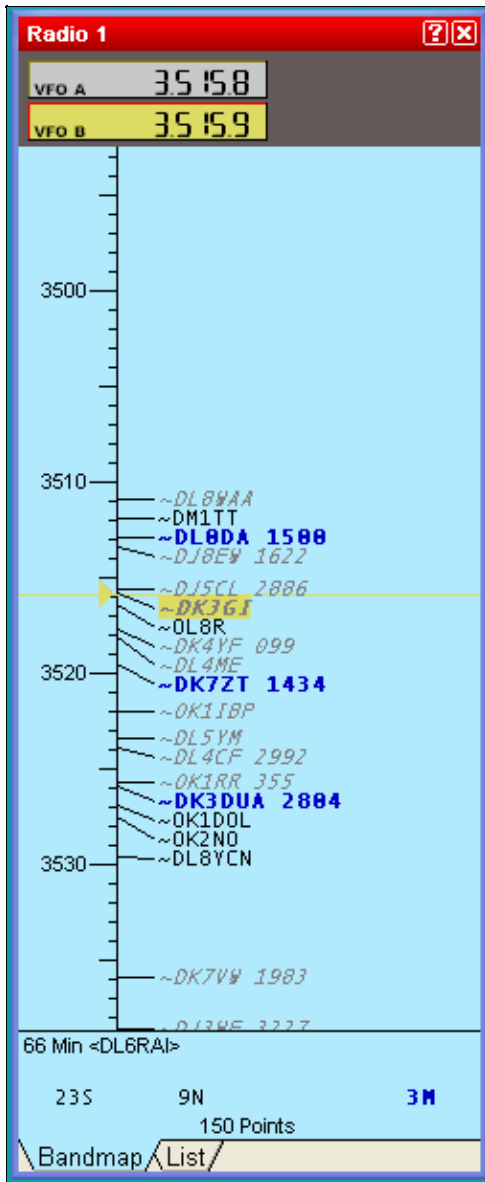

Band map with Exchange Guessing enabled

## Exchange Guessing in VHF/UHF/SHF Contests

In VHF+ contests logs, you can enter a partial callsign (in the callsign field) and/or a partial locator/grid (in the grid square field) to refine searches in the Check Partial windows (F12). The minimum number of characters to start the search for the callsign field is set by the contextual menu (3 by default), and set to 2 characters for the locator.

In both fields you can also use wildcard characters '?' to represent a character. Ex: **JN?8EQ** will search for all callsigns with locator **JN08EQ, JN18EQ, JN28EQ, ... JN98EQ**.

The resulting matches are displayed in the Check Partial window.

### A note about Exchange Guessing

Exchange guessing is provided as a feature, that is, to assist the operator. It is NOT recommend to be used as a replacement for your ears! :) . You should always try to hear the exchange sent from the station you are working as there can be discrepancies in the database files.

## Brewing your own Database file

**Beware:** This section is for the brave and experienced programmer and power user!

Win-Test's .DTB files come in a binary format and - by default - are not editable with a simple tool like a text editor or a word processor. Having some programming expertise, you can still successfully create/replace an existing .DTB file with your own version. Remember, however, that you can not make Win-Test load a database it doesn't know.

The file structure of the database files is straightforward and simple: As an example, take a look at the first bytes of the WAG\_DL.DTB file used for looking up DOKs:

```
00000000 44 41 30 41 41 00 00 00 00 00 00 00 00 00 00 52 31 DA0AA.....R1
00000010 37 00 00 00 00 00 00 00 00 00 44 41 30 42 41 59 7.....DA0BAY
00000020 00 00 00 00 00 00 00 00 42 30 36 00 00 00 00 00 .....B06.....
00000030 00 00 00 00 44 41 30 43 42 00 00 00 00 00 00 00 00 ....DA0CB.....
00000040 00 00 59 32 34 00 00 00 00 00 00 00 00 00 44 41 ..Y24.....DA
00000050 30 43 57 00 00 00 00 00 00 00 00 00 55 32 33 00 0CW.....U23.
00000060 00 00 00 00 00 00 00 00 44 41 30 44 49 47 00 00 .....DA0DIG..
[...]
```

From that hex dump we can see that the file consists of records of equal length of 26 bytes. The callsign is stored as a null-padded string in the first 14 bytes, the corresponding information (the DOK) is contained in the following 12 bytes, also null-padded.

As another example, let's take a look at the file VHF.DTB, which contains stations active on the VHF/UHF bands and their corresponding QTH locators:

```
00000000 34 4E 31 42 00 00 00 00 00 00 00 00 00 00 4B 4E 4N1B.....KN
00000010 30 35 43 52 00 30 31 39 35 00 39 41 31 42 00 00 05CR.0195.9A1B..
00000020 00 00 00 00 00 00 00 00 4A 4E 38 35 4A 58 00 30 .....JN85JX.0
00000030 31 39 35 00 39 41 31 42 20 00 00 00 00 00 00 00 195.9A1B .....
```

## Win-Test Wiki

```
00000040 00 00 4A 4E 38 35 4F 56 00 30 31 39 35 00 39 41 ..JN85OV.0195.9A
00000050 31 43 43 55 00 00 00 00 00 00 00 00 4A 4E 38 35 1CCU.....JN85
00000060 4C 49 00 30 31 39 35 00 39 41 31 43 45 51 00 00 LI.0195.9A1CEQ..
[...]
```

Here you can basically see the same file structure with the exception that the information field is actually split in two fields, one containing the information to display, and another one which contains information about the content itself - namely when this very piece of information was verified last - here "0195" meaning "January 1995".

Using a programming environment like Perl, you can create a simple application that will do the job for you. Here is a sample. Please feel free to copy and adapt to your needs.

The program processes a number of .db plaintext files (line 3). To work around duplicate information (e.g. one station is listed with several different locators), a space character is appended to the callsign (line 11). True duplicates are simply eliminated (line 7). Once the data collection process is finished, a new .dtb file is created (line 21) and - using Perl's pack() function, the records are created (line 23) and written to the file (line 24). The date information is left at 0195 for simplicity. This could certainly be elaborated to some detail.

The final product has to be renamed to VHF.DTB before Win-Test will start using it.

```
1 #!/usr/bin/perl
2
3 foreach $f (<*.db>) {
4     open(IN,$f);
5     while(<IN>) {
6         ($c,$q) = split;
7         goto DONE if (length($c) < 1);
8         if (defined($m{$c})) {
9             goto DONE if ($m{$c} eq $q);
10            while (defined($m{$c})) {
11                $c .= ' ';
12                goto DONE if ($m{$c} eq $q);
13            }
14        }
15        $m{$c} = $q;
16        DONE:
17    }
18    close(IN);
19 }
20
21 open(OUT,"> vhf_new.dtb");
22 foreach (sort keys %m) {
23     $r = pack("a14a6xa4x", $_, $m{$_}, "0195");
24     print OUT $r;
25 }
26 close(OUT);
```

After all, if you can contribute updated .DTB files of reasonably good quality, the Win-Test team will be happy to incorporate them into their distribution which is available for free on the internet.

## See also

Some other methods, to create/update DTB-Files, have been described by F6FVY in the WT Support forum (see: <http://lists.f5mzn.org/pipermail/support/2007-January/072867.html>).

## Namespaces

- [Page](#)
- [Discussion](#)

## Variants

## Views

- [Read](#)
- [View source](#)
- [View history](#)

## More

- This page was last edited on 10 February 2021, at 23:35.

- [Privacy policy](#)
- [About Win-Test Wiki](#)
- [Disclaimers](#)



# Multi-op/Deleting QSO

From Win-Test Wiki

[Jump to navigation](#) [Jump to search](#)

## Deleting a QSO mid-contest in a multi-op situation

If you need to delete a QSO during a contest it is recommended you do **NOT** use the menu option [Edit | Delete QSO](#) as this will have the consequence of deleting the QSO in the log at your operating position *only* but **not** network-wide.

Instead, replace the callsign of the QSO you wish to delete with *your* callsign (specified when you created your log). For example, if you are using the callsign G6PZ and you wish to remove the QSO with CE1ABC, replace the CE1ABC callsign with G6PZ. Later, when it comes to [merging and exporting the logs](#), there is an option to delete all QSOs with yourself from the log.

In a Multi-Multi environment the QSO rate can be very high, therefore it can be useful to check [Menu | Edit | Move in my log only](#). Please refer to the [Menu:Edit Move in my log only](#) chapter in this manual for a full description of this option.

## Namespaces

- [Page](#)
- [Discussion](#)

## Variants

## Views

- [Read](#)
- [View source](#)
- [View history](#)

## More

- This page was last edited on 9 December 2016, at 23:29.
- [Privacy policy](#)
- [About Win-Test Wiki](#)
- [Disclaimers](#)





# Main Page

From Win-Test Wiki

[Jump to navigation](#) [Jump to search](#)

## Win-Test Documentation

- This documentation is current to version 4.47
- This documentation can be [downloaded in PDF format](#).

### I. **Preface**

1. [Authors and contributors](#)

### II. **Installation**

1. [Download the software](#)
2. [Install the software](#)
3. [Registering the software](#)

### III. **Configuration**

1. [One-time configuration](#)
  - ◇ [Interface configuration](#)
  - ◇ [DX Cluster configuration](#)
  - ◇ [Rotator configuration](#)
  - ◇ [RTTY configuration](#)
  - ◇ [Setting up networking](#)
  - ◇ [Category:BestPractice](#)
2. [Pre-contest configuration](#)

### IV. **Running a contest**

1. [Logging OSOs](#)
2. [SO1R](#)
3. [SO2R](#)
4. [Multi-op](#)
5. [Contest-specific behaviour](#)
6. [Posting live score on-line](#)
7. [Post-contest specifics](#)

### V. **Menus**

1. [File \(without a Win-Test file opened\)](#)
2. [File \(with a Win-Test file opened\)](#)
3. [Edit](#)
4. [Operating](#)
5. [Commands](#)
6. [Messages](#)
7. [Tools](#)
8. [Windows](#)
9. [Options](#)
10. [Help](#)

### VI. **More...**

1. [Icon bar](#)
2. [Text commands](#)
3. [Keys](#)
4. [Message variables \(aka macros\)](#)
5. [Supported contests](#)
6. [Supported rigs](#)

7. [Supported accessories](#)
8. [Check Partial and N+1 Files](#)
9. [Database files](#)
10. [Other files...](#)
11. [Release notes](#)
12. [Release notes \(old version 3 archive\)](#)

#### VII. **Frequently Asked Questions (FAQ)**

1. [Problems registering and running](#)
2. [DX Cluster and wtDxTelnet](#)
3. [Rotator control and wtRotators](#)
4. [User interface](#)
5. [Networking](#)
6. [Licensing issues](#)

#### VIII. **See also**

- ◆ [Win-Test installation, registration and configuration guide](#)
- ◆ [Win-Test quick start manual](#) — for Win-Test 3.11.0 (slightly outdated)
- ◆ [Win-Test mailing list](#)

## Namespaces

- [Main page](#)
- [Discussion](#)

## Variants

## Views

- [Read](#)
- [View source](#)
- [View history](#)

## More

- This page was last edited on 5 April 2020, at 16:54.

- [Privacy policy](#)
- [About Win-Test Wiki](#)
- [Disclaimers](#)



# Main Page

From Win-Test Wiki

[Jump to navigation](#) [Jump to search](#)

## Win-Test Documentation

- This documentation is current to version 4.47
- This documentation can be [downloaded in PDF format](#).

### I. **Preface**

1. [Authors and contributors](#)

### II. **Installation**

1. [Download the software](#)
2. [Install the software](#)
3. [Registering the software](#)

### III. **Configuration**

1. [One-time configuration](#)
  - ◇ [Interface configuration](#)
  - ◇ [DX Cluster configuration](#)
  - ◇ [Rotator configuration](#)
  - ◇ [RTTY configuration](#)
  - ◇ [Setting up networking](#)
  - ◇ [Category:BestPractice](#)
2. [Pre-contest configuration](#)

### IV. **Running a contest**

1. [Logging OSOs](#)
2. [SO1R](#)
3. [SO2R](#)
4. [Multi-op](#)
5. [Contest-specific behaviour](#)
6. [Posting live score on-line](#)
7. [Post-contest specifics](#)

### V. **Menus**

1. [File \(without a Win-Test file opened\)](#)
2. [File \(with a Win-Test file opened\)](#)
3. [Edit](#)
4. [Operating](#)
5. [Commands](#)
6. [Messages](#)
7. [Tools](#)
8. [Windows](#)
9. [Options](#)
10. [Help](#)

### VI. **More...**

1. [Icon bar](#)
2. [Text commands](#)
3. [Keys](#)
4. [Message variables \(aka macros\)](#)
5. [Supported contests](#)
6. [Supported rigs](#)

7. [Supported accessories](#)
8. [Check Partial and N+1 Files](#)
9. [Database files](#)
10. [Other files...](#)
11. [Release notes](#)
12. [Release notes \(old version 3 archive\)](#)

#### VII. **Frequently Asked Questions (FAQ)**

1. [Problems registering and running](#)
2. [DX Cluster and wtDxTelnet](#)
3. [Rotator control and wtRotators](#)
4. [User interface](#)
5. [Networking](#)
6. [Licensing issues](#)

#### VIII. **See also**

- ◆ [Win-Test installation, registration and configuration guide](#)
- ◆ [Win-Test quick start manual](#) — for Win-Test 3.11.0 (slightly outdated)
- ◆ [Win-Test mailing list](#)

## Namespaces

- [Main page](#)
- [Discussion](#)

## Variants

## Views

- [Read](#)
- [View source](#)
- [View history](#)



## More

- This page was last edited on 5 April 2020, at 16:54.

- [Privacy policy](#)
- [About Win-Test Wiki](#)
- [Disclaimers](#)



# Index of /pdf/downloads

<u>Name</u>	<u>Last modified</u>	<u>Size</u>	<u>Description</u>
 <a href="#">Parent Directory</a>		-	
 <a href="#">manual.pdf</a>	2024-03-30 01:05	49M	

Apache/2.4.41 Server at docs.win-test.com Port 80

# DVK CW RTTY Messaging

From Win-Test Wiki

[Jump to navigation](#) [Jump to search](#)

Configuring CW, RTTY and Digital Voice Keyer (henceforth DVK) messages in Win-Test can be done at any time 'on the fly'. This document shows you how. We will first cover how to configure CW messages and RTTY macros. For SSB, please look below under DVK.

## Contents

- [1 Configuring CW/RTTY messages](#)
  - ◆ [1.1 Additional CW/RTTY messages](#)
  - ◆ [1.2 Variables for use with CW/RTTY messages](#)
  - ◆ [1.3 Saving/Loading from \\*.msg file](#)
  - ◆ [1.4 Advanced SO2R specifics](#)
    - ◇ [1.4.1 SO2R specific variables](#)
  - ◆ [1.5 RTTY Message Tips](#)
- [2 Configuring the Win-Test DVK messages](#)
  - ◆ [2.1 Text commands related to the DVK functionality](#)
  - ◆ [2.2 Recording your messages in a separate application](#)
- [3 Using the microHAM DVK](#)
- [4 See Also](#)

## Configuring CW/RTTY messages

Editing CW and RTTY messages is a simple case of pressing **Shift+F $x$**  where  $x$  is a number in the range 1 .. 7. **F8** and above are reserved as shortcuts for opening/closing various windows within Win-Test. Other keys you can edit are **INSERT** and the plus (+) key (the former of which sends the callsign entered in the callsign entry field + the content of the F2 key, and the plus key sends a TU message and logs the QSO by default).

With a log open, press and hold **Shift+F1**. This will let you edit the message that is assigned to the **F1** key.

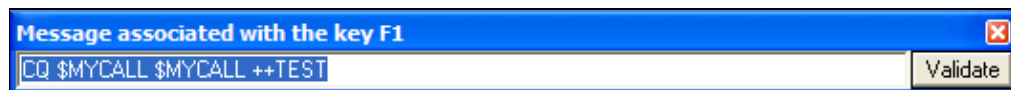

Editing CW/RTTY message for F1 key

By default, this is a CQ message. You'll notice some special variables, prefixed by a dollar symbol - for example, \$MYCALL, which is simply replaced by your callsign (as you entered in the [contest configuration](#) dialog box) when the message is sent. You can also speed up certain text by placing plus and minus symbols around the text which you want speeded up - *but you must ensure you have the same number of plus symbols (before the text) as minus symbols (after the text) otherwise you may discover some discrepancies in speed.*

Since the ++ and -- accelerators have sense in CW only, they must not be used in RTTY messages, so they have to be removed.

Now press **Shift+INSERT**. You will notice that all this is doing is sending \$LOGGEDCALL, which, as the name suggests, is replaced by the callsign you have currently entered in the callsign entry field, and the \$F2

variable is replaced by the content of the F2 key (thus you will have to use **Shift+F2** to edit the content for that key).

## Additional CW/RTTY messages

We understand that sometimes, **F1 .. F7** is just not adequate during a contest. So, Win-Test has catered for your needs. You can use additional CW/RTTY messages. To edit these CW/RTTY messages, use **ALT+C** to open the window. Enter the text you wish to have assigned to each key, and then you can simply click the **Transmit** button to send the messages

**Tip:** You can also press **ALT+C** to open the additional CW messages window and then just hit the corresponding F-key for the messages you wish to send.

Since the release 3.8.6 the Message Variables (see below) will work also within these additional CW/RTTY messages.

Please also note that the additional CW/RTTY messages dialog can also be reached by clicking on the `Options | CW | Modify additional messages...` or `Options | RTTY | Modify additional messages...` menu.

## Variables for use with CW/RTTY messages

OK, so now you understand *how* to edit the messages, but you want to know what all the various variables are/mean, right? Worry no more:

- \$SERIAL - sends the current QSO (serial) number
- \$LOGGEDCALL - sends the callsign you currently have entered in the callsign entry field
- \$ZONE - sends your zone (as entered in the [contest configuration](#) screen)
- \$ZONE2 - sends your state or province (the second box after zone as entered in the [contest configuration](#) screen for the CQ WW RTTY contest for U.S. and Canadian entrants)
- \$INSERT and \$PLUS - sends the messages contained within the INSERT and PLUS keys respectively
- \$MSG1 ... \$MSG12 - sends content of additional CW messages (see above)
- \$SPACEBAR - works just like hitting the SPACEBAR - can be useful within the INSERT key 'message' to move exchange fields
- \$GUESSEXCH - attempts to guess the exchange but does not move the entry field (see also [Database Files Installing a Database file](#))
- \$CR - works just like pressing RETURN/ENTER - useful for inclusion in the PLUS key 'message' (to enter the QSO in to the log)
- \$MYCALL - replaced with your callsign
- \$CORRECT - useful for inclusion within the PLUS key message to send the correct call if you made a change to the other station's callsign since hitting INSERT
- \$F1 ... \$F6 - sends the message corresponding to the F1 ... F6 key
- + and - - each plus symbol speeds up the text contained with these characters by 2 wpm, and minus slows down the text by 2 wpm. Please ensure you have an equal number of pluses and minuses around the text in question otherwise you may notice speed irregularity.
- Only in RTTY: \$13 sends a carriage return character, all message after this code will start on a new line in the terminal of the station receiving it.

## Saving/Loading from \*.msg file

Two buttons on the left lower corner of the window allow you to save/load your preferred settings from a \*.msg file. This way you can export/import your personal favourite setup. The files are stored to/read from the current op's directory, which is typically %ALLUSERSPOFILE%\win-Test\ops. Example messages file for a RTTY contest.

```
#
# Standard Messages File generated by Win-Test
#
[ RUN ]
F1 CQ TEST $MYCALL $MYCALL CQ
F2 $SETEXCHSENT $RST-$SERIAL-$SERIAL
F3 $SERIAL
F4 $MYCALL
F5 $LOGGEDCALL
F6 NR?
F7 ?
INSERT $LOGGEDCALL $QSOB4 $F2 $LOGGEDCALL
PLUS $LOGGEDCALL TU $CR $MYCALL CQ
#
[ S&P ]
F1 $MYCALL $MYCALL
F2 $RST-$SERIAL-$SERIAL
F3 $SERIAL
F4 $MYCALL
F5 $LOGGEDCALL
F6 NR?
F7 ?
INSERT $F1
PLUS $LOGGEDCALL QSL $F2 $MYCALL $CR
#
[ MISC ]
QSOB4 QSOB4
```

## Advanced SO2R specifics

Please note, for some SO2R configurations, you have to use **AltGr+Fx** to edit the messages. This is because of the 'shift binds second radio' functionality whereby the [**SHIFT**] key is bound to the second radio window (e.g. to enter a callsign on the second rig).

### SO2R specific variables

There are also some SO2R specific variables which can be used:

- \$R1R1, \$R1R2, \$R2R1, \$R2R2 - for headphone switching. For example, at the end of the F2 message, you could have \$R1R2 which would set the headphones so that the left ear is on radio 1 and the right ear is on radio 2, etc.
- \$TR1, \$TR2 - set the TX to radio 1 or radio 2
- \$RESET - reset any audio/headphone settings
- \$ALTERNATECQ (or \$ACQ) - swap primary and secondary radios and send CQ on the secondary radio
- \$CQ - same as \$ALTERNATECQ but does not swap radios

Please see the section regarding SO2R contesting for more information.



## RTTY Message Tips

Here are some tips from W0YK for RTTY contesting.

RTTY contesting is evolving to be competitively similar to CW contesting. RTTY contests are no longer rallies for RTTY specialists to contact each other and work new countries. Just like the evolution of CW and SSB contesting, RTTY contesting is comprised of a growing number of serious contesters trying to be as efficient as possible with their transmissions. As such, RTTY contest messages should basically be similar to CW contest messages. Accordingly, here are some tips and recommendations for RTTY contest messages:

- Start most messages with a carriage return (\$13) so that the message will stand out from noise and other information on the recipient's screen. Exceptions are your call sign message and his call sign message, where you may want to repeat them or chain with other messages.
- End all messages with a space character to separate it from noise and other information.
- Modularize messages so they can be repeated or combined to best fit the situation at the time. For example, have a message that contains your call sign only once. Depending on conditions, you may tap that function key twice or perhaps three times, with an appropriate amount of delay (space) between taps.
- Omit the "DE" in front of your call sign. It is no more needed in RTTY than it is in CW. (The inclusion of "DE" stems from earlier decoding software that used the "DE" to determine that the following characters were a call sign. Now, Super Check Partial databases more accurately identify call signs.)
- Send exchange element once unless the element is unique such as a serial number. Send unique elements twice. (Traditional RTTY practice was to send serial numbers three or more times with the rationale that if two or more of the instances were the same, then that would be considered the transmitted information. But, copy is good enough today that sending it only twice is sufficient for the receiver. If the two instances are different, then a repeat can be requested, but this happens rarely.)
- Do NOT put hyphens between exchange elements. Use spaces just like CW. The probability of accurate printing is slightly better with spaces, across all permutations of whether the sender or receiver, or both, are using UOS (Unshift On Space).
- Do NOT use cut numbers which actually take longer in RTTY because of the need to shift between the figures and letters character sets, requiring additional time to send control characters.
- Do NOT add the other station's call sign at the end of your exchange message. Depending on the situation, you can always tap your call sign message to chain it to the end of your exchange, but only do this if you feel there is a possibility that your sending of his call sign at the beginning of your exchange message was QRM'd.
- Your TU/QRZ message does not need his call sign at the beginning because you've already sent his call sign in your exchange. It is a waste of time. End the message with CQ rather than QRZ ... it is shorter and simply conveys that you are ready for another QSO. It is irrelevant whether you just ended a prior QSO or are free-CQing.
- Have a message for each of your exchange elements that may need repeating for a fill request. This avoids sending superfluous information.
- Have a message for requesting a fill on each important exchange element.
- If available for your radio, put a #CLEARIT Lua script call at the end of CQ and TU/QRZ messages. Check N6TV's Lua scripts at <http://bit.ly/wtscripts>.
- In RUN mode, put another **CQ** at the end of your **F1** message so that somebody tuning in while you transmit knows what is going on, and can come back immediately. Same in the **PLUS** message which ends a QSO.

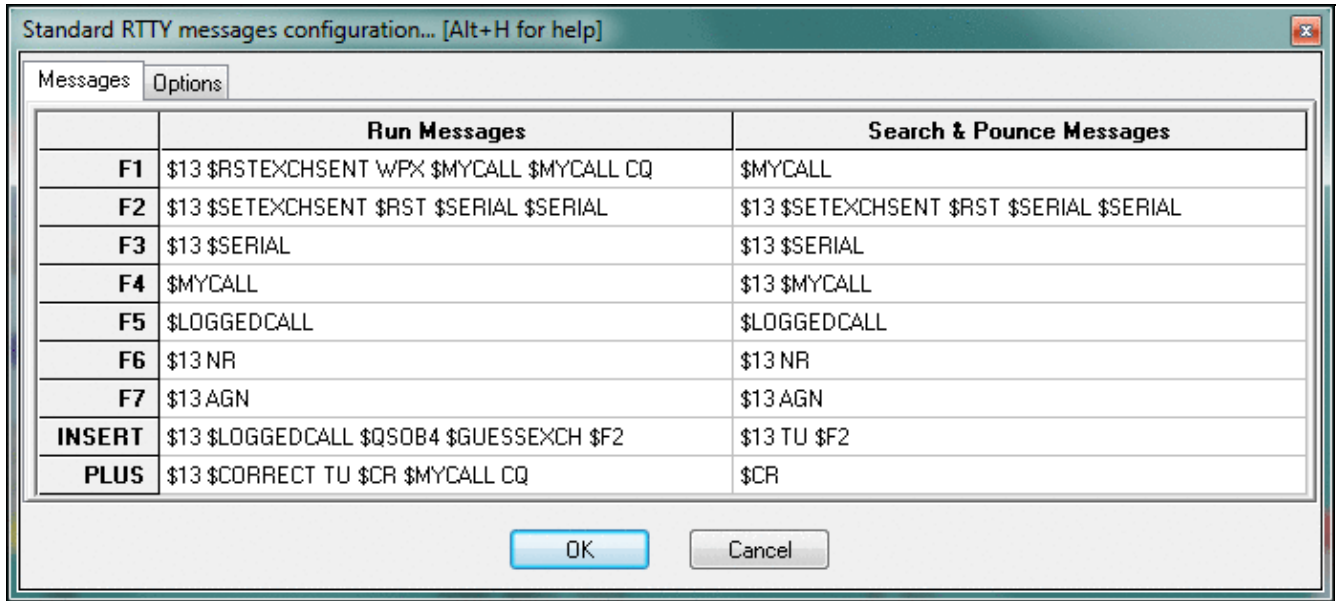

Typical RTTY messages for RUN and S/P mode used by W0YK.

You can find some useful information about RTTY Contesting on <http://www.rttycontesting.com>. Most tutorials are for Writelog, but a lot of the information is about MMTTY or RTTY Contesting in general. The RTTY information is quite helpful for beginners.

## Configuring the Win-Test DVK messages

Using the built-in soundcard digital voice keyer (DVK) in Win-Test is of course much easier than CW messages because you have no variables to worry about! Of course, you must ensure the box labelled 'Enable sound card' is ticked in the `Options|Configure` interfaces dialog box.

Before you start, it is recommended you have your soundcard audio levels already correctly set. There is an SSB bar meter included in Win-Test which you can open using `Windows | SSB bargraph`.



SSB bargraph window

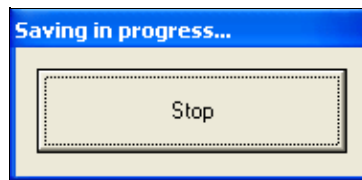

STOP recording

The audio should be in the yellow area for optimal performance.

Like with CW/RTTY messages, use **Shift+F<sub>x</sub>** to edit (actually record) the messages. Please note that, as soon as you press **Shift+F<sub>x</sub>**, Win-Test will start recording - so be prepared!

Upon clicking **Shift+F<sub>x</sub>**, a window will appear with a button labelled 'Stop' (see picture). You can simply hit ENTER/RETURN or SPACEBAR to stop recording (no need to locate the mouse and physically click the button).

For each **Shift+F<sub>x</sub>** key a corresponding `msgx.wav` file will be created/updated in the main Win-Test directory.

For **Shift+F1** a corresponding **msg1.wav** file will be created, and so forth for **Shift+F2** with a **msg2.wav**, up to **Shift+F7** with a corresponding **msg7.wav** file.

A useful feature of the Win-Test DVK is that you can vary speed by using **Alt+F9** and **Alt+F10** like on CW. Interestingly, this will not change audio characteristics, so your voice will still sound natural.

### Text commands related to the DVK functionality

There are some text commands which can be entered to change the functionality of the voice keyer within Win-Test. Please note that these *must* be entered in the callsign entry field - there is no corresponding menu option.

- MIC - enables the mic input when the voice keyer is NOT playing
- NOMIC - mutes the mic input when the voice keyer is NOT playing (*default*)
- MICWHENPLAY - enables the mic input when the voice keyer is playing
- NOMICWHENPLAY - mutes the mic input when the voice keyer is playing (*default*)

### Recording your messages in a separate application

Please note that if you decide to record your messages in a separate program to Win-Test, it is **very** important you get the codec settings correct. Please ensure you use the ADPCM codec (standard WAV), with an 8000Hz sampling frequency (mono), and 16-bits per sample.

### Using the microHAM DVK

Alternatively, if you own a microKeyer II or microKeyer III you might want to use the built-in DVK device to store audio snippets. The advantage is that you do not need to install additional audio cables, thus avoiding another source of RF feedback.

First you will have to configure the microKeyer control port in Win-Test.

- Assign an unused COM port in the microHAM router to the line named "Control".
- In the microHAM router in the Audio Switching tab, make sure you are using VOICE settings (automatic by frequency or manually by selecting VOICE)

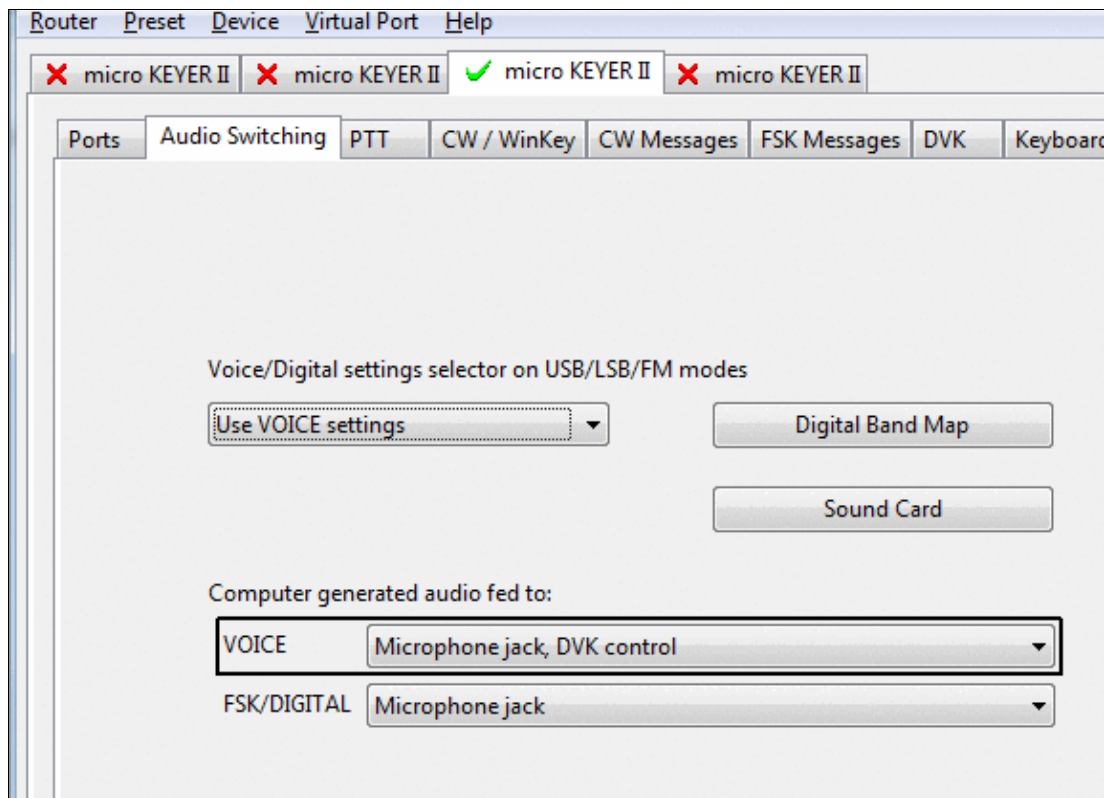

make sure, you are using correct settings for voice modes

- In Win-Test enter **SETUP** and configure the COM port assigned to microHAM control to **MK/MKII/MKIII**.
- In the same menu, make sure under **Voice Keyer** the option **Enable sound card** is untagged.
- In Win-Test go to **Options | MK/MKII/MKIII/MK2R/u2R configuration...** and tag the option **Enable the DVK integrated in the microHAM Device**

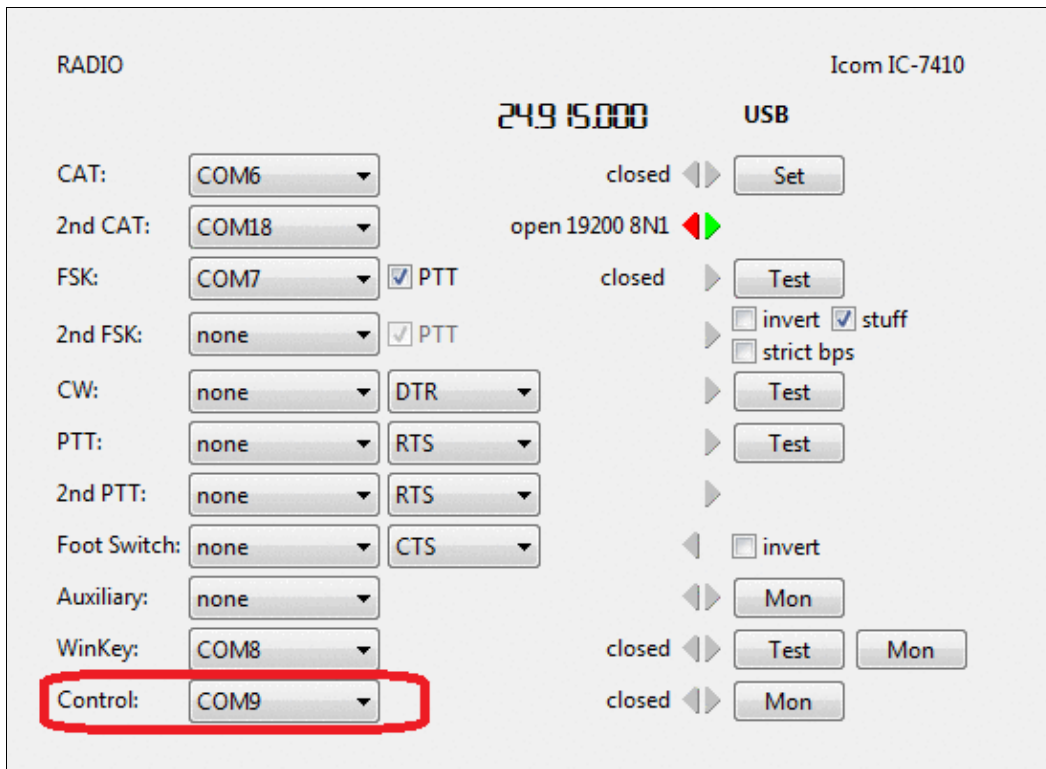

microHAM router setup to enable DVK

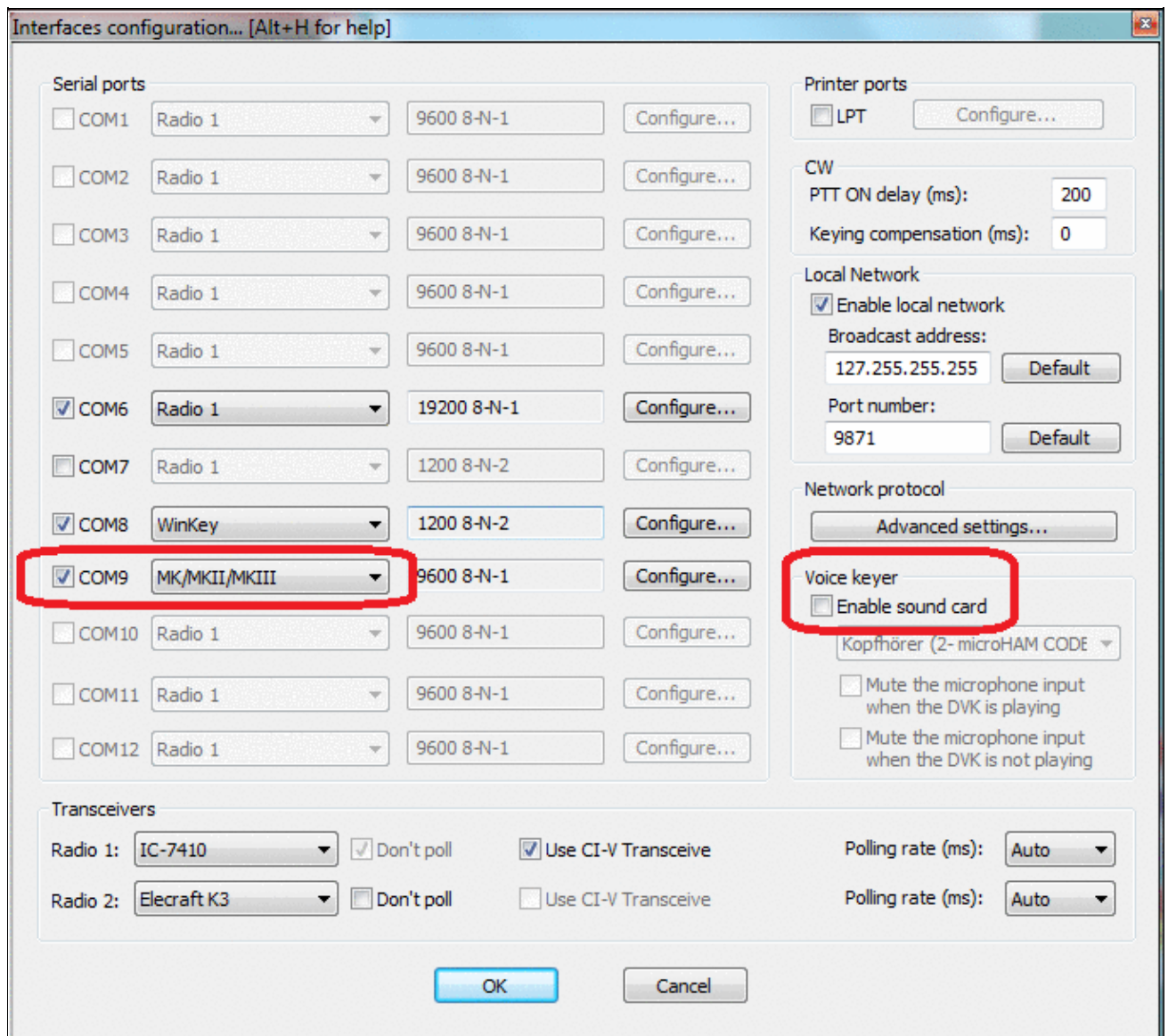

DVK setup in Win-Test

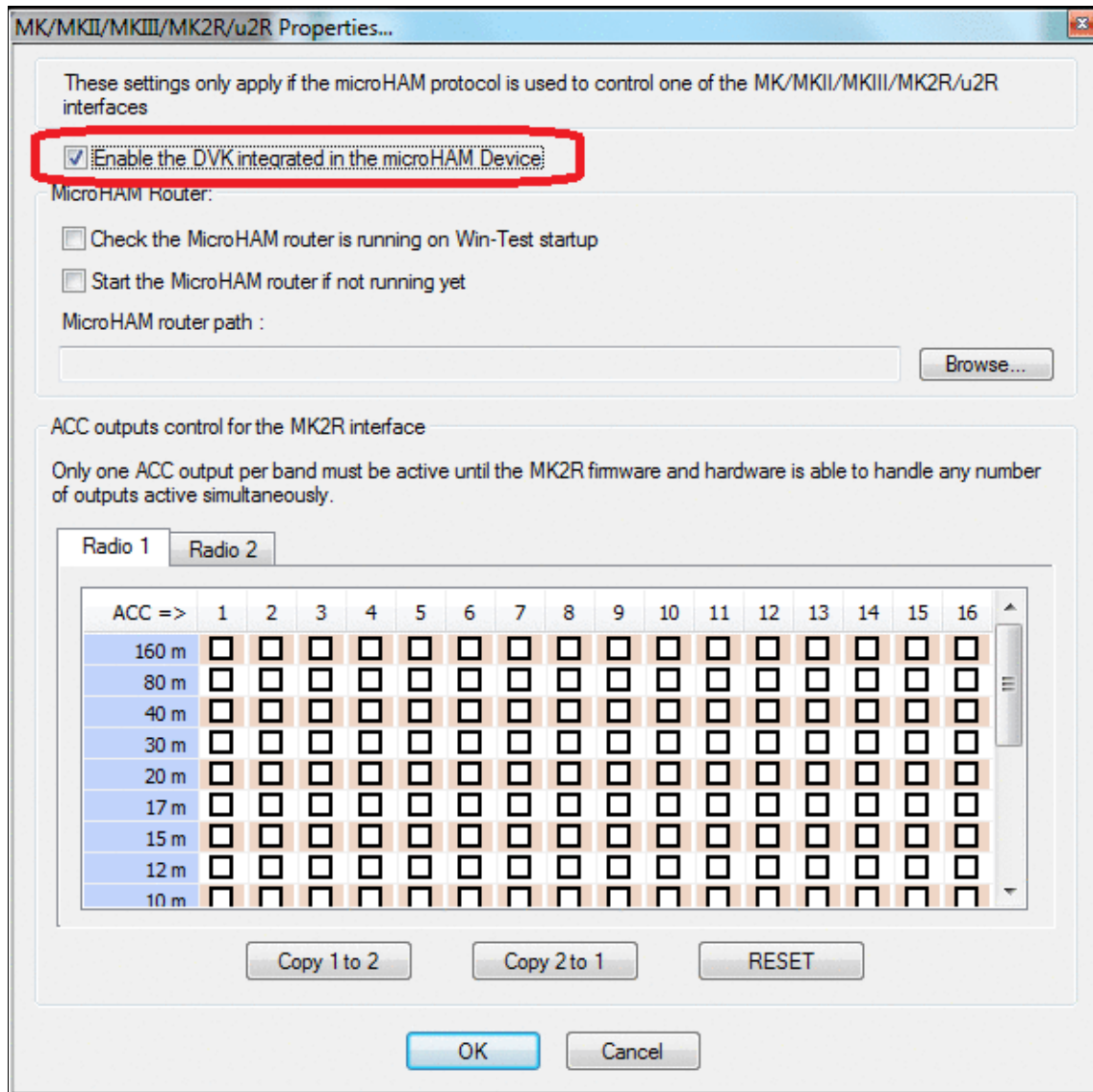

Enable microHAM DVK setup in Win-Test configuration

Now you will be able to comfortably record and play voice messages from the microHAM device. Your microphone of course, needs to be connected to the microHAM device, either via the RJ45 connector on the back or via the 3.5mm phone jack on the front of the device so that the audio goes through the device.

Press **F1** to play voice memory 1, **Shift+F1** to record to memory 1. Four memories can be controlled from your keyboard using **F1** to **F4**. Memory 2 is also bound to the **Insert** key, memory 3 is bound to the **Plus** key and **Esc** is bound to message abort.

What's more, in a multi-op environment, when you switch operators using **OPON**, different voice banks will be selected so that the recording of one operator will not overwrite the recordings of another. Since these messages are stored in the microHAM device, you can even re-use them in the next contest.

## See Also

- Description of various [Interfaces](#) elsewhere in this manual

## Namespaces

- [Page](#)
- [Discussion](#)

## Variants

## Views

- [Read](#)
- [View source](#)
- [View history](#)

## More

- This page was last edited on 10 April 2023, at 06:51.
- [Privacy policy](#)
- [About Win-Test Wiki](#)
- [Disclaimers](#)





# DVK CW RTTY Messaging

From Win-Test Wiki

[Jump to navigation](#) [Jump to search](#)

Configuring CW, RTTY and Digital Voice Keyer (henceforth DVK) messages in Win-Test can be done at any time 'on the fly'. This document shows you how. We will first cover how to configure CW messages and RTTY macros. For SSB, please look below under DVK.

## Contents

- [1 Configuring CW/RTTY messages](#)
  - ◆ [1.1 Additional CW/RTTY messages](#)
  - ◆ [1.2 Variables for use with CW/RTTY messages](#)
  - ◆ [1.3 Saving/Loading from \\*.msg file](#)
  - ◆ [1.4 Advanced SO2R specifics](#)
    - ◇ [1.4.1 SO2R specific variables](#)
  - ◆ [1.5 RTTY Message Tips](#)
- [2 Configuring the Win-Test DVK messages](#)
  - ◆ [2.1 Text commands related to the DVK functionality](#)
  - ◆ [2.2 Recording your messages in a separate application](#)
- [3 Using the microHAM DVK](#)
- [4 See Also](#)

## Configuring CW/RTTY messages

Editing CW and RTTY messages is a simple case of pressing **Shift+F $x$**  where  $x$  is a number in the range 1 .. 7. **F8** and above are reserved as shortcuts for opening/closing various windows within Win-Test. Other keys you can edit are **INSERT** and the plus (+) key (the former of which sends the callsign entered in the callsign entry field + the content of the F2 key, and the plus key sends a TU message and logs the QSO by default).

With a log open, press and hold **Shift+F1**. This will let you edit the message that is assigned to the **F1** key.



Editing CW/RTTY message for F1 key

By default, this is a CQ message. You'll notice some special variables, prefixed by a dollar symbol - for example, \$MYCALL, which is simply replaced by your callsign (as you entered in the [contest configuration](#) dialog box) when the message is sent. You can also speed up certain text by placing plus and minus symbols around the text which you want speeded up - *but you must ensure you have the same number of plus symbols (before the text) as minus symbols (after the text) otherwise you may discover some discrepancies in speed.*

Since the ++ and -- accelerators have sense in CW only, they must not be used in RTTY messages, so they have to be removed.

Now press **Shift+INSERT**. You will notice that all this is doing is sending \$LOGGEDCALL, which, as the name suggests, is replaced by the callsign you have currently entered in the callsign entry field, and the \$F2

variable is replaced by the content of the F2 key (thus you will have to use **Shift+F2** to edit the content for that key).

## Additional CW/RTTY messages

We understand that sometimes, **F1 .. F7** is just not adequate during a contest. So, Win-Test has catered for your needs. You can use additional CW/RTTY messages. To edit these CW/RTTY messages, use **ALT+C** to open the window. Enter the text you wish to have assigned to each key, and then you can simply click the **Transmit** button to send the messages

**Tip:** You can also press **ALT+C** to open the additional CW messages window and then just hit the corresponding F-key for the messages you wish to send.

Since the release 3.8.6 the Message Variables (see below) will work also within these additional CW/RTTY messages.

Please also note that the additional CW/RTTY messages dialog can also be reached by clicking on the `Options | CW | Modify additional messages...` or `Options | RTTY | Modify additional messages...` menu.

## Variables for use with CW/RTTY messages

OK, so now you understand *how* to edit the messages, but you want to know what all the various variables are/mean, right? Worry no more:

- `$SERIAL` - sends the current QSO (serial) number
- `$LOGGEDCALL` - sends the callsign you currently have entered in the callsign entry field
- `$ZONE` - sends your zone (as entered in the [contest configuration](#) screen)
- `$ZONE2` - sends your state or province (the second box after zone as entered in the [contest configuration](#) screen for the CQ WW RTTY contest for U.S. and Canadian entrants)
- `$INSERT` and `$PLUS` - sends the messages contained within the INSERT and PLUS keys respectively
- `$MSG1 ... $MSG12` - sends content of additional CW messages (see above)
- `$SPACEBAR` - works just like hitting the SPACEBAR - can be useful within the INSERT key 'message' to move exchange fields
- `$GUESSEXCH` - attempts to guess the exchange but does not move the entry field (see also [Database Files Installing a Database file](#))
- `$CR` - works just like pressing RETURN/ENTER - useful for inclusion in the PLUS key 'message' (to enter the QSO in to the log)
- `$MYCALL` - replaced with your callsign
- `$CORRECT` - useful for inclusion within the PLUS key message to send the correct call if you made a change to the other station's callsign since hitting INSERT
- `$F1 ... $F6` - sends the message corresponding to the F1 ... F6 key
- `+` and `-` - each plus symbol speeds up the text contained with these characters by 2 wpm, and minus slows down the text by 2 wpm. Please ensure you have an equal number of pluses and minuses around the text in question otherwise you may notice speed irregularity.
- Only in RTTY: `$13` sends a carriage return character, all message after this code will start on a new line in the terminal of the station receiving it.

## Saving/Loading from \*.msg file

Two buttons on the left lower corner of the window allow you to save/load your preferred settings from a \*.msg file. This way you can export/import your personal favourite setup. The files are stored to/read from the current op's directory, which is typically %ALLUSERSPOFILE%\win-Test\ops. Example messages file for a RTTY contest.

```
#
# Standard Messages File generated by Win-Test
#
[ RUN ]
F1 CQ TEST $MYCALL $MYCALL CQ
F2 $SETEXCHSENT $RST-$SERIAL-$SERIAL
F3 $SERIAL
F4 $MYCALL
F5 $LOGGEDCALL
F6 NR?
F7 ?
INSERT $LOGGEDCALL $QSOB4 $F2 $LOGGEDCALL
PLUS $LOGGEDCALL TU $CR $MYCALL CQ
#
[ S&P ]
F1 $MYCALL $MYCALL
F2 $RST-$SERIAL-$SERIAL
F3 $SERIAL
F4 $MYCALL
F5 $LOGGEDCALL
F6 NR?
F7 ?
INSERT $F1
PLUS $LOGGEDCALL QSL $F2 $MYCALL $CR
#
[ MISC ]
QSOB4 QSOB4
```

## Advanced SO2R specifics

Please note, for some SO2R configurations, you have to use **AltGr+Fx** to edit the messages. This is because of the 'shift binds second radio' functionality whereby the [**SHIFT**] key is bound to the second radio window (e.g. to enter a callsign on the second rig).

### SO2R specific variables

There are also some SO2R specific variables which can be used:

- \$R1R1, \$R1R2, \$R2R1, \$R2R2 - for headphone switching. For example, at the end of the F2 message, you could have \$R1R2 which would set the headphones so that the left ear is on radio 1 and the right ear is on radio 2, etc.
- \$TR1, \$TR2 - set the TX to radio 1 or radio 2
- \$RESET - reset any audio/headphone settings
- \$ALTERNATECQ (or \$ACQ) - swap primary and secondary radios and send CQ on the secondary radio
- \$CQ - same as \$ALTERNATECQ but does not swap radios

Please see the section regarding SO2R contesting for more information.

## RTTY Message Tips

Here are some tips from W0YK for RTTY contesting.

RTTY contesting is evolving to be competitively similar to CW contesting. RTTY contests are no longer rallies for RTTY specialists to contact each other and work new countries. Just like the evolution of CW and SSB contesting, RTTY contesting is comprised of a growing number of serious contesters trying to be as efficient as possible with their transmissions. As such, RTTY contest messages should basically be similar to CW contest messages. Accordingly, here are some tips and recommendations for RTTY contest messages:

- Start most messages with a carriage return (\$13) so that the message will stand out from noise and other information on the recipient's screen. Exceptions are your call sign message and his call sign message, where you may want to repeat them or chain with other messages.
- End all messages with a space character to separate it from noise and other information.
- Modularize messages so they can be repeated or combined to best fit the situation at the time. For example, have a message that contains your call sign only once. Depending on conditions, you may tap that function key twice or perhaps three times, with an appropriate amount of delay (space) between taps.
- Omit the "DE" in front of your call sign. It is no more needed in RTTY than it is in CW. (The inclusion of "DE" stems from earlier decoding software that used the "DE" to determine that the following characters were a call sign. Now, Super Check Partial databases more accurately identify call signs.)
- Send exchange element once unless the element is unique such as a serial number. Send unique elements twice. (Traditional RTTY practice was to send serial numbers three or more times with the rationale that if two or more of the instances were the same, then that would be considered the transmitted information. But, copy is good enough today that sending it only twice is sufficient for the receiver. If the two instances are different, then a repeat can be requested, but this happens rarely.)
- Do NOT put hyphens between exchange elements. Use spaces just like CW. The probability of accurate printing is slightly better with spaces, across all permutations of whether the sender or receiver, or both, are using UOS (Unshift On Space).
- Do NOT use cut numbers which actually take longer in RTTY because of the need to shift between the figures and letters character sets, requiring additional time to send control characters.
- Do NOT add the other station's call sign at the end of your exchange message. Depending on the situation, you can always tap your call sign message to chain it to the end of your exchange, but only do this if you feel there is a possibility that your sending of his call sign at the beginning of your exchange message was QRM'd.
- Your TU/QRZ message does not need his call sign at the beginning because you've already sent his call sign in your exchange. It is a waste of time. End the message with CQ rather than QRZ ... it is shorter and simply conveys that you are ready for another QSO. It is irrelevant whether you just ended a prior QSO or are free-CQing.
- Have a message for each of your exchange elements that may need repeating for a fill request. This avoids sending superfluous information.
- Have a message for requesting a fill on each important exchange element.
- If available for your radio, put a #CLEARIT Lua script call at the end of CQ and TU/QRZ messages. Check N6TV's Lua scripts at <http://bit.ly/wtscripts>.
- In RUN mode, put another **CQ** at the end of your **F1** message so that somebody tuning in while you transmit knows what is going on, and can come back immediately. Same in the **PLUS** message which ends a QSO.

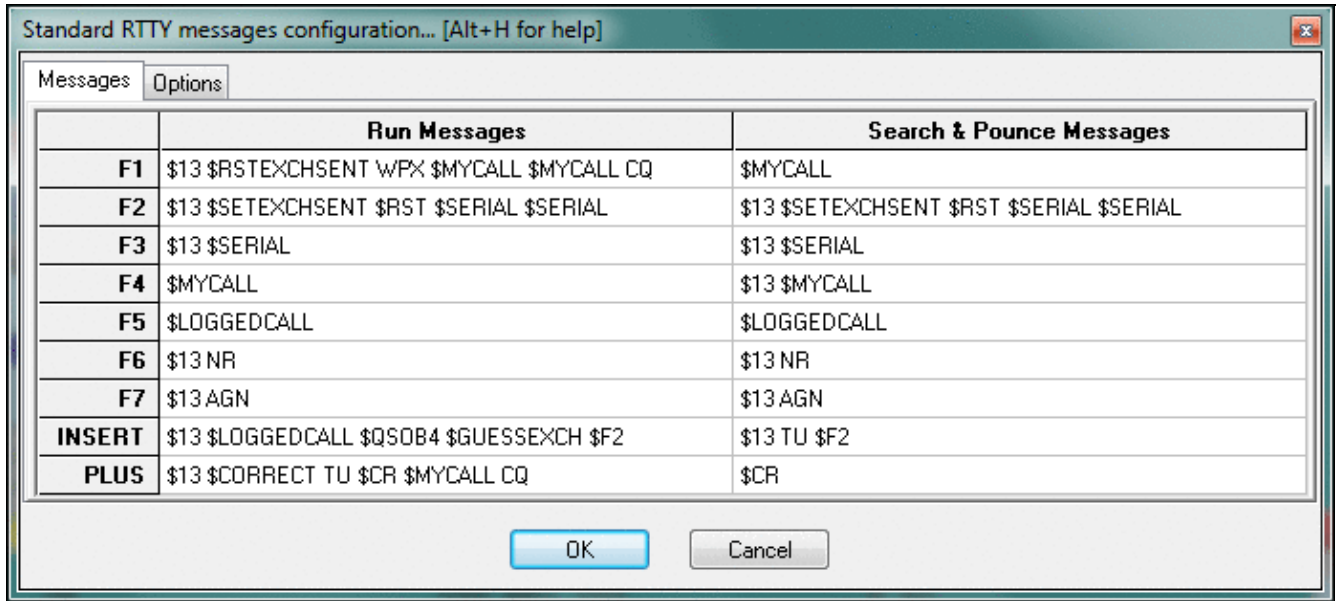

Typical RTTY messages for RUN and S/P mode used by W0YK.

You can find some useful information about RTTY Contesting on <http://www.rttycontesting.com>. Most tutorials are for Writelog, but a lot of the information is about MMTTY or RTTY Contesting in general. The RTTY information is quite helpful for beginners.

## Configuring the Win-Test DVK messages

Using the built-in soundcard digital voice keyer (DVK) in Win-Test is of course much easier than CW messages because you have no variables to worry about! Of course, you must ensure the box labelled 'Enable sound card' is ticked in the `Options|Configure` interfaces dialog box.

Before you start, it is recommended you have your soundcard audio levels already correctly set. There is an SSB bar meter included in Win-Test which you can open using `Windows | SSB bargraph`.



SSB bargraph window

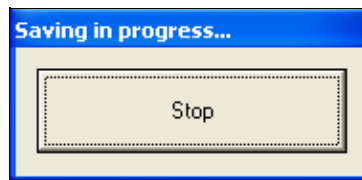

STOP recording

The audio should be in the yellow area for optimal performance.

Like with CW/RTTY messages, use **Shift+F<sub>x</sub>** to edit (actually record) the messages. Please note that, as soon as you press **Shift+F<sub>x</sub>**, Win-Test will start recording - so be prepared!

Upon clicking **Shift+F<sub>x</sub>**, a window will appear with a button labelled 'Stop' (see picture). You can simply hit ENTER/RETURN or SPACEBAR to stop recording (no need to locate the mouse and physically click the button).

For each **Shift+F<sub>x</sub>** key a corresponding `msgx.wav` file will be created/updated in the main Win-Test directory.

For **Shift+F1** a corresponding **msg1.wav** file will be created, and so forth for **Shift+F2** with a **msg2.wav**, up to **Shift+F7** with a corresponding **msg7.wav** file.

A useful feature of the Win-Test DVK is that you can vary speed by using **Alt+F9** and **Alt+F10** like on CW. Interestingly, this will not change audio characteristics, so your voice will still sound natural.

### Text commands related to the DVK functionality

There are some text commands which can be entered to change the functionality of the voice keyer within Win-Test. Please note that these *must* be entered in the callsign entry field - there is no corresponding menu option.

- MIC - enables the mic input when the voice keyer is NOT playing
- NOMIC - mutes the mic input when the voice keyer is NOT playing (*default*)
- MICWHENPLAY - enables the mic input when the voice keyer is playing
- NOMICWHENPLAY - mutes the mic input when the voice keyer is playing (*default*)

### Recording your messages in a separate application

Please note that if you decide to record your messages in a separate program to Win-Test, it is **very** important you get the codec settings correct. Please ensure you use the ADPCM codec (standard WAV), with an 8000Hz sampling frequency (mono), and 16-bits per sample.

### Using the microHAM DVK

Alternatively, if you own a microKeyer II or microKeyer III you might want to use the built-in DVK device to store audio snippets. The advantage is that you do not need to install additional audio cables, thus avoiding another source of RF feedback.

First you will have to configure the microKeyer control port in Win-Test.

- Assign an unused COM port in the microHAM router to the line named "Control".
- In the microHAM router in the Audio Switching tab, make sure you are using VOICE settings (automatic by frequency or manually by selecting VOICE)

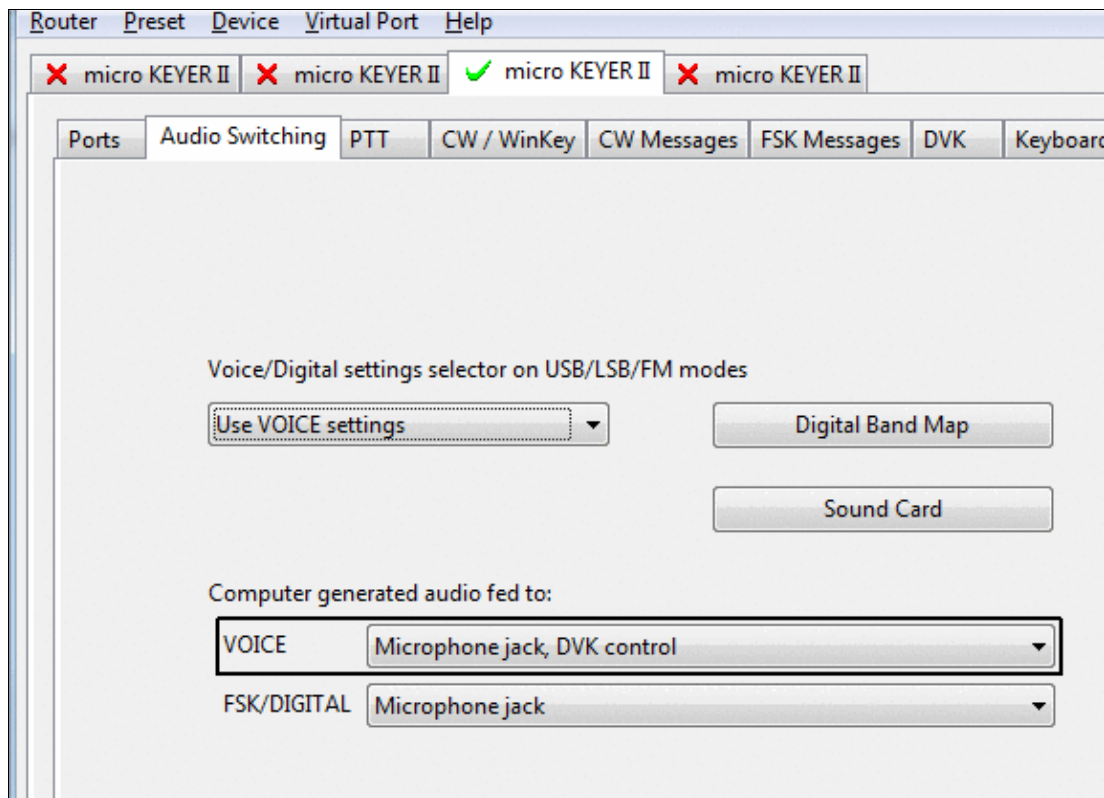

make sure, you are using correct settings for voice modes

- In Win-Test enter **SETUP** and configure the COM port assigned to microHAM control to **MK/MKII/MKIII**.
- In the same menu, make sure under **Voice Keyer** the option **Enable sound card** is untagged.
- In Win-Test go to **Options | MK/MKII/MKIII/MK2R/u2R configuration...** and tag the option **Enable the DVK integrated in the microHAM Device**

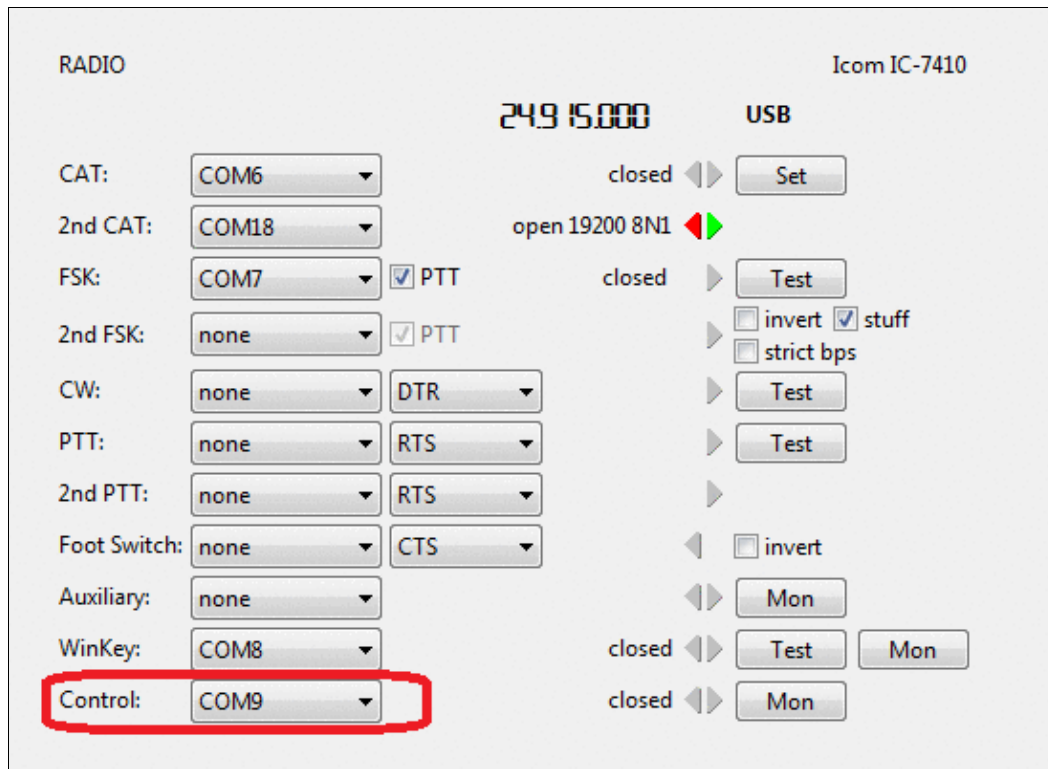

microHAM router setup to enable DVK



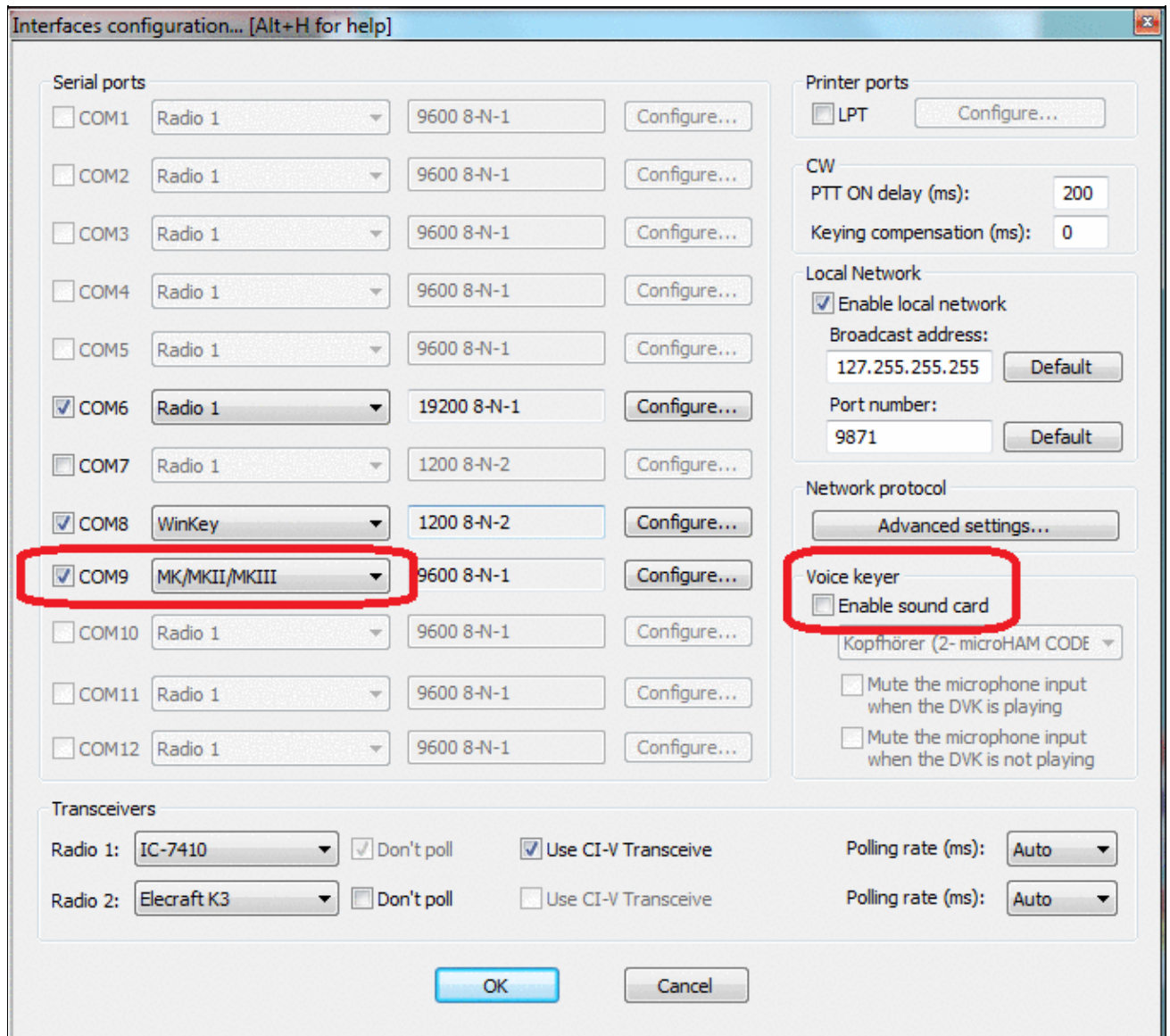

DVK setup in Win-Test

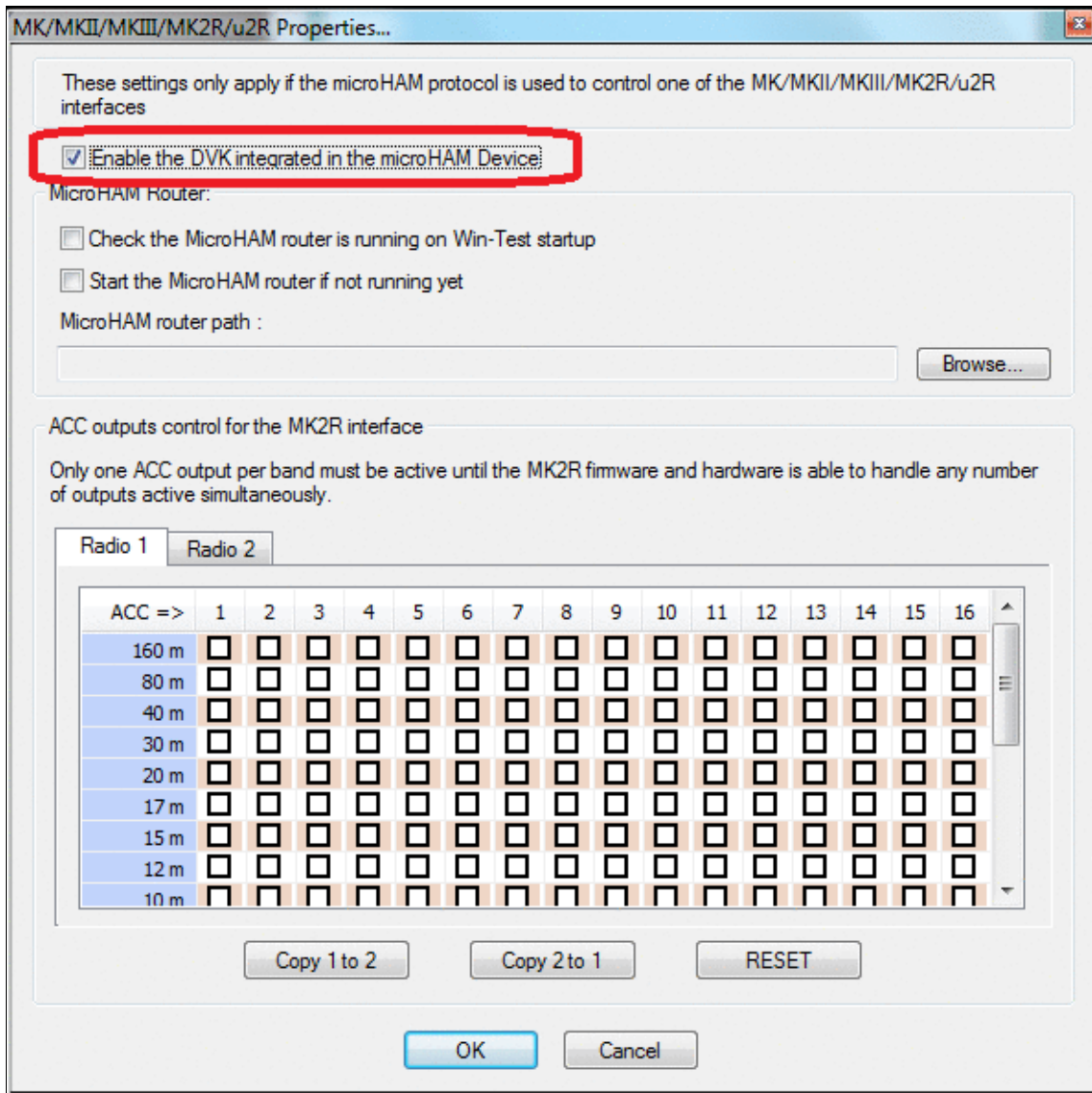

Enable microHAM DVK setup in Win-Test configuration

Now you will be able to comfortably record and play voice messages from the microHAM device. Your microphone of course, needs to be connected to the microHAM device, either via the RJ45 connector on the back or via the 3.5mm phone jack on the front of the device so that the audio goes through the device.

Press **F1** to play voice memory 1, **Shift+F1** to record to memory 1. Four memories can be controlled from your keyboard using **F1** to **F4**. Memory 2 is also bound to the **Insert** key, memory 3 is bound to the **Plus** key and **Esc** is bound to message abort.

What's more, in a multi-op environment, when you switch operators using **OPON**, different voice banks will be selected so that the recording of one operator will not overwrite the recordings of another. Since these messages are stored in the microHAM device, you can even re-use them in the next contest.

## See Also

- Description of various [Interfaces](#) elsewhere in this manual

## Namespaces

- [Page](#)
- [Discussion](#)

## Variants

## Views

- [Read](#)
- [View source](#)
- [View history](#)

## More

- This page was last edited on 10 April 2023, at 06:51.
- [Privacy policy](#)
- [About Win-Test Wiki](#)
- [Disclaimers](#)



# DX Cluster

From Win-Test Wiki

[Jump to navigation](#) [Jump to search](#)

Win-Test supports connection to the DX cluster either in the more modern approach of connecting via the Internet (and subsequently telnet) or by using a TNC (and subsequently packet radio/AX.25).

Win-Test treats both methods quite differently and thus instructions have been separated into two:

- [Connecting via telnet](#)
- [Connecting via packet radio/TNC](#)

## Namespaces

- [Page](#)
- [Discussion](#)

## Variants

## Views

- [Read](#)
- [View source](#)
- [View history](#)

## More

- This page was last edited on 13 August 2011, at 07:33.

- [Privacy policy](#)
- [About Win-Test Wiki](#)
- [Disclaimers](#)

- The logo consists of a small sun icon to the left of the text "Powered By MediaWiki".

# DX Cluster

From Win-Test Wiki

[Jump to navigation](#) [Jump to search](#)

Win-Test supports connection to the DX cluster either in the more modern approach of connecting via the Internet (and subsequently telnet) or by using a TNC (and subsequently packet radio/AX.25).

Win-Test treats both methods quite differently and thus instructions have been separated into two:

- [Connecting via telnet](#)
- [Connecting via packet radio/TNC](#)

## Namespaces

- [Page](#)
- [Discussion](#)

## Variants

## Views

- [Read](#)
- [View source](#)
- [View history](#)

## More

- This page was last edited on 13 August 2011, at 07:33.

- [Privacy policy](#)
- [About Win-Test Wiki](#)
- [Disclaimers](#)

- The logo consists of a small sun icon to the left of the text "Powered By MediaWiki".

# DXpedition

From Win-Test Wiki

[Jump to navigation](#) [Jump to search](#)

## Using Win-Test on a DXpedition

In DXpedition mode, Win-Test allows you to add some information - like operator's name, QTH - to the QSO in an info field that can optionally be enabled through the [DXpedition Options menu](#).

You may find the following information helpful for a DXpedition. It was contributed by several DXpeditioners.

Some useful hints:

- In the Contest Configuration dialog, click the **[Days ...]** button next to the **Contest** drop-down list to set the DXpedition duration (maximum 14 days). The default duration is 4 days. This value controls the width of the graphs in the [Statistics window](#).
- To see - at a glance- on which bands and modes you have worked a specific station, use the Check Multipliers window (available by **[F10]**) with the automatic update enabled.
- Synchronizing logs:
  - ◆ Synchronizing should be turned on to make sure nothing is lost, even in case of RFI or a hardware failure. However, note that changes to existing QSOs will not propagate to computers that are not on the network while the change occurs. This is a known limitation.
  - ◆ To create a complete log, merge the different WTB files on an offline computer. The \*.merge file will contain merge conflicts which you will have to sort out one by one (cannot be done by software).
- You plan to join a contest during the DXpedition? You have two choices:
  - ◆ If you are not interested in taking part: stay in DXpedition mode and just log the contacts either skipping the contest information or add it to the info field
  - ◆ If you plan to turn in a competitive log: split the Win-Test network in two (Win-Test does not allow different contest settings in a single network so you have to separate the stations doing contest from the rest of the DXpedition setup), create a new log for the contest and you are ready to go. Merge the contest log with the other logs later.
- It may be especially helpful on a DXpedition to remember that you can actually double click call signs displayed in the Check Partial or N+1 Windows which will fill-in the call sign field. This comes in handy, when you have copied only parts of a call sign and finally spot the complete call in one of these two windows.
- Markers for beacons and band segments can be very handy on a DXpedition. See [Extra Information](#) in the Windows Menu for more information.
- There is no "zones worked" display in DXpedition mode.
- Duplicate contacts are normally not included in the figures of the Summary window (net total). However, there is a context menu option that will allow you to change this to display gross totals.
- Some keys like the **[INS]** and the **[F3]** keys have slightly different predefined CW messages.

## Namespaces

- [Page](#)
- [Discussion](#)

## Variants

## Views

- [Read](#)
- [View source](#)
- [View history](#)

## More

- This page was last edited on 31 July 2014, at 17:26.

- [Privacy policy](#)
- [About Win-Test Wiki](#)
- [Disclaimers](#)



# DXpedition

From Win-Test Wiki

[Jump to navigation](#) [Jump to search](#)

## Using Win-Test on a DXpedition

In DXpedition mode, Win-Test allows you to add some information - like operator's name, QTH - to the QSO in an info field that can optionally be enabled through the [DXpedition Options menu](#).

You may find the following information helpful for a DXpedition. It was contributed by several DXpeditioners.

Some useful hints:

- In the Contest Configuration dialog, click the **[Days ...]** button next to the **Contest** drop-down list to set the DXpedition duration (maximum 14 days). The default duration is 4 days. This value controls the width of the graphs in the [Statistics window](#).
- To see - at a glance- on which bands and modes you have worked a specific station, use the Check Multipliers window (available by **[F10]**) with the automatic update enabled.
- Synchronizing logs:
  - ◆ Synchronizing should be turned on to make sure nothing is lost, even in case of RFI or a hardware failure. However, note that changes to existing QSOs will not propagate to computers that are not on the network while the change occurs. This is a known limitation.
  - ◆ To create a complete log, merge the different WTB files on an offline computer. The \*.merge file will contain merge conflicts which you will have to sort out one by one (cannot be done by software).
- You plan to join a contest during the DXpedition? You have two choices:
  - ◆ If you are not interested in taking part: stay in DXpedition mode and just log the contacts either skipping the contest information or add it to the info field
  - ◆ If you plan to turn in a competitive log: split the Win-Test network in two (Win-Test does not allow different contest settings in a single network so you have to separate the stations doing contest from the rest of the DXpedition setup), create a new log for the contest and you are ready to go. Merge the contest log with the other logs later.
- It may be especially helpful on a DXpedition to remember that you can actually double click call signs displayed in the Check Partial or N+1 Windows which will fill-in the call sign field. This comes in handy, when you have copied only parts of a call sign and finally spot the complete call in one of these two windows.
- Markers for beacons and band segments can be very handy on a DXpedition. See [Extra Information](#) in the Windows Menu for more information.
- There is no "zones worked" display in DXpedition mode.
- Duplicate contacts are normally not included in the figures of the Summary window (net total). However, there is a context menu option that will allow you to change this to display gross totals.
- Some keys like the **[INS]** and the **[F3]** keys have slightly different predefined CW messages.

## Namespaces

- [Page](#)
- [Discussion](#)



## Variants

## Views

- [Read](#)
- [View source](#)
- [View history](#)

## More

- This page was last edited on 31 July 2014, at 17:26.

- [Privacy policy](#)
- [About Win-Test Wiki](#)
- [Disclaimers](#)



# Multi-op/Issues/Editing serials

From Win-Test Wiki

[Jump to navigation](#) [Jump to search](#)

If, by remote chance, you should experience a machine crash on the network during the contest, and other stations continue making QSOs, the log at your operating position will be out of sync. The danger, with such a scenario, is that you may mistakenly work what you *thought* was a mult but may actually have been worked by another station on the network during the crash. Another problem is that serial numbers might be out of sync at the various operating positions.

**RELAX: all this was possibly true before the LOG SYNCHRONIZATION era!!**

With Log Synchronization introduced in version 3.0.0 (see [Release Notes](#)), this should not happen anymore.

Log synchronization is turned on by default. The menu option [Disable log synchronization on network](#) will let the user turn off synchronization.

## Overcoming out-of-sync scenarios

As said before, this should not happen anymore, apart some smart Mr. Murphy unpredictable interventions.....

Just in that case, and for whatever other reason you may have to change the sequential serial numbering, the old option has been left in place and is still available.

## Editing serial numbers

Through the menu `Edit | Edit serial number...` a new window will open up, where the serial number can be changed. Use this option with care, however.

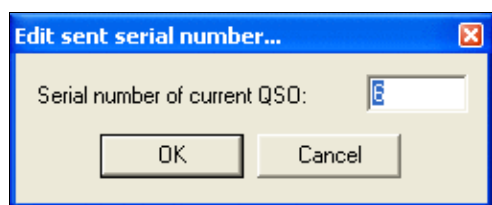

## Preventing crashes mid-contest

Win-Test is a very stable contest logging application and it was built with **stability** in mind because, let's face it, everybody **hates** logging program crashes midway through a contest.

As a result, a crash is *most likely* to be a result of a conflicting program on the operating system (of course there are exceptions, but very rare). It is *highly* recommended that you close all unnecessary programs.

Common programs left running (which, nonetheless, are still totally unnecessary) include instant messaging programs (e.g. Windows/MSN Messenger, ICQ, Skype etc), audio program 'agents' (e.g. Winamp agent, RealPlayer agent, ...) etc. Please close **everything** is not required for your contest operation.

## Namespaces

- [Page](#)
- [Discussion](#)

## Variants

## Views

- [Read](#)
- [View source](#)
- [View history](#)

## More

- This page was last edited on 31 March 2007, at 20:11.

- [Privacy policy](#)
- [About Win-Test Wiki](#)
- [Disclaimers](#)

- The logo for MediaWiki, featuring a sun icon and the text "Powered By MediaWiki".

# Extracting log Information

From Win-Test Wiki

[Jump to navigation](#) [Jump to search](#)

## Log Breakdown

Log breakdown information like summary (score, number of QSO's, points, zones, countries), QSO rate, worked zones, worked DXCC, can be extracted and copied to an external application like, Notepad, Excel spreadsheet etc.

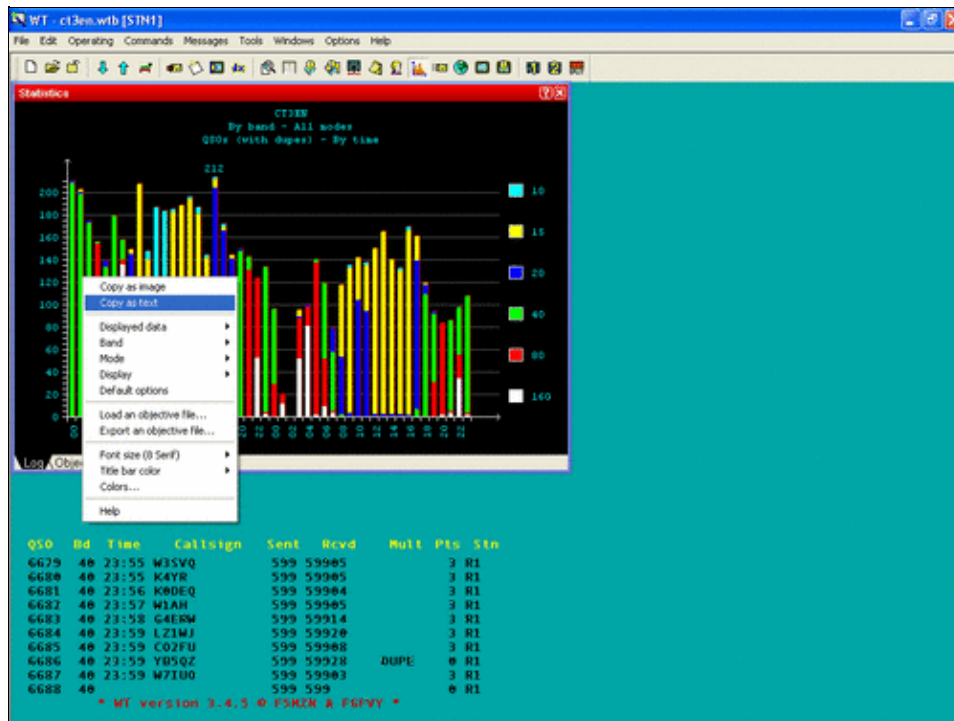

## Win-Test Wiki

To create a log breakdown, right click into the specific window

The procedure is always the same. Choose the Window with the required information: Statistics, Worked Zones, Worked DXCC or Summary. Right click on the window, select 'Copy as text' and paste the information to a text file or a spreadsheet.

Pay attention that if the information in the window has several display options, the output is created accordingly. For instance if the statistics window shows "Displayed data" (QSOs) and Band (ALL Total) then the output information will show just that:

- All bands - All modes
- QSOs (with dupes) - By time

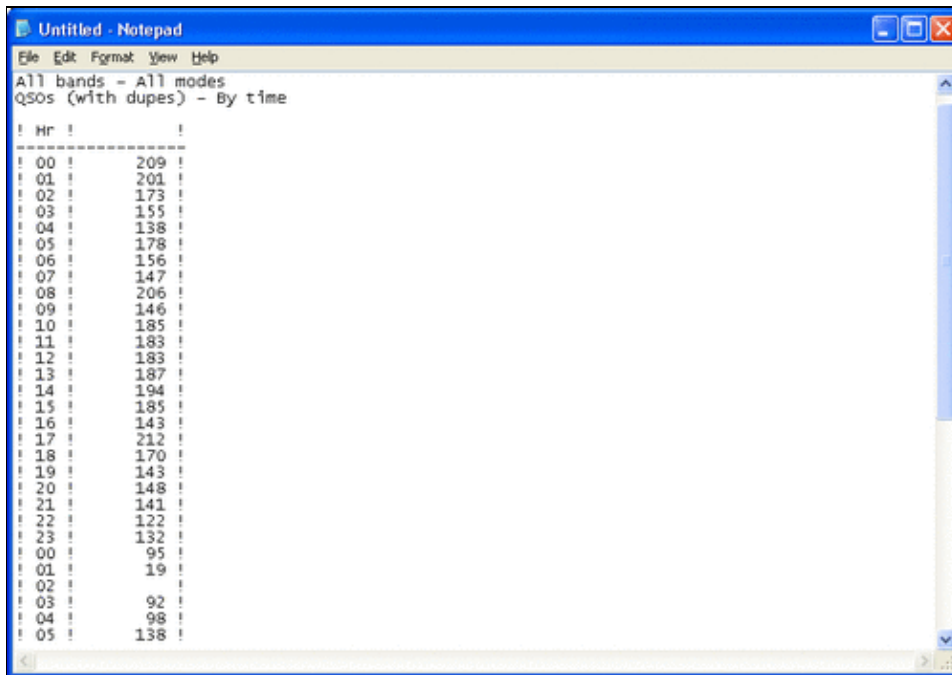

The screenshot shows a Notepad window titled "Untitled - Notepad" with a menu bar (File, Edit, Format, View, Help). The text content is as follows:

```
All bands - All modes
QSOs (with dupes) - By time

! Hr !
-----!
! 00 ! 209 !
! 01 ! 201 !
! 02 ! 173 !
! 03 ! 155 !
! 04 ! 138 !
! 05 ! 178 !
! 06 ! 156 !
! 07 ! 147 !
! 08 ! 206 !
! 09 ! 146 !
! 10 ! 185 !
! 11 ! 183 !
! 12 ! 183 !
! 13 ! 187 !
! 14 ! 194 !
! 15 ! 185 !
! 16 ! 143 !
! 17 ! 212 !
! 18 ! 170 !
! 19 ! 143 !
! 20 ! 148 !
! 21 ! 141 !
! 22 ! 122 !
! 23 ! 132 !
! 00 ! 95 !
! 01 ! 19 !
! 02 !
! 03 ! 92 !
! 04 ! 98 !
! 05 ! 138 !
```

Breakdown by hour

But if the statistics window shows "Displayed data" (QSOS) and Band (All detailed) then the output information is shown in a more detailed fashion:

Hr	160	80	40	20	15	10	Total
00			208	1			209
01			198	1	2		201
02			172	1			173
03		154	1				155
04		74	59	5			138
05		5	173				178
06	135	4	17				156
07		56	47	40	4		147
08				91	115		206
09			4		135	7	146
10				81	29	75	185
11					99	84	183
12				30	151	2	183
13				2	185		187
14				1	192	1	194
15				14	166	5	185
16				3	138	2	143
17				204	7	1	212
18			1	164	3	2	170
19			31	109	3		143
20			147	1			148
21		130	11				141
22	52	70					122
23	2	1	129				132
00		29	66				95
01	11	8					19
02							
03	51	35		1	5		92
04	80	17		1			98

Breakdown by hour and band

## Namespaces

- [Page](#)
- [Discussion](#)

## Variants

## Views

- [Read](#)
- [View source](#)
- [View history](#)

## More

- This page was last edited on 24 January 2007, at 08:54.

- [Privacy policy](#)
- [About Win-Test Wiki](#)
- [Disclaimers](#)



# Extracting log Information

From Win-Test Wiki

[Jump to navigation](#) [Jump to search](#)

## Log Breakdown

Log breakdown information like summary (score, number of QSO's, points, zones, countries), QSO rate, worked zones, worked DXCC, can be extracted and copied to an external application like, Notepad, Excel spreadsheet etc.

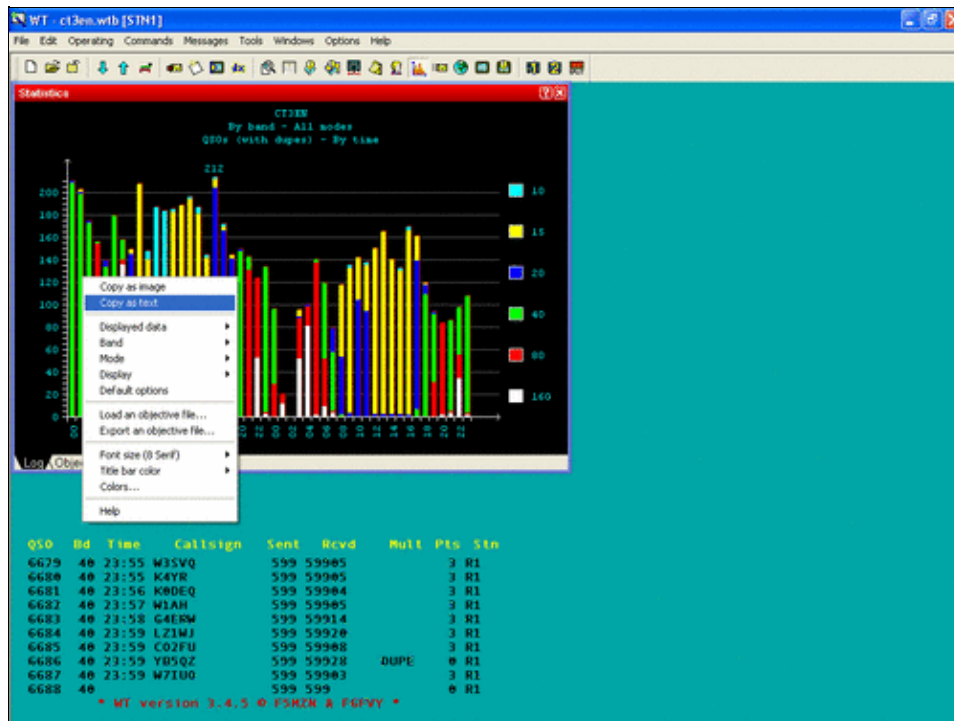

## Win-Test Wiki

To create a log breakdown, right click into the specific window

The procedure is always the same. Choose the Window with the required information: Statistics, Worked Zones, Worked DXCC or Summary. Right click on the window, select 'Copy as text' and paste the information to a text file or a spreadsheet.

Pay attention that if the information in the window has several display options, the output is created accordingly. For instance if the statistics window shows "Displayed data" (QSOs) and Band (ALL Total) then the output information will show just that:

- All bands - All modes
- QSOs (with dupes) - By time

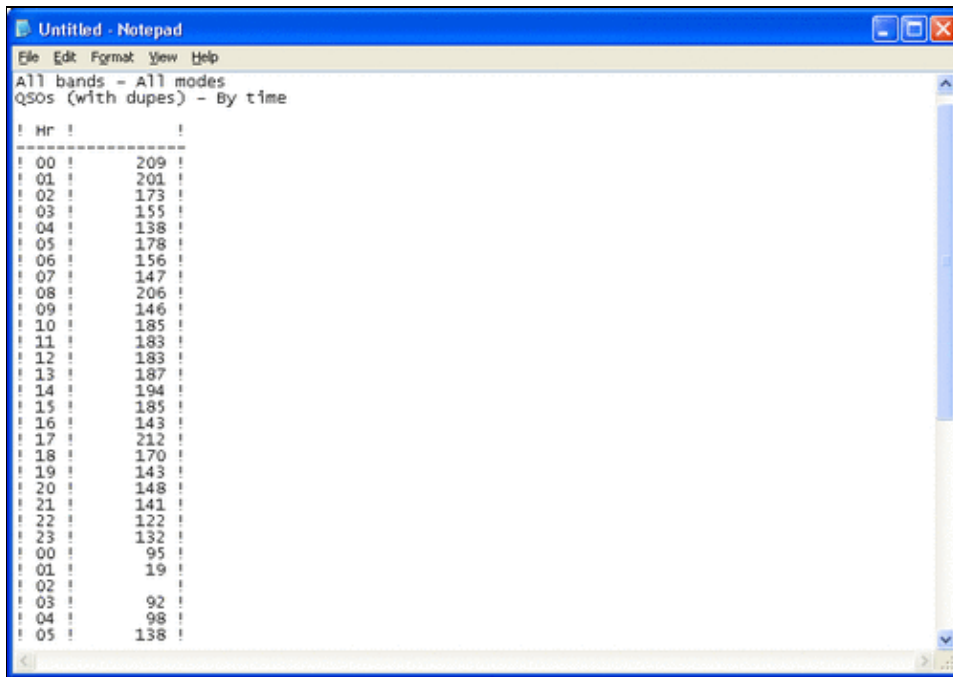

The screenshot shows a Notepad window titled "Untitled - Notepad" with a menu bar (File, Edit, Format, View, Help). The text content is as follows:

```
All bands - All modes
QSOs (with dupes) - By time

! Hr !
-----!
! 00 ! 209 !
! 01 ! 201 !
! 02 ! 173 !
! 03 ! 155 !
! 04 ! 138 !
! 05 ! 178 !
! 06 ! 156 !
! 07 ! 147 !
! 08 ! 206 !
! 09 ! 146 !
! 10 ! 185 !
! 11 ! 183 !
! 12 ! 183 !
! 13 ! 187 !
! 14 ! 194 !
! 15 ! 185 !
! 16 ! 143 !
! 17 ! 212 !
! 18 ! 170 !
! 19 ! 143 !
! 20 ! 148 !
! 21 ! 141 !
! 22 ! 122 !
! 23 ! 132 !
! 00 ! 95 !
! 01 ! 19 !
! 02 !
! 03 ! 92 !
! 04 ! 98 !
! 05 ! 138 !
```

Breakdown by hour

But if the statistics window shows "Displayed data" (QSOS) and Band (All detailed) then the output information is shown in a more detailed fashion:



Hr	160	80	40	20	15	10	Total
00			208	1			209
01			198	1	2		201
02			172	1			173
03		154	1				155
04		74	59	5			138
05		5	173				178
06	135	4	17				156
07		56	47	40	4		147
08				91	115		206
09			4		135	7	146
10				81	29	75	185
11					99	84	183
12				30	151	2	183
13				2	185		187
14				1	192	1	194
15				14	166	5	185
16				3	138	2	143
17				204	7	1	212
18			1	164	3	2	170
19			31	109	3		143
20			147	1			148
21		130	11				141
22	52	70					122
23	2	1	129				132
00		29	66				95
01	11	8					19
02							
03	51	35		1	5		92
04	80	17		1			98

Breakdown by hour and band

## Namespaces

- [Page](#)
- [Discussion](#)

## Variants

## Views

- [Read](#)
- [View source](#)
- [View history](#)

## More

- This page was last edited on 24 January 2007, at 08:54.

- [Privacy policy](#)
- [About Win-Test Wiki](#)
- [Disclaimers](#)



# SO2R/EZMaster

From Win-Test Wiki

[Jump to navigation](#) [Jump to search](#)

## Contents

- [1 Setting up the EZMaster for use with Win-Test](#)
  - ◆ [1.1 Setting up the technique](#)
  - ◆ [1.2 Setting up the \[Shift\] key for secondary radio](#)
  - ◆ [1.3 Setting up the \[Caps Lock\] key for secondary radio](#)
  - ◆ [1.4 Setting the SO2R Control box](#)
- [2 See also](#)
  - ◆ [2.1 External sources](#)

## Setting up the EZMaster for use with Win-Test

Advanced SO2R mode and setting up scenarios requires external SO2R control equipment of the last generation, communicating with Win-Test via a USB port. EZMaster from HamRadioSolutions has this possibility.

### Setting up the technique

The user must check in the menu `Operating | Technique | Advanced SO2R`.

### Setting up the [Shift] key for secondary radio

The user must check in the menu `Operating | Shift binds to the secondary radio`.

### Setting up the [Caps Lock] key for secondary radio

The user must check in the menu `Operating | Caps Lock binds to the secondary radio`.

### Setting the SO2R Control box

The control SO2R box must be configured in the menu `Options | Configure interfaces`, select a virtual COM port and - if using an EZMaster - choose for settings 19200 bits per second, 8 data bits, no parity, and 1 stop bit, CW for DTR, PTT for RTS and Both Radios active.

Finally the user must set in the case of an EZMaster control box in the menu `Options | EZMaster configuration`, and choose the radios communication data. For example, for two FT1000MPs, the settings are port `rs232` and `com` (cable connecting radios to EZMaster), a speed of 4800 baud, 8 data bits, no parity, 2 stop bits.

### See also

## External sources

- [HamRadioSolutions web site](#)

## Namespaces

- [Page](#)
- [Discussion](#)

## Variants

## Views

- [Read](#)
- [View source](#)
- [View history](#)

## More

- This page was last edited on 12 September 2013, at 14:23.

- [Privacy policy](#)
- [About Win-Test Wiki](#)
- [Disclaimers](#)



# SO2R/EZMaster

From Win-Test Wiki

[Jump to navigation](#) [Jump to search](#)

## Contents

- [1 Setting up the EZMaster for use with Win-Test](#)
  - ◆ [1.1 Setting up the technique](#)
  - ◆ [1.2 Setting up the \[Shift\] key for secondary radio](#)
  - ◆ [1.3 Setting up the \[Caps Lock\] key for secondary radio](#)
  - ◆ [1.4 Setting the SO2R Control box](#)
- [2 See also](#)
  - ◆ [2.1 External sources](#)

## Setting up the EZMaster for use with Win-Test

Advanced SO2R mode and setting up scenarios requires external SO2R control equipment of the last generation, communicating with Win-Test via a USB port. EZMaster from HamRadioSolutions has this possibility.

### Setting up the technique

The user must check in the menu `Operating | Technique | Advanced SO2R`.

### Setting up the [Shift] key for secondary radio

The user must check in the menu `Operating | Shift binds to the secondary radio`.

### Setting up the [Caps Lock] key for secondary radio

The user must check in the menu `Operating | Caps Lock binds to the secondary radio`.

### Setting the SO2R Control box

The control SO2R box must be configured in the menu `Options | Configure interfaces`, select a virtual COM port and - if using an EZMaster - choose for settings 19200 bits per second, 8 data bits, no parity, and 1 stop bit, CW for DTR, PTT for RTS and Both Radios active.

Finally the user must set in the case of an EZMaster control box in the menu `Options | EZMaster configuration`, and choose the radios communication data. For example, for two FT1000MPs, the settings are port `rs232` and `com` (cable connecting radios to EZMaster), a speed of 4800 baud, 8 data bits, no parity, 2 stop bits.

### See also

## External sources

- [HamRadioSolutions web site](#)

## Namespaces

- [Page](#)
- [Discussion](#)

## Variants

## Views

- [Read](#)
- [View source](#)
- [View history](#)

## More

- This page was last edited on 12 September 2013, at 14:23.

- [Privacy policy](#)
- [About Win-Test Wiki](#)
- [Disclaimers](#)



# FAQ:DX Cluster and wtDxTelnet

From Win-Test Wiki

[Jump to navigation](#) [Jump to search](#)

## Contents

- [1 Why don't I see any packet spots in Win-Test?](#)
- [2 Why do I see lots of cluster traffic in the Alt-O window, but only a few spots in the band map?](#)
- [3 How can I connect to other DX Clusters?](#)
- [4 Why do I see many duplicate packet spots in Win-Test?](#)
- [5 Can I make wtDxTelnet start automatically when I start Win-Test?](#)
- [6 Can I connect to more than one cluster or to both CW Skimmer and a cluster?](#)
- [7 Can I make multiple copies of wtDxTelnet start automatically and connect to different clusters?](#)

## Why don't I see any packet spots in Win-Test?

Win-Test provides a separate program called **wtDxTelnet** to connect to packet cluster nodes over the Internet, and to other devices (TNCs or [CW Skimmer](#)). wtDxTelnet then shares these spots with one or more copies of Win-Test via local TCP/IP broadcast messages.

Both Win-Test *and* wtDxTelnet have to be configured to use the same **broadcast address** and **port number**, or else packet spots will not be seen by Win-Test, even if they are displayed OK by wtDxTelnet. You also have to *uncheck* the box labeled **Disable communication with Win-Test** in wtDxTelnet.

- **If you are using a single computer** for both logging and cluster connections (e.g. single-op assisted class), follow the procedure for [Configuring wtDxTelnet \(single-op environment\)](#). It explains how to use the "loopback" address so that all communication between Win-Test and wtDxTelnet stays inside the computer, instead of going over the LAN.
- **If you are using multiple networked computers**, and want to share spotting information between them (e.g. multi-single, multi-multi), follow the procedure for [Configuring wtDxTelnet \(multi-op environment\)](#). You only need to run wtDxTelnet on *one* computer in your network, not all of them.

In both environments, it is essential to **configure the same broadcast address and port number in both programs**.

## Why do I see lots of cluster traffic in the Alt-O window, but only a few spots in the band map?

Win-Test's band map windows automatically filter packet spots based on the radio's current band and entry class (CW, Phone, Mixed), as defined on the [Contest Configuration screen](#). Spots are further filtered by the [band plan](#) that you have selected there.

All DX cluster spots have a time-stamp indicating when the spot was posted by a DX station. Spots have a certain lifetime. They "expire" after they reach a specific age, as defined in the [Band Map Properties](#) dialog. Expired (old) spots never appear in the band map.

## How can I connect to other DX Clusters?

You can always manually change DX Cluster properties. However, there is a list of DX clusters worldwide integrated into Win-Test.

1. In **wtDxTelnet**, select Options | DxCluster Properties and then press the search button
2. You will be prompted with a list of all known DX Clusters who support telnet access
3. Just click on one of them and then OK and the new connection data will be stored

## Why do I see many duplicate packet spots in Win-Test?

If your PC has *both* a wired Ethernet port and a wireless LAN (WLAN) adapter active and connected to the same network, disable one of them.

Only run *one* copy of wtDxTelnet on the network.

When using Ethernet networking, do *not* select **Network** on any serial port. When using rig control, make sure that the proper serial port is marked **Radio 1** or **Radio 2**, and configured properly.

## Can I make wtDxTelnet start automatically when I start Win-Test?

Yes.

1. In **Win-Test**, select Options | DX Cluster ... | Local wtDxTelnet | Start/stop automatically
2. In **wtDxTelnet**, select Options | DxCluster Properties and check both:
  - ◆ *Autoconnect at startup*
  - ◆ *Try to restore connection automatically*

## Can I connect to more than one cluster or to both CW Skimmer and a cluster?

Yes. Just start another wtDxTelnet window (Start | All Programs | Win-Test | wtDxTelnet), but specify a *different* hostname / DX Cluster. You need to run one copy of wtDxTelnet per remote cluster, TNC, or CW Skimmer.

For CW Skimmer running locally, use:

- Hostname/IP: **localhost**
- Port: **7300**

If running wtDxTelnet version 3.0 or higher, create two or more wtDxTelnet icons, one for each cluster and one for CW Skimmer.

1. Create a copy of the wtDxTelnet shortcut, perhaps named **wtDxTelnetSkimmer**
2. Modify the target in the properties of this shortcut by using the **-i** parameter. For example:

```
"C:\Program Files\Win-Test 4\wtDxTelnet.exe" -i wtDxTelnetSkimmer.ini
```

Once this is done, this instance of wtDxTelnet will use its "own" ini file (named **wtDxTelnetSkimmer.ini** in this example) and the two instances of wtDxTelnet will operate independently.

Win-Test can only automatically start *one* instance of wtDxTelnet, and that instance will always use the hard coded **wtDxTelnet.ini** file.

All ini files are saved in the Win-Test **/cfg** directory. See [File | Explore | /cfg directory](#).

## Can I make multiple copies of wtDxTelnet start automatically and connect to different clusters?

No. Win-Test does not support starting more than a single copy of wtDxTelnet automatically, but you can start as many copies as you need manually by adding a wtDxTelnet shortcut to your Windows desktop or to your Windows "Quick Launch" bar.

### Namespaces

- [Page](#)
- [Discussion](#)

### Variants

### Views

- [Read](#)
- [View source](#)
- [View history](#)

### More

- This page was last edited on 24 November 2020, at 14:06.

- [Privacy policy](#)
- [About Win-Test Wiki](#)
- [Disclaimers](#)





# FAQ:DX Cluster and wtDxTelnet

From Win-Test Wiki

[Jump to navigation](#) [Jump to search](#)

## Contents

- [1 Why don't I see any packet spots in Win-Test?](#)
- [2 Why do I see lots of cluster traffic in the Alt-O window, but only a few spots in the band map?](#)
- [3 How can I connect to other DX Clusters?](#)
- [4 Why do I see many duplicate packet spots in Win-Test?](#)
- [5 Can I make wtDxTelnet start automatically when I start Win-Test?](#)
- [6 Can I connect to more than one cluster or to both CW Skimmer and a cluster?](#)
- [7 Can I make multiple copies of wtDxTelnet start automatically and connect to different clusters?](#)

## Why don't I see any packet spots in Win-Test?

Win-Test provides a separate program called **wtDxTelnet** to connect to packet cluster nodes over the Internet, and to other devices (TNCs or [CW Skimmer](#)). wtDxTelnet then shares these spots with one or more copies of Win-Test via local TCP/IP broadcast messages.

Both Win-Test *and* wtDxTelnet have to be configured to use the same **broadcast address** and **port number**, or else packet spots will not be seen by Win-Test, even if they are displayed OK by wtDxTelnet. You also have to *uncheck* the box labeled **Disable communication with Win-Test** in wtDxTelnet.

- **If you are using a single computer** for both logging and cluster connections (e.g. single-op assisted class), follow the procedure for [Configuring wtDxTelnet \(single-op environment\)](#). It explains how to use the "loopback" address so that all communication between Win-Test and wtDxTelnet stays inside the computer, instead of going over the LAN.
- **If you are using multiple networked computers**, and want to share spotting information between them (e.g. multi-single, multi-multi), follow the procedure for [Configuring wtDxTelnet \(multi-op environment\)](#). You only need to run wtDxTelnet on *one* computer in your network, not all of them.

In both environments, it is essential to **configure the same broadcast address and port number in both programs**.

## Why do I see lots of cluster traffic in the Alt-O window, but only a few spots in the band map?

Win-Test's band map windows automatically filter packet spots based on the radio's current band and entry class (CW, Phone, Mixed), as defined on the [Contest Configuration screen](#). Spots are further filtered by the [band plan](#) that you have selected there.

All DX cluster spots have a time-stamp indicating when the spot was posted by a DX station. Spots have a certain lifetime. They "expire" after they reach a specific age, as defined in the [Band Map Properties](#) dialog. Expired (old) spots never appear in the band map.

## How can I connect to other DX Clusters?

You can always manually change DX Cluster properties. However, there is a list of DX clusters worldwide integrated into Win-Test.

1. In **wtDxTelnet**, select Options | DxCluster Properties and then press the search button
2. You will be prompted with a list of all known DX Clusters who support telnet access
3. Just click on one of them and then OK and the new connection data will be stored

## Why do I see many duplicate packet spots in Win-Test?

If your PC has *both* a wired Ethernet port and a wireless LAN (WLAN) adapter active and connected to the same network, disable one of them.

Only run *one* copy of wtDxTelnet on the network.

When using Ethernet networking, do *not* select **Network** on any serial port. When using rig control, make sure that the proper serial port is marked **Radio 1** or **Radio 2**, and configured properly.

## Can I make wtDxTelnet start automatically when I start Win-Test?

Yes.

1. In **Win-Test**, select Options | DX Cluster ... | Local wtDxTelnet | Start/stop automatically
2. In **wtDxTelnet**, select Options | DxCluster Properties and check both:
  - ◆ *Autoconnect at startup*
  - ◆ *Try to restore connection automatically*

## Can I connect to more than one cluster or to both CW Skimmer and a cluster?

Yes. Just start another wtDxTelnet window (Start | All Programs | Win-Test | wtDxTelnet), but specify a *different* hostname / DX Cluster. You need to run one copy of wtDxTelnet per remote cluster, TNC, or CW Skimmer.

For CW Skimmer running locally, use:

- Hostname/IP: **localhost**
- Port: **7300**

If running wtDxTelnet version 3.0 or higher, create two or more wtDxTelnet icons, one for each cluster and one for CW Skimmer.

1. Create a copy of the wtDxTelnet shortcut, perhaps named **wtDxTelnetSkimmer**
2. Modify the target in the properties of this shortcut by using the **-i** parameter. For example:

```
"C:\Program Files\Win-Test 4\wtDxTelnet.exe" -i wtDxTelnetSkimmer.ini
```

Once this is done, this instance of wtDxTelnet will use its "own" ini file (named **wtDxTelnetSkimmer.ini** in this example) and the two instances of wtDxTelnet will operate independently.

Win-Test can only automatically start *one* instance of wtDxTelnet, and that instance will always use the hard coded **wtDxTelnet.ini** file.

All ini files are saved in the Win-Test **/cfg** directory. See [File | Explore | /cfg directory](#).

## Can I make multiple copies of wtDxTelnet start automatically and connect to different clusters?

No. Win-Test does not support starting more than a single copy of wtDxTelnet automatically, but you can start as many copies as you need manually by adding a wtDxTelnet shortcut to your Windows desktop or to your Windows "Quick Launch" bar.

### Namespaces

- [Page](#)
- [Discussion](#)

### Variants

### Views

- [Read](#)
- [View source](#)
- [View history](#)

### More

- This page was last edited on 24 November 2020, at 14:06.

- [Privacy policy](#)
- [About Win-Test Wiki](#)
- [Disclaimers](#)



# FAQ:Licensing

From Win-Test Wiki

[Jump to navigation](#) [Jump to search](#)

## Contents

- [1 I bought Win-Test on the web with my PayPal account since several days, but I haven't received any CD-ROM ! What's wrong ?](#)
- [2 I bought Win-Test on the web with my PayPal account since several days, but I haven't received my registration key ! What's wrong ?](#)
- [3 I received your automatic email, but my registration key is not in ! What's wrong ?](#)
- [4 I went to your registration page but the form requires a computer code. I totally dismantled my computer and I can't find it. Where is it located ?](#)
- [5 I am hosting a multi-op station with several machines. Do I need to buy a licence for each of them ?](#)
- [6 I personally own a Win-Test licence. Can I install Win-Test using my identifiers on the computer of my local radio club ?](#)
- [7 I personally own a Win-Test licence. Can I install Win-Test using my identifiers on the computer brought by my mates who come home for a multi-op effort ?](#)
- [8 I have registered the Win-Test licence to my personal call. Can I use it with a different callsign, like a vanity one?](#)
- [9 My local radio-club owns a Win-Test licence. As a member of this club, can I use its identifiers to install and register Win-Test on my own computer?](#)
- [10 I have registered Win-Test on my desktop computer. Can I register it on my notebook \(or my other computer\), and if so, how to do it?](#)
- [11 I just upgraded to Win-Test V3. But my license is gone?](#)
- [12 Can I have a registered WT2 and a registered WT3 in the same installation directory?](#)
- [13 I asked a question directly to the author and I did not have an answer !](#)
- [14 Where can I read the archives of this mailing list you do not stop talking about ?](#)
- [15 See also](#)

## I bought Win-Test on the web with my PayPal account since several days, but I haven't received any CD-ROM ! What's wrong ?

Actually, you will **never** receive any CD-ROM. Win-Test is **only** downloadable on our web site. Win-Test is not available on CD-ROM or any other media.

## I bought Win-Test on the web with my PayPal account since several days, but I haven't received my registration key ! What's wrong ?

Once our server has received your payment, it automatically sends an email with instructions to register your copy of Win-Test. This email is sent to the email address you provided on our purchase form. First, check you have received this email, by checking your inbox and your junk/spam box (if any). Some antispam software discard this email because it is written in three different languages. Secondly, read it carefully. It explains how to register your copy of Win-Test.

## **I received your automatic email, but my registration key is not in ! What's wrong ?**

You should have carefully read this email. It explains that you have to go to the [registration page](#) on our website, and fulfill this form to request a key. Our server will then send you a personalized registration key to the email address you provided when you bought Win-Test.

## **I went to your registration page but the form requires a computer code. I totally dismantled my computer and I can't find it. Where is it located ?**

Actually, you can re-assemble it now. As the instructions email and the registration page clearly indicate, this computer code is located in the registration dialog you will find in the [Help | Register software...](#) menu of Win-Test. Save the planet, always read the instructions !

## **I am hosting a multi-op station with several machines. Do I need to buy a licence for each of them ?**

No. One licence is enough. The purchase of Win-Test authorizes his owner to use it on every machine he owns. But you will have to request a registration key for each computer.

## **I personally own a Win-Test licence. Can I install Win-Test using my identifiers on the computer of my local radio club ?**

No. You can bring your own computer (laptop) if you wish to operate from the radio club, even using the radio club's callsign, but you cannot install Win-Test on a computer belonging to the radio club, using your personal Win-Test account (licence). To install Win-Test on the (or one of the) computer(s) of the radio club, the radio club itself must have its own licence.

## **I personally own a Win-Test licence. Can I install Win-Test using my identifiers on the computer brought by my mates who come home for a multi-op effort ?**

No. You are only allowed to install and register Win-Test on your own computer(s). Your mates need a personal licence to install and use Win-Test on their own computers.

## **I have registered the Win-Test licence to my personal call. Can I use it with a different callsign, like a vanity one?**

Yes. The operating callsign can be different to the registered callsign. When you set up your contest, you can choose here any callsign you will operate with.

## **My local radio-club owns a Win-Test licence. As a member of this club, can I use its identifiers to install and register Win-Test on my own computer?**

No. The radio-club licence allows to register Win-Test on the computers owned by this club only. If you need to register Win-Test on your own computer, you must buy a personal licence.

## **I have registered Win-Test on my desktop computer. Can I register it on my notebook (or my other computer), and if so, how to do it?**

As you own both computers, you are allowed to install Win-Test and register it. Just request another key for your notebook on our website. Obviously, as the computer code are different for each computer, the registration key you will receive will be different.

## **I just upgraded to Win-Test V3. But my license is gone?**

You have to enter a new registration Key for Win-Test V3. If you would like to have Win-Test V2 installed at the same time, You must install V3 into a different directory so you can have both registration keys installed.

## **Can I have a registered WT2 and a registered WT3 in the same installation directory?**

We totally discourage it. If you want to keep and use a v2, and also use a v3, it is mandatory to install each of them in a different directory. If not, after registering the v3, your v2 will be automatically un-registered. Of course, if you decide not to keep a v2, you can install your v3, and register it, in the same existing directory.

## **I asked a question directly to the author and I did not have an answer !**

Bad choice. Use the mailing list instead.

## **Where can I read the archives of this mailing list you do not stop talking about ?**

You can read the public archives of the mailing list here: <http://www.f5mzn.org/pipermail/support/>

## **See also**

- [Win-Test licensing on http://www.win-test.com](http://www.win-test.com)

[Back to Main Page](#)

## Namespaces

- [Page](#)
- [Discussion](#)

## Variants

## Views

- [Read](#)
- [View source](#)
- [View history](#)

## More

- This page was last edited on 18 November 2007, at 17:26.
- [Privacy policy](#)
- [About Win-Test Wiki](#)
- [Disclaimers](#)



# FAQ:Networking

From Win-Test Wiki

[Jump to navigation](#) [Jump to search](#)

## Contents

- [1 What is the Win-Test network protocol?](#)
- [2 In a networked environment, can we mix different versions of Win-Test?](#)
- [3 UDP error opening socket #10013 and #10038 Errors](#)
- [4 See also](#)

## What is the Win-Test network protocol?

The Win-Test network protocol is used for communication between the computers running Win-Test. It is based on UDP broadcasts ([Wikipedia:User Datagram Protocol](#)). Please see [Networking](#) for information on how to configure networking in Win-Test.

## In a networked environment, can we mix different versions of Win-Test?

No. As usual, you must have the same WT version on every connected computer.

**It is important that ALL computers on the network are running the SAME Win-Test version!** (For example do **not** run version 4.0.7 on one computer and version 4.1.0 on another.)

## UDP error opening socket #10013 and #10038 Errors

Installation of some HUAWEI HSDPA USB MODEM drivers is known to cause these error messages to appear whenever you try to use Win-Test networking. Please try the following:

- Disconnect the Huawei USB modem
- Uninstall the Huawei modem drivers via Control Panel, Add/Remove programs or the icon supplied with the software, if any
- Delete or rename the **Huawei** sub-directory, if any, found under **C:\Program Files**
- Test Win-test networking
- Reinstall the Huawei modem drivers, but use a [newer software driver](#).

There are reports that a newer driver for the Huawei USB modem may fix the problem. But if you no longer need to use the Huawei device on the Win-Test machine, do not install a new driver.

Please check the value of the following registry key using **Start | Run | regedit** in Windows:

```
HKEY_LOCAL_MACHINE\SYSTEM\CurrentControlSet\Services\AFD\Parameters\DisableAddressSharing  
(REG_DWORD, Value 0,1, Default=0)
```

If it is set to 1, set the value to 0.



Reference: [http://technet.microsoft.com/en-us/library/cc781532\(WS.10\).aspx](http://technet.microsoft.com/en-us/library/cc781532(WS.10).aspx)

See also: <http://lists.f5mzn.org/pipermail/support/2009-December/079147.html>

(thanks DL2ALF)

## See also

- [Networking](#)

## Namespaces

- [Page](#)
- [Discussion](#)

## Variants

## Views

- [Read](#)
- [View source](#)
- [View history](#)

## More

- This page was last edited on 10 December 2016, at 16:06.

- [Privacy policy](#)
- [About Win-Test Wiki](#)
- [Disclaimers](#)



# FAQ:Problems Registering and Running

From Win-Test Wiki

[Jump to navigation](#) [Jump to search](#)

## Contents

- [1 How do I download, install, register and configure Win-Test on a new computer?](#)
- [2 I selected Help | Register Software, but don't see my Computer Code](#)
- [3 When I attempt to download Win-Test 4 the web site asks for a login and password. What should I use?](#)
- [4 I requested a new registration key but I never received an email with the key](#)
- [5 Win-Test always starts in "Demo" mode](#)
- [6 My virus scanner reports that Win-Test is a virus!](#)

## How do I download, install, register and configure Win-Test on a new computer?

Click one of the following links to view or download the step-by-step illustrated **Win-Test Installation, Registration and Configuration Guide** (in PDF format) from <http://download.win-test.com/registration/> :

- [wtreg\\_en.pdf](#) - English version by N6TV ([alternate server](#))
- [wtreg\\_fr.pdf](#) - French version by F6FVY ([alternate version by XE1AY](#))
- [wtreg\\_es.pdf](#) - Spanish translation by LU5VV ([alternate server](#))
- [wtreg\\_it.pdf](#) - Italian translation by IK2NCJ ([alternate server](#))
- [wtreg\\_de.pdf](#) - German translation by DL1ELY ([alternate server](#))
- [wtreg\\_pt.pdf](#) - Portuguese translation by CU3HY ([alternate server](#))

Volunteers are needed to translate the guide to other languages. Please [contact N6TV](#) for the PowerPoint source file.

## I selected Help | Register Software, but don't see my Computer Code

Chances are you are running the free "demo" version of Win-Test 4. This version cannot be registered. Download and install the official version from [The Official Version 4 Download Site](#) (password required).

## When I attempt to download Win-Test 4 the web site asks for a login and password. What should I use?

Your **login** is usually your **callsign**.

Both your **login** and **password** are located in the "Win-Test Upgrade" or "Win-Test Purchase" email that you should have received when you purchased or upgraded to Version 4 (including free automatic upgrades). Look for an email:

```
From: robot@win-test.com
Subject: Win-Test V4 Free Upgrade
```

## Win-Test Wiki

-or-

Subject: **Achat de Win-Test - Win-Test purchase**

or similar.

If you can't find the email with your unique web site password, you will need to send an email to F5HRY or F6FVY including your:

- Account Number
- Callsign
- Email address used at time of purchase/upgrade
- Your new email address if any

## I requested a new registration key but I never received an email with the key

First, check your "Spam" folder, if any. Look for an email:

From: **robot@win-test.com**

Subject: **Code de validation de Win-Test - Win-Test registration key**

Next, please note that registration keys are sent to the **email address you provided when you first purchased Win-Test**. If you no longer have access to this email address, you will need to send an email to F5HRY or F6FVY including your:

- Account Number
- Callsign
- Old email address
- New email address

Due to security changes made by many email service providers (Google "DMARC policy"), registration keys sent by the Win-Test robot to **the following email domains will be discarded automatically**, without any warning or notification:

- aol.com
- att.net
- comcast.net
- darc.de
- kolumbus.fi
- prodigy.net
- sbcglobal.net
- talktalk.net
- yahoo.com
- ymail.com

If your registered email address is at one of these domains, contact F5HRY to have your registered email address changed to another domain that still works, such as a Gmail account (gmail.com).

When I attempt to download Win-Test 4 the web site asks for a login and password. What should I use?

## Win-Test always starts in "Demo" mode

Note: Unlike Win-Test Version 3, the free demo version of Win-Test version 4, and the free DXpedition version cannot be registered or "activated"; the full version, which runs in demo mode until it is registered via Help | Register Software, is a different file. It must be downloaded from the password-protected download site (see above if you don't have the password).

Every PC has a unique 13-digit **computer code** (XXX-XXXX-XXXXXX) and every PC needs a unique 25-digit **registration key** (XXXXX-XXXXX-XXXXX-XXXXX-XXXXX).

The registration keys for Win-Test Version 3 and Win-Test Version 4 are different. Even if you never purchased or installed Win-Test Version 4, you may have received a "free upgrade" email, especially if you purchased Win-Test Version 3 *after June, 2008*. If you received such an email, you are automatically going to receive only Version 4 registration keys when you request a key from the Win-Test Registration Page. Such keys *do not work* on Win-Test Version 3, though no error message is displayed. If you still require a Win-Test Version 3 registration key, you will need to request one by sending an email to F5HRY or F6FVY including your:

- Account Number
- Callsign
- Computer Code

Users who have not received a free upgrade to Version 4 and have not purchased an upgrade to Version 4 will still receive Version 3 registration keys from the web site.

## My virus scanner reports that Win-Test is a virus!

This is most probably a false alarm, especially if you downloaded and installed Win-Test from the Official Win-Test download site.

Many virus scanners are especially prone to falsely reporting the "Artemis" or "Themida" virus in Win-Test Version 4, due to the way the executable is constructed. You will need to add an "exception" to your antivirus software to allow Win-Test to run.

On Windows 10, Microsoft Defender has been observed inhibiting the start of the **wt.exe** or even moving the file into quarantine. To avoid this, add Win-Test's installation directory to the Defender's exception list.

You can always upload **wt.exe** to VirusTotal.com to test it with multiple scanners. If less than 25% of the virus scanners report an issue, it is likely that Win-Test is *not infected*. Typically 6-7 out of the 60+ scanners will falsely report a virus in **wt.exe**.

## Namespaces

- Page
- Discussion

## Variants

## Views

- [Read](#)
- [View source](#)
- [View history](#)

## More

- This page was last edited on 20 November 2020, at 17:53.

- [Privacy policy](#)
- [About Win-Test Wiki](#)
- [Disclaimers](#)



# FAQ:Problems Registering and Running

From Win-Test Wiki

[Jump to navigation](#) [Jump to search](#)

## Contents

- [1 How do I download, install, register and configure Win-Test on a new computer?](#)
- [2 I selected Help | Register Software, but don't see my Computer Code](#)
- [3 When I attempt to download Win-Test 4 the web site asks for a login and password. What should I use?](#)
- [4 I requested a new registration key but I never received an email with the key](#)
- [5 Win-Test always starts in "Demo" mode](#)
- [6 My virus scanner reports that Win-Test is a virus!](#)

## How do I download, install, register and configure Win-Test on a new computer?

Click one of the following links to view or download the step-by-step illustrated **Win-Test Installation, Registration and Configuration Guide** (in PDF format) from <http://download.win-test.com/registration/> :

- [wtreg\\_en.pdf](#) - English version by N6TV ([alternate server](#))
- [wtreg\\_fr.pdf](#) - French version by F6FVY ([alternate version by XE1AY](#))
- [wtreg\\_es.pdf](#) - Spanish translation by LU5VV ([alternate server](#))
- [wtreg\\_it.pdf](#) - Italian translation by IK2NCJ ([alternate server](#))
- [wtreg\\_de.pdf](#) - German translation by DL1ELY ([alternate server](#))
- [wtreg\\_pt.pdf](#) - Portuguese translation by CU3HY ([alternate server](#))

Volunteers are needed to translate the guide to other languages. Please [contact N6TV](#) for the PowerPoint source file.

## I selected Help | Register Software, but don't see my Computer Code

Chances are you are running the free "demo" version of Win-Test 4. This version cannot be registered. Download and install the official version from [The Official Version 4 Download Site](#) (password required).

## When I attempt to download Win-Test 4 the web site asks for a login and password. What should I use?

Your **login** is usually your **callsign**.

Both your **login** and **password** are located in the "Win-Test Upgrade" or "Win-Test Purchase" email that you should have received when you purchased or upgraded to Version 4 (including free automatic upgrades). Look for an email:

From: [robot@win-test.com](mailto:robot@win-test.com)  
Subject: **Win-Test V4 Free Upgrade**

## Win-Test Wiki

-or-

Subject: **Achat de Win-Test - Win-Test purchase**

or similar.

If you can't find the email with your unique web site password, you will need to send an email to F5HRY or F6FVY including your:

- Account Number
- Callsign
- Email address used at time of purchase/upgrade
- Your new email address if any

## I requested a new registration key but I never received an email with the key

First, check your "Spam" folder, if any. Look for an email:

From: **robot@win-test.com**

Subject: **Code de validation de Win-Test - Win-Test registration key**

Next, please note that registration keys are sent to the **email address you provided when you first purchased Win-Test**. If you no longer have access to this email address, you will need to send an email to F5HRY or F6FVY including your:

- Account Number
- Callsign
- Old email address
- New email address

Due to security changes made by many email service providers (Google "DMARC policy"), registration keys sent by the Win-Test robot to **the following email domains will be discarded automatically**, without any warning or notification:

- aol.com
- att.net
- comcast.net
- darc.de
- kolumbus.fi
- prodigy.net
- sbcglobal.net
- talktalk.net
- yahoo.com
- ymail.com

If your registered email address is at one of these domains, contact F5HRY to have your registered email address changed to another domain that still works, such as a Gmail account (gmail.com).

When I attempt to download Win-Test 4 the web site asks for a login and password. What should I use?

## Win-Test always starts in "Demo" mode

Note: Unlike Win-Test Version 3, the free demo version of Win-Test version 4, and the free DXpedition version cannot be registered or "activated"; the full version, which runs in demo mode until it is registered via Help | Register Software, is a different file. It must be downloaded from the password-protected download site (see above if you don't have the password).

Every PC has a unique 13-digit **computer code** (XXX-XXXX-XXXXXX) and every PC needs a unique 25-digit **registration key** (XXXXX-XXXXX-XXXXX-XXXXX-XXXXX).

The registration keys for Win-Test Version 3 and Win-Test Version 4 are different. Even if you never purchased or installed Win-Test Version 4, you may have received a "free upgrade" email, especially if you purchased Win-Test Version 3 *after June, 2008*. If you received such an email, you are automatically going to receive only Version 4 registration keys when you request a key from the Win-Test Registration Page. Such keys *do not work* on Win-Test Version 3, though no error message is displayed. If you still require a Win-Test Version 3 registration key, you will need to request one by sending an email to F5HRY or F6FVY including your:

- Account Number
- Callsign
- Computer Code

Users who have not received a free upgrade to Version 4 and have not purchased an upgrade to Version 4 will still receive Version 3 registration keys from the web site.

## My virus scanner reports that Win-Test is a virus!

This is most probably a false alarm, especially if you downloaded and installed Win-Test from the Official Win-Test download site.

Many virus scanners are especially prone to falsely reporting the "Artemis" or "Themida" virus in Win-Test Version 4, due to the way the executable is constructed. You will need to add an "exception" to your antivirus software to allow Win-Test to run.

On Windows 10, Microsoft Defender has been observed inhibiting the start of the **wt.exe** or even moving the file into quarantine. To avoid this, add Win-Test's installation directory to the Defender's exception list.

You can always upload **wt.exe** to VirusTotal.com to test it with multiple scanners. If less than 25% of the virus scanners report an issue, it is likely that Win-Test is *not infected*. Typically 6-7 out of the 60+ scanners will falsely report a virus in **wt.exe**.

## Namespaces

- Page
- Discussion



## Variants

## Views

- [Read](#)
- [View source](#)
- [View history](#)

## More

- This page was last edited on 20 November 2020, at 17:53.

- [Privacy policy](#)
- [About Win-Test Wiki](#)
- [Disclaimers](#)



# FAQ:Rotator Control and wtRotators

From Win-Test Wiki

[Jump to navigation](#) [Jump to search](#)

## How do I control my rotators with Win-Test?

Win-Test provides a separate program called **wtRotators** to connect to rotator control boxes. wtRotators shares the rotator controller with one or more copies of Win-Test via local TCP/IP broadcast messages. A third party program called [PstRotatorAz](#) offered by YO3DMU may also be used with Win-Test instead of wtRotators.

Both Win-Test *and* wtRotators/PstRotatorsAz have to be configured to use the same **broadcast address** and **port number**, or else Win-Test and the rotator control software will not be able to communicate.

- **If you are using a single computer** for both logging and rotator control (e.g. single-op), follow the procedure for [Configuring wtRotators \(single PC, no network\)](#). It explains how to use the "loopback" address so that all communication between Win-Test and wtRotators stays inside the computer, instead of going over the LAN.
- **If you are using multiple networked computers**, and want to control rotators from more than one PC, (e.g. multi-single, multi-multi), follow the procedure for [Configuring wtRotators \(multi-op environment\)](#). You only need to run wtRotators on the PC that is physically connected to the control box, not all of them.

In both environments, it is essential to **configure the same broadcast address and port number in both programs**.

Win-Test will automatically calculate beam headings and rotate the appropriate antenna as long as this information is properly defined to wtRotators. See [Add your rotators](#).

## Can I make wtRotators start automatically when I start Win-Test?

Yes. In **Win-Test**, select [Windows | Rotators](#) then right click and select **Local wtRotators | Start/stop automatically**.

## How do I control a Green Heron RT-21 control box with wtRotators?

Select **Hy-Gain DCU-1** as the rotator type.

Serial ports numbered COM10 and above are supported by wtRotators version 1.4.2 or later. Earlier versions only work with COM1 to COM9. If using the USB Interface, use the Windows Device Manager to determine the virtual serial port assigned to your control box.

## Namespaces

- [Page](#)
- [Discussion](#)

## Variants

## Views

- [Read](#)
- [View source](#)
- [View history](#)

## More

- This page was last edited on 23 February 2016, at 05:30.
- [Privacy policy](#)
- [About Win-Test Wiki](#)
- [Disclaimers](#)



# FAQ:Rotator Control and wtRotators

From Win-Test Wiki

[Jump to navigation](#) [Jump to search](#)

## How do I control my rotators with Win-Test?

Win-Test provides a separate program called **wtRotators** to connect to rotator control boxes. wtRotators shares the rotator controller with one or more copies of Win-Test via local TCP/IP broadcast messages. A third party program called [PstRotatorAz](#) offered by YO3DMU may also be used with Win-Test instead of wtRotators.

Both Win-Test *and* wtRotators/PstRotatorsAz have to be configured to use the same **broadcast address** and **port number**, or else Win-Test and the rotator control software will not be able to communicate.

- **If you are using a single computer** for both logging and rotator control (e.g. single-op), follow the procedure for [Configuring wtRotators \(single PC, no network\)](#). It explains how to use the "loopback" address so that all communication between Win-Test and wtRotators stays inside the computer, instead of going over the LAN.
- **If you are using multiple networked computers**, and want to control rotators from more than one PC, (e.g. multi-single, multi-multi), follow the procedure for [Configuring wtRotators \(multi-op environment\)](#). You only need to run wtRotators on the PC that is physically connected to the control box, not all of them.

In both environments, it is essential to **configure the same broadcast address and port number in both programs**.

Win-Test will automatically calculate beam headings and rotate the appropriate antenna as long as this information is properly defined to wtRotators. See [Add your rotators](#).

## Can I make wtRotators start automatically when I start Win-Test?

Yes. In **Win-Test**, select [Windows | Rotators](#) then right click and select **Local wtRotators | Start/stop automatically**.

## How do I control a Green Heron RT-21 control box with wtRotators?

Select **Hy-Gain DCU-1** as the rotator type.

Serial ports numbered COM10 and above are supported by wtRotators version 1.4.2 or later. Earlier versions only work with COM1 to COM9. If using the USB Interface, use the Windows Device Manager to determine the virtual serial port assigned to your control box.

## Namespaces

- [Page](#)
- [Discussion](#)

## Variants

## Views

- [Read](#)
- [View source](#)
- [View history](#)

## More

- This page was last edited on 23 February 2016, at 05:30.

- [Privacy policy](#)
- [About Win-Test Wiki](#)
- [Disclaimers](#)



# File:20200208 221352.gif

From Win-Test Wiki

[Jump to navigation](#) [Jump to search](#)

- [File](#)
- [File history](#)
- [File usage](#)
- [Metadata](#)





No higher resolution available.

20200208\_221352.gif (800 Å 480 pixels, file size: 34 KB, MIME type: image.gif)

## File history

Click on a date/time to view the file as it appeared at that time.

	Date/Time	Thumbnail	Dimensions	User	Comment
current	<u>19:14, 10 February 2020</u>		800 Å 480 (34 KB)	<u>DI6rai</u> ( <a href="#">talk</a>   <a href="#">contribs</a> )	
	<u>19:13, 10 February 2020</u>		800 Å 480 (34 KB)	<u>DI6rai</u> ( <a href="#">talk</a>   <a href="#">contribs</a> )	

You cannot overwrite this file.

## File usage

The following page uses this file:

- BestPractice7

## Metadata

This file contains additional information, probably added from the digital camera or scanner used to create or digitize it.

If the file has been modified from its original state, some details may not fully reflect the modified file.

**Horizontal resolution** 28.35 dpc

**Vertical resolution** 28.35 dpc

## Namespaces

- File
- Discussion

## Variants

## Views

- Read
- View source
- View history

## More

- This page was last edited on 10 February 2020, at 19:14.

- [Privacy policy](#)
- [About Win-Test Wiki](#)
- [Disclaimers](#)





# File:20200208 221352.gif

From Win-Test Wiki

[Jump to navigation](#) [Jump to search](#)

- [File](#)
- [File history](#)
- [File usage](#)
- [Metadata](#)





No higher resolution available.

[20200208\\_221352.gif](#) (800 Å 480 pixels, file size: 34 KB, MIME type: image.gif)

## File history

Click on a date/time to view the file as it appeared at that time.

	Date/Time	Thumbnail	Dimensions	User	Comment
current	<a href="#">19:14, 10 February 2020</a>		800 Å 480 (34 KB)	<a href="#">Dl6rai</a> ( <a href="#">talk</a>   <a href="#">contribs</a> )	
	<a href="#">19:13, 10 February 2020</a>		800 Å 480 (34 KB)	<a href="#">Dl6rai</a> ( <a href="#">talk</a>   <a href="#">contribs</a> )	

You cannot overwrite this file.

## File usage

The following page uses this file:

- [BestPractice7](#)

## Metadata

This file contains additional information, probably added from the digital camera or scanner used to create or digitize it.

If the file has been modified from its original state, some details may not fully reflect the modified file.

**Horizontal resolution** 28.35 dpc

**Vertical resolution** 28.35 dpc

## Namespaces

- [File](#)
- [Discussion](#)

## Variants

## Views

- [Read](#)
- [View source](#)
- [View history](#)

## More

- This page was last edited on 10 February 2020, at 19:14.

- [Privacy policy](#)
- [About Win-Test Wiki](#)
- [Disclaimers](#)



# File:20200210 105102.gif

From Win-Test Wiki

[Jump to navigation](#) [Jump to search](#)

- [File](#)
- [File history](#)
- [File usage](#)
- [Metadata](#)



RADIO SETTING	
MODE SSB MODE AM MODE FM MODE PSK / DATA <b>MODE RTTY</b> ENCDEC PSK ENCDEC RTTY	MODE RTTY
	HCUT FREQ: 3000Hz
	HCUT SLOPE: 6dB/oct, 18dB/oct
	RTTY OUT SELECT: MAIN, SUB
	RTTY OUT LEVEL: 50
	RPTT SELECT: DAKY, <b>RTS</b> , DTR
	MARK FREQUENCY: 1275Hz, 2125Hz
	SHIFT FREQUENCY: 170Hz
BACK	

No higher resolution available.

20200210\_105102.gif (800 × 480 pixels, file size: 39 KB, MIME type: image.gif)

## File history

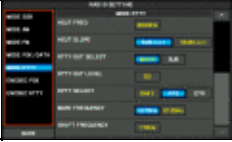
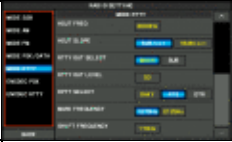
Click on a date/time to view the file as it appeared at that time.

	Date/Time	Thumbnail	Dimensions	User	Comment
current	<u>18:49, 10 February 2020</u>		800 × 480 (39 KB)	<a href="#">Dl6rai</a> ( <a href="#">talk</a>   <a href="#">contribs</a> )	
	<u>18:47, 10 February 2020</u>		800 × 480 (32 KB)	<a href="#">Dl6rai</a> ( <a href="#">talk</a>   <a href="#">contribs</a> )	Reverted to version as of 18:34, 10 February 2020
	<u>18:46, 10 February 2020</u>		800 × 480 (39 KB)	<a href="#">Dl6rai</a> ( <a href="#">talk</a>   <a href="#">contribs</a> )	
	<u>18:34, 10 February 2020</u>		800 × 480 (32 KB)	<a href="#">Dl6rai</a> ( <a href="#">talk</a>   <a href="#">contribs</a> )	

You cannot overwrite this file.

## File usage

The following page uses this file:

- [BestPractice7](#)

## Metadata

This file contains additional information, probably added from the digital camera or scanner used to create or digitize it.

If the file has been modified from its original state, some details may not fully reflect the modified file.

**Horizontal resolution** 28.35 dpc

**Vertical resolution** 28.35 dpc

## Namespaces

- [File](#)
- [Discussion](#)

## Variants

## Views

- [Read](#)
- [View source](#)
- [View history](#)

## More

- This page was last edited on 10 February 2020, at 18:49.

- [Privacy policy](#)
- [About Win-Test Wiki](#)
- [Disclaimers](#)



# File:20200210 105102.gif

From Win-Test Wiki

[Jump to navigation](#) [Jump to search](#)

- [File](#)
- [File history](#)
- [File usage](#)
- [Metadata](#)



RADIO SETTING	
MODE SSB MODE AM MODE FM MODE PSK / DATA <b>MODE RTTY</b> ENCDEC PSK ENCDEC RTTY	MODE RTTY
	HCUT FREQ: 3000Hz
	HCUT SLOPE: 6dB/oct, 18dB/oct
	RTTY OUT SELECT: MAIN, SUB
	RTTY OUT LEVEL: 50
	RPTT SELECT: DAKY, RTS, DTR
	MARK FREQUENCY: 1275Hz, 2125Hz
	SHIFT FREQUENCY: 170Hz
BACK	

No higher resolution available.

20200210\_105102.gif (800 × 480 pixels, file size: 39 KB, MIME type: image.gif)

## File history

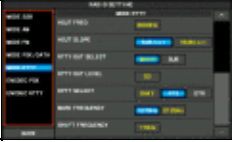
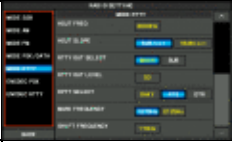
Click on a date/time to view the file as it appeared at that time.

	Date/Time	Thumbnail	Dimensions	User	Comment
current	<a href="#">18:49, 10 February 2020</a>		800 × 480 (39 KB)	<a href="#">Dl6rai (talk   contribs)</a>	
	<a href="#">18:47, 10 February 2020</a>		800 × 480 (32 KB)	<a href="#">Dl6rai (talk   contribs)</a>	Reverted to version as of 18:34, 10 February 2020
	<a href="#">18:46, 10 February 2020</a>		800 × 480 (39 KB)	<a href="#">Dl6rai (talk   contribs)</a>	
	<a href="#">18:34, 10 February 2020</a>		800 × 480 (32 KB)	<a href="#">Dl6rai (talk   contribs)</a>	

You cannot overwrite this file.

## File usage

The following page uses this file:

- [BestPractice7](#)

## Metadata

This file contains additional information, probably added from the digital camera or scanner used to create or digitize it.

If the file has been modified from its original state, some details may not fully reflect the modified file.

**Horizontal resolution** 28.35 dpc

**Vertical resolution** 28.35 dpc

## Namespaces

- [File](#)
- [Discussion](#)



## Variants

## Views

- [Read](#)
- [View source](#)
- [View history](#)

## More

- This page was last edited on 10 February 2020, at 18:49.

- [Privacy policy](#)
- [About Win-Test Wiki](#)
- [Disclaimers](#)



# File:ActivateExchangeGuessing.gif

From Win-Test Wiki

[Jump to navigation](#) [Jump to search](#)

- [File](#)
- [File history](#)
- [File usage](#)

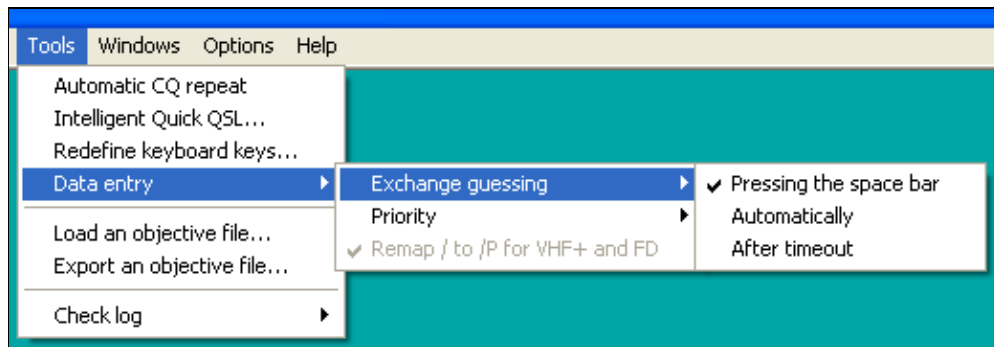

No higher resolution available.

[ActivateExchangeGuessing.gif](#) (520 × 178 pixels, file size: 7 KB, MIME type: image/gif)

## File history

Click on a date/time to view the file as it appeared at that time.

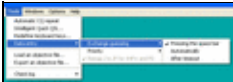
Date/Time	Thumbnail	Dimensions	User	Comment
current <a href="#">07:54, 1 January 2007</a>		520 × 178 (7 KB)	<a href="#">Dl6rai</a> ( <a href="#">talk</a>   <a href="#">contribs</a> )	

You cannot overwrite this file.

## File usage

The following page uses this file:

- [Database Files](#)

## Namespaces

- [File](#)
- [Discussion](#)

## Variants

## Views

- [Read](#)
- [View source](#)
- [View history](#)

## More

- This page was last edited on 1 January 2007, at 07:54.

- [Privacy policy](#)
- [About Win-Test Wiki](#)
- [Disclaimers](#)



# File:ActivateExchangeGuessing.gif

From Win-Test Wiki

[Jump to navigation](#) [Jump to search](#)

- [File](#)
- [File history](#)
- [File usage](#)

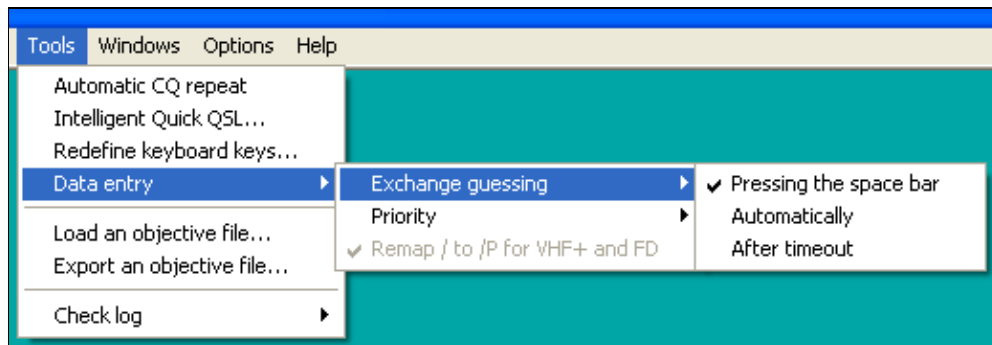

No higher resolution available.

[ActivateExchangeGuessing.gif](#) (520 × 178 pixels, file size: 7 KB, MIME type: image/gif)

## File history

Click on a date/time to view the file as it appeared at that time.

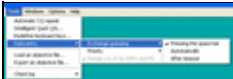
Date/Time	Thumbnail	Dimensions	User	Comment
current <a href="#">07:54, 1 January 2007</a>		520 × 178 (7 KB)	<a href="#">Dl6rai</a> ( <a href="#">talk</a>   <a href="#">contribs</a> )	

You cannot overwrite this file.

## File usage

The following page uses this file:

- [Database Files](#)

## Namespaces

- [File](#)
- [Discussion](#)

## Variants

## Views

- [Read](#)
- [View source](#)
- [View history](#)

## More

- This page was last edited on 1 January 2007, at 07:54.

- [Privacy policy](#)
- [About Win-Test Wiki](#)
- [Disclaimers](#)



# File:ARRLSweepstakesContestConfiguration.gif

From Win-Test Wiki

[Jump to navigation](#) [Jump to search](#)

- [File](#)
- [File history](#)
- [File usage](#)

**Contest configuration**

Station

Callsign: N6TV Grid Square: CM97CF Exchange (zone, ...: SCV ?

DXCC Prefix: W WAZ zone: 03 ITU zone: 06 State/Province/Other: CA

Name: Robert A. Wilson

Address: 51 Cheltenham Way

Address: San Jose, CA 95139-1257

Address: USA

Club: Northern California Contest Club

Load

N6TV WRTC R3/N6TV R39WRTC WK5T

Save as

N6TV WRTC R3/N6TV R39WRTC WK5T

Contest

Contest: ARRL Sweepstakes Days...  This month only

Category: Single operator Mode: CW

Overlay: --- Band plan: Default Setup...

Class: High power License year: 72

Operators:

Network

Station: STN1  Enable time distribution across the network

OK Cancel

No higher resolution available.

[ARRLSweepstakesContestConfiguration.gif](#) (526 × 600 pixels, file size: 35 KB, MIME type: image.gif)

Typical contest configuration window for ARRL Sweepstakes

## File history

Click on a date/time to view the file as it appeared at that time.

	Date/Time	Thumbnail	Dimensions	User	Comment
current	<a href="#">06:56, 5 November 2010</a>		526 × 600 (35 KB)	<a href="#">N6TV</a> ( <a href="#">talk</a>   <a href="#">contribs</a> )	Typical contest configuration window for ARRL Sweepstakes

You cannot overwrite this file.

## File usage

The following page uses this file:

- [Sweepstakes](#)

## Namespaces

- [File](#)
- [Discussion](#)

## Variants

## Views

- [Read](#)
- [View source](#)
- [View history](#)

## More

- This page was last edited on 5 November 2010, at 06:56.

- [Privacy policy](#)
- [About Win-Test Wiki](#)
- [Disclaimers](#)



# File:ARRLSweepstakesCWMsgsConfiguration.gif

From Win-Test Wiki

[Jump to navigation](#) [Jump to search](#)

- [File](#)
- [File history](#)
- [File usage](#)

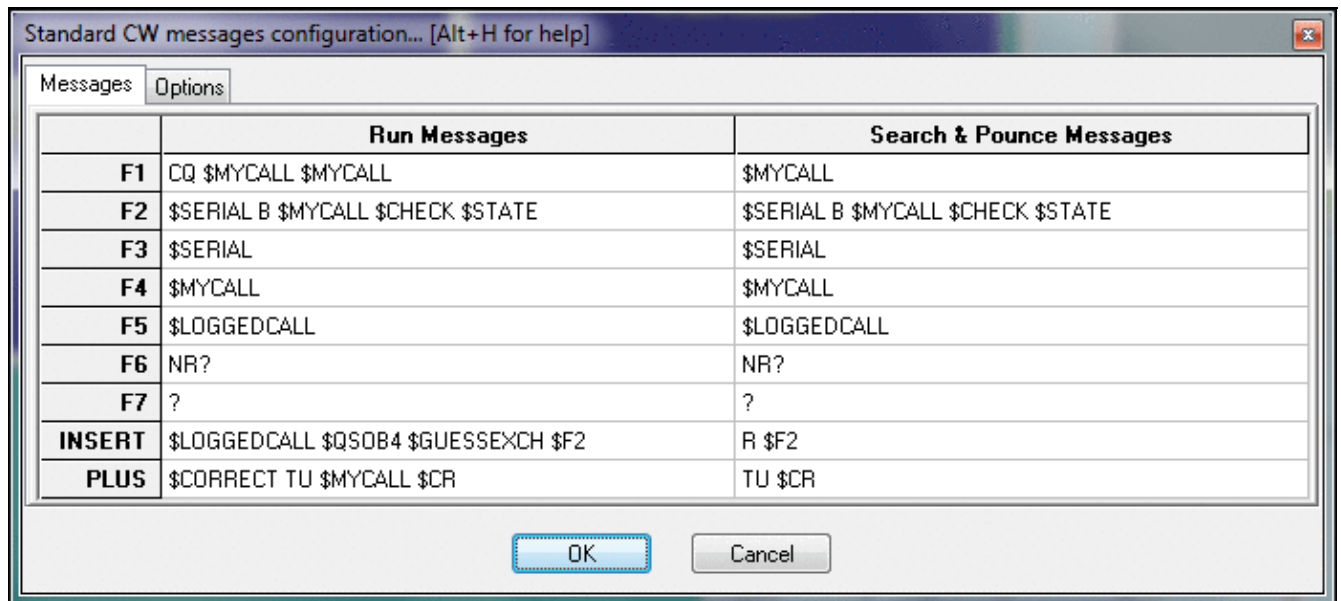

No higher resolution available.

[ARRLSweepstakesCWMsgsConfiguration.gif](#) (694 × 312 pixels, file size: 29 KB, MIME type: image/gif)

Typical ARRL Sweepstakes CW Messages Configuration

## File history

Click on a date/time to view the file as it appeared at that time.

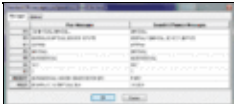
	Date/Time	Thumbnail	Dimensions	User	Comment
current	<a href="#">06:56, 5 November 2010</a>		694 × 312 (29 KB)	<a href="#">N6TV (talk   contribs)</a>	Typical ARRL Sweepstakes CW Messages Configuration

You cannot overwrite this file.

## File usage

The following page uses this file:

- [Sweepstakes](#)



## Namespaces

- [File](#)
- [Discussion](#)

## Variants

## Views

- [Read](#)
- [View source](#)
- [View history](#)

## More

- This page was last edited on 5 November 2010, at 06:56.
- [Privacy policy](#)
- [About Win-Test Wiki](#)
- [Disclaimers](#)



# File:ARRLSweepstakesLogOptions.gif

From Win-Test Wiki

[Jump to navigation](#) [Jump to search](#)

- [File](#)
- [File history](#)
- [File usage](#)

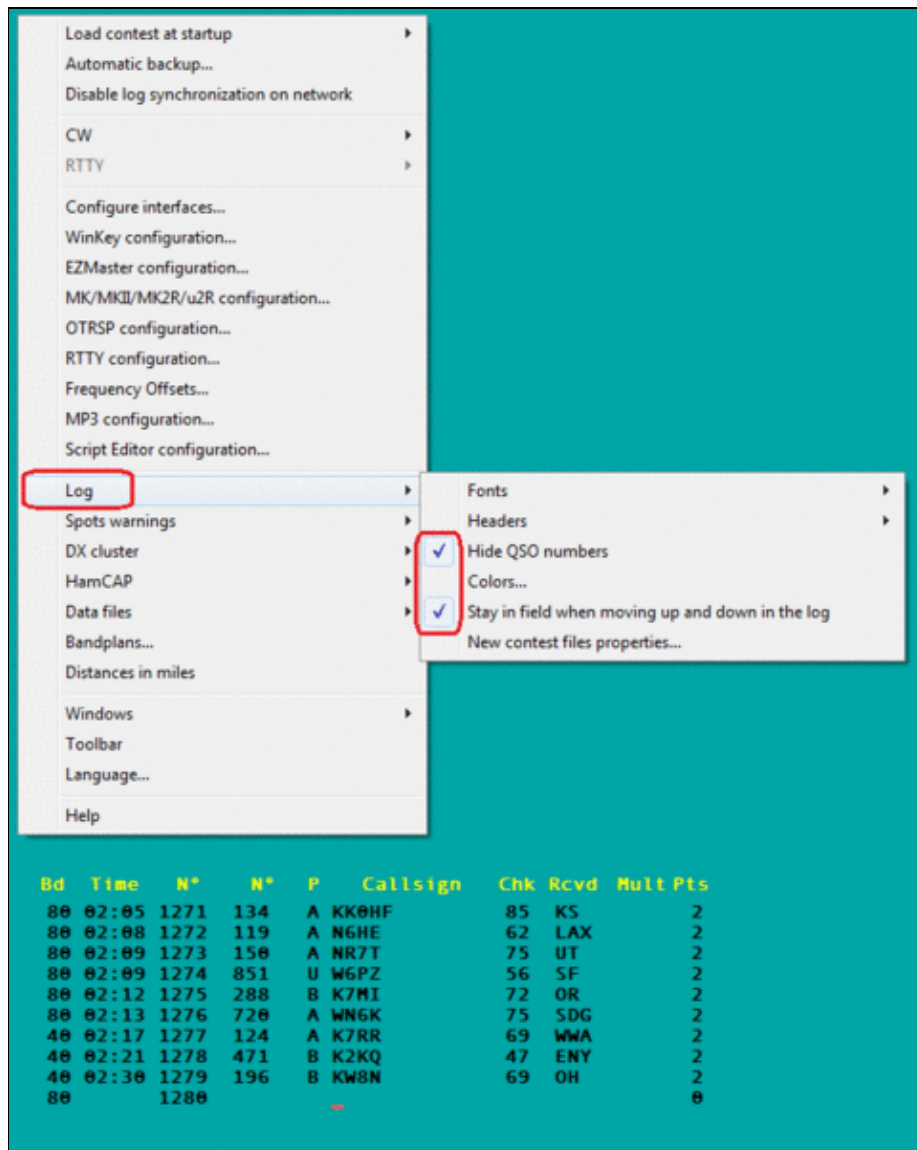



Size of this preview: [481 Å 600 pixels](#). Other resolutions: [192 Å 240 pixels](#) | [668 Å 833 pixels](#). [Original file](#) (668 Å 833 pixels, file size: 42 KB, MIME type: image.gif)

Using the "hide QSO numbers" and "stay in field when moving up and down in the log" options.

## File history

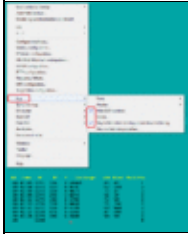
Click on a date/time to view the file as it appeared at that time.

	Date/Time	Thumbnail	Dimensions	User	Comment
current	<a href="#">07:39, 5 November 2010</a>		668 Å 833 (42 KB)	<a href="#">N6TV (talk   contribs)</a>	ARRL Log Window options useful for ARRL Sweepstakes
	<a href="#">07:29, 5 November 2010</a>		1,165 Å 615 (49 KB)	<a href="#">N6TV (talk   contribs)</a>	Using the "hide QSO numbers" and "stay in field when moving up and down in the log" options.

You cannot overwrite this file.

## File usage

The following page uses this file:

- [Sweepstakes](#)

## Namespaces

- [File](#)
- [Discussion](#)

## Variants

## Views

- [Read](#)
- [View source](#)
- [View history](#)

## More

- This page was last edited on 5 November 2010, at 07:29.
- [Privacy policy](#)
- [About Win-Test Wiki](#)
- [Disclaimers](#)



# File:ARRLSweepstakesLogOptions.gif

From Win-Test Wiki

[Jump to navigation](#) [Jump to search](#)

- [File](#)
- [File history](#)
- [File usage](#)

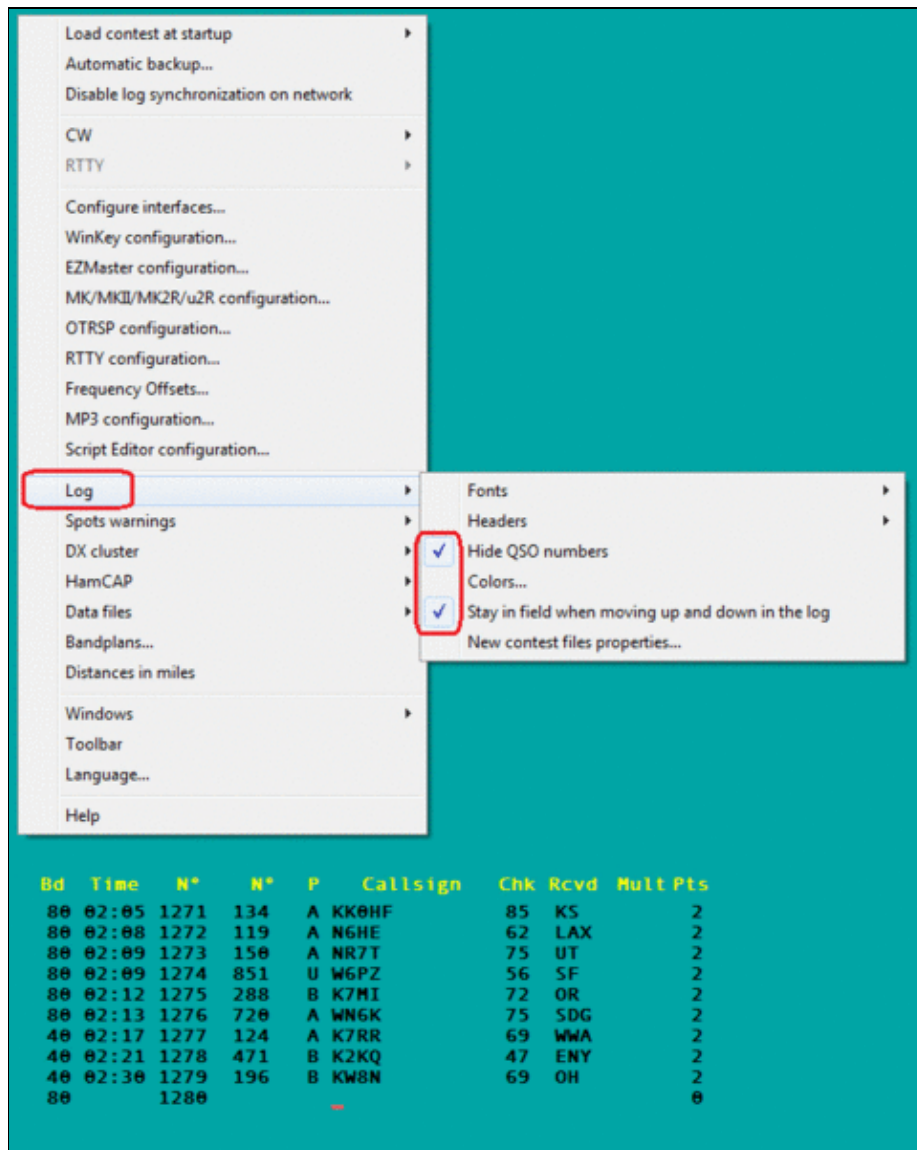



Size of this preview: [481 Å 600 pixels](#). Other resolutions: [192 Å 240 pixels](#) | [668 Å 833 pixels](#). [Original file](#) (668 Å 833 pixels, file size: 42 KB, MIME type: image.gif)

Using the "hide QSO numbers" and "stay in field when moving up and down in the log" options.

## File history

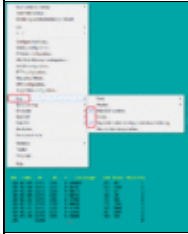
Click on a date/time to view the file as it appeared at that time.

	Date/Time	Thumbnail	Dimensions	User	Comment
current	<a href="#">07:39, 5 November 2010</a>		668 Å 833 (42 KB)	<a href="#">N6TV (talk   contribs)</a>	ARRL Log Window options useful for ARRL Sweepstakes
	<a href="#">07:29, 5 November 2010</a>		1,165 Å 615 (49 KB)	<a href="#">N6TV (talk   contribs)</a>	Using the "hide QSO numbers" and "stay in field when moving up and down in the log" options.

You cannot overwrite this file.

## File usage

The following page uses this file:

- [Sweepstakes](#)

## Namespaces

- [File](#)
- [Discussion](#)

## Variants

## Views

- [Read](#)
- [View source](#)
- [View history](#)

## More

- This page was last edited on 5 November 2010, at 07:29.
- [Privacy policy](#)
- [About Win-Test Wiki](#)
- [Disclaimers](#)



# File:ARRLSweepstakesSectionList.gif

From Win-Test Wiki

[Jump to navigation](#) [Jump to search](#)

- [File](#)
- [File history](#)
- [File usage](#)

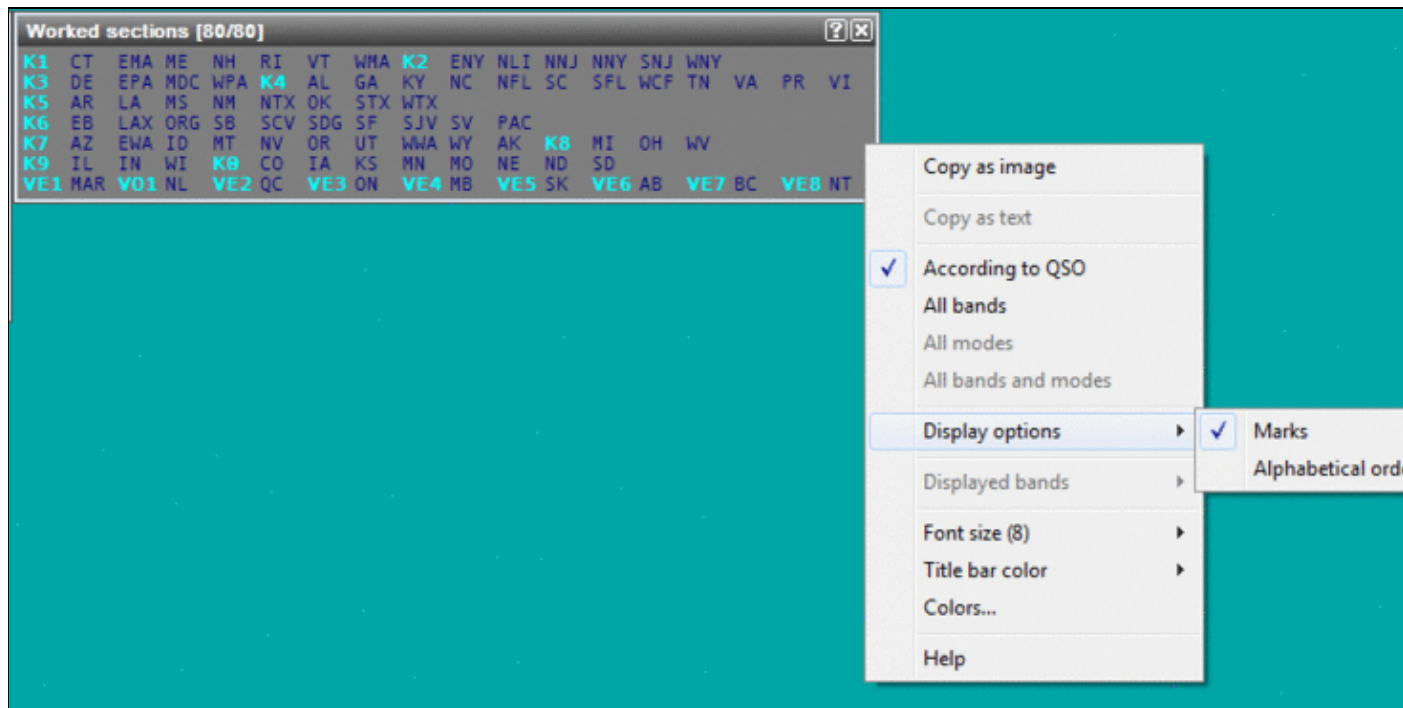

Size of this preview: [800 Å 368 pixels](#). Other resolutions: [320 Å 147 pixels](#) | [903 Å 415 pixels](#). [Original file](#) (903 Å 415 pixels, file size: 24 KB, MIME type: image.gif)

ARRL Sweepstakes Section List, display by call district

## File history

Click on a date/time to view the file as it appeared at that time.

	Date/Time	Thumbnail	Dimensions	User	Comment
current	<a href="#">07:21, 5 November 2010</a>		903 Å 415 (24 KB)	<a href="#">N6TV</a> ( <a href="#">talk</a>   <a href="#">contribs</a> )	ARRL Sweepstakes Section List, display by call district

You cannot overwrite this file.

## File usage

The following page uses this file:

File:ARRLSweepstakesSectionList.gif



- [Sweepstakes](#)

## Namespaces

- [File](#)
- [Discussion](#)

## Variants

## Views

- [Read](#)
- [View source](#)
- [View history](#)

## More

- This page was last edited on 5 November 2010, at 07:21.

- [Privacy policy](#)
- [About Win-Test Wiki](#)
- [Disclaimers](#)



# File:ARRLSweepstakesSectionList.gif

From Win-Test Wiki

[Jump to navigation](#) [Jump to search](#)

- [File](#)
- [File history](#)
- [File usage](#)

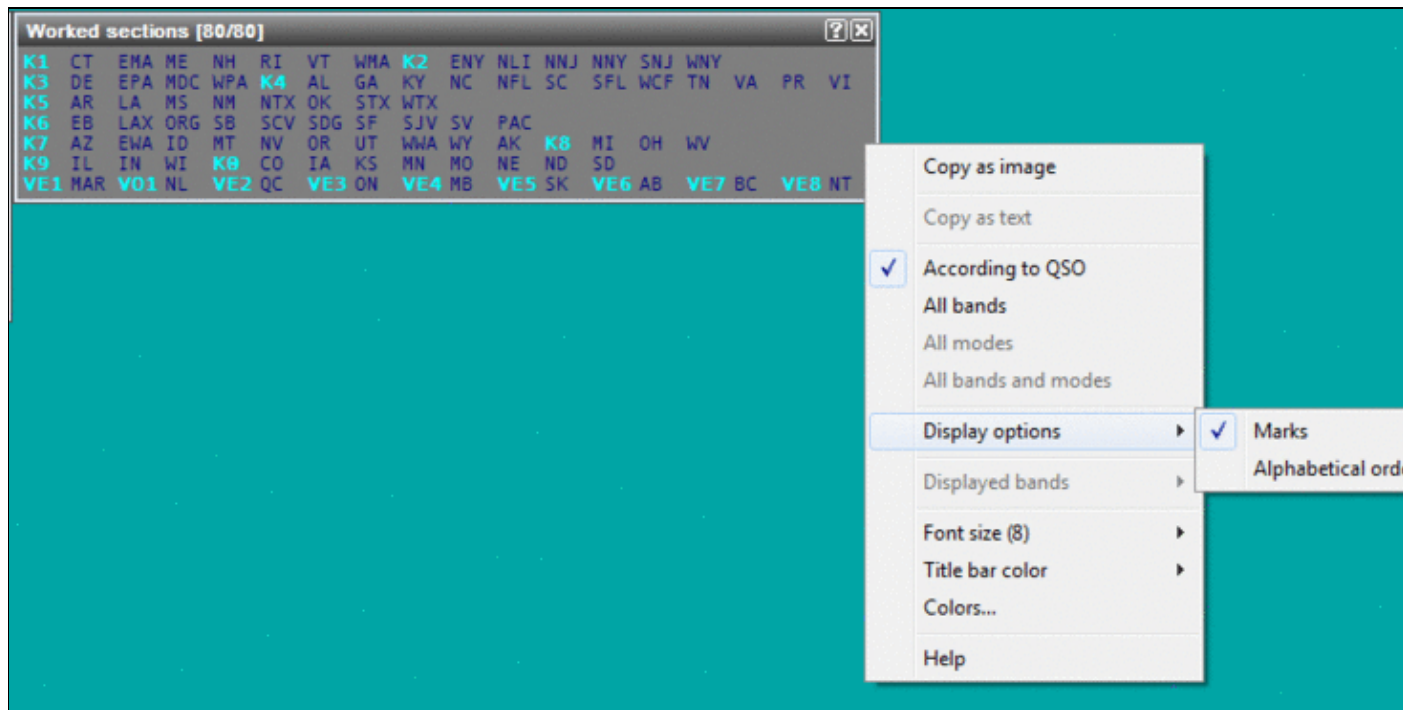

Size of this preview: [800 × 368 pixels](#). Other resolutions: [320 × 147 pixels](#) | [903 × 415 pixels](#).  
[Original file](#) (903 × 415 pixels, file size: 24 KB, MIME type: image.gif)

ARRL Sweepstakes Section List, display by call district

## File history

Click on a date/time to view the file as it appeared at that time.

	Date/Time	Thumbnail	Dimensions	User	Comment
current	<a href="#">07:21, 5 November 2010</a>		903 × 415 (24 KB)	<a href="#">N6TV</a> ( <a href="#">talk</a>   <a href="#">contribs</a> )	ARRL Sweepstakes Section List, display by call district

You cannot overwrite this file.

## File usage

The following page uses this file:

File:ARRLSweepstakesSectionList.gif

- [Sweepstakes](#)

## Namespaces

- [File](#)
- [Discussion](#)

## Variants

## Views

- [Read](#)
- [View source](#)
- [View history](#)

## More

- This page was last edited on 5 November 2010, at 07:21.

- [Privacy policy](#)
- [About Win-Test Wiki](#)
- [Disclaimers](#)



# File:AutomaticBackup.PNG

From Win-Test Wiki

[Jump to navigation](#) [Jump to search](#)

- [File](#)
- [File history](#)
- [File usage](#)

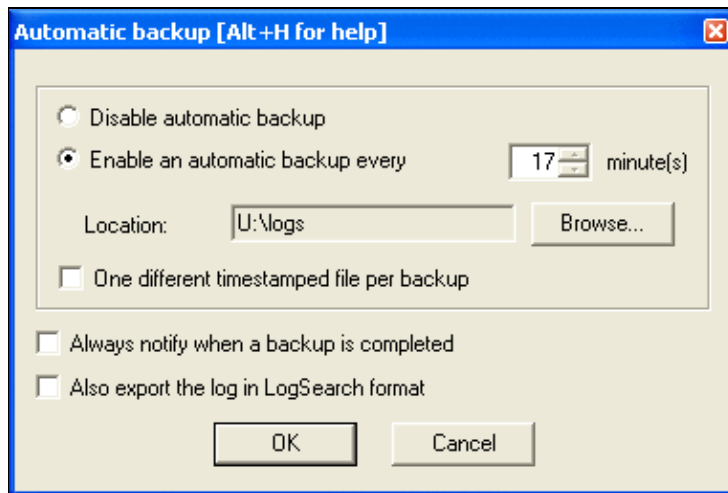

No higher resolution available.

[AutomaticBackup.PNG](#) (381 × 255 pixels, file size: 9 KB, MIME type: image/gif)

## File history

Click on a date/time to view the file as it appeared at that time.

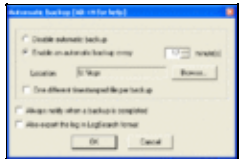
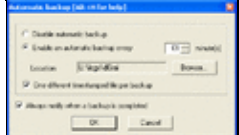
	Date/Time	Thumbnail	Dimensions	User	Comment
current	<a href="#">21:17, 3 June 2008</a>		381 × 255 (9 KB)	<a href="#">Dl6rai</a> ( <a href="#">talk</a>   <a href="#">contribs</a> )	
	<a href="#">05:10, 20 May 2007</a>		381 × 230 (8 KB)	<a href="#">Dl6rai</a> ( <a href="#">talk</a>   <a href="#">contribs</a> )	

You cannot overwrite this file.

## File usage

The following page uses this file:

- [Menu:Options](#)

## Namespaces

- [File](#)
- [Discussion](#)

## Variants

## Views

- [Read](#)
- [View source](#)
- [View history](#)

## More

- This page was last edited on 20 May 2007, at 05:10.
- [Privacy policy](#)
- [About Win-Test Wiki](#)
- [Disclaimers](#)



# File:AutomaticBackup.PNG

From Win-Test Wiki

[Jump to navigation](#) [Jump to search](#)

- [File](#)
- [File history](#)
- [File usage](#)

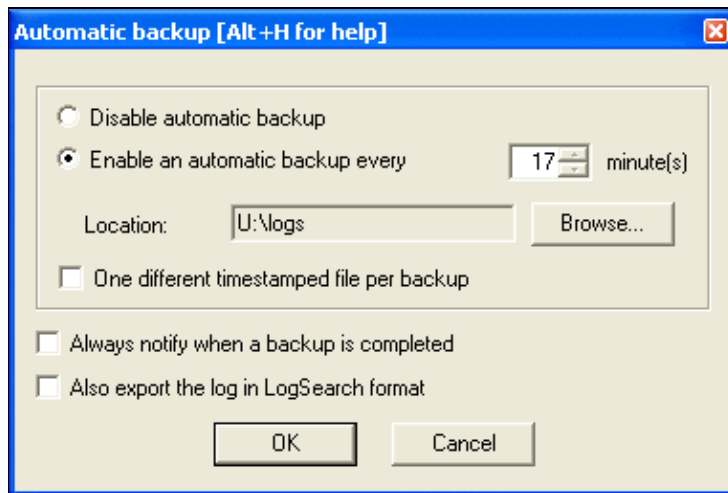

No higher resolution available.

[AutomaticBackup.PNG](#) (381 × 255 pixels, file size: 9 KB, MIME type: image/gif)

## File history

Click on a date/time to view the file as it appeared at that time.

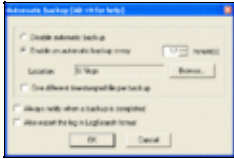
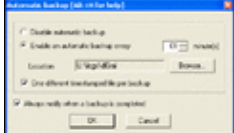
	Date/Time	Thumbnail	Dimensions	User	Comment
current	<a href="#">21:17, 3 June 2008</a>		381 × 255 (9 KB)	<a href="#">Dl6rai</a> ( <a href="#">talk</a>   <a href="#">contribs</a> )	
	<a href="#">05:10, 20 May 2007</a>		381 × 230 (8 KB)	<a href="#">Dl6rai</a> ( <a href="#">talk</a>   <a href="#">contribs</a> )	

You cannot overwrite this file.

## File usage

The following page uses this file:

- [Menu:Options](#)

## Namespaces

- [File](#)
- [Discussion](#)

## Variants

## Views

- [Read](#)
- [View source](#)
- [View history](#)

## More

- This page was last edited on 20 May 2007, at 05:10.
- [Privacy policy](#)
- [About Win-Test Wiki](#)
- [Disclaimers](#)



# File:BandmapExcGuessEnable.gif

From Win-Test Wiki

[Jump to navigation](#) [Jump to search](#)

- [File](#)
- [File history](#)
- [File usage](#)

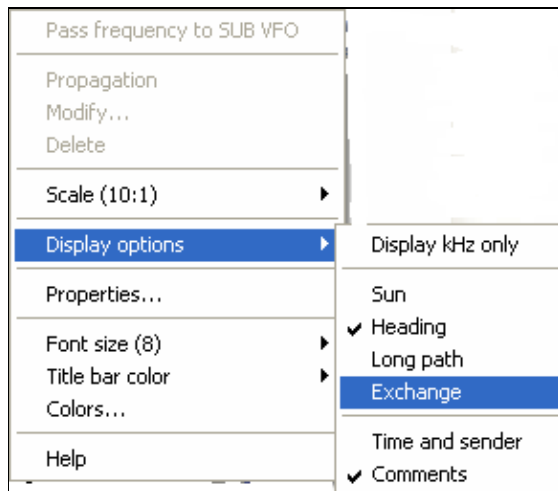

No higher resolution available.

[BandmapExcGuessEnable.gif](#) (290 × 254 pixels, file size: 7 KB, MIME type: image/gif)

## File history

Click on a date/time to view the file as it appeared at that time.

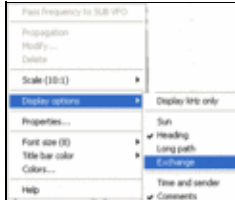
Date/Time	Thumbnail	Dimensions	User	Comment
current <a href="#">10:12, 23 January 2007</a>		290 × 254 (7 KB)	<a href="#">I2WIJ</a> ( <a href="#">talk</a>   <a href="#">contribs</a> )	

You cannot overwrite this file.

## File usage

The following page uses this file:

- [Database Files](#)



## Namespaces

- [File](#)
- [Discussion](#)

## Variants

## Views

- [Read](#)
- [View source](#)
- [View history](#)

## More

- This page was last edited on 23 January 2007, at 10:12.
- [Privacy policy](#)
- [About Win-Test Wiki](#)
- [Disclaimers](#)



# File:BandmapExcGuessEnable.gif

From Win-Test Wiki

[Jump to navigation](#) [Jump to search](#)

- [File](#)
- [File history](#)
- [File usage](#)

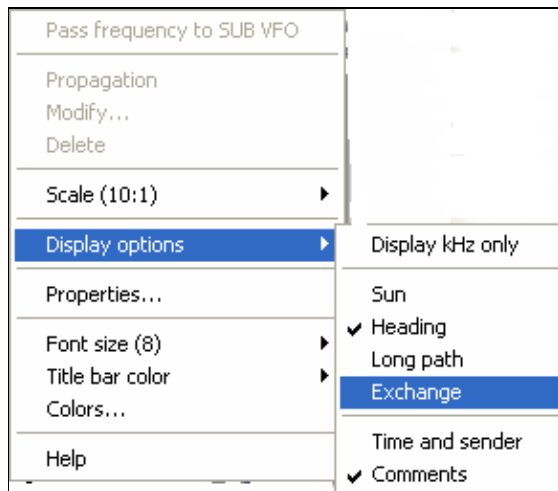

No higher resolution available.

[BandmapExcGuessEnable.gif](#) (290 × 254 pixels, file size: 7 KB, MIME type: image.gif)

## File history

Click on a date/time to view the file as it appeared at that time.

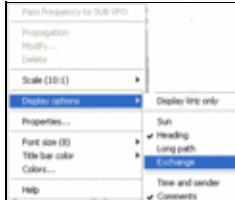
Date/Time	Thumbnail	Dimensions	User	Comment
current <a href="#">10:12, 23 January 2007</a>		290 × 254 (7 KB)	<a href="#">I2WIJ</a> ( <a href="#">talk</a>   <a href="#">contribs</a> )	

You cannot overwrite this file.

## File usage

The following page uses this file:

- [Database Files](#)

## Namespaces

- [File](#)
- [Discussion](#)

## Variants

## Views

- [Read](#)
- [View source](#)
- [View history](#)

## More

- This page was last edited on 23 January 2007, at 10:12.
- [Privacy policy](#)
- [About Win-Test Wiki](#)
- [Disclaimers](#)



# File:BandMapMarkerSegment.gif

From Win-Test Wiki

[Jump to navigation](#) [Jump to search](#)

- [File](#)
- [File history](#)
- [File usage](#)

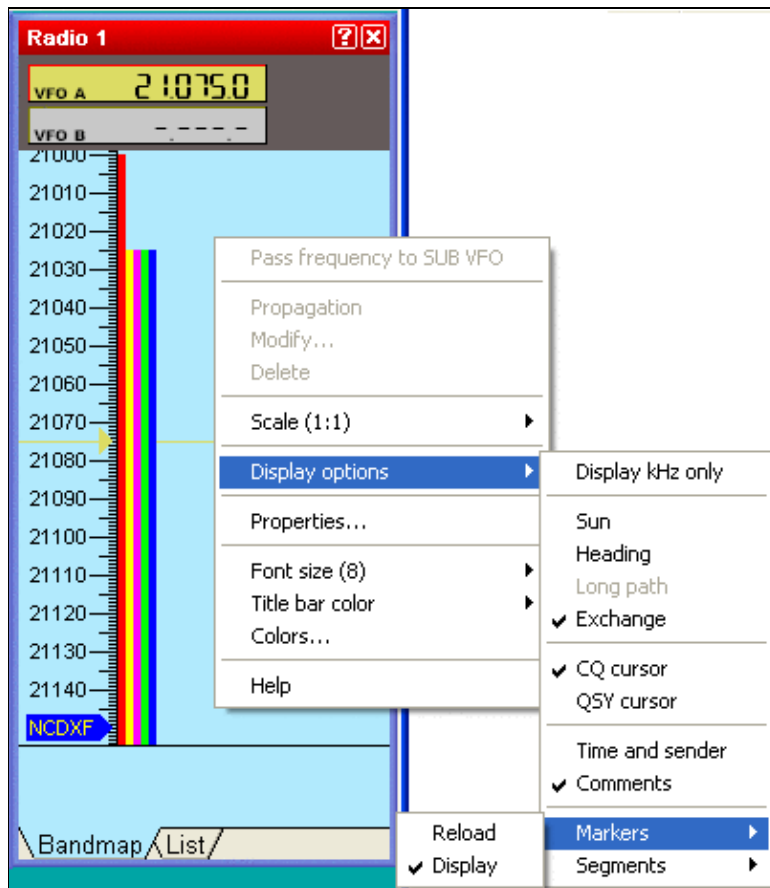

No higher resolution available.

[BandMapMarkerSegment.gif](#) (403 × 462 pixels, file size: 17 KB, MIME type: image/gif)

## File history

Click on a date/time to view the file as it appeared at that time.

	Date/Time	Thumbnail	Dimensions	User	Comment
current	<a href="#">14:09, 23 March 2007</a>		403 × 462 (17 KB)	<a href="#">I2WIJ</a> ( <a href="#">talk</a>   <a href="#">contribs</a> )	

You cannot overwrite this file.

## File usage

The following page uses this file:

- [Menu:Windows](#)

## Namespaces

- [File](#)
- [Discussion](#)

## Variants

## Views

- [Read](#)
- [View source](#)
- [View history](#)

## More

- This page was last edited on 23 March 2007, at 14:09.

- [Privacy policy](#)
- [About Win-Test Wiki](#)
- [Disclaimers](#)



# File:BandMapMarkerSegment.gif

From Win-Test Wiki

[Jump to navigation](#) [Jump to search](#)

- [File](#)
- [File history](#)
- [File usage](#)

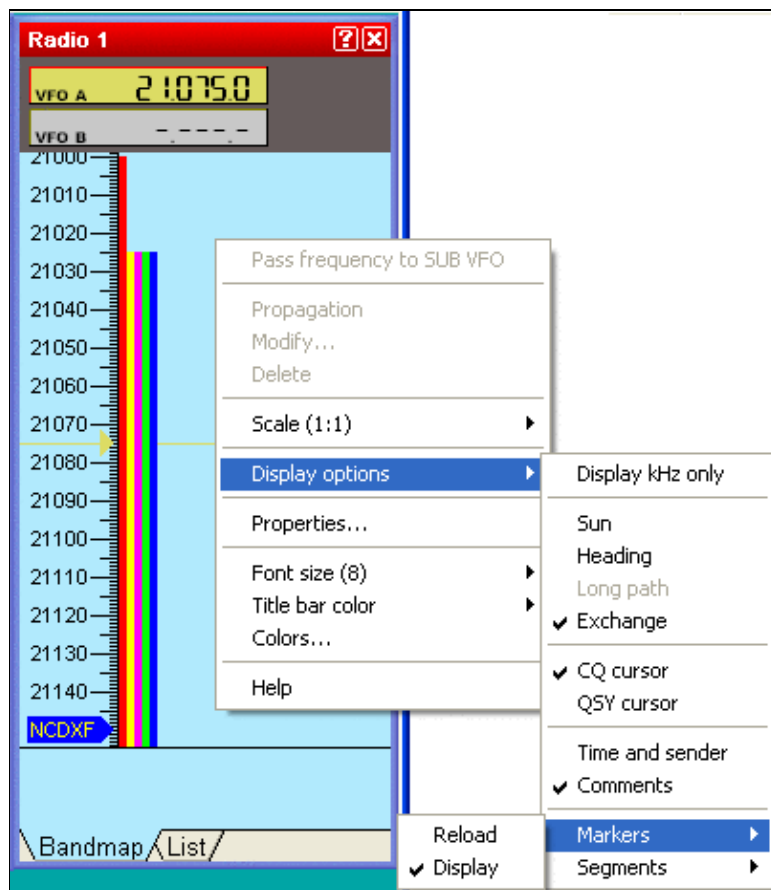

No higher resolution available.

[BandMapMarkerSegment.gif](#) (403 × 462 pixels, file size: 17 KB, MIME type: image/gif)

## File history

Click on a date/time to view the file as it appeared at that time.

	Date/Time	Thumbnail	Dimensions	User	Comment
current	<a href="#">14:09, 23 March 2007</a>		403 × 462 (17 KB)	<a href="#">I2WIJ</a> ( <a href="#">talk</a>   <a href="#">contribs</a> )	

You cannot overwrite this file.

## File usage

The following page uses this file:

- [Menu:Windows](#)

## Namespaces

- [File](#)
- [Discussion](#)

## Variants

## Views

- [Read](#)
- [View source](#)
- [View history](#)

## More

- This page was last edited on 23 March 2007, at 14:09.
- [Privacy policy](#)
- [About Win-Test Wiki](#)
- [Disclaimers](#)



# File:BandMapProperties.gif

From Win-Test Wiki

[Jump to navigation](#) [Jump to search](#)

- [File](#)
- [File history](#)
- [File usage](#)

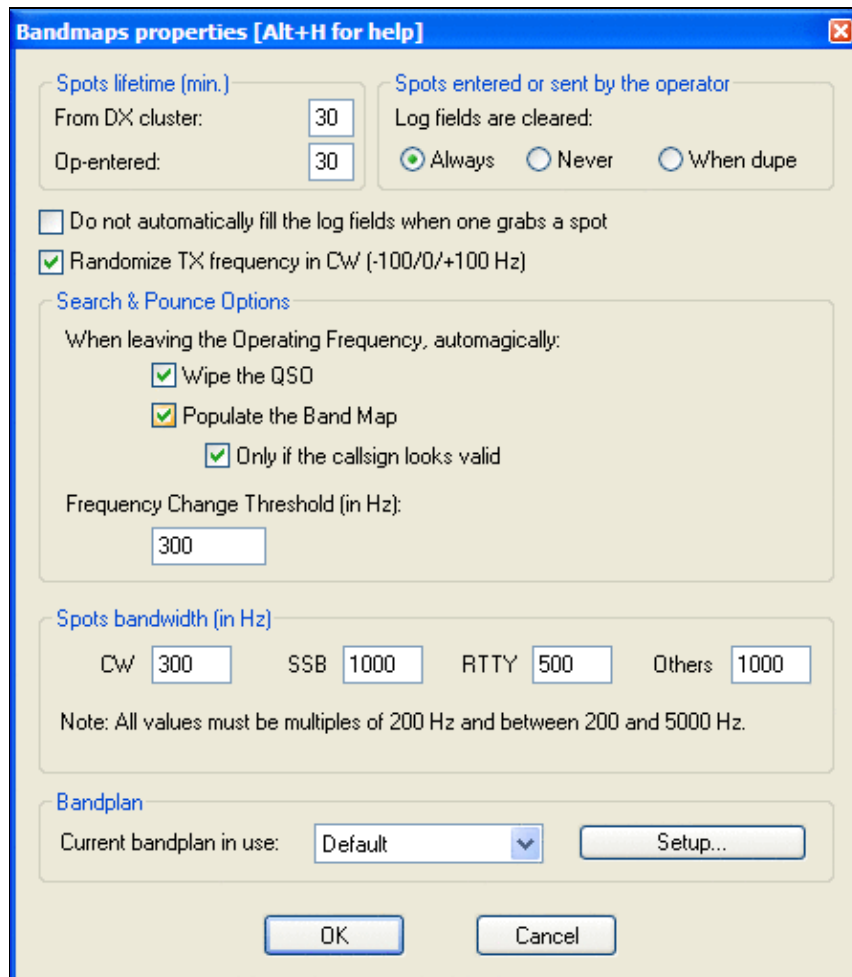





No higher resolution available.

[BandMapProperties.gif](#) (446 × 510 pixels, file size: 21 KB, MIME type: image.gif)

## File history

Click on a date/time to view the file as it appeared at that time.

	Date/Time	Thumbnail	Dimensions	User	Comment
current	<a href="#">04:26, 26 July 2010</a>		446 × 510 (21 KB)	<a href="#">N6TV (talk   contribs)</a>	WT 4 Version of Bandmap Properties dialog, with random offset feature.
	<a href="#">20:15, 26 July 2007</a>		446 × 480 (16 KB)	<a href="#">Dl6rai (talk   contribs)</a>	

You cannot overwrite this file.

## File usage

The following page uses this file:

- [Menu:Windows](#)

## Namespaces

- [File](#)
- [Discussion](#)

## Variants

## Views

- [Read](#)
- [View source](#)
- [View history](#)

## More

- This page was last edited on 26 July 2007, at 20:15.
- [Privacy policy](#)
- [About Win-Test Wiki](#)

- Disclaimers



# File:BandMapProperties.gif

From Win-Test Wiki

[Jump to navigation](#) [Jump to search](#)

- [File](#)
- [File history](#)
- [File usage](#)

The screenshot shows the 'Bandmaps properties' dialog box with the following settings:

- Spots lifetime (min.):** From DX cluster: 30, Op-entered: 30
- Spots entered or sent by the operator:** Log fields are cleared:  Always,  Never,  When dupe
- Do not automatically fill the log fields when one grabs a spot
- Randomize TX frequency in CW (-100/0/+100 Hz)
- Search & Pounce Options:** When leaving the Operating Frequency, automatically:
  - Wipe the QSO
  - Populate the Band Map
    - Only if the callsign looks valid
- Frequency Change Threshold (in Hz):** 300
- Spots bandwidth (in Hz):** CW: 300, SSB: 1000, RTTY: 500, Others: 1000
- Note: All values must be multiples of 200 Hz and between 200 and 5000 Hz.
- Bandplan:** Current bandplan in use: Default (dropdown), Setup... (button)



Buttons: OK, Cancel

No higher resolution available.

[BandMapProperties.gif](#) (446 × 510 pixels, file size: 21 KB, MIME type: image.gif)

## File history

Click on a date/time to view the file as it appeared at that time.

	Date/Time	Thumbnail	Dimensions	User	Comment
current	<a href="#">04:26, 26 July 2010</a>		446 × 510 (21 KB)	<a href="#">N6TV (talk   contribs)</a>	WT 4 Version of Bandmap Properties dialog, with random offset feature.
	<a href="#">20:15, 26 July 2007</a>		446 × 480 (16 KB)	<a href="#">Dl6rai (talk   contribs)</a>	

You cannot overwrite this file.

## File usage

The following page uses this file:

- [Menu:Windows](#)

## Namespaces

- [File](#)
- [Discussion](#)

## Variants

## Views

- [Read](#)
- [View source](#)
- [View history](#)

## More

- This page was last edited on 26 July 2007, at 20:15.
- [Privacy policy](#)
- [About Win-Test Wiki](#)

- Disclaimers



# File:Bandplans.gif

From Win-Test Wiki

[Jump to navigation](#) [Jump to search](#)

- [File](#)
- [File history](#)
- [File usage](#)

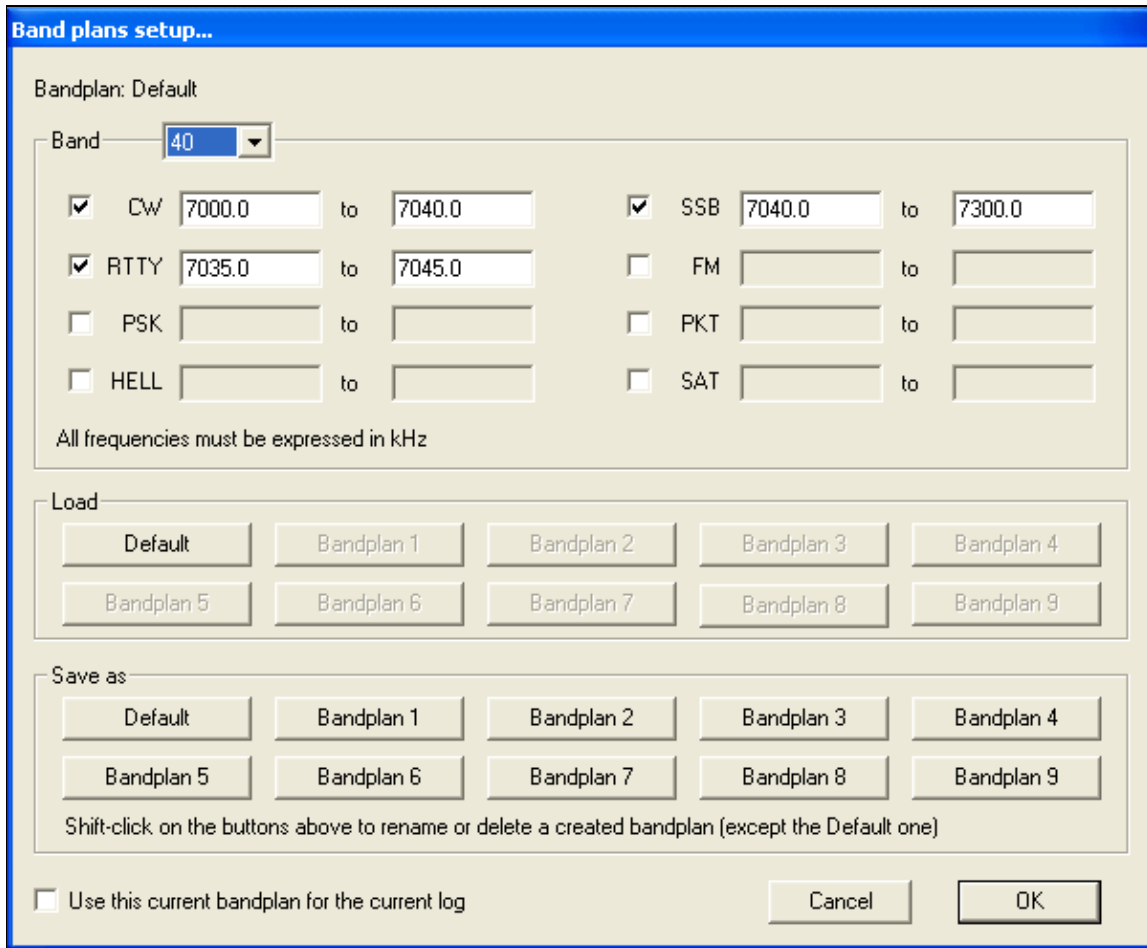

No higher resolution available.

[Bandplans.gif](#) (600 × 494 pixels, file size: 11 KB, MIME type: image.gif)

## File history

Click on a date/time to view the file as it appeared at that time.

	Date/Time	Thumbnail	Dimensions	User	Comment
current	<a href="#">23:11, 15 September 2006</a>		600 × 494 (11 KB)	<a href="#">Dl6rai</a> ( <a href="#">talk</a>   <a href="#">contribs</a> )	

You cannot overwrite this file.

## File usage

The following page uses this file:

- [Menu:Options](#)

## Namespaces

- [File](#)
- [Discussion](#)

## Variants

## Views

- [Read](#)
- [View source](#)
- [View history](#)

## More

- This page was last edited on 15 September 2006, at 23:11.
- [Privacy policy](#)
- [About Win-Test Wiki](#)
- [Disclaimers](#)



# File:Bandplans.gif

From Win-Test Wiki

[Jump to navigation](#) [Jump to search](#)

- [File](#)
- [File history](#)
- [File usage](#)

**Band plans setup...**

Bandplan: Default

Band: 40

<input checked="" type="checkbox"/> CW	7000.0	to	7040.0	<input checked="" type="checkbox"/> SSB	7040.0	to	7300.0
<input checked="" type="checkbox"/> RTTY	7035.0	to	7045.0	<input type="checkbox"/> FM		to	
<input type="checkbox"/> PSK		to		<input type="checkbox"/> PKT		to	
<input type="checkbox"/> HELL		to		<input type="checkbox"/> SAT		to	

All frequencies must be expressed in kHz

Load

Default	Bandplan 1	Bandplan 2	Bandplan 3	Bandplan 4
Bandplan 5	Bandplan 6	Bandplan 7	Bandplan 8	Bandplan 9

Save as

Default	Bandplan 1	Bandplan 2	Bandplan 3	Bandplan 4
Bandplan 5	Bandplan 6	Bandplan 7	Bandplan 8	Bandplan 9

Shift-click on the buttons above to rename or delete a created bandplan (except the Default one)

Use this current bandplan for the current log

Cancel OK



No higher resolution available.

[Bandplans.gif](#) (600 × 494 pixels, file size: 11 KB, MIME type: image.gif)

## File history

Click on a date/time to view the file as it appeared at that time.

	Date/Time	Thumbnail	Dimensions	User	Comment
current	<a href="#">23:11, 15 September 2006</a>		600 × 494 (11 KB)	<a href="#">Dl6rai</a> ( <a href="#">talk</a>   <a href="#">contribs</a> )	

You cannot overwrite this file.

## File usage

The following page uses this file:

- [Menu:Options](#)

## Namespaces

- [File](#)
- [Discussion](#)

## Variants

## Views

- [Read](#)
- [View source](#)
- [View history](#)

## More

- This page was last edited on 15 September 2006, at 23:11.
- [Privacy policy](#)
- [About Win-Test Wiki](#)
- [Disclaimers](#)



# File:BestPractice42.gif

From Win-Test Wiki

[Jump to navigation](#) [Jump to search](#)

- [File](#)
- [File history](#)
- [File usage](#)

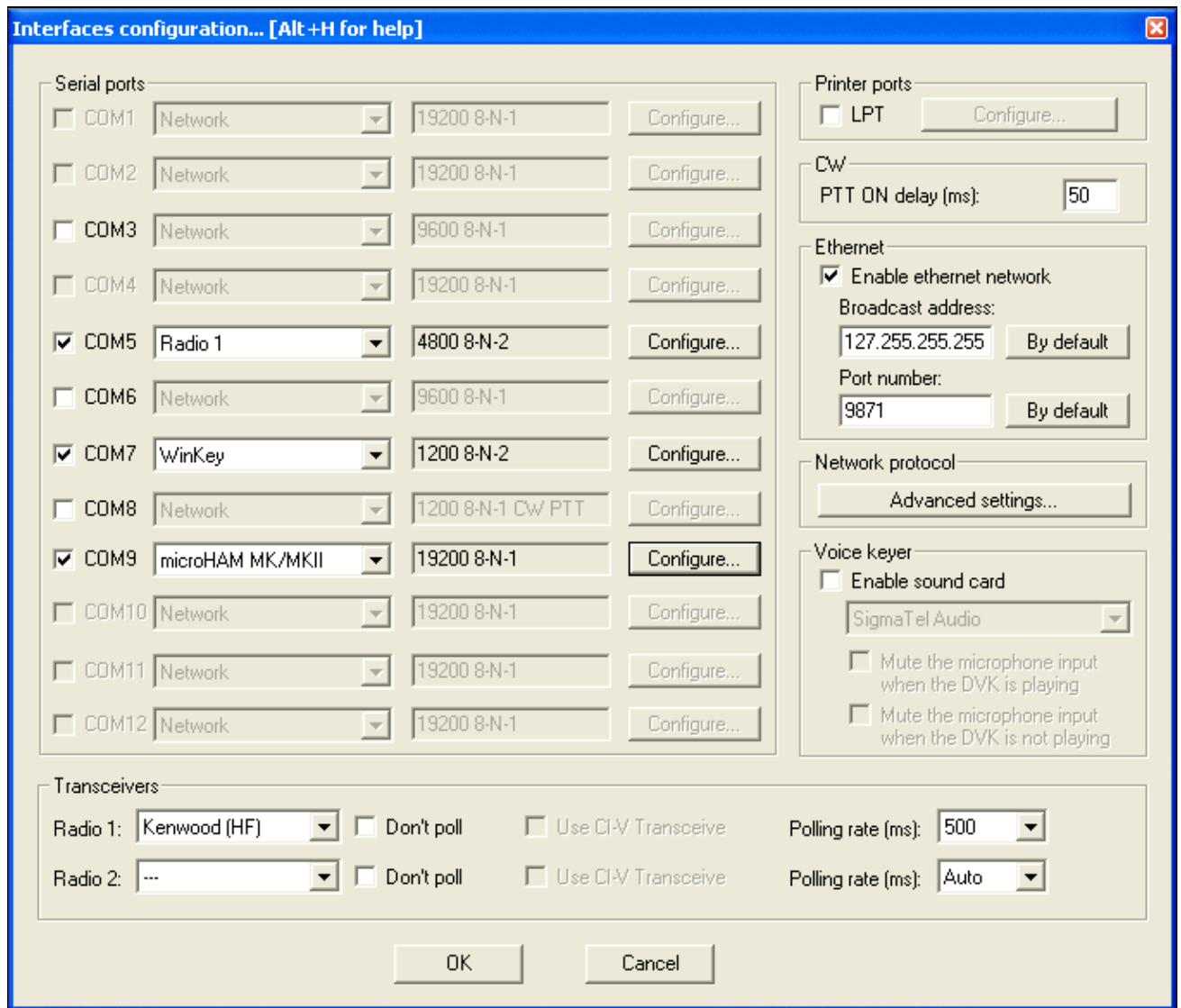



No higher resolution available.

[BestPractice42.gif](#) (678 Å 583 pixels, file size: 35 KB, MIME type: image.gif)

## File history

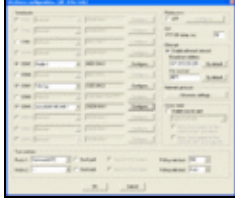
Click on a date/time to view the file as it appeared at that time.

	Date/Time	Thumbnail	Dimensions	User	Comment
current	<a href="#">08:05, 18 November 2007</a>		678 Å 583 (35 KB)	<a href="#">Dl6rai</a> ( <a href="#">talk</a>   <a href="#">contribs</a> )	
	<a href="#">09:55, 9 September 2007</a>		800 Å 600 (49 KB)	<a href="#">Dl6rai</a> ( <a href="#">talk</a>   <a href="#">contribs</a> )	

You cannot overwrite this file.

## File usage

The following 3 pages use this file:

- [BestPractice4](#)
- [BestPractice5](#)
- [BestPractice6](#)

## Namespaces

- [File](#)
- [Discussion](#)

## Variants

## Views

- [Read](#)
- [View source](#)
- [View history](#)

## More

- This page was last edited on 9 September 2007, at 09:55.
- [Privacy policy](#)
- [About Win-Test Wiki](#)

- Disclaimers



# File:BestPractice42.gif

From Win-Test Wiki

[Jump to navigation](#) [Jump to search](#)

- [File](#)
- [File history](#)
- [File usage](#)

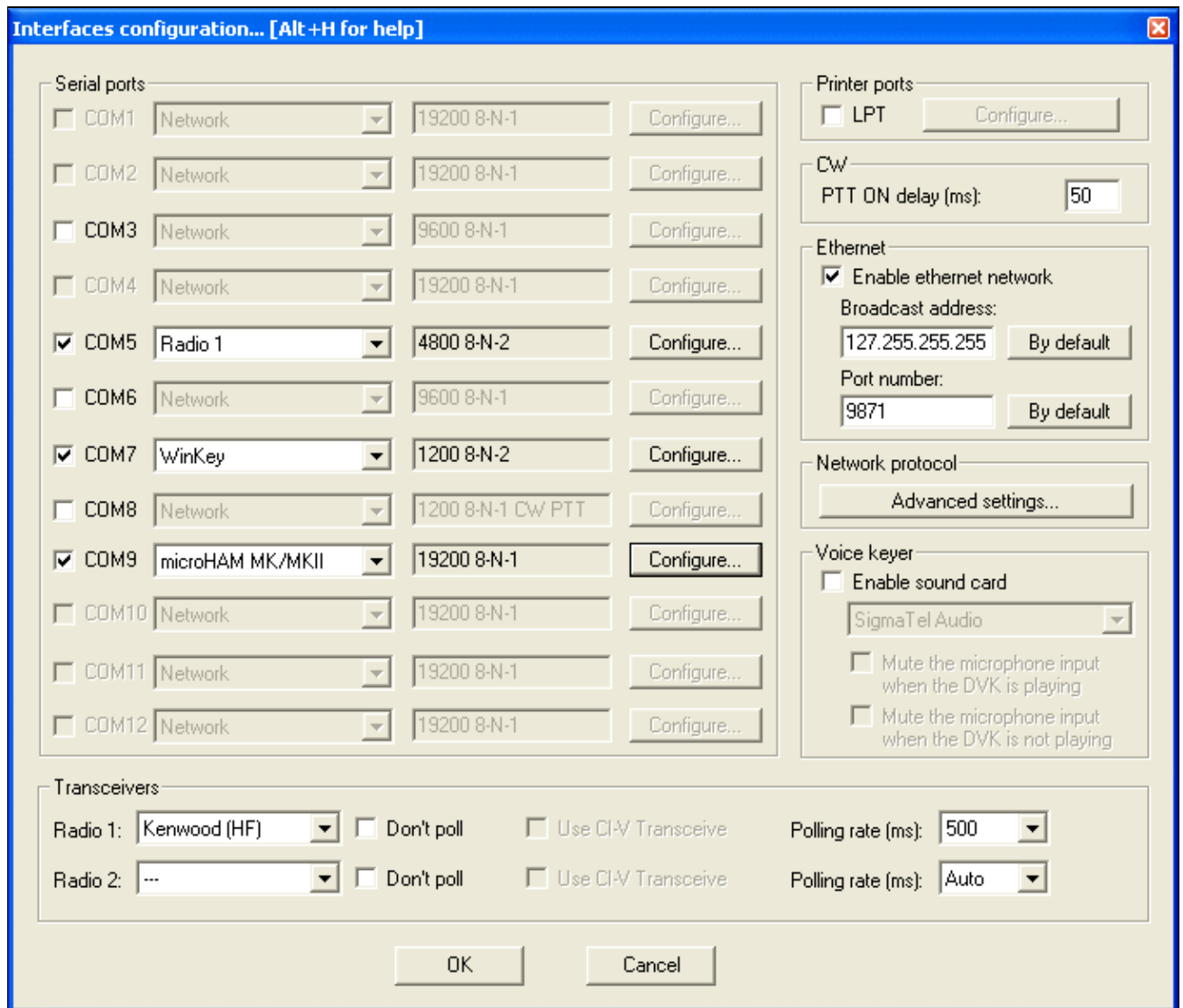



No higher resolution available.

[BestPractice42.gif](#) (678 Å 583 pixels, file size: 35 KB, MIME type: image.gif)

## File history

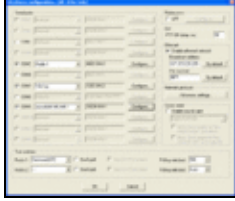
Click on a date/time to view the file as it appeared at that time.

	Date/Time	Thumbnail	Dimensions	User	Comment
current	<a href="#">08:05, 18 November 2007</a>		678 Å 583 (35 KB)	<a href="#">Dl6rai</a> ( <a href="#">talk</a>   <a href="#">contribs</a> )	
	<a href="#">09:55, 9 September 2007</a>		800 Å 600 (49 KB)	<a href="#">Dl6rai</a> ( <a href="#">talk</a>   <a href="#">contribs</a> )	

You cannot overwrite this file.

## File usage

The following 3 pages use this file:

- [BestPractice4](#)
- [BestPractice5](#)
- [BestPractice6](#)

## Namespaces

- [File](#)
- [Discussion](#)

## Variants

## Views

- [Read](#)
- [View source](#)
- [View history](#)

## More

- This page was last edited on 9 September 2007, at 09:55.
- [Privacy policy](#)
- [About Win-Test Wiki](#)

- Disclaimers



# File:BestPractice71.gif

From Win-Test Wiki

[Jump to navigation](#) [Jump to search](#)

- [File](#)
- [File history](#)
- [File usage](#)
- [Metadata](#)

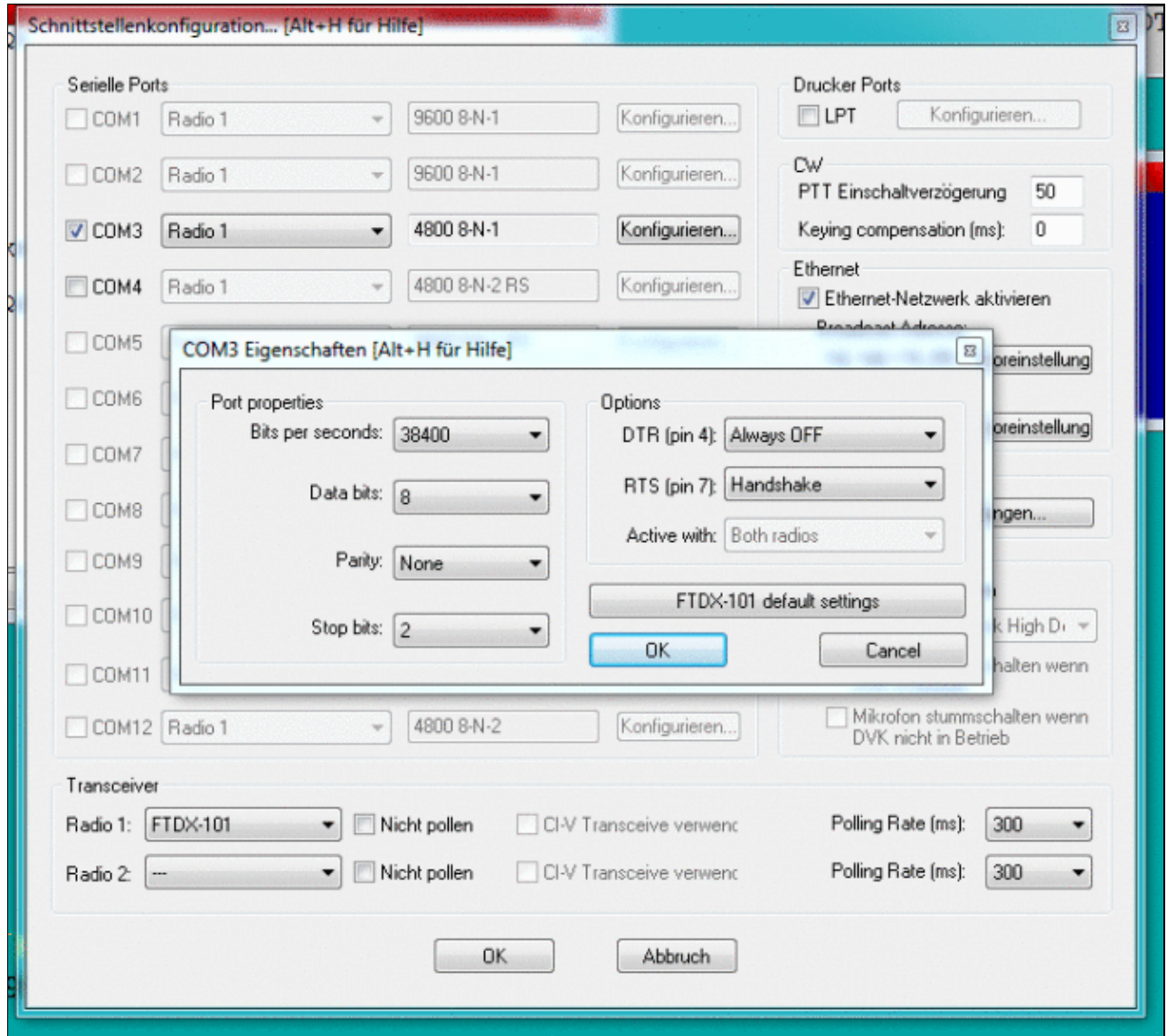





Size of this preview: 668 Å 599 pixels. Other resolutions: 267 Å 240 pixels | 702 Å 630 pixels.  
[Original file](#) (702 Å 630 pixels, file size: 70 KB, MIME type: image.gif)

## File history

Click on a date/time to view the file as it appeared at that time.

	Date/Time	Thumbnail	Dimensions	User	Comment
current	<u>13:57, 6 June 2020</u>		702 Å 630 (70 KB)	<a href="#">Dl6rai</a> ( <a href="#">talk</a>   <a href="#">contribs</a> )	
	<u>10:12, 8 February 2020</u>		702 Å 630 (72 KB)	<a href="#">Dl6rai</a> ( <a href="#">talk</a>   <a href="#">contribs</a> )	

You cannot overwrite this file.

## File usage

The following page uses this file:

- [BestPractice7](#)

## Metadata

This file contains additional information, probably added from the digital camera or scanner used to create or digitize it.

If the file has been modified from its original state, some details may not fully reflect the modified file.

**Horizontal resolution** 37.8 dpc

**Vertical resolution** 37.8 dpc

## Namespaces

- [File](#)
- [Discussion](#)

## Variants

## Views

- [Read](#)

- [View source](#)
- [View history](#)

## More

- This page was last edited on 6 June 2020, at 13:57.

- [Privacy policy](#)
- [About Win-Test Wiki](#)
- [Disclaimers](#)



# File:BestPractice71.gif

From Win-Test Wiki

[Jump to navigation](#) [Jump to search](#)

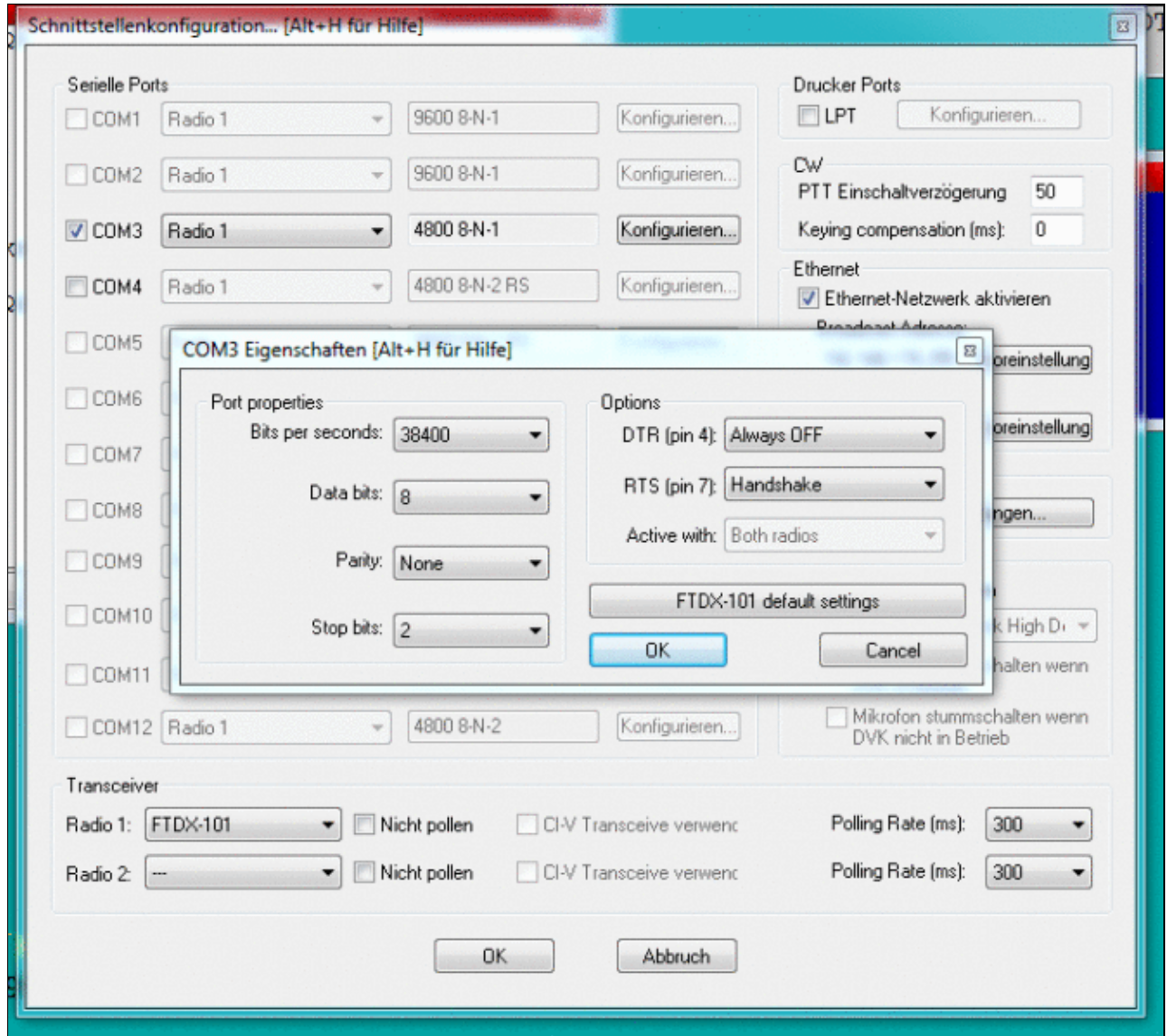

- [File](#)
- [File history](#)
- [File usage](#)
- [Metadata](#)



Size of this preview: 668 Å 599 pixels. Other resolutions: 267 Å 240 pixels | 702 Å 630 pixels.  
[Original file](#) (702 Å 630 pixels, file size: 70 KB, MIME type: image.gif)

## File history

Click on a date/time to view the file as it appeared at that time.

	Date/Time	Thumbnail	Dimensions	User	Comment
current	<u>13:57, 6 June 2020</u>		702 Å 630 (70 KB)	<a href="#">Dl6rai</a> ( <a href="#">talk</a>   <a href="#">contribs</a> )	
	<u>10:12, 8 February 2020</u>		702 Å 630 (72 KB)	<a href="#">Dl6rai</a> ( <a href="#">talk</a>   <a href="#">contribs</a> )	

You cannot overwrite this file.

## File usage

The following page uses this file:

- [BestPractice7](#)

## Metadata

This file contains additional information, probably added from the digital camera or scanner used to create or digitize it.

If the file has been modified from its original state, some details may not fully reflect the modified file.

**Horizontal resolution** 37.8 dpc

**Vertical resolution** 37.8 dpc

## Namespaces

- [File](#)
- [Discussion](#)

## Variants

## Views

- [Read](#)

- [View source](#)
- [View history](#)

## More

- This page was last edited on 6 June 2020, at 13:57.

- [Privacy policy](#)
- [About Win-Test Wiki](#)
- [Disclaimers](#)



# File:BestPractice82.gif

From Win-Test Wiki

[Jump to navigation](#) [Jump to search](#)

- [File](#)
- [File history](#)
- [File usage](#)
- [Metadata](#)

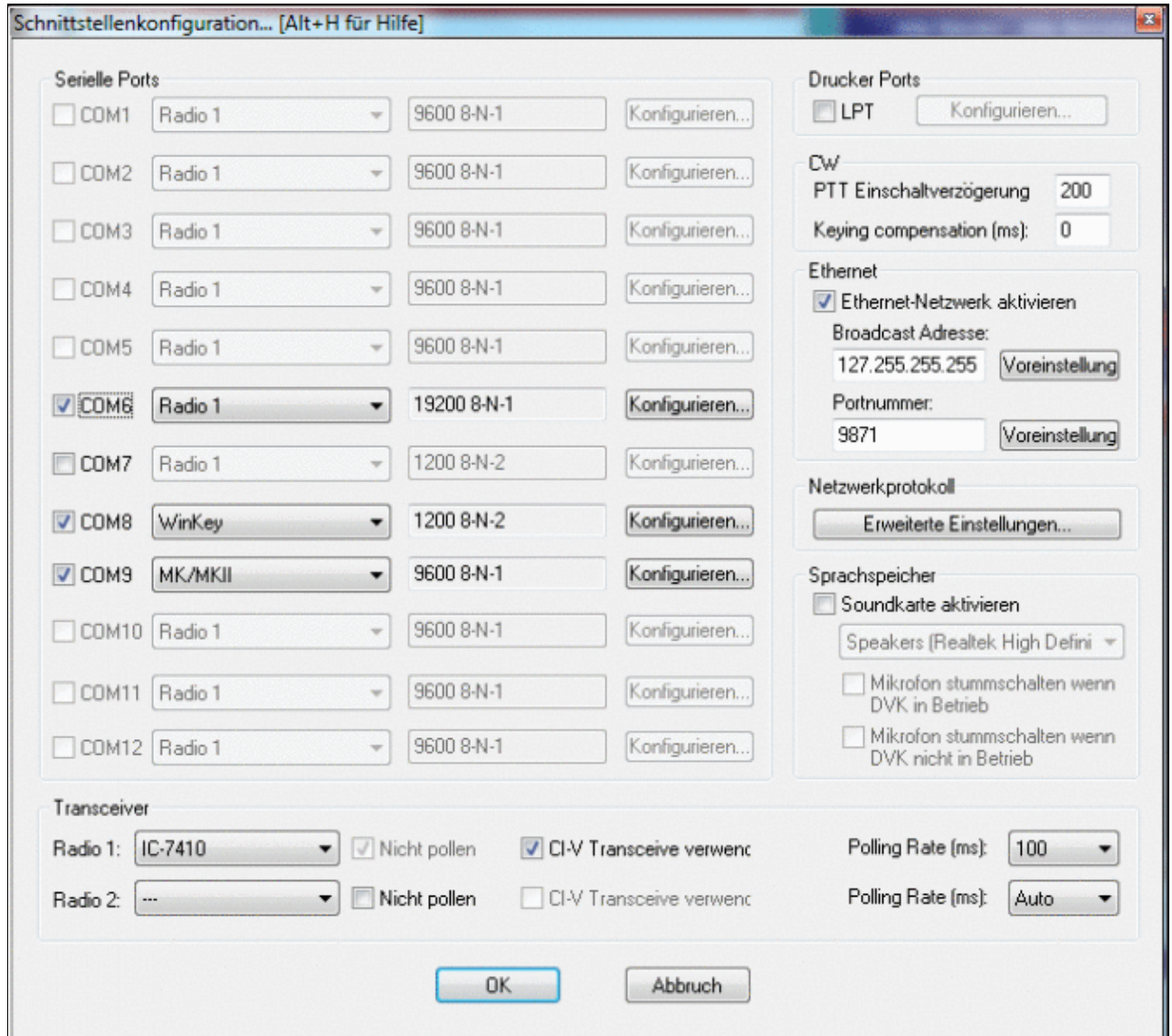

Size of this preview: 670 Å 600 pixels. Other resolutions: 268 Å 240 pixels | 678 Å 607 pixels.  
[Original file](#) (678 Å 607 pixels, file size: 52 KB, MIME type: image.gif)

## File history

Click on a date/time to view the file as it appeared at that time.

	Date/Time	Thumbnail	Dimensions	User	Comment
current	<u>15:48, 31 March 2020</u>		678 Å 607 (52 KB)	<a href="#">Dl6rai</a> ( <a href="#">talk</a>   <a href="#">contribs</a> )	

You cannot overwrite this file.

## File usage

The following 2 pages use this file:

- [BestPractice10](#)
- [BestPractice8](#)

## Metadata

This file contains additional information, probably added from the digital camera or scanner used to create or digitize it.

If the file has been modified from its original state, some details may not fully reflect the modified file.

**Horizontal resolution** 37.79 dpc

**Vertical resolution** 37.79 dpc

## Namespaces

- [File](#)
- [Discussion](#)

## Variants

## Views

- [Read](#)
- [View source](#)
- [View history](#)

## More

- This page was last edited on 31 March 2020, at 15:48.

- [Privacy policy](#)
- [About Win-Test Wiki](#)
- [Disclaimers](#)





# File:BestPractice82.gif

From Win-Test Wiki

[Jump to navigation](#) [Jump to search](#)

- [File](#)
- [File history](#)
- [File usage](#)
- [Metadata](#)

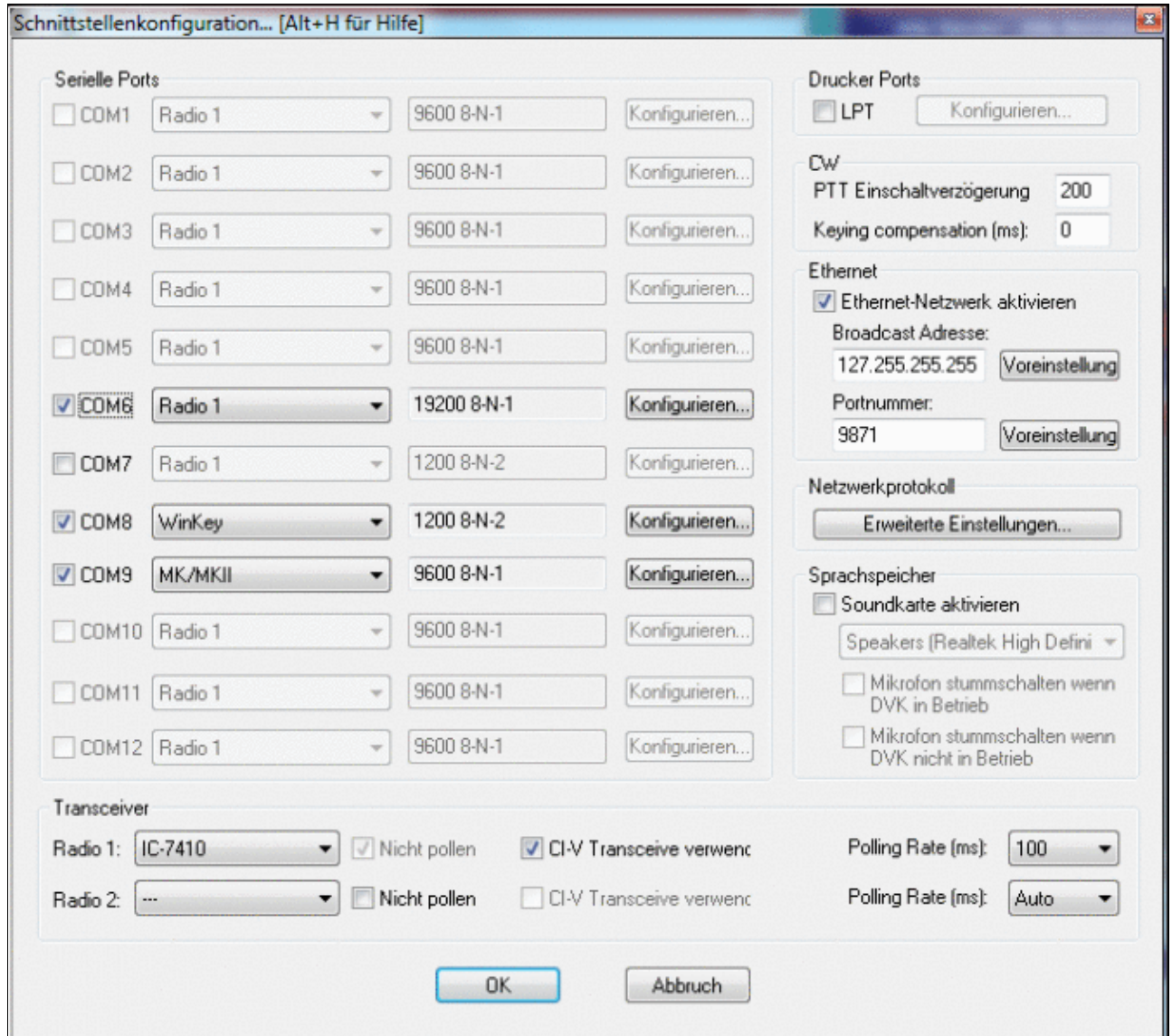

Size of this preview: 670 Å 600 pixels. Other resolutions: 268 Å 240 pixels | 678 Å 607 pixels.  
[Original file](#) (678 Å 607 pixels, file size: 52 KB, MIME type: image.gif)

## File history

Click on a date/time to view the file as it appeared at that time.

	Date/Time	Thumbnail	Dimensions	User	Comment
current	<u>15:48, 31 March 2020</u>		678 Å 607 (52 KB)	<a href="#">Dl6rai</a> ( <a href="#">talk</a>   <a href="#">contribs</a> )	

You cannot overwrite this file.

## File usage

The following 2 pages use this file:

- [BestPractice10](#)
- [BestPractice8](#)

## Metadata

This file contains additional information, probably added from the digital camera or scanner used to create or digitize it.

If the file has been modified from its original state, some details may not fully reflect the modified file.

**Horizontal resolution** 37.79 dpc

**Vertical resolution** 37.79 dpc

## Namespaces

- [File](#)
- [Discussion](#)

## Variants

## Views

- [Read](#)
- [View source](#)
- [View history](#)

## More

- This page was last edited on 31 March 2020, at 15:48.

- [Privacy policy](#)
- [About Win-Test Wiki](#)
- [Disclaimers](#)



# File:CallsignPatternRed.PNG

From Win-Test Wiki

[Jump to navigation](#) [Jump to search](#)

- [File](#)
- [File history](#)
- [File usage](#)

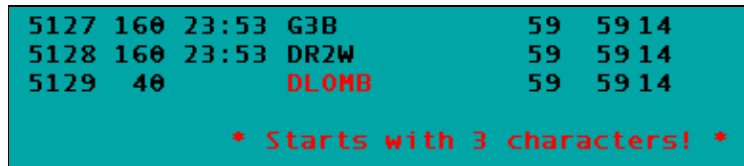

No higher resolution available.

[CallsignPatternRed.PNG](#) (389 × 85 pixels, file size: 3 KB, MIME type: image/gif)

## File history

Click on a date/time to view the file as it appeared at that time.

	Date/Time	Thumbnail	Dimensions	User	Comment
current	<a href="#">18:15, 4 October 2009</a>		389 × 85 (3 KB)	<a href="#">Dl6rai</a> ( <a href="#">talk</a>   <a href="#">contribs</a> )	

You cannot overwrite this file.

## File usage

The following page uses this file:

- [Menu:Tools](#)

## Namespaces

- [File](#)
- [Discussion](#)

## Variants

## Views

- [Read](#)
- [View source](#)
- [View history](#)

## More

- This page was last edited on 4 October 2009, at 18:15.

- [Privacy policy](#)
- [About Win-Test Wiki](#)
- [Disclaimers](#)



# File:CallsignPatternRed.PNG

From Win-Test Wiki

[Jump to navigation](#) [Jump to search](#)

- [File](#)
- [File history](#)
- [File usage](#)

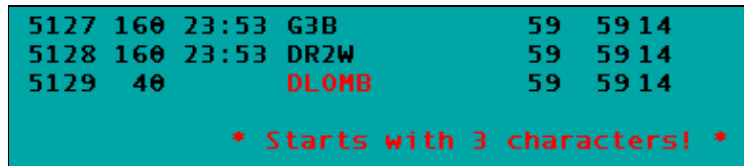

No higher resolution available.

[CallsignPatternRed.PNG](#) (389 × 85 pixels, file size: 3 KB, MIME type: image.gif)

## File history

Click on a date/time to view the file as it appeared at that time.

	Date/Time	Thumbnail	Dimensions	User	Comment
current	<a href="#">18:15, 4 October 2009</a>		389 × 85 (3 KB)	<a href="#">Dl6rai</a> ( <a href="#">talk</a>   <a href="#">contribs</a> )	

You cannot overwrite this file.

## File usage

The following page uses this file:

- [Menu:Tools](#)

## Namespaces

- [File](#)
- [Discussion](#)

## Variants

## Views

- [Read](#)
- [View source](#)
- [View history](#)

## More

- This page was last edited on 4 October 2009, at 18:15.

- [Privacy policy](#)
- [About Win-Test Wiki](#)
- [Disclaimers](#)



# File:CallsignPatternYellow.PNG

From Win-Test Wiki

[Jump to navigation](#) [Jump to search](#)

- [File](#)
- [File history](#)
- [File usage](#)

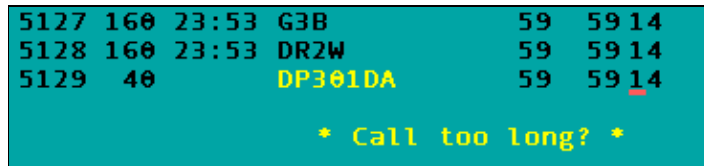

No higher resolution available.

[CallsignPatternYellow.PNG](#) (368 Å 85 pixels, file size: 2 KB, MIME type: image.gif)

## File history

Click on a date/time to view the file as it appeared at that time.

	Date/Time	Thumbnail	Dimensions	User	Comment
current	<a href="#">18:15, 4 October 2009</a>		368 Å 85 (2 KB)	<a href="#">Dl6rai</a> ( <a href="#">talk</a>   <a href="#">contribs</a> )	

You cannot overwrite this file.

## File usage

The following page uses this file:

- [Menu:Tools](#)

## Namespaces

- [File](#)
- [Discussion](#)

## Variants

## Views

- [Read](#)
- [View source](#)
- [View history](#)



## More

- This page was last edited on 4 October 2009, at 18:15.

- [Privacy policy](#)
- [About Win-Test Wiki](#)
- [Disclaimers](#)



# File:CallsignPatternYellow.PNG

From Win-Test Wiki

[Jump to navigation](#) [Jump to search](#)

- [File](#)
- [File history](#)
- [File usage](#)

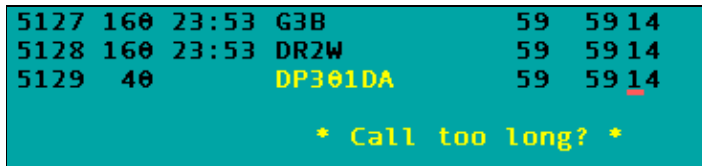

No higher resolution available.

[CallsignPatternYellow.PNG](#) (368 Å 85 pixels, file size: 2 KB, MIME type: image.gif)

## File history

Click on a date/time to view the file as it appeared at that time.

	Date/Time	Thumbnail	Dimensions	User	Comment
current	<a href="#">18:15, 4 October 2009</a>		368 Å 85 (2 KB)	<a href="#">Dl6rai</a> ( <a href="#">talk</a>   <a href="#">contribs</a> )	

You cannot overwrite this file.

## File usage

The following page uses this file:

- [Menu:Tools](#)

## Namespaces

- [File](#)
- [Discussion](#)

## Variants

## Views

- [Read](#)
- [View source](#)
- [View history](#)

## More

- This page was last edited on 4 October 2009, at 18:15.

- [Privacy policy](#)
- [About Win-Test Wiki](#)
- [Disclaimers](#)



# File:carrier.gif

From Win-Test Wiki

[Jump to navigation](#) [Jump to search](#)

- [File](#)
- [File history](#)
- [File usage](#)
- [Metadata](#)

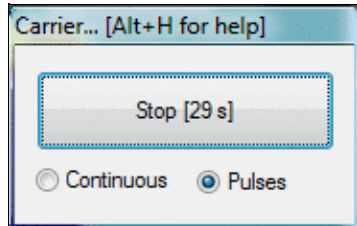

No higher resolution available.

[carrier.gif](#) (183 × 117 pixels, file size: 9 KB, MIME type: image.gif)

## File history

Click on a date/time to view the file as it appeared at that time.

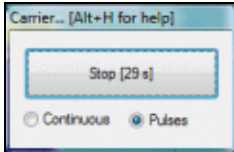
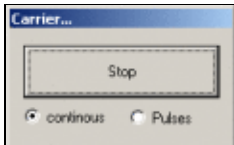
	Date/Time	Thumbnail	Dimensions	User	Comment
current	<a href="#">06:35, 10 April 2023</a>		183 × 117 (9 KB)	<a href="#">Dl6rai</a> ( <a href="#">talk</a>   <a href="#">contribs</a> )	
	<a href="#">21:13, 29 July 2006</a>		183 × 115 (2 KB)	<a href="#">DL4NER</a> ( <a href="#">talk</a>   <a href="#">contribs</a> )	

You cannot overwrite this file.

## File usage

The following page uses this file:

- [Menu:Commands](#)

## Metadata

This file contains additional information, probably added from the digital camera or scanner used to create or digitize it.

If the file has been modified from its original state, some details may not fully reflect the modified file.

**Horizontal resolution** 37.79 dpc

**Vertical resolution** 37.79 dpc

## Namespaces

- [File](#)
- [Discussion](#)

## Variants

## Views

- [Read](#)
- [View source](#)
- [View history](#)

## More

- This page was last edited on 10 April 2023, at 06:35.

- [Privacy policy](#)
- [About Win-Test Wiki](#)
- [Disclaimers](#)



# File:carrier.gif

From Win-Test Wiki

[Jump to navigation](#) [Jump to search](#)

- [File](#)
- [File history](#)
- [File usage](#)
- [Metadata](#)

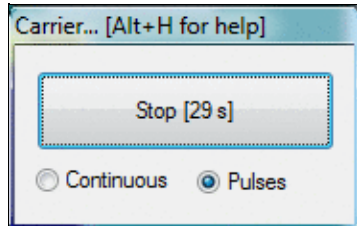

No higher resolution available.

[carrier.gif](#) (183 × 117 pixels, file size: 9 KB, MIME type: image.gif)

## File history

Click on a date/time to view the file as it appeared at that time.

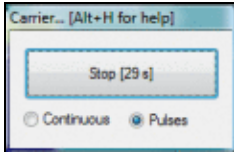
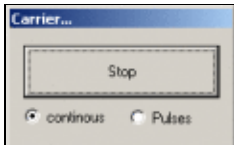
	Date/Time	Thumbnail	Dimensions	User	Comment
current	<a href="#">06:35, 10 April 2023</a>		183 × 117 (9 KB)	<a href="#">Dl6rai</a> ( <a href="#">talk</a>   <a href="#">contribs</a> )	
	<a href="#">21:13, 29 July 2006</a>		183 × 115 (2 KB)	<a href="#">DL4NER</a> ( <a href="#">talk</a>   <a href="#">contribs</a> )	

You cannot overwrite this file.

## File usage

The following page uses this file:

- [Menu:Commands](#)

## Metadata

This file contains additional information, probably added from the digital camera or scanner used to create or digitize it.

If the file has been modified from its original state, some details may not fully reflect the modified file.

**Horizontal resolution** 37.79 dpc

**Vertical resolution** 37.79 dpc

## Namespaces

- [File](#)
- [Discussion](#)

## Variants

## Views

- [Read](#)
- [View source](#)
- [View history](#)

## More

- This page was last edited on 10 April 2023, at 06:35.

- [Privacy policy](#)
- [About Win-Test Wiki](#)
- [Disclaimers](#)



# File:Checked report.gif

From Win-Test Wiki

[Jump to navigation](#) [Jump to search](#)

- [File](#)
- [File history](#)
- [File usage](#)
- [Metadata](#)

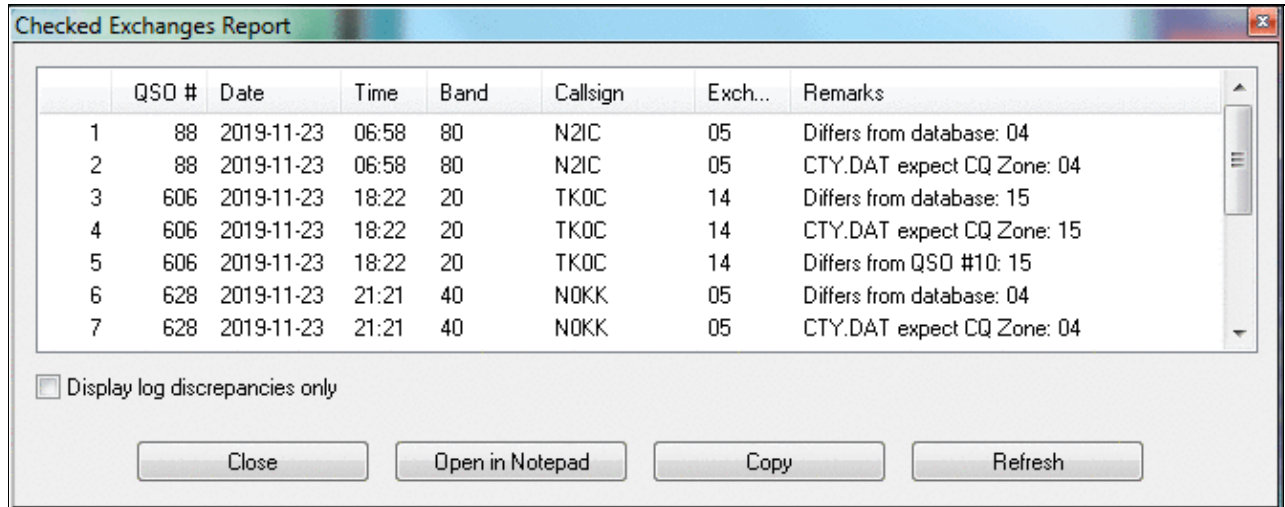

	QSO #	Date	Time	Band	Callsign	Exch...	Remarks
1	88	2019-11-23	06:58	80	N2IC	05	Differs from database: 04
2	88	2019-11-23	06:58	80	N2IC	05	CTY.DAT expect CQ Zone: 04
3	606	2019-11-23	18:22	20	TKOC	14	Differs from database: 15
4	606	2019-11-23	18:22	20	TKOC	14	CTY.DAT expect CQ Zone: 15
5	606	2019-11-23	18:22	20	TKOC	14	Differs from QSO #10: 15
6	628	2019-11-23	21:21	40	N0KK	05	Differs from database: 04
7	628	2019-11-23	21:21	40	N0KK	05	CTY.DAT expect CQ Zone: 04

No higher resolution available.

[Checked report.gif](#) (666 Å 265 pixels, file size: 26 KB, MIME type: image.gif)

## File history

Click on a date/time to view the file as it appeared at that time.

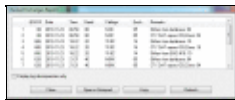
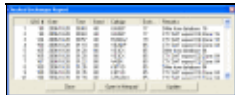
	Date/Time	Thumbnail	Dimensions	User	Comment
current	<a href="#">11:27, 4 April 2020</a>		666 Å 265 (26 KB)	<a href="#">D16rai</a> ( <a href="#">talk</a>   <a href="#">contribs</a> )	
	<a href="#">10:35, 14 March 2007</a>		585 Å 234 (19 KB)	<a href="#">I2WIJ</a> ( <a href="#">talk</a>   <a href="#">contribs</a> )	

You cannot overwrite this file.

## File usage

The following page uses this file:

- [Menu:Tools](#)



## Metadata

This file contains additional information, probably added from the digital camera or scanner used to create or digitize it.

If the file has been modified from its original state, some details may not fully reflect the modified file.

**Horizontal resolution** 37.79 dpc

**Vertical resolution** 37.79 dpc

## Namespaces

- [File](#)
- [Discussion](#)

## Variants

## Views

- [Read](#)
- [View source](#)
- [View history](#)

## More

- This page was last edited on 4 April 2020, at 11:27.

- [Privacy policy](#)
- [About Win-Test Wiki](#)
- [Disclaimers](#)

- The logo consists of a yellow sun icon on the left, followed by the text "Powered By" in a small font, and "MediaWiki" in a larger font below it, all contained within a thin black rectangular border.

# File:Checked report.gif

From Win-Test Wiki

[Jump to navigation](#) [Jump to search](#)

- [File](#)
- [File history](#)
- [File usage](#)
- [Metadata](#)

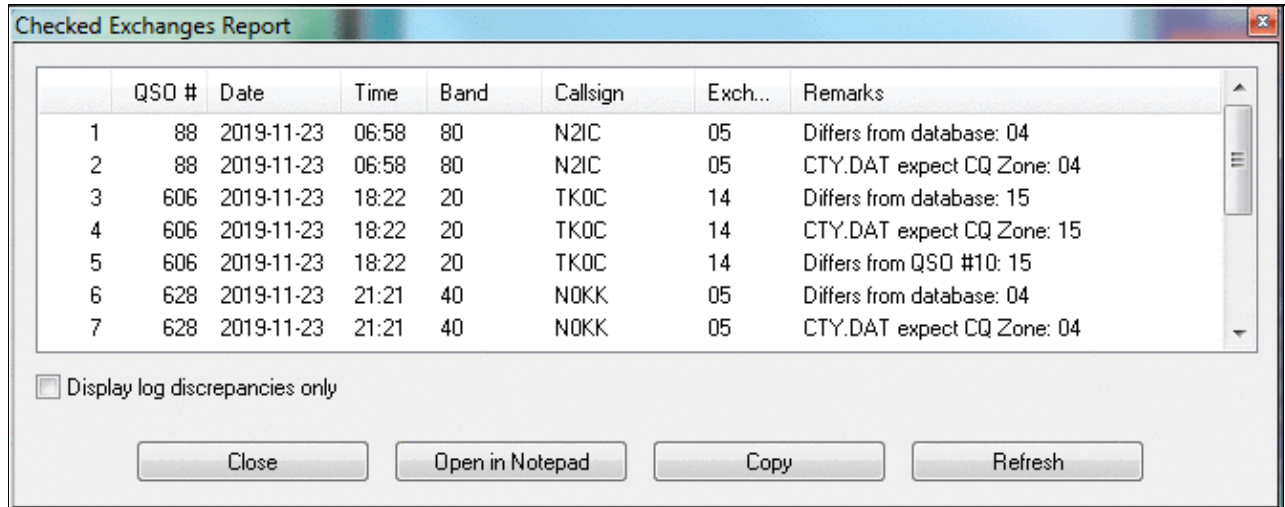

	QSO #	Date	Time	Band	Callsign	Exch...	Remarks
1	88	2019-11-23	06:58	80	N2IC	05	Differs from database: 04
2	88	2019-11-23	06:58	80	N2IC	05	CTY.DAT expect CQ Zone: 04
3	606	2019-11-23	18:22	20	TKOC	14	Differs from database: 15
4	606	2019-11-23	18:22	20	TKOC	14	CTY.DAT expect CQ Zone: 15
5	606	2019-11-23	18:22	20	TKOC	14	Differs from QSO #10: 15
6	628	2019-11-23	21:21	40	N0KK	05	Differs from database: 04
7	628	2019-11-23	21:21	40	N0KK	05	CTY.DAT expect CQ Zone: 04

No higher resolution available.

[Checked report.gif](#) (666 Å 265 pixels, file size: 26 KB, MIME type: image.gif)

## File history

Click on a date/time to view the file as it appeared at that time.

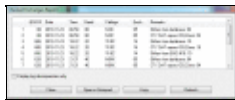
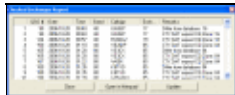
	Date/Time	Thumbnail	Dimensions	User	Comment
current	<a href="#">11:27, 4 April 2020</a>		666 Å 265 (26 KB)	<a href="#">D16rai</a> ( <a href="#">talk</a>   <a href="#">contribs</a> )	
	<a href="#">10:35, 14 March 2007</a>		585 Å 234 (19 KB)	<a href="#">I2WIJ</a> ( <a href="#">talk</a>   <a href="#">contribs</a> )	

You cannot overwrite this file.

## File usage

The following page uses this file:

- [Menu:Tools](#)

## Metadata

This file contains additional information, probably added from the digital camera or scanner used to create or digitize it.

If the file has been modified from its original state, some details may not fully reflect the modified file.

**Horizontal resolution** 37.79 dpc

**Vertical resolution** 37.79 dpc

## Namespaces

- [File](#)
- [Discussion](#)

## Variants

## Views

- [Read](#)
- [View source](#)
- [View history](#)

## More

- This page was last edited on 4 April 2020, at 11:27.

- [Privacy policy](#)
- [About Win-Test Wiki](#)
- [Disclaimers](#)

- The logo consists of a yellow sun icon on the left, followed by the text "Powered By" in a small font, and "MediaWiki" in a larger font to the right, all contained within a thin black rectangular border.

# File:CheckPartialContextMenu.gif

From Win-Test Wiki

[Jump to navigation](#) [Jump to search](#)

- [File](#)
- [File history](#)
- [File usage](#)

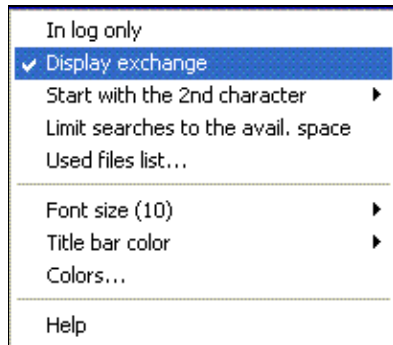

No higher resolution available.

[CheckPartialContextMenu.gif](#) (203 × 178 pixels, file size: 3 KB, MIME type: image/gif)

## File history

Click on a date/time to view the file as it appeared at that time.

Date/Time	Thumbnail	Dimensions	User	Comment
current <a href="#">07:41, 1 January 2007</a>		203 × 178 (3 KB)	<a href="#">Dl6rai</a> ( <a href="#">talk</a>   <a href="#">contribs</a> )	

You cannot overwrite this file.

## File usage

The following page uses this file:

- [Database Files](#)

## Namespaces

- [File](#)
- [Discussion](#)

## Variants

## Views

- [Read](#)
- [View source](#)
- [View history](#)

## More

- This page was last edited on 1 January 2007, at 07:41.

- [Privacy policy](#)
- [About Win-Test Wiki](#)
- [Disclaimers](#)



# File:CheckPartialContextMenu.gif

From Win-Test Wiki

[Jump to navigation](#) [Jump to search](#)

- [File](#)
- [File history](#)
- [File usage](#)

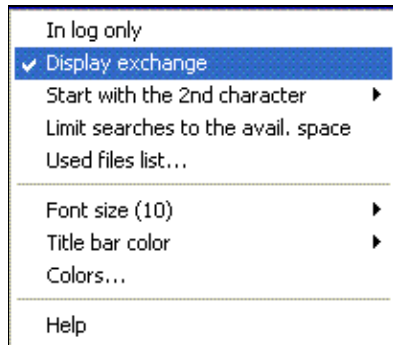

No higher resolution available.

[CheckPartialContextMenu.gif](#) (203 × 178 pixels, file size: 3 KB, MIME type: image/gif)

## File history

Click on a date/time to view the file as it appeared at that time.

Date/Time	Thumbnail	Dimensions	User	Comment
current <a href="#">07:41, 1 January 2007</a>		203 × 178 (3 KB)	<a href="#">Dl6rai</a> ( <a href="#">talk</a>   <a href="#">contribs</a> )	

You cannot overwrite this file.

## File usage

The following page uses this file:

- [Database Files](#)

## Namespaces

- [File](#)
- [Discussion](#)

## Variants

## Views

- [Read](#)
- [View source](#)
- [View history](#)

## More

- This page was last edited on 1 January 2007, at 07:41.

- [Privacy policy](#)
- [About Win-Test Wiki](#)
- [Disclaimers](#)



# File:Check Partial Files List.PNG

From Win-Test Wiki

[Jump to navigation](#) [Jump to search](#)

- [File](#)
- [File history](#)
- [File usage](#)

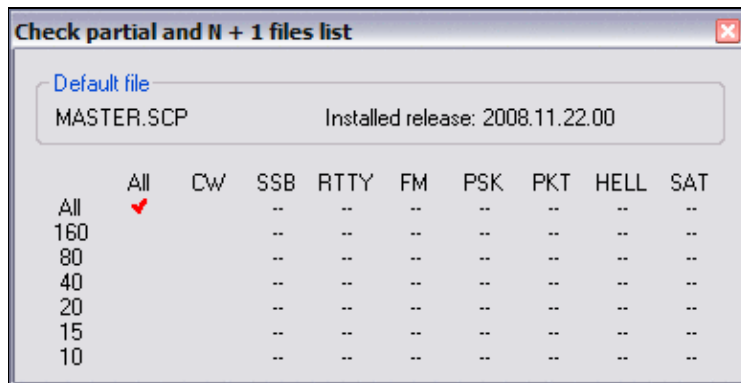

No higher resolution available.

[Check Partial Files List.PNG](#) (387 × 198 pixels, file size: 6 KB, MIME type: image/gif)

Check partial and N + 1 Files List (Used files list from Check partial window pop-up)

## File history

Click on a date/time to view the file as it appeared at that time.

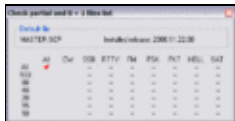
Date/Time	Thumbnail	Dimensions	User	Comment
<a href="#">00:51, 5 current December 2009</a>		387 × 198 (6 KB)	<a href="#">N6TV (talk   contribs)</a>	Check partial and N + 1 Files List (Used files list from Check partial window pop-up)

You cannot overwrite this file.

## File usage

The following 2 pages use this file:

- [Check Partial and Np1 Files](#)
- [Menu:Windows](#)

## Namespaces

- [File](#)
- [Discussion](#)



## Variants

## Views

- [Read](#)
- [View source](#)
- [View history](#)

## More

- This page was last edited on 5 December 2009, at 00:51.

- [Privacy policy](#)
- [About Win-Test Wiki](#)
- [Disclaimers](#)



# File:Check Partial Files List.PNG

From Win-Test Wiki

[Jump to navigation](#) [Jump to search](#)

- [File](#)
- [File history](#)
- [File usage](#)

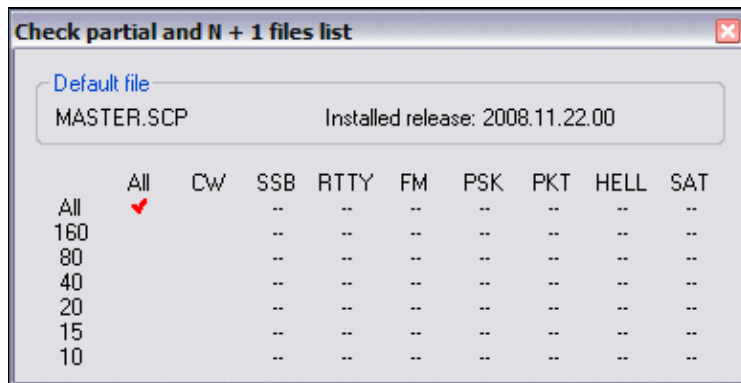

No higher resolution available.

[Check Partial Files List.PNG](#) (387 × 198 pixels, file size: 6 KB, MIME type: image/gif)

Check partial and N + 1 Files List (Used files list from Check partial window pop-up)

## File history

Click on a date/time to view the file as it appeared at that time.

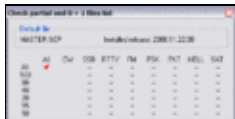
Date/Time	Thumbnail	Dimensions	User	Comment
<a href="#">00:51, 5 current December 2009</a>		387 × 198 (6 KB)	<a href="#">N6TV (talk   contribs)</a>	Check partial and N + 1 Files List (Used files list from Check partial window pop-up)

You cannot overwrite this file.

## File usage

The following 2 pages use this file:

- [Check Partial and Np1 Files](#)
- [Menu:Windows](#)

## Namespaces

- [File](#)
- [Discussion](#)

## Variants

## Views

- [Read](#)
- [View source](#)
- [View history](#)

## More

- This page was last edited on 5 December 2009, at 00:51.

- [Privacy policy](#)
- [About Win-Test Wiki](#)
- [Disclaimers](#)



# File:CheckPartialUsedFilesList.gif

From Win-Test Wiki

[Jump to navigation](#) [Jump to search](#)

- [File](#)
- [File history](#)
- [File usage](#)

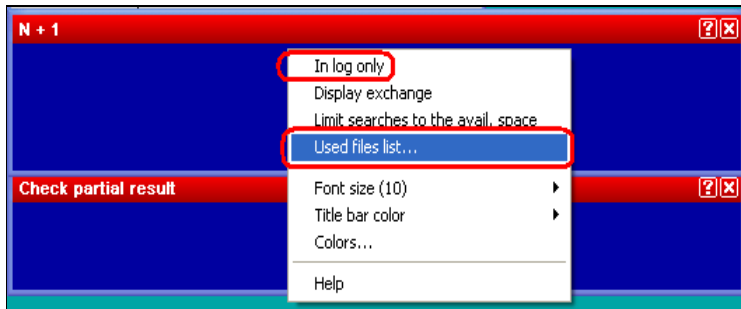

No higher resolution available.

[CheckPartialUsedFilesList.gif](#) (387 × 159 pixels, file size: 4 KB, MIME type: image/gif)

## File history

Click on a date/time to view the file as it appeared at that time.

Date/Time	Thumbnail	Dimensions	User	Comment
current <a href="#">07:41, 1 January 2007</a>		387 × 159 (4 KB)	<a href="#">Dl6rai</a> ( <a href="#">talk</a>   <a href="#">contribs</a> )	

You cannot overwrite this file.

## File usage

The following page uses this file:

- [Database Files](#)

## Namespaces

- [File](#)
- [Discussion](#)

## Variants

## Views

- [Read](#)
- [View source](#)
- [View history](#)

## More

- This page was last edited on 1 January 2007, at 07:41.

- [Privacy policy](#)
- [About Win-Test Wiki](#)
- [Disclaimers](#)



# File:CheckPartialUsedFilesList.PNG

From Win-Test Wiki

[Jump to navigation](#) [Jump to search](#)

- [File](#)
- [File history](#)
- [File usage](#)

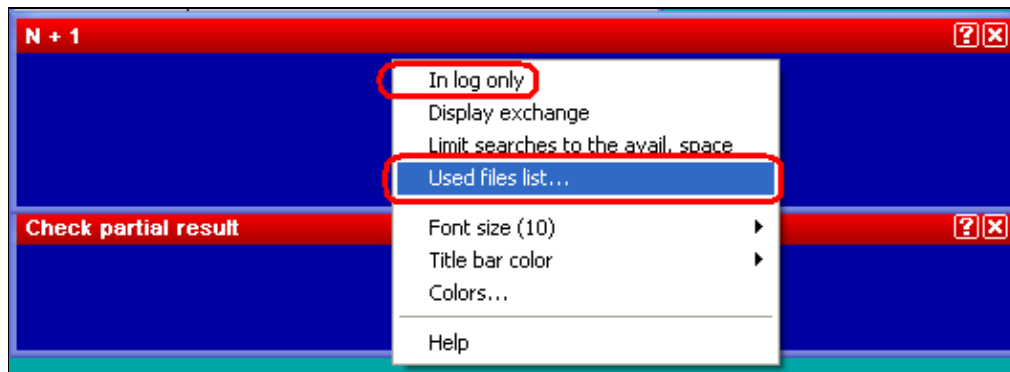

No higher resolution available.

[CheckPartialUsedFilesList.PNG](#) (529 × 192 pixels, file size: 7 KB, MIME type: image/gif)

Menu to display which check partial files are being used.

## File history

Click on a date/time to view the file as it appeared at that time.

	Date/Time	Thumbnail	Dimensions	User	Comment
current	<a href="#">20:52.9 November 2010</a>		529 × 192 (7 KB)	<a href="#">N6TV (talk   contribs)</a>	Menu to display which check partial files are being used.

You cannot overwrite this file.

## File usage

The following page uses this file:

- [Sweepstakes](#)

## Namespaces

- [File](#)
- [Discussion](#)

## Variants

## Views

- [Read](#)
- [View source](#)
- [View history](#)

## More

- This page was last edited on 9 November 2010, at 20:52.

- [Privacy policy](#)
- [About Win-Test Wiki](#)
- [Disclaimers](#)



# File:CheckPartialUsedFilesList.PNG

From Win-Test Wiki

[Jump to navigation](#) [Jump to search](#)

- [File](#)
- [File history](#)
- [File usage](#)

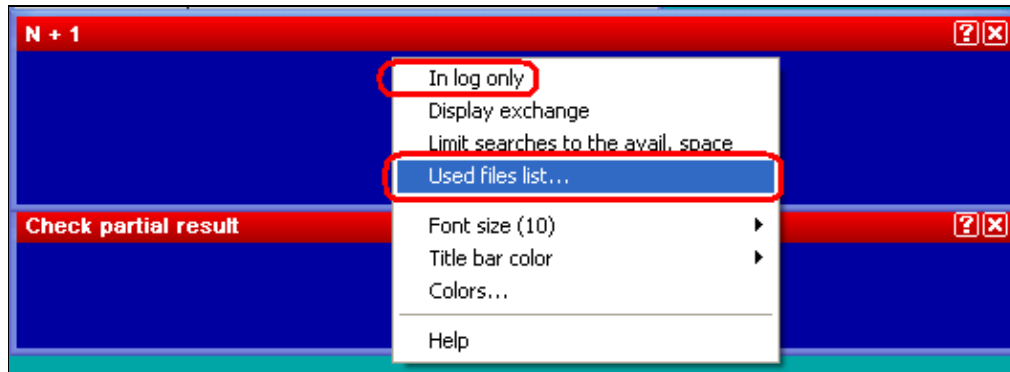

No higher resolution available.

[CheckPartialUsedFilesList.PNG](#) (529 × 192 pixels, file size: 7 KB, MIME type: image/gif)

Menu to display which check partial files are being used.

## File history

Click on a date/time to view the file as it appeared at that time.

	Date/Time	Thumbnail	Dimensions	User	Comment
current	<a href="#">20:52.9 November 2010</a>		529 × 192 (7 KB)	<a href="#">N6TV (talk   contribs)</a>	Menu to display which check partial files are being used.

You cannot overwrite this file.

## File usage

The following page uses this file:

- [Sweepstakes](#)

## Namespaces

- [File](#)
- [Discussion](#)



## Variants

## Views

- [Read](#)
- [View source](#)
- [View history](#)

## More

- This page was last edited on 9 November 2010, at 20:52.

- [Privacy policy](#)
- [About Win-Test Wiki](#)
- [Disclaimers](#)



# File:CheckPartialUsedFilesList.gif

From Win-Test Wiki

[Jump to navigation](#) [Jump to search](#)

- [File](#)
- [File history](#)
- [File usage](#)

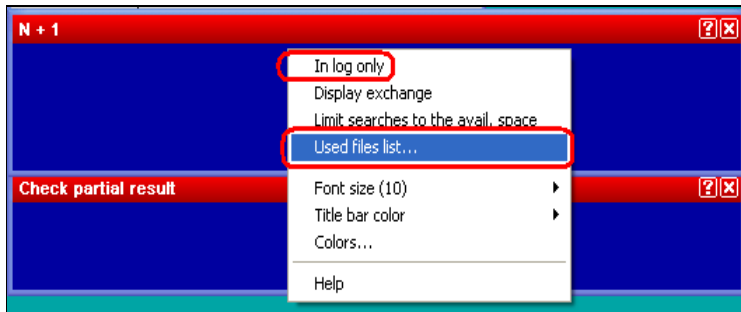

No higher resolution available.

[CheckPartialUsedFilesList.gif](#) (387 Å 159 pixels, file size: 4 KB, MIME type: image/gif)

## File history

Click on a date/time to view the file as it appeared at that time.

Date/Time	Thumbnail	Dimensions	User	Comment
current <a href="#">07:41, 1 January 2007</a>		387 Å 159 (4 KB)	<a href="#">Dl6rai</a> ( <a href="#">talk</a>   <a href="#">contribs</a> )	

You cannot overwrite this file.

## File usage

The following page uses this file:

- [Database Files](#)

## Namespaces

- [File](#)
- [Discussion](#)

## Variants

## Views

- [Read](#)
- [View source](#)
- [View history](#)

## More

- This page was last edited on 1 January 2007, at 07:41.

- [Privacy policy](#)
- [About Win-Test Wiki](#)
- [Disclaimers](#)



# File:clocks.gif

From Win-Test Wiki

[Jump to navigation](#) [Jump to search](#)

- [File](#)
- [File history](#)
- [File usage](#)

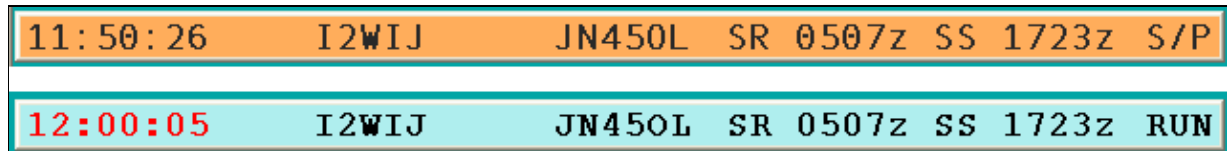

No higher resolution available.

[clocks.gif](#) (638 × 77 pixels, file size: 3 KB, MIME type: image.gif)

two sample of clock window

## File history

Click on a date/time to view the file as it appeared at that time.

	Date/Time	Thumbnail	Dimensions	User	Comment
current	<a href="#">12:12, 21 September 2007</a>		638 × 77 (3 KB)	<a href="#">I2WIJ (talk   contribs)</a>	two sample of clock window

You cannot overwrite this file.

## File usage

The following page uses this file:

- [Menu:Windows](#)

## Namespaces

- [File](#)
- [Discussion](#)

## Variants

## Views

- [Read](#)
- [View source](#)
- [View history](#)

## More

- This page was last edited on 21 September 2007, at 12:12.

- [Privacy policy](#)
- [About Win-Test Wiki](#)
- [Disclaimers](#)



# File:clocks.gif

From Win-Test Wiki

[Jump to navigation](#) [Jump to search](#)

- [File](#)
- [File history](#)
- [File usage](#)

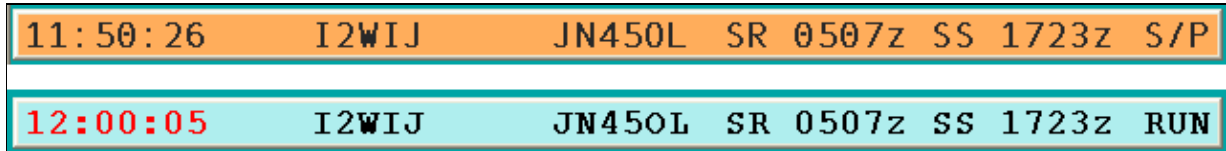

No higher resolution available.

[clocks.gif](#) (638 × 77 pixels, file size: 3 KB, MIME type: image.gif)

two sample of clock window

## File history

Click on a date/time to view the file as it appeared at that time.

	Date/Time	Thumbnail	Dimensions	User	Comment
current	<a href="#">12:12, 21 September 2007</a>		638 × 77 (3 KB)	<a href="#">I2WIJ</a> ( <a href="#">talk</a>   <a href="#">contribs</a> )	two sample of clock window

You cannot overwrite this file.

## File usage

The following page uses this file:

- [Menu:Windows](#)

## Namespaces

- [File](#)
- [Discussion](#)

## Variants

## Views

- [Read](#)
- [View source](#)
- [View history](#)

## More

- This page was last edited on 21 September 2007, at 12:12.

- [Privacy policy](#)
- [About Win-Test Wiki](#)
- [Disclaimers](#)



# File:com1-properties.gif

From Win-Test Wiki

[Jump to navigation](#) [Jump to search](#)

- [File](#)
- [File history](#)
- [File usage](#)

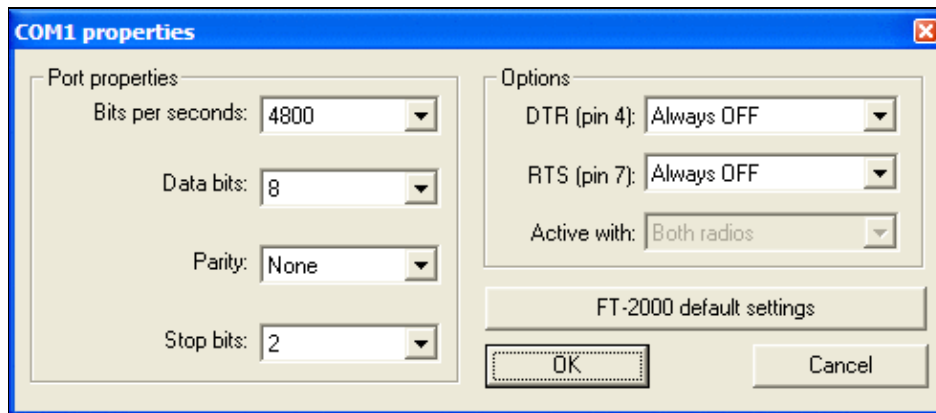

No higher resolution available.

[com1-properties.gif](#) (491 × 213 pixels, file size: 10 KB, MIME type: image/gif)

## File history

Click on a date/time to view the file as it appeared at that time.

	Date/Time	Thumbnail	Dimensions	User	Comment
current	<a href="#">03:38, 14 January 2008</a>		491 × 213 (10 KB)	<a href="#">N6TV</a> ( <a href="#">talk</a>   <a href="#">contribs</a> )	Updated to WT 3.18 version, with "default for FT-2000" button.
	<a href="#">21:11, 26 July 2006</a>		461 × 188 (5 KB)	<a href="#">DL4NER</a> ( <a href="#">talk</a>   <a href="#">contribs</a> )	

You cannot overwrite this file.

## File usage

The following page uses this file:

- [Menu:Options](#)

## Namespaces

- [File](#)
- [Discussion](#)



## Variants

## Views

- [Read](#)
- [View source](#)
- [View history](#)

## More

- This page was last edited on 26 July 2006, at 21:11.

- [Privacy policy](#)
- [About Win-Test Wiki](#)
- [Disclaimers](#)



# File:com1-properties.gif

From Win-Test Wiki

[Jump to navigation](#) [Jump to search](#)

- [File](#)
- [File history](#)
- [File usage](#)

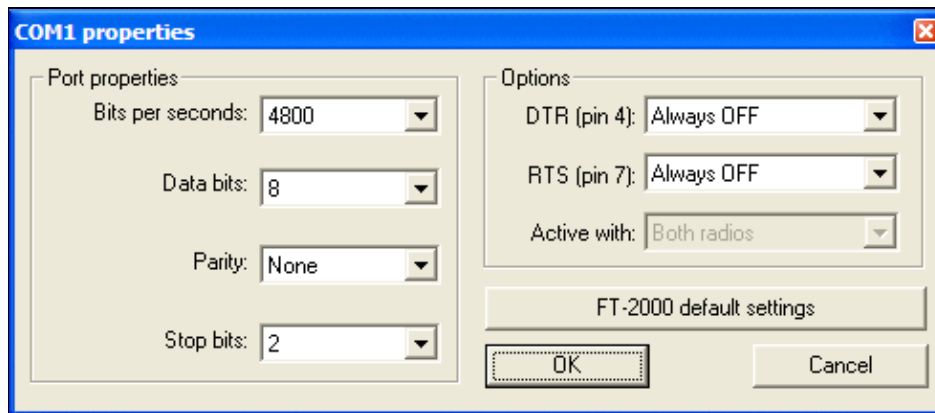

No higher resolution available.

[com1-properties.gif](#) (491 × 213 pixels, file size: 10 KB, MIME type: image/gif)

## File history

Click on a date/time to view the file as it appeared at that time.

	Date/Time	Thumbnail	Dimensions	User	Comment
current	<a href="#">03:38, 14 January 2008</a>		491 × 213 (10 KB)	<a href="#">N6TV</a> ( <a href="#">talk</a>   <a href="#">contribs</a> )	Updated to WT 3.18 version, with "default for FT-2000" button.
	<a href="#">21:11, 26 July 2006</a>		461 × 188 (5 KB)	<a href="#">DL4NER</a> ( <a href="#">talk</a>   <a href="#">contribs</a> )	

You cannot overwrite this file.

## File usage

The following page uses this file:

- [Menu:Options](#)

## Namespaces

- [File](#)
- [Discussion](#)

## Variants

## Views

- [Read](#)
- [View source](#)
- [View history](#)

## More

- This page was last edited on 26 July 2006, at 21:11.

- [Privacy policy](#)
- [About Win-Test Wiki](#)
- [Disclaimers](#)



# File:com6-properties.gif

From Win-Test Wiki

[Jump to navigation](#) [Jump to search](#)

- [File](#)
- [File history](#)
- [File usage](#)
- [Metadata](#)

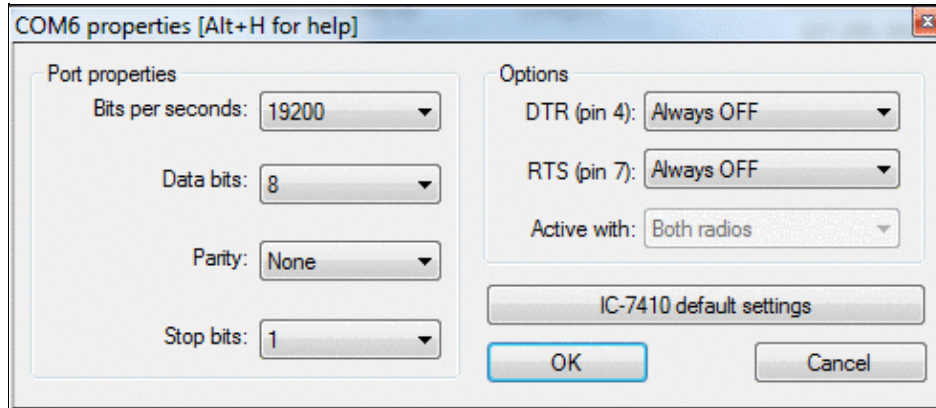

No higher resolution available.

[com6-properties.gif](#) (491 × 213 pixels, file size: 20 KB, MIME type: image/gif)

## File history

Click on a date/time to view the file as it appeared at that time.

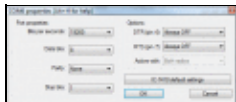
	Date/Time	Thumbnail	Dimensions	User	Comment
current	<a href="#">13:34, 30 December 2021</a>		491 × 213 (20 KB)	<a href="#">Dl6rai</a> ( <a href="#">talk</a>   <a href="#">contribs</a> )	

You cannot overwrite this file.

## File usage

The following page uses this file:

- [Interfaces](#)

## Metadata

This file contains additional information, probably added from the digital camera or scanner used to create or digitize it.

If the file has been modified from its original state, some details may not fully reflect the modified file.

**Horizontal resolution** 37.79 dpc

**Vertical resolution** 37.79 dpc

## Namespaces

- [File](#)
- [Discussion](#)

## Variants

## Views

- [Read](#)
- [View source](#)
- [View history](#)

## More

- This page was last edited on 30 December 2021, at 13:34.
- [Privacy policy](#)
- [About Win-Test Wiki](#)
- [Disclaimers](#)



# File:com6-properties.gif

From Win-Test Wiki

[Jump to navigation](#) [Jump to search](#)

- [File](#)
- [File history](#)
- [File usage](#)
- [Metadata](#)

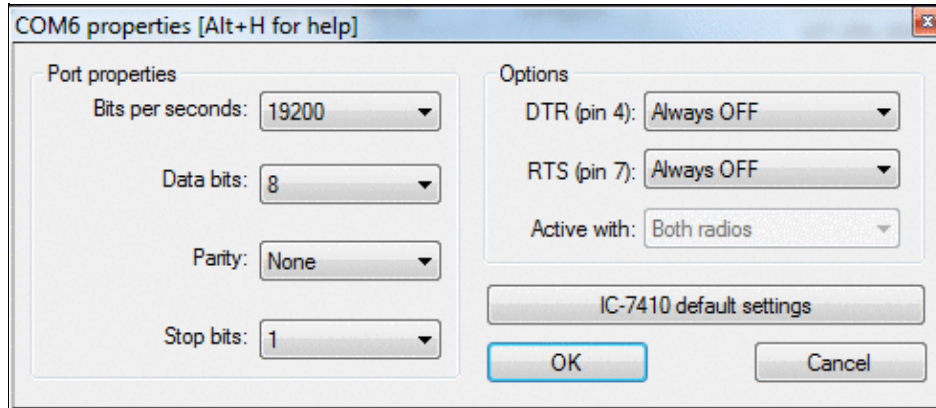

No higher resolution available.

[com6-properties.gif](#) (491 × 213 pixels, file size: 20 KB, MIME type: image/gif)

## File history

Click on a date/time to view the file as it appeared at that time.

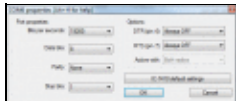
	Date/Time	Thumbnail	Dimensions	User	Comment
current	<a href="#">13:34, 30 December 2021</a>		491 × 213 (20 KB)	<a href="#">Dl6rai</a> ( <a href="#">talk</a>   <a href="#">contribs</a> )	

You cannot overwrite this file.

## File usage

The following page uses this file:

- [Interfaces](#)

## Metadata

This file contains additional information, probably added from the digital camera or scanner used to create or digitize it.

If the file has been modified from its original state, some details may not fully reflect the modified file.

**Horizontal resolution** 37.79 dpc

**Vertical resolution** 37.79 dpc

## Namespaces

- [File](#)
- [Discussion](#)

## Variants

## Views

- [Read](#)
- [View source](#)
- [View history](#)

## More

- This page was last edited on 30 December 2021, at 13:34.
- [Privacy policy](#)
- [About Win-Test Wiki](#)
- [Disclaimers](#)



# File:COM Port CW PTT Circuit.gif

From Win-Test Wiki

[Jump to navigation](#) [Jump to search](#)

- [File](#)
- [File history](#)
- [File usage](#)
- [Metadata](#)

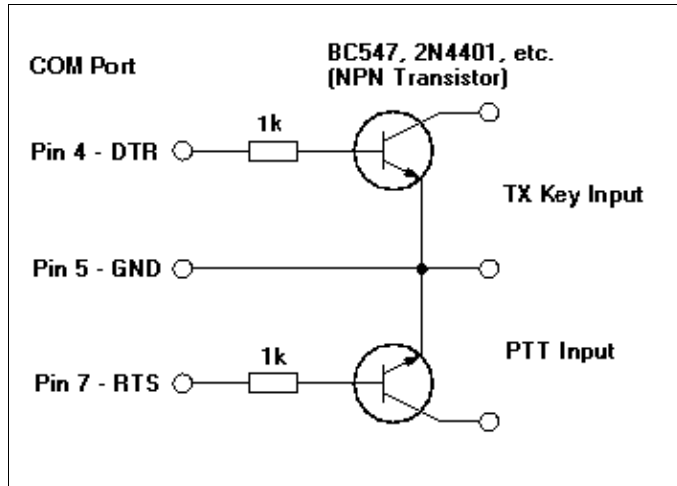

No higher resolution available.

[COM Port CW PTT Circuit.gif](#) (353 × 253 pixels, file size: 4 KB, MIME type: image/gif)

New COM port CW and PTT circuit schematic. Replaces old one that only showed CW output and didn't include pin numbers.

## File history

Click on a date/time to view the file as it appeared at that time.

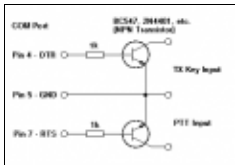
	Date/Time	Thumbnail	Dimensions	User	Comment
current	<a href="#">17:31, 7 June 2016</a>		353 × 253 (4 KB)	<a href="#">N6TV</a> ( <a href="#">talk</a>   <a href="#">contribs</a> )	New COM port CW and PTT circuit schematic. Replaces old one that only showed CW output and didn't include pin numbers.

You cannot overwrite this file.

## File usage

The following page uses this file:

- [Interfaces](#)



## Metadata

This file contains additional information, probably added from the digital camera or scanner used to create or digitize it.

If the file has been modified from its original state, some details may not fully reflect the modified file.

**Horizontal resolution** 37.79 dpc

**Vertical resolution** 37.79 dpc

## Namespaces

- [File](#)
- [Discussion](#)

## Variants

## Views

- [Read](#)
- [View source](#)
- [View history](#)

## More

- This page was last edited on 7 June 2016, at 17:31.

- [Privacy policy](#)
- [About Win-Test Wiki](#)
- [Disclaimers](#)

- The logo consists of a small yellow sun icon to the left of the text "Powered By MediaWiki". The text is in a blue, sans-serif font, with "Powered By" on the top line and "MediaWiki" on the bottom line. The entire logo is enclosed in a thin black rectangular border.

# File:COM Port CW PTT Circuit.gif

From Win-Test Wiki

[Jump to navigation](#) [Jump to search](#)

- [File](#)
- [File history](#)
- [File usage](#)
- [Metadata](#)

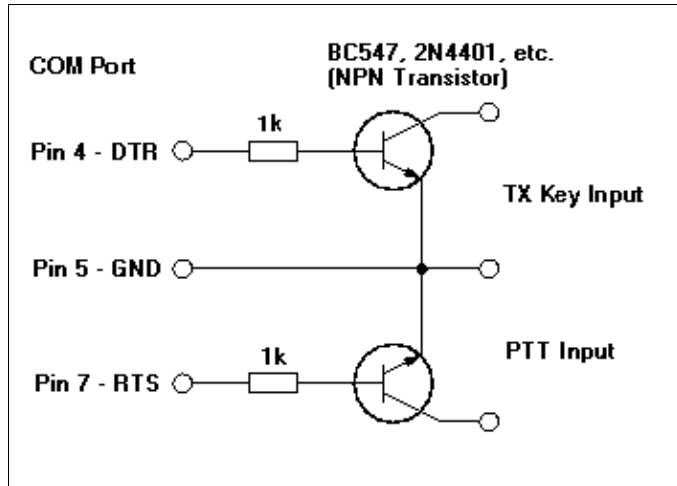

No higher resolution available.

[COM Port CW PTT Circuit.gif](#) (353 × 253 pixels, file size: 4 KB, MIME type: image/gif)

New COM port CW and PTT circuit schematic. Replaces old one that only showed CW output and didn't include pin numbers.

## File history

Click on a date/time to view the file as it appeared at that time.

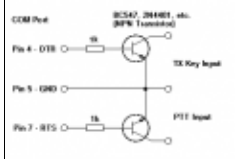
	Date/Time	Thumbnail	Dimensions	User	Comment
current	<a href="#">17:31, 7 June 2016</a>		353 × 253 (4 KB)	<a href="#">N6TV</a> ( <a href="#">talk</a>   <a href="#">contribs</a> )	New COM port CW and PTT circuit schematic. Replaces old one that only showed CW output and didn't include pin numbers.

You cannot overwrite this file.

## File usage

The following page uses this file:

- [Interfaces](#)

## Metadata

This file contains additional information, probably added from the digital camera or scanner used to create or digitize it.

If the file has been modified from its original state, some details may not fully reflect the modified file.

**Horizontal resolution** 37.79 dpc

**Vertical resolution** 37.79 dpc

## Namespaces

- [File](#)
- [Discussion](#)

## Variants

## Views

- [Read](#)
- [View source](#)
- [View history](#)

## More

- This page was last edited on 7 June 2016, at 17:31.

- [Privacy policy](#)
- [About Win-Test Wiki](#)
- [Disclaimers](#)

- The logo for MediaWiki, featuring a yellow sun icon and the text "Powered By MediaWiki".

# File:Config TNC.jpg

From Win-Test Wiki

[Jump to navigation](#) [Jump to search](#)

- [File](#)
- [File history](#)
- [File usage](#)

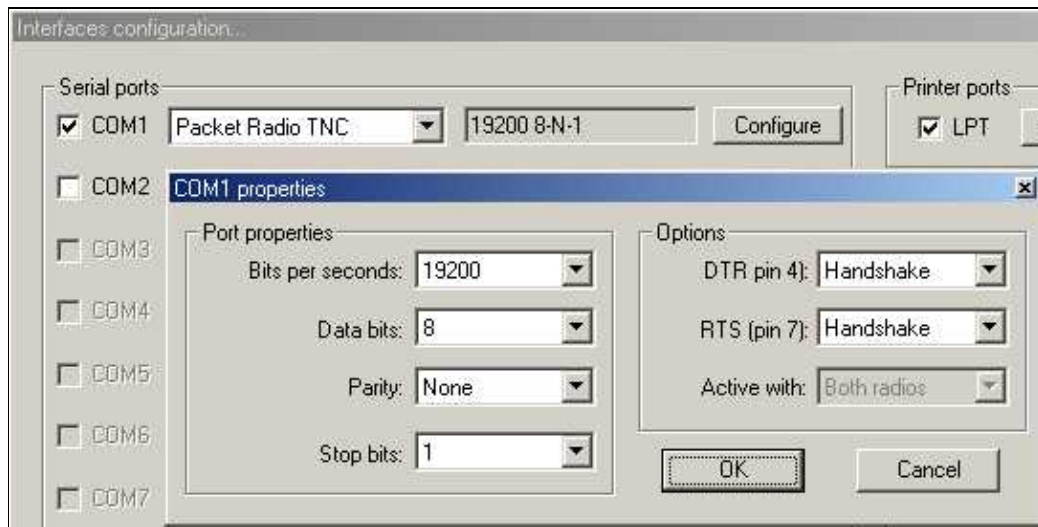

No higher resolution available.

[Config\\_TNC.jpg](#) (542 × 273 pixels, file size: 23 KB, MIME type: image/jpeg)

## File history

Click on a date/time to view the file as it appeared at that time.

Date/Time	Thumbnail	Dimensions	User	Comment
current <a href="#">18:27, 26 July 2006</a>		542 × 273 (23 KB)	<a href="#">DL8NAS</a> ( <a href="#">talk</a>   <a href="#">contribs</a> )	

You cannot overwrite this file.

## File usage

The following page uses this file:

- [DX Cluster/Packet](#)

## Namespaces

- [File](#)
- [Discussion](#)

## Variants

## Views

- [Read](#)
- [View source](#)
- [View history](#)

## More

- This page was last edited on 26 July 2006, at 18:27.

- [Privacy policy](#)
- [About Win-Test Wiki](#)
- [Disclaimers](#)



# File:Config TNC.jpg

From Win-Test Wiki

[Jump to navigation](#) [Jump to search](#)

- [File](#)
- [File history](#)
- [File usage](#)

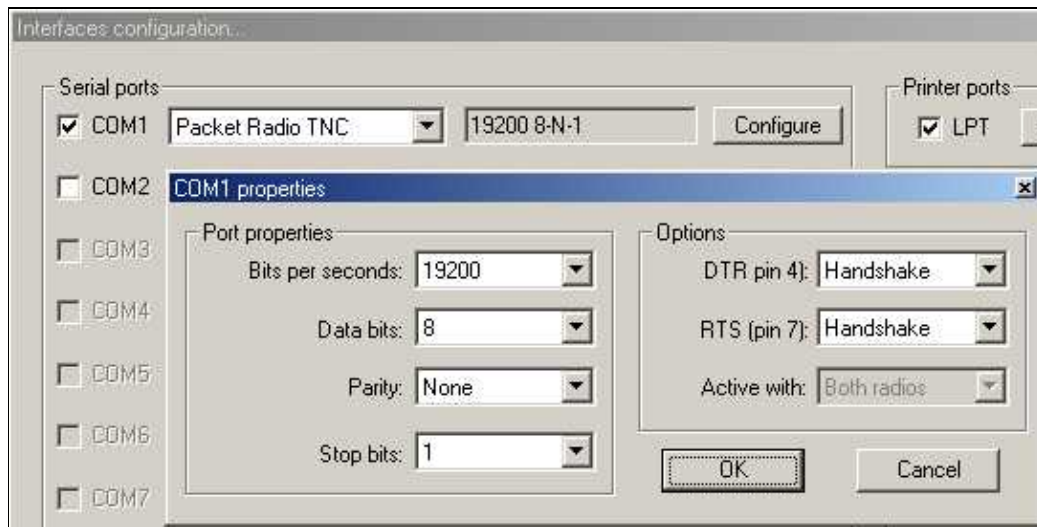

No higher resolution available.

[Config\\_TNC.jpg](#) (542 × 273 pixels, file size: 23 KB, MIME type: image/jpeg)

## File history

Click on a date/time to view the file as it appeared at that time.

Date/Time	Thumbnail	Dimensions	User	Comment
current <a href="#">18:27, 26 July 2006</a>		542 × 273 (23 KB)	<a href="#">DL8NAS</a> ( <a href="#">talk</a>   <a href="#">contribs</a> )	

You cannot overwrite this file.

## File usage

The following page uses this file:

- [DX Cluster/Packet](#)

## Namespaces

- [File](#)
- [Discussion](#)

## Variants

## Views

- [Read](#)
- [View source](#)
- [View history](#)

## More

- This page was last edited on 26 July 2006, at 18:27.

- [Privacy policy](#)
- [About Win-Test Wiki](#)
- [Disclaimers](#)



# File:Configure-interfaces.gif

From Win-Test Wiki

[Jump to navigation](#) [Jump to search](#)

- [File](#)
- [File history](#)
- [File usage](#)

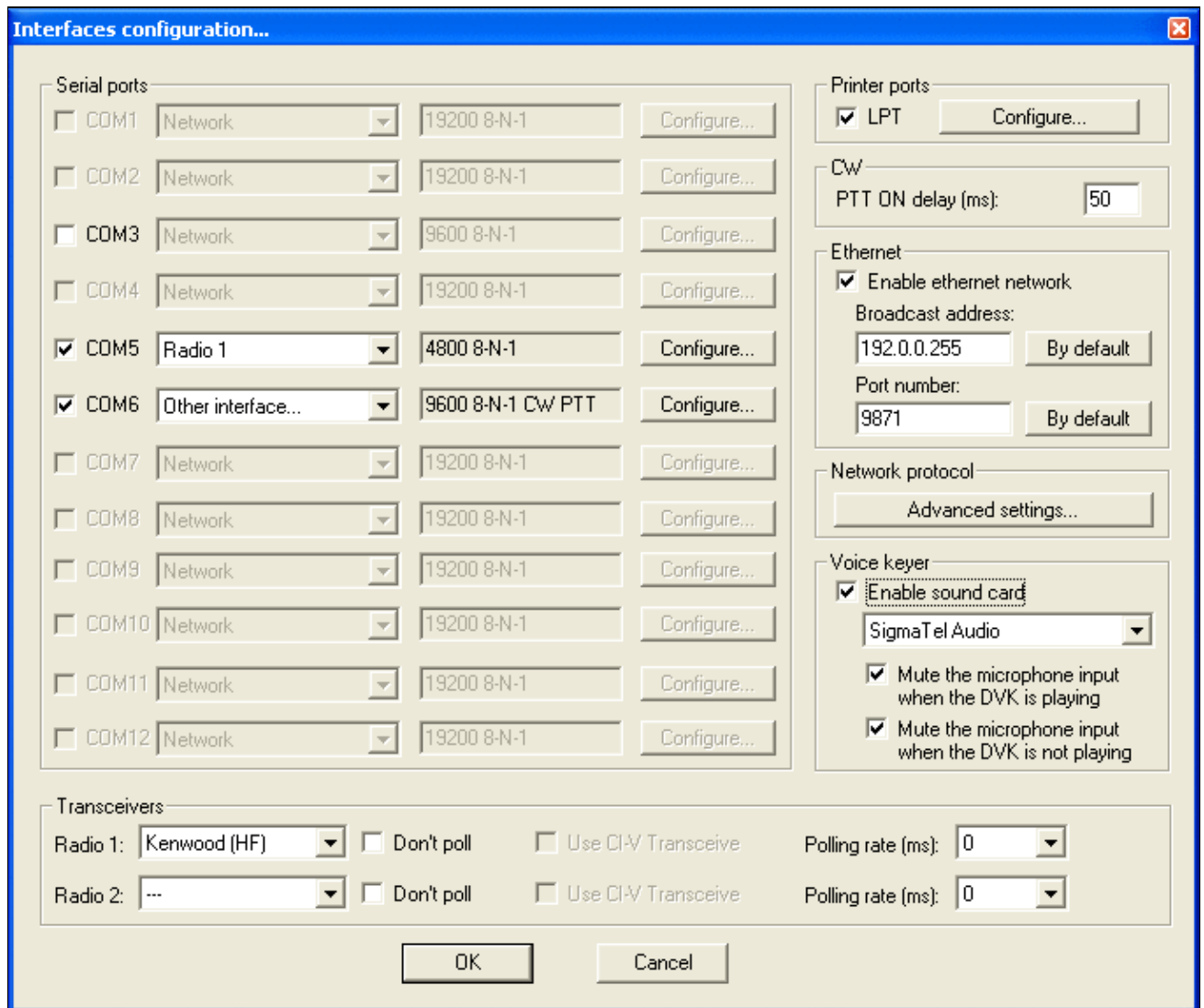



No higher resolution available.

[Configure-interfaces.gif](#) (678 × 573 pixels, file size: 21 KB, MIME type: image.gif)

## File history

Click on a date/time to view the file as it appeared at that time.

	Date/Time	Thumbnail	Dimensions	User	Comment
current	<a href="#">06:38, 1 December 2006</a>		678 × 573 (21 KB)	<a href="#">Dl6rai</a> ( <a href="#">talk</a>   <a href="#">contribs</a> )	

You cannot overwrite this file.

## File usage

The following page uses this file:

- [Menu:Options](#)

## Namespaces

- [File](#)
- [Discussion](#)

## Variants

## Views

- [Read](#)
- [View source](#)
- [View history](#)

## More

- This page was last edited on 1 December 2006, at 06:38.
- [Privacy policy](#)
- [About Win-Test Wiki](#)
- [Disclaimers](#)



# File:Configure-interfaces.gif

From Win-Test Wiki

[Jump to navigation](#) [Jump to search](#)

- [File](#)
- [File history](#)
- [File usage](#)

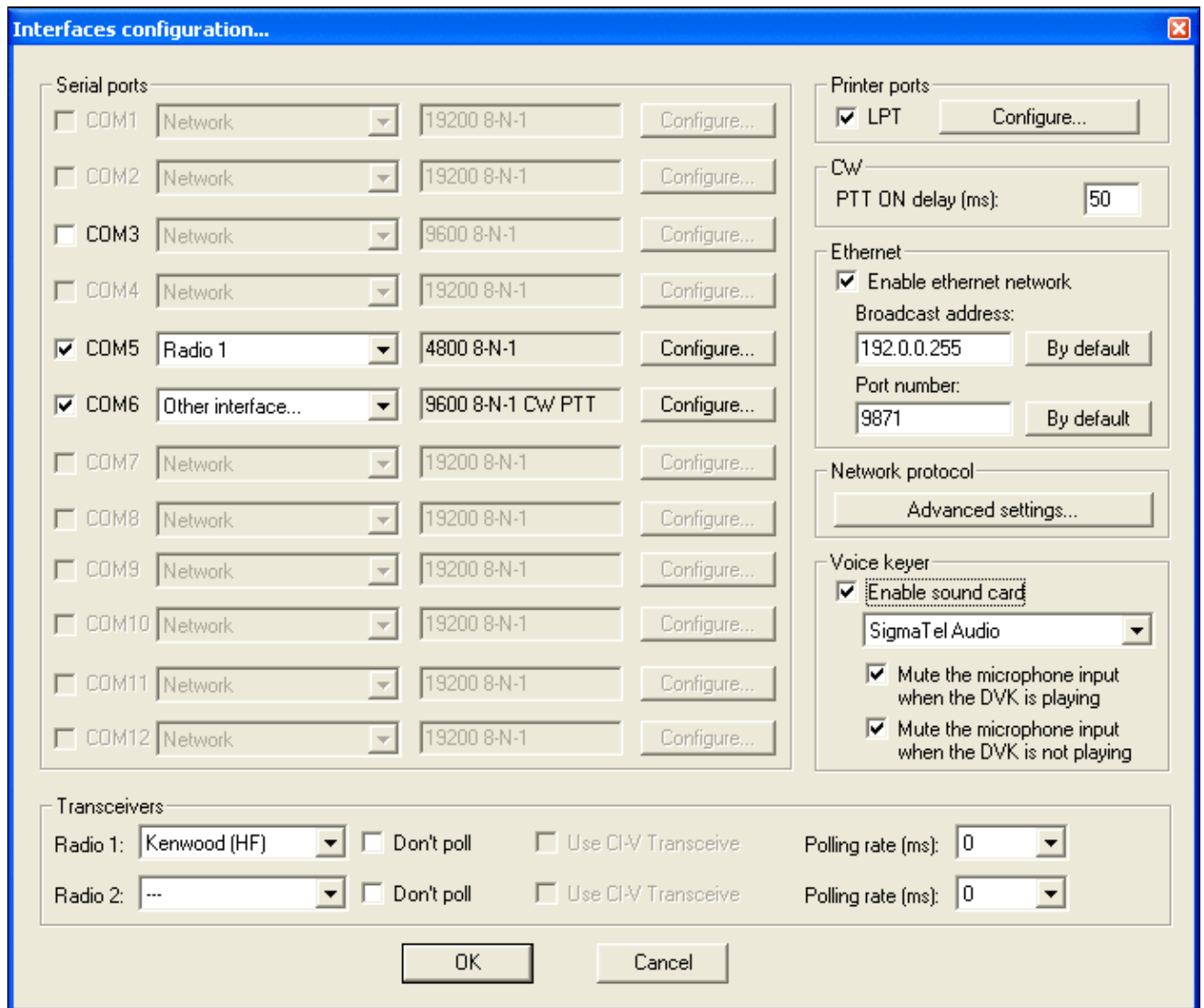

No higher resolution available.

[Configure-interfaces.gif](#) (678 × 573 pixels, file size: 21 KB, MIME type: image.gif)

## File history

Click on a date/time to view the file as it appeared at that time.

	Date/Time	Thumbnail	Dimensions	User	Comment
current	<a href="#">06:38, 1 December 2006</a>		678 × 573 (21 KB)	<a href="#">Dl6rai</a> ( <a href="#">talk</a>   <a href="#">contribs</a> )	

You cannot overwrite this file.

## File usage

The following page uses this file:

- [Menu:Options](#)

## Namespaces

- [File](#)
- [Discussion](#)

## Variants

## Views

- [Read](#)
- [View source](#)
- [View history](#)

## More

- This page was last edited on 1 December 2006, at 06:38.
- [Privacy policy](#)
- [About Win-Test Wiki](#)
- [Disclaimers](#)



# File:Contest configuration.gif

From Win-Test Wiki

[Jump to navigation](#) [Jump to search](#)

- [File](#)
- [File history](#)
- [File usage](#)

The image shows a screenshot of the "Contest configuration" dialog box. The dialog is titled "Contest configuration" and has a close button in the top right corner. It is divided into several sections:

- Station:** Contains fields for Callsign (N6TV), Locator (CM97CF), Exchange (zone, ...): (6), DXCC Prefix (W), WAZ zone (03), ITU zone (06), State/Province/Other (CA), Name (Robert A. Wilson), Address (51 Cheltenham Way), Address (San Jose, CA 95139-1257), Address (USA), and Club (Northern California Contest Club).
- Load:** Contains buttons for N6TV, Station 2, Station 3, Station 4, and Station 5.
- Save as:** Contains buttons for N6TV, Station 2, Station 3, Station 4, and Station 5.
- Contest:** Contains a Contest dropdown (IARU HF World Championship), Days... button, This month only checkbox, Category dropdown (Single operator), Mode dropdown (CW), Overlay dropdown (---), Band plan dropdown (Default) with Setup... button, Class dropdown (High power), and Power field (1500). There is also an Operators field.
- Network:** Contains a Station field (STN1) and an Enable time distribution across the network checkbox.

At the bottom right of the dialog are OK and Cancel buttons.



No higher resolution available.

[Contest configuration.gif](#) (516 × 590 pixels, file size: 21 KB, MIME type: image.gif)

Contesting configuration screenshot

## File history

Click on a date/time to view the file as it appeared at that time.

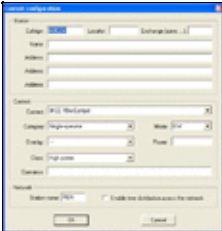
	Date/Time	Thumbnail	Dimensions	User	Comment
current	<a href="#">21:29, 19 July 2008</a>		516 × 590 (21 KB)	<a href="#">N6TV</a> ( <a href="#">talk</a>   <a href="#">contribs</a> )	Updated to show new "Days" button
	<a href="#">23:32, 28 July 2007</a>		516 × 590 (25 KB)	<a href="#">N6TV</a> ( <a href="#">talk</a>   <a href="#">contribs</a> )	New contest configuration screen from v3.14.
	<a href="#">14:15, 5 January 2006</a>		480 × 502 (14 KB)	<a href="#">M0CLW</a> ( <a href="#">talk</a>   <a href="#">contribs</a> )	Contesting configuration screenshot

You cannot overwrite this file.

## File usage

The following 2 pages use this file:

- [Menu:File new](#)
- [New Log](#)

## Namespaces

- [File](#)
- [Discussion](#)

## Variants

## Views

- [Read](#)
- [View source](#)
- [View history](#)

## More

- This page was last edited on 5 January 2006, at 14:15.

- [Privacy policy](#)
- [About Win-Test Wiki](#)
- [Disclaimers](#)



# File:ContestRecorder.PNG

From Win-Test Wiki

[Jump to navigation](#) [Jump to search](#)

- [File](#)
- [File history](#)
- [File usage](#)
- [Metadata](#)

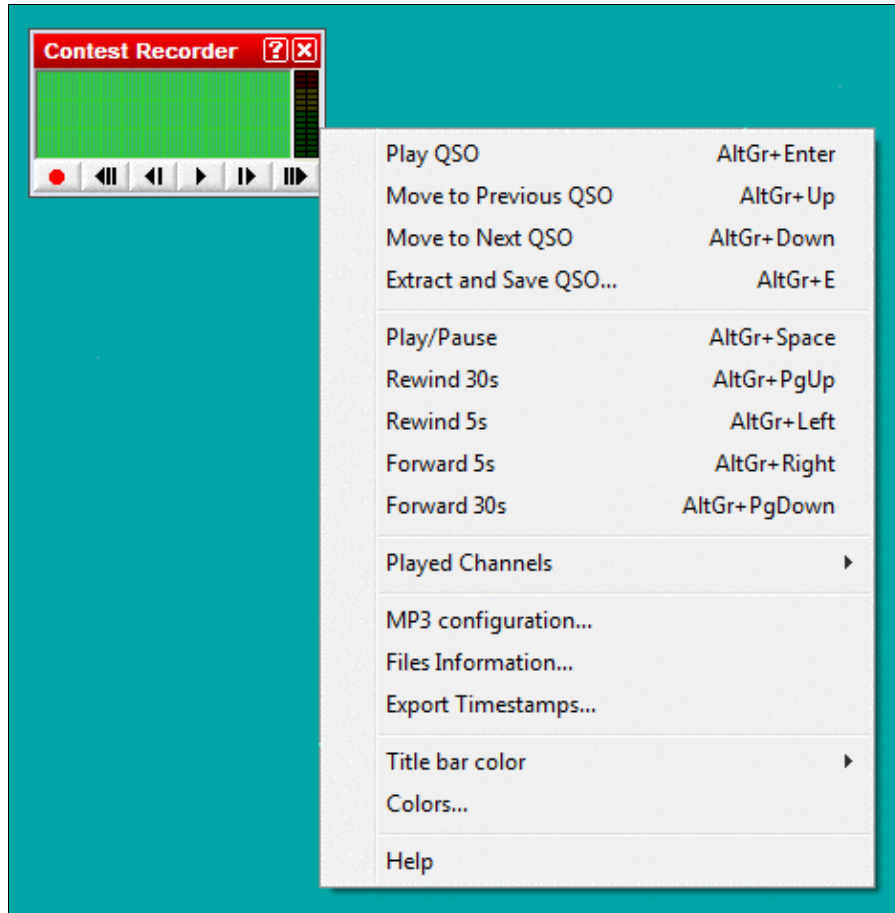



No higher resolution available.

ContestRecorder.PNG (469 × 476 pixels, file size: 16 KB, MIME type: image.gif)

## File history

Click on a date/time to view the file as it appeared at that time.

	Date/Time	Thumbnail	Dimensions	User	Comment
current	<u>15:07, 17 December 2016</u>		469 × 476 (16 KB)	<a href="#">DL6rai</a> (talk   <a href="#">contribs</a> )	
	<u>21:29, 2 August 2009</u>		156 × 88 (6 KB)	<a href="#">DL4NER</a> (talk   <a href="#">contribs</a> )	

You cannot overwrite this file.

## File usage

The following page uses this file:

- [Menu:Windows](#)

## Metadata

This file contains additional information, probably added from the digital camera or scanner used to create or digitize it.

If the file has been modified from its original state, some details may not fully reflect the modified file.

**Horizontal resolution** 37.79 dpc

**Vertical resolution** 37.79 dpc

## Namespaces

- [File](#)
- [Discussion](#)

## Variants

## Views

- [Read](#)
- [View source](#)
- [View history](#)



## More

- This page was last edited on 17 December 2016, at 15:07.

- [Privacy policy](#)
- [About Win-Test Wiki](#)
- [Disclaimers](#)



# File:ContestRecorderExtractQSO.PNG

From Win-Test Wiki

[Jump to navigation](#) [Jump to search](#)

- [File](#)
- [File history](#)
- [File usage](#)
- [Metadata](#)

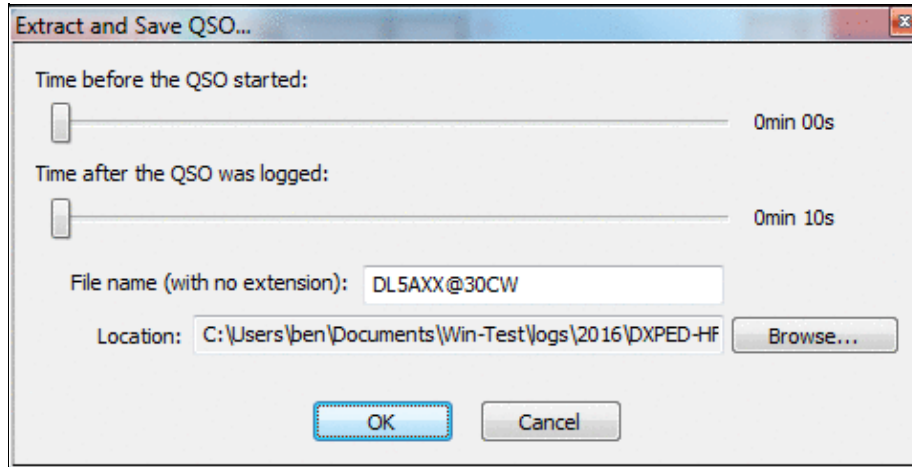

No higher resolution available.

[ContestRecorderExtractQSO.PNG](#) (479 × 243 pixels, file size: 21 KB, MIME type: image.gif)

## File history

Click on a date/time to view the file as it appeared at that time.

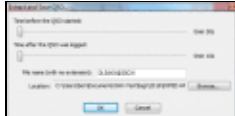
	Date/Time	Thumbnail	Dimensions	User	Comment
current	<a href="#">15:18, 17 December 2016</a>		479 × 243 (21 KB)	<a href="#">Dl6rai</a> ( <a href="#">talk</a>   <a href="#">contribs</a> )	

You cannot overwrite this file.

## File usage

The following page uses this file:

- [Menu:Windows](#)

## Metadata

This file contains additional information, probably added from the digital camera or scanner used to create or digitize it.

If the file has been modified from its original state, some details may not fully reflect the modified file.

**Horizontal resolution** 37.79 dpc

**Vertical resolution** 37.79 dpc

## Namespaces

- [File](#)
- [Discussion](#)

## Variants

## Views

- [Read](#)
- [View source](#)
- [View history](#)

## More

- This page was last edited on 17 December 2016, at 15:18.

- [Privacy policy](#)
- [About Win-Test Wiki](#)
- [Disclaimers](#)

-  The logo consists of a small sun icon to the left of the text "Powered By MediaWiki".

# File:ContestRecorderExtractQSO.PNG

From Win-Test Wiki

[Jump to navigation](#) [Jump to search](#)

- [File](#)
- [File history](#)
- [File usage](#)
- [Metadata](#)

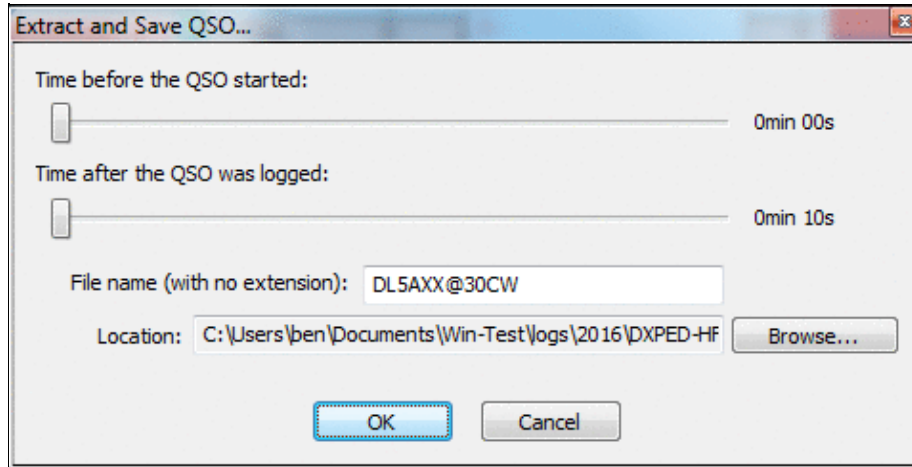

No higher resolution available.

[ContestRecorderExtractQSO.PNG](#) (479 × 243 pixels, file size: 21 KB, MIME type: image.gif)

## File history

Click on a date/time to view the file as it appeared at that time.

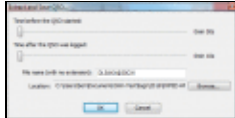
	Date/Time	Thumbnail	Dimensions	User	Comment
current	<a href="#">15:18, 17 December 2016</a>		479 × 243 (21 KB)	<a href="#">Dl6rai</a> ( <a href="#">talk</a>   <a href="#">contribs</a> )	

You cannot overwrite this file.

## File usage

The following page uses this file:

- [Menu:Windows](#)

## Metadata

This file contains additional information, probably added from the digital camera or scanner used to create or digitize it.

If the file has been modified from its original state, some details may not fully reflect the modified file.

**Horizontal resolution** 37.79 dpc

**Vertical resolution** 37.79 dpc

## Namespaces

- [File](#)
- [Discussion](#)

## Variants

## Views

- [Read](#)
- [View source](#)
- [View history](#)

## More

- This page was last edited on 17 December 2016, at 15:18.

- [Privacy policy](#)
- [About Win-Test Wiki](#)
- [Disclaimers](#)



# File:ContestRecorder.PNG

From Win-Test Wiki

[Jump to navigation](#) [Jump to search](#)

- [File](#)
- [File history](#)
- [File usage](#)
- [Metadata](#)

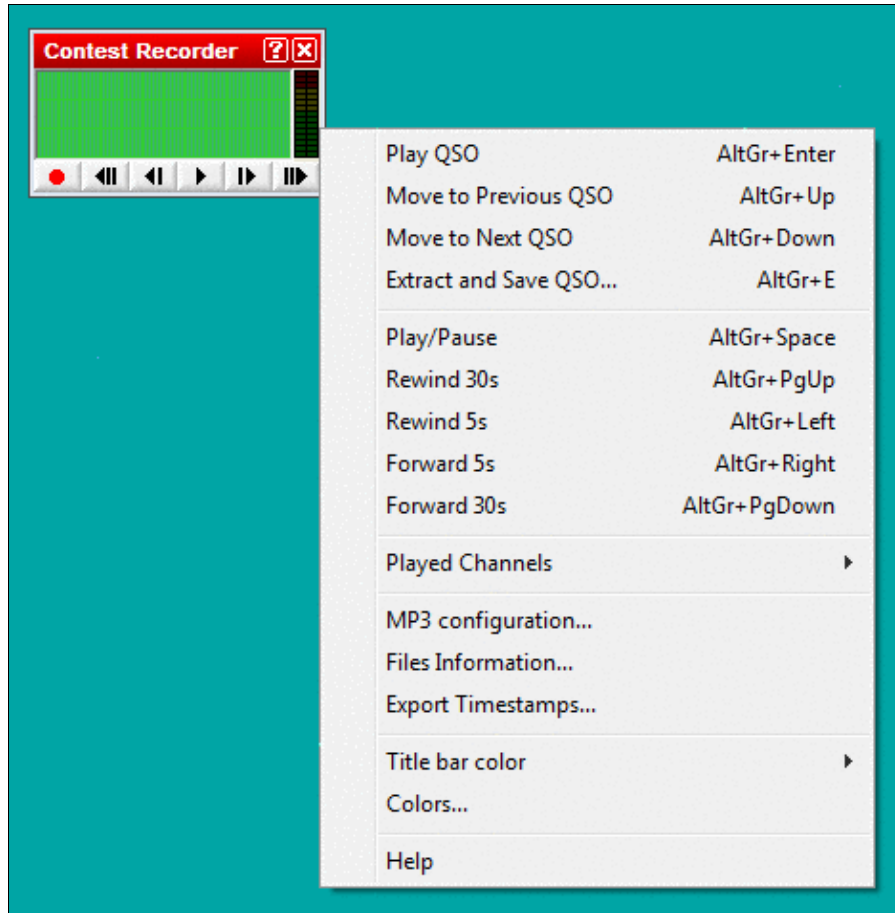



No higher resolution available.

ContestRecorder.PNG (469 × 476 pixels, file size: 16 KB, MIME type: image.gif)

## File history

Click on a date/time to view the file as it appeared at that time.

	Date/Time	Thumbnail	Dimensions	User	Comment
current	<u>15:07, 17 December 2016</u>		469 × 476 (16 KB)	<a href="#">DL6rai</a> (talk   <a href="#">contribs</a> )	
	<u>21:29, 2 August 2009</u>		156 × 88 (6 KB)	<a href="#">DL4NER</a> (talk   <a href="#">contribs</a> )	

You cannot overwrite this file.

## File usage

The following page uses this file:

- [Menu:Windows](#)

## Metadata

This file contains additional information, probably added from the digital camera or scanner used to create or digitize it.

If the file has been modified from its original state, some details may not fully reflect the modified file.

**Horizontal resolution** 37.79 dpc

**Vertical resolution** 37.79 dpc

## Namespaces

- [File](#)
- [Discussion](#)

## Variants

## Views

- [Read](#)
- [View source](#)
- [View history](#)

## More

- This page was last edited on 17 December 2016, at 15:07.

- [Privacy policy](#)
- [About Win-Test Wiki](#)
- [Disclaimers](#)





# File:Copyastext.PNG

From Win-Test Wiki

[Jump to navigation](#) [Jump to search](#)

- [File](#)
- [File history](#)
- [File usage](#)

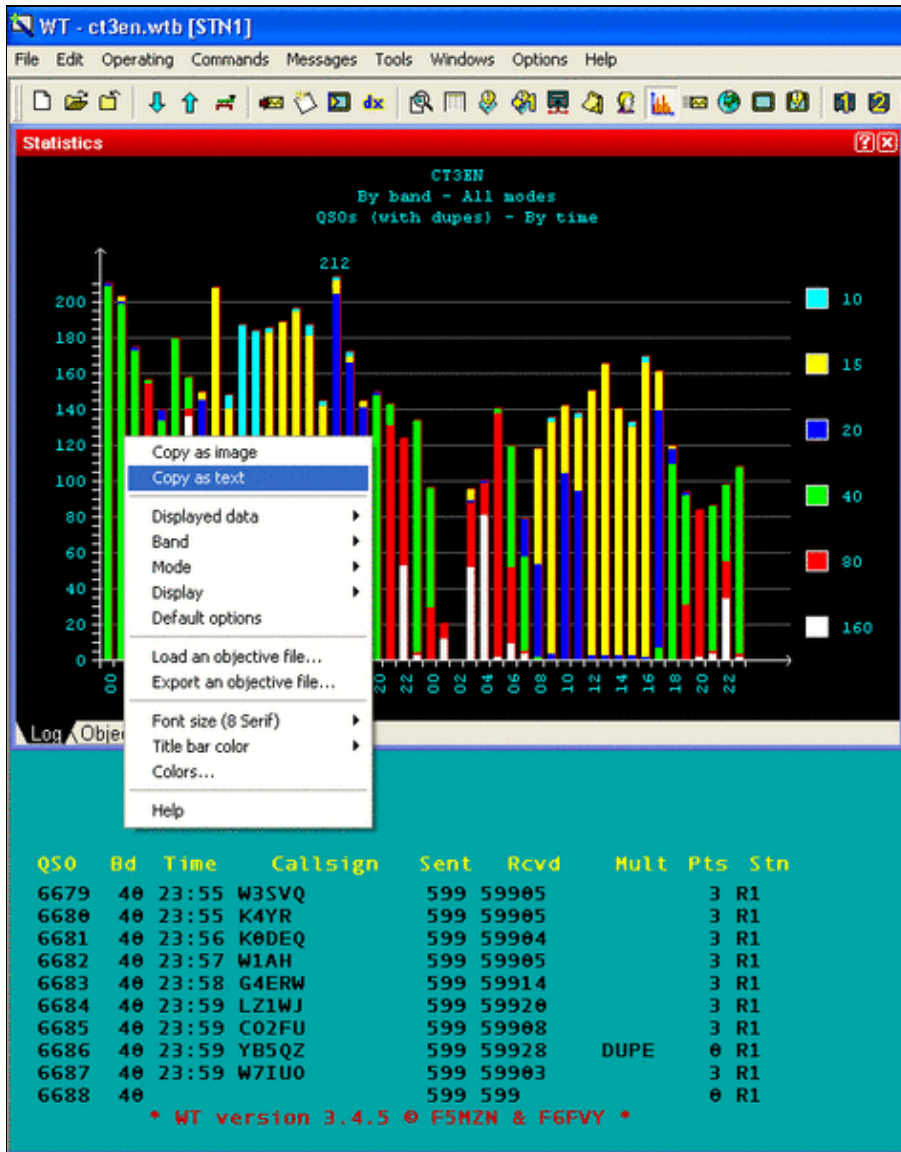

Size of this preview: [800 Å 600 pixels](#). Other resolutions: [320 Å 240 pixels](#) | [1,024 Å 768 pixels](#).  
[Original file](#) (1,024 Å 768 pixels, file size: 44 KB, MIME type: image.gif)

## File history

Click on a date/time to view the file as it appeared at that time.

	Date/Time	Thumbnail	Dimensions	User	Comment
current	<a href="#">15:33, 13 October 2006</a>		1,024 Å 768 (44 KB)	<a href="#">Ct1boh</a> ( <a href="#">talk</a>   <a href="#">contribs</a> )	

You cannot overwrite this file.

## File usage

The following page uses this file:

- [Extracting log Information](#)

## Namespaces

- [File](#)
- [Discussion](#)

## Variants

## Views

- [Read](#)
- [View source](#)
- [View history](#)

## More

- This page was last edited on 13 October 2006, at 15:33.

- [Privacy policy](#)
- [About Win-Test Wiki](#)
- [Disclaimers](#)



# File:Copyastext.PNG

From Win-Test Wiki

[Jump to navigation](#) [Jump to search](#)

- [File](#)
- [File history](#)
- [File usage](#)

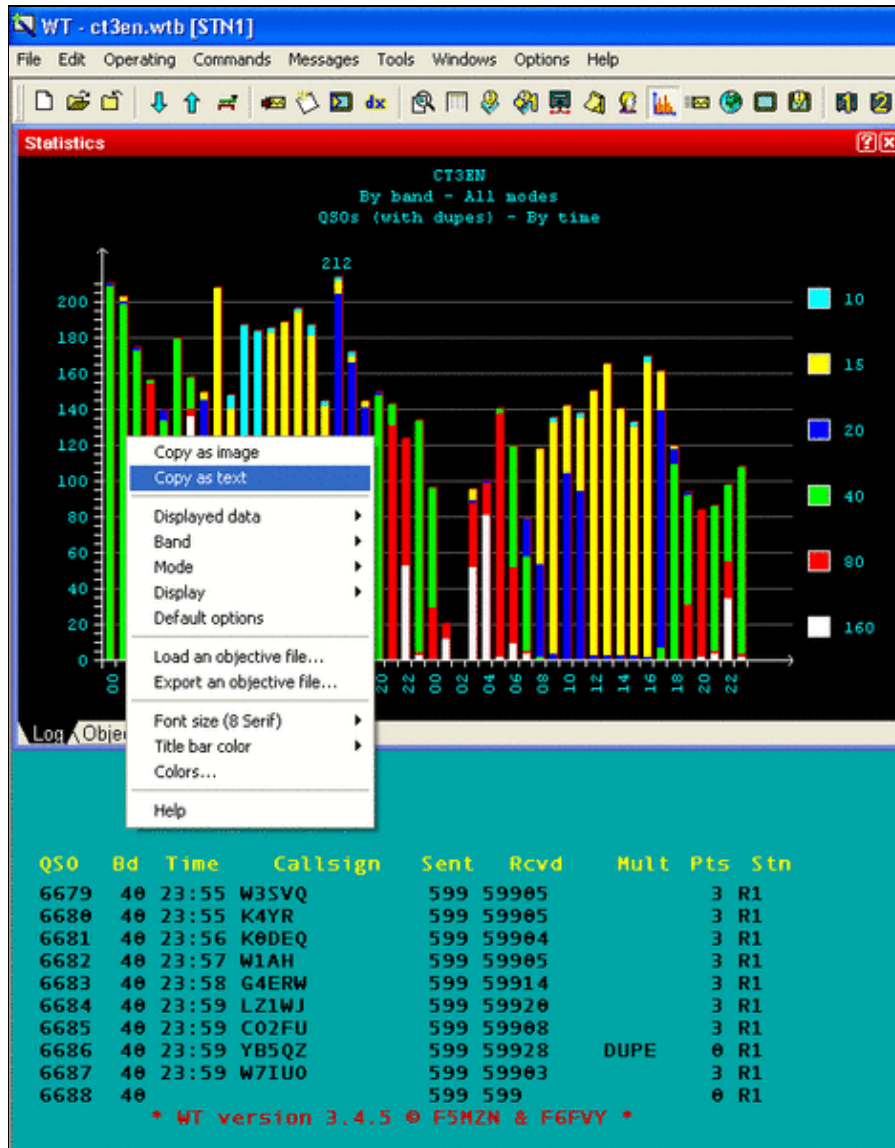

Size of this preview: [800 Å 600 pixels](#). Other resolutions: [320 Å 240 pixels](#) | [1,024 Å 768 pixels](#).  
[Original file](#) (1,024 Å 768 pixels, file size: 44 KB, MIME type: image.gif)

## File history

Click on a date/time to view the file as it appeared at that time.

	Date/Time	Thumbnail	Dimensions	User	Comment
current	<a href="#">15:33, 13 October 2006</a>		1,024 Å 768 (44 KB)	<a href="#">Ct1boh</a> ( <a href="#">talk</a>   <a href="#">contribs</a> )	

You cannot overwrite this file.

## File usage

The following page uses this file:

- [Extracting log Information](#)

## Namespaces

- [File](#)
- [Discussion](#)

## Variants

## Views

- [Read](#)
- [View source](#)
- [View history](#)

## More

- This page was last edited on 13 October 2006, at 15:33.

- [Privacy policy](#)
- [About Win-Test Wiki](#)
- [Disclaimers](#)



# File:Creating.gif

From Win-Test Wiki

[Jump to navigation](#) [Jump to search](#)

- [File](#)
- [File history](#)
- [File usage](#)

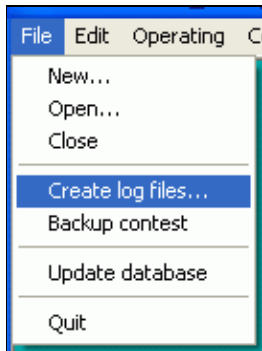

No higher resolution available.

[Creating.gif](#) (134 × 181 pixels, file size: 3 KB, MIME type: image/gif)

## File history

Click on a date/time to view the file as it appeared at that time.

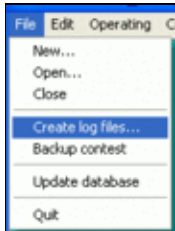
	Date/Time	Thumbnail	Dimensions	User	Comment
current	<a href="#">07:39, 3 December 2006</a>		134 × 181 (3 KB)	<a href="#">Dl6rai</a> ( <a href="#">talk</a>   <a href="#">contribs</a> )	

You cannot overwrite this file.

## File usage

The following page uses this file:

- [Creating](#)

## Namespaces

- [File](#)
- [Discussion](#)

## Variants

## Views

- [Read](#)
- [View source](#)
- [View history](#)

## More

- This page was last edited on 3 December 2006, at 07:39.

- [Privacy policy](#)
- [About Win-Test Wiki](#)
- [Disclaimers](#)



# File:CreatingAdifOptions.gif

From Win-Test Wiki

[Jump to navigation](#) [Jump to search](#)

- [File](#)
- [File history](#)
- [File usage](#)

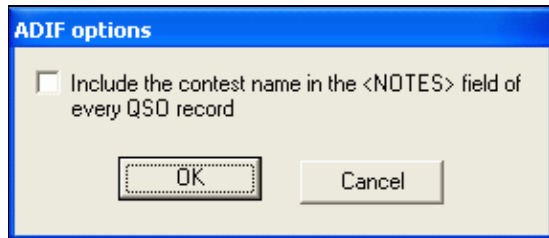

No higher resolution available.

[CreatingAdifOptions.gif](#) (285 × 122 pixels, file size: 5 KB, MIME type: image/gif)

## File history

Click on a date/time to view the file as it appeared at that time.

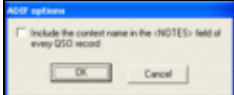
	Date/Time	Thumbnail	Dimensions	User	Comment
current	<a href="#">07:39, 3 December 2006</a>		285 × 122 (5 KB)	<a href="#">Dl6rai</a> ( <a href="#">talk</a>   <a href="#">contribs</a> )	

You cannot overwrite this file.

## File usage

The following page uses this file:

- [Creating](#)

## Namespaces

- [File](#)
- [Discussion](#)

## Variants

## Views

- [Read](#)
- [View source](#)
- [View history](#)

## More

- This page was last edited on 3 December 2006, at 07:39.

- [Privacy policy](#)
- [About Win-Test Wiki](#)
- [Disclaimers](#)





# File:CreatingAdifOptions.gif

From Win-Test Wiki

[Jump to navigation](#) [Jump to search](#)

- [File](#)
- [File history](#)
- [File usage](#)

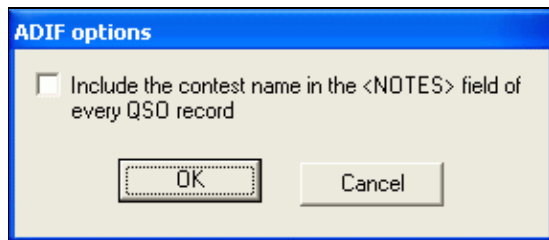

No higher resolution available.

[CreatingAdifOptions.gif](#) (285 × 122 pixels, file size: 5 KB, MIME type: image/gif)

## File history

Click on a date/time to view the file as it appeared at that time.

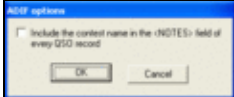
	Date/Time	Thumbnail	Dimensions	User	Comment
current	<a href="#">07:39, 3 December 2006</a>		285 × 122 (5 KB)	<a href="#">Dl6rai</a> ( <a href="#">talk</a>   <a href="#">contribs</a> )	

You cannot overwrite this file.

## File usage

The following page uses this file:

- [Creating](#)

## Namespaces

- [File](#)
- [Discussion](#)

## Variants

## Views

- [Read](#)
- [View source](#)
- [View history](#)

## More

- This page was last edited on 3 December 2006, at 07:39.

- [Privacy policy](#)
- [About Win-Test Wiki](#)
- [Disclaimers](#)



# File:CreatingCabrilloOptions.gif

From Win-Test Wiki

[Jump to navigation](#) [Jump to search](#)

- [File](#)
- [File history](#)
- [File usage](#)

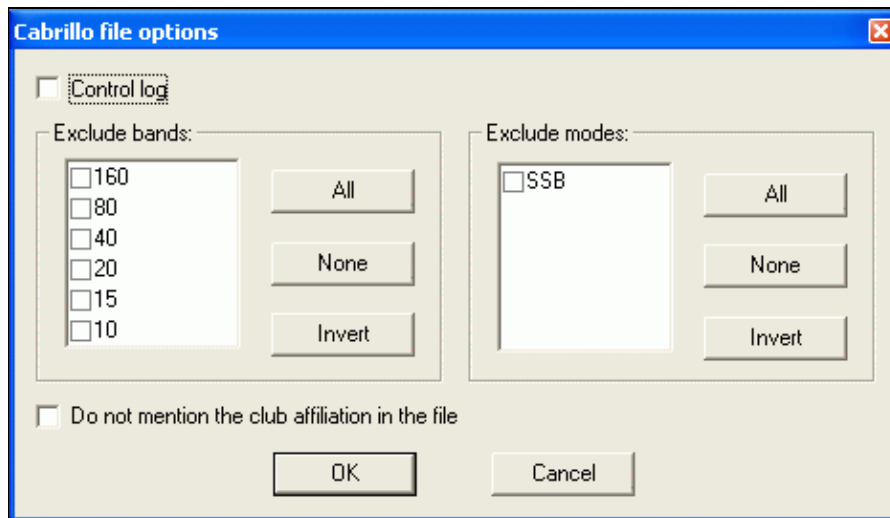

No higher resolution available.

[CreatingCabrilloOptions.gif](#) (467 × 269 pixels, file size: 10 KB, MIME type: image/gif)

## File history

Click on a date/time to view the file as it appeared at that time.

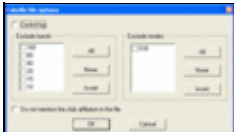
	Date/Time	Thumbnail	Dimensions	User	Comment
current	<a href="#">07:39, 3 December 2006</a>		467 × 269 (10 KB)	<a href="#">Dl6rai</a> ( <a href="#">talk</a>   <a href="#">contribs</a> )	

You cannot overwrite this file.

## File usage

The following page uses this file:

- [Creating](#)

## Namespaces

- [File](#)
- [Discussion](#)

## Variants

## Views

- [Read](#)
- [View source](#)
- [View history](#)

## More

- This page was last edited on 3 December 2006, at 07:39.

- [Privacy policy](#)
- [About Win-Test Wiki](#)
- [Disclaimers](#)



# File:CreatingCabrilloOptions.gif

From Win-Test Wiki

[Jump to navigation](#) [Jump to search](#)

- [File](#)
- [File history](#)
- [File usage](#)

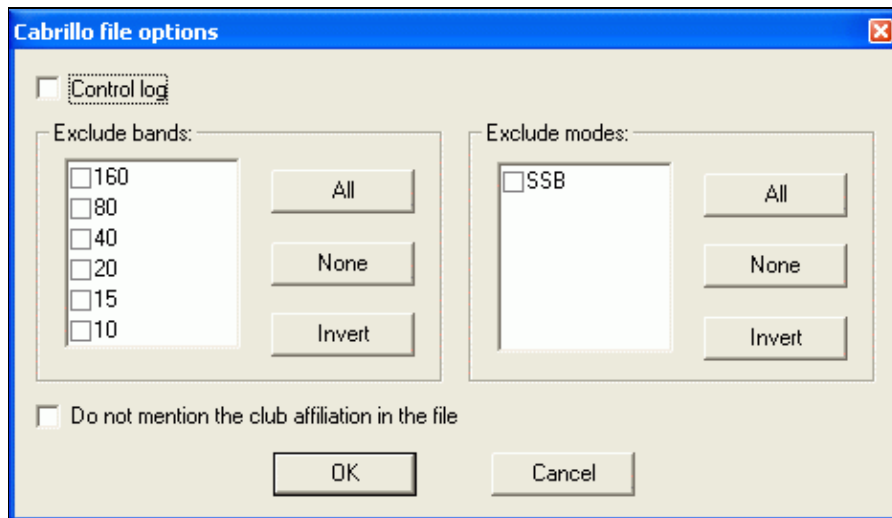

No higher resolution available.

[CreatingCabrilloOptions.gif](#) (467 × 269 pixels, file size: 10 KB, MIME type: image/gif)

## File history

Click on a date/time to view the file as it appeared at that time.

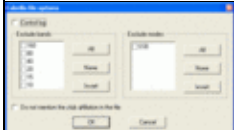
	Date/Time	Thumbnail	Dimensions	User	Comment
current	<a href="#">07:39, 3 December 2006</a>		467 × 269 (10 KB)	<a href="#">Dl6rai</a> ( <a href="#">talk</a>   <a href="#">contribs</a> )	

You cannot overwrite this file.

## File usage

The following page uses this file:

- [Creating](#)

## Namespaces

- [File](#)
- [Discussion](#)

## Variants

## Views

- [Read](#)
- [View source](#)
- [View history](#)

## More

- This page was last edited on 3 December 2006, at 07:39.

- [Privacy policy](#)
- [About Win-Test Wiki](#)
- [Disclaimers](#)



# File:CreatingCSVFileOptions.gif

From Win-Test Wiki

[Jump to navigation](#) [Jump to search](#)

- [File](#)
- [File history](#)
- [File usage](#)

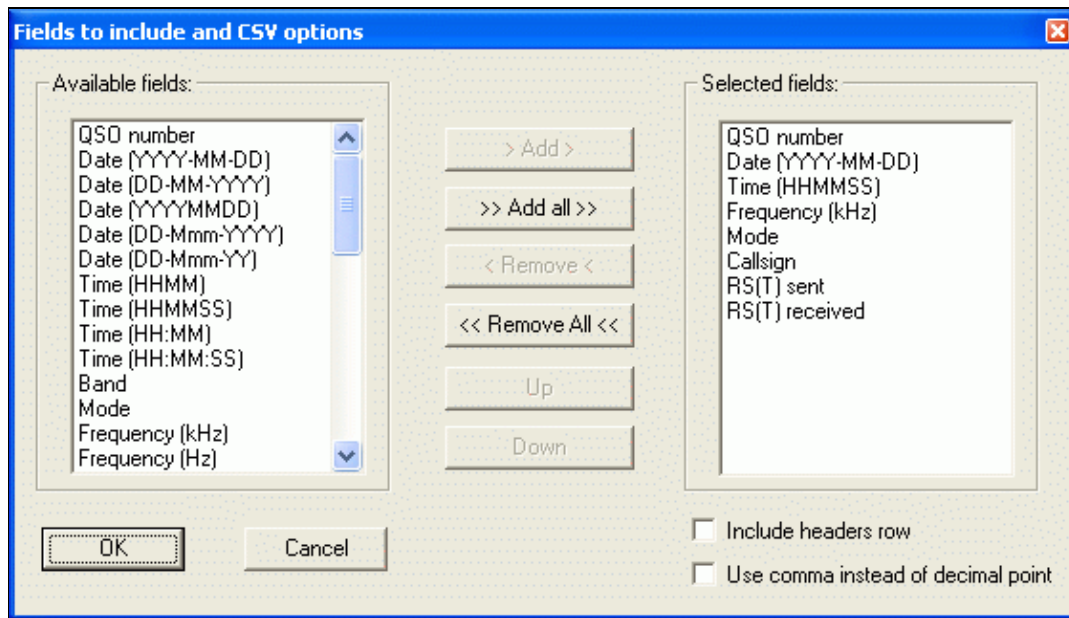

No higher resolution available.

[CreatingCSVFileOptions.gif](#) (560 × 320 pixels, file size: 19 KB, MIME type: image/gif)

## File history

Click on a date/time to view the file as it appeared at that time.

	Date/Time	Thumbnail	Dimensions	User	Comment
current	<a href="#">07:41, 3 December 2006</a>		560 × 320 (19 KB)	<a href="#">Dl6rai</a> ( <a href="#">talk</a>   <a href="#">contribs</a> )	

You cannot overwrite this file.

## File usage

The following page uses this file:

- [Creating](#)

## Namespaces

- [File](#)
- [Discussion](#)

## Variants

## Views

- [Read](#)
- [View source](#)
- [View history](#)

## More

- This page was last edited on 3 December 2006, at 07:41.
- [Privacy policy](#)
- [About Win-Test Wiki](#)
- [Disclaimers](#)





# File:CreatingCSVFileOptions.gif

From Win-Test Wiki

[Jump to navigation](#) [Jump to search](#)

- [File](#)
- [File history](#)
- [File usage](#)

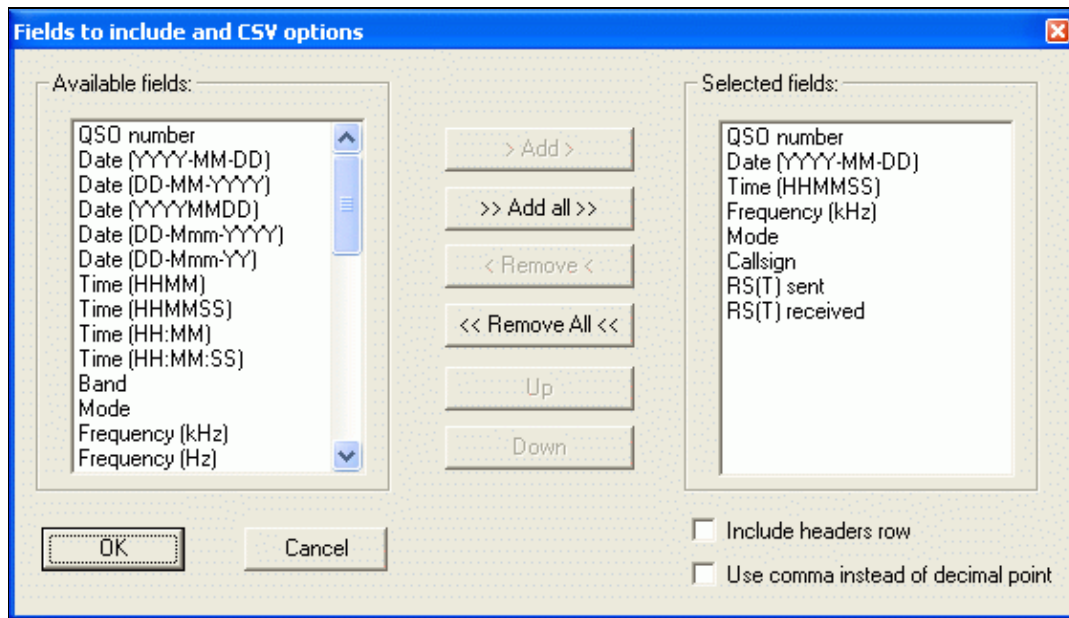

No higher resolution available.

[CreatingCSVFileOptions.gif](#) (560 × 320 pixels, file size: 19 KB, MIME type: image/gif)

## File history

Click on a date/time to view the file as it appeared at that time.

	Date/Time	Thumbnail	Dimensions	User	Comment
current	<a href="#">07:41, 3 December 2006</a>		560 × 320 (19 KB)	<a href="#">Dl6rai</a> ( <a href="#">talk</a>   <a href="#">contribs</a> )	

You cannot overwrite this file.

## File usage

The following page uses this file:

- [Creating](#)

## Namespaces

- [File](#)
- [Discussion](#)

## Variants

## Views

- [Read](#)
- [View source](#)
- [View history](#)

## More

- This page was last edited on 3 December 2006, at 07:41.
- [Privacy policy](#)
- [About Win-Test Wiki](#)
- [Disclaimers](#)



# File:Creating.gif

From Win-Test Wiki

[Jump to navigation](#) [Jump to search](#)

- [File](#)
- [File history](#)
- [File usage](#)

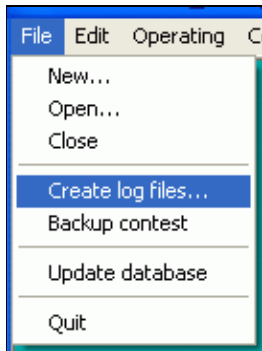

No higher resolution available.

[Creating.gif](#) (134 × 181 pixels, file size: 3 KB, MIME type: image/gif)

## File history

Click on a date/time to view the file as it appeared at that time.

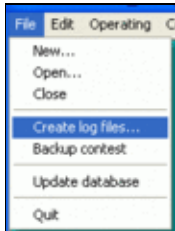
	Date/Time	Thumbnail	Dimensions	User	Comment
current	<a href="#">07:39, 3 December 2006</a>		134 × 181 (3 KB)	<a href="#">Dl6rai</a> ( <a href="#">talk</a>   <a href="#">contribs</a> )	

You cannot overwrite this file.

## File usage

The following page uses this file:

- [Creating](#)

## Namespaces

- [File](#)
- [Discussion](#)

## Variants

## Views

- [Read](#)
- [View source](#)
- [View history](#)

## More

- This page was last edited on 3 December 2006, at 07:39.

- [Privacy policy](#)
- [About Win-Test Wiki](#)
- [Disclaimers](#)



# File:CreatingLogsearchFileOptions.PNG

From Win-Test Wiki

[Jump to navigation](#) [Jump to search](#)

- [File](#)
- [File history](#)
- [File usage](#)

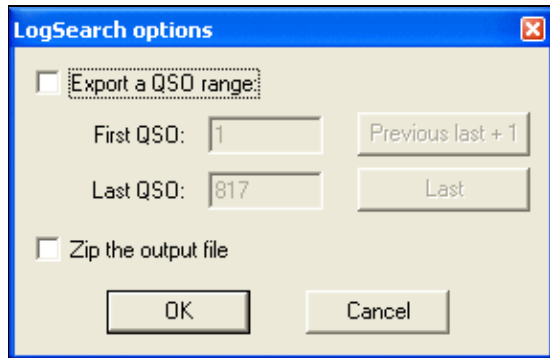

No higher resolution available.

[CreatingLogsearchFileOptions.PNG](#) (285 Å 185 pixels, file size: 6 KB, MIME type: image.gif)

## File history

Click on a date/time to view the file as it appeared at that time.

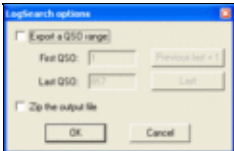
	Date/Time	Thumbnail	Dimensions	User	Comment
current	<a href="#">21:12, 3 June 2008</a>		285 Å 185 (6 KB)	<a href="#">D16rai</a> ( <a href="#">talk</a>   <a href="#">contribs</a> )	

You cannot overwrite this file.

## File usage

The following page uses this file:

- [Creating](#)

## Namespaces

- [File](#)
- [Discussion](#)

## Variants

## Views

- [Read](#)
- [View source](#)
- [View history](#)

## More

- This page was last edited on 3 June 2008, at 21:12.

- [Privacy policy](#)
- [About Win-Test Wiki](#)
- [Disclaimers](#)



# File:CreatingLogsearchFileOptions.PNG

From Win-Test Wiki

[Jump to navigation](#) [Jump to search](#)

- [File](#)
- [File history](#)
- [File usage](#)

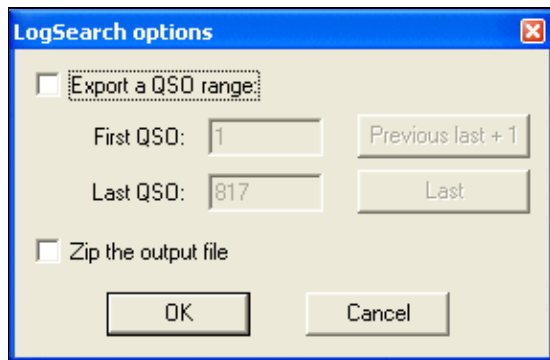

No higher resolution available.

[CreatingLogsearchFileOptions.PNG](#) (285 × 185 pixels, file size: 6 KB, MIME type: image/gif)

## File history

Click on a date/time to view the file as it appeared at that time.

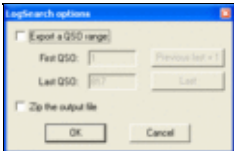
	Date/Time	Thumbnail	Dimensions	User	Comment
current	<a href="#">21:12, 3 June 2008</a>		285 × 185 (6 KB)	<a href="#">D16rai</a> ( <a href="#">talk</a>   <a href="#">contribs</a> )	

You cannot overwrite this file.

## File usage

The following page uses this file:

- [Creating](#)

## Namespaces

- [File](#)
- [Discussion](#)

## Variants

## Views

- [Read](#)
- [View source](#)
- [View history](#)

## More

- This page was last edited on 3 June 2008, at 21:12.

- [Privacy policy](#)
- [About Win-Test Wiki](#)
- [Disclaimers](#)





# File:CreatingReg1Test.gif

From Win-Test Wiki

[Jump to navigation](#) [Jump to search](#)

- [File](#)
- [File history](#)
- [File usage](#)

**Needed data for the REG1TEST format**

**Band: 144 MHz**

Information about the station and the contest

Contest name:

Station address:

Station address:

Club of affiliation:

RX equipment:

TX equipment:

Antennas:

Power (in watts):

Antenna height:

Station altitude:

Station owner

Name:

Callsign:

Address:

Address:

Postal code:

City:

Country:

Phone num:

E-mail / BBS:

No higher resolution available.

[CreatingReg1Test.gif](#) (612 × 369 pixels, file size: 24 KB, MIME type: image/gif)

## File history

Click on a date/time to view the file as it appeared at that time.

	Date/Time	Thumbnail	Dimensions	User	Comment
current	<a href="#">07:40, 3 December 2006</a>		612 × 369 (24 KB)	<a href="#">DL6rai</a> ( <a href="#">talk</a>   <a href="#">contribs</a> )	

You cannot overwrite this file.

## File usage

The following page uses this file:

- [Creating](#)

## Namespaces

- [File](#)
- [Discussion](#)

## Variants

## Views

- [Read](#)
- [View source](#)
- [View history](#)

## More

- This page was last edited on 3 December 2006, at 07:40.

- [Privacy policy](#)
- [About Win-Test Wiki](#)
- [Disclaimers](#)



# File:CreatingReg1Test.gif

From Win-Test Wiki

[Jump to navigation](#) [Jump to search](#)

- [File](#)
- [File history](#)
- [File usage](#)

**Needed data for the REG1TEST format**

**Band: 144 MHz**

Information about the station and the contest

Contest name:

Station address:

Station address:

Club of affiliation:

RX equipment:

TX equipment:

Antennas:

Power (in watts):

Antenna height:

Station altitude:

Station owner

Name:

Callsign:

Address:

Address:

Postal code:

City:

Country:

Phone num:

E-mail / BBS:

No higher resolution available.

[CreatingReg1Test.gif](#) (612 × 369 pixels, file size: 24 KB, MIME type: image/gif)

## File history

Click on a date/time to view the file as it appeared at that time.

	Date/Time	Thumbnail	Dimensions	User	Comment
current	<a href="#">07:40, 3 December 2006</a>		612 × 369 (24 KB)	<a href="#">DL6rai</a> ( <a href="#">talk</a>   <a href="#">contribs</a> )	

You cannot overwrite this file.

## File usage

The following page uses this file:

- [Creating](#)

## Namespaces

- [File](#)
- [Discussion](#)

## Variants

## Views

- [Read](#)
- [View source](#)
- [View history](#)

## More

- This page was last edited on 3 December 2006, at 07:40.

- [Privacy policy](#)
- [About Win-Test Wiki](#)
- [Disclaimers](#)



# File:CreatingTextFileOptions.gif

From Win-Test Wiki

[Jump to navigation](#) [Jump to search](#)

- [File](#)
- [File history](#)
- [File usage](#)

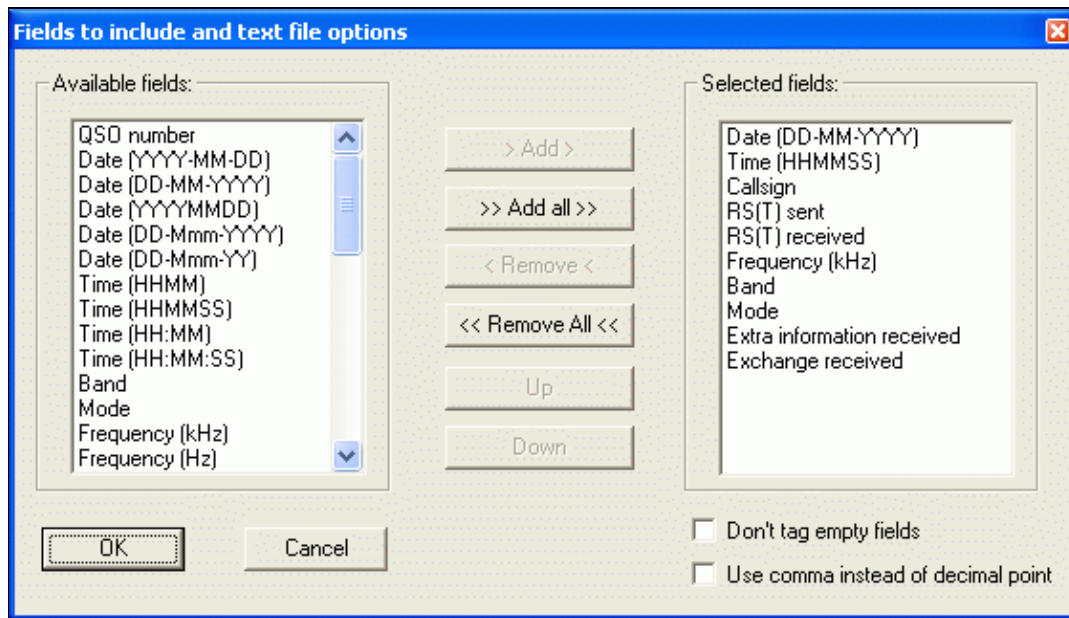

No higher resolution available.

[CreatingTextFileOptions.gif](#) (560 Å 320 pixels, file size: 19 KB, MIME type: image/gif)

## File history

Click on a date/time to view the file as it appeared at that time.

	Date/Time	Thumbnail	Dimensions	User	Comment
current	<a href="#">07:40, 3 December 2006</a>		560 Å 320 (19 KB)	<a href="#">Dl6rai</a> ( <a href="#">talk</a>   <a href="#">contribs</a> )	

You cannot overwrite this file.

## File usage

The following page uses this file:

- [Creating](#)

## Namespaces

- [File](#)
- [Discussion](#)

## Variants

## Views

- [Read](#)
- [View source](#)
- [View history](#)

## More

- This page was last edited on 3 December 2006, at 07:40.
- [Privacy policy](#)
- [About Win-Test Wiki](#)
- [Disclaimers](#)



# File:CreatingTextFileOptions.gif

From Win-Test Wiki

[Jump to navigation](#) [Jump to search](#)

- [File](#)
- [File history](#)
- [File usage](#)

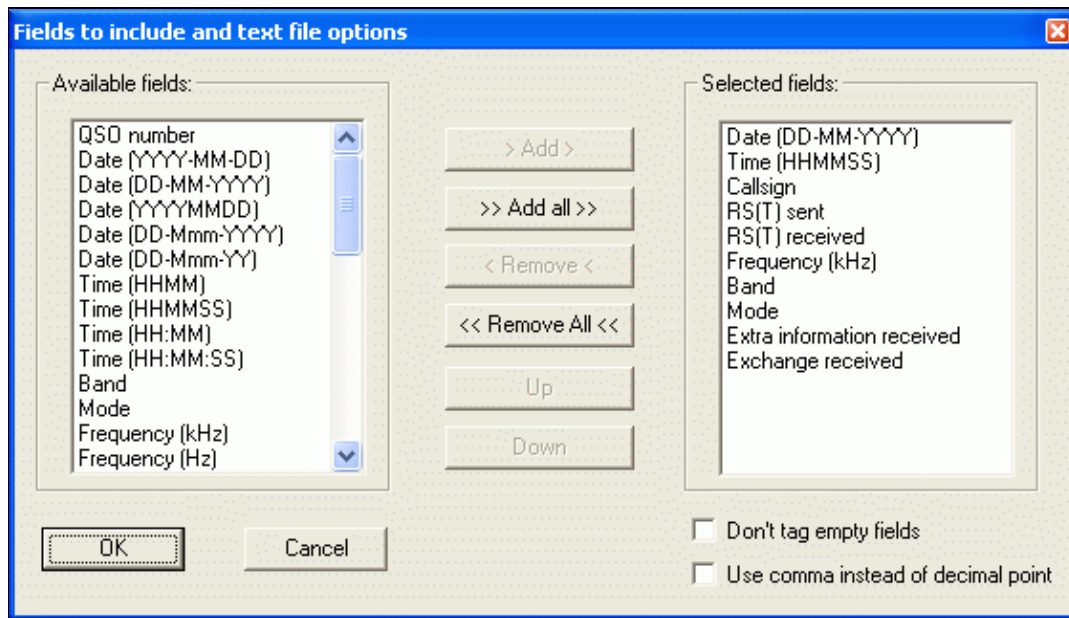

No higher resolution available.

[CreatingTextFileOptions.gif](#) (560 Å 320 pixels, file size: 19 KB, MIME type: image/gif)

## File history

Click on a date/time to view the file as it appeared at that time.

	Date/Time	Thumbnail	Dimensions	User	Comment
current	<a href="#">07:40, 3 December 2006</a>		560 Å 320 (19 KB)	<a href="#">Dl6rai</a> ( <a href="#">talk</a>   <a href="#">contribs</a> )	

You cannot overwrite this file.

## File usage

The following page uses this file:

- [Creating](#)

## Namespaces

- [File](#)
- [Discussion](#)

## Variants

## Views

- [Read](#)
- [View source](#)
- [View history](#)

## More

- This page was last edited on 3 December 2006, at 07:40.
- [Privacy policy](#)
- [About Win-Test Wiki](#)
- [Disclaimers](#)





# File: cw-additional-messages.gif

From Win-Test Wiki

[Jump to navigation](#) [Jump to search](#)

- [File](#)
- [File history](#)
- [File usage](#)
- [Metadata](#)

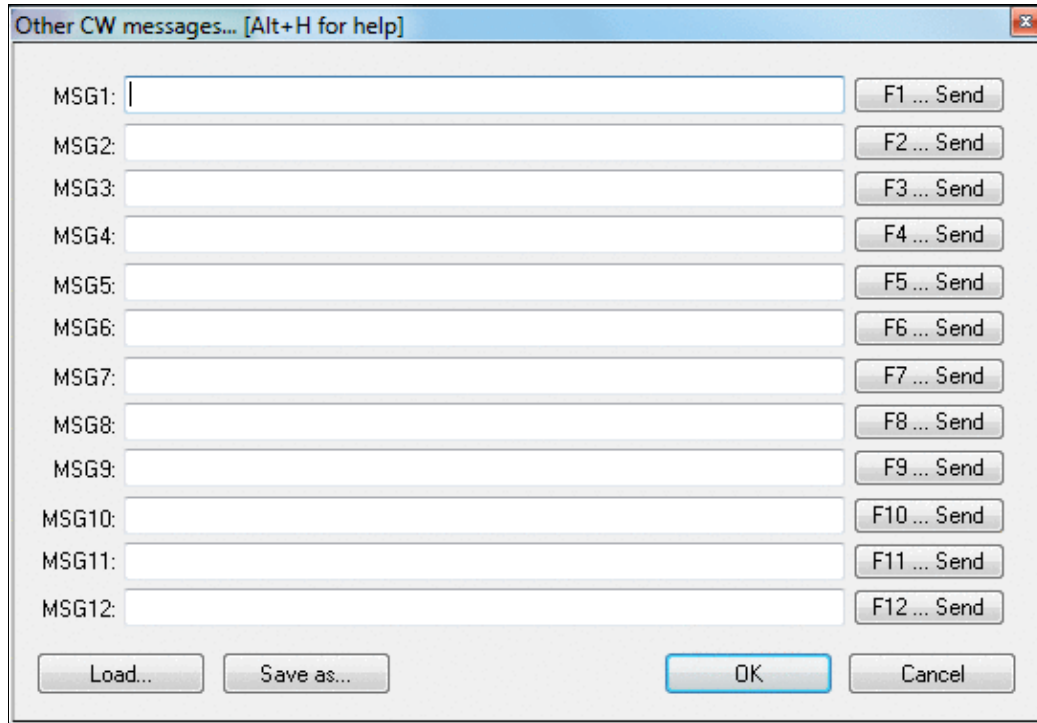

No higher resolution available.

[cw-additional-messages.gif](#) (542 × 377 pixels, file size: 20 KB, MIME type: image/gif)

## File history

Click on a date/time to view the file as it appeared at that time.

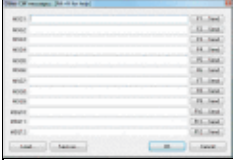
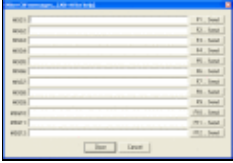
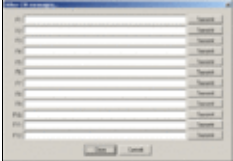
	Date/Time	Thumbnail	Dimensions	User	Comment
current	<a href="#">18:05, 17 December 2016</a>		542 × 377 (20 KB)	<a href="#">D16rai</a> ( <a href="#">talk</a>   <a href="#">contribs</a> )	
	<a href="#">08:22, 28 July 2007</a>		542 × 377 (15 KB)	<a href="#">N6TV</a> ( <a href="#">talk</a>   <a href="#">contribs</a> )	New version as of 3.14. Labels now MSG1-MSG12.
	<a href="#">20:57, 26 July 2006</a>		533 × 375 (6 KB)	<a href="#">DL4NER</a> ( <a href="#">talk</a>   <a href="#">contribs</a> )	

You cannot overwrite this file.

## File usage

The following 2 pages use this file:

- [Menu:Commands](#)
- [Menu:Options](#)

## Metadata

This file contains additional information, probably added from the digital camera or scanner used to create or digitize it.

If the file has been modified from its original state, some details may not fully reflect the modified file.

**Horizontal resolution** 37.79 dpc

**Vertical resolution** 37.79 dpc

## Namespaces

- [File](#)
- [Discussion](#)

## Variants

## Views

- [Read](#)
- [View source](#)
- [View history](#)

## More

- This page was last edited on 17 December 2016, at 18:05.

- [Privacy policy](#)
- [About Win-Test Wiki](#)
- [Disclaimers](#)



# File: cw-additional-messages.gif

From Win-Test Wiki

[Jump to navigation](#) [Jump to search](#)

- [File](#)
- [File history](#)
- [File usage](#)
- [Metadata](#)

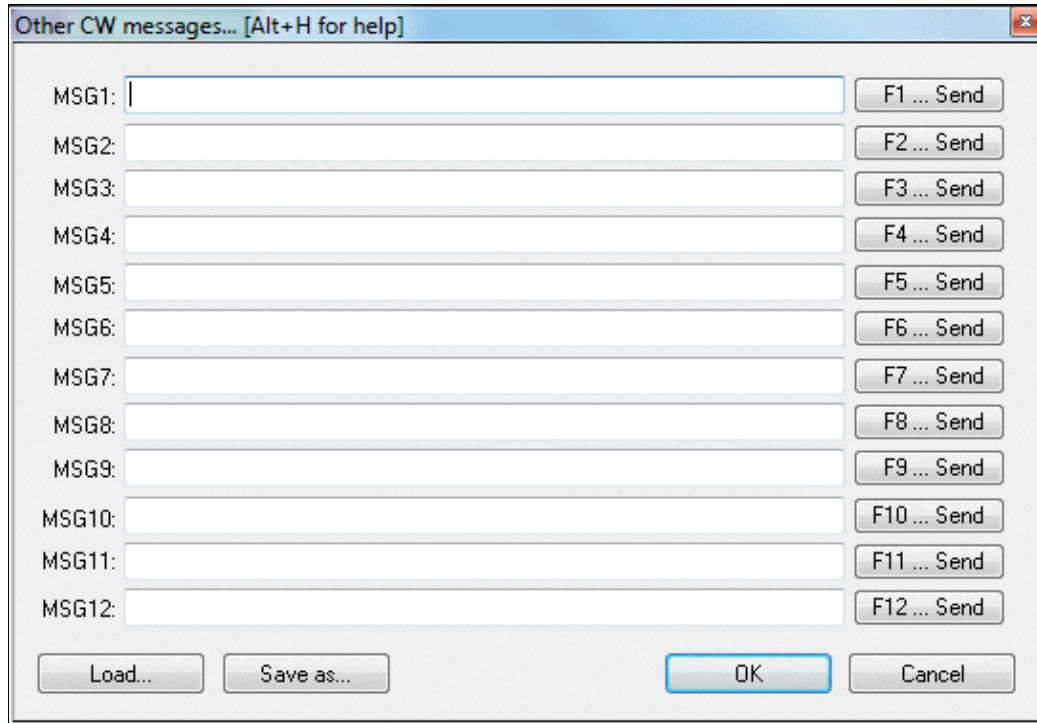



No higher resolution available.

[cw-additional-messages.gif](#) (542 × 377 pixels, file size: 20 KB, MIME type: image/gif)

## File history

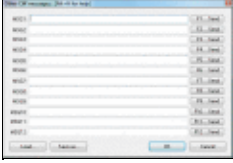
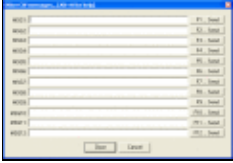
Click on a date/time to view the file as it appeared at that time.

	Date/Time	Thumbnail	Dimensions	User	Comment
current	<a href="#">18:05, 17 December 2016</a>		542 × 377 (20 KB)	<a href="#">D16rai</a> ( <a href="#">talk</a>   <a href="#">contribs</a> )	
	<a href="#">08:22, 28 July 2007</a>		542 × 377 (15 KB)	<a href="#">N6TV</a> ( <a href="#">talk</a>   <a href="#">contribs</a> )	New version as of 3.14. Labels now MSG1-MSG12.
	<a href="#">20:57, 26 July 2006</a>		533 × 375 (6 KB)	<a href="#">DL4NER</a> ( <a href="#">talk</a>   <a href="#">contribs</a> )	

You cannot overwrite this file.

## File usage

The following 2 pages use this file:

- [Menu:Commands](#)
- [Menu:Options](#)

## Metadata

This file contains additional information, probably added from the digital camera or scanner used to create or digitize it.

If the file has been modified from its original state, some details may not fully reflect the modified file.

**Horizontal resolution** 37.79 dpc

**Vertical resolution** 37.79 dpc

## Namespaces

- [File](#)
- [Discussion](#)

## Variants

## Views

- [Read](#)
- [View source](#)
- [View history](#)

## More

- This page was last edited on 17 December 2016, at 18:05.

- [Privacy policy](#)
- [About Win-Test Wiki](#)
- [Disclaimers](#)



# File: CWSerialNumberAbbreviation.PNG

From Win-Test Wiki

[Jump to navigation](#) [Jump to search](#)

- [File](#)
- [File history](#)
- [File usage](#)
- [Metadata](#)

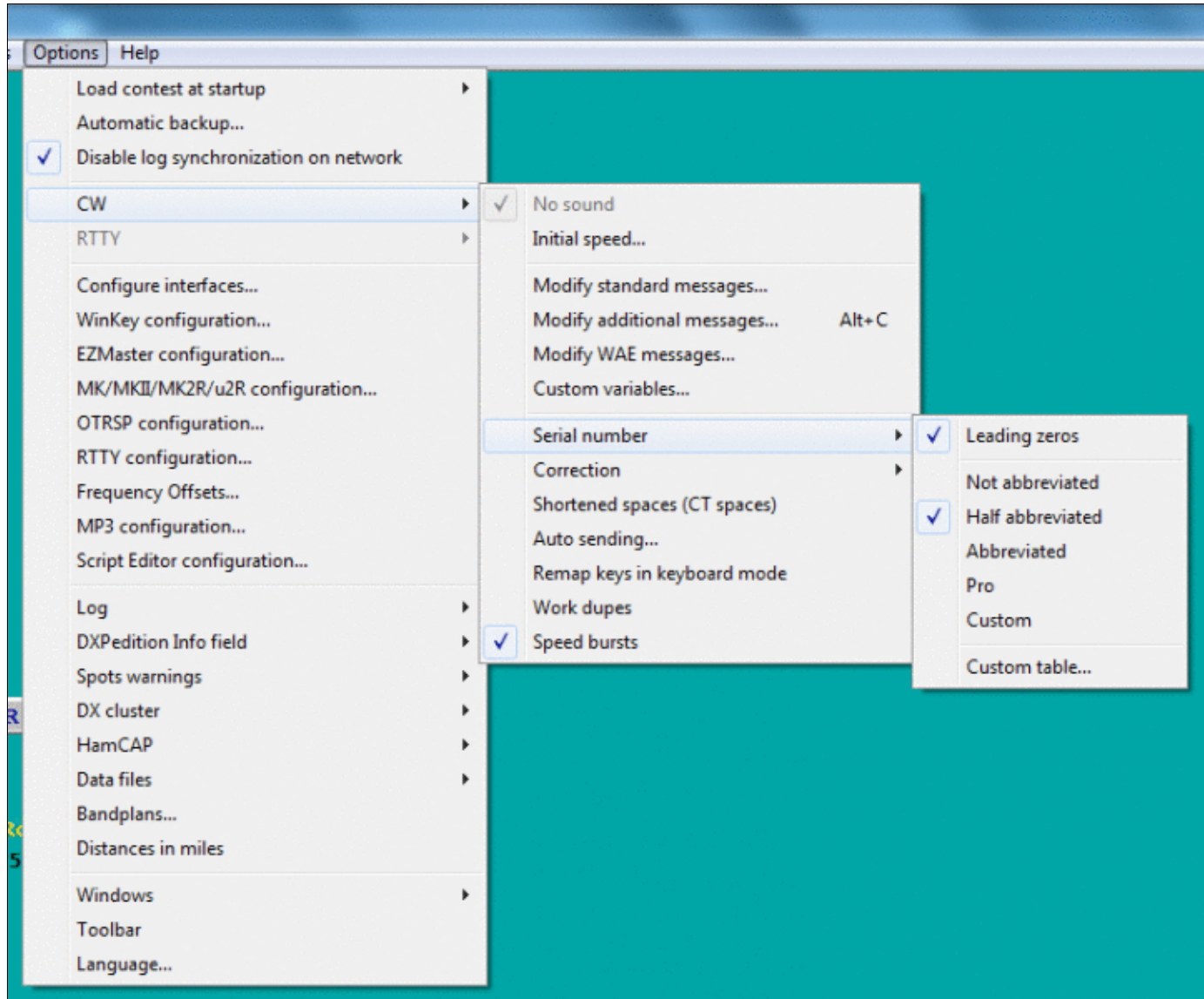

Size of this preview: 722 Å 600 pixels. Other resolutions: 289 Å 240 pixels | 769 Å 639 pixels. Original file (769 Å 639 pixels, file size: 50 KB, MIME type: image.gif)

Menu settings for sending CW serial number abbreviations

## File history

Click on a date/time to view the file as it appeared at that time.

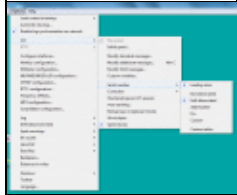
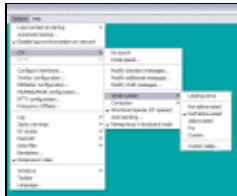
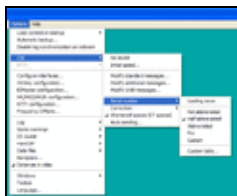
	Date/Time	Thumbnail	Dimensions	User	Comment
current	<u>13:59, 17 December 2016</u>		769 Å 639 (50 KB)	<u>D16rai (talk   contribs)</u>	
	<u>23:27, 2 February 2009</u>		550 Å 463 (20 KB)	<u>N6TV (talk   contribs)</u>	Includes new option "Remap keys in keyboard mode".
	<u>20:20, 6 September 2008</u>		551 Å 459 (20 KB)	<u>N6TV (talk   contribs)</u>	Menu settings for sending CW serial number abbreviations

You cannot overwrite this file.

## File usage

The following page uses this file:

- Menu:Options

## Metadata

This file contains additional information, probably added from the digital camera or scanner used to create or digitize it.

If the file has been modified from its original state, some details may not fully reflect the modified file.

**Horizontal resolution** 37.79 dpc

**Vertical resolution** 37.79 dpc



## Namespaces

- [File](#)
- [Discussion](#)

## Variants

## Views

- [Read](#)
- [View source](#)
- [View history](#)

## More

- This page was last edited on 17 December 2016, at 13:59.

- [Privacy policy](#)
- [About Win-Test Wiki](#)
- [Disclaimers](#)



# File:CWSerialNumberAbbreviation.PNG

From Win-Test Wiki

[Jump to navigation](#) [Jump to search](#)

- [File](#)
- [File history](#)
- [File usage](#)
- [Metadata](#)

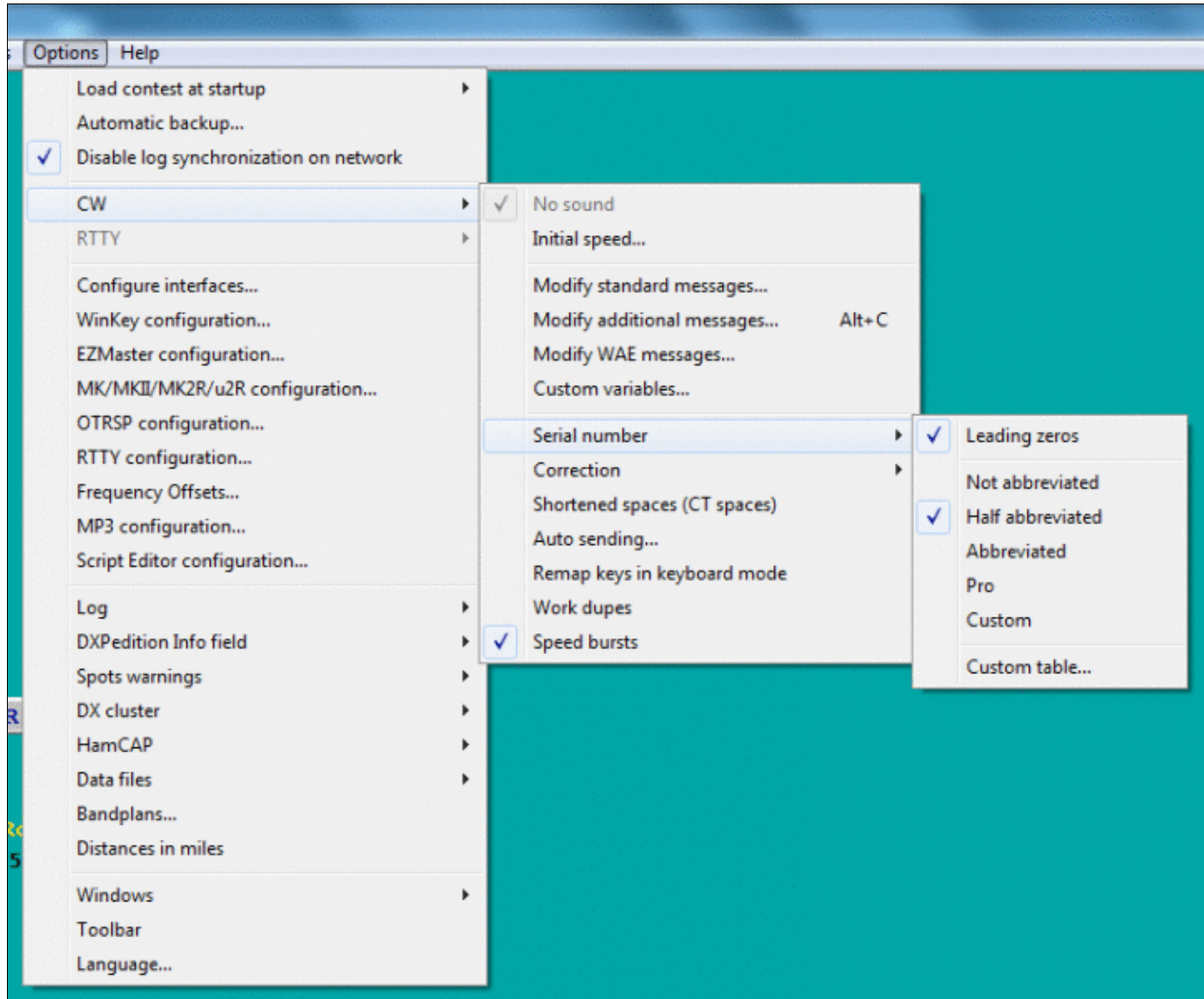

Size of this preview: 722 Å 600 pixels. Other resolutions: 289 Å 240 pixels | 769 Å 639 pixels. Original file (769 Å 639 pixels, file size: 50 KB, MIME type: image.gif)

Menu settings for sending CW serial number abbreviations

## File history

Click on a date/time to view the file as it appeared at that time.

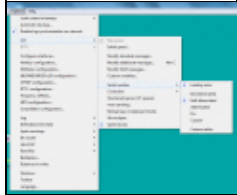
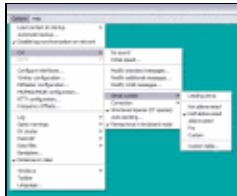
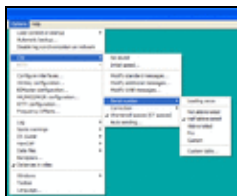
	Date/Time	Thumbnail	Dimensions	User	Comment
current	<u>13:59, 17 December 2016</u>		769 Å 639 (50 KB)	<u>D16rai (talk   contribs)</u>	
	<u>23:27, 2 February 2009</u>		550 Å 463 (20 KB)	<u>N6TV (talk   contribs)</u>	Includes new option "Remap keys in keyboard mode".
	<u>20:20, 6 September 2008</u>		551 Å 459 (20 KB)	<u>N6TV (talk   contribs)</u>	Menu settings for sending CW serial number abbreviations

You cannot overwrite this file.

## File usage

The following page uses this file:

- Menu:Options

## Metadata

This file contains additional information, probably added from the digital camera or scanner used to create or digitize it.

If the file has been modified from its original state, some details may not fully reflect the modified file.

**Horizontal resolution** 37.79 dpc

**Vertical resolution** 37.79 dpc

## Namespaces

- [File](#)
- [Discussion](#)

## Variants

## Views

- [Read](#)
- [View source](#)
- [View history](#)

## More

- This page was last edited on 17 December 2016, at 13:59.

- [Privacy policy](#)
- [About Win-Test Wiki](#)
- [Disclaimers](#)



# File:CWSerialNumberCustomTable.PNG

From Win-Test Wiki

[Jump to navigation](#) [Jump to search](#)

- [File](#)
- [File history](#)
- [File usage](#)

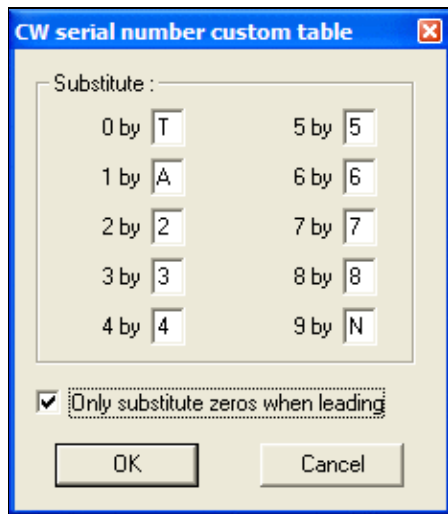

No higher resolution available.

[CWSerialNumberCustomTable.PNG](#) (231 × 265 pixels, file size: 7 KB, MIME type: image.gif)

Table for customizing cut numbers

## File history

Click on a date/time to view the file as it appeared at that time.

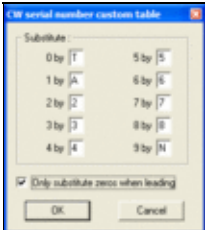
	Date/Time	Thumbnail	Dimensions	User	Comment
current	<a href="#">20:41, 6 September 2008</a>		231 × 265 (7 KB)	<a href="#">N6TV (talk   contribs)</a>	Table for customizing cut numbers

You cannot overwrite this file.

## File usage

The following page uses this file:

- [Menu:Options](#)

## Namespaces

- [File](#)
- [Discussion](#)

## Variants

## Views

- [Read](#)
- [View source](#)
- [View history](#)

## More

- This page was last edited on 6 September 2008, at 20:41.
- [Privacy policy](#)
- [About Win-Test Wiki](#)
- [Disclaimers](#)



# File:CWSerialNumberCustomTable.PNG

From Win-Test Wiki

[Jump to navigation](#) [Jump to search](#)

- [File](#)
- [File history](#)
- [File usage](#)

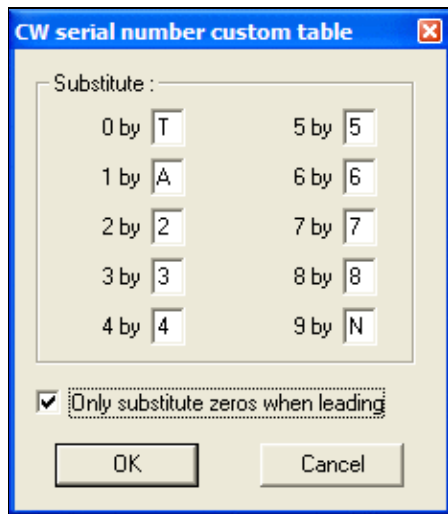

No higher resolution available.

[CWSerialNumberCustomTable.PNG](#) (231 Å 265 pixels, file size: 7 KB, MIME type: image.gif)

Table for customizing cut numbers

## File history

Click on a date/time to view the file as it appeared at that time.

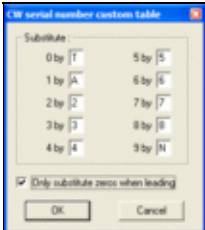
	Date/Time	Thumbnail	Dimensions	User	Comment
current	<a href="#">20:41, 6 September 2008</a>		231 Å 265 (7 KB)	<a href="#">N6TV (talk   contribs)</a>	Table for customizing cut numbers

You cannot overwrite this file.

## File usage

The following page uses this file:

- [Menu:Options](#)

## Namespaces

- [File](#)
- [Discussion](#)

## Variants

## Views

- [Read](#)
- [View source](#)
- [View history](#)

## More

- This page was last edited on 6 September 2008, at 20:41.
- [Privacy policy](#)
- [About Win-Test Wiki](#)
- [Disclaimers](#)





# File:cwspeed.gif

From Win-Test Wiki

[Jump to navigation](#) [Jump to search](#)

- [File](#)
- [File history](#)
- [File usage](#)



No higher resolution available.

[cwspeed.gif](#) (155 × 42 pixels, file size: 1 KB, MIME type: image/gif)

## File history

Click on a date/time to view the file as it appeared at that time.

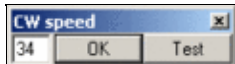
	Date/Time	Thumbnail	Dimensions	User	Comment
current	<a href="#">21:48, 29 July 2006</a>		155 × 42 (1 KB)	<a href="#">DL4NER</a> ( <a href="#">talk</a>   <a href="#">contribs</a> )	

You cannot overwrite this file.

## File usage

The following page uses this file:

- [Menu:Commands](#)

## Namespaces

- [File](#)
- [Discussion](#)

## Variants

## Views

- [Read](#)
- [View source](#)
- [View history](#)

## More

- This page was last edited on 29 July 2006, at 21:48.

## Win-Test Wiki

- [Privacy policy](#)
- [About Win-Test Wiki](#)
- [Disclaimers](#)



# File:cwspeed.gif

From Win-Test Wiki

[Jump to navigation](#) [Jump to search](#)

- [File](#)
- [File history](#)
- [File usage](#)



No higher resolution available.

[cwspeed.gif](#) (155 × 42 pixels, file size: 1 KB, MIME type: image/gif)

## File history

Click on a date/time to view the file as it appeared at that time.

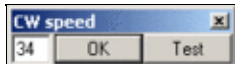
	Date/Time	Thumbnail	Dimensions	User	Comment
current	<a href="#">21:48, 29 July 2006</a>		155 × 42 (1 KB)	<a href="#">DL4NER</a> ( <a href="#">talk</a>   <a href="#">contribs</a> )	

You cannot overwrite this file.

## File usage

The following page uses this file:

- [Menu:Commands](#)

## Namespaces

- [File](#)
- [Discussion](#)

## Variants

## Views

- [Read](#)
- [View source](#)
- [View history](#)

## More

- This page was last edited on 29 July 2006, at 21:48.

## Win-Test Wiki

- [Privacy policy](#)
- [About Win-Test Wiki](#)
- [Disclaimers](#)



# File:CwStandardMessages.gif

From Win-Test Wiki

[Jump to navigation](#) [Jump to search](#)

- [File](#)
- [File history](#)
- [File usage](#)
- [Metadata](#)

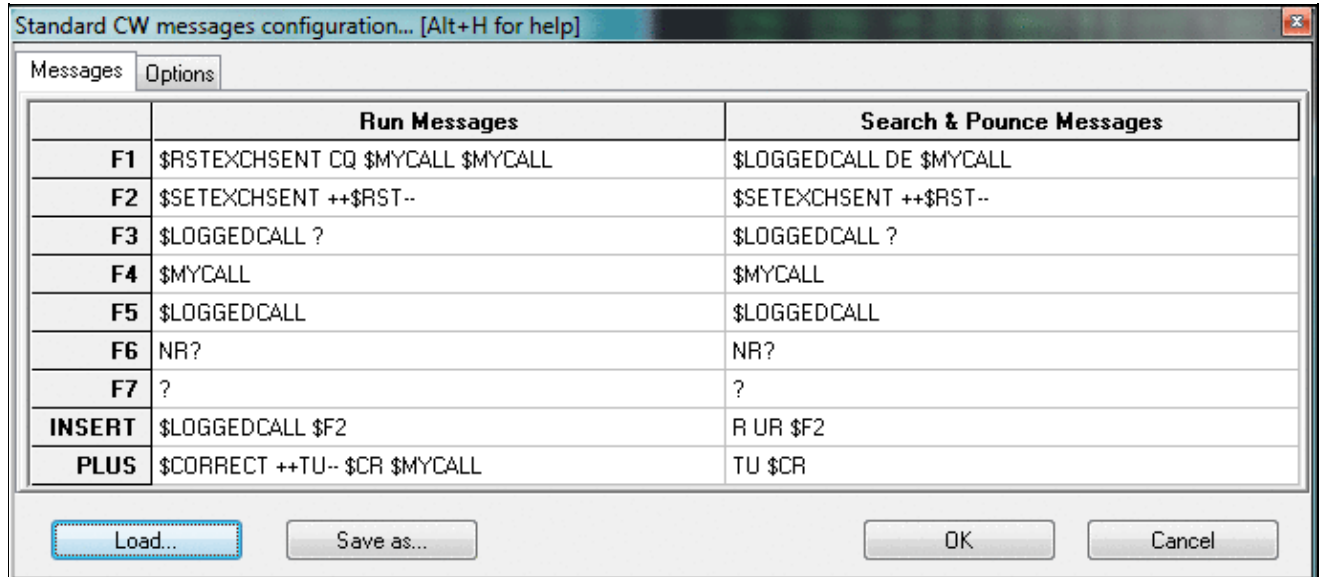

No higher resolution available.

[CwStandardMessages.gif](#) (684 × 302 pixels, file size: 29 KB, MIME type: image.gif)

## File history

Click on a date/time to view the file as it appeared at that time.

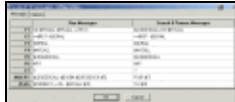
	Date/Time	Thumbnail	Dimensions	User	Comment
current	<a href="#">17:56, 17 December 2016</a>		684 × 302 (29 KB)	<a href="#">Dl6rai</a> ( <a href="#">talk</a>   <a href="#">contribs</a> )	
	<a href="#">20:27, 26 July 2007</a>		684 × 300 (13 KB)	<a href="#">Dl6rai</a> ( <a href="#">talk</a>   <a href="#">contribs</a> )	

You cannot overwrite this file.

## File usage

The following page uses this file:

- [Menu:Options](#)

## Metadata

This file contains additional information, probably added from the digital camera or scanner used to create or digitize it.

If the file has been modified from its original state, some details may not fully reflect the modified file.

**Horizontal resolution** 37.79 dpc

**Vertical resolution** 37.79 dpc

## Namespaces

- [File](#)
- [Discussion](#)

## Variants

## Views

- [Read](#)
- [View source](#)
- [View history](#)

## More

- This page was last edited on 17 December 2016, at 17:56.

- [Privacy policy](#)
- [About Win-Test Wiki](#)
- [Disclaimers](#)

- The logo consists of a yellow sun icon on the left, followed by the text "Powered By" in a small font, and "MediaWiki" in a larger font below it, all enclosed in a thin black rectangular border.

# File:CwStandardMessages.gif

From Win-Test Wiki

[Jump to navigation](#) [Jump to search](#)

- [File](#)
- [File history](#)
- [File usage](#)
- [Metadata](#)

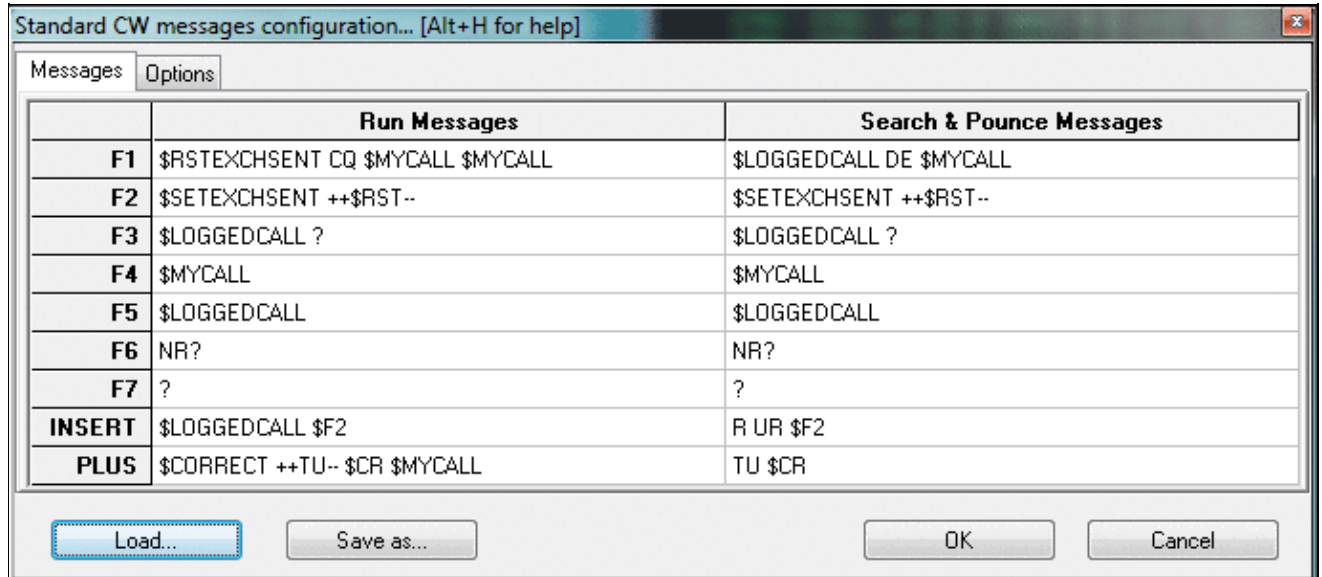

No higher resolution available.

[CwStandardMessages.gif](#) (684 × 302 pixels, file size: 29 KB, MIME type: image.gif)

## File history

Click on a date/time to view the file as it appeared at that time.

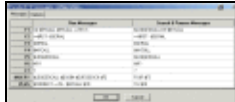
	Date/Time	Thumbnail	Dimensions	User	Comment
current	<a href="#">17:56, 17 December 2016</a>		684 × 302 (29 KB)	<a href="#">Dl6rai</a> ( <a href="#">talk</a>   <a href="#">contribs</a> )	
	<a href="#">20:27, 26 July 2007</a>		684 × 300 (13 KB)	<a href="#">Dl6rai</a> ( <a href="#">talk</a>   <a href="#">contribs</a> )	

You cannot overwrite this file.

## File usage

The following page uses this file:

- [Menu:Options](#)

## Metadata

This file contains additional information, probably added from the digital camera or scanner used to create or digitize it.

If the file has been modified from its original state, some details may not fully reflect the modified file.

**Horizontal resolution** 37.79 dpc

**Vertical resolution** 37.79 dpc

## Namespaces

- [File](#)
- [Discussion](#)

## Variants

## Views

- [Read](#)
- [View source](#)
- [View history](#)

## More

- This page was last edited on 17 December 2016, at 17:56.

- [Privacy policy](#)
- [About Win-Test Wiki](#)
- [Disclaimers](#)

- The logo consists of a yellow sun icon on the left, followed by the text "Powered By" in a small font, and "MediaWiki" in a larger font below it, all enclosed in a thin black border.



# File:CwStandardMessagesOptions.gif

From Win-Test Wiki

[Jump to navigation](#) [Jump to search](#)

- [File](#)
- [File history](#)
- [File usage](#)

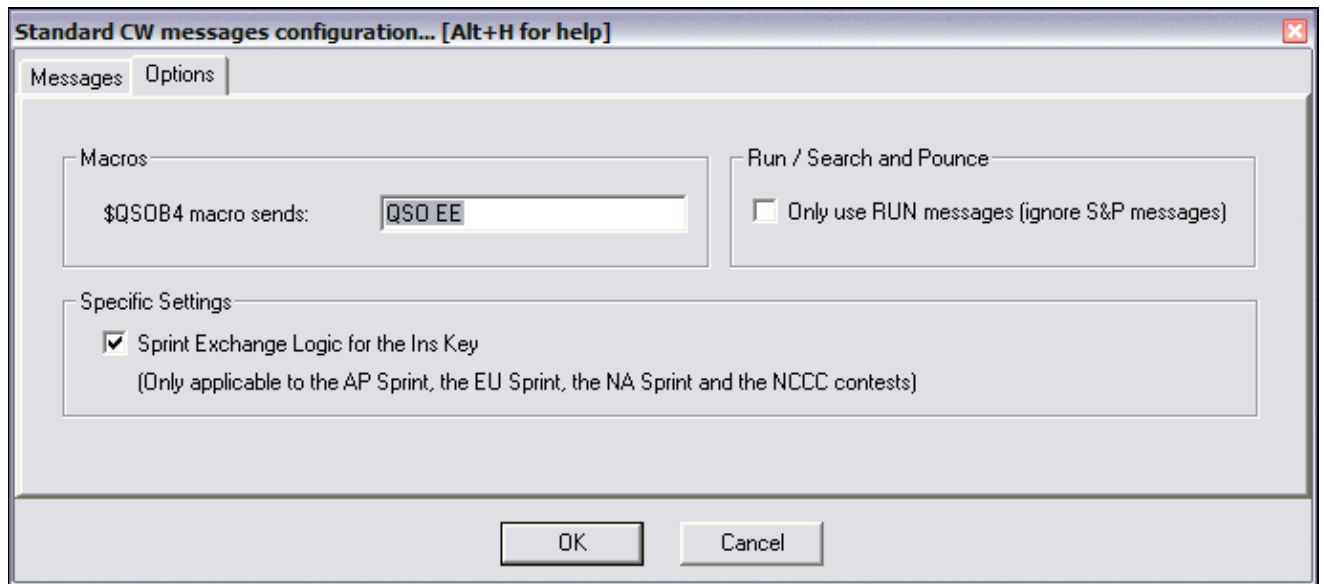



No higher resolution available.

[CwStandardMessagesOptions.gif](#) (684 × 302 pixels, file size: 12 KB, MIME type: image.gif)

## File history

Click on a date/time to view the file as it appeared at that time.

	Date/Time	Thumbnail	Dimensions	User	Comment
current	<a href="#">21:02, 14 July 2008</a>		684 × 302 (12 KB)	<a href="#">N6TV (talk   contribs)</a>	Updated with 3.21 additional features
	<a href="#">20:26, 26 July 2007</a>		684 × 300 (10 KB)	<a href="#">Dl6rai (talk   contribs)</a>	

You cannot overwrite this file.

## File usage

The following page uses this file:

- [Menu:Options](#)

## Namespaces

- [File](#)
- [Discussion](#)

## Variants

## Views

- [Read](#)
- [View source](#)
- [View history](#)

## More

- This page was last edited on 26 July 2007, at 20:26.

- [Privacy policy](#)
- [About Win-Test Wiki](#)
- [Disclaimers](#)



# File:CwStandardMessagesOptions.gif

From Win-Test Wiki

[Jump to navigation](#) [Jump to search](#)

- [File](#)
- [File history](#)
- [File usage](#)

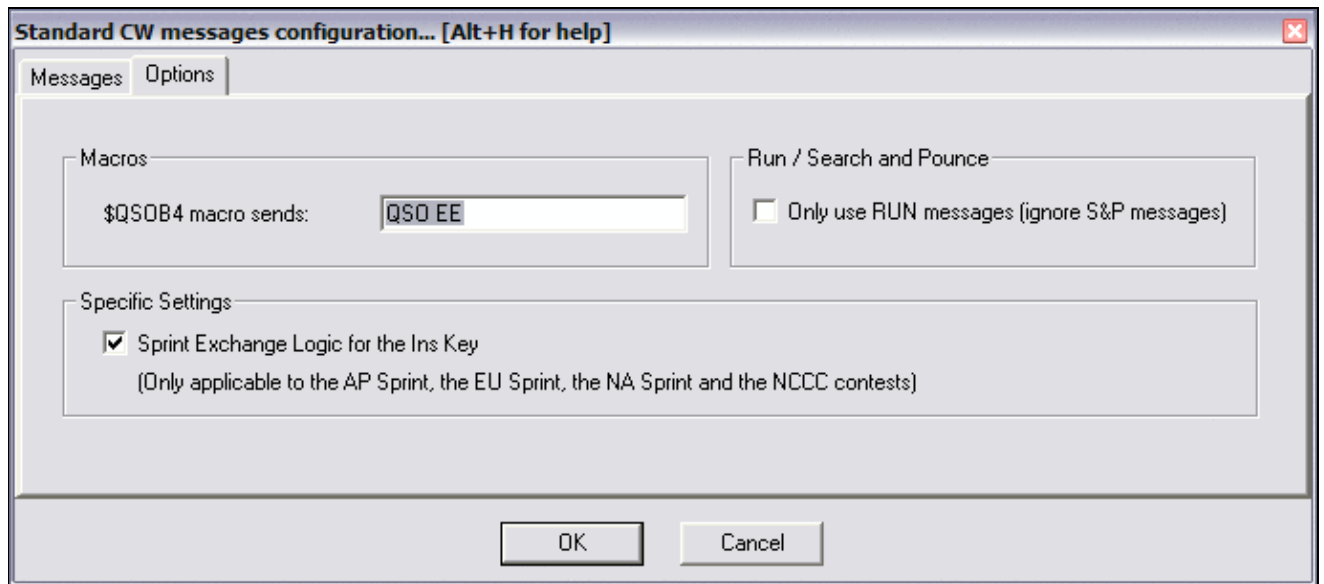



No higher resolution available.

[CwStandardMessagesOptions.gif](#) (684 × 302 pixels, file size: 12 KB, MIME type: image.gif)

## File history

Click on a date/time to view the file as it appeared at that time.

	Date/Time	Thumbnail	Dimensions	User	Comment
current	<a href="#">21:02, 14 July 2008</a>		684 × 302 (12 KB)	<a href="#">N6TV</a> ( <a href="#">talk</a>   <a href="#">contribs</a> )	Updated with 3.21 additional features
	<a href="#">20:26, 26 July 2007</a>		684 × 300 (10 KB)	<a href="#">Dl6rai</a> ( <a href="#">talk</a>   <a href="#">contribs</a> )	

You cannot overwrite this file.

## File usage

The following page uses this file:

- [Menu:Options](#)

## Namespaces

- [File](#)
- [Discussion](#)

## Variants

## Views

- [Read](#)
- [View source](#)
- [View history](#)

## More

- This page was last edited on 26 July 2007, at 20:26.

- [Privacy policy](#)
- [About Win-Test Wiki](#)
- [Disclaimers](#)

- The logo for MediaWiki, featuring a sun icon and the text "Powered By MediaWiki".

# File:cwweight.gif

From Win-Test Wiki

[Jump to navigation](#) [Jump to search](#)

- [File](#)
- [File history](#)
- [File usage](#)



No higher resolution available.

[cwweight.gif](#) (149 × 42 pixels, file size: 1 KB, MIME type: image.gif)

## File history

Click on a date/time to view the file as it appeared at that time.

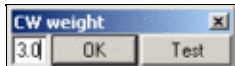
Date/Time	Thumbnail	Dimensions	User	Comment
current <a href="#">21:50, 29 July 2006</a>		149 × 42 (1 KB)	<a href="#">DL4NER</a> ( <a href="#">talk</a>   <a href="#">contribs</a> )	

You cannot overwrite this file.

## File usage

The following page uses this file:

- [Menu:Commands](#)

## Namespaces

- [File](#)
- [Discussion](#)

## Variants

## Views

- [Read](#)
- [View source](#)
- [View history](#)

## More

- This page was last edited on 29 July 2006, at 21:50.

## Win-Test Wiki

- [Privacy policy](#)
- [About Win-Test Wiki](#)
- [Disclaimers](#)



# File:cwweight.gif

From Win-Test Wiki

[Jump to navigation](#) [Jump to search](#)

- [File](#)
- [File history](#)
- [File usage](#)



No higher resolution available.

[cwweight.gif](#) (149 × 42 pixels, file size: 1 KB, MIME type: image.gif)

## File history

Click on a date/time to view the file as it appeared at that time.

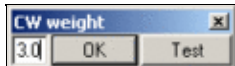
Date/Time	Thumbnail	Dimensions	User	Comment
current <a href="#">21:50, 29 July 2006</a>		149 × 42 (1 KB)	<a href="#">DL4NER</a> ( <a href="#">talk</a>   <a href="#">contribs</a> )	

You cannot overwrite this file.

## File usage

The following page uses this file:

- [Menu:Commands](#)

## Namespaces

- [File](#)
- [Discussion](#)

## Variants

## Views

- [Read](#)
- [View source](#)
- [View history](#)

## More

- This page was last edited on 29 July 2006, at 21:50.

## Win-Test Wiki

- [Privacy policy](#)
- [About Win-Test Wiki](#)
- [Disclaimers](#)





# File:DataFilesExtra.gif

From Win-Test Wiki

[Jump to navigation](#) [Jump to search](#)

- [File](#)
- [File history](#)
- [File usage](#)

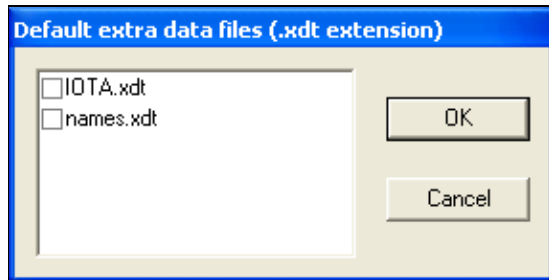

No higher resolution available.

[DataFilesExtra.gif](#) (285 × 144 pixels, file size: 4 KB, MIME type: image.gif)

## File history

Click on a date/time to view the file as it appeared at that time.

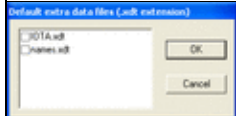
	Date/Time	Thumbnail	Dimensions	User	Comment
current	<a href="#">12:29, 26 March 2007</a>		285 × 144 (4 KB)	<a href="#">I2WIJ</a> ( <a href="#">talk</a>   <a href="#">contribs</a> )	

You cannot overwrite this file.

## File usage

The following page uses this file:

- [Menu:Options](#)

## Namespaces

- [File](#)
- [Discussion](#)

## Variants

## Views

- [Read](#)
- [View source](#)
- [View history](#)

## More

- This page was last edited on 26 March 2007, at 12:29.

- [Privacy policy](#)
- [About Win-Test Wiki](#)
- [Disclaimers](#)



# File:DataFilesExtra.gif

From Win-Test Wiki

[Jump to navigation](#) [Jump to search](#)

- [File](#)
- [File history](#)
- [File usage](#)

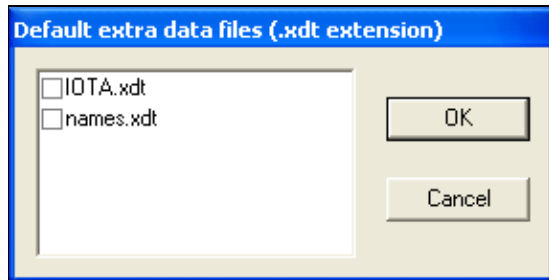

No higher resolution available.

[DataFilesExtra.gif](#) (285 × 144 pixels, file size: 4 KB, MIME type: image.gif)

## File history

Click on a date/time to view the file as it appeared at that time.

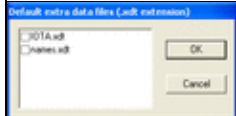
	Date/Time	Thumbnail	Dimensions	User	Comment
current	<a href="#">12:29, 26 March 2007</a>		285 × 144 (4 KB)	<a href="#">I2WIJ</a> ( <a href="#">talk</a>   <a href="#">contribs</a> )	

You cannot overwrite this file.

## File usage

The following page uses this file:

- [Menu:Options](#)

## Namespaces

- [File](#)
- [Discussion](#)

## Variants

## Views

- [Read](#)
- [View source](#)
- [View history](#)

## More

- This page was last edited on 26 March 2007, at 12:29.

- [Privacy policy](#)
- [About Win-Test Wiki](#)
- [Disclaimers](#)



# File:DataFilesMarkers.gif

From Win-Test Wiki

[Jump to navigation](#) [Jump to search](#)

- [File](#)
- [File history](#)
- [File usage](#)

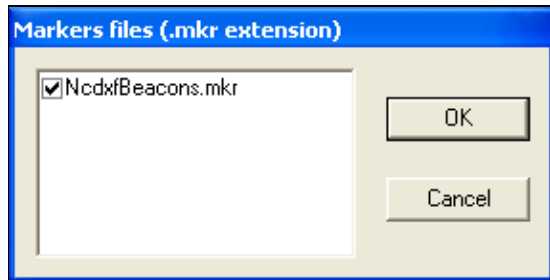

No higher resolution available.

[DataFilesMarkers.gif](#) (285 × 144 pixels, file size: 4 KB, MIME type: image.gif)

## File history

Click on a date/time to view the file as it appeared at that time.

	Date/Time	Thumbnail	Dimensions	User	Comment
current	<a href="#">12:30, 26 March 2007</a>		285 × 144 (4 KB)	<a href="#">I2WIJ</a> ( <a href="#">talk</a>   <a href="#">contribs</a> )	

You cannot overwrite this file.

## File usage

The following page uses this file:

- [Menu:Options](#)

## Namespaces

- [File](#)
- [Discussion](#)

## Variants

## Views

- [Read](#)
- [View source](#)
- [View history](#)

## More

- This page was last edited on 26 March 2007, at 12:30.

- [Privacy policy](#)
- [About Win-Test Wiki](#)
- [Disclaimers](#)



# File:DataFilesMarkers.gif

From Win-Test Wiki

[Jump to navigation](#) [Jump to search](#)

- [File](#)
- [File history](#)
- [File usage](#)

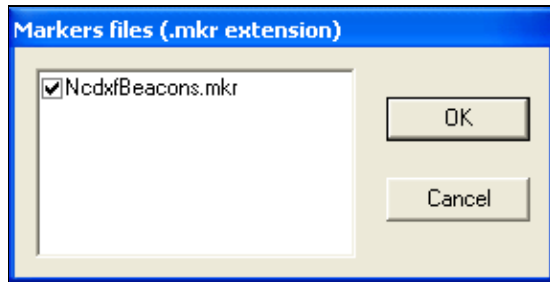

No higher resolution available.

[DataFilesMarkers.gif](#) (285 × 144 pixels, file size: 4 KB, MIME type: image.gif)

## File history

Click on a date/time to view the file as it appeared at that time.

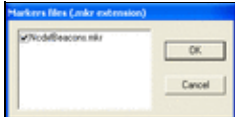
	Date/Time	Thumbnail	Dimensions	User	Comment
current	<a href="#">12:30, 26 March 2007</a>		285 × 144 (4 KB)	<a href="#">I2WIJ</a> ( <a href="#">talk</a>   <a href="#">contribs</a> )	

You cannot overwrite this file.

## File usage

The following page uses this file:

- [Menu:Options](#)

## Namespaces

- [File](#)
- [Discussion](#)

## Variants

## Views

- [Read](#)
- [View source](#)
- [View history](#)

## More

- This page was last edited on 26 March 2007, at 12:30.

- [Privacy policy](#)
- [About Win-Test Wiki](#)
- [Disclaimers](#)





# File:DataFilesSegment.gif

From Win-Test Wiki

[Jump to navigation](#) [Jump to search](#)

- [File](#)
- [File history](#)
- [File usage](#)

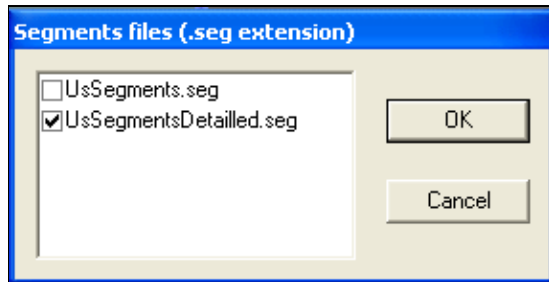

No higher resolution available.

[DataFilesSegment.gif](#) (285 × 145 pixels, file size: 5 KB, MIME type: image/gif)

## File history

Click on a date/time to view the file as it appeared at that time.

	Date/Time	Thumbnail	Dimensions	User	Comment
current	<a href="#">12:30, 26 March 2007</a>		285 × 145 (5 KB)	<a href="#">I2WIJ</a> ( <a href="#">talk</a>   <a href="#">contribs</a> )	

You cannot overwrite this file.

## File usage

The following page uses this file:

- [Menu:Options](#)

## Namespaces

- [File](#)
- [Discussion](#)

## Variants

## Views

- [Read](#)
- [View source](#)
- [View history](#)

## More

- This page was last edited on 26 March 2007, at 12:30.

- [Privacy policy](#)
- [About Win-Test Wiki](#)
- [Disclaimers](#)



# File:DataFilesSegment.gif

From Win-Test Wiki

[Jump to navigation](#) [Jump to search](#)

- [File](#)
- [File history](#)
- [File usage](#)

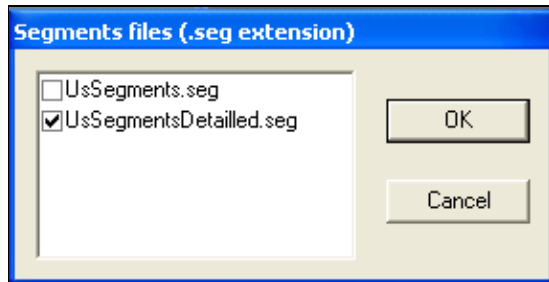

No higher resolution available.

[DataFilesSegment.gif](#) (285 × 145 pixels, file size: 5 KB, MIME type: image/gif)

## File history

Click on a date/time to view the file as it appeared at that time.

	Date/Time	Thumbnail	Dimensions	User	Comment
current	<a href="#">12:30, 26 March 2007</a>		285 × 145 (5 KB)	<a href="#">I2WIJ</a> ( <a href="#">talk</a>   <a href="#">contribs</a> )	

You cannot overwrite this file.

## File usage

The following page uses this file:

- [Menu:Options](#)

## Namespaces

- [File](#)
- [Discussion](#)

## Variants

## Views

- [Read](#)
- [View source](#)
- [View history](#)

## More

- This page was last edited on 26 March 2007, at 12:30.

- [Privacy policy](#)
- [About Win-Test Wiki](#)
- [Disclaimers](#)



# File:DefaultOpenChildWindows.gif

From Win-Test Wiki

[Jump to navigation](#) [Jump to search](#)

- [File](#)
- [File history](#)
- [File usage](#)

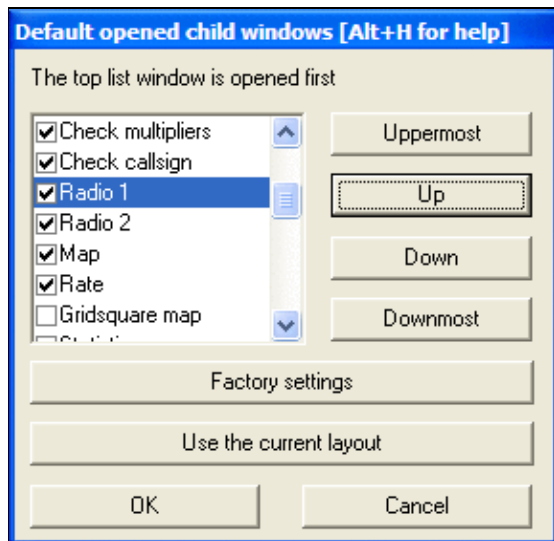

No higher resolution available.

[DefaultOpenChildWindows.gif](#) (287 × 281 pixels, file size: 10 KB, MIME type: image.gif)

Shows the dialog box displayed by Options | Windows | Default layout ...

## File history

Click on a date/time to view the file as it appeared at that time.

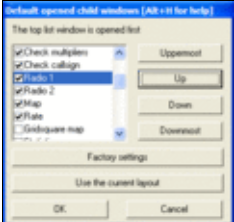
	Date/Time	Thumbnail	Dimensions	User	Comment
current	<a href="#">22:49, 1 June 2008</a>		287 × 281 (10 KB)	<a href="#">N6TV (talk   contribs)</a>	Shows the dialog box displayed by Options   Windows   Default layout ...

You cannot overwrite this file.

## File usage

The following page uses this file:

- [Menu:Options](#)

File:DefaultOpenChildWindows.gif

## Namespaces

- [File](#)
- [Discussion](#)

## Variants

## Views

- [Read](#)
- [View source](#)
- [View history](#)

## More

- This page was last edited on 1 June 2008, at 22:49.

- [Privacy policy](#)
- [About Win-Test Wiki](#)
- [Disclaimers](#)



# File:DefaultOpenChildWindows.gif

From Win-Test Wiki

[Jump to navigation](#) [Jump to search](#)

- [File](#)
- [File history](#)
- [File usage](#)

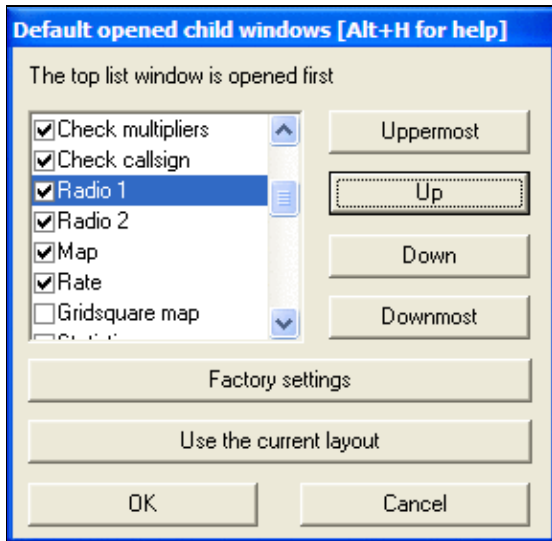

No higher resolution available.

[DefaultOpenChildWindows.gif](#) (287 × 281 pixels, file size: 10 KB, MIME type: image.gif)

Shows the dialog box displayed by Options | Windows | Default layout ...

## File history

Click on a date/time to view the file as it appeared at that time.

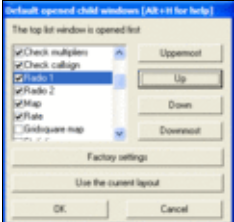
	Date/Time	Thumbnail	Dimensions	User	Comment
current	<a href="#">22:49, 1 June 2008</a>		287 × 281 (10 KB)	<a href="#">N6TV (talk   contribs)</a>	Shows the dialog box displayed by Options   Windows   Default layout ...

You cannot overwrite this file.

## File usage

The following page uses this file:

- [Menu:Options](#)

File:DefaultOpenChildWindows.gif

## Namespaces

- [File](#)
- [Discussion](#)

## Variants

## Views

- [Read](#)
- [View source](#)
- [View history](#)

## More

- This page was last edited on 1 June 2008, at 22:49.

- [Privacy policy](#)
- [About Win-Test Wiki](#)
- [Disclaimers](#)

- The logo for MediaWiki, featuring a sun icon and the text "Powered By MediaWiki".



# File:DeleteAllQSO.gif

From Win-Test Wiki

[Jump to navigation](#) [Jump to search](#)

- [File](#)
- [File history](#)
- [File usage](#)

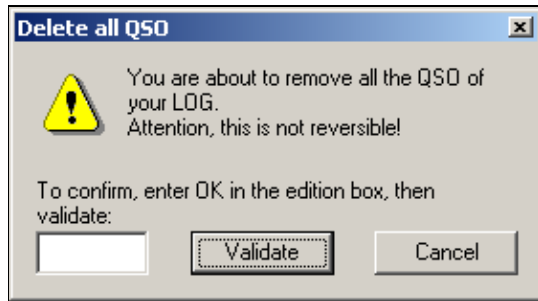

No higher resolution available.

[DeleteAllQSO.gif](#) (279 × 154 pixels, file size: 4 KB, MIME type: image.gif)

## File history

Click on a date/time to view the file as it appeared at that time.

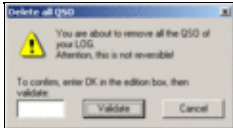
Date/Time	Thumbnail	Dimensions	User	Comment
current <a href="#">20:50, 27 July 2006</a>		279 × 154 (4 KB)	<a href="#">DL4NER</a> ( <a href="#">talk</a>   <a href="#">contribs</a> )	

You cannot overwrite this file.

## File usage

The following page uses this file:

- [Menu:Edit](#)

## Namespaces

- [File](#)
- [Discussion](#)

## Variants

## Views

- [Read](#)
- [View source](#)
- [View history](#)

## More

- This page was last edited on 27 July 2006, at 20:50.

- [Privacy policy](#)
- [About Win-Test Wiki](#)
- [Disclaimers](#)



# File:DeleteAllQSO.gif

From Win-Test Wiki

[Jump to navigation](#) [Jump to search](#)

- [File](#)
- [File history](#)
- [File usage](#)

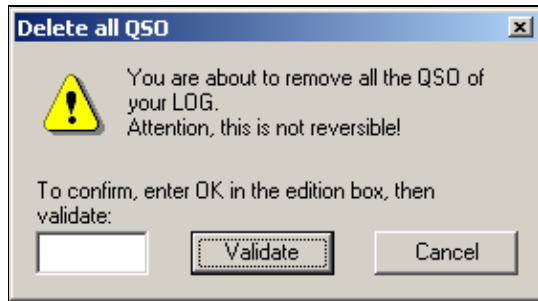

No higher resolution available.

[DeleteAllQSO.gif](#) (279 × 154 pixels, file size: 4 KB, MIME type: image.gif)

## File history

Click on a date/time to view the file as it appeared at that time.

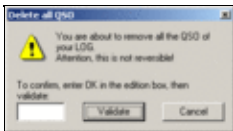
Date/Time	Thumbnail	Dimensions	User	Comment
current <a href="#">20:50, 27 July 2006</a>		279 × 154 (4 KB)	<a href="#">DL4NER</a> ( <a href="#">talk</a>   <a href="#">contribs</a> )	

You cannot overwrite this file.

## File usage

The following page uses this file:

- [Menu:Edit](#)

## Namespaces

- [File](#)
- [Discussion](#)

## Variants

## Views

- [Read](#)
- [View source](#)
- [View history](#)

## More

- This page was last edited on 27 July 2006, at 20:50.

- [Privacy policy](#)
- [About Win-Test Wiki](#)
- [Disclaimers](#)



# File:DeleteAQSO.gif

From Win-Test Wiki

[Jump to navigation](#) [Jump to search](#)

- [File](#)
- [File history](#)
- [File usage](#)

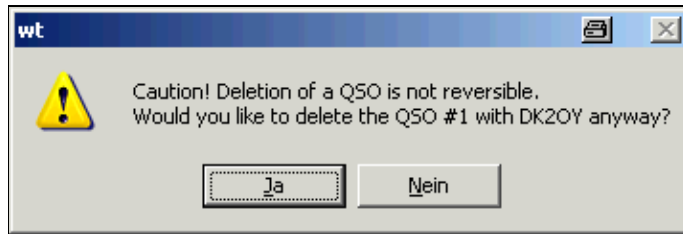

No higher resolution available.

[DeleteAQSO.gif](#) (356 × 119 pixels, file size: 5 KB, MIME type: image.gif)

## File history

Click on a date/time to view the file as it appeared at that time.

	Date/Time	Thumbnail	Dimensions	User	Comment
current	<a href="#">20:35, 26 July 2007</a>		356 × 119 (5 KB)	<a href="#">Dl6rai</a> ( <a href="#">talk</a>   <a href="#">contribs</a> )	

You cannot overwrite this file.

## File usage

The following page uses this file:

- [Menu:Edit](#)

## Namespaces

- [File](#)
- [Discussion](#)

## Variants

## Views

- [Read](#)
- [View source](#)
- [View history](#)

## More

- This page was last edited on 26 July 2007, at 20:35.

- [Privacy policy](#)
- [About Win-Test Wiki](#)
- [Disclaimers](#)



# File:DeleteAQSO.gif

From Win-Test Wiki

[Jump to navigation](#) [Jump to search](#)

- [File](#)
- [File history](#)
- [File usage](#)

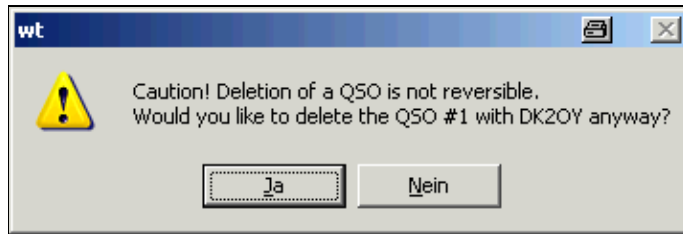

No higher resolution available.

[DeleteAQSO.gif](#) (356 × 119 pixels, file size: 5 KB, MIME type: image.gif)

## File history

Click on a date/time to view the file as it appeared at that time.

	Date/Time	Thumbnail	Dimensions	User	Comment
current	<a href="#">20:35, 26 July 2007</a>		356 × 119 (5 KB)	<a href="#">Dl6rai</a> ( <a href="#">talk</a>   <a href="#">contribs</a> )	

You cannot overwrite this file.

## File usage

The following page uses this file:

- [Menu:Edit](#)

## Namespaces

- [File](#)
- [Discussion](#)

## Variants

## Views

- [Read](#)
- [View source](#)
- [View history](#)

## More

- This page was last edited on 26 July 2007, at 20:35.

- [Privacy policy](#)
- [About Win-Test Wiki](#)
- [Disclaimers](#)





# File:Detailed.PNG

From Win-Test Wiki

[Jump to navigation](#) [Jump to search](#)

- [File](#)
- [File history](#)
- [File usage](#)

The screenshot shows a Notepad window with the following text:

```

File Edit Format View Help
By band - All modes
QSOs (with dupes) - By time

```

Hr	160	80	40	20	15	10	Total
00			208	1			209
01			198	1	2		201
02			172	1			173
03		154	1				155
04		74	59	5			138
05		5	173				178
06	135	4	17				156
07		56	47	40	4		147
08				91	115		206
09			4		135	7	146
10				81	29	75	185
11					99	84	183
12				30	151	2	183
13				2	185		187
14				1	192	1	194
15				14	166	5	185
16				3	138	2	143
17				204	7	1	212
18			1	164	3	2	170
19			31	109	3		143
20			147	1			148
21		130	11				141
22	52	70					122
23	2	1	129				132
00		29	66				95
01	11	8					19
02							
03	51	35		1	5		92
04	80	17		1			98

No higher resolution available.

Detailed.PNG (763 × 536 pixels, file size: 31 KB, MIME type: image.gif)

## File history

Click on a date/time to view the file as it appeared at that time.

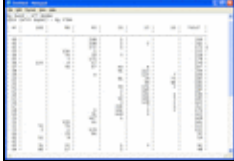
	Date/Time	Thumbnail	Dimensions	User	Comment
current	<u>15:24, 13 October 2006</u>		763 × 536 (31 KB)	<u>Ct1boh</u> ( <a href="#">talk</a>   <a href="#">contribs</a> )	

You cannot overwrite this file.

## File usage

The following page uses this file:

- [Extracting log Information](#)

## Namespaces

- [File](#)
- [Discussion](#)

## Variants

## Views

- [Read](#)
- [View source](#)
- [View history](#)

## More

- This page was last edited on 13 October 2006, at 15:24.

- [Privacy policy](#)
- [About Win-Test Wiki](#)
- [Disclaimers](#)



# File:Detailed.PNG

From Win-Test Wiki

[Jump to navigation](#) [Jump to search](#)

- [File](#)
- [File history](#)
- [File usage](#)

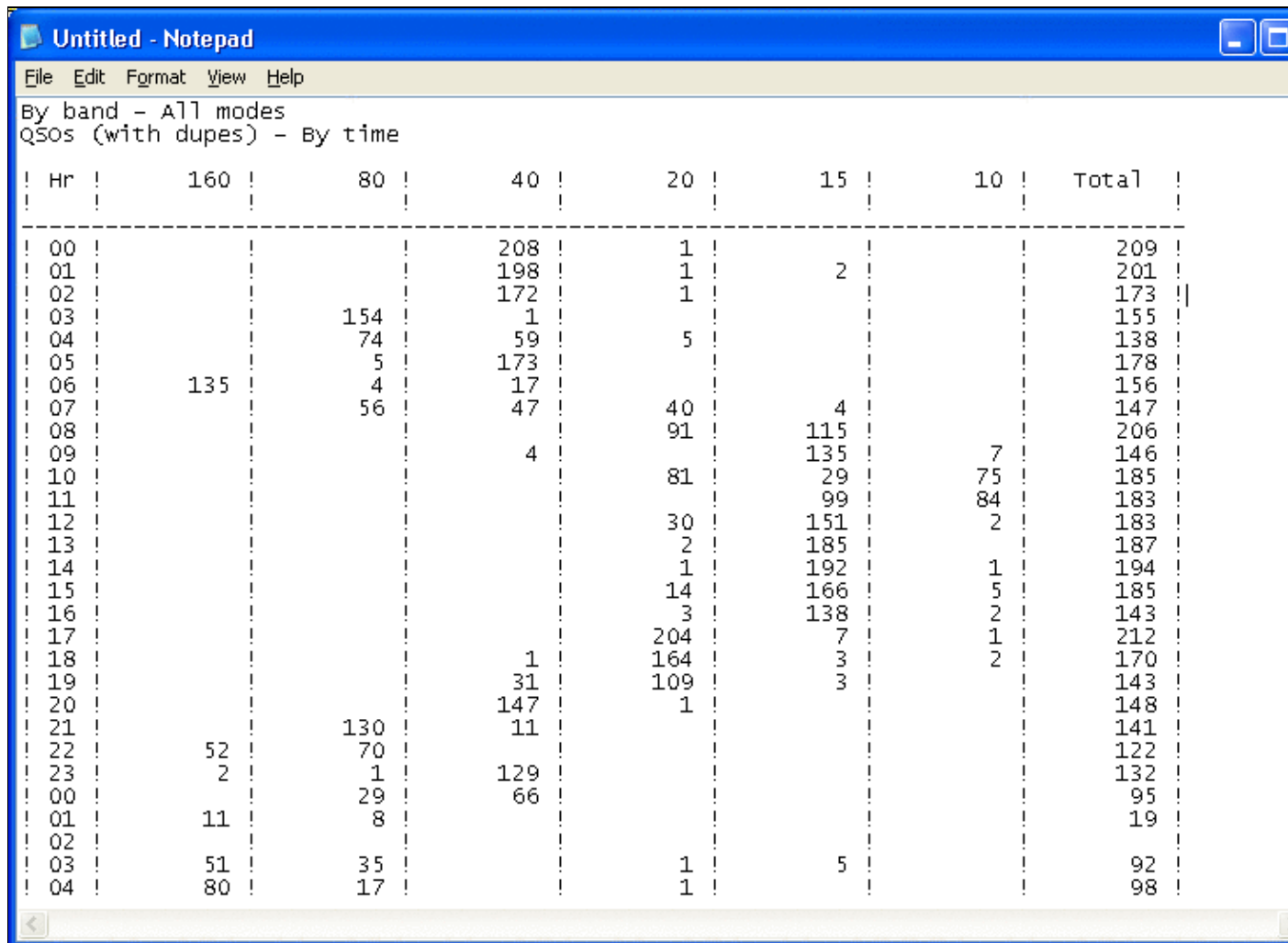

The image shows a Notepad window titled "Untitled - Notepad" with a menu bar (File, Edit, Format, View, Help). The text content is a table of QSO statistics. The table has columns for hours (Hr), bands (160, 80, 40, 20, 15, 10), and a Total column. The rows represent hours from 00 to 24. The data is as follows:

Hr	160	80	40	20	15	10	Total
00			208	1			209
01			198	1	2		201
02			172	1			173
03		154	1				155
04		74	59	5			138
05		5	173				178
06	135	4	17				156
07		56	47	40	4		147
08				91	115		206
09			4		135	7	146
10				81	29	75	185
11					99	84	183
12				30	151	2	183
13				2	185		187
14				1	192	1	194
15				14	166	5	185
16				3	138	2	143
17				204	7	1	212
18			1	164	3	2	170
19			31	109	3		143
20			147	1			148
21		130	11				141
22	52	70					122
23	2	1	129				132
00		29	66				95
01	11	8					19
02							
03	51	35		1	5		92
04	80	17		1			98

No higher resolution available.

Detailed.PNG (763 × 536 pixels, file size: 31 KB, MIME type: image.gif)

## File history

Click on a date/time to view the file as it appeared at that time.

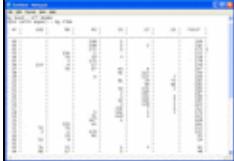
	Date/Time	Thumbnail	Dimensions	User	Comment
current	<u>15:24, 13 October 2006</u>		763 × 536 (31 KB)	<u>Ct1boh</u> ( <a href="#">talk</a>   <a href="#">contribs</a> )	

You cannot overwrite this file.

## File usage

The following page uses this file:

- [Extracting log Information](#)

## Namespaces

- [File](#)
- [Discussion](#)

## Variants

## Views

- [Read](#)
- [View source](#)
- [View history](#)

## More

- This page was last edited on 13 October 2006, at 15:24.

- [Privacy policy](#)
- [About Win-Test Wiki](#)
- [Disclaimers](#)



# File:DeviceMgrYaesu-FTDX-101.gif

From Win-Test Wiki

[Jump to navigation](#) [Jump to search](#)

- [File](#)
- [File history](#)
- [File usage](#)

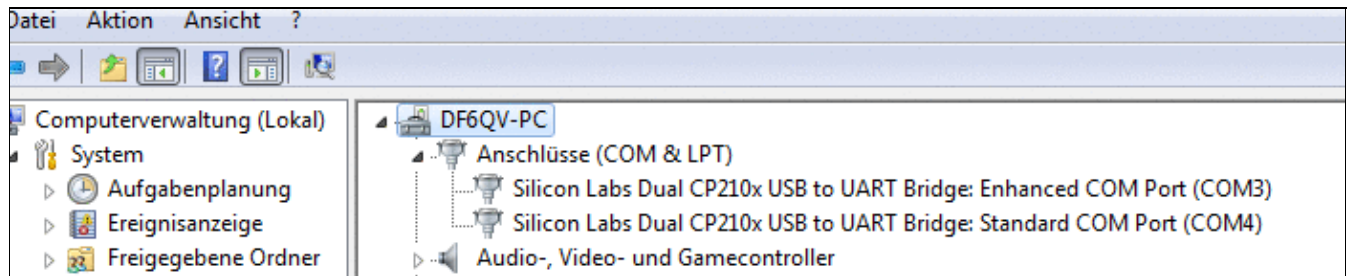

No higher resolution available.

[DeviceMgrYaesu-FTDX-101.gif](#) (698 × 140 pixels, file size: 21 KB, MIME type: image.gif)

## File history

Click on a date/time to view the file as it appeared at that time.

	Date/Time	Thumbnail	Dimensions	User	Comment
current	<a href="#">09:50, 8 February 2020</a>		698 × 140 (21 KB)	<a href="#">Dl6rai (talk   contribs)</a>	

You cannot overwrite this file.

## File usage

The following page uses this file:

- [BestPractice7](#)

## Namespaces

- [File](#)
- [Discussion](#)

## Variants

## Views

- [Read](#)
- [View source](#)
- [View history](#)

## More

- This page was last edited on 8 February 2020, at 09:50.

- [Privacy policy](#)
- [About Win-Test Wiki](#)
- [Disclaimers](#)



# File:DeviceMgrYaesu-FTDX-101.gif

From Win-Test Wiki

[Jump to navigation](#) [Jump to search](#)

- [File](#)
- [File history](#)
- [File usage](#)

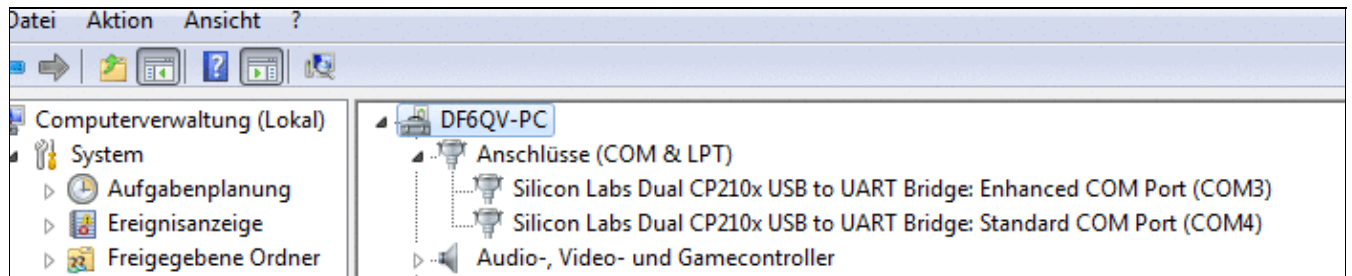

No higher resolution available.

[DeviceMgrYaesu-FTDX-101.gif](#) (698 × 140 pixels, file size: 21 KB, MIME type: image.gif)

## File history

Click on a date/time to view the file as it appeared at that time.

	Date/Time	Thumbnail	Dimensions	User	Comment
current	<a href="#">09:50, 8 February 2020</a>		698 × 140 (21 KB)	<a href="#">Dl6rai (talk   contribs)</a>	

You cannot overwrite this file.

## File usage

The following page uses this file:

- [BestPractice7](#)

## Namespaces

- [File](#)
- [Discussion](#)

## Variants

## Views

- [Read](#)
- [View source](#)
- [View history](#)

## More

- This page was last edited on 8 February 2020, at 09:50.

- [Privacy policy](#)
- [About Win-Test Wiki](#)
- [Disclaimers](#)





# File:DistinctCallsignsReport.PNG

From Win-Test Wiki

[Jump to navigation](#) [Jump to search](#)

- [File](#)
- [File history](#)
- [File usage](#)
- [Metadata](#)

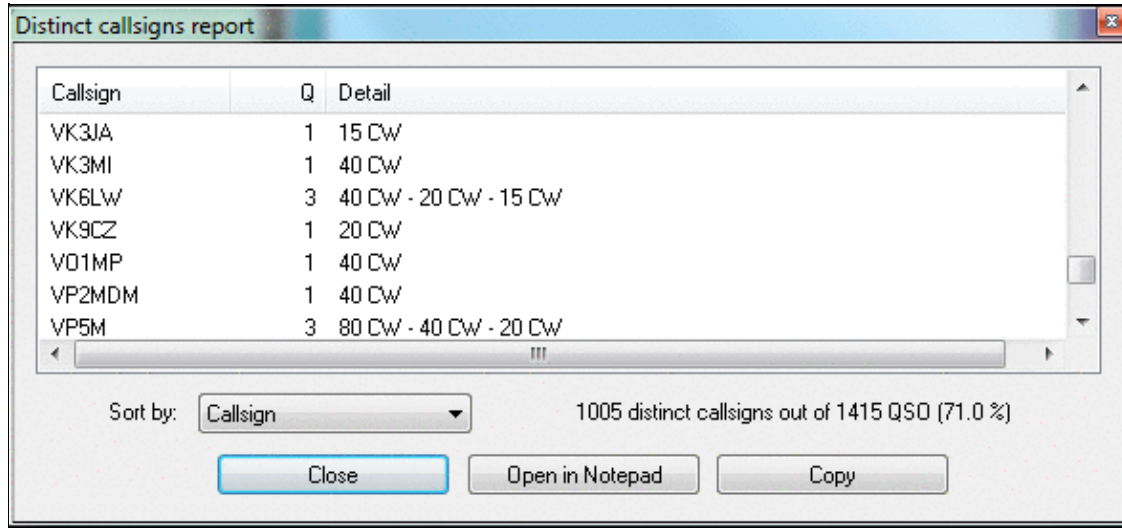



No higher resolution available.

[DistinctCallsignsReport.PNG](#) (587 × 273 pixels, file size: 19 KB, MIME type: image/gif)

## File history

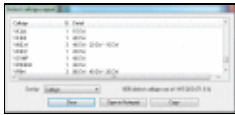
Click on a date/time to view the file as it appeared at that time.

	Date/Time	Thumbnail	Dimensions	User	Comment
current	<a href="#">11:30, 4 April 2020</a>		587 × 273 (19 KB)	<a href="#">Dl6rai</a> ( <a href="#">talk</a>   <a href="#">contribs</a> )	
	<a href="#">05:20, 5 June 2008</a>		587 × 273 (13 KB)	<a href="#">Dl6rai</a> ( <a href="#">talk</a>   <a href="#">contribs</a> )	

You cannot overwrite this file.

## File usage

The following page uses this file:

- [Menu:Tools](#)

## Metadata

This file contains additional information, probably added from the digital camera or scanner used to create or digitize it.

If the file has been modified from its original state, some details may not fully reflect the modified file.

**Horizontal resolution** 37.79 dpc

**Vertical resolution** 37.79 dpc

## Namespaces

- [File](#)
- [Discussion](#)

## Variants

## Views

- [Read](#)
- [View source](#)
- [View history](#)

## More

- This page was last edited on 4 April 2020, at 11:30.

- [Privacy policy](#)
- [About Win-Test Wiki](#)
- [Disclaimers](#)

- The logo consists of a yellow sun icon on the left, followed by the text "Powered By" in a small font, and "MediaWiki" in a larger font below it, all contained within a thin black rectangular border.

# File:DistinctCallsignsReport.PNG

From Win-Test Wiki

[Jump to navigation](#) [Jump to search](#)

- [File](#)
- [File history](#)
- [File usage](#)
- [Metadata](#)

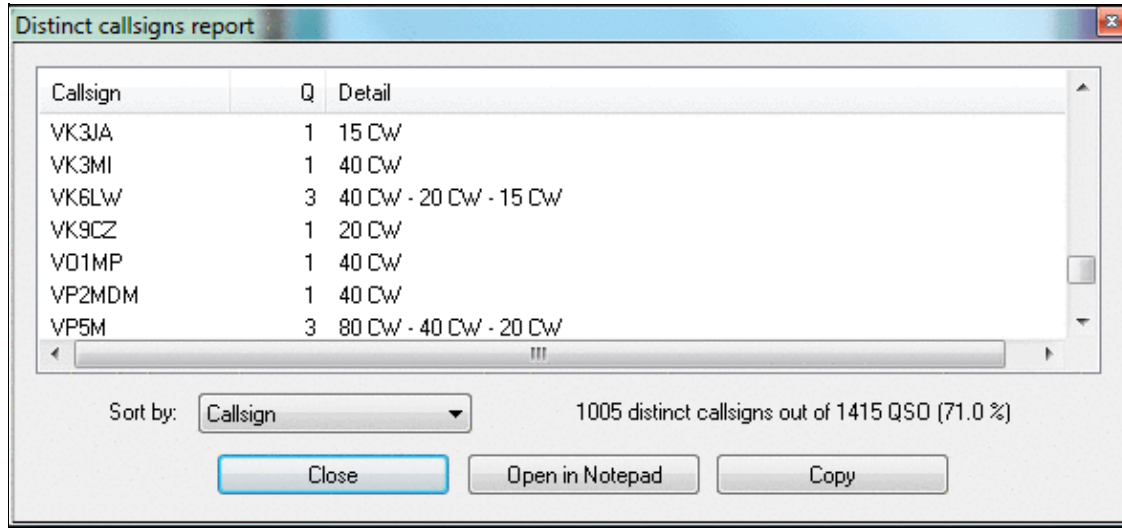



No higher resolution available.

[DistinctCallsignsReport.PNG](#) (587 × 273 pixels, file size: 19 KB, MIME type: image/gif)

## File history

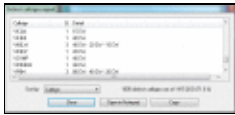
Click on a date/time to view the file as it appeared at that time.

	Date/Time	Thumbnail	Dimensions	User	Comment
current	<a href="#">11:30, 4 April 2020</a>		587 × 273 (19 KB)	<a href="#">Dl6rai</a> ( <a href="#">talk</a>   <a href="#">contribs</a> )	
	<a href="#">05:20, 5 June 2008</a>		587 × 273 (13 KB)	<a href="#">Dl6rai</a> ( <a href="#">talk</a>   <a href="#">contribs</a> )	

You cannot overwrite this file.

## File usage

The following page uses this file:

- [Menu:Tools](#)

## Metadata

This file contains additional information, probably added from the digital camera or scanner used to create or digitize it.

If the file has been modified from its original state, some details may not fully reflect the modified file.

**Horizontal resolution** 37.79 dpc

**Vertical resolution** 37.79 dpc

## Namespaces

- [File](#)
- [Discussion](#)

## Variants

## Views

- [Read](#)
- [View source](#)
- [View history](#)

## More

- This page was last edited on 4 April 2020, at 11:30.

- [Privacy policy](#)
- [About Win-Test Wiki](#)
- [Disclaimers](#)

- The logo consists of a blue square with a white sun icon on the left, followed by the text "Powered By" in a small font and "MediaWiki" in a larger font, all contained within a thin black border.

# File:dl4ner-contest-specific.gif

From Win-Test Wiki

[Jump to navigation](#) [Jump to search](#)

- [File](#)
- [File history](#)
- [File usage](#)

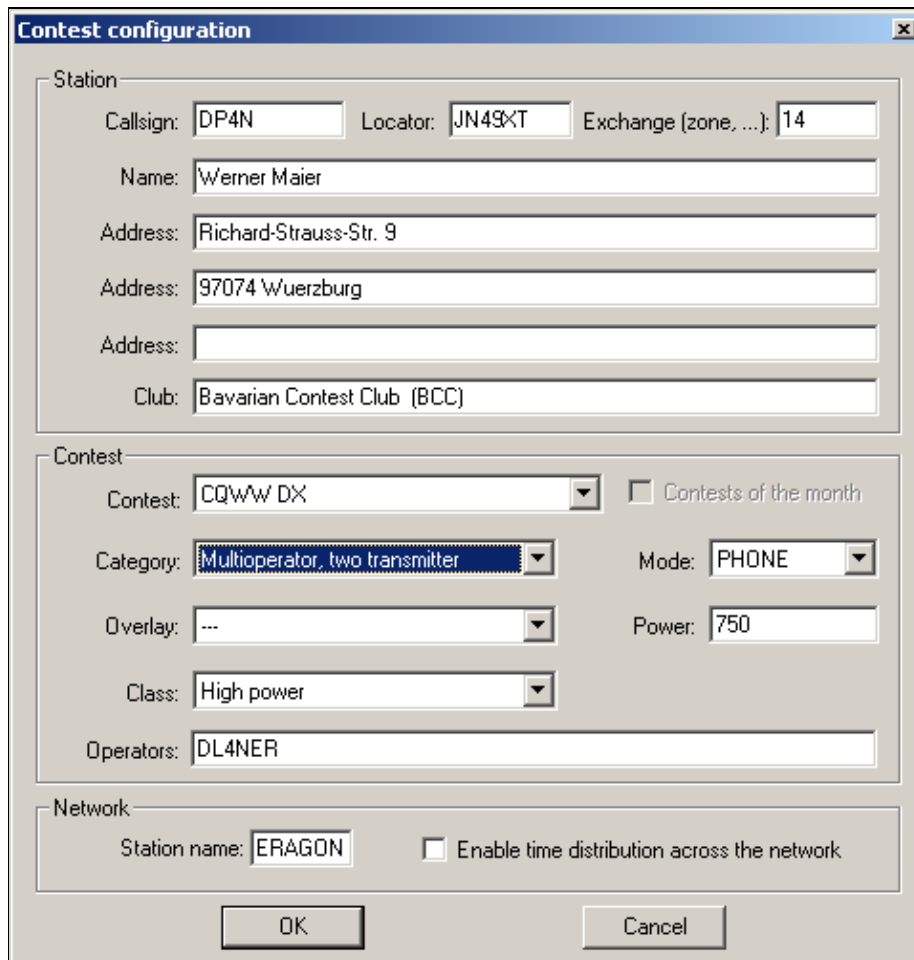

The image shows a screenshot of the 'Contest configuration' dialog box in the Win-Test software. The dialog is organized into three main sections: Station, Contest, and Network.

**Station Section:**

- Callsign: DP4N
- Locator: JN49XT
- Exchange (zone, ...): 14
- Name: Werner Maier
- Address: Richard-Strauss-Str. 9
- Address: 97074 Wuerzburg
- Address: (empty)
- Club: Bavarian Contest Club (BCC)

**Contest Section:**

- Contest: CQWW DX
- Contests of the month
- Category: Multioperator, two transmitter
- Mode: PHONE
- Overlay: ---
- Power: 750
- Class: High power
- Operators: DL4NER

**Network Section:**

- Station name: ERAGON
- Enable time distribution across the network

At the bottom of the dialog are two buttons: 'OK' and 'Cancel'.

No higher resolution available.

[dl4ner-contest-specific.gif](#) (480 × 500 pixels, file size: 13 KB, MIME type: image/gif)

main contest configuration page

## File history

Click on a date/time to view the file as it appeared at that time.

	Date/Time	Thumbnail	Dimensions	User	Comment
current	<a href="#">21:33, 23 July 2006</a>		480 × 500 (13 KB)	<a href="#">Dl4ner (talk   contribs)</a>	main contest configuration page

You cannot overwrite this file.

## File usage

The following page uses this file:

- [Contest specific behaviour](#)

## Namespaces

- [File](#)
- [Discussion](#)

## Variants

## Views

- [Read](#)
- [View source](#)
- [View history](#)

## More

- This page was last edited on 23 July 2006, at 21:33.

- [Privacy policy](#)
- [About Win-Test Wiki](#)
- [Disclaimers](#)



# File:dl4ner-contest-specific.gif

From Win-Test Wiki

[Jump to navigation](#) [Jump to search](#)

- [File](#)
- [File history](#)
- [File usage](#)

The image shows a screenshot of the 'Contest configuration' dialog box. The dialog is divided into three main sections: Station, Contest, and Network. The Station section contains fields for Callsign (DP4N), Locator (JN49XT), Exchange (zone, ...): (14), Name (Werner Maier), Address (Richard-Strauss-Str. 9), Address (97074 Wuerzburg), and Club (Bavarian Contest Club (BCC)). The Contest section contains a Contest dropdown (CQWW DX), a checkbox for 'Contests of the month', a Category dropdown (Multioperator, two transmitter), a Mode dropdown (PHONE), an Overlay dropdown (---), a Power field (750), a Class dropdown (High power), and an Operators field (DL4NER). The Network section contains a Station name field (ERAGON) and a checkbox for 'Enable time distribution across the network'. At the bottom of the dialog are 'OK' and 'Cancel' buttons.

Section	Field	Value
Station	Callsign	DP4N
	Locator	JN49XT
	Exchange (zone, ...):	14
	Name	Werner Maier
	Address	Richard-Strauss-Str. 9
	Address	97074 Wuerzburg
	Club	Bavarian Contest Club (BCC)
Contest	Contest	CQWW DX
	Contests of the month	<input type="checkbox"/>
	Category	Multioperator, two transmitter
	Mode	PHONE
	Overlay	---
	Power	750
	Class	High power
Operators	DL4NER	
Network	Station name	ERAGON
	Enable time distribution across the network	<input type="checkbox"/>

No higher resolution available.

[dl4ner-contest-specific.gif](#) (480 × 500 pixels, file size: 13 KB, MIME type: image/gif)

main contest configuration page

## File history

Click on a date/time to view the file as it appeared at that time.

	Date/Time	Thumbnail	Dimensions	User	Comment
current	<a href="#">21:33, 23 July 2006</a>		480 × 500 (13 KB)	<a href="#">Dl4ner (talk   contribs)</a>	main contest configuration page

You cannot overwrite this file.

## File usage

The following page uses this file:

- [Contest specific behaviour](#)

## Namespaces

- [File](#)
- [Discussion](#)

## Variants

## Views

- [Read](#)
- [View source](#)
- [View history](#)

## More

- This page was last edited on 23 July 2006, at 21:33.

- [Privacy policy](#)
- [About Win-Test Wiki](#)
- [Disclaimers](#)





# File:dx-cluster.gif

From Win-Test Wiki

[Jump to navigation](#) [Jump to search](#)

- [File](#)
- [File history](#)
- [File usage](#)

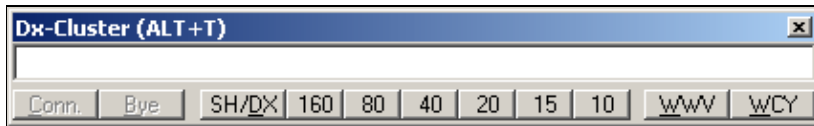

No higher resolution available.

[dx-cluster.gif](#) (426 × 63 pixels, file size: 3 KB, MIME type: image/gif)

## File history

Click on a date/time to view the file as it appeared at that time.

	Date/Time	Thumbnail	Dimensions	User	Comment
current	<a href="#">20:04, 26 July 2006</a>		426 × 63 (3 KB)	<a href="#">DL4NER</a> ( <a href="#">talk</a>   <a href="#">contribs</a> )	

You cannot overwrite this file.

## File usage

The following page uses this file:

- [DX Cluster/Packet](#)

## Namespaces

- [File](#)
- [Discussion](#)

## Variants

## Views

- [Read](#)
- [View source](#)
- [View history](#)

## More

- This page was last edited on 26 July 2006, at 20:04.

## Win-Test Wiki

- [Privacy policy](#)
- [About Win-Test Wiki](#)
- [Disclaimers](#)



# File:DxCluster.gif

From Win-Test Wiki

[Jump to navigation](#) [Jump to search](#)

- [File](#)
- [File history](#)
- [File usage](#)

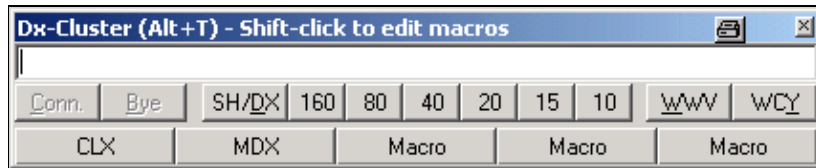

No higher resolution available.

[DxCluster.gif](#) (426 × 85 pixels, file size: 6 KB, MIME type: image/gif)

## File history

Click on a date/time to view the file as it appeared at that time.

	Date/Time	Thumbnail	Dimensions	User	Comment
current	<a href="#">14:23, 9 October 2006</a>		426 × 85 (6 KB)	<a href="#">Dl6rai</a> ( <a href="#">talk</a>   <a href="#">contribs</a> )	

You cannot overwrite this file.

## File usage

The following page uses this file:

- [Menu:Commands](#)

## Namespaces

- [File](#)
- [Discussion](#)

## Variants

## Views

- [Read](#)
- [View source](#)
- [View history](#)

## More

- This page was last edited on 9 October 2006, at 14:23.

- [Privacy policy](#)
- [About Win-Test Wiki](#)
- [Disclaimers](#)



# File:DXClusterAnnouncementsBands.PNG

From Win-Test Wiki

[Jump to navigation](#) [Jump to search](#)

- [File](#)
- [File history](#)
- [File usage](#)
- [Metadata](#)

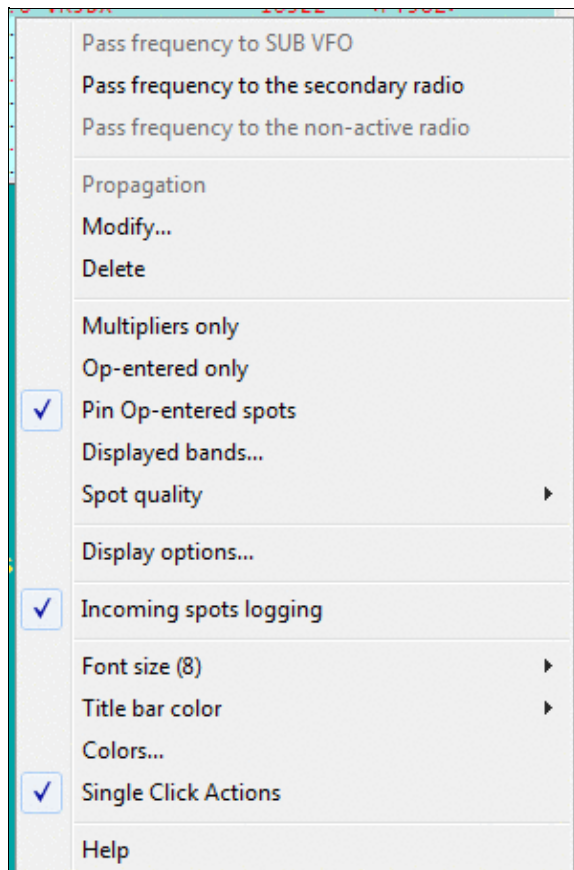





No higher resolution available.

[DXClusterAnnouncementsBands.PNG](#) (299 Å 453 pixels, file size: 11 KB, MIME type: image.gif)

DX Cluster Announcements Window pop-up menu for band selection.

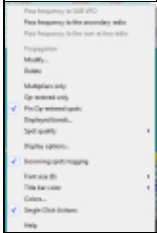
## File history

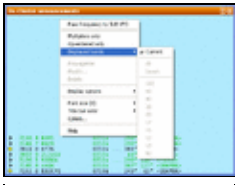
Click on a date/time to view the file as it appeared at that time.

	Date/Time	Thumbnail	Dimensions	User	Comment
current	<u><a href="#">10:36, 30 December 2021</a></u>		299 Å 453 (11 KB)	<u><a href="#">D16rai</a></u> ( <u><a href="#">talk</a></u>   <u><a href="#">contribs</a></u> )	
	<u><a href="#">14:49, 15 August 2013</a></u>		406 Å 354 (11 KB)	<u><a href="#">D16rai</a></u> ( <u><a href="#">talk</a></u>   <u><a href="#">contribs</a></u> )	
	<u><a href="#">07:48, 7 March 2009</a></u>		504 Å 373 (13 KB)	<u><a href="#">D16rai</a></u> ( <u><a href="#">talk</a></u>   <u><a href="#">contribs</a></u> )	
	<u><a href="#">21:34, 12 November 2008</a></u>		628 Å 342 (12 KB)	<u><a href="#">N6TV</a></u> ( <u><a href="#">talk</a></u>   <u><a href="#">contribs</a></u> )	Band selection pop-up menu for the DX Cluster Announcements window
	<u><a href="#">21:32, 12 November 2008</a></u>		628 Å 342 (12 KB)	<u><a href="#">N6TV</a></u> ( <u><a href="#">talk</a></u>   <u><a href="#">contribs</a></u> )	DX Cluster Announcements Window pop-up menu for band selection.

You cannot overwrite this file.

## File usage

The following page uses this file:

- [Menu:Windows](#)

## Metadata

This file contains additional information, probably added from the digital camera or scanner used to create or digitize it.

If the file has been modified from its original state, some details may not fully reflect the modified file.

**Horizontal resolution** 37.79 dpc

**Vertical resolution** 37.79 dpc

## Namespaces

- [File](#)
- [Discussion](#)

## Variants

## Views

- [Read](#)
- [View source](#)
- [View history](#)

## More

- This page was last edited on 30 December 2021, at 10:36.

- [Privacy policy](#)
- [About Win-Test Wiki](#)
- [Disclaimers](#)

-  The logo consists of a small sun icon on the left, followed by the text "Powered By" in a smaller font above "MediaWiki" in a larger font, all contained within a thin black rectangular border.

# File:DXClusterAnnouncementsBands.PNG

From Win-Test Wiki

[Jump to navigation](#) [Jump to search](#)

- [File](#)
- [File history](#)
- [File usage](#)
- [Metadata](#)

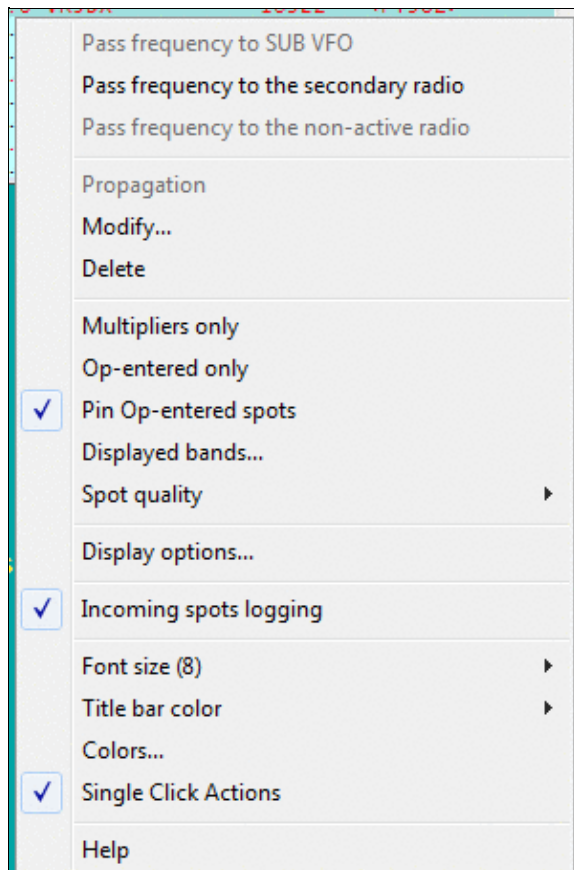







No higher resolution available.

[DXClusterAnnouncementsBands.PNG](#) (299 Å 453 pixels, file size: 11 KB, MIME type: image.gif)

DX Cluster Announcements Window pop-up menu for band selection.

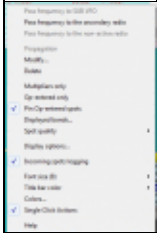
## File history

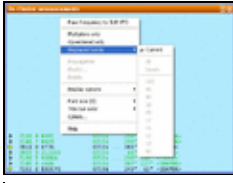
Click on a date/time to view the file as it appeared at that time.

	Date/Time	Thumbnail	Dimensions	User	Comment
current	<a href="#">10:36, 30 December 2021</a>		299 Å 453 (11 KB)	<a href="#">D16rai (talk   contribs)</a>	
	<a href="#">14:49, 15 August 2013</a>		406 Å 354 (11 KB)	<a href="#">D16rai (talk   contribs)</a>	
	<a href="#">07:48, 7 March 2009</a>		504 Å 373 (13 KB)	<a href="#">D16rai (talk   contribs)</a>	
	<a href="#">21:34, 12 November 2008</a>		628 Å 342 (12 KB)	<a href="#">N6TV (talk   contribs)</a>	Band selection pop-up menu for the DX Cluster Announcements window
	<a href="#">21:32, 12 November 2008</a>		628 Å 342 (12 KB)	<a href="#">N6TV (talk   contribs)</a>	DX Cluster Announcements Window pop-up menu for band selection.

You cannot overwrite this file.

## File usage

The following page uses this file:

- [Menu:Windows](#)

## Metadata

This file contains additional information, probably added from the digital camera or scanner used to create or digitize it.

If the file has been modified from its original state, some details may not fully reflect the modified file.

**Horizontal resolution** 37.79 dpc

**Vertical resolution** 37.79 dpc

## Namespaces

- [File](#)
- [Discussion](#)

## Variants

## Views

- [Read](#)
- [View source](#)
- [View history](#)

## More

- This page was last edited on 30 December 2021, at 10:36.

- [Privacy policy](#)
- [About Win-Test Wiki](#)
- [Disclaimers](#)

- The logo for MediaWiki, featuring a sun icon and the text "Powered By MediaWiki".

# File:DXClusterAnnouncementsDisplayOptions.PNG

From Win-Test Wiki

[Jump to navigation](#) [Jump to search](#)

- [File](#)
- [File history](#)
- [File usage](#)
- [Metadata](#)

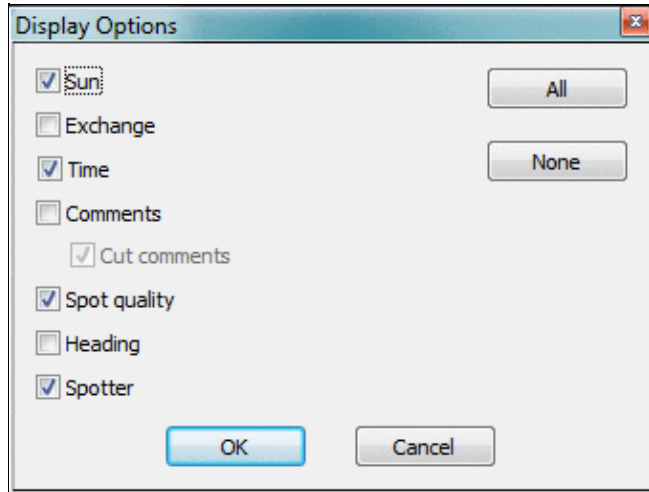

No higher resolution available.



[DXClusterAnnouncementsDisplayOptions.PNG](#) (338 × 256 pixels, file size: 15 KB, MIME type: image/gif)

Display selection pop-up menu for the DX Cluster Announcements window

## File history

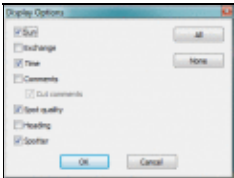
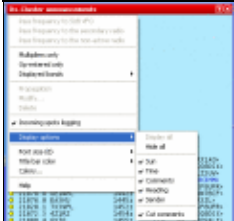
Click on a date/time to view the file as it appeared at that time.

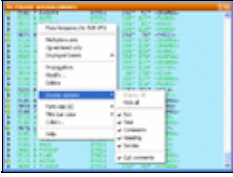
	Date/Time	Thumbnail	Dimensions	User	Comment
current	<a href="#">10:41, 30 December 2021</a>		338 × 256 (15 KB)	<a href="#">Dl6rai (talk   contribs)</a>	
	<a href="#">14:56, 15 August 2013</a>		408 × 398 (14 KB)	<a href="#">Dl6rai (talk   contribs)</a>	

Date/Time	Thumbnail	Dimensions	User	Comment
<u>07:49, 7 March 2009</u>		505 Å 374 (21 KB)	<a href="#">D16rai (talk   contribs)</a>	
<u>21:35, 12 November 2008</u>		626 Å 342 (13 KB)	<a href="#">N6TV (talk   contribs)</a>	Display selection pop-up menu for the DX Cluster Announcements window

You cannot overwrite this file.

## File usage

The following page uses this file:

- [Menu:Windows](#)

## Metadata

This file contains additional information, probably added from the digital camera or scanner used to create or digitize it.

If the file has been modified from its original state, some details may not fully reflect the modified file.

**Horizontal resolution** 37.79 dpc

**Vertical resolution** 37.79 dpc

## Namespaces

- [File](#)
- [Discussion](#)

## Variants

## Views

- [Read](#)
- [View source](#)
- [View history](#)

## More

- This page was last edited on 30 December 2021, at 10:41.
- [Privacy policy](#)
- [About Win-Test Wiki](#)
- [Disclaimers](#)



# File:DXClusterAnnouncementsDisplayOptions.PNG

From Win-Test Wiki

[Jump to navigation](#) [Jump to search](#)

- [File](#)
- [File history](#)
- [File usage](#)
- [Metadata](#)

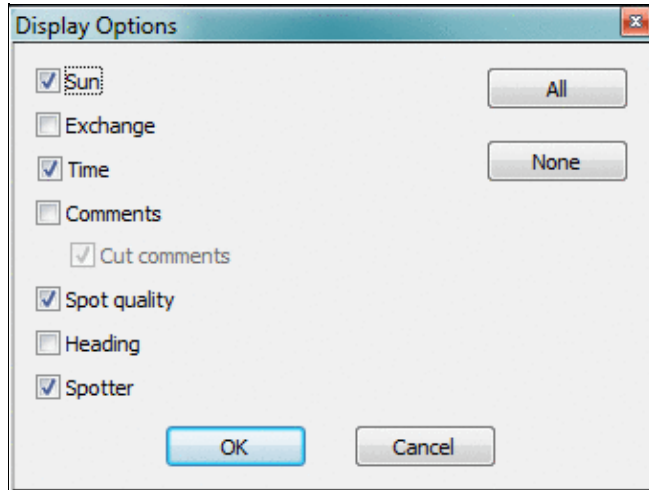

No higher resolution available.



[DXClusterAnnouncementsDisplayOptions.PNG](#) (338 × 256 pixels, file size: 15 KB, MIME type: image/gif)

Display selection pop-up menu for the DX Cluster Announcements window

## File history

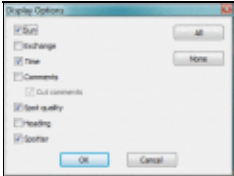
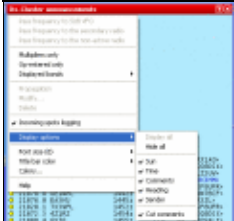
Click on a date/time to view the file as it appeared at that time.

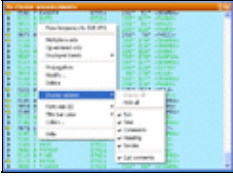
	Date/Time	Thumbnail	Dimensions	User	Comment
current	<a href="#">10:41, 30 December 2021</a>		338 × 256 (15 KB)	<a href="#">Dl6rai (talk   contribs)</a>	
	<a href="#">14:56, 15 August 2013</a>		408 × 398 (14 KB)	<a href="#">Dl6rai (talk   contribs)</a>	

Date/Time	Thumbnail	Dimensions	User	Comment
<u>07:49, 7 March 2009</u>		505 × 374 (21 KB)	<u>D16rai</u> ( <a href="#">talk</a>   <a href="#">contribs</a> )	
<u>21:35, 12 November 2008</u>		626 × 342 (13 KB)	<u>N6TV</u> ( <a href="#">talk</a>   <a href="#">contribs</a> )	Display selection pop-up menu for the DX Cluster Announcements window

You cannot overwrite this file.

## File usage

The following page uses this file:

- [Menu:Windows](#)

## Metadata

This file contains additional information, probably added from the digital camera or scanner used to create or digitize it.

If the file has been modified from its original state, some details may not fully reflect the modified file.

**Horizontal resolution** 37.79 dpc

**Vertical resolution** 37.79 dpc

## Namespaces

- [File](#)
- [Discussion](#)

## Variants

## Views

- [Read](#)
- [View source](#)
- [View history](#)

## More

- This page was last edited on 30 December 2021, at 10:41.
- [Privacy policy](#)
- [About Win-Test Wiki](#)
- [Disclaimers](#)





# File:DXClusterAnnouncementsSpotQuality.PNG

From Win-Test Wiki

[Jump to navigation](#) [Jump to search](#)

- [File](#)
- [File history](#)
- [File usage](#)
- [Metadata](#)

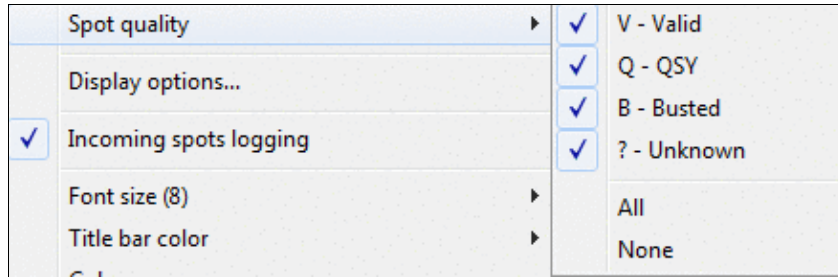

No higher resolution available.

[DXClusterAnnouncementsSpotQuality.PNG](#) (438 × 142 pixels, file size: 5 KB, MIME type: image.gif)

## File history

Click on a date/time to view the file as it appeared at that time.

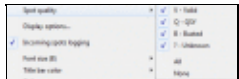
	Date/Time	Thumbnail	Dimensions	User	Comment
current	<a href="#">10:47, 30 December 2021</a>		438 × 142 (5 KB)	<a href="#">Dl6rai</a> ( <a href="#">talk</a>   <a href="#">contribs</a> )	

You cannot overwrite this file.

## File usage

The following page uses this file:

- [Menu:Windows](#)

## Metadata

This file contains additional information, probably added from the digital camera or scanner used to create or digitize it.

If the file has been modified from its original state, some details may not fully reflect the modified file.

**Horizontal resolution** 37.79 dpc

**Vertical resolution** 37.79 dpc

## Namespaces

- [File](#)
- [Discussion](#)

## Variants

## Views

- [Read](#)
- [View source](#)
- [View history](#)

## More

- This page was last edited on 30 December 2021, at 10:47.
- [Privacy policy](#)
- [About Win-Test Wiki](#)
- [Disclaimers](#)



# File:DXClusterAnnouncementsSpotQuality.PNG

From Win-Test Wiki

[Jump to navigation](#) [Jump to search](#)

- [File](#)
- [File history](#)
- [File usage](#)
- [Metadata](#)

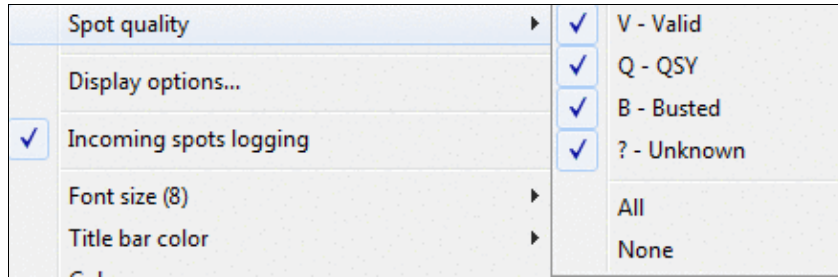

No higher resolution available.

[DXClusterAnnouncementsSpotQuality.PNG](#) (438 × 142 pixels, file size: 5 KB, MIME type: image.gif)

## File history

Click on a date/time to view the file as it appeared at that time.

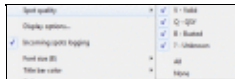
	Date/Time	Thumbnail	Dimensions	User	Comment
current	<a href="#">10:47, 30 December 2021</a>		438 × 142 (5 KB)	<a href="#">Dl6rai</a> ( <a href="#">talk</a>   <a href="#">contribs</a> )	

You cannot overwrite this file.

## File usage

The following page uses this file:

- [Menu:Windows](#)

## Metadata

This file contains additional information, probably added from the digital camera or scanner used to create or digitize it.

If the file has been modified from its original state, some details may not fully reflect the modified file.

**Horizontal resolution** 37.79 dpc

**Vertical resolution** 37.79 dpc

## Namespaces

- [File](#)
- [Discussion](#)

## Variants

## Views

- [Read](#)
- [View source](#)
- [View history](#)

## More

- This page was last edited on 30 December 2021, at 10:47.
- [Privacy policy](#)
- [About Win-Test Wiki](#)
- [Disclaimers](#)



# File:dx-cluster.gif

From Win-Test Wiki

[Jump to navigation](#) [Jump to search](#)

- [File](#)
- [File history](#)
- [File usage](#)

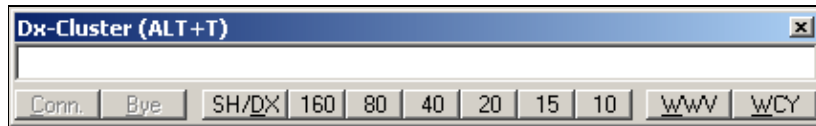

No higher resolution available.

[dx-cluster.gif](#) (426 × 63 pixels, file size: 3 KB, MIME type: image/gif)

## File history

Click on a date/time to view the file as it appeared at that time.

	Date/Time	Thumbnail	Dimensions	User	Comment
current	<a href="#">20:04, 26 July 2006</a>		426 × 63 (3 KB)	<a href="#">DL4NER</a> ( <a href="#">talk</a>   <a href="#">contribs</a> )	

You cannot overwrite this file.

## File usage

The following page uses this file:

- [DX Cluster/Packet](#)

## Namespaces

- [File](#)
- [Discussion](#)

## Variants

## Views

- [Read](#)
- [View source](#)
- [View history](#)

## More

- This page was last edited on 26 July 2006, at 20:04.

## Win-Test Wiki

- [Privacy policy](#)
- [About Win-Test Wiki](#)
- [Disclaimers](#)



# File:DxCluster.gif

From Win-Test Wiki

[Jump to navigation](#) [Jump to search](#)

- [File](#)
- [File history](#)
- [File usage](#)

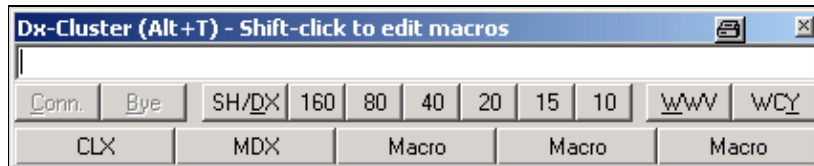

No higher resolution available.

[DxCluster.gif](#) (426 × 85 pixels, file size: 6 KB, MIME type: image/gif)

## File history

Click on a date/time to view the file as it appeared at that time.

	Date/Time	Thumbnail	Dimensions	User	Comment
current	<a href="#">14:23, 9 October 2006</a>		426 × 85 (6 KB)	<a href="#">Dl6rai</a> ( <a href="#">talk</a>   <a href="#">contribs</a> )	

You cannot overwrite this file.

## File usage

The following page uses this file:

- [Menu:Commands](#)

## Namespaces

- [File](#)
- [Discussion](#)

## Variants

## Views

- [Read](#)
- [View source](#)
- [View history](#)

## More

- This page was last edited on 9 October 2006, at 14:23.

- [Privacy policy](#)
- [About Win-Test Wiki](#)
- [Disclaimers](#)





# File:DxClusterMacros.gif

From Win-Test Wiki

[Jump to navigation](#) [Jump to search](#)

- [File](#)
- [File history](#)
- [File usage](#)

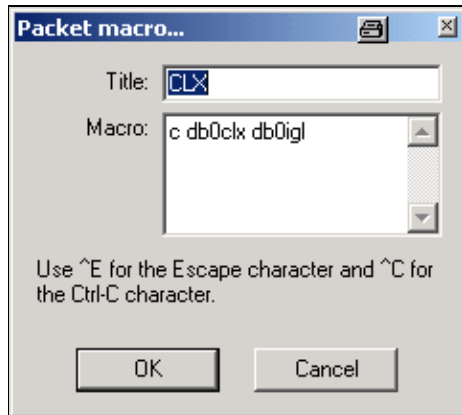

No higher resolution available.

[DxClusterMacros.gif](#) (239 × 215 pixels, file size: 5 KB, MIME type: image/gif)

## File history

Click on a date/time to view the file as it appeared at that time.

	Date/Time	Thumbnail	Dimensions	User	Comment
current	<a href="#">14:24, 9 October 2006</a>		239 × 215 (5 KB)	<a href="#">Dl6rai (talk   contribs)</a>	

You cannot overwrite this file.

## File usage

The following page uses this file:

- [Menu:Commands](#)

## Namespaces

- [File](#)
- [Discussion](#)

## Variants

## Views

- [Read](#)
- [View source](#)
- [View history](#)

## More

- This page was last edited on 9 October 2006, at 14:24.

- [Privacy policy](#)
- [About Win-Test Wiki](#)
- [Disclaimers](#)



# File:DxClusterMacros.gif

From Win-Test Wiki

[Jump to navigation](#) [Jump to search](#)

- [File](#)
- [File history](#)
- [File usage](#)

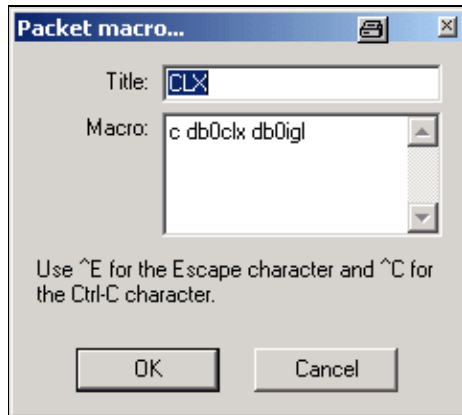

No higher resolution available.

[DxClusterMacros.gif](#) (239 × 215 pixels, file size: 5 KB, MIME type: image/gif)

## File history

Click on a date/time to view the file as it appeared at that time.

	Date/Time	Thumbnail	Dimensions	User	Comment
current	<a href="#">14:24, 9 October 2006</a>		239 × 215 (5 KB)	<a href="#">Dl6rai</a> ( <a href="#">talk</a>   <a href="#">contribs</a> )	

You cannot overwrite this file.

## File usage

The following page uses this file:

- [Menu:Commands](#)

## Namespaces

- [File](#)
- [Discussion](#)

## Variants

## Views

- [Read](#)
- [View source](#)
- [View history](#)

## More

- This page was last edited on 9 October 2006, at 14:24.

- [Privacy policy](#)
- [About Win-Test Wiki](#)
- [Disclaimers](#)



# File:DxClusterShortcuts.gif

From Win-Test Wiki

[Jump to navigation](#) [Jump to search](#)

- [File](#)
- [File history](#)
- [File usage](#)

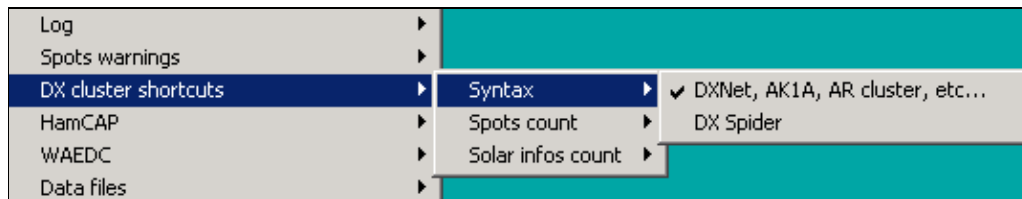

No higher resolution available.

[DxClusterShortcuts.gif](#) (536 × 101 pixels, file size: 2 KB, MIME type: image/gif)

## File history

Click on a date/time to view the file as it appeared at that time.

	Date/Time	Thumbnail	Dimensions	User	Comment
current	<a href="#">13:44, 22 September 2006</a>		536 × 101 (2 KB)	<a href="#">Dl6rai</a> ( <a href="#">talk</a>   <a href="#">contribs</a> )	

You cannot overwrite this file.

## File usage

The following page uses this file:

- [Menu:Commands](#)

## Namespaces

- [File](#)
- [Discussion](#)

## Variants

## Views

- [Read](#)
- [View source](#)
- [View history](#)

## More

- This page was last edited on 22 September 2006, at 13:44.

- [Privacy policy](#)
- [About Win-Test Wiki](#)
- [Disclaimers](#)



# File:DxClusterShortcuts.gif

From Win-Test Wiki

[Jump to navigation](#) [Jump to search](#)

- [File](#)
- [File history](#)
- [File usage](#)

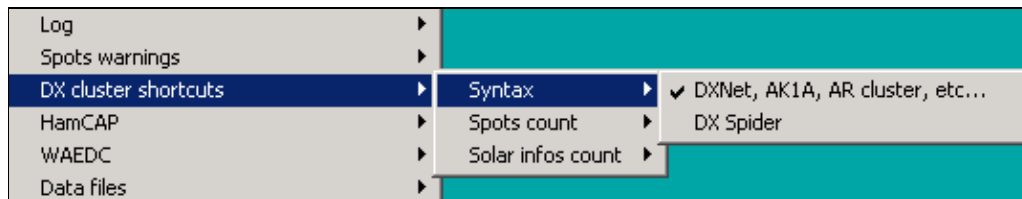

No higher resolution available.

[DxClusterShortcuts.gif](#) (536 × 101 pixels, file size: 2 KB, MIME type: image/gif)

## File history

Click on a date/time to view the file as it appeared at that time.

	Date/Time	Thumbnail	Dimensions	User	Comment
current	<a href="#">13:44, 22 September 2006</a>		536 × 101 (2 KB)	<a href="#">Dl6rai</a> ( <a href="#">talk</a>   <a href="#">contribs</a> )	

You cannot overwrite this file.

## File usage

The following page uses this file:

- [Menu:Commands](#)

## Namespaces

- [File](#)
- [Discussion](#)

## Variants

## Views

- [Read](#)
- [View source](#)
- [View history](#)

## More

- This page was last edited on 22 September 2006, at 13:44.

- [Privacy policy](#)
- [About Win-Test Wiki](#)
- [Disclaimers](#)





# File:dx-cluster-syntax.gif

From Win-Test Wiki

[Jump to navigation](#) [Jump to search](#)

- [File](#)
- [File history](#)
- [File usage](#)

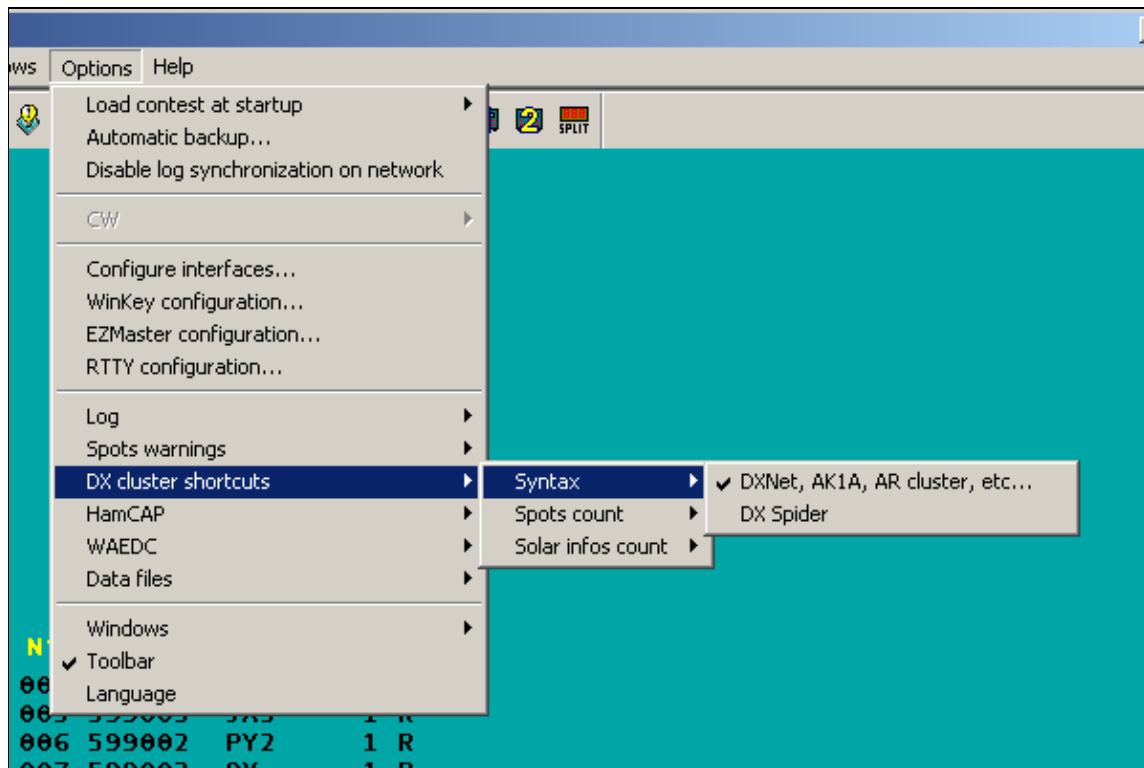

No higher resolution available.

[dx-cluster-syntax.gif](#) (597 × 398 pixels, file size: 8 KB, MIME type: image.gif)

## File history

Click on a date/time to view the file as it appeared at that time.

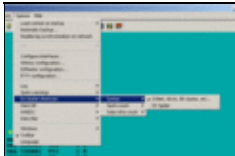
	Date/Time	Thumbnail	Dimensions	User	Comment
current	<a href="#">20:05, 26 July 2006</a>		597 × 398 (8 KB)	<a href="#">DL4NER</a> ( <a href="#">talk</a>   <a href="#">contribs</a> )	

You cannot overwrite this file.

## File usage

The following page uses this file:

- [DX Cluster/Packet](#)

## Namespaces

- [File](#)
- [Discussion](#)

## Variants

## Views

- [Read](#)
- [View source](#)
- [View history](#)

## More

- This page was last edited on 26 July 2006, at 20:05.

- [Privacy policy](#)
- [About Win-Test Wiki](#)
- [Disclaimers](#)



# File:dx-cluster-syntax.gif

From Win-Test Wiki

[Jump to navigation](#) [Jump to search](#)

- [File](#)
- [File history](#)
- [File usage](#)

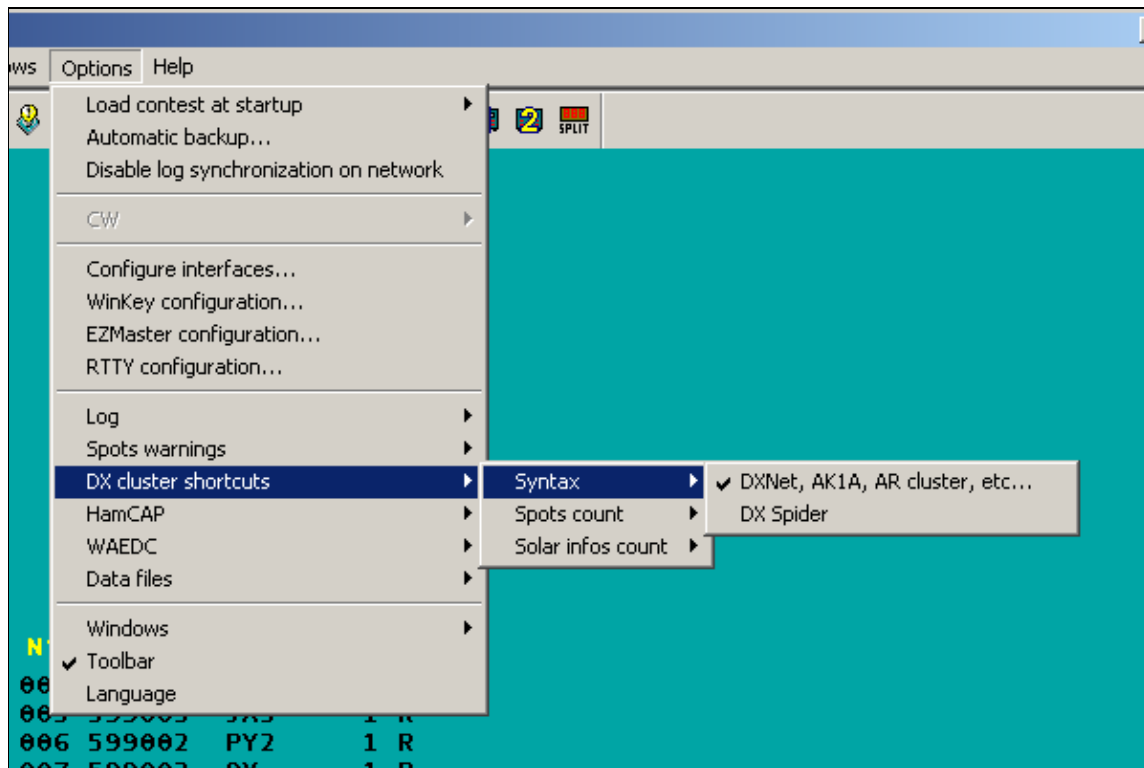

No higher resolution available.

[dx-cluster-syntax.gif](#) (597 × 398 pixels, file size: 8 KB, MIME type: image.gif)

## File history

Click on a date/time to view the file as it appeared at that time.

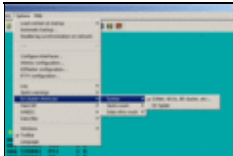
	Date/Time	Thumbnail	Dimensions	User	Comment
current	<a href="#">20:05, 26 July 2006</a>		597 × 398 (8 KB)	<a href="#">DL4NER</a> ( <a href="#">talk</a>   <a href="#">contribs</a> )	

You cannot overwrite this file.

## File usage

The following page uses this file:

- [DX Cluster/Packet](#)

## Namespaces

- [File](#)
- [Discussion](#)

## Variants

## Views

- [Read](#)
- [View source](#)
- [View history](#)

## More

- This page was last edited on 26 July 2006, at 20:05.

- [Privacy policy](#)
- [About Win-Test Wiki](#)
- [Disclaimers](#)



# File:DXDoublersJumpersForWin-Test.gif

From Win-Test Wiki

[Jump to navigation](#) [Jump to search](#)

- [File](#)
- [File history](#)
- [File usage](#)

The DXD is shipped configured for operation with CT, TRLog and WriteLog. To reconfigure the DXD for use with NA (or back to CT/TR/WriteLog from NA) follow these steps:

1. Remove the top cover by removing all the screws in the black cover itself only.
2. Locate the programming header P1, which is close to the 25 pin computer connector. Note that this is a standard computer-style programming header, with a single row of ten pins. Adjacent pins are either shorted together or open, depending upon the location of three supplied push-on shorting jumpers.
3. Pin 1 of P1 is closest to the rear of the DXD.
4. Place the jumpers on P1 depending upon the driving software as follows:

Software	Jumper 1	Jumper 2	Jumper 3
CT, TR, WriteLog	1-2	4-5	8-9
NA	2-3	5-6	9-10

5. Replace the top cover of the DXD.

**For Win-Test, place Jumper 1 & 2 in NA mode, Jumper in 3 CT mode, as shown above.**

No higher resolution available.

[DXDoublerJumpersForWin-Test.gif](#) (747 Å 448 pixels, file size: 47 KB, MIME type: image.gif)

Copied from the DX Doubler Manual, showing jumper settings to use for Win-Test.

## File history

Click on a date/time to view the file as it appeared at that time.

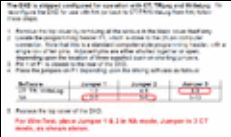
	Date/Time	Thumbnail	Dimensions	User	Comment
current	<u><a href="#">22:03, 12 November 2011</a></u>		747 Å 448 (47 KB)	<u><a href="#">N6TV (talk   contribs)</a></u>	Copied from the DX Doubler Manual, showing jumper settings to use for Win-Test.

You cannot overwrite this file.

## File usage

The following page uses this file:

- [Supported Accessories](#)

## Namespaces

- [File](#)
- [Discussion](#)

## Variants

## Views

- [Read](#)
- [View source](#)
- [View history](#)

## More

- This page was last edited on 12 November 2011, at 22:03.

- [Privacy policy](#)
- [About Win-Test Wiki](#)
- [Disclaimers](#)



# File:DXDoublersJumpersForWin-Test.gif

From Win-Test Wiki

[Jump to navigation](#) [Jump to search](#)

- [File](#)
- [File history](#)
- [File usage](#)

The DXD is shipped configured for operation with CT, TRLog and WriteLog. To reconfigure the DXD for use with NA (or back to CT/TR/WriteLog from NA) follow these steps:

1. Remove the top cover by removing all the screws in the black cover itself only.
2. Locate the programming header P1, which is close to the 25 pin computer connector. Note that this is a standard computer-style programming header, with a single row of ten pins. Adjacent pins are either shorted together or open, depending upon the location of three supplied push-on shorting jumpers.
3. Pin 1 of P1 is closest to the rear of the DXD.
4. Place the jumpers on P1 depending upon the driving software as follows:

Software	Jumper 1	Jumper 2	Jumper 3
CT, TR, WriteLog	1-2	4-5	8-9
NA	2-3	5-6	9-10

5. Replace the top cover of the DXD.

**For Win-Test, place Jumper 1 & 2 in NA mode, Jumper in 3 CT mode, as shown above.**

No higher resolution available.

[DXDoublerJumpersForWin-Test.gif](#) (747 Å 448 pixels, file size: 47 KB, MIME type: image.gif)

Copied from the DX Doubler Manual, showing jumper settings to use for Win-Test.

## File history

Click on a date/time to view the file as it appeared at that time.

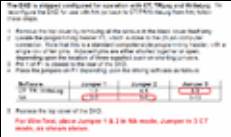
	Date/Time	Thumbnail	Dimensions	User	Comment
current	<a href="#">22:03, 12 November 2011</a>		747 Å 448 (47 KB)	<a href="#">N6TV (talk   contribs)</a>	Copied from the DX Doubler Manual, showing jumper settings to use for Win-Test.

You cannot overwrite this file.

## File usage

The following page uses this file:

- [Supported Accessories](#)

## Namespaces

- [File](#)
- [Discussion](#)

## Variants

## Views

- [Read](#)
- [View source](#)
- [View history](#)

## More

- This page was last edited on 12 November 2011, at 22:03.

- [Privacy policy](#)
- [About Win-Test Wiki](#)
- [Disclaimers](#)





# File:DxPeditionInfoField.gif

From Win-Test Wiki

[Jump to navigation](#) [Jump to search](#)

- [File](#)
- [File history](#)
- [File usage](#)

QSO	Mode	Bd	Time	Callsign	SentRcvd	Info	Dup
1	CW	20	12:28	DK20Y	599 599	MANFRED M15	
2	CW	20			599 599		

No higher resolution available.

[DxPeditionInfoField.gif](#) (769 × 103 pixels, file size: 4 KB, MIME type: image/gif)

## File history

Click on a date/time to view the file as it appeared at that time.

	Date/Time	Thumbnail	Dimensions	User	Comment
current	<a href="#">12:38, 17 November 2007</a>		769 × 103 (4 KB)	<a href="#">Dl6rai</a> ( <a href="#">talk</a>   <a href="#">contribs</a> )	

You cannot overwrite this file.

## File usage

The following page uses this file:

- [Menu:Options](#)

## Namespaces

- [File](#)
- [Discussion](#)

## Variants

## Views

- [Read](#)
- [View source](#)
- [View history](#)

## More

- This page was last edited on 17 November 2007, at 12:38.

- [Privacy policy](#)
- [About Win-Test Wiki](#)
- [Disclaimers](#)



# File:DxPeditionInfoField.gif

From Win-Test Wiki

[Jump to navigation](#) [Jump to search](#)

- [File](#)
- [File history](#)
- [File usage](#)

QSO	Mode	Bd	Time	Callsign	SentRcvd	Info	Dup
1	CW	20	12:28	DK20Y	599 599	MANFRED M15	
2	CW	20			599 599		

No higher resolution available.

[DxPeditionInfoField.gif](#) (769 × 103 pixels, file size: 4 KB, MIME type: image/gif)

## File history

Click on a date/time to view the file as it appeared at that time.

	Date/Time	Thumbnail	Dimensions	User	Comment
current	<a href="#">12:38, 17 November 2007</a>		769 × 103 (4 KB)	<a href="#">Dl6rai</a> ( <a href="#">talk</a>   <a href="#">contribs</a> )	

You cannot overwrite this file.

## File usage

The following page uses this file:

- [Menu:Options](#)

## Namespaces

- [File](#)
- [Discussion](#)

## Variants

## Views

- [Read](#)
- [View source](#)
- [View history](#)

## More

- This page was last edited on 17 November 2007, at 12:38.

- [Privacy policy](#)
- [About Win-Test Wiki](#)
- [Disclaimers](#)



# File:DxPeditionOptions.gif

From Win-Test Wiki

[Jump to navigation](#) [Jump to search](#)

- [File](#)
- [File history](#)
- [File usage](#)

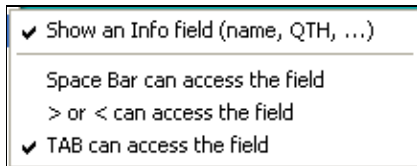

No higher resolution available.

[DxPeditionOptions.gif](#) (216 × 84 pixels, file size: 2 KB, MIME type: image.gif)

## File history

Click on a date/time to view the file as it appeared at that time.

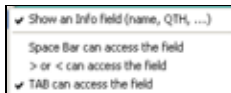
	Date/Time	Thumbnail	Dimensions	User	Comment
current	<a href="#">12:40, 17 November 2007</a>		216 × 84 (2 KB)	<a href="#">Dl6rai</a> ( <a href="#">talk</a>   <a href="#">contribs</a> )	

You cannot overwrite this file.

## File usage

The following page uses this file:

- [Menu:Options](#)

## Namespaces

- [File](#)
- [Discussion](#)

## Variants

## Views

- [Read](#)
- [View source](#)
- [View history](#)

## More

- This page was last edited on 17 November 2007, at 12:40.

- [Privacy policy](#)
- [About Win-Test Wiki](#)
- [Disclaimers](#)



# File:DxPeditionOptions.gif

From Win-Test Wiki

[Jump to navigation](#) [Jump to search](#)

- [File](#)
- [File history](#)
- [File usage](#)

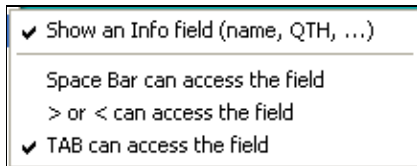

No higher resolution available.

[DxPeditionOptions.gif](#) (216 × 84 pixels, file size: 2 KB, MIME type: image.gif)

## File history

Click on a date/time to view the file as it appeared at that time.

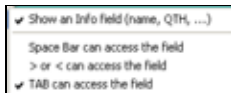
	Date/Time	Thumbnail	Dimensions	User	Comment
current	<a href="#">12:40, 17 November 2007</a>		216 × 84 (2 KB)	<a href="#">Dl6rai</a> ( <a href="#">talk</a>   <a href="#">contribs</a> )	

You cannot overwrite this file.

## File usage

The following page uses this file:

- [Menu:Options](#)

## Namespaces

- [File](#)
- [Discussion](#)

## Variants

## Views

- [Read](#)
- [View source](#)
- [View history](#)

## More

- This page was last edited on 17 November 2007, at 12:40.

- [Privacy policy](#)
- [About Win-Test Wiki](#)
- [Disclaimers](#)





# File:EditApplyExchangeToEveryQSO.gif

From Win-Test Wiki

[Jump to navigation](#) [Jump to search](#)

- [File](#)
- [File history](#)
- [File usage](#)
- [Metadata](#)

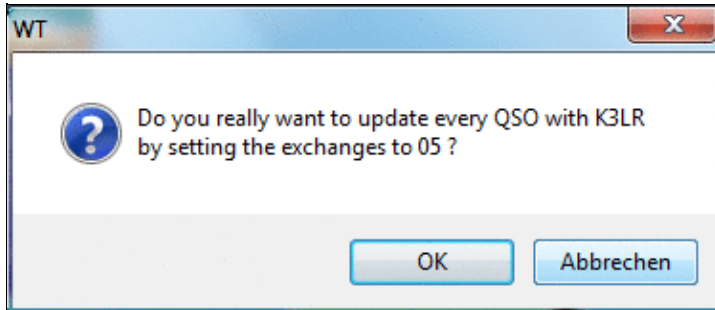

No higher resolution available.

[EditApplyExchangeToEveryQSO.gif](#) (374 × 161 pixels, file size: 19 KB, MIME type: image.gif)

## File history

Click on a date/time to view the file as it appeared at that time.

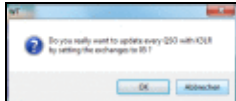
	Date/Time	Thumbnail	Dimensions	User	Comment
current	<a href="#">16:37, 17 December 2016</a>		374 × 161 (19 KB)	<a href="#">Dl6rai</a> ( <a href="#">talk</a>   <a href="#">contribs</a> )	

You cannot overwrite this file.

## File usage

The following page uses this file:

- [Menu:Edit](#)

## Metadata

This file contains additional information, probably added from the digital camera or scanner used to create or digitize it.

If the file has been modified from its original state, some details may not fully reflect the modified file.

**Horizontal resolution** 37.79 dpc

**Vertical resolution** 37.79 dpc

Horizontal resolution 37.79 dpc

## Namespaces

- [File](#)
- [Discussion](#)

## Variants

## Views

- [Read](#)
- [View source](#)
- [View history](#)

## More

- This page was last edited on 17 December 2016, at 16:37.

- [Privacy policy](#)
- [About Win-Test Wiki](#)
- [Disclaimers](#)



# File:EditApplyExchangeToEveryQSO.gif

From Win-Test Wiki

[Jump to navigation](#) [Jump to search](#)

- [File](#)
- [File history](#)
- [File usage](#)
- [Metadata](#)

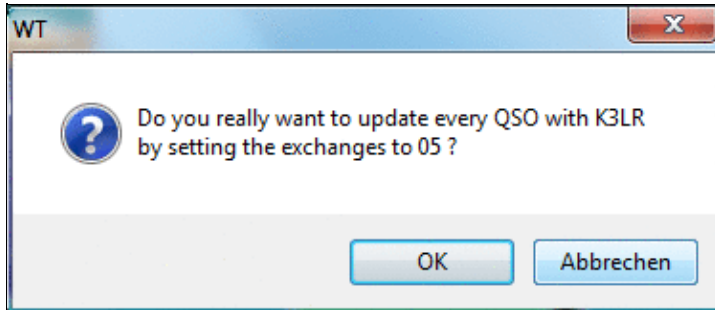

No higher resolution available.

[EditApplyExchangeToEveryQSO.gif](#) (374 × 161 pixels, file size: 19 KB, MIME type: image.gif)

## File history

Click on a date/time to view the file as it appeared at that time.

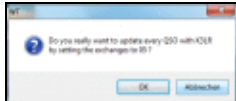
	Date/Time	Thumbnail	Dimensions	User	Comment
current	<a href="#">16:37, 17 December 2016</a>		374 × 161 (19 KB)	<a href="#">Dl6rai</a> ( <a href="#">talk</a>   <a href="#">contribs</a> )	

You cannot overwrite this file.

## File usage

The following page uses this file:

- [Menu:Edit](#)

## Metadata

This file contains additional information, probably added from the digital camera or scanner used to create or digitize it.

If the file has been modified from its original state, some details may not fully reflect the modified file.

**Horizontal resolution** 37.79 dpc

**Vertical resolution** 37.79 dpc

**Horizontal resolution** 37.79 dpc

## Namespaces

- [File](#)
- [Discussion](#)

## Variants

## Views

- [Read](#)
- [View source](#)
- [View history](#)

## More

- This page was last edited on 17 December 2016, at 16:37.

- [Privacy policy](#)
- [About Win-Test Wiki](#)
- [Disclaimers](#)



# File:EditDateTimeFrequency.gif

From Win-Test Wiki

[Jump to navigation](#) [Jump to search](#)

- [File](#)
- [File history](#)
- [File usage](#)

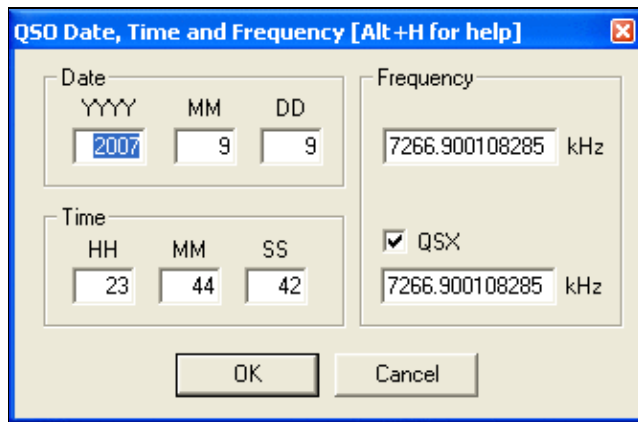

No higher resolution available.

[EditDateTimeFrequency.gif](#) (332 × 217 pixels, file size: 8 KB, MIME type: image.gif)

## File history

Click on a date/time to view the file as it appeared at that time.

	Date/Time	Thumbnail	Dimensions	User	Comment
current	<a href="#">07:17, 15 September 2007</a>		332 × 217 (8 KB)	<a href="#">Dl6rai</a> ( <a href="#">talk</a>   <a href="#">contribs</a> )	

You cannot overwrite this file.

## File usage

The following page uses this file:

- [Menu:Edit](#)

## Namespaces

- [File](#)
- [Discussion](#)

## Variants

## Views

- [Read](#)
- [View source](#)
- [View history](#)

## More

- This page was last edited on 15 September 2007, at 07:17.

- [Privacy policy](#)
- [About Win-Test Wiki](#)
- [Disclaimers](#)



# File:EditDateTimeFrequency.gif

From Win-Test Wiki

[Jump to navigation](#) [Jump to search](#)

- [File](#)
- [File history](#)
- [File usage](#)

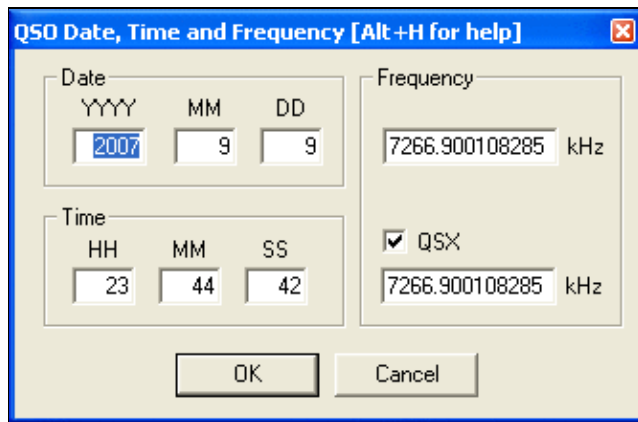

No higher resolution available.

[EditDateTimeFrequency.gif](#) (332 × 217 pixels, file size: 8 KB, MIME type: image.gif)

## File history

Click on a date/time to view the file as it appeared at that time.

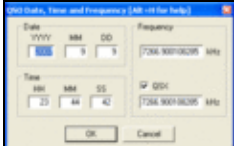
	Date/Time	Thumbnail	Dimensions	User	Comment
current	<a href="#">07:17, 15 September 2007</a>		332 × 217 (8 KB)	<a href="#">Dl6rai</a> ( <a href="#">talk</a>   <a href="#">contribs</a> )	

You cannot overwrite this file.

## File usage

The following page uses this file:

- [Menu:Edit](#)

## Namespaces

- [File](#)
- [Discussion](#)

## Variants

## Views

- [Read](#)
- [View source](#)
- [View history](#)

## More

- This page was last edited on 15 September 2007, at 07:17.

- [Privacy policy](#)
- [About Win-Test Wiki](#)
- [Disclaimers](#)





# File:editserial.gif

From Win-Test Wiki

[Jump to navigation](#) [Jump to search](#)

- [File](#)
- [File history](#)
- [File usage](#)

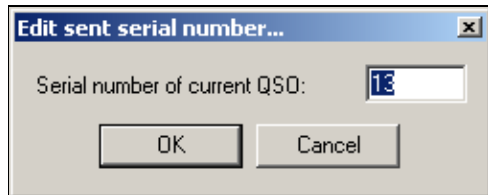

No higher resolution available.

[editserial.gif](#) (252 × 100 pixels, file size: 2 KB, MIME type: image.gif)

## File history

Click on a date/time to view the file as it appeared at that time.

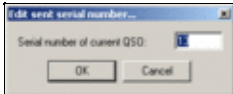
Date/Time	Thumbnail	Dimensions	User	Comment
current <a href="#">21:32, 27 July 2006</a>		252 × 100 (2 KB)	<a href="#">DL4NER</a> ( <a href="#">talk</a>   <a href="#">contribs</a> )	

You cannot overwrite this file.

## File usage

The following page uses this file:

- [Menu:Edit](#)

## Namespaces

- [File](#)
- [Discussion](#)

## Variants

## Views

- [Read](#)
- [View source](#)
- [View history](#)

## More

- This page was last edited on 27 July 2006, at 21:32.

- [Privacy policy](#)
- [About Win-Test Wiki](#)
- [Disclaimers](#)



# File:EditSerial.gif

From Win-Test Wiki

[Jump to navigation](#) [Jump to search](#)

- [File](#)
- [File history](#)
- [File usage](#)

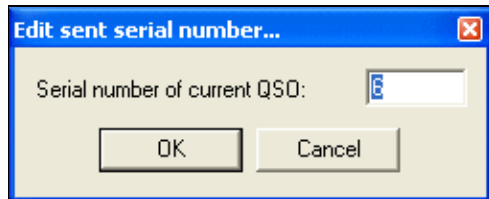

No higher resolution available.

[EditSerial.gif](#) (253 × 102 pixels, file size: 4 KB, MIME type: image.gif)

Edit serial # screenshot

## File history

Click on a date/time to view the file as it appeared at that time.

	Date/Time	Thumbnail	Dimensions	User	Comment
current	<a href="#">14:26, 5 January 2006</a>		253 × 102 (4 KB)	<a href="#">M0CLW</a> ( <a href="#">talk</a>   <a href="#">contribs</a> )	Edit serial # screenshot

You cannot overwrite this file.

## File usage

The following page uses this file:

- [Multi-op/Issues/Editing serials](#)

## Namespaces

- [File](#)
- [Discussion](#)

## Variants

## Views

- [Read](#)
- [View source](#)

- [View history](#)

## More

- This page was last edited on 5 January 2006, at 14:26.

- [Privacy policy](#)
- [About Win-Test Wiki](#)
- [Disclaimers](#)



# File:EditSerial.gif

From Win-Test Wiki

[Jump to navigation](#) [Jump to search](#)

- [File](#)
- [File history](#)
- [File usage](#)

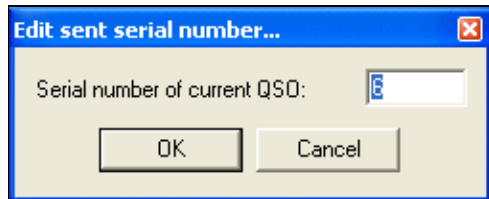

No higher resolution available.

[EditSerial.gif](#) (253 × 102 pixels, file size: 4 KB, MIME type: image.gif)

Edit serial # screenshot

## File history

Click on a date/time to view the file as it appeared at that time.

	Date/Time	Thumbnail	Dimensions	User	Comment
current	<a href="#">14:26, 5 January 2006</a>		253 × 102 (4 KB)	<a href="#">M0CLW</a> ( <a href="#">talk</a>   <a href="#">contribs</a> )	Edit serial # screenshot

You cannot overwrite this file.

## File usage

The following page uses this file:

- [Multi-op/Issues/Editing serials](#)

## Namespaces

- [File](#)
- [Discussion](#)

## Variants

## Views

- [Read](#)
- [View source](#)

- [View history](#)

## More

- This page was last edited on 5 January 2006, at 14:26.

- [Privacy policy](#)
- [About Win-Test Wiki](#)
- [Disclaimers](#)



# File:editserial.gif

From Win-Test Wiki

[Jump to navigation](#) [Jump to search](#)

- [File](#)
- [File history](#)
- [File usage](#)

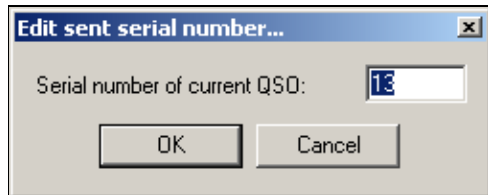

No higher resolution available.

[editserial.gif](#) (252 × 100 pixels, file size: 2 KB, MIME type: image.gif)

## File history

Click on a date/time to view the file as it appeared at that time.

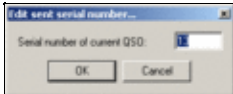
	Date/Time	Thumbnail	Dimensions	User	Comment
current	<a href="#">21:32, 27 July 2006</a>		252 × 100 (2 KB)	<a href="#">DL4NER</a> ( <a href="#">talk</a>   <a href="#">contribs</a> )	

You cannot overwrite this file.

## File usage

The following page uses this file:

- [Menu:Edit](#)

## Namespaces

- [File](#)
- [Discussion](#)

## Variants

## Views

- [Read](#)
- [View source](#)
- [View history](#)

## More

- This page was last edited on 27 July 2006, at 21:32.

- [Privacy policy](#)
- [About Win-Test Wiki](#)
- [Disclaimers](#)





# File:EnableDVKinmicroHAM.gif

From Win-Test Wiki

[Jump to navigation](#) [Jump to search](#)

- [File](#)
- [File history](#)
- [File usage](#)

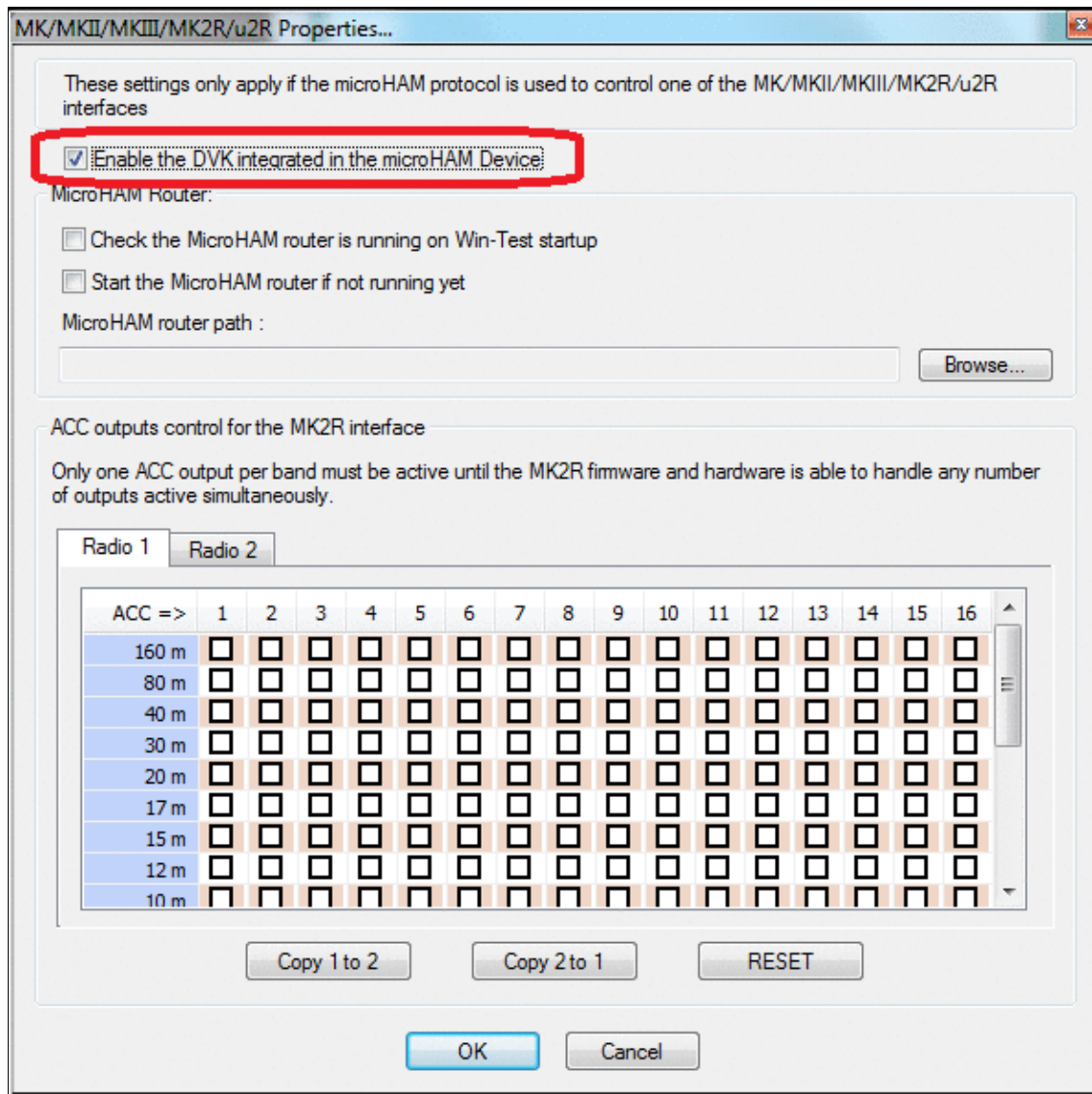

No higher resolution available.

[EnableDVKinmicroHAM.gif](#) (594 × 593 pixels, file size: 53 KB, MIME type: image/gif)

## File history

Click on a date/time to view the file as it appeared at that time.

Date/Time	Thumbnail	Dimensions	User	Comment
current <a href="#">07:58, 2 March 2021</a>		594 × 593 (53 KB)	<a href="#">Dl6rai</a> ( <a href="#">talk</a>   <a href="#">contribs</a> )	

You cannot overwrite this file.

## File usage

The following page uses this file:

- [DVK CW RTTY Messaging](#)

## Namespaces

- [File](#)
- [Discussion](#)

## Variants

## Views

- [Read](#)
- [View source](#)
- [View history](#)

## More

- This page was last edited on 2 March 2021, at 07:58.
- [Privacy policy](#)
- [About Win-Test Wiki](#)
- [Disclaimers](#)



# File:EnableDVKinmicroHAM.gif

From Win-Test Wiki

[Jump to navigation](#) [Jump to search](#)

- [File](#)
- [File history](#)
- [File usage](#)

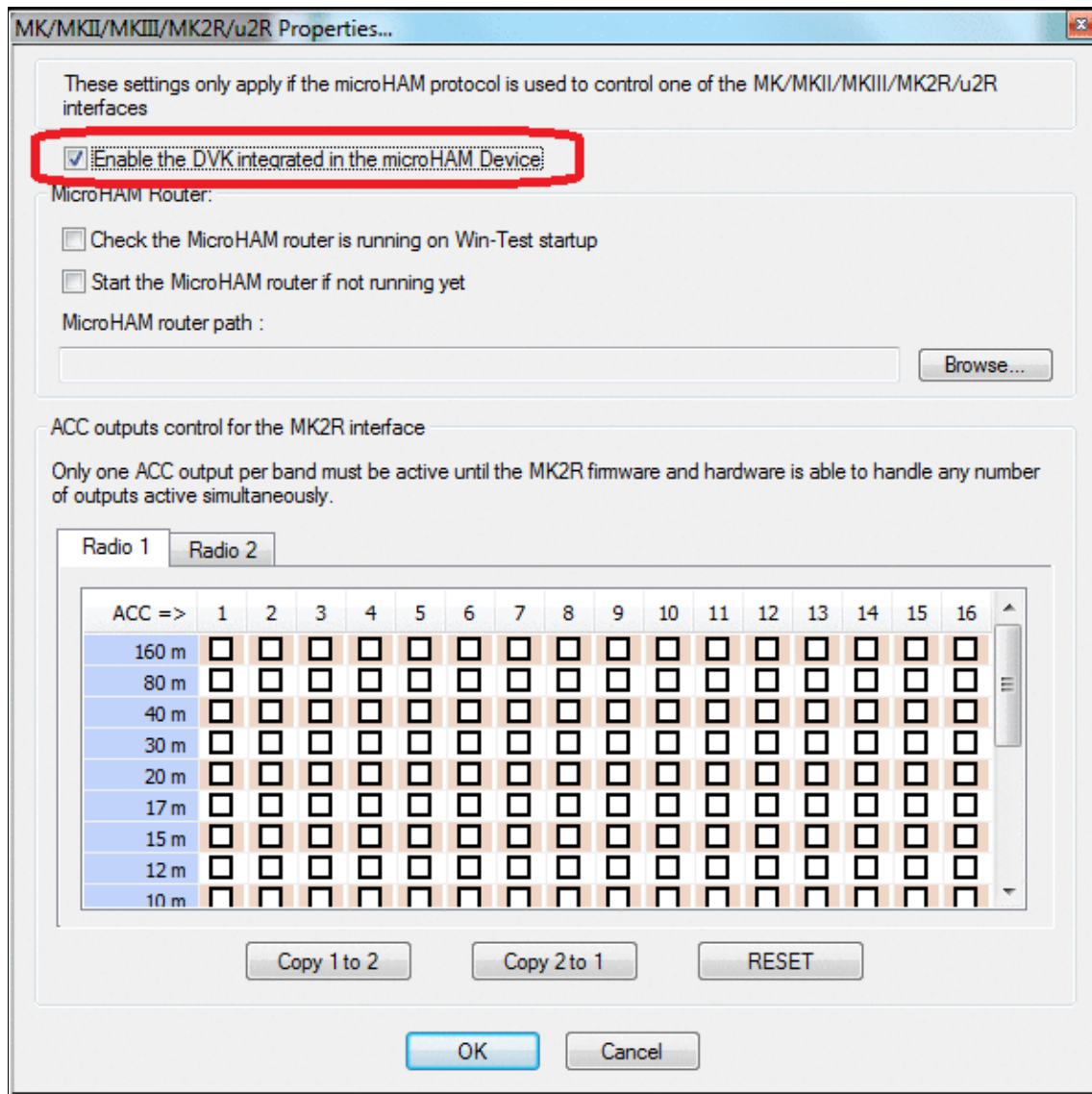

No higher resolution available.

[EnableDVKinmicroHAM.gif](#) (594 × 593 pixels, file size: 53 KB, MIME type: image.gif)

## File history

Click on a date/time to view the file as it appeared at that time.

Date/Time	Thumbnail	Dimensions	User	Comment
current <a href="#">07:58, 2 March 2021</a>		594 × 593 (53 KB)	<a href="#">Dl6rai</a> ( <a href="#">talk</a>   <a href="#">contribs</a> )	

You cannot overwrite this file.

## File usage

The following page uses this file:

- [DVK CW RTTY Messaging](#)

## Namespaces

- [File](#)
- [Discussion](#)

## Variants

## Views

- [Read](#)
- [View source](#)
- [View history](#)

## More

- This page was last edited on 2 March 2021, at 07:58.
- [Privacy policy](#)
- [About Win-Test Wiki](#)
- [Disclaimers](#)



# File:ExchangeGuessingBandmap.gif

From Win-Test Wiki

[Jump to navigation](#) [Jump to search](#)

- [File](#)
- [File history](#)
- [File usage](#)

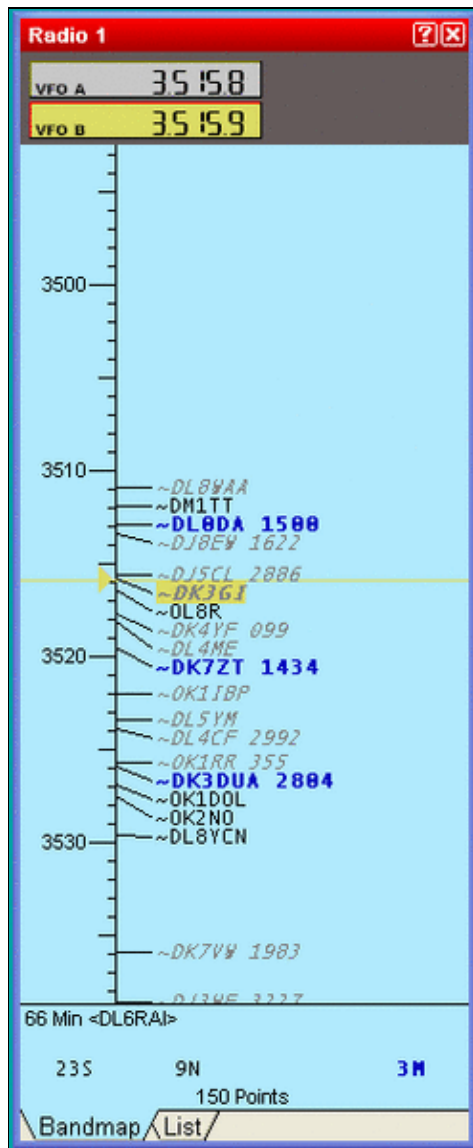

Size of this preview: 246 Å 599 pixels. Other resolution: 253 Å 616 pixels.  
Original file (253 Å 616 pixels, file size: 11 KB, MIME type: image.gif)

## File history

Click on a date/time to view the file as it appeared at that time.

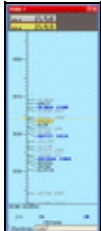
Date/Time	Thumbnail	Dimensions	User	Comment
current <u>10:46, 1 January 2007</u>		253 Å 616 (11 KB)	<u>Dl6rai</u> ( <a href="#">talk</a>   <a href="#">contribs</a> )	

You cannot overwrite this file.

## File usage

The following page uses this file:

- [Database Files](#)

## Namespaces

- [File](#)
- [Discussion](#)

## Variants

## Views

- [Read](#)
- [View source](#)
- [View history](#)

## More

- This page was last edited on 1 January 2007, at 10:46.

- [Privacy policy](#)
- [About Win-Test Wiki](#)
- [Disclaimers](#)



# File:ExchangeGuessingBandmap.gif

From Win-Test Wiki

[Jump to navigation](#) [Jump to search](#)

- [File](#)
- [File history](#)
- [File usage](#)

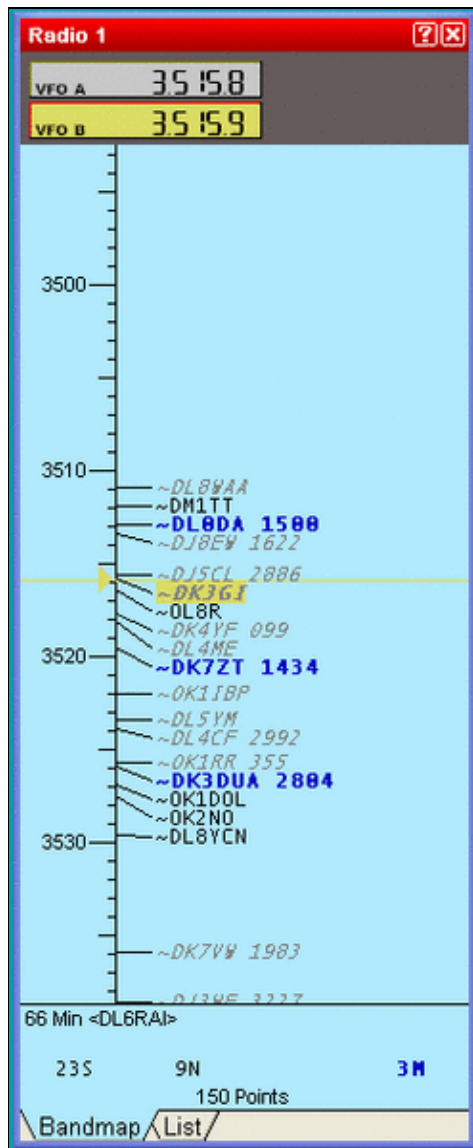

Size of this preview: [246 × 599 pixels](#). Other resolution: [253 × 616 pixels](#).  
[Original file](#) (253 × 616 pixels, file size: 11 KB, MIME type: image.gif)

## File history

Click on a date/time to view the file as it appeared at that time.

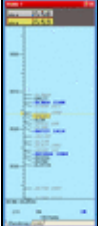
Date/Time	Thumbnail	Dimensions	User	Comment
current <a href="#">10:46, 1 January 2007</a>		<a href="#">253 × 616</a> (11 KB)	<a href="#">Dl6rai</a> ( <a href="#">talk</a>   <a href="#">contribs</a> )	

You cannot overwrite this file.

## File usage

The following page uses this file:

- [Database Files](#)

## Namespaces

- [File](#)
- [Discussion](#)

## Variants

## Views

- [Read](#)
- [View source](#)
- [View history](#)

## More

- This page was last edited on 1 January 2007, at 10:46.

- [Privacy policy](#)
- [About Win-Test Wiki](#)
- [Disclaimers](#)





# File:ExportFileTo.gif

From Win-Test Wiki

[Jump to navigation](#) [Jump to search](#)

- [File](#)
- [File history](#)
- [File usage](#)

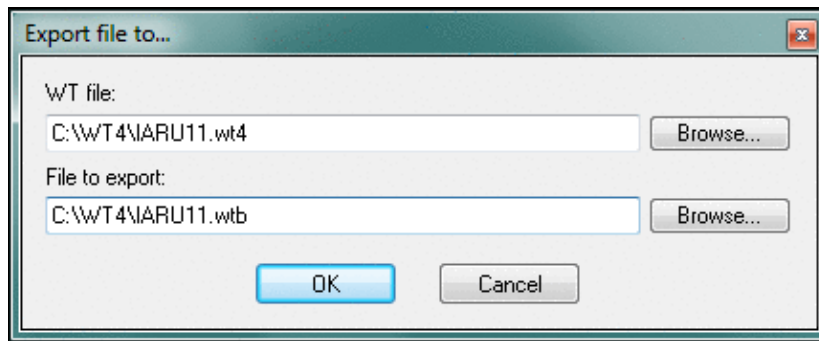

No higher resolution available.

[ExportFileTo.gif](#) (429 × 174 pixels, file size: 15 KB, MIME type: image.gif)

Win-test 4 version of Export File To dialog

## File history

Click on a date/time to view the file as it appeared at that time.

	Date/Time	Thumbnail	Dimensions	User	Comment
current	<a href="#">00:06, 17 October 2011</a>		429 × 174 (15 KB)	<a href="#">N6TV</a> ( <a href="#">talk</a>   <a href="#">contribs</a> )	Win-test 4 version of Export File To dialog

You cannot overwrite this file.

## File usage

The following page uses this file:

- [Menu:File new](#)

## Namespaces

- [File](#)
- [Discussion](#)

## Variants

## Views

- [Read](#)
- [View source](#)
- [View history](#)

## More

- This page was last edited on 17 October 2011, at 00:06.

- [Privacy policy](#)
- [About Win-Test Wiki](#)
- [Disclaimers](#)



# File:ExportFileTo.gif

From Win-Test Wiki

[Jump to navigation](#) [Jump to search](#)

- [File](#)
- [File history](#)
- [File usage](#)

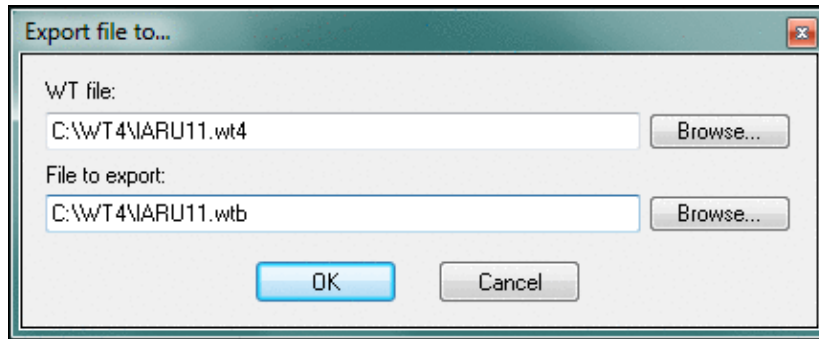

No higher resolution available.

[ExportFileTo.gif](#) (429 × 174 pixels, file size: 15 KB, MIME type: image.gif)

Win-test 4 version of Export File To dialog

## File history

Click on a date/time to view the file as it appeared at that time.

	Date/Time	Thumbnail	Dimensions	User	Comment
current	<a href="#">00:06, 17 October 2011</a>		429 × 174 (15 KB)	<a href="#">N6TV</a> ( <a href="#">talk</a>   <a href="#">contribs</a> )	Win-test 4 version of Export File To dialog

You cannot overwrite this file.

## File usage

The following page uses this file:

- [Menu:File new](#)

## Namespaces

- [File](#)
- [Discussion](#)

## Variants

## Views

- [Read](#)
- [View source](#)
- [View history](#)

## More

- This page was last edited on 17 October 2011, at 00:06.

- [Privacy policy](#)
- [About Win-Test Wiki](#)
- [Disclaimers](#)



# File:Ezmaster.PNG

From Win-Test Wiki

[Jump to navigation](#) [Jump to search](#)

- [File](#)
- [File history](#)
- [File usage](#)

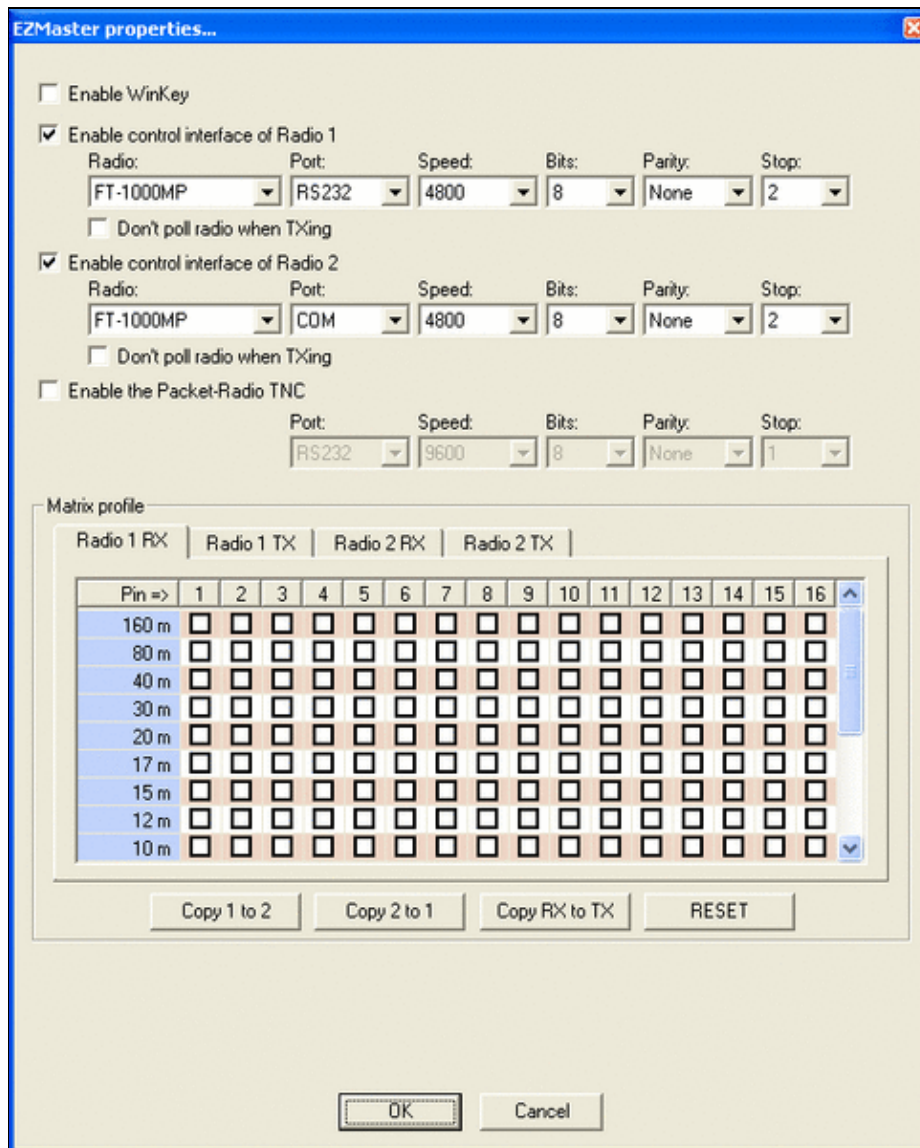

Size of this preview: [483 × 599 pixels](#). Other resolutions: [193 × 240 pixels](#) | [563 × 698 pixels](#). [Original file](#) (563 × 698 pixels, file size: 24 KB, MIME type: image.gif)

## File history

Click on a date/time to view the file as it appeared at that time.

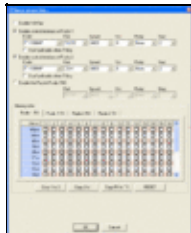
Date/Time	Thumbnail	Dimensions	User	Comment
current <a href="#">08:42, 8 October 2006</a>		563 × 698 (24 KB)	<a href="#">Ct1boh</a> ( <a href="#">talk</a>   <a href="#">contribs</a> )	

You cannot overwrite this file.

## File usage

The following page uses this file:

- [Menu:Options](#)

## Namespaces

- [File](#)
- [Discussion](#)

## Variants

## Views

- [Read](#)
- [View source](#)
- [View history](#)

## More

- This page was last edited on 8 October 2006, at 08:42.
- [Privacy policy](#)
- [About Win-Test Wiki](#)
- [Disclaimers](#)



# File:Ezmaster.PNG

From Win-Test Wiki

[Jump to navigation](#) [Jump to search](#)

- [File](#)
- [File history](#)
- [File usage](#)

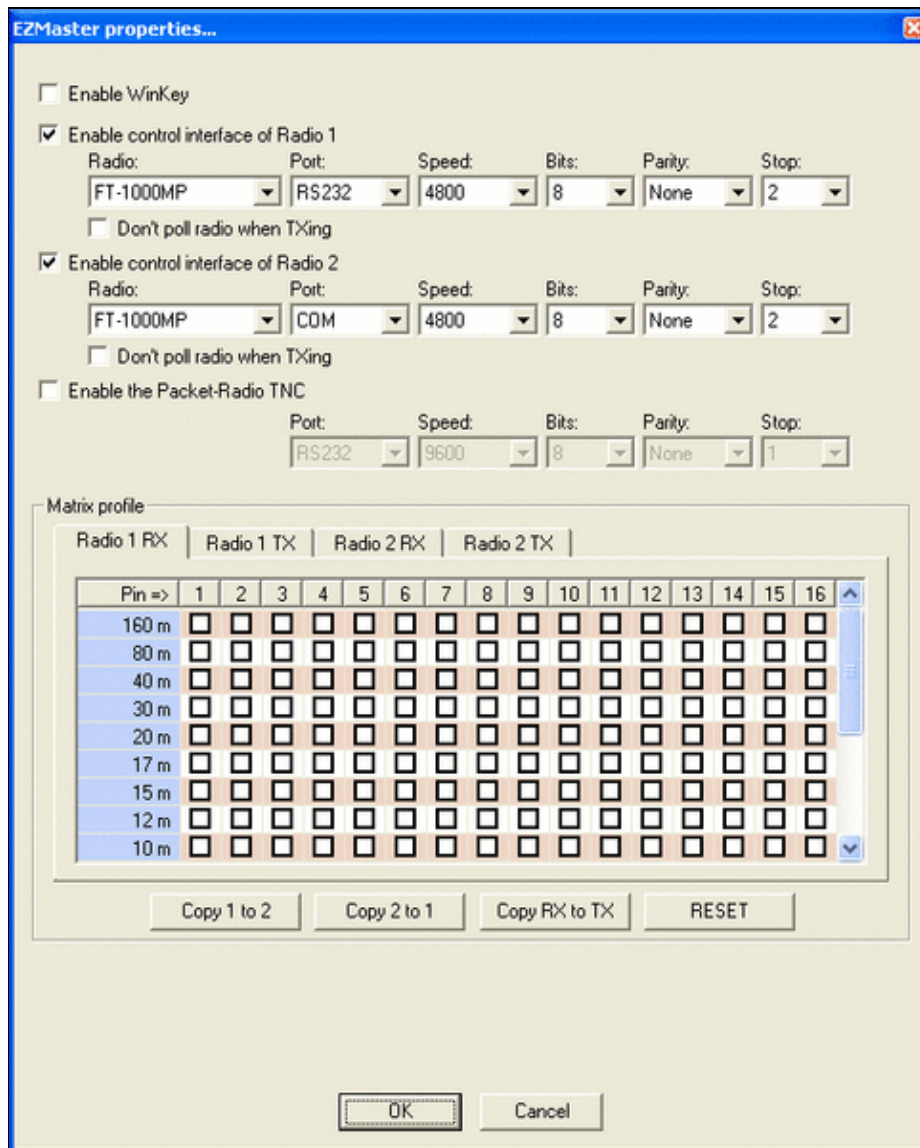

Size of this preview: [483 × 599 pixels](#). Other resolutions: [193 × 240 pixels](#) | [563 × 698 pixels](#).  
[Original file](#) (563 × 698 pixels, file size: 24 KB, MIME type: image.gif)

## File history

Click on a date/time to view the file as it appeared at that time.

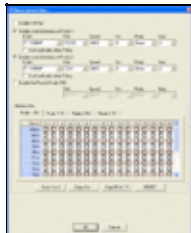
Date/Time	Thumbnail	Dimensions	User	Comment
current <a href="#">08:42, 8 October 2006</a>		<a href="#">563 × 698</a> (24 KB)	<a href="#">Ct1boh</a> ( <a href="#">talk</a>   <a href="#">contribs</a> )	

You cannot overwrite this file.

## File usage

The following page uses this file:

- [Menu:Options](#)

## Namespaces

- [File](#)
- [Discussion](#)

## Variants

## Views

- [Read](#)
- [View source](#)
- [View history](#)

## More

- This page was last edited on 8 October 2006, at 08:42.
- [Privacy policy](#)
- [About Win-Test Wiki](#)
- [Disclaimers](#)





# File:FileCleanLog.PNG

From Win-Test Wiki

[Jump to navigation](#) [Jump to search](#)

- [File](#)
- [File history](#)
- [File usage](#)
- [Metadata](#)

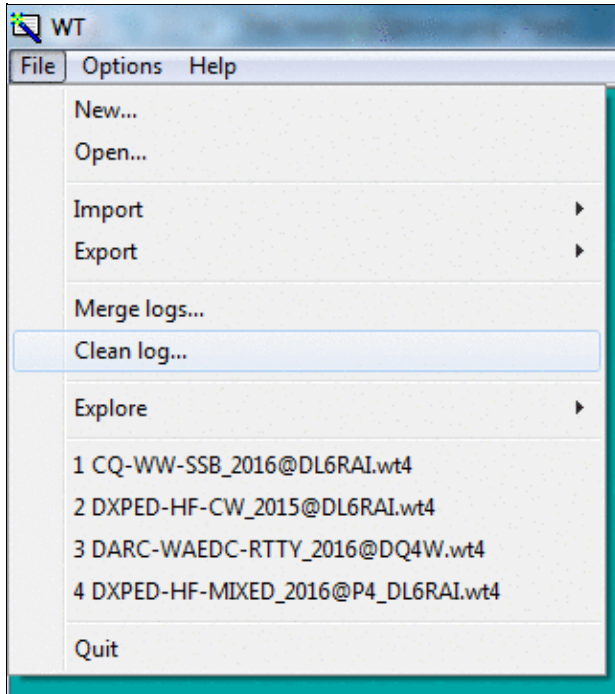

No higher resolution available.

[FileCleanLog.PNG](#) (321 × 362 pixels, file size: 25 KB, MIME type: image/gif)

## File history

Click on a date/time to view the file as it appeared at that time.

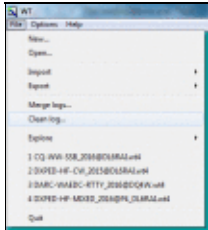
	Date/Time	Thumbnail	Dimensions	User	Comment
current	<a href="#">17:51, 17 December 2016</a>		321 × 362 (25 KB)	<a href="#">DL6rai</a> ( <a href="#">talk</a>   <a href="#">contribs</a> )	

Date/Time	Thumbnail	Dimensions	User	Comment
You cannot overwrite this file.				

## File usage

The following page uses this file:

- [Menu:File new](#)

## Metadata

This file contains additional information, probably added from the digital camera or scanner used to create or digitize it.

If the file has been modified from its original state, some details may not fully reflect the modified file.

**Horizontal resolution** 37.79 dpc

**Vertical resolution** 37.79 dpc

## Namespaces

- [File](#)
- [Discussion](#)

## Variants

## Views

- [Read](#)
- [View source](#)
- [View history](#)

## More

- This page was last edited on 17 December 2016, at 17:51.

- [Privacy policy](#)
- [About Win-Test Wiki](#)
- [Disclaimers](#)



# File:FileCleanLog.PNG

From Win-Test Wiki

[Jump to navigation](#) [Jump to search](#)

- [File](#)
- [File history](#)
- [File usage](#)
- [Metadata](#)

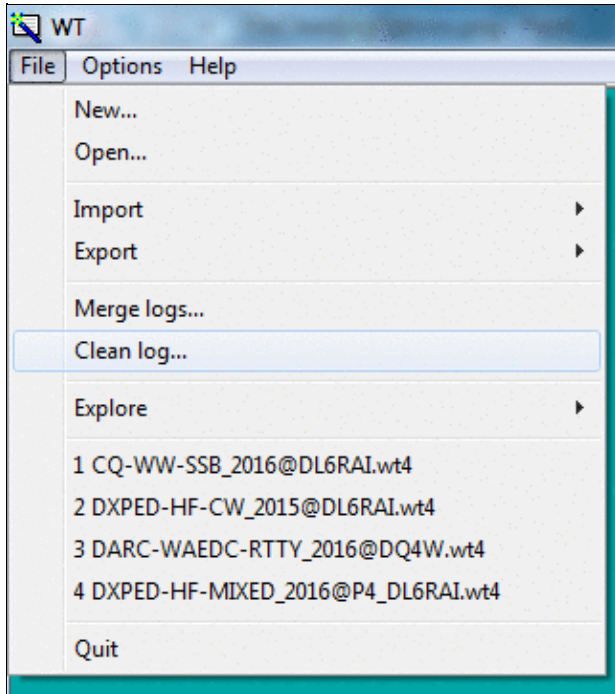

No higher resolution available.

[FileCleanLog.PNG](#) (321 × 362 pixels, file size: 25 KB, MIME type: image/gif)

## File history

Click on a date/time to view the file as it appeared at that time.

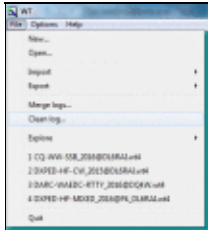
	Date/Time	Thumbnail	Dimensions	User	Comment
current	<a href="#">17:51, 17 December 2016</a>		321 × 362 (25 KB)	<a href="#">Dl6rai</a> ( <a href="#">talk</a>   <a href="#">contribs</a> )	

Date/Time	Thumbnail	Dimensions	User	Comment
You cannot overwrite this file.				

## File usage

The following page uses this file:

- [Menu:File new](#)

## Metadata

This file contains additional information, probably added from the digital camera or scanner used to create or digitize it.

If the file has been modified from its original state, some details may not fully reflect the modified file.

**Horizontal resolution** 37.79 dpc

**Vertical resolution** 37.79 dpc

## Namespaces

- [File](#)
- [Discussion](#)

## Variants

## Views

- [Read](#)
- [View source](#)
- [View history](#)

## More

- This page was last edited on 17 December 2016, at 17:51.

- [Privacy policy](#)
- [About Win-Test Wiki](#)
- [Disclaimers](#)



# File:FileCleanLogOptions.PNG

From Win-Test Wiki

[Jump to navigation](#) [Jump to search](#)

- [File](#)
- [File history](#)
- [File usage](#)
- [Metadata](#)

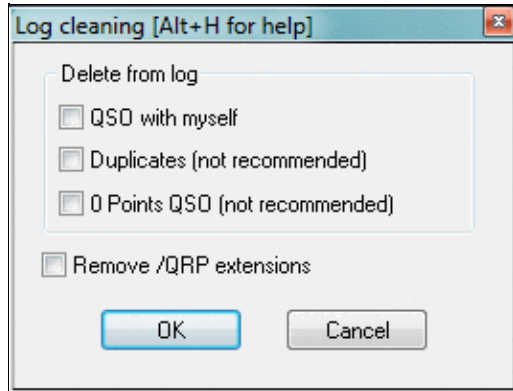

No higher resolution available.

[FileCleanLogOptions.PNG](#) (266 × 203 pixels, file size: 9 KB, MIME type: image.gif)

## File history

Click on a date/time to view the file as it appeared at that time.

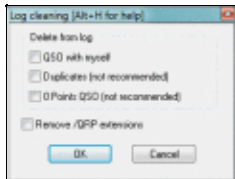
	Date/Time	Thumbnail	Dimensions	User	Comment
current	<a href="#">17:51, 17 December 2016</a>		266 × 203 (9 KB)	<a href="#">Dl6rai</a> ( <a href="#">talk</a>   <a href="#">contribs</a> )	

You cannot overwrite this file.

## File usage

The following page uses this file:

- [Menu:File new](#)

## Metadata

This file contains additional information, probably added from the digital camera or scanner used to create or digitize it.

If the file has been modified from its original state, some details may not fully reflect the modified file.

**Horizontal resolution** 37.79 dpc

**Vertical resolution** 37.79 dpc

## Namespaces

- [File](#)
- [Discussion](#)

## Variants

## Views

- [Read](#)
- [View source](#)
- [View history](#)

## More

- This page was last edited on 17 December 2016, at 17:51.

- [Privacy policy](#)
- [About Win-Test Wiki](#)
- [Disclaimers](#)



# File:FileCleanLogOptions.PNG

From Win-Test Wiki

[Jump to navigation](#) [Jump to search](#)

- [File](#)
- [File history](#)
- [File usage](#)
- [Metadata](#)

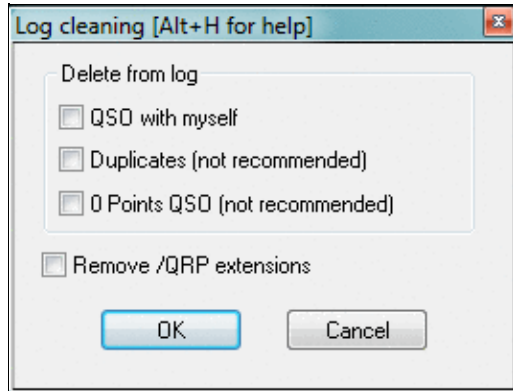

No higher resolution available.

[FileCleanLogOptions.PNG](#) (266 × 203 pixels, file size: 9 KB, MIME type: image.gif)

## File history

Click on a date/time to view the file as it appeared at that time.

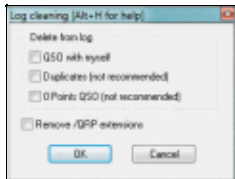
	Date/Time	Thumbnail	Dimensions	User	Comment
current	<a href="#">17:51, 17 December 2016</a>		266 × 203 (9 KB)	<a href="#">Dl6rai</a> ( <a href="#">talk</a>   <a href="#">contribs</a> )	

You cannot overwrite this file.

## File usage

The following page uses this file:

- [Menu:File new](#)

## Metadata

This file contains additional information, probably added from the digital camera or scanner used to create or digitize it.

If the file has been modified from its original state, some details may not fully reflect the modified file.

**Horizontal resolution** 37.79 dpc

**Vertical resolution** 37.79 dpc

## Namespaces

- [File](#)
- [Discussion](#)

## Variants

## Views

- [Read](#)
- [View source](#)
- [View history](#)

## More

- This page was last edited on 17 December 2016, at 17:51.

- [Privacy policy](#)
- [About Win-Test Wiki](#)
- [Disclaimers](#)

-  The logo consists of a small sun icon to the left of the text "Powered By MediaWiki".



# File:file-create-logfiles.gif

From Win-Test Wiki

[Jump to navigation](#) [Jump to search](#)

- [File](#)
- [File history](#)
- [File usage](#)

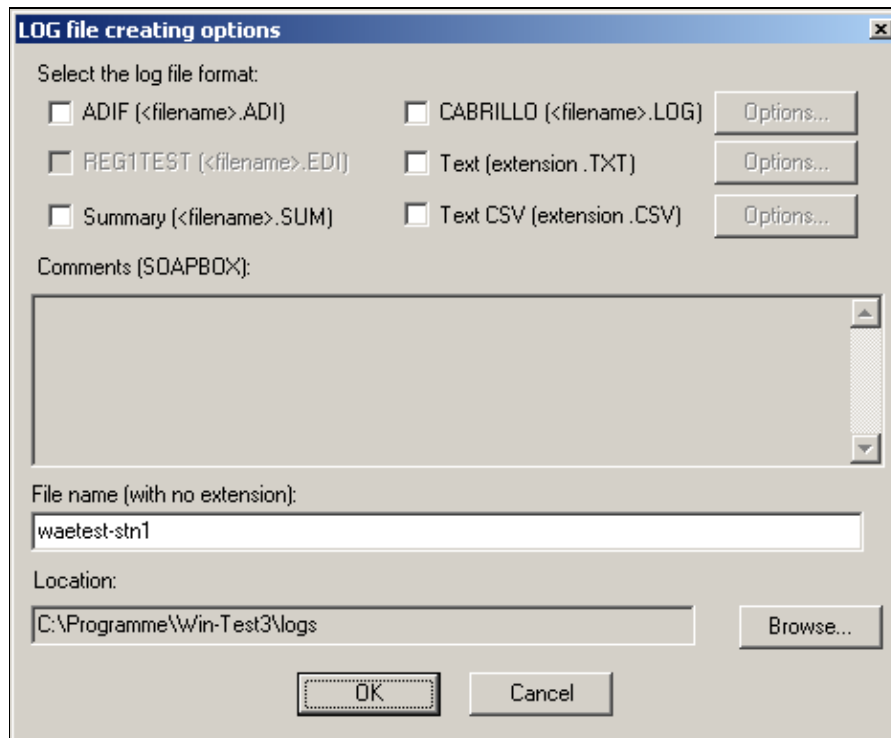

No higher resolution available.

[file-create-logfiles.gif](#) (467 × 384 pixels, file size: 7 KB, MIME type: image.gif)

## File history

Click on a date/time to view the file as it appeared at that time.

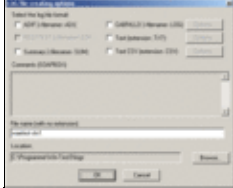
	Date/Time	Thumbnail	Dimensions	User	Comment
current	<a href="#">21:43, 25 July 2006</a>		467 × 384 (7 KB)	<a href="#">DL4NER</a> ( <a href="#">talk</a>   <a href="#">contribs</a> )	

You cannot overwrite this file.

## File usage

The following page uses this file:

- [Creating](#)

## Namespaces

- [File](#)
- [Discussion](#)

## Variants

## Views

- [Read](#)
- [View source](#)
- [View history](#)

## More

- This page was last edited on 25 July 2006, at 21:43.
- [Privacy policy](#)
- [About Win-Test Wiki](#)
- [Disclaimers](#)



# File:FileCreateLogFiles.PNG

From Win-Test Wiki

[Jump to navigation](#) [Jump to search](#)

- [File](#)
- [File history](#)
- [File usage](#)

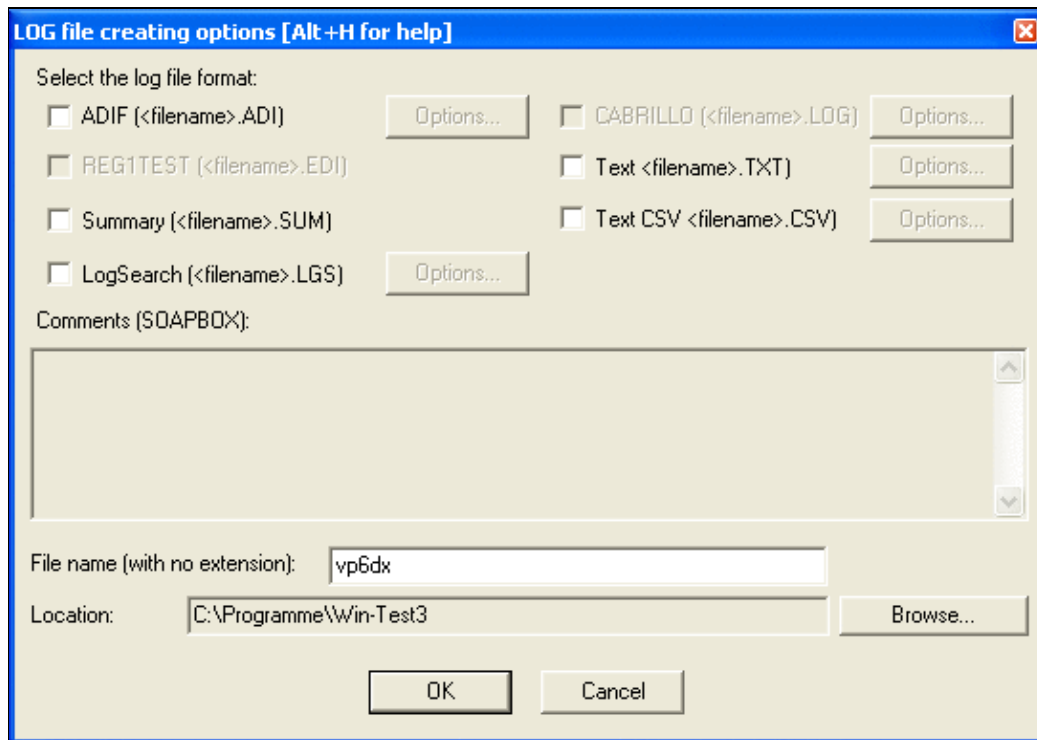

No higher resolution available.

FileCreateLogFiles.PNG (543 × 385 pixels, file size: 15 KB, MIME type: image.gif)

## File history

Click on a date/time to view the file as it appeared at that time.

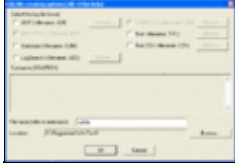
Date/Time	Thumbnail	Dimensions	User	Comment
current <a href="#">21:04, 3 June 2008</a>		543 × 385 (15 KB)	<a href="#">Dl6rai</a> ( <a href="#">talk</a>   <a href="#">contribs</a> )	

You cannot overwrite this file.

## File usage

The following 2 pages use this file:

- [Creating](#)
- [Menu:File open](#)

## Namespaces

- [File](#)
- [Discussion](#)

## Variants

## Views

- [Read](#)
- [View source](#)
- [View history](#)

## More

- This page was last edited on 3 June 2008, at 21:04.
- [Privacy policy](#)
- [About Win-Test Wiki](#)
- [Disclaimers](#)



# File:file-create-logfiles.gif

From Win-Test Wiki

[Jump to navigation](#) [Jump to search](#)

- [File](#)
- [File history](#)
- [File usage](#)

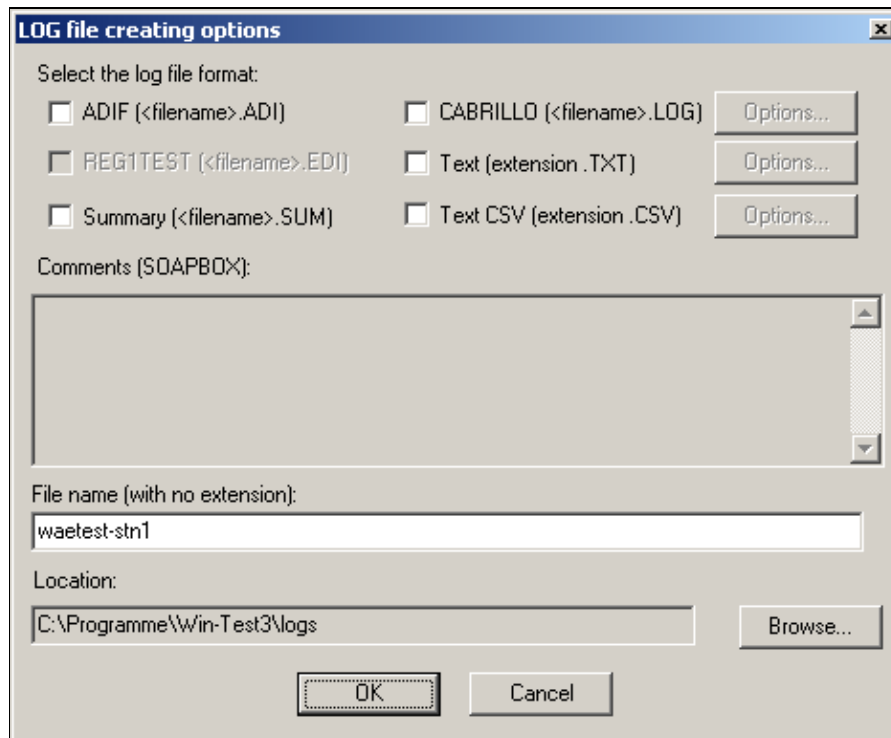

No higher resolution available.

[file-create-logfiles.gif](#) (467 × 384 pixels, file size: 7 KB, MIME type: image.gif)

## File history

Click on a date/time to view the file as it appeared at that time.

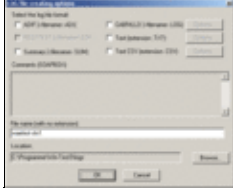
	Date/Time	Thumbnail	Dimensions	User	Comment
current	<a href="#">21:43, 25 July 2006</a>		467 × 384 (7 KB)	<a href="#">DL4NER</a> ( <a href="#">talk</a>   <a href="#">contribs</a> )	

You cannot overwrite this file.

## File usage

The following page uses this file:

- [Creating](#)

## Namespaces

- [File](#)
- [Discussion](#)

## Variants

## Views

- [Read](#)
- [View source](#)
- [View history](#)

## More

- This page was last edited on 25 July 2006, at 21:43.
- [Privacy policy](#)
- [About Win-Test Wiki](#)
- [Disclaimers](#)



# File:FileCreateLogFiles.PNG

From Win-Test Wiki

[Jump to navigation](#) [Jump to search](#)

- [File](#)
- [File history](#)
- [File usage](#)

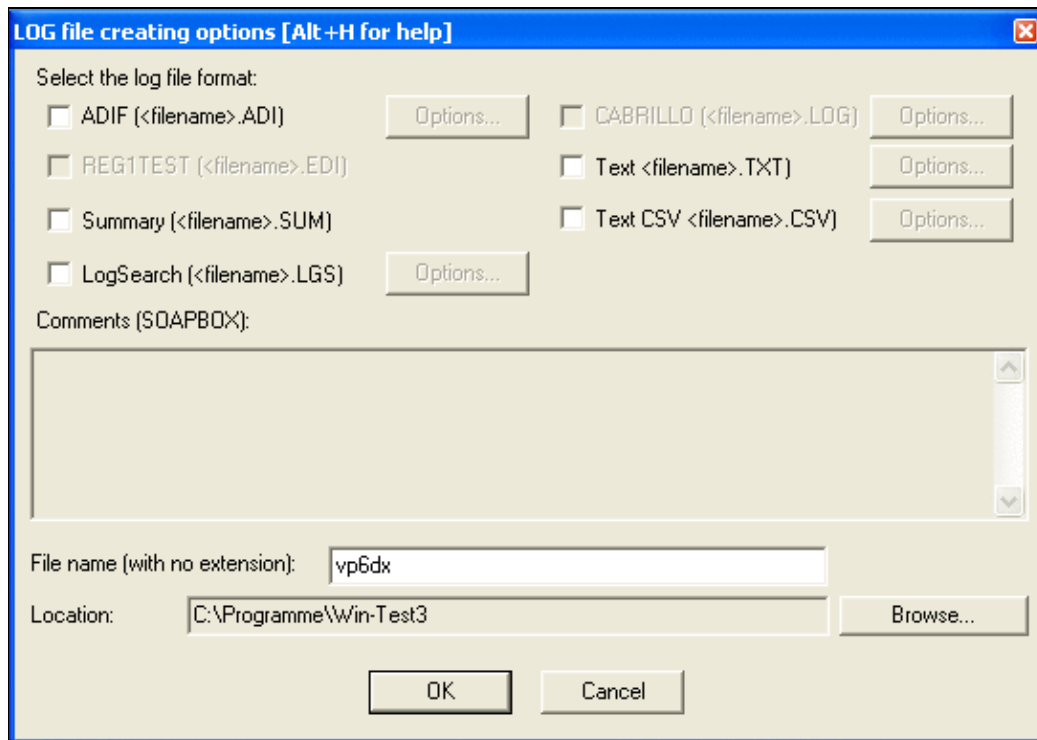

No higher resolution available.

[FileCreateLogFiles.PNG](#) (543 × 385 pixels, file size: 15 KB, MIME type: image.gif)

## File history

Click on a date/time to view the file as it appeared at that time.

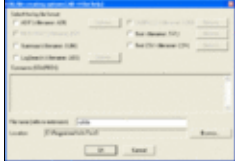
Date/Time	Thumbnail	Dimensions	User	Comment
current <a href="#">21:04, 3 June 2008</a>		543 × 385 (15 KB)	<a href="#">Dl6rai</a> ( <a href="#">talk</a>   <a href="#">contribs</a> )	

You cannot overwrite this file.

## File usage

The following 2 pages use this file:

- [Creating](#)
- [Menu:File open](#)

## Namespaces

- [File](#)
- [Discussion](#)

## Variants

## Views

- [Read](#)
- [View source](#)
- [View history](#)

## More

- This page was last edited on 3 June 2008, at 21:04.
- [Privacy policy](#)
- [About Win-Test Wiki](#)
- [Disclaimers](#)





# File:FileExplore.PNG

From Win-Test Wiki

[Jump to navigation](#) [Jump to search](#)

- [File](#)
- [File history](#)
- [File usage](#)

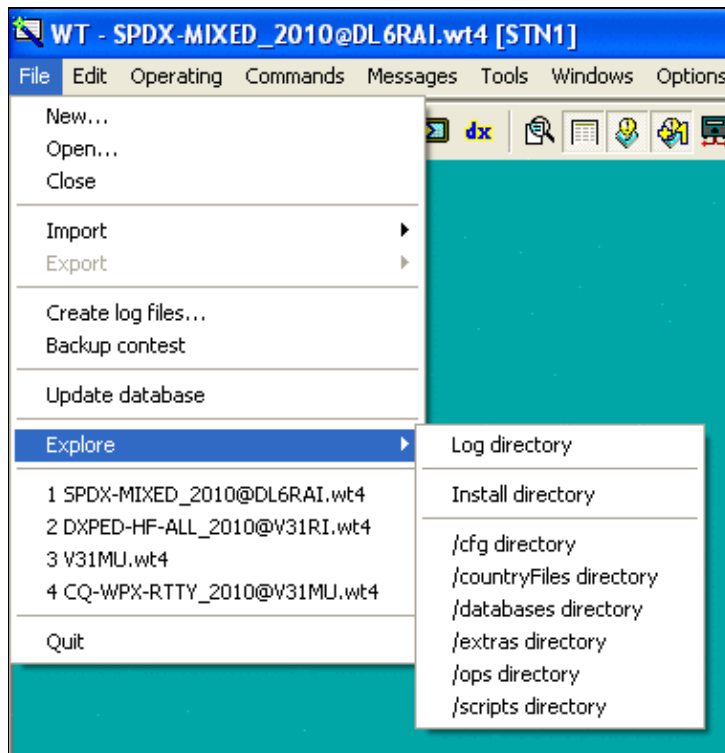

No higher resolution available.

[FileExplore.PNG](#) (379 × 392 pixels, file size: 14 KB, MIME type: image.gif)

## File history

Click on a date/time to view the file as it appeared at that time.

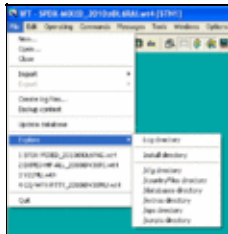
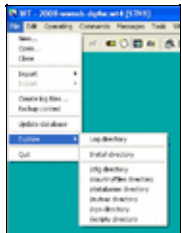
Date/Time	Thumbnail	Dimensions	User	Comment
<a href="#">current</a> <a href="#">07:05, 18 April 2010</a>		379 × 392 (14 KB)	<a href="#">Dl6rai</a> ( <a href="#">talk</a>   <a href="#">contribs</a> )	
<a href="#">17:38, 4 October 2009</a>		295 × 394 (11 KB)	<a href="#">Dl6rai</a> ( <a href="#">talk</a>   <a href="#">contribs</a> )	

You cannot overwrite this file.

## File usage

The following page uses this file:

- [Menu:File open](#)

## Namespaces

- [File](#)
- [Discussion](#)

## Variants

## Views

- [Read](#)
- [View source](#)
- [View history](#)

## More

- This page was last edited on 4 October 2009, at 17:38.
- [Privacy policy](#)
- [About Win-Test Wiki](#)

- Disclaimers



# File:FileExplore.PNG

From Win-Test Wiki

[Jump to navigation](#) [Jump to search](#)

- [File](#)
- [File history](#)
- [File usage](#)

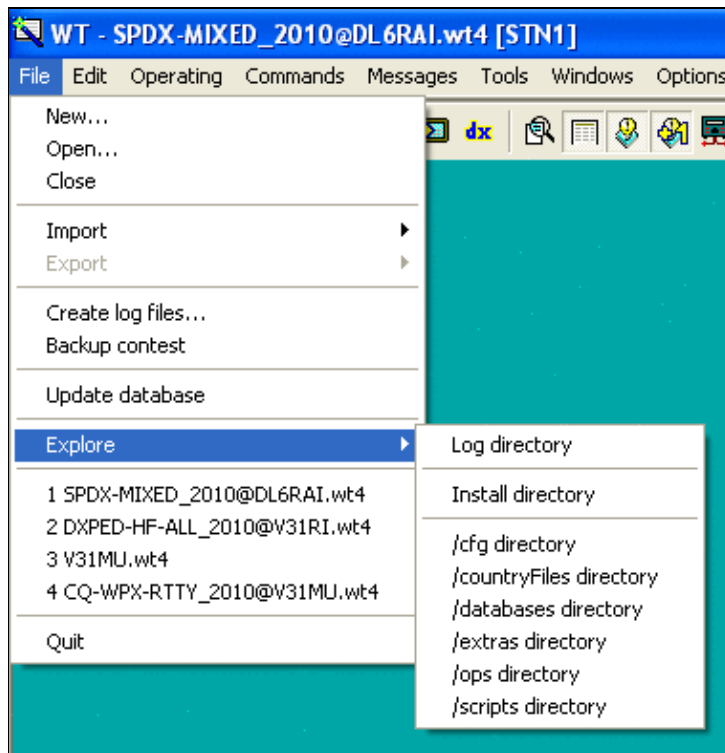

No higher resolution available.

[FileExplore.PNG](#) (379 × 392 pixels, file size: 14 KB, MIME type: image.gif)

## File history

Click on a date/time to view the file as it appeared at that time.

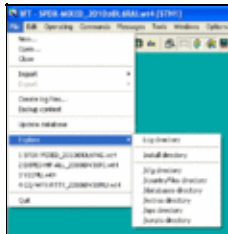
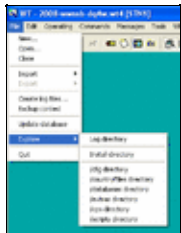
Date/Time	Thumbnail	Dimensions	User	Comment
current <a href="#">07:05, 18 April 2010</a>		379 × 392 (14 KB)	<a href="#">Dl6rai</a> ( <a href="#">talk</a>   <a href="#">contribs</a> )	
<a href="#">17:38, 4 October 2009</a>		295 × 394 (11 KB)	<a href="#">Dl6rai</a> ( <a href="#">talk</a>   <a href="#">contribs</a> )	

You cannot overwrite this file.

## File usage

The following page uses this file:

- [Menu:File open](#)

## Namespaces

- [File](#)
- [Discussion](#)

## Variants

## Views

- [Read](#)
- [View source](#)
- [View history](#)

## More

- This page was last edited on 4 October 2009, at 17:38.
- [Privacy policy](#)
- [About Win-Test Wiki](#)

- Disclaimers



# File:file-import-cabrillo.gif

From Win-Test Wiki

[Jump to navigation](#) [Jump to search](#)

- [File](#)
- [File history](#)
- [File usage](#)

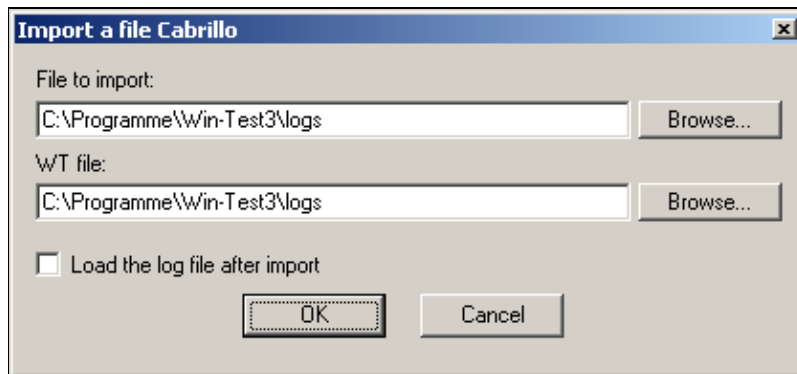

No higher resolution available.

[file-import-cabrillo.gif](#) (417 × 193 pixels, file size: 4 KB, MIME type: image.gif)

## File history

Click on a date/time to view the file as it appeared at that time.

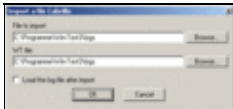
	Date/Time	Thumbnail	Dimensions	User	Comment
current	<a href="#">21:28, 25 July 2006</a>		417 × 193 (4 KB)	<a href="#">DL4NER</a> ( <a href="#">talk</a>   <a href="#">contribs</a> )	

You cannot overwrite this file.

## File usage

The following page uses this file:

- [Menu:File new](#)

## Namespaces

- [File](#)
- [Discussion](#)

## Variants

## Views

- [Read](#)
- [View source](#)
- [View history](#)

## More

- This page was last edited on 25 July 2006, at 21:28.

- [Privacy policy](#)
- [About Win-Test Wiki](#)
- [Disclaimers](#)





# File:file-import-cabrillo.gif

From Win-Test Wiki

[Jump to navigation](#) [Jump to search](#)

- [File](#)
- [File history](#)
- [File usage](#)

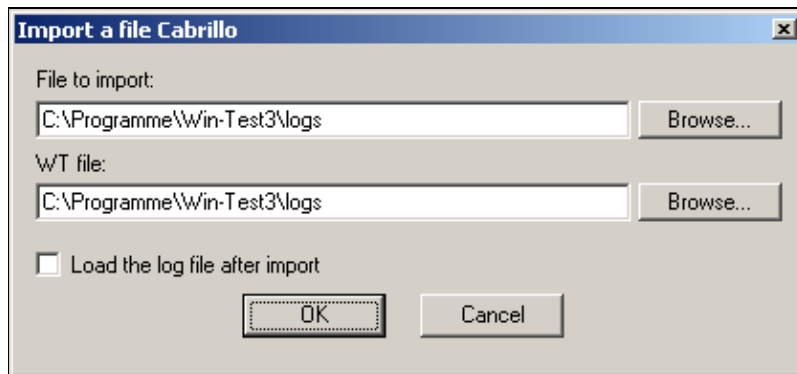

No higher resolution available.

[file-import-cabrillo.gif](#) (417 × 193 pixels, file size: 4 KB, MIME type: image.gif)

## File history

Click on a date/time to view the file as it appeared at that time.

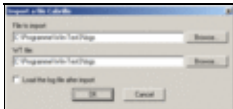
	Date/Time	Thumbnail	Dimensions	User	Comment
current	<a href="#">21:28, 25 July 2006</a>		417 × 193 (4 KB)	<a href="#">DL4NER</a> ( <a href="#">talk</a>   <a href="#">contribs</a> )	

You cannot overwrite this file.

## File usage

The following page uses this file:

- [Menu:File new](#)

## Namespaces

- [File](#)
- [Discussion](#)

## Variants

## Views

- [Read](#)
- [View source](#)
- [View history](#)

## More

- This page was last edited on 25 July 2006, at 21:28.

- [Privacy policy](#)
- [About Win-Test Wiki](#)
- [Disclaimers](#)



# File:file-import-editest.gif

From Win-Test Wiki

[Jump to navigation](#) [Jump to search](#)

- [File](#)
- [File history](#)
- [File usage](#)

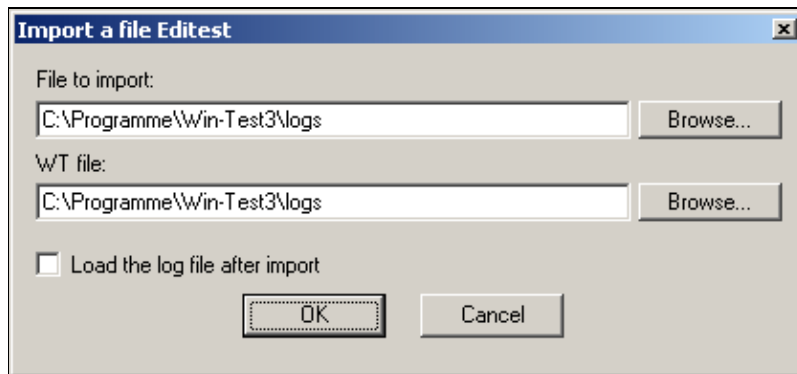

No higher resolution available.

[file-import-editest.gif](#) (417 Å 193 pixels, file size: 4 KB, MIME type: image.gif)

## File history

Click on a date/time to view the file as it appeared at that time.

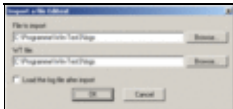
	Date/Time	Thumbnail	Dimensions	User	Comment
current	<a href="#">21:28, 25 July 2006</a>		417 Å 193 (4 KB)	<a href="#">DL4NER</a> ( <a href="#">talk</a>   <a href="#">contribs</a> )	

You cannot overwrite this file.

## File usage

The following page uses this file:

- [Menu:File new](#)

## Namespaces

- [File](#)
- [Discussion](#)

## Variants

## Views

- [Read](#)
- [View source](#)
- [View history](#)

## More

- This page was last edited on 25 July 2006, at 21:28.

- [Privacy policy](#)
- [About Win-Test Wiki](#)
- [Disclaimers](#)



# File:file-import-editest.gif

From Win-Test Wiki

[Jump to navigation](#) [Jump to search](#)

- [File](#)
- [File history](#)
- [File usage](#)

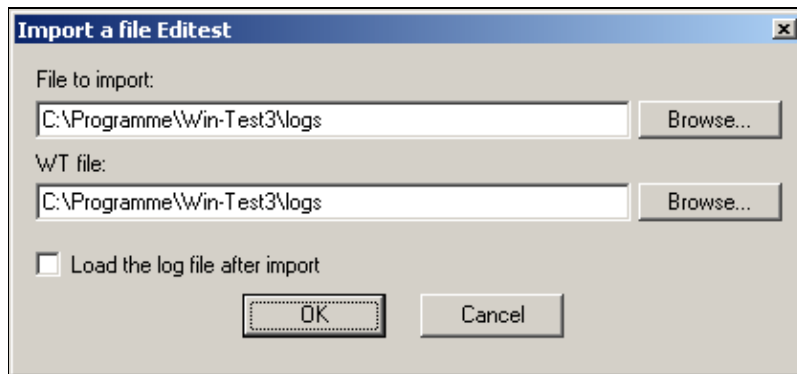

No higher resolution available.

[file-import-editest.gif](#) (417 Å 193 pixels, file size: 4 KB, MIME type: image.gif)

## File history

Click on a date/time to view the file as it appeared at that time.

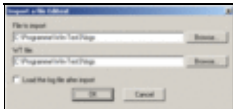
	Date/Time	Thumbnail	Dimensions	User	Comment
current	<a href="#">21:28, 25 July 2006</a>		417 Å 193 (4 KB)	<a href="#">DL4NER</a> ( <a href="#">talk</a>   <a href="#">contribs</a> )	

You cannot overwrite this file.

## File usage

The following page uses this file:

- [Menu:File new](#)

## Namespaces

- [File](#)
- [Discussion](#)

## Variants

## Views

- [Read](#)
- [View source](#)
- [View history](#)

## More

- This page was last edited on 25 July 2006, at 21:28.

- [Privacy policy](#)
- [About Win-Test Wiki](#)
- [Disclaimers](#)



# File:FileMRU.PNG

From Win-Test Wiki

[Jump to navigation](#) [Jump to search](#)

- [File](#)
- [File history](#)
- [File usage](#)



No higher resolution available.

[FileMRU.PNG](#) (225 × 88 pixels, file size: 2 KB, MIME type: image.gif)

## File history

Click on a date/time to view the file as it appeared at that time.

Date/Time	Thumbnail	Dimensions	User	Comment
current <a href="#">07:07, 18 April 2010</a>		225 × 88 (2 KB)	<a href="#">Dl6rai</a> ( <a href="#">talk</a>   <a href="#">contribs</a> )	

You cannot overwrite this file.

## File usage

The following page uses this file:

- [Menu:File open](#)

## Namespaces

- [File](#)
- [Discussion](#)

## Variants

## Views

- [Read](#)
- [View source](#)
- [View history](#)

## More

- This page was last edited on 18 April 2010, at 07:07.

- [Privacy policy](#)
- [About Win-Test Wiki](#)
- [Disclaimers](#)





# File:FileMRU.PNG

From Win-Test Wiki

[Jump to navigation](#) [Jump to search](#)

- [File](#)
- [File history](#)
- [File usage](#)



No higher resolution available.

[FileMRU.PNG](#) (225 × 88 pixels, file size: 2 KB, MIME type: image.gif)

## File history

Click on a date/time to view the file as it appeared at that time.

Date/Time	Thumbnail	Dimensions	User	Comment
current <a href="#">07:07, 18 April 2010</a>		225 × 88 (2 KB)	<a href="#">Dl6rai</a> ( <a href="#">talk</a>   <a href="#">contribs</a> )	

You cannot overwrite this file.

## File usage

The following page uses this file:

- [Menu:File open](#)

## Namespaces

- [File](#)
- [Discussion](#)

## Variants

## Views

- [Read](#)
- [View source](#)
- [View history](#)

## More

- This page was last edited on 18 April 2010, at 07:07.

- [Privacy policy](#)
- [About Win-Test Wiki](#)
- [Disclaimers](#)



# File:FileNew.gif

From Win-Test Wiki

[Jump to navigation](#) [Jump to search](#)

- [File](#)
- [File history](#)
- [File usage](#)

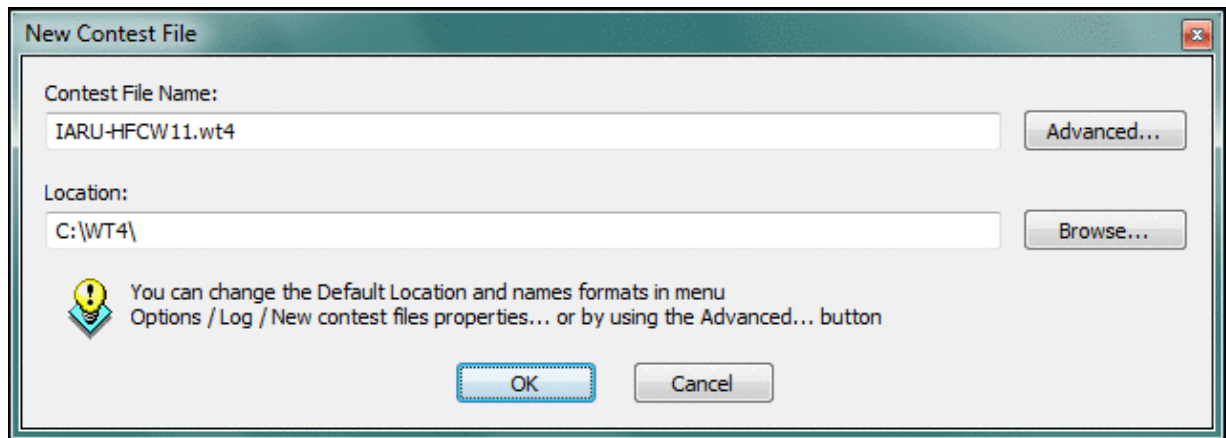



No higher resolution available.

[FileNew.gif](#) (636 × 226 pixels, file size: 26 KB, MIME type: image.gif)

Dialog displayed after selecting File | New and entering data on the contest configuration window.

## File history

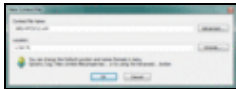
Click on a date/time to view the file as it appeared at that time.

	Date/Time	Thumbnail	Dimensions	User	Comment
current	<a href="#">22:55, 16 October 2011</a>		636 × 226 (26 KB)	<a href="#">N6TV (talk   contribs)</a>	Update to show IARU contest, for consistency with Contest Configuration window.
	<a href="#">22:54, 16 October 2011</a>		636 × 226 (23 KB)	<a href="#">N6TV (talk   contribs)</a>	Dialog displayed after selecting File   New and entering data on the contest configuration window.

You cannot overwrite this file.

## File usage

The following 2 pages use this file:

- [Menu:File new](#)

- [New Log](#)

## Namespaces

- [File](#)
- [Discussion](#)

## Variants

## Views

- [Read](#)
- [View source](#)
- [View history](#)

## More

- This page was last edited on 16 October 2011, at 22:55.

- [Privacy policy](#)
- [About Win-Test Wiki](#)
- [Disclaimers](#)



# File:FileNew.gif

From Win-Test Wiki

[Jump to navigation](#) [Jump to search](#)

- [File](#)
- [File history](#)
- [File usage](#)

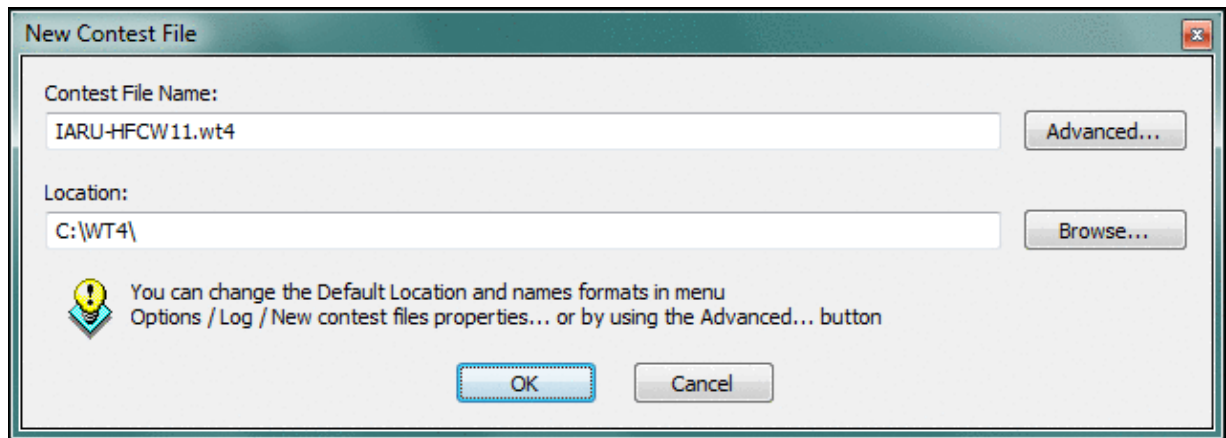



No higher resolution available.

[FileNew.gif](#) (636 × 226 pixels, file size: 26 KB, MIME type: image.gif)

Dialog displayed after selecting File | New and entering data on the contest configuration window.

## File history

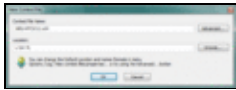
Click on a date/time to view the file as it appeared at that time.

	Date/Time	Thumbnail	Dimensions	User	Comment
current	<a href="#">22:55, 16 October 2011</a>		636 × 226 (26 KB)	<a href="#">N6TV (talk   contribs)</a>	Update to show IARU contest, for consistency with Contest Configuration window.
	<a href="#">22:54, 16 October 2011</a>		636 × 226 (23 KB)	<a href="#">N6TV (talk   contribs)</a>	Dialog displayed after selecting File   New and entering data on the contest configuration window.

You cannot overwrite this file.

## File usage

The following 2 pages use this file:

- [Menu:File new](#)

- [New Log](#)

## Namespaces

- [File](#)
- [Discussion](#)

## Variants

## Views

- [Read](#)
- [View source](#)
- [View history](#)

## More

- This page was last edited on 16 October 2011, at 22:55.

- [Privacy policy](#)
- [About Win-Test Wiki](#)
- [Disclaimers](#)



# File:FileOpen.gif

From Win-Test Wiki

[Jump to navigation](#) [Jump to search](#)

- [File](#)
- [File history](#)
- [File usage](#)

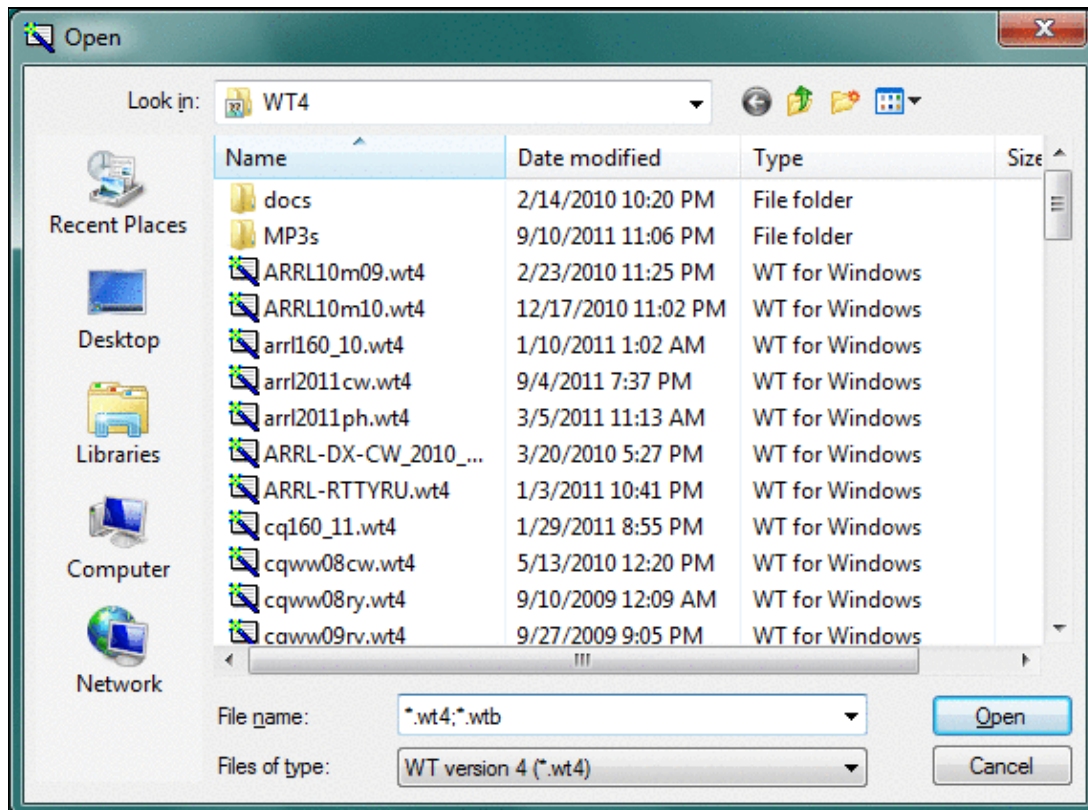

No higher resolution available.

[FileOpen.gif](#) (571 × 423 pixels, file size: 65 KB, MIME type: image.gif)

Win-Test 4 File Open Dialog (Windows 7)

## File history

Click on a date/time to view the file as it appeared at that time.

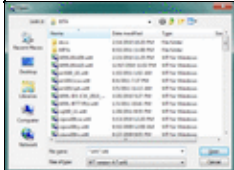
	Date/Time	Thumbnail	Dimensions	User	Comment
current	<a href="#">23:56, 16 October 2011</a>		571 × 423 (65 KB)	<a href="#">N6TV (talk   contribs)</a>	Win-Test 4 File Open Dialog (Windows 7)

You cannot overwrite this file.

## File usage

The following page uses this file:

- [Menu:File new](#)

## Namespaces

- [File](#)
- [Discussion](#)

## Variants

## Views

- [Read](#)
- [View source](#)
- [View history](#)

## More

- This page was last edited on 16 October 2011, at 23:56.

- [Privacy policy](#)
- [About Win-Test Wiki](#)
- [Disclaimers](#)





# File:FileOpen.gif

From Win-Test Wiki

[Jump to navigation](#) [Jump to search](#)

- [File](#)
- [File history](#)
- [File usage](#)

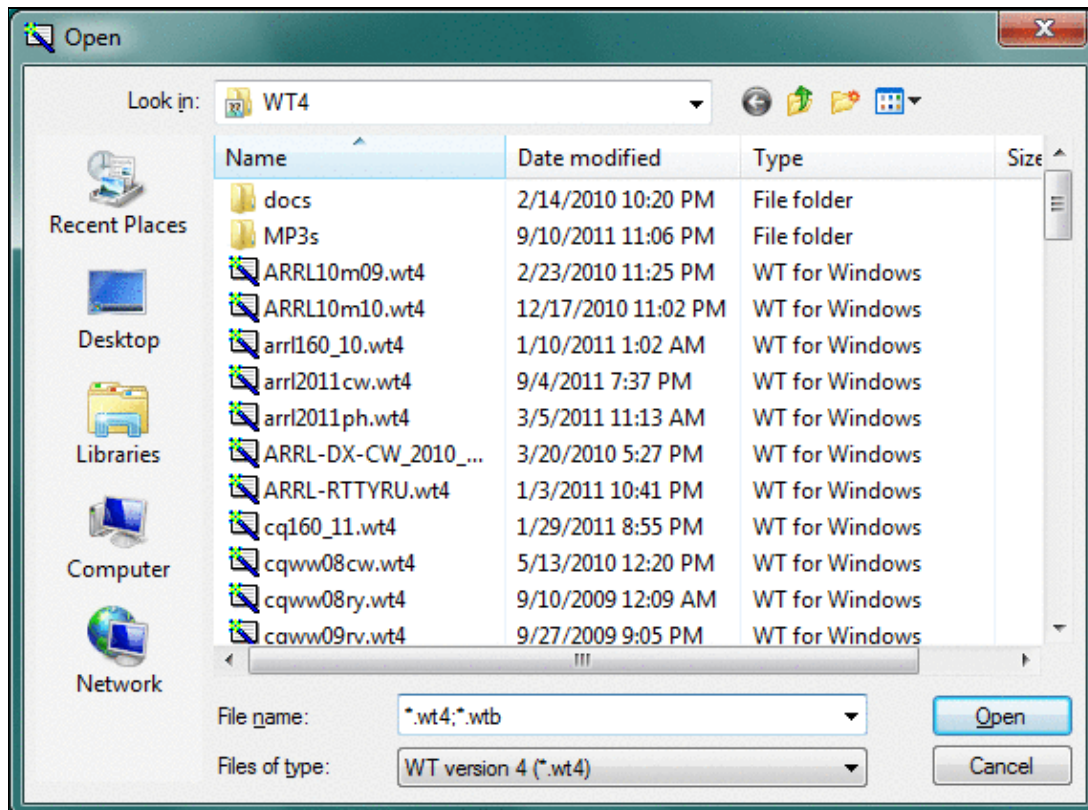

No higher resolution available.

[FileOpen.gif](#) (571 × 423 pixels, file size: 65 KB, MIME type: image.gif)

Win-Test 4 File Open Dialog (Windows 7)

## File history

Click on a date/time to view the file as it appeared at that time.

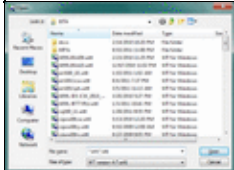
	Date/Time	Thumbnail	Dimensions	User	Comment
current	<a href="#">23:56, 16 October 2011</a>		571 × 423 (65 KB)	<a href="#">N6TV (talk   contribs)</a>	Win-Test 4 File Open Dialog (Windows 7)

You cannot overwrite this file.

## File usage

The following page uses this file:

- [Menu:File new](#)

## Namespaces

- [File](#)
- [Discussion](#)

## Variants

## Views

- [Read](#)
- [View source](#)
- [View history](#)

## More

- This page was last edited on 16 October 2011, at 23:56.

- [Privacy policy](#)
- [About Win-Test Wiki](#)
- [Disclaimers](#)



# File:FloatingWindows.gif

From Win-Test Wiki

[Jump to navigation](#) [Jump to search](#)

- [File](#)
- [File history](#)
- [File usage](#)

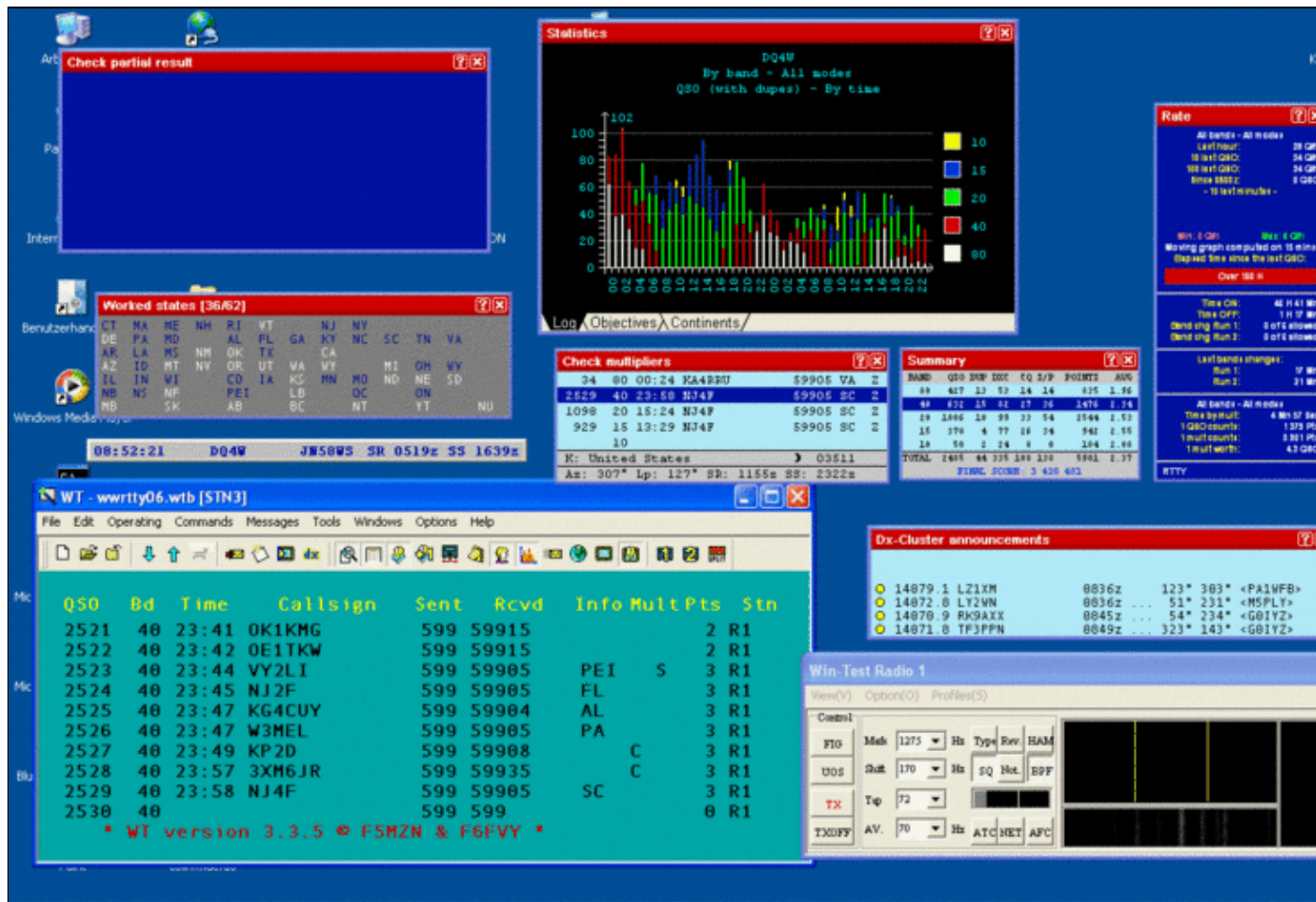

Size of this preview: [800 Å 500 pixels](#). Other resolutions: [320 Å 200 pixels](#) | [1,280 Å 800 pixels](#).  
[Original file](#) (1,280 Å 800 pixels, file size: 169 KB, MIME type: image/gif)

## File history

Click on a date/time to view the file as it appeared at that time.

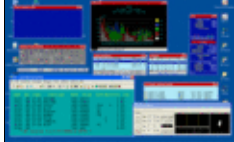
	Date/Time	Thumbnail	Dimensions	User	Comment
current	<a href="#">08:56, 7 October 2006</a>		1,280 Å 800 (169 KB)	<a href="#">Dl6rai</a> ( <a href="#">talk</a>   <a href="#">contribs</a> )	

You cannot overwrite this file.

## File usage

The following page uses this file:

- [Positioning Windows](#)

## Namespaces

- [File](#)
- [Discussion](#)

## Variants

## Views

- [Read](#)
- [View source](#)
- [View history](#)

## More

- This page was last edited on 7 October 2006, at 08:56.

- [Privacy policy](#)
- [About Win-Test Wiki](#)
- [Disclaimers](#)



# File:FloatingWindows.gif

From Win-Test Wiki

[Jump to navigation](#) [Jump to search](#)

- [File](#)
- [File history](#)
- [File usage](#)

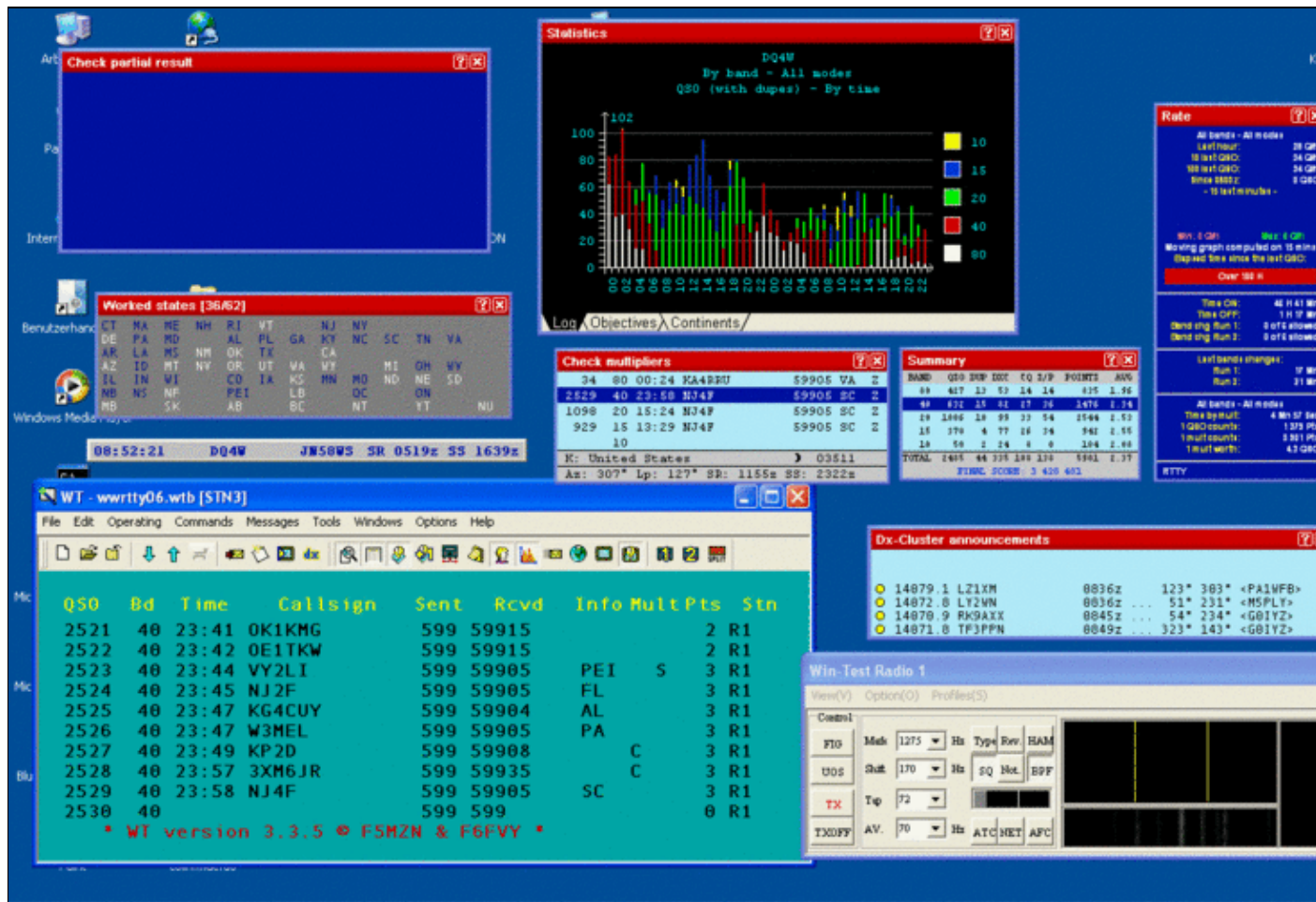

Size of this preview: [800 Å 500 pixels](#). Other resolutions: [320 Å 200 pixels](#) | [1,280 Å 800 pixels](#).  
[Original file](#) (1,280 Å 800 pixels, file size: 169 KB, MIME type: image/gif)

## File history

Click on a date/time to view the file as it appeared at that time.

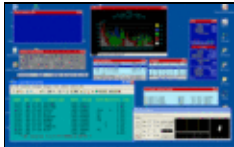
	Date/Time	Thumbnail	Dimensions	User	Comment
current	<a href="#">08:56, 7 October 2006</a>		1,280 Å 800 (169 KB)	<a href="#">Dl6rai</a> ( <a href="#">talk</a>   <a href="#">contribs</a> )	

You cannot overwrite this file.

## File usage

The following page uses this file:

- [Positioning Windows](#)

## Namespaces

- [File](#)
- [Discussion](#)

## Variants

## Views

- [Read](#)
- [View source](#)
- [View history](#)

## More

- This page was last edited on 7 October 2006, at 08:56.
- [Privacy policy](#)
- [About Win-Test Wiki](#)
- [Disclaimers](#)



# File:FT101DX CW-Setting Menu.gif

From Win-Test Wiki

[Jump to navigation](#) [Jump to search](#)

- [File](#)
- [File history](#)
- [File usage](#)
- [Metadata](#)



No higher resolution available.

[FT101DX\\_CW-Setting\\_Menu.gif](#) (800 × 480 pixels, file size: 29 KB, MIME type: image/gif)

## File history

Click on a date/time to view the file as it appeared at that time.

Date/Time	Thumbnail	Dimensions	User	Comment
current <u><a href="#">08:06, 6 June 2020</a></u>		800 × 480 (29 KB)	<u><a href="#">Dl6rai</a></u> ( <u><a href="#">talk</a></u>   <u><a href="#">contribs</a></u> )	

You cannot overwrite this file.

## File usage

The following page uses this file:

- [BestPractice7](#)

## Metadata

This file contains additional information, probably added from the digital camera or scanner used to create or digitize it.

If the file has been modified from its original state, some details may not fully reflect the modified file.

**Horizontal resolution** 37.79 dpc

**Vertical resolution** 37.79 dpc

## Namespaces

- [File](#)
- [Discussion](#)

## Variants

## Views

- [Read](#)
- [View source](#)
- [View history](#)

## More

- This page was last edited on 6 June 2020, at 08:06.
- [Privacy policy](#)



## Win-Test Wiki

- [About Win-Test Wiki](#)
- [Disclaimers](#)



# File:FT101DX CW-Setting Menu.gif

From Win-Test Wiki

[Jump to navigation](#) [Jump to search](#)

- [File](#)
- [File history](#)
- [File usage](#)
- [Metadata](#)



No higher resolution available.

[FT101DX\\_CW-Setting\\_Menu.gif](#) (800 × 480 pixels, file size: 29 KB, MIME type: image/gif)

## File history

Click on a date/time to view the file as it appeared at that time.

Date/Time	Thumbnail	Dimensions	User	Comment
current <u><a href="#">08:06, 6 June 2020</a></u>		800 × 480 (29 KB)	<u><a href="#">Dl6rai</a></u> ( <u><a href="#">talk</a></u>   <u><a href="#">contribs</a></u> )	

You cannot overwrite this file.

## File usage

The following page uses this file:

- [BestPractice7](#)

## Metadata

This file contains additional information, probably added from the digital camera or scanner used to create or digitize it.

If the file has been modified from its original state, some details may not fully reflect the modified file.

**Horizontal resolution** 37.79 dpc

**Vertical resolution** 37.79 dpc

## Namespaces

- [File](#)
- [Discussion](#)

## Variants

## Views

- [Read](#)
- [View source](#)
- [View history](#)

## More

- This page was last edited on 6 June 2020, at 08:06.
- [Privacy policy](#)

## Win-Test Wiki

- [About Win-Test Wiki](#)
- [Disclaimers](#)



# File:FT101DX General Menu.gif

From Win-Test Wiki

[Jump to navigation](#) [Jump to search](#)

- [File](#)
- [File history](#)
- [File usage](#)
- [Metadata](#)

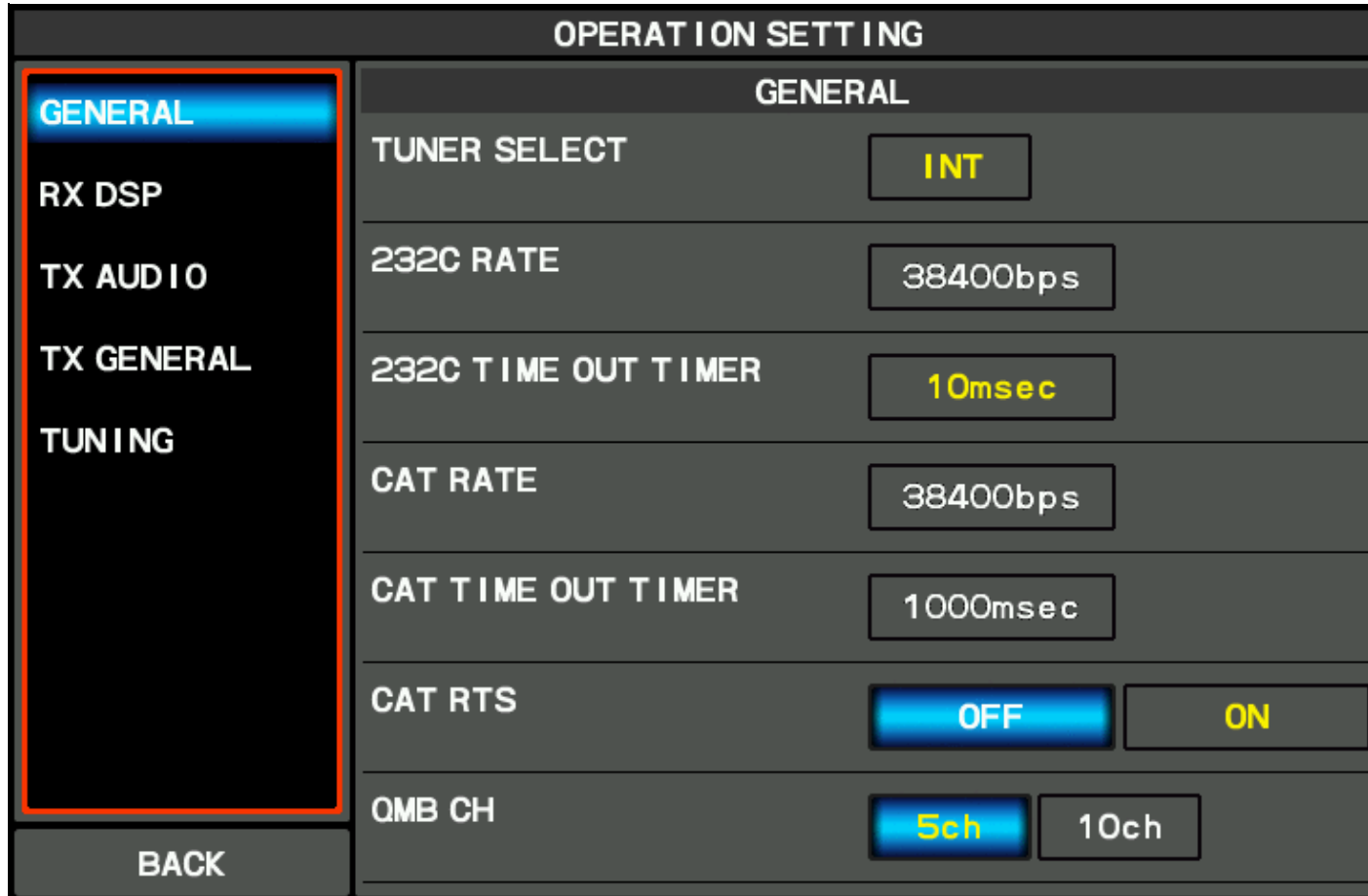

No higher resolution available.

FT101DX General Menu.gif (800 × 480 pixels, file size: 30 KB, MIME type: image.gif)

## File history

Click on a date/time to view the file as it appeared at that time.

Date/Time	Thumbnail	Dimensions	User	Comment
current <u>08:06, 6 June 2020</u>		800 × 480 (30 KB)	<u>DI6rai</u> ( <a href="#">talk</a>   <a href="#">contribs</a> )	

You cannot overwrite this file.

## File usage

The following page uses this file:

- BestPractice7

## Metadata

This file contains additional information, probably added from the digital camera or scanner used to create or digitize it.

If the file has been modified from its original state, some details may not fully reflect the modified file.

**Horizontal resolution** 37.79 dpc

**Vertical resolution** 37.79 dpc

## Namespaces

- File
- Discussion

## Variants

## Views

- Read
- View source
- View history

## More

- This page was last edited on 6 June 2020, at 08:06.
- Privacy policy

## Win-Test Wiki

- [About Win-Test Wiki](#)
- [Disclaimers](#)



# File:FT101DX General Menu.gif

From Win-Test Wiki

[Jump to navigation](#) [Jump to search](#)

- [File](#)
- [File history](#)
- [File usage](#)
- [Metadata](#)

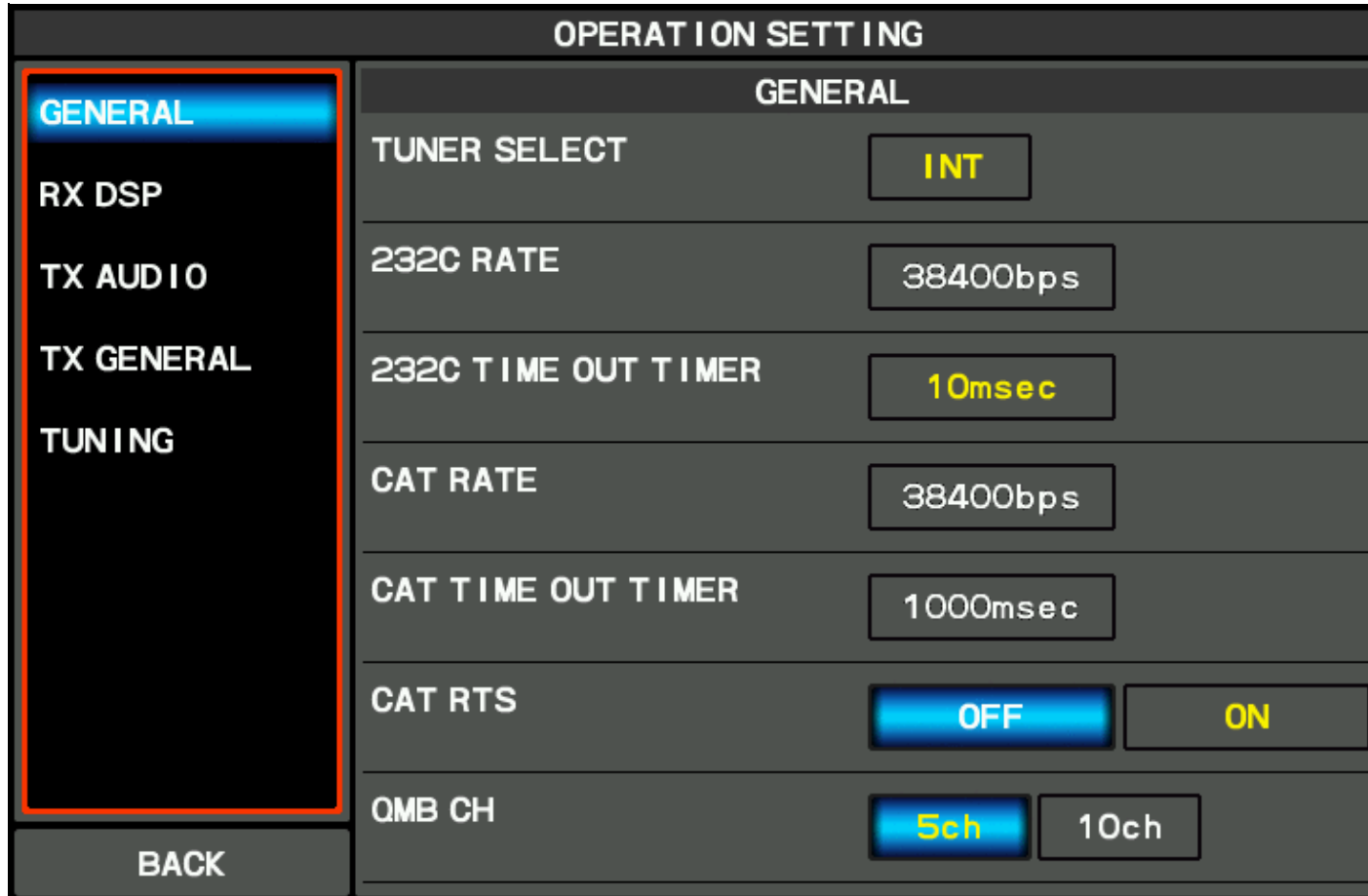



No higher resolution available.

FT101DX General Menu.gif (800 × 480 pixels, file size: 30 KB, MIME type: image.gif)

## File history

Click on a date/time to view the file as it appeared at that time.

Date/Time	Thumbnail	Dimensions	User	Comment
current <u>08:06, 6 June 2020</u>		800 × 480 (30 KB)	<u>DI6rai</u> ( <a href="#">talk</a>   <a href="#">contribs</a> )	

You cannot overwrite this file.

## File usage

The following page uses this file:

- BestPractice7

## Metadata

This file contains additional information, probably added from the digital camera or scanner used to create or digitize it.

If the file has been modified from its original state, some details may not fully reflect the modified file.

**Horizontal resolution** 37.79 dpc

**Vertical resolution** 37.79 dpc

## Namespaces

- File
- Discussion

## Variants

## Views

- Read
- View source
- View history

## More

- This page was last edited on 6 June 2020, at 08:06.
- Privacy policy

## Win-Test Wiki

- [About Win-Test Wiki](#)
- [Disclaimers](#)



# File:GabSend.gif

From Win-Test Wiki

[Jump to navigation](#) [Jump to search](#)

- [File](#)
- [File history](#)
- [File usage](#)



No higher resolution available.

[GabSend.gif](#) (525 × 43 pixels, file size: 3 KB, MIME type: image/gif)

Gab screenshot

## File history

Click on a date/time to view the file as it appeared at that time.

	Date/Time	Thumbnail	Dimensions	User	Comment
current	<a href="#">14:22, 5 January 2006</a>		525 × 43 (3 KB)	<a href="#">MOCLW</a> ( <a href="#">talk</a>   <a href="#">contribs</a> )	Gab screenshot

You cannot overwrite this file.

## File usage

The following page uses this file:

- [Multi-op/Gabbing](#)

## Namespaces

- [File](#)
- [Discussion](#)

## Variants

## Views

- [Read](#)
- [View source](#)
- [View history](#)

## More

- This page was last edited on 5 January 2006, at 14:22.

- [Privacy policy](#)
- [About Win-Test Wiki](#)
- [Disclaimers](#)



# File:GabSend.gif

From Win-Test Wiki

[Jump to navigation](#) [Jump to search](#)

- [File](#)
- [File history](#)
- [File usage](#)



No higher resolution available.

[GabSend.gif](#) (525 × 43 pixels, file size: 3 KB, MIME type: image.gif)

Gab screenshot

## File history

Click on a date/time to view the file as it appeared at that time.

	Date/Time	Thumbnail	Dimensions	User	Comment
current	<a href="#">14:22, 5 January 2006</a>		525 × 43 (3 KB)	<a href="#">MOCLW</a> ( <a href="#">talk</a>   <a href="#">contribs</a> )	Gab screenshot

You cannot overwrite this file.

## File usage

The following page uses this file:

- [Multi-op/Gabbing](#)

## Namespaces

- [File](#)
- [Discussion](#)

## Variants

## Views

- [Read](#)
- [View source](#)
- [View history](#)

## More

- This page was last edited on 5 January 2006, at 14:22.

- [Privacy policy](#)
- [About Win-Test Wiki](#)
- [Disclaimers](#)



# File:gab-sending.gif

From Win-Test Wiki

[Jump to navigation](#) [Jump to search](#)

- [File](#)
- [File history](#)
- [File usage](#)



No higher resolution available.

[gab-sending.gif](#) (525 × 42 pixels, file size: 2 KB, MIME type: image/gif)

## File history

Click on a date/time to view the file as it appeared at that time.

	Date/Time	Thumbnail	Dimensions	User	Comment
current	<a href="#">21:53, 26 July 2006</a>		525 × 42 (2 KB)	<a href="#">DL4NER</a> ( <a href="#">talk</a>   <a href="#">contribs</a> )	

You cannot overwrite this file.

## File usage

The following page uses this file:

- [Menu:Messages](#)

## Namespaces

- [File](#)
- [Discussion](#)

## Variants

## Views

- [Read](#)
- [View source](#)
- [View history](#)

## More

- This page was last edited on 26 July 2006, at 21:53.
- [Privacy policy](#)

- [About Win-Test Wiki](#)
- [Disclaimers](#)





# File:gab-sending.gif

From Win-Test Wiki

[Jump to navigation](#) [Jump to search](#)

- [File](#)
- [File history](#)
- [File usage](#)



No higher resolution available.

[gab-sending.gif](#) (525 × 42 pixels, file size: 2 KB, MIME type: image.gif)

## File history

Click on a date/time to view the file as it appeared at that time.

	Date/Time	Thumbnail	Dimensions	User	Comment
current	<a href="#">21:53, 26 July 2006</a>		525 × 42 (2 KB)	<a href="#">DL4NER</a> ( <a href="#">talk</a>   <a href="#">contribs</a> )	

You cannot overwrite this file.

## File usage

The following page uses this file:

- [Menu:Messages](#)

## Namespaces

- [File](#)
- [Discussion](#)

## Variants

## Views

- [Read](#)
- [View source](#)
- [View history](#)

## More

- This page was last edited on 26 July 2006, at 21:53.
- [Privacy policy](#)

## Win-Test Wiki

- [About Win-Test Wiki](#)
- [Disclaimers](#)



# File:gab-window.gif

From Win-Test Wiki

[Jump to navigation](#) [Jump to search](#)

- [File](#)
- [File history](#)
- [File usage](#)



No higher resolution available.

[gab-window.gif](#) (442 × 71 pixels, file size: 2 KB, MIME type: image/gif)

## File history

Click on a date/time to view the file as it appeared at that time.

Date/Time	Thumbnail	Dimensions	User	Comment
current <a href="#">21:53, 26 July 2006</a>		442 × 71 (2 KB)	<a href="#">DL4NER</a> ( <a href="#">talk</a>   <a href="#">contribs</a> )	

You cannot overwrite this file.

## File usage

The following page uses this file:

- [Menu:Messages](#)

## Namespaces

- [File](#)
- [Discussion](#)

## Variants

## Views

- [Read](#)
- [View source](#)
- [View history](#)

## More

- This page was last edited on 26 July 2006, at 21:53.

- [Privacy policy](#)
- [About Win-Test Wiki](#)
- [Disclaimers](#)



# File:gab-window.gif

From Win-Test Wiki

[Jump to navigation](#) [Jump to search](#)

- [File](#)
- [File history](#)
- [File usage](#)



No higher resolution available.

[gab-window.gif](#) (442 × 71 pixels, file size: 2 KB, MIME type: image/gif)

## File history

Click on a date/time to view the file as it appeared at that time.

Date/Time	Thumbnail	Dimensions	User	Comment
current <a href="#">21:53, 26 July 2006</a>		442 × 71 (2 KB)	<a href="#">DL4NER</a> ( <a href="#">talk</a>   <a href="#">contribs</a> )	

You cannot overwrite this file.

## File usage

The following page uses this file:

- [Menu:Messages](#)

## Namespaces

- [File](#)
- [Discussion](#)

## Variants

## Views

- [Read](#)
- [View source](#)
- [View history](#)

## More

- This page was last edited on 26 July 2006, at 21:53.

- [Privacy policy](#)
- [About Win-Test Wiki](#)
- [Disclaimers](#)



# File:GabWindowNoSyncClearLogNowSync.gif

From Win-Test Wiki

[Jump to navigation](#) [Jump to search](#)

- [File](#)
- [File history](#)
- [File usage](#)

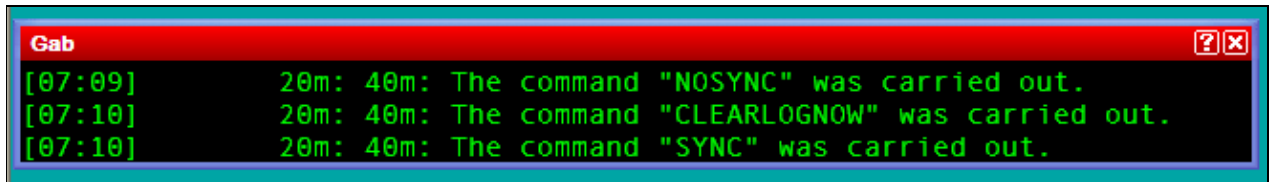

No higher resolution available.

[GabWindowNoSyncClearLogNowSync.gif](#) (659 × 93 pixels, file size: 8 KB, MIME type: image.gif)

Gab window messages confirming remote command execution.

## File history

Click on a date/time to view the file as it appeared at that time.

	Date/Time	Thumbnail	Dimensions	User	Comment
current	<a href="#">07:16, 23 November 2007</a>		659 × 93 (8 KB)	<a href="#">N6TV (talk   contribs)</a>	Gab window messages confirming remote command execution.

You cannot overwrite this file.

## File usage

The following page uses this file:

- [Multi-op/Clearing all logs before the start](#)

## Namespaces

- [File](#)
- [Discussion](#)

## Variants

## Views

- [Read](#)
- [View source](#)

- [View history](#)

## More

- This page was last edited on 23 November 2007, at 07:16.

- [Privacy policy](#)
- [About Win-Test Wiki](#)
- [Disclaimers](#)





# File:GabWindowNoSyncClearLogNowSync.gif

From Win-Test Wiki

[Jump to navigation](#) [Jump to search](#)

- [File](#)
- [File history](#)
- [File usage](#)

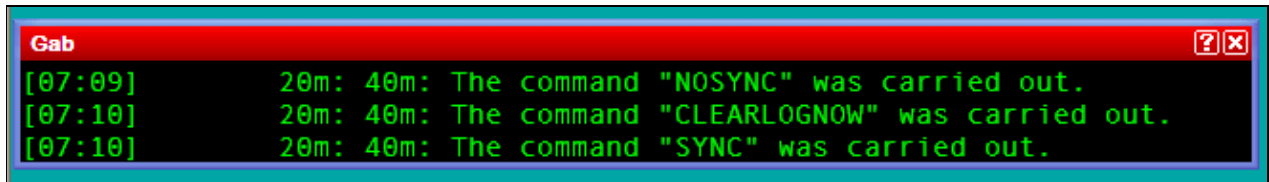

No higher resolution available.

[GabWindowNoSyncClearLogNowSync.gif](#) (659 × 93 pixels, file size: 8 KB, MIME type: image.gif)

Gab window messages confirming remote command execution.

## File history

Click on a date/time to view the file as it appeared at that time.

	Date/Time	Thumbnail	Dimensions	User	Comment
current	<a href="#">07:16, 23 November 2007</a>		659 × 93 (8 KB)	<a href="#">N6TV (talk   contribs)</a>	Gab window messages confirming remote command execution.

You cannot overwrite this file.

## File usage

The following page uses this file:

- [Multi-op/Clearing all logs before the start](#)

## Namespaces

- [File](#)
- [Discussion](#)

## Variants

## Views

- [Read](#)
- [View source](#)

- [View history](#)

## More

- This page was last edited on 23 November 2007, at 07:16.

- [Privacy policy](#)
- [About Win-Test Wiki](#)
- [Disclaimers](#)



# File:gotoCallsign.gif

From Win-Test Wiki

[Jump to navigation](#) [Jump to search](#)

- [File](#)
- [File history](#)
- [File usage](#)
- [Metadata](#)

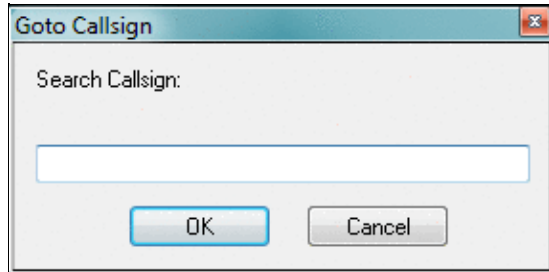

No higher resolution available.

[gotoCallsign.gif](#) (285 × 141 pixels, file size: 7 KB, MIME type: image/gif)

## File history

Click on a date/time to view the file as it appeared at that time.

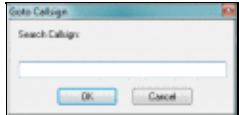
	Date/Time	Thumbnail	Dimensions	User	Comment
current	<a href="#">13:41, 17 December 2016</a>		285 × 141 (7 KB)	<a href="#">Dl6rai</a> ( <a href="#">talk</a>   <a href="#">contribs</a> )	

You cannot overwrite this file.

## File usage

The following page uses this file:

- [Menu:Edit](#)

## Metadata

This file contains additional information, probably added from the digital camera or scanner used to create or digitize it.

If the file has been modified from its original state, some details may not fully reflect the modified file.

**Horizontal resolution** 37.79 dpc

**Vertical resolution** 37.79 dpc

**Horizontal resolution** 37.79 dpc

## Namespaces

- [File](#)
- [Discussion](#)

## Variants

## Views

- [Read](#)
- [View source](#)
- [View history](#)

## More

- This page was last edited on 17 December 2016, at 13:41.

- [Privacy policy](#)
- [About Win-Test Wiki](#)
- [Disclaimers](#)



# File:gotoCallsign.gif

From Win-Test Wiki

[Jump to navigation](#) [Jump to search](#)

- [File](#)
- [File history](#)
- [File usage](#)
- [Metadata](#)

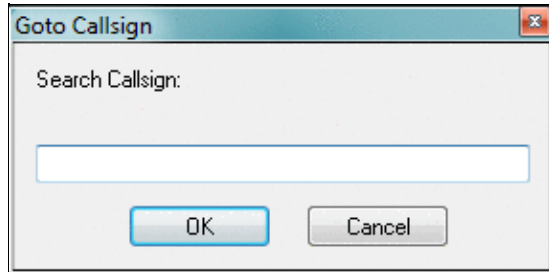

No higher resolution available.

[gotoCallsign.gif](#) (285 × 141 pixels, file size: 7 KB, MIME type: image.gif)

## File history

Click on a date/time to view the file as it appeared at that time.

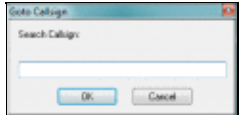
	Date/Time	Thumbnail	Dimensions	User	Comment
current	<a href="#">13:41, 17 December 2016</a>		285 × 141 (7 KB)	<a href="#">Dl6rai</a> ( <a href="#">talk</a>   <a href="#">contribs</a> )	

You cannot overwrite this file.

## File usage

The following page uses this file:

- [Menu:Edit](#)

## Metadata

This file contains additional information, probably added from the digital camera or scanner used to create or digitize it.

If the file has been modified from its original state, some details may not fully reflect the modified file.

**Horizontal resolution** 37.79 dpc

**Vertical resolution** 37.79 dpc

**Horizontal resolution** 37.79 dpc

## Namespaces

- [File](#)
- [Discussion](#)

## Variants

## Views

- [Read](#)
- [View source](#)
- [View history](#)

## More

- This page was last edited on 17 December 2016, at 13:41.
- [Privacy policy](#)
- [About Win-Test Wiki](#)
- [Disclaimers](#)



# File:gotoQSO.gif

From Win-Test Wiki

[Jump to navigation](#) [Jump to search](#)

- [File](#)
- [File history](#)
- [File usage](#)

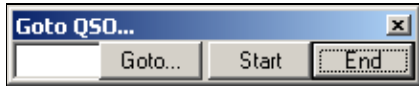

No higher resolution available.

[gotoQSO.gif](#) (216 × 42 pixels, file size: 2 KB, MIME type: image.gif)

## File history

Click on a date/time to view the file as it appeared at that time.

	Date/Time	Thumbnail	Dimensions	User	Comment
current	<a href="#">20:50, 27 July 2006</a>		216 × 42 (2 KB)	<a href="#">DL4NER</a> ( <a href="#">talk</a>   <a href="#">contribs</a> )	

You cannot overwrite this file.

## File usage

The following page uses this file:

- [Menu:Edit](#)

## Namespaces

- [File](#)
- [Discussion](#)

## Variants

## Views

- [Read](#)
- [View source](#)
- [View history](#)

## More

- This page was last edited on 27 July 2006, at 20:50.
- [Privacy policy](#)

## Win-Test Wiki

- [About Win-Test Wiki](#)
- [Disclaimers](#)





# File:gotoQSO.gif

From Win-Test Wiki

[Jump to navigation](#) [Jump to search](#)

- [File](#)
- [File history](#)
- [File usage](#)

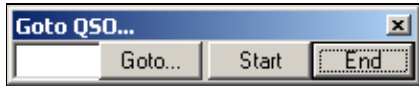

No higher resolution available.

[gotoQSO.gif](#) (216 × 42 pixels, file size: 2 KB, MIME type: image/gif)

## File history

Click on a date/time to view the file as it appeared at that time.

	Date/Time	Thumbnail	Dimensions	User	Comment
current	<a href="#">20:50, 27 July 2006</a>		216 × 42 (2 KB)	<a href="#">DL4NER</a> ( <a href="#">talk</a>   <a href="#">contribs</a> )	

You cannot overwrite this file.

## File usage

The following page uses this file:

- [Menu:Edit](#)

## Namespaces

- [File](#)
- [Discussion](#)

## Variants

## Views

- [Read](#)
- [View source](#)
- [View history](#)

## More

- This page was last edited on 27 July 2006, at 20:50.
- [Privacy policy](#)

## Win-Test Wiki

- [About Win-Test Wiki](#)
- [Disclaimers](#)



# File:GridSquareMapPopUp.PNG

From Win-Test Wiki

[Jump to navigation](#) [Jump to search](#)

- [File](#)
- [File history](#)
- [File usage](#)

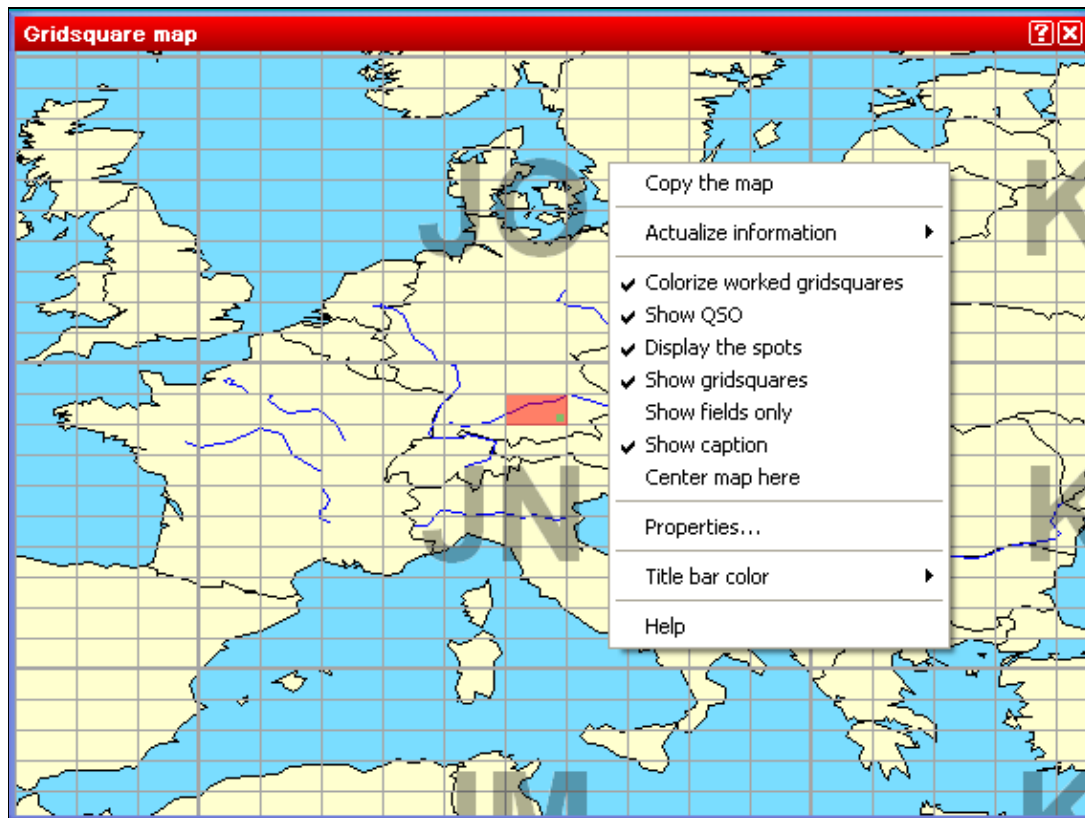



No higher resolution available.

[GridSquareMapPopUp.PNG](#) (567 × 426 pixels, file size: 30 KB, MIME type: image.gif)

Grid square map pop-up window

## File history

Click on a date/time to view the file as it appeared at that time.

	Date/Time	Thumbnail	Dimensions	User	Comment
current	<a href="#">08:55, 18 April 2010</a>		567 × 426 (30 KB)	<a href="#">Dl6rai</a> ( <a href="#">talk</a>   <a href="#">contribs</a> )	
	<a href="#">00:03, 19 December 2009</a>		376 × 275 (15 KB)	<a href="#">N6TV</a> ( <a href="#">talk</a>   <a href="#">contribs</a> )	Grid square map pop-up window

You cannot overwrite this file.

## File usage

The following page uses this file:

- [Menu:Windows](#)

## Namespaces

- [File](#)
- [Discussion](#)

## Variants

## Views

- [Read](#)
- [View source](#)
- [View history](#)

## More

- This page was last edited on 19 December 2009, at 00:03.
- [Privacy policy](#)
- [About Win-Test Wiki](#)
- [Disclaimers](#)



# File:GridSquareMapPopUp.PNG

From Win-Test Wiki

[Jump to navigation](#) [Jump to search](#)

- [File](#)
- [File history](#)
- [File usage](#)

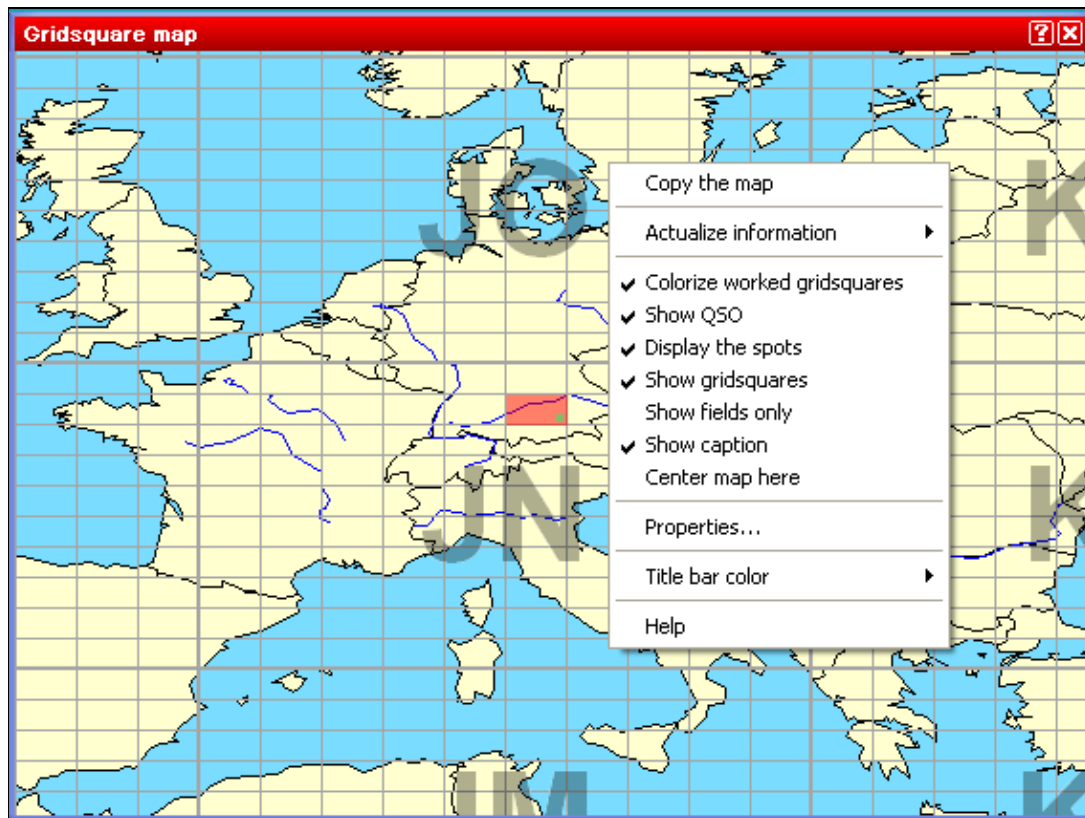



No higher resolution available.

[GridSquareMapPopUp.PNG](#) (567 × 426 pixels, file size: 30 KB, MIME type: image.gif)

Grid square map pop-up window

## File history

Click on a date/time to view the file as it appeared at that time.

	Date/Time	Thumbnail	Dimensions	User	Comment
current	<a href="#">08:55, 18 April 2010</a>		567 × 426 (30 KB)	<a href="#">Dl6rai</a> ( <a href="#">talk</a>   <a href="#">contribs</a> )	
	<a href="#">00:03, 19 December 2009</a>		376 × 275 (15 KB)	<a href="#">N6TV</a> ( <a href="#">talk</a>   <a href="#">contribs</a> )	Grid square map pop-up window

You cannot overwrite this file.

## File usage

The following page uses this file:

- [Menu:Windows](#)

## Namespaces

- [File](#)
- [Discussion](#)

## Variants

## Views

- [Read](#)
- [View source](#)
- [View history](#)

## More

- This page was last edited on 19 December 2009, at 00:03.
- [Privacy policy](#)
- [About Win-Test Wiki](#)
- [Disclaimers](#)





# File:GridSquareMapProperties.PNG

From Win-Test Wiki

[Jump to navigation](#) [Jump to search](#)

- [File](#)
- [File history](#)
- [File usage](#)

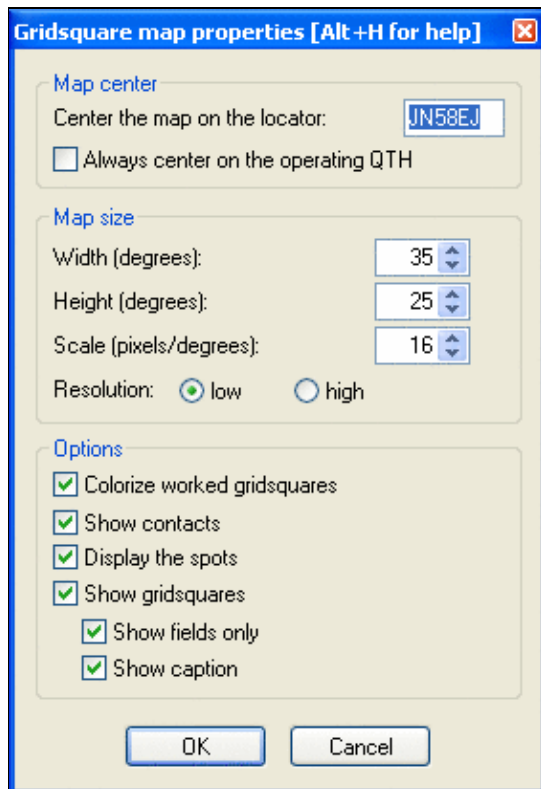



No higher resolution available.

[GridSquareMapProperties.PNG](#) (281 × 411 pixels, file size: 13 KB, MIME type: image.gif)

Grid square map properties (English version)

## File history

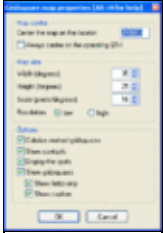
Click on a date/time to view the file as it appeared at that time.

	Date/Time	Thumbnail	Dimensions	User	Comment
current	<u><a href="#">09:06, 18 April 2010</a></u>		281 × 411 (13 KB)	<u><a href="#">Dl6rai</a></u> ( <u><a href="#">talk</a></u>   <u><a href="#">contribs</a></u> )	
	<u><a href="#">00:04, 19 December 2009</a></u>		281 × 386 (10 KB)	<u><a href="#">N6TV</a></u> ( <u><a href="#">talk</a></u>   <u><a href="#">contribs</a></u> )	Grid square map properties (English version)

You cannot overwrite this file.

## File usage

The following page uses this file:

- [Menu:Windows](#)

## Namespaces

- [File](#)
- [Discussion](#)

## Variants

## Views

- [Read](#)
- [View source](#)
- [View history](#)

## More

- This page was last edited on 19 December 2009, at 00:04.

## Win-Test Wiki

- [Privacy policy](#)
- [About Win-Test Wiki](#)
- [Disclaimers](#)



# File:GridSquareMapProperties.PNG

From Win-Test Wiki

[Jump to navigation](#) [Jump to search](#)

- [File](#)
- [File history](#)
- [File usage](#)

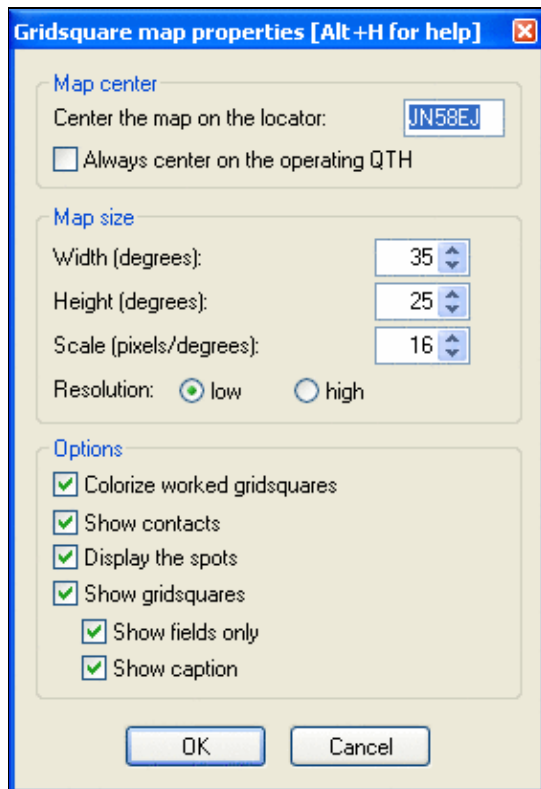



No higher resolution available.

[GridSquareMapProperties.PNG](#) (281 × 411 pixels, file size: 13 KB, MIME type: image.gif)

Grid square map properties (English version)

## File history

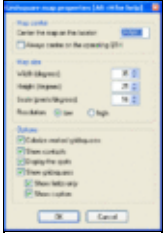
Click on a date/time to view the file as it appeared at that time.

	Date/Time	Thumbnail	Dimensions	User	Comment
current	<u><a href="#">09:06, 18 April 2010</a></u>		281 × 411 (13 KB)	<u><a href="#">Dl6rai</a></u> ( <u><a href="#">talk</a></u>   <u><a href="#">contribs</a></u> )	
	<u><a href="#">00:04, 19 December 2009</a></u>		281 × 386 (10 KB)	<u><a href="#">N6TV</a></u> ( <u><a href="#">talk</a></u>   <u><a href="#">contribs</a></u> )	Grid square map properties (English version)

You cannot overwrite this file.

## File usage

The following page uses this file:

- [Menu:Windows](#)

## Namespaces

- [File](#)
- [Discussion](#)

## Variants

## Views

- [Read](#)
- [View source](#)
- [View history](#)

## More

- This page was last edited on 19 December 2009, at 00:04.

## Win-Test Wiki

- [Privacy policy](#)
- [About Win-Test Wiki](#)
- [Disclaimers](#)



# File:HamCapAnt.gif

From Win-Test Wiki

[Jump to navigation](#) [Jump to search](#)

- [File](#)
- [File history](#)
- [File usage](#)

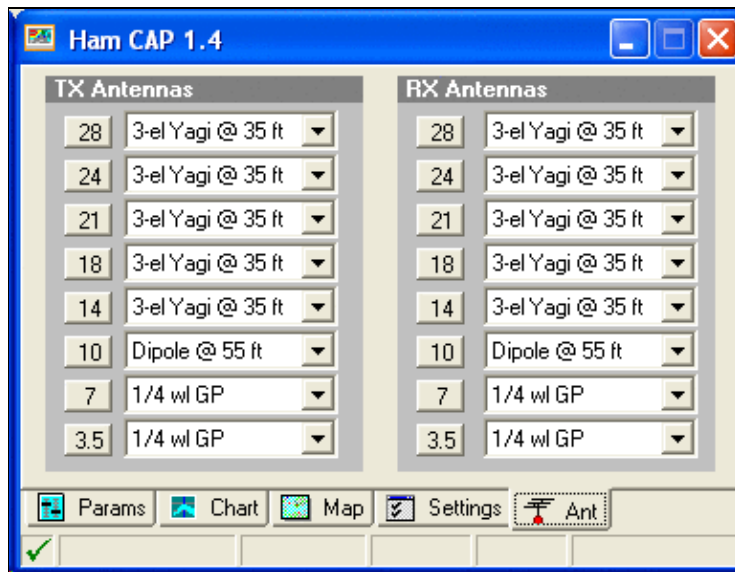

No higher resolution available.

[HamCapAnt.gif](#) (383 × 295 pixels, file size: 20 KB, MIME type: image/gif)

## File history

Click on a date/time to view the file as it appeared at that time.

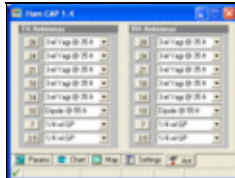
Date/Time	Thumbnail	Dimensions	User	Comment
current <a href="#">13:49, 10 August 2006</a>		383 × 295 (20 KB)	<a href="#">I2WIJ</a> ( <a href="#">talk</a>   <a href="#">contribs</a> )	

You cannot overwrite this file.

## File usage

The following page uses this file:

- [HamCAP](#)

## Namespaces

- [File](#)
- [Discussion](#)

## Variants

## Views

- [Read](#)
- [View source](#)
- [View history](#)

## More

- This page was last edited on 10 August 2006, at 13:49.
- [Privacy policy](#)
- [About Win-Test Wiki](#)
- [Disclaimers](#)





# File:HamCapAnt.gif

From Win-Test Wiki

[Jump to navigation](#) [Jump to search](#)

- [File](#)
- [File history](#)
- [File usage](#)

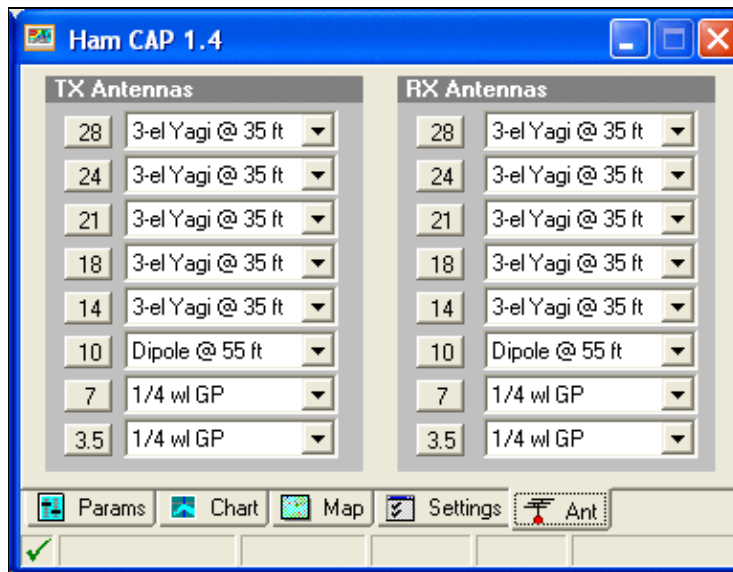

No higher resolution available.

[HamCapAnt.gif](#) (383 × 295 pixels, file size: 20 KB, MIME type: image/gif)

## File history

Click on a date/time to view the file as it appeared at that time.

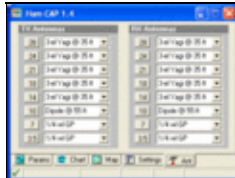
Date/Time	Thumbnail	Dimensions	User	Comment
current <a href="#">13:49, 10 August 2006</a>		383 × 295 (20 KB)	<a href="#">I2WIJ</a> ( <a href="#">talk</a>   <a href="#">contribs</a> )	

You cannot overwrite this file.

## File usage

The following page uses this file:

- [HamCAP](#)

## Namespaces

- [File](#)
- [Discussion](#)

## Variants

## Views

- [Read](#)
- [View source](#)
- [View history](#)

## More

- This page was last edited on 10 August 2006, at 13:49.
- [Privacy policy](#)
- [About Win-Test Wiki](#)
- [Disclaimers](#)



# File:HamCapChart.gif

From Win-Test Wiki

[Jump to navigation](#) [Jump to search](#)

- [File](#)
- [File history](#)
- [File usage](#)

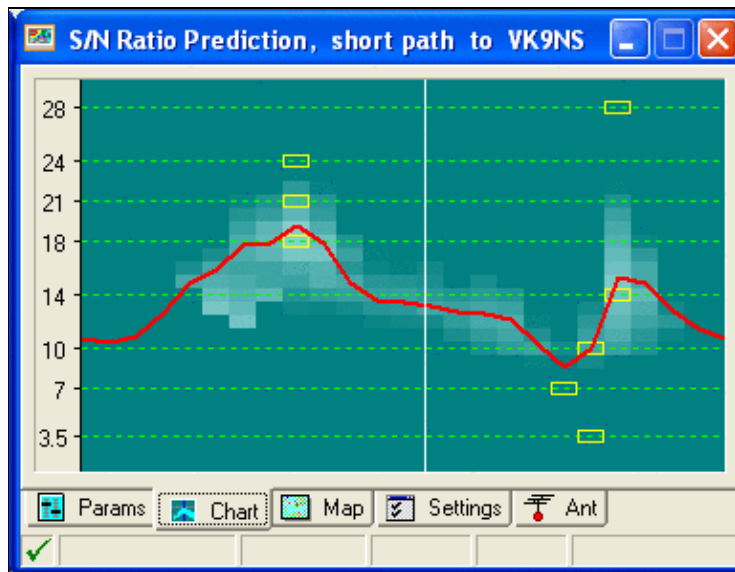

No higher resolution available.

[HamCapChart.gif](#) (383 × 295 pixels, file size: 18 KB, MIME type: image.gif)

## File history

Click on a date/time to view the file as it appeared at that time.

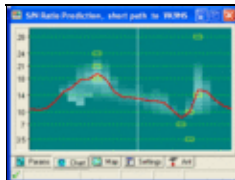
Date/Time	Thumbnail	Dimensions	User	Comment
current <a href="#">13:49, 10 August 2006</a>		383 × 295 (18 KB)	<a href="#">I2WIJ</a> ( <a href="#">talk</a>   <a href="#">contribs</a> )	

You cannot overwrite this file.

## File usage

The following page uses this file:

- [Menu:Commands](#)

## Namespaces

- [File](#)
- [Discussion](#)

## Variants

## Views

- [Read](#)
- [View source](#)
- [View history](#)

## More

- This page was last edited on 10 August 2006, at 13:49.
- [Privacy policy](#)
- [About Win-Test Wiki](#)
- [Disclaimers](#)



# File:HamCapChart.gif

From Win-Test Wiki

[Jump to navigation](#) [Jump to search](#)

- [File](#)
- [File history](#)
- [File usage](#)

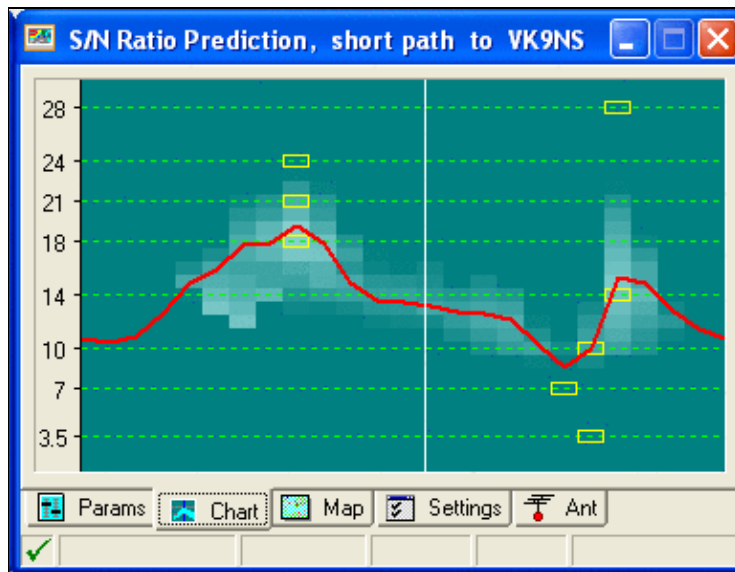

No higher resolution available.

[HamCapChart.gif](#) (383 × 295 pixels, file size: 18 KB, MIME type: image.gif)

## File history

Click on a date/time to view the file as it appeared at that time.

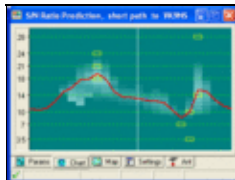
Date/Time	Thumbnail	Dimensions	User	Comment
current <a href="#">13:49, 10 August 2006</a>		383 × 295 (18 KB)	<a href="#">I2WIJ</a> ( <a href="#">talk</a>   <a href="#">contribs</a> )	

You cannot overwrite this file.

## File usage

The following page uses this file:

- [Menu:Commands](#)

## Namespaces

- [File](#)
- [Discussion](#)

## Variants

## Views

- [Read](#)
- [View source](#)
- [View history](#)

## More

- This page was last edited on 10 August 2006, at 13:49.
- [Privacy policy](#)
- [About Win-Test Wiki](#)
- [Disclaimers](#)



# File:HamCapForeground.gif

From Win-Test Wiki

[Jump to navigation](#) [Jump to search](#)

- [File](#)
- [File history](#)
- [File usage](#)

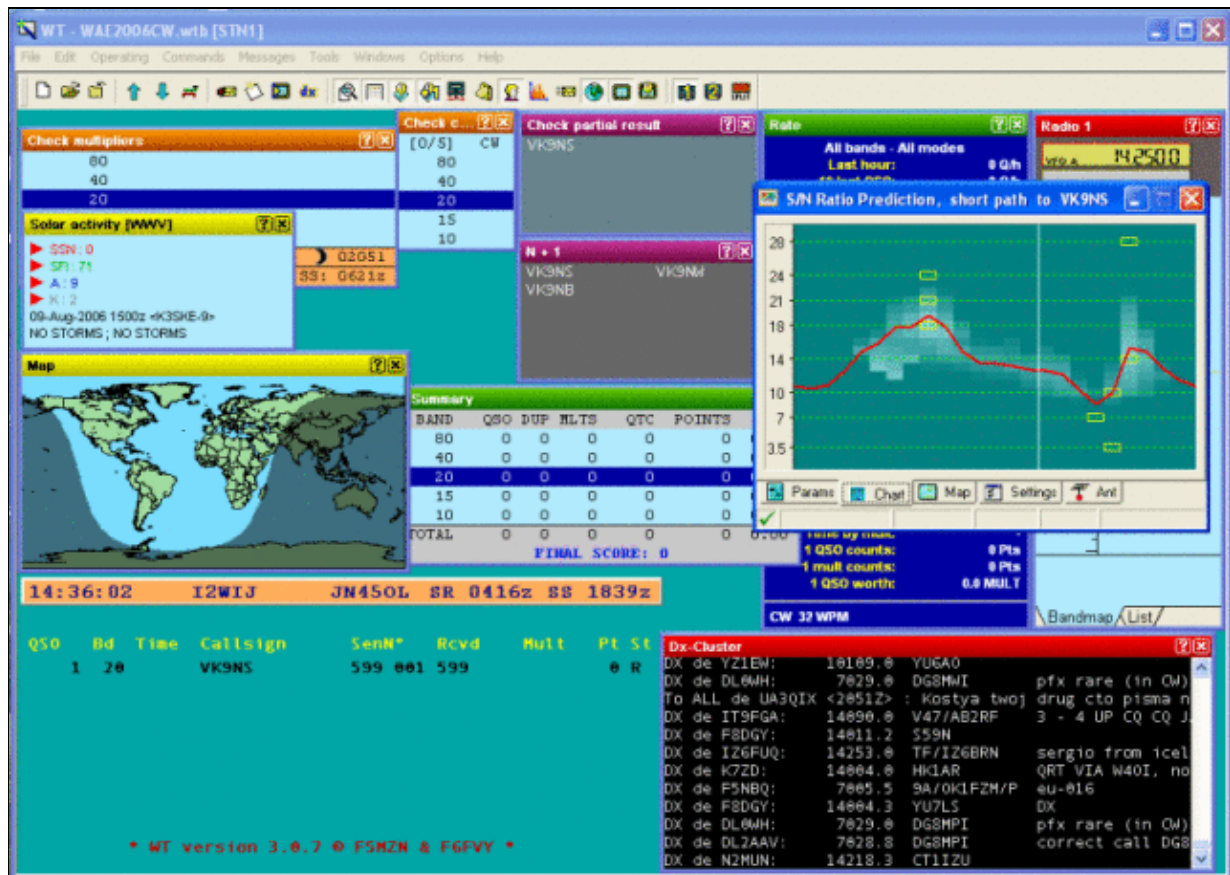



No higher resolution available.

[HamCapForeground.gif](#) (640 × 456 pixels, file size: 152 KB, MIME type: image.gif)

This image shows the usage of HamCAP from within Win-Test

## File history

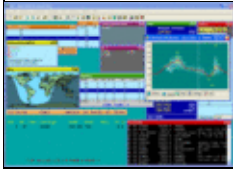
Click on a date/time to view the file as it appeared at that time.

	Date/Time	Thumbnail	Dimensions	User	Comment
current	<a href="#">07:09, 30 March 2007</a>		640 × 456 (152 KB)	<a href="#">I2WIJ (talk   contribs)</a>	reduced sized to have a better printout
	<a href="#">14:40, 10 August 2006</a>		800 × 570 (164 KB)	<a href="#">I2WIJ (talk   contribs)</a>	

You cannot overwrite this file.

## File usage

The following page uses this file:

- [Menu:Options](#)

## Namespaces

- [File](#)
- [Discussion](#)

## Variants

## Views

- [Read](#)
- [View source](#)
- [View history](#)

## More

- This page was last edited on 24 August 2006, at 11:44.
- [Privacy policy](#)
- [About Win-Test Wiki](#)
- [Disclaimers](#)





# File:HamCapForeground.gif

From Win-Test Wiki

[Jump to navigation](#) [Jump to search](#)

- [File](#)
- [File history](#)
- [File usage](#)

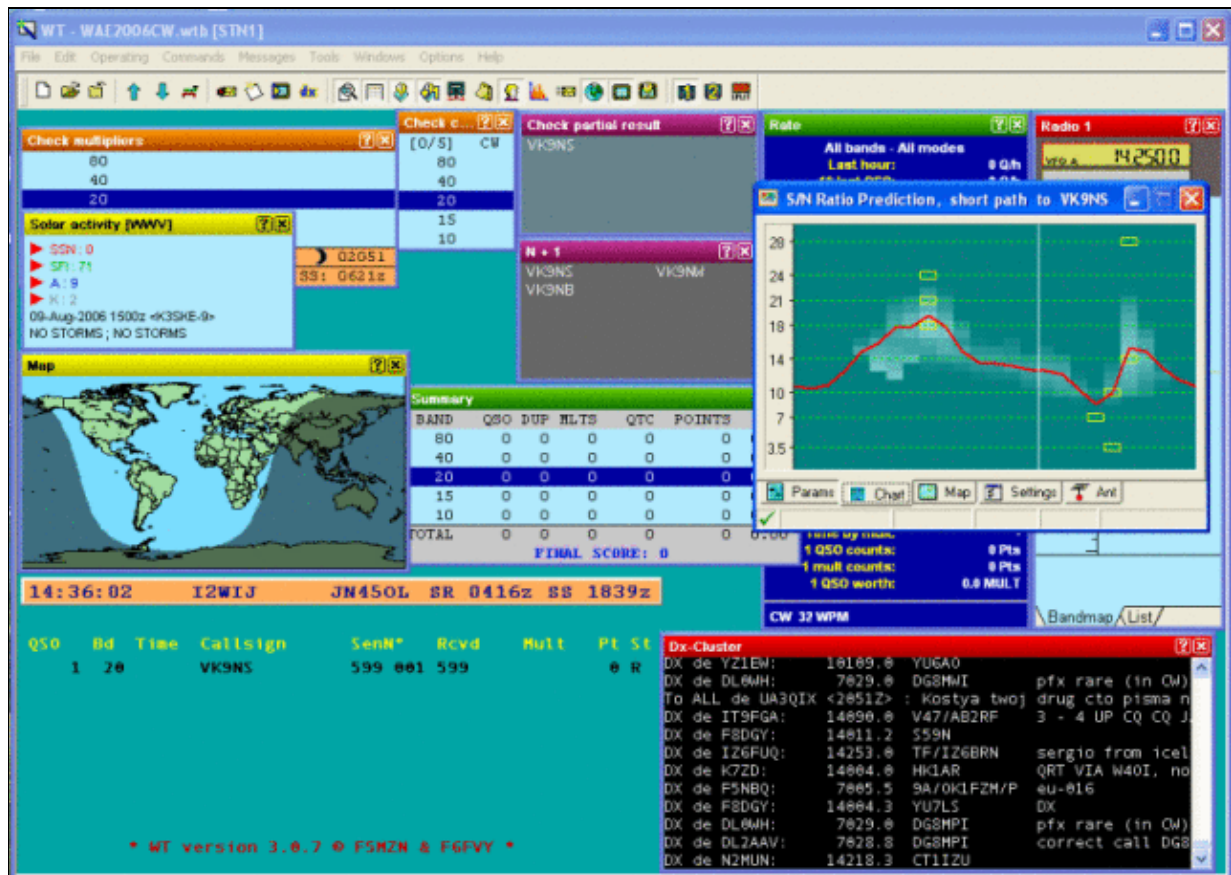



No higher resolution available.

[HamCapForeground.gif](#) (640 × 456 pixels, file size: 152 KB, MIME type: image.gif)

This image shows the usage of HamCAP from within Win-Test

## File history

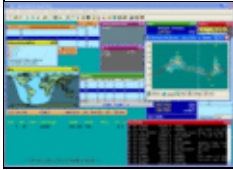
Click on a date/time to view the file as it appeared at that time.

	Date/Time	Thumbnail	Dimensions	User	Comment
current	<a href="#">07:09, 30 March 2007</a>		640 × 456 (152 KB)	<a href="#">I2WIJ (talk   contribs)</a>	reduced sized to have a better printout
	<a href="#">14:40, 10 August 2006</a>		800 × 570 (164 KB)	<a href="#">I2WIJ (talk   contribs)</a>	

You cannot overwrite this file.

## File usage

The following page uses this file:

- [Menu:Options](#)

## Namespaces

- [File](#)
- [Discussion](#)

## Variants

## Views

- [Read](#)
- [View source](#)
- [View history](#)

## More

- This page was last edited on 24 August 2006, at 11:44.
- [Privacy policy](#)
- [About Win-Test Wiki](#)
- [Disclaimers](#)



# File:HamCapMap.gif

From Win-Test Wiki

[Jump to navigation](#) [Jump to search](#)

- [File](#)
- [File history](#)
- [File usage](#)

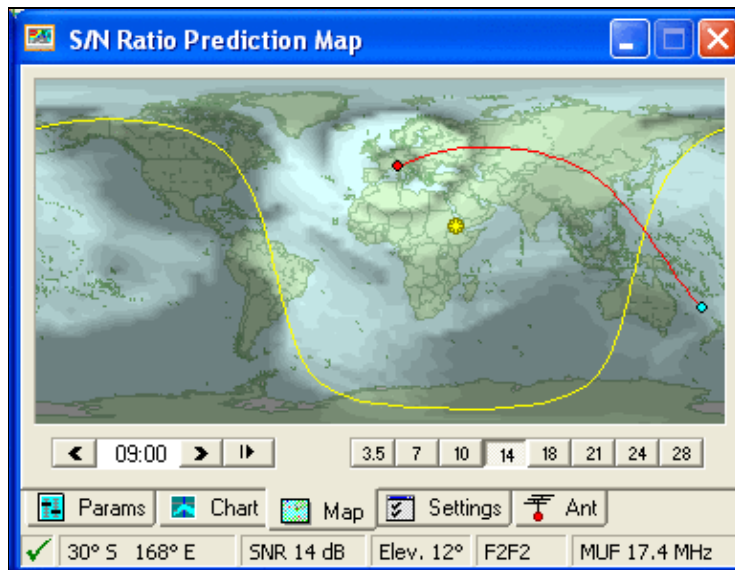

No higher resolution available.

[HamCapMap.gif](#) (383 × 295 pixels, file size: 36 KB, MIME type: image.gif)

## File history

Click on a date/time to view the file as it appeared at that time.

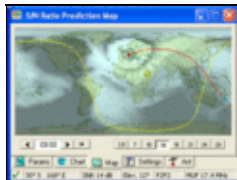
Date/Time	Thumbnail	Dimensions	User	Comment
current <a href="#">13:48, 10 August 2006</a>		383 × 295 (36 KB)	<a href="#">I2WIJ</a> ( <a href="#">talk</a>   <a href="#">contribs</a> )	

You cannot overwrite this file.

## File usage

The following page uses this file:

- [Menu:Commands](#)

## Namespaces

- [File](#)
- [Discussion](#)

## Variants

## Views

- [Read](#)
- [View source](#)
- [View history](#)

## More

- This page was last edited on 10 August 2006, at 13:48.
- [Privacy policy](#)
- [About Win-Test Wiki](#)
- [Disclaimers](#)



# File:HamCapMap.gif

From Win-Test Wiki

[Jump to navigation](#) [Jump to search](#)

- [File](#)
- [File history](#)
- [File usage](#)

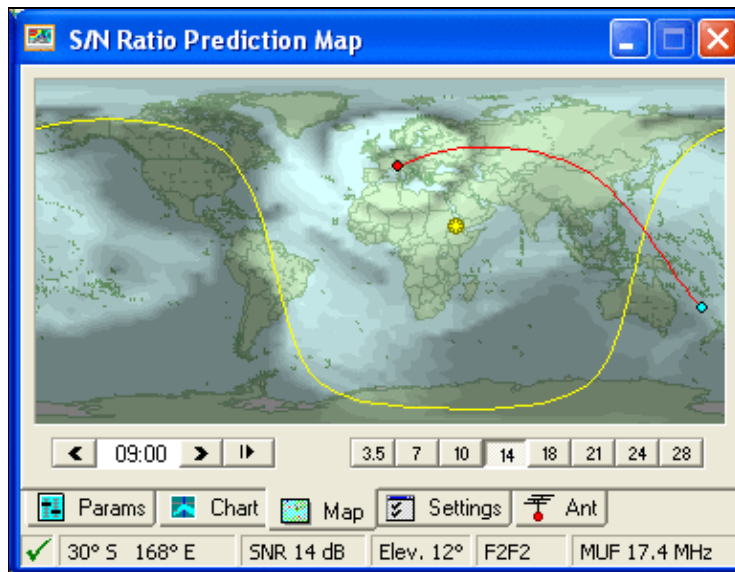

No higher resolution available.

[HamCapMap.gif](#) (383 × 295 pixels, file size: 36 KB, MIME type: image.gif)

## File history

Click on a date/time to view the file as it appeared at that time.

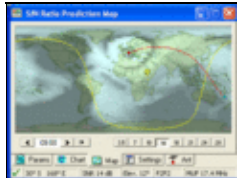
Date/Time	Thumbnail	Dimensions	User	Comment
current <a href="#">13:48, 10 August 2006</a>		383 × 295 (36 KB)	<a href="#">I2WIJ</a> ( <a href="#">talk</a>   <a href="#">contribs</a> )	

You cannot overwrite this file.

## File usage

The following page uses this file:

- [Menu:Commands](#)

## Namespaces

- [File](#)
- [Discussion](#)

## Variants

## Views

- [Read](#)
- [View source](#)
- [View history](#)

## More

- This page was last edited on 10 August 2006, at 13:48.
- [Privacy policy](#)
- [About Win-Test Wiki](#)
- [Disclaimers](#)





# File:HamCapParams.gif

From Win-Test Wiki

[Jump to navigation](#) [Jump to search](#)

- [File](#)
- [File history](#)
- [File usage](#)

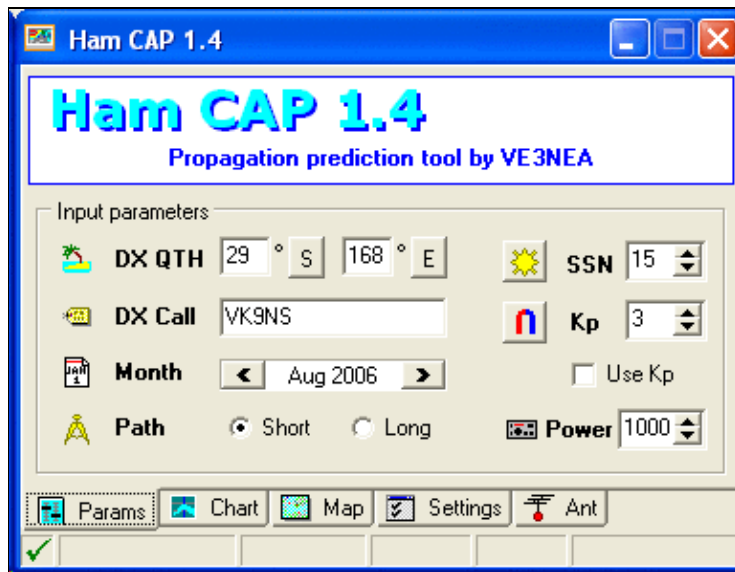

No higher resolution available.

[HamCapParams.gif](#) (383 × 295 pixels, file size: 19 KB, MIME type: image.gif)

## File history

Click on a date/time to view the file as it appeared at that time.

	Date/Time	Thumbnail	Dimensions	User	Comment
current	<a href="#">13:50, 10 August 2006</a>		383 × 295 (19 KB)	<a href="#">I2WIJ</a> ( <a href="#">talk</a>   <a href="#">contribs</a> )	

You cannot overwrite this file.

## File usage

The following page uses this file:

- [HamCAP](#)

## Namespaces

- [File](#)
- [Discussion](#)

## Variants

## Views

- [Read](#)
- [View source](#)
- [View history](#)

## More

- This page was last edited on 10 August 2006, at 13:50.
- [Privacy policy](#)
- [About Win-Test Wiki](#)
- [Disclaimers](#)



# File:HamCapParams.gif

From Win-Test Wiki

[Jump to navigation](#) [Jump to search](#)

- [File](#)
- [File history](#)
- [File usage](#)

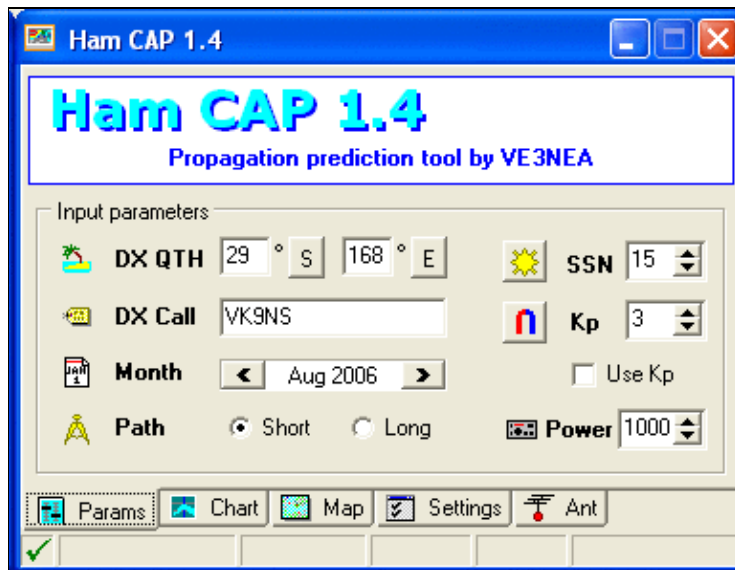

No higher resolution available.

[HamCapParams.gif](#) (383 × 295 pixels, file size: 19 KB, MIME type: image.gif)

## File history

Click on a date/time to view the file as it appeared at that time.

	Date/Time	Thumbnail	Dimensions	User	Comment
current	<a href="#">13:50, 10 August 2006</a>		383 × 295 (19 KB)	<a href="#">I2WIJ</a> ( <a href="#">talk</a>   <a href="#">contribs</a> )	

You cannot overwrite this file.

## File usage

The following page uses this file:

- [HamCAP](#)

## Namespaces

- [File](#)
- [Discussion](#)

## Variants

## Views

- [Read](#)
- [View source](#)
- [View history](#)

## More

- This page was last edited on 10 August 2006, at 13:50.
- [Privacy policy](#)
- [About Win-Test Wiki](#)
- [Disclaimers](#)



# File:HamCAPprediction.gif

From Win-Test Wiki

[Jump to navigation](#) [Jump to search](#)

- [File](#)
- [File history](#)
- [File usage](#)

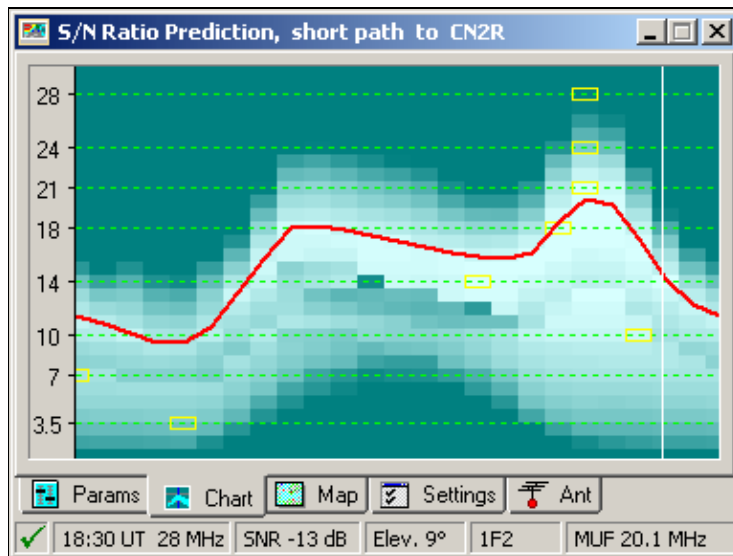

No higher resolution available.

[HamCAPprediction.gif](#) (383 × 288 pixels, file size: 8 KB, MIME type: image/gif)

## File history

Click on a date/time to view the file as it appeared at that time.

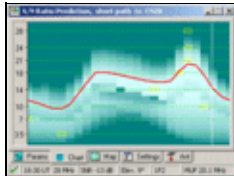
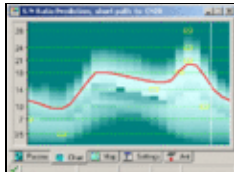
	Date/Time	Thumbnail	Dimensions	User	Comment
current	<a href="#">21:53, 30 August 2006</a>		383 × 288 (8 KB)	<a href="#">DL4NER</a> ( <a href="#">talk</a>   <a href="#">contribs</a> )	
	<a href="#">21:51, 30 August 2006</a>		383 × 288 (7 KB)	<a href="#">DL4NER</a> ( <a href="#">talk</a>   <a href="#">contribs</a> )	

You cannot overwrite this file.

## File usage

The following page uses this file:

- [Menu:Windows](#)

## Namespaces

- [File](#)
- [Discussion](#)

## Variants

## Views

- [Read](#)
- [View source](#)
- [View history](#)

## More

- This page was last edited on 30 August 2006, at 21:51.

- [Privacy policy](#)
- [About Win-Test Wiki](#)
- [Disclaimers](#)



# File:HamCAPprediction.gif

From Win-Test Wiki

[Jump to navigation](#) [Jump to search](#)

- [File](#)
- [File history](#)
- [File usage](#)

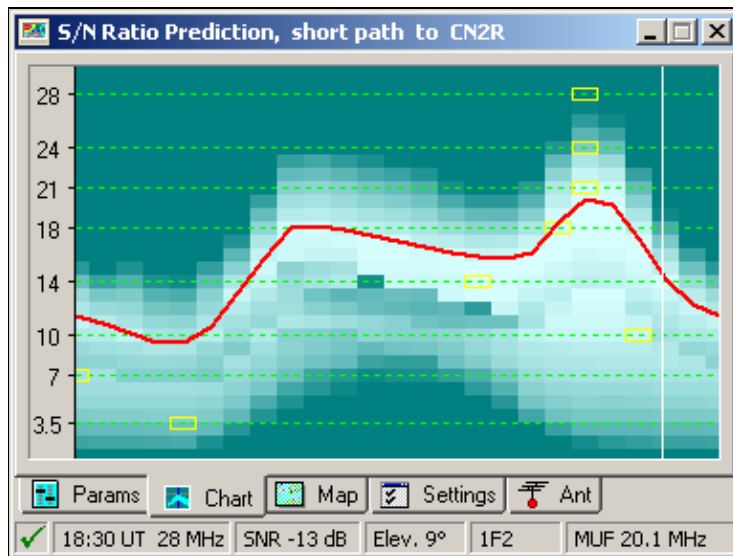

No higher resolution available.

[HamCAPprediction.gif](#) (383 × 288 pixels, file size: 8 KB, MIME type: image/gif)

## File history

Click on a date/time to view the file as it appeared at that time.

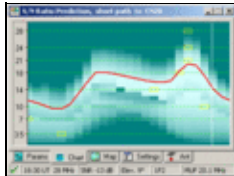
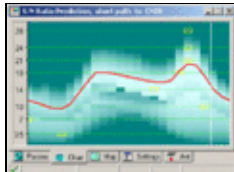
	Date/Time	Thumbnail	Dimensions	User	Comment
current	<a href="#">21:53, 30 August 2006</a>		383 × 288 (8 KB)	<a href="#">DL4NER</a> ( <a href="#">talk</a>   <a href="#">contribs</a> )	
	<a href="#">21:51, 30 August 2006</a>		383 × 288 (7 KB)	<a href="#">DL4NER</a> ( <a href="#">talk</a>   <a href="#">contribs</a> )	

You cannot overwrite this file.

## File usage

The following page uses this file:

- [Menu:Windows](#)

## Namespaces

- [File](#)
- [Discussion](#)

## Variants

## Views

- [Read](#)
- [View source](#)
- [View history](#)

## More

- This page was last edited on 30 August 2006, at 21:51.

- [Privacy policy](#)
- [About Win-Test Wiki](#)
- [Disclaimers](#)





# File:HamCapSetting.gif

From Win-Test Wiki

[Jump to navigation](#) [Jump to search](#)

- [File](#)
- [File history](#)
- [File usage](#)

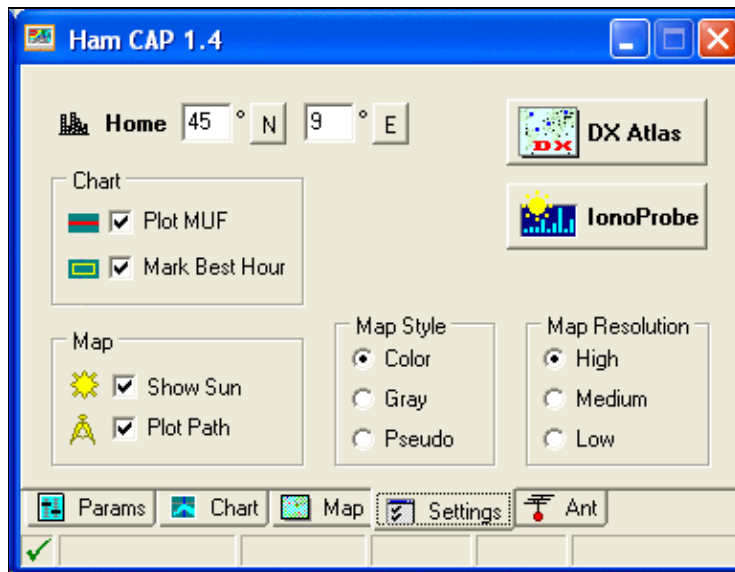

No higher resolution available.

[HamCapSetting.gif](#) (383 × 295 pixels, file size: 18 KB, MIME type: image.gif)

## File history

Click on a date/time to view the file as it appeared at that time.

Date/Time	Thumbnail	Dimensions	User	Comment
current <a href="#">13:50, 10 August 2006</a>		383 × 295 (18 KB)	<a href="#">I2WIJ</a> ( <a href="#">talk</a>   <a href="#">contribs</a> )	

You cannot overwrite this file.

## File usage

The following page uses this file:

- [HamCAP](#)

## Namespaces

- [File](#)
- [Discussion](#)

## Variants

## Views

- [Read](#)
- [View source](#)
- [View history](#)

## More

- This page was last edited on 10 August 2006, at 13:50.
- [Privacy policy](#)
- [About Win-Test Wiki](#)
- [Disclaimers](#)



# File:HamCapSetting.gif

From Win-Test Wiki

[Jump to navigation](#) [Jump to search](#)

- [File](#)
- [File history](#)
- [File usage](#)

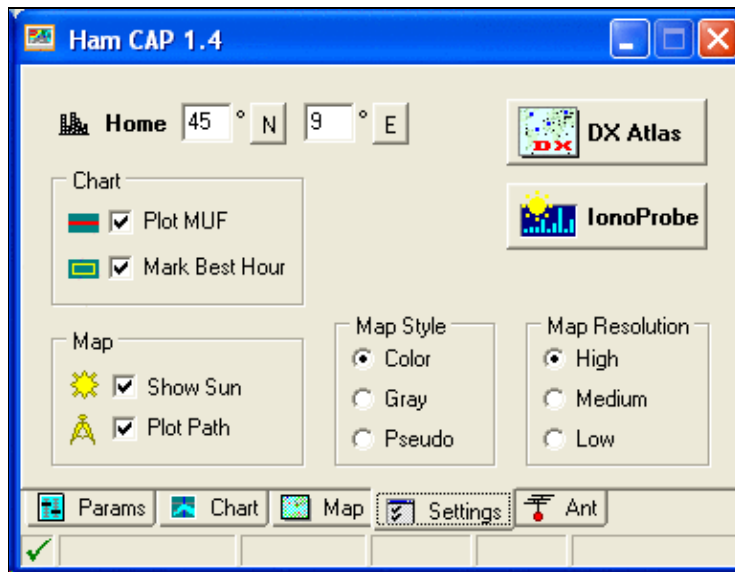

No higher resolution available.

[HamCapSetting.gif](#) (383 × 295 pixels, file size: 18 KB, MIME type: image.gif)

## File history

Click on a date/time to view the file as it appeared at that time.

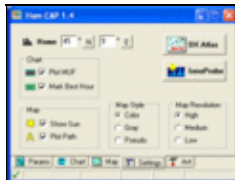
Date/Time	Thumbnail	Dimensions	User	Comment
current <a href="#">13:50, 10 August 2006</a>		383 × 295 (18 KB)	<a href="#">I2WIJ</a> ( <a href="#">talk</a>   <a href="#">contribs</a> )	

You cannot overwrite this file.

## File usage

The following page uses this file:

- [HamCAP](#)

## Namespaces

- [File](#)
- [Discussion](#)

## Variants

## Views

- [Read](#)
- [View source](#)
- [View history](#)

## More

- This page was last edited on 10 August 2006, at 13:50.
- [Privacy policy](#)
- [About Win-Test Wiki](#)
- [Disclaimers](#)



# File:HelpAbout.PNG

From Win-Test Wiki

[Jump to navigation](#) [Jump to search](#)

- [File](#)
- [File history](#)
- [File usage](#)



No higher resolution available.

[HelpAbout.PNG](#) (339 × 125 pixels, file size: 6 KB, MIME type: image.gif)

## File history

Click on a date/time to view the file as it appeared at that time.

Date/Time	Thumbnail	Dimensions	User	Comment
current <a href="#">06:21, 21 January 2009</a>		339 × 125 (6 KB)	<a href="#">Dl6rai</a> ( <a href="#">talk</a>   <a href="#">contribs</a> )	

You cannot overwrite this file.

## File usage

The following page uses this file:

- [Menu:Help](#)

## Namespaces

- [File](#)
- [Discussion](#)

## Variants

## Views

- [Read](#)
- [View source](#)
- [View history](#)

## More

- This page was last edited on 21 January 2009, at 06:21.

- [Privacy policy](#)
- [About Win-Test Wiki](#)
- [Disclaimers](#)



# File:HelpAbout.PNG

From Win-Test Wiki

[Jump to navigation](#) [Jump to search](#)

- [File](#)
- [File history](#)
- [File usage](#)



No higher resolution available.

[HelpAbout.PNG](#) (339 × 125 pixels, file size: 6 KB, MIME type: image.gif)

## File history

Click on a date/time to view the file as it appeared at that time.

Date/Time	Thumbnail	Dimensions	User	Comment
current <a href="#">06:21, 21 January 2009</a>		339 × 125 (6 KB)	<a href="#">Dl6rai</a> ( <a href="#">talk</a>   <a href="#">contribs</a> )	

You cannot overwrite this file.

## File usage

The following page uses this file:

- [Menu:Help](#)

## Namespaces

- [File](#)
- [Discussion](#)

## Variants

## Views

- [Read](#)
- [View source](#)
- [View history](#)

## More

- This page was last edited on 21 January 2009, at 06:21.

- [Privacy policy](#)
- [About Win-Test Wiki](#)
- [Disclaimers](#)





# File:HelpRegisterSoftware.gif

From Win-Test Wiki

[Jump to navigation](#) [Jump to search](#)

- [File](#)
- [File history](#)
- [File usage](#)

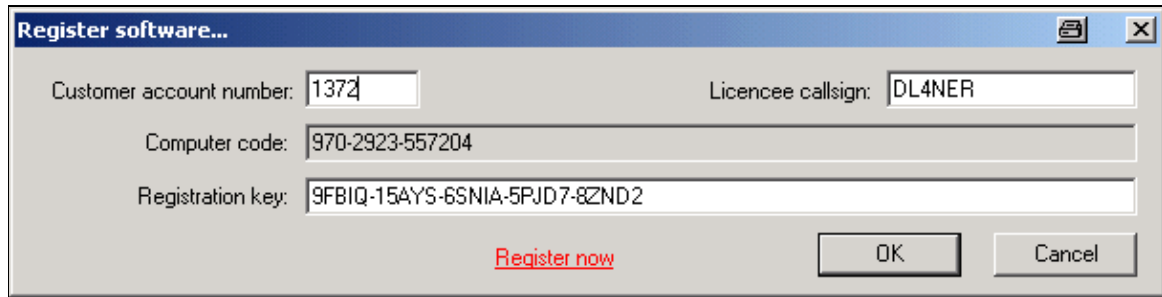

No higher resolution available.

[HelpRegisterSoftware.gif](#) (605 Å 152 pixels, file size: 8 KB, MIME type: image/gif)

## File history

Click on a date/time to view the file as it appeared at that time.

	Date/Time	Thumbnail	Dimensions	User	Comment
current	<a href="#">11:52, 10 October 2006</a>		605 Å 152 (8 KB)	<a href="#">Dl6rai</a> ( <a href="#">talk</a>   <a href="#">contribs</a> )	

You cannot overwrite this file.

## File usage

The following page uses this file:

- [Menu:Help](#)

## Namespaces

- [File](#)
- [Discussion](#)

## Variants

## Views

- [Read](#)
- [View source](#)

- [View history](#)

## More

- This page was last edited on 10 October 2006, at 11:52.

- [Privacy policy](#)
- [About Win-Test Wiki](#)
- [Disclaimers](#)



# File:HelpRegisterSoftware.gif

From Win-Test Wiki

[Jump to navigation](#) [Jump to search](#)

- [File](#)
- [File history](#)
- [File usage](#)

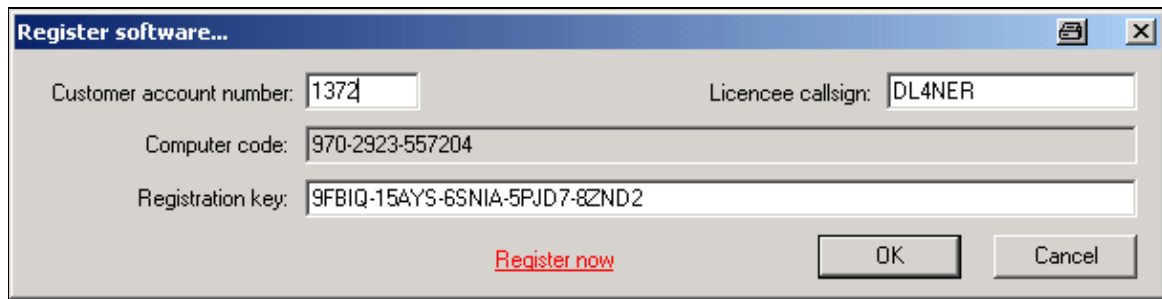

No higher resolution available.

[HelpRegisterSoftware.gif](#) (605 Å 152 pixels, file size: 8 KB, MIME type: image/gif)

## File history

Click on a date/time to view the file as it appeared at that time.

	Date/Time	Thumbnail	Dimensions	User	Comment
current	<a href="#">11:52, 10 October 2006</a>		605 Å 152 (8 KB)	<a href="#">Dl6rai</a> ( <a href="#">talk</a>   <a href="#">contribs</a> )	

You cannot overwrite this file.

## File usage

The following page uses this file:

- [Menu:Help](#)

## Namespaces

- [File](#)
- [Discussion](#)

## Variants

## Views

- [Read](#)
- [View source](#)

- [View history](#)

## More

- This page was last edited on 10 October 2006, at 11:52.

- [Privacy policy](#)
- [About Win-Test Wiki](#)
- [Disclaimers](#)



# File:IC-275HSetupComProperties.PNG

From Win-Test Wiki

[Jump to navigation](#) [Jump to search](#)

- [File](#)
- [File history](#)
- [File usage](#)

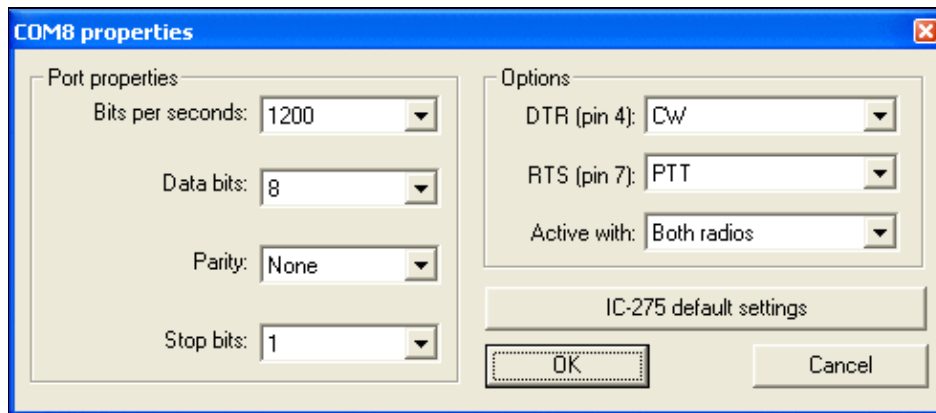

No higher resolution available.

[IC-275HSetupComProperties.PNG](#) (491 × 213 pixels, file size: 9 KB, MIME type: image/gif)

## File history

Click on a date/time to view the file as it appeared at that time.

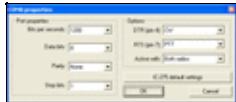
	Date/Time	Thumbnail	Dimensions	User	Comment
current	<a href="#">08:00, 17 May 2007</a>		491 × 213 (9 KB)	<a href="#">Dl6rai</a> ( <a href="#">talk</a>   <a href="#">contribs</a> )	

You cannot overwrite this file.

## File usage

The following page uses this file:

- [BestPractice3](#)

## Namespaces

- [File](#)
- [Discussion](#)

## Variants

## Views

- [Read](#)
- [View source](#)
- [View history](#)

## More

- This page was last edited on 17 May 2007, at 08:00.

- [Privacy policy](#)
- [About Win-Test Wiki](#)
- [Disclaimers](#)



# File:IC-275HSetupComProperties.PNG

From Win-Test Wiki

[Jump to navigation](#) [Jump to search](#)

- [File](#)
- [File history](#)
- [File usage](#)

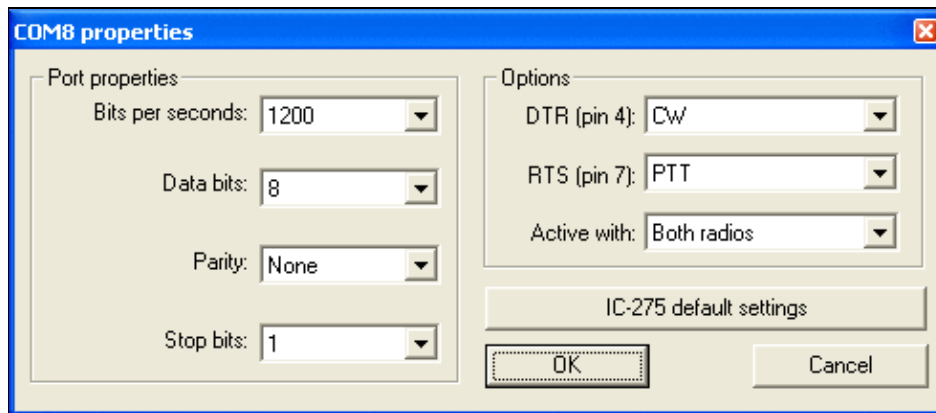

No higher resolution available.

[IC-275HSetupComProperties.PNG](#) (491 × 213 pixels, file size: 9 KB, MIME type: image/gif)

## File history

Click on a date/time to view the file as it appeared at that time.

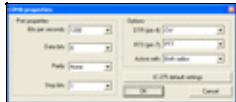
	Date/Time	Thumbnail	Dimensions	User	Comment
current	<a href="#">08:00, 17 May 2007</a>		491 × 213 (9 KB)	<a href="#">Dl6rai</a> ( <a href="#">talk</a>   <a href="#">contribs</a> )	

You cannot overwrite this file.

## File usage

The following page uses this file:

- [BestPractice3](#)

## Namespaces

- [File](#)
- [Discussion](#)

## Variants

## Views

- [Read](#)
- [View source](#)
- [View history](#)

## More

- This page was last edited on 17 May 2007, at 08:00.

- [Privacy policy](#)
- [About Win-Test Wiki](#)
- [Disclaimers](#)





# File:IC-275HSetupProperties.PNG

From Win-Test Wiki

[Jump to navigation](#) [Jump to search](#)

- [File](#)
- [File history](#)
- [File usage](#)

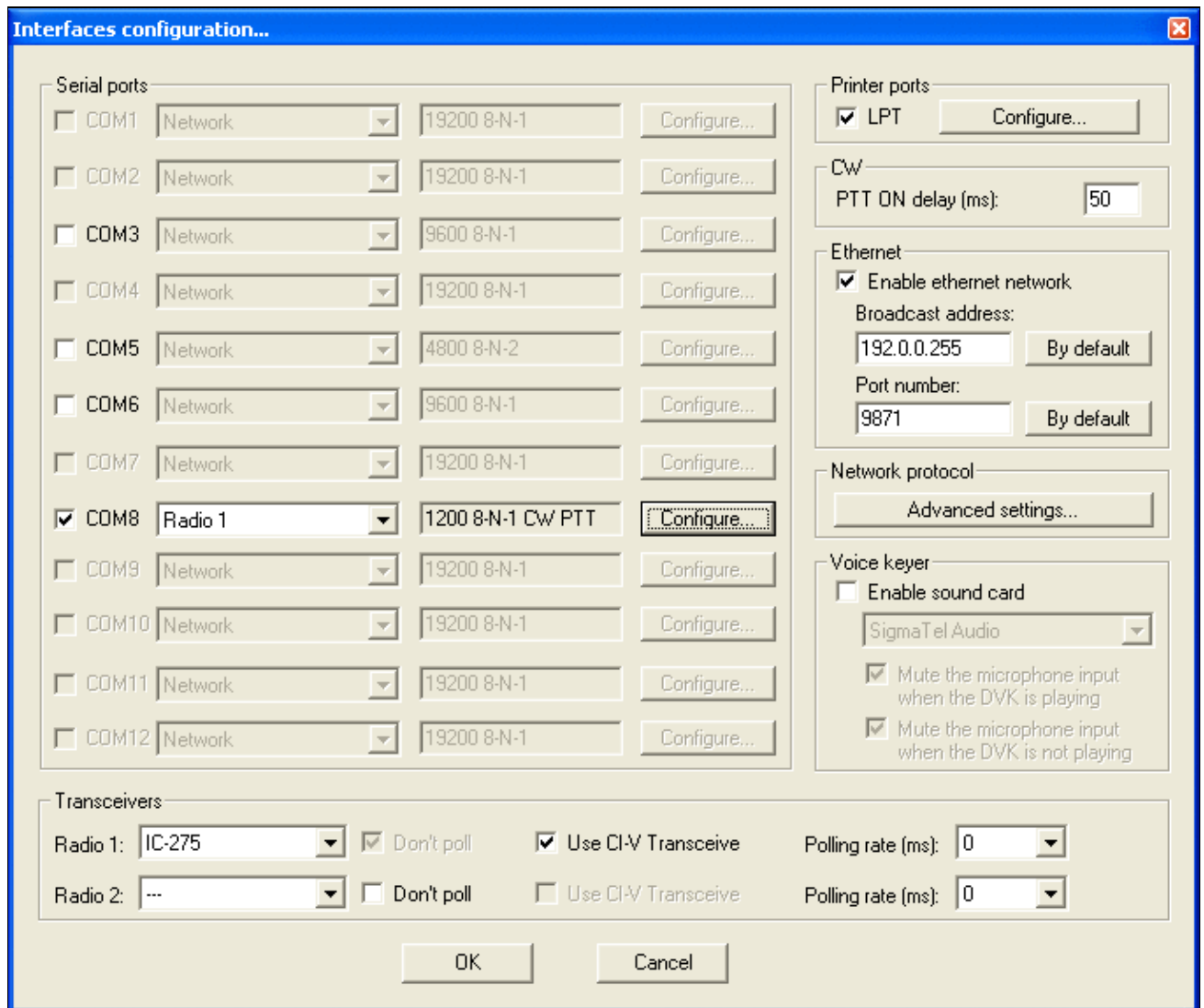

No higher resolution available.

IC-275HSetupProperties.PNG (678 Å 573 pixels, file size: 34 KB, MIME type: image.gif)

## File history

Click on a date/time to view the file as it appeared at that time.

	Date/Time	Thumbnail	Dimensions	User	Comment
current	<u>08:04, 17 May 2007</u>		678 Å 573 (34 KB)	<u>Dl6rai</u> ( <a href="#">talk</a>   <a href="#">contribs</a> )	

You cannot overwrite this file.

## File usage

The following page uses this file:

- [BestPractice3](#)

## Namespaces

- [File](#)
- [Discussion](#)

## Variants

## Views

- [Read](#)
- [View source](#)
- [View history](#)

## More

- This page was last edited on 17 May 2007, at 08:04.
- [Privacy policy](#)
- [About Win-Test Wiki](#)
- [Disclaimers](#)



# File:IC-275HSetupProperties.PNG

From Win-Test Wiki

[Jump to navigation](#) [Jump to search](#)

- [File](#)
- [File history](#)
- [File usage](#)

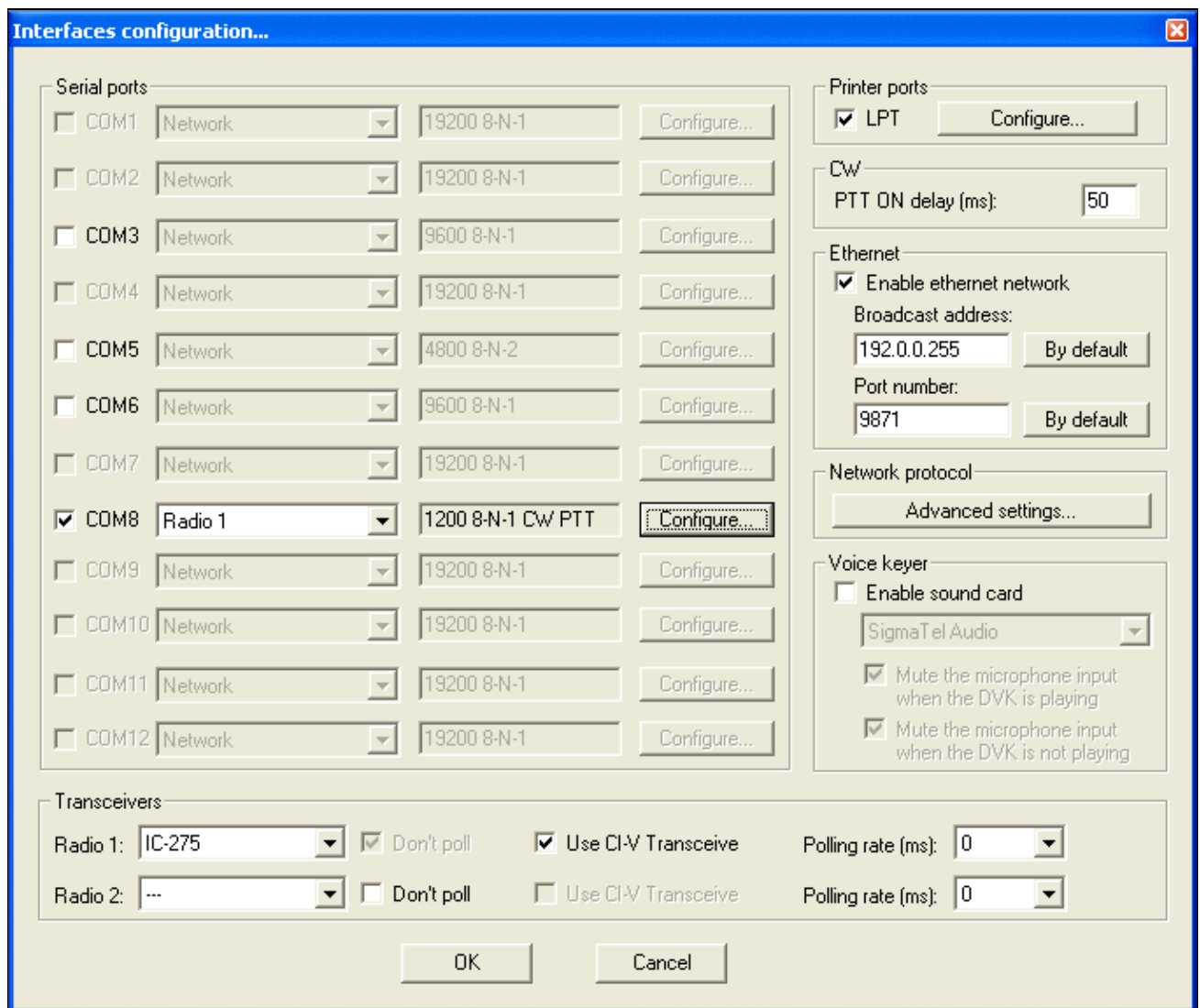

No higher resolution available.

IC-275HSetupProperties.PNG (678 Å 573 pixels, file size: 34 KB, MIME type: image.gif)

## File history

Click on a date/time to view the file as it appeared at that time.

	Date/Time	Thumbnail	Dimensions	User	Comment
current	<u>08:04, 17 May 2007</u>		678 Å 573 (34 KB)	<u>Dl6rai</u> ( <a href="#">talk</a>   <a href="#">contribs</a> )	

You cannot overwrite this file.

## File usage

The following page uses this file:

- [BestPractice3](#)

## Namespaces

- [File](#)
- [Discussion](#)

## Variants

## Views

- [Read](#)
- [View source](#)
- [View history](#)

## More

- This page was last edited on 17 May 2007, at 08:04.
- [Privacy policy](#)
- [About Win-Test Wiki](#)
- [Disclaimers](#)



# File:IconsBar.gif

From Win-Test Wiki

[Jump to navigation](#) [Jump to search](#)

- [File](#)
- [File history](#)
- [File usage](#)



No higher resolution available.

[IconsBar.gif](#) (629 Å 57 pixels, file size: 8 KB, MIME type: image/gif)

## File history

Click on a date/time to view the file as it appeared at that time.

Date/Time	Thumbnail	Dimensions	User	Comment
current <a href="#">21:10, 24 July 2006</a>		629 Å 57 (8 KB)	<a href="#">Dl4ner</a> ( <a href="#">talk</a>   <a href="#">contribs</a> )	

You cannot overwrite this file.

## File usage

The following 2 pages use this file:

- [Icon bar](#)
- [Menu:Options](#)

## Namespaces

- [File](#)
- [Discussion](#)

## Variants

## Views

- [Read](#)
- [View source](#)
- [View history](#)

## More

- This page was last edited on 24 July 2006, at 21:10.

- [Privacy policy](#)
- [About Win-Test Wiki](#)
- [Disclaimers](#)





## More

- This page was last edited on 24 July 2006, at 21:10.

- [Privacy policy](#)
- [About Win-Test Wiki](#)
- [Disclaimers](#)





# File:Interfaces.gif

From Win-Test Wiki

[Jump to navigation](#) [Jump to search](#)

- [File](#)
- [File history](#)
- [File usage](#)
- [Metadata](#)

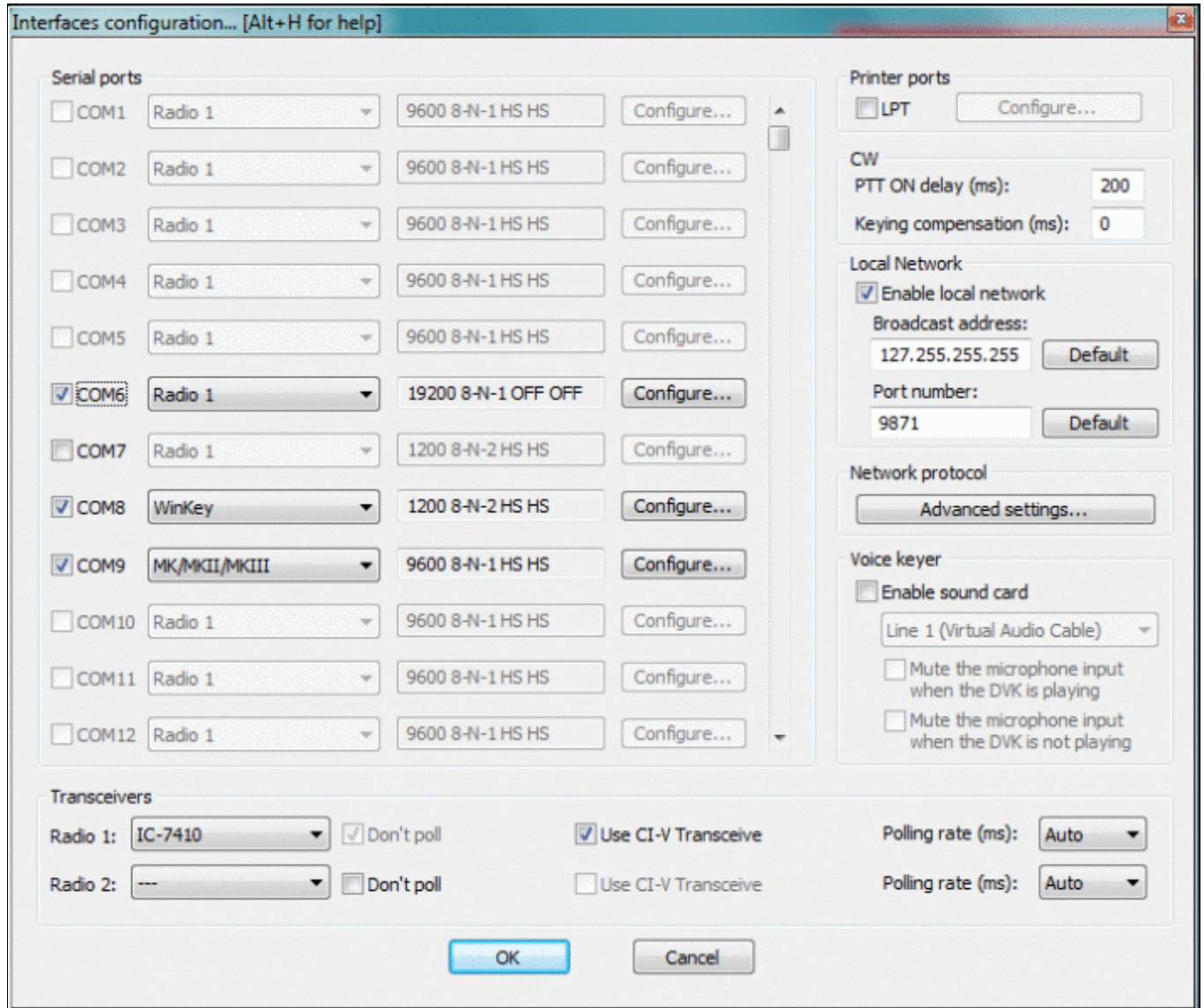

Size of this preview: [707 Å 599 pixels](#). Other resolutions: [283 Å 240 pixels](#) | [716 Å 607 pixels](#).  
[Original file](#) (716 Å 607 pixels, file size: 57 KB, MIME type: image.gif)

"Configure Interfaces" dialog screenshot

## File history

Click on a date/time to view the file as it appeared at that time.

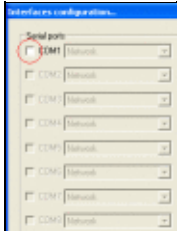
	Date/Time	Thumbnail	Dimensions	User	Comment
current	<a href="#">13:32, 30 December 2021</a>		716 Å 607 (57 KB)	<a href="#">Dl6rai (talk   contribs)</a>	
	<a href="#">14:13, 5 January 2006</a>		230 Å 308 (6 KB)	<a href="#">M0CLW (talk   contribs)</a>	"Configure Interfaces" dialog screenshot

You cannot overwrite this file.

## File usage

The following page uses this file:

- [Interfaces](#)

## Metadata

This file contains additional information, probably added from the digital camera or scanner used to create or digitize it.

If the file has been modified from its original state, some details may not fully reflect the modified file.

**Horizontal resolution** 37.79 dpc

**Vertical resolution** 37.79 dpc

## Namespaces

- [File](#)
- [Discussion](#)

## Variants

## Views

- [Read](#)
- [View source](#)
- [View history](#)

## More

- This page was last edited on 30 December 2021, at 13:32.

- [Privacy policy](#)
- [About Win-Test Wiki](#)
- [Disclaimers](#)



# File:Interfaces.gif

From Win-Test Wiki

[Jump to navigation](#) [Jump to search](#)

- [File](#)
- [File history](#)
- [File usage](#)
- [Metadata](#)

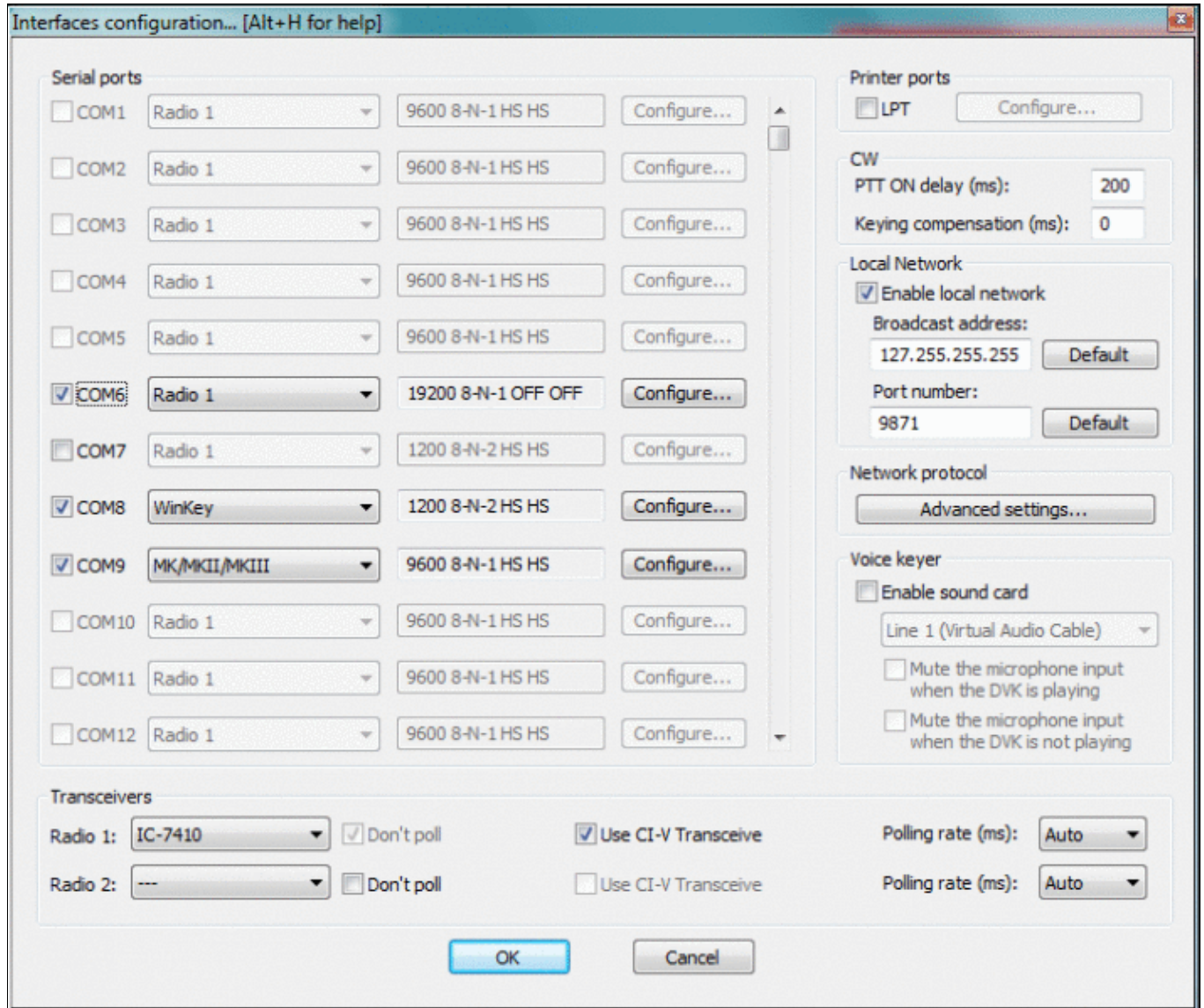

Size of this preview: [707 Å 599 pixels](#). Other resolutions: [283 Å 240 pixels](#) | [716 Å 607 pixels](#). [Original file](#) (716 Å 607 pixels, file size: 57 KB, MIME type: image.gif)

"Configure Interfaces" dialog screenshot

## File history

Click on a date/time to view the file as it appeared at that time.

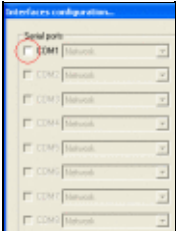
	Date/Time	Thumbnail	Dimensions	User	Comment
current	<a href="#">13:32, 30 December 2021</a>		716 Å 607 (57 KB)	<a href="#">Dl6rai (talk   contribs)</a>	
	<a href="#">14:13, 5 January 2006</a>		230 Å 308 (6 KB)	<a href="#">M0CLW (talk   contribs)</a>	"Configure Interfaces" dialog screenshot

You cannot overwrite this file.

## File usage

The following page uses this file:

- [Interfaces](#)

## Metadata

This file contains additional information, probably added from the digital camera or scanner used to create or digitize it.

If the file has been modified from its original state, some details may not fully reflect the modified file.

**Horizontal resolution** 37.79 dpc

**Vertical resolution** 37.79 dpc

## Namespaces

- [File](#)
- [Discussion](#)

## Variants

## Views

- [Read](#)
- [View source](#)
- [View history](#)

## More

- This page was last edited on 30 December 2021, at 13:32.

- [Privacy policy](#)
- [About Win-Test Wiki](#)
- [Disclaimers](#)



# File:keyboardmode.gif

From Win-Test Wiki

[Jump to navigation](#) [Jump to search](#)

- [File](#)
- [File history](#)
- [File usage](#)

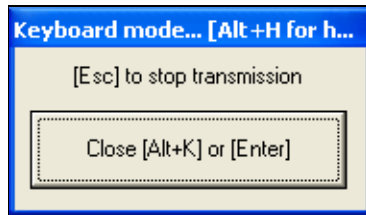

No higher resolution available.

[keyboardmode.gif](#) (189 × 109 pixels, file size: 4 KB, MIME type: image.gif)

## File history

Click on a date/time to view the file as it appeared at that time.

	Date/Time	Thumbnail	Dimensions	User	Comment
current	<a href="#">07:23, 15 September 2007</a>		189 × 109 (4 KB)	<a href="#">Dl6rai</a> ( <a href="#">talk</a>   <a href="#">contribs</a> )	
	<a href="#">21:05, 29 July 2006</a>		185 × 89 (2 KB)	<a href="#">DL4NER</a> ( <a href="#">talk</a>   <a href="#">contribs</a> )	

You cannot overwrite this file.

## File usage

The following page uses this file:

- [Menu:Commands](#)

## Namespaces

- [File](#)
- [Discussion](#)

## Variants

## Views

- [Read](#)
- [View source](#)
- [View history](#)

## More

- This page was last edited on 29 July 2006, at 21:05.

- [Privacy policy](#)
- [About Win-Test Wiki](#)
- [Disclaimers](#)





# File:keyboardmode.gif

From Win-Test Wiki

[Jump to navigation](#) [Jump to search](#)

- [File](#)
- [File history](#)
- [File usage](#)

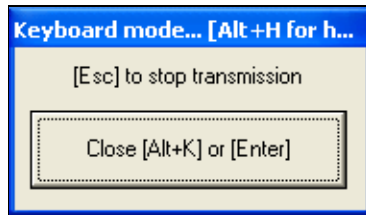

No higher resolution available.

[keyboardmode.gif](#) (189 × 109 pixels, file size: 4 KB, MIME type: image.gif)

## File history

Click on a date/time to view the file as it appeared at that time.

	Date/Time	Thumbnail	Dimensions	User	Comment
current	<a href="#">07:23, 15 September 2007</a>		189 × 109 (4 KB)	<a href="#">Dl6rai</a> ( <a href="#">talk</a>   <a href="#">contribs</a> )	
	<a href="#">21:05, 29 July 2006</a>		185 × 89 (2 KB)	<a href="#">DL4NER</a> ( <a href="#">talk</a>   <a href="#">contribs</a> )	

You cannot overwrite this file.

## File usage

The following page uses this file:

- [Menu:Commands](#)

## Namespaces

- [File](#)
- [Discussion](#)

## Variants

## Views

- [Read](#)
- [View source](#)
- [View history](#)

## More

- This page was last edited on 29 July 2006, at 21:05.

- [Privacy policy](#)
- [About Win-Test Wiki](#)
- [Disclaimers](#)



# File:LineInPopUp.gif

From Win-Test Wiki

[Jump to navigation](#) [Jump to search](#)

- [File](#)
- [File history](#)
- [File usage](#)

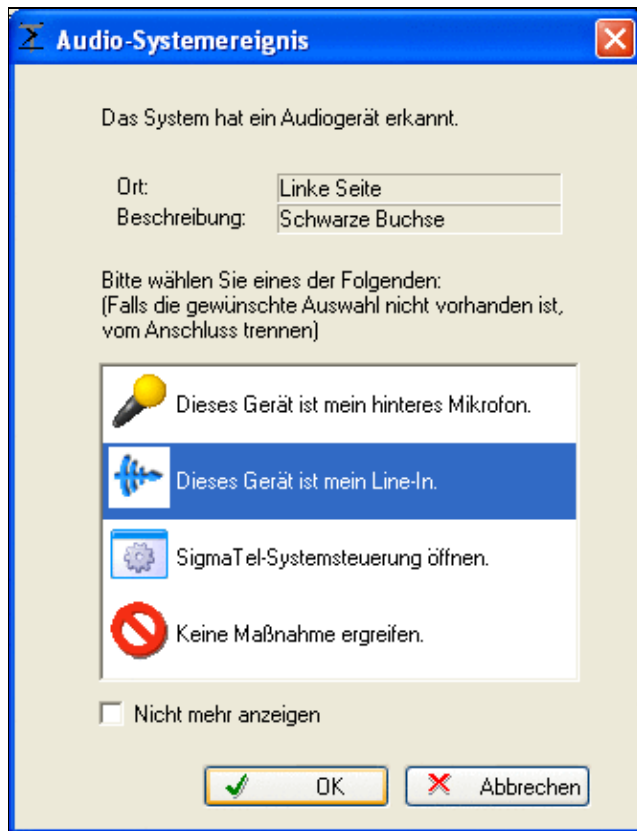

No higher resolution available.

[LineInPopUp.gif](#) (332 × 432 pixels, file size: 18 KB, MIME type: image.gif)

## File history

Click on a date/time to view the file as it appeared at that time.

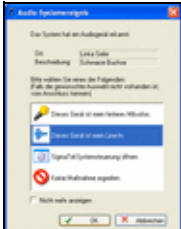
Date/Time	Thumbnail	Dimensions	User	Comment
current <a href="#">09:18, 5 January 2007</a>		332 × 432 (18 KB)	<a href="#">Dl6rai</a> ( <a href="#">talk</a>   <a href="#">contribs</a> )	

You cannot overwrite this file.

## File usage

The following 2 pages use this file:

- [BestPractice1](#)
- [BestPractice4](#)

## Namespaces

- [File](#)
- [Discussion](#)

## Variants

## Views

- [Read](#)
- [View source](#)
- [View history](#)

## More

- This page was last edited on 5 January 2007, at 09:18.

- [Privacy policy](#)
- [About Win-Test Wiki](#)
- [Disclaimers](#)



# File:LineInPopUp.gif

From Win-Test Wiki

[Jump to navigation](#) [Jump to search](#)

- [File](#)
- [File history](#)
- [File usage](#)

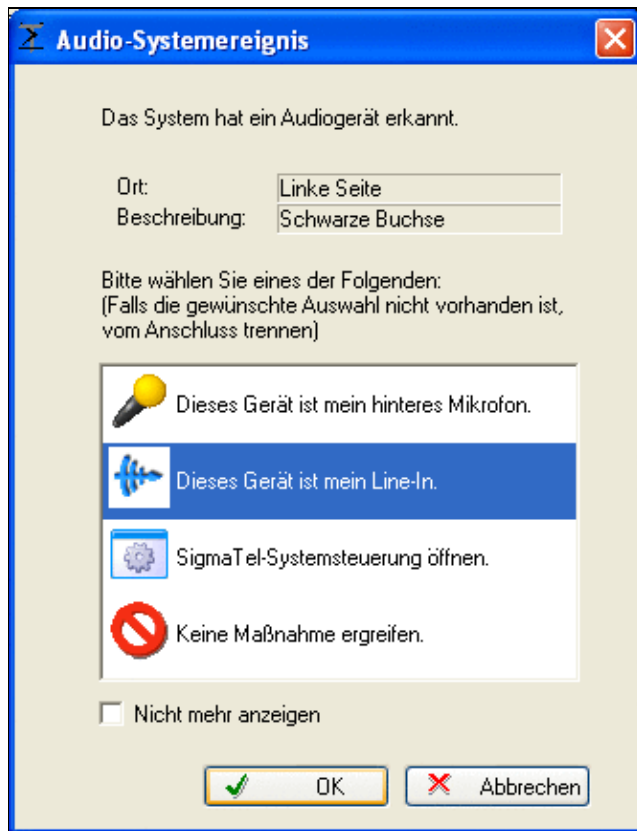

No higher resolution available.

[LineInPopUp.gif](#) (332 × 432 pixels, file size: 18 KB, MIME type: image.gif)

## File history

Click on a date/time to view the file as it appeared at that time.

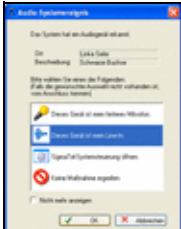
Date/Time	Thumbnail	Dimensions	User	Comment
current <a href="#">09:18, 5 January 2007</a>		332 × 432 (18 KB)	<a href="#">Dl6rai</a> ( <a href="#">talk</a>   <a href="#">contribs</a> )	

You cannot overwrite this file.

## File usage

The following 2 pages use this file:

- [BestPractice1](#)
- [BestPractice4](#)

## Namespaces

- [File](#)
- [Discussion](#)

## Variants

## Views

- [Read](#)
- [View source](#)
- [View history](#)

## More

- This page was last edited on 5 January 2007, at 09:18.

- [Privacy policy](#)
- [About Win-Test Wiki](#)
- [Disclaimers](#)



# File:LiveScoreBroadcasting.gif

From Win-Test Wiki

[Jump to navigation](#) [Jump to search](#)

- [File](#)
- [File history](#)
- [File usage](#)

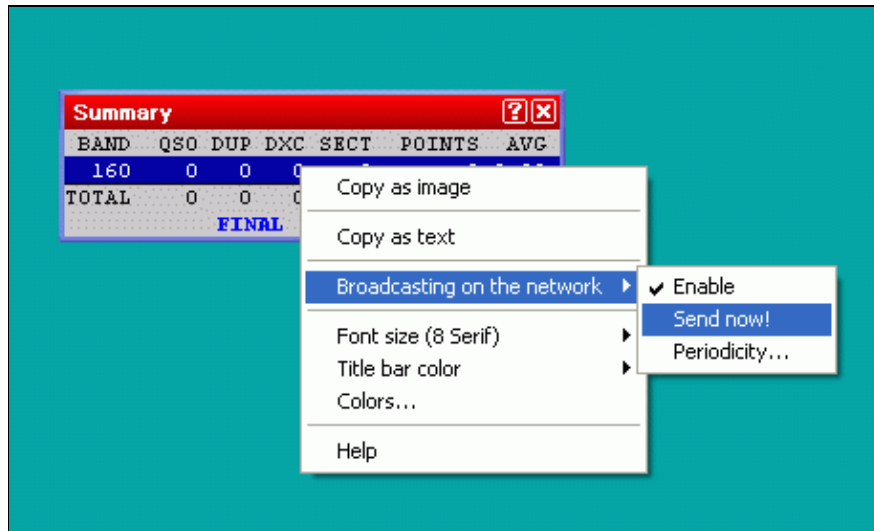

No higher resolution available.

[LiveScoreBroadcasting.gif](#) (458 × 276 pixels, file size: 9 KB, MIME type: image/gif)

## File history

Click on a date/time to view the file as it appeared at that time.

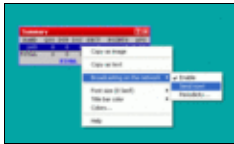
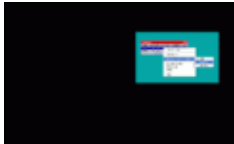
	Date/Time	Thumbnail	Dimensions	User	Comment
current	<a href="#">15:54, 2 December 2006</a>		458 × 276 (9 KB)	<a href="#">Dl6rai</a> ( <a href="#">talk</a>   <a href="#">contribs</a> )	
	<a href="#">15:50, 2 December 2006</a>		1,280 × 800 (13 KB)	<a href="#">Dl6rai</a> ( <a href="#">talk</a>   <a href="#">contribs</a> )	

You cannot overwrite this file.

## File usage

The following page uses this file:

- [Menu:Windows](#)

## Namespaces

- [File](#)
- [Discussion](#)

## Variants

## Views

- [Read](#)
- [View source](#)
- [View history](#)

## More

- This page was last edited on 2 December 2006, at 15:50.
- [Privacy policy](#)
- [About Win-Test Wiki](#)
- [Disclaimers](#)





# File:LiveScoreBroadcasting.gif

From Win-Test Wiki

[Jump to navigation](#) [Jump to search](#)

- [File](#)
- [File history](#)
- [File usage](#)

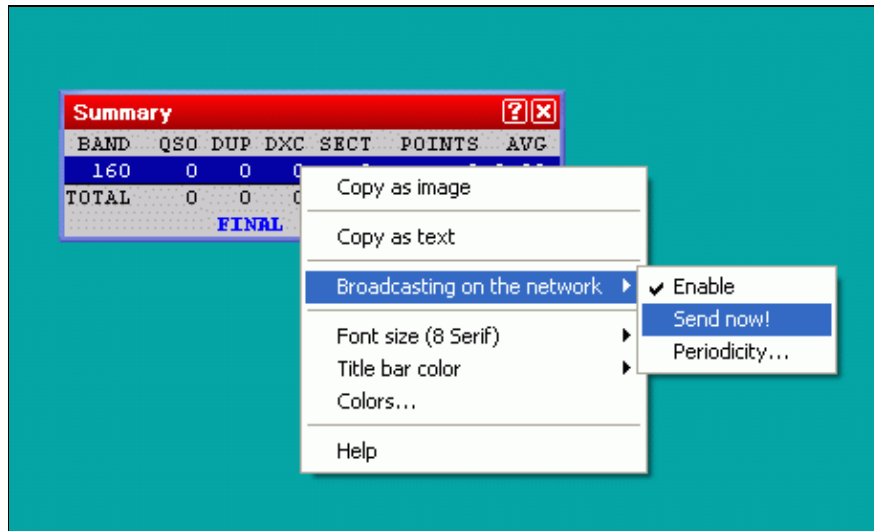

No higher resolution available.

[LiveScoreBroadcasting.gif](#) (458 × 276 pixels, file size: 9 KB, MIME type: image/gif)

## File history

Click on a date/time to view the file as it appeared at that time.

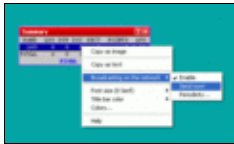
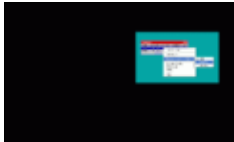
	Date/Time	Thumbnail	Dimensions	User	Comment
current	<a href="#">15:54, 2 December 2006</a>		458 × 276 (9 KB)	<a href="#">Dl6rai</a> ( <a href="#">talk</a>   <a href="#">contribs</a> )	
	<a href="#">15:50, 2 December 2006</a>		1,280 × 800 (13 KB)	<a href="#">Dl6rai</a> ( <a href="#">talk</a>   <a href="#">contribs</a> )	

You cannot overwrite this file.

## File usage

The following page uses this file:

- [Menu:Windows](#)

## Namespaces

- [File](#)
- [Discussion](#)

## Variants

## Views

- [Read](#)
- [View source](#)
- [View history](#)

## More

- This page was last edited on 2 December 2006, at 15:50.
- [Privacy policy](#)
- [About Win-Test Wiki](#)
- [Disclaimers](#)



# File:LogEntryWindow.PNG

From Win-Test Wiki

[Jump to navigation](#) [Jump to search](#)

- [File](#)
- [File history](#)
- [File usage](#)

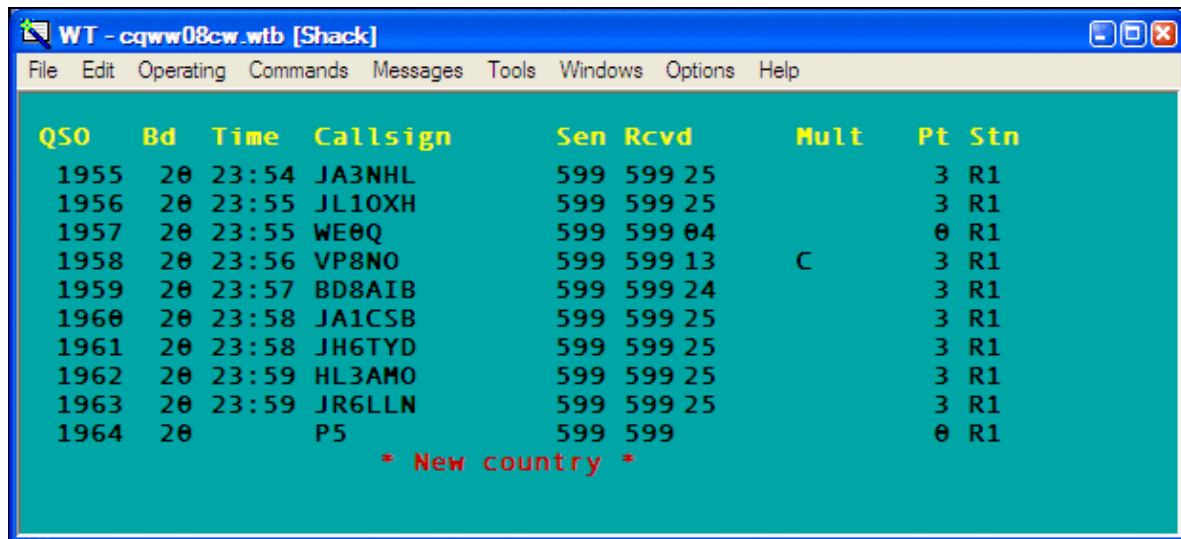

No higher resolution available.

[LogEntryWindow.PNG](#) (617 × 280 pixels, file size: 18 KB, MIME type: image/gif)

Win-Test Main window for log entry.

## File history

Click on a date/time to view the file as it appeared at that time.

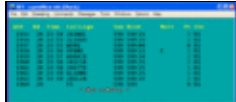
	Date/Time	Thumbnail	Dimensions	User	Comment
current	<a href="#">01:53, 15 February 2009</a>		617 × 280 (18 KB)	<a href="#">N6TV (talk   contribs)</a>	Win-Test Main window for log entry.

You cannot overwrite this file.

## File usage

The following page uses this file:

- [Menu:Windows](#)

## Namespaces

- [File](#)
- [Discussion](#)

## Variants

## Views

- [Read](#)
- [View source](#)
- [View history](#)

## More

- This page was last edited on 15 February 2009, at 01:53.

- [Privacy policy](#)
- [About Win-Test Wiki](#)
- [Disclaimers](#)



# File:LogEntryWindow.PNG

From Win-Test Wiki

[Jump to navigation](#) [Jump to search](#)

- [File](#)
- [File history](#)
- [File usage](#)

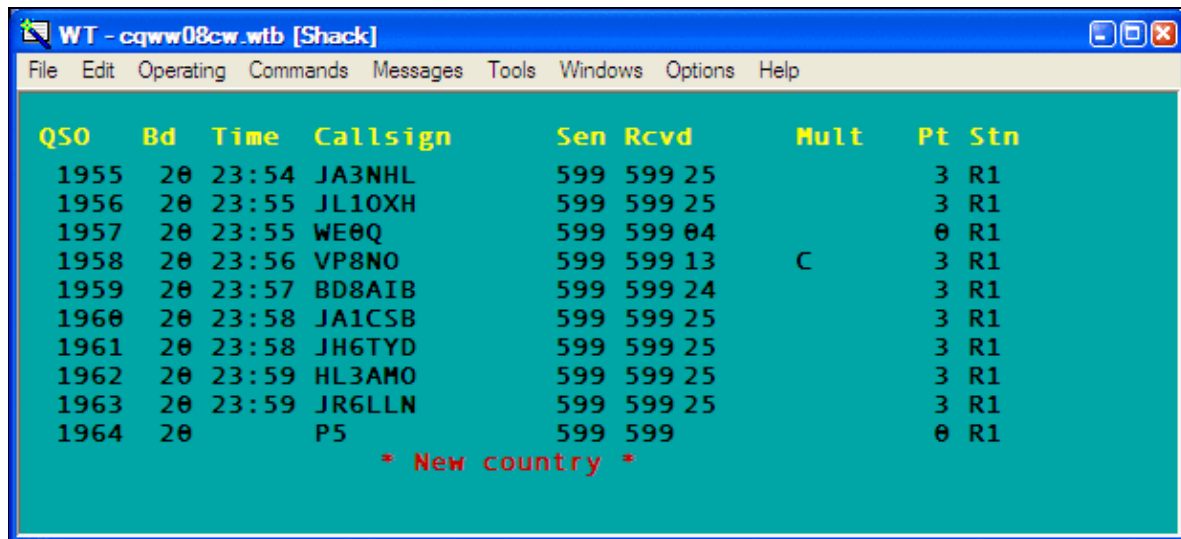

No higher resolution available.

[LogEntryWindow.PNG](#) (617 × 280 pixels, file size: 18 KB, MIME type: image/gif)

Win-Test Main window for log entry.

## File history

Click on a date/time to view the file as it appeared at that time.

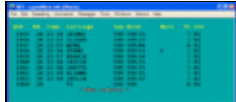
	Date/Time	Thumbnail	Dimensions	User	Comment
current	<a href="#">01:53, 15 February 2009</a>		617 × 280 (18 KB)	<a href="#">N6TV (talk   contribs)</a>	Win-Test Main window for log entry.

You cannot overwrite this file.

## File usage

The following page uses this file:

- [Menu:Windows](#)

## Namespaces

- [File](#)
- [Discussion](#)

## Variants

## Views

- [Read](#)
- [View source](#)
- [View history](#)

## More

- This page was last edited on 15 February 2009, at 01:53.
- [Privacy policy](#)
- [About Win-Test Wiki](#)
- [Disclaimers](#)



# File:LogFontSize.PNG

From Win-Test Wiki

[Jump to navigation](#) [Jump to search](#)

- [File](#)
- [File history](#)
- [File usage](#)
- [Metadata](#)

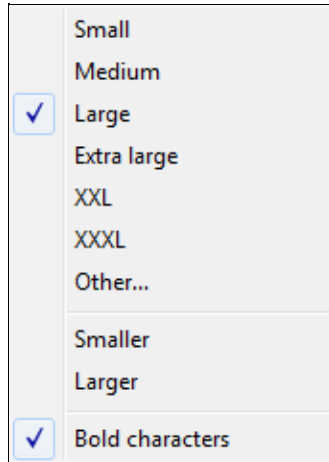

No higher resolution available.

[LogFontSize.PNG](#) (169 × 240 pixels, file size: 3 KB, MIME type: image/gif)

## File history

Click on a date/time to view the file as it appeared at that time.

	Date/Time	Thumbnail	Dimensions	User	Comment
current	<a href="#">13:23, 30 December 2021</a>		169 × 240 (3 KB)	<a href="#">Dl6rai</a> ( <a href="#">talk</a>   <a href="#">contribs</a> )	

You cannot overwrite this file.

## File usage

The following page uses this file:

- [Menu:Windows](#)

## Metadata

This file contains additional information, probably added from the digital camera or scanner used to create or digitize it.

If the file has been modified from its original state, some details may not fully reflect the modified file.

**Horizontal resolution** 37.79 dpc

**Vertical resolution** 37.79 dpc

## Namespaces

- [File](#)
- [Discussion](#)

## Variants

## Views

- [Read](#)
- [View source](#)
- [View history](#)

## More

- This page was last edited on 30 December 2021, at 13:23.

- [Privacy policy](#)
- [About Win-Test Wiki](#)
- [Disclaimers](#)

- The logo consists of a yellow sun icon on the left, followed by the text "Powered By" in a small font, and "MediaWiki" in a larger font below it, all contained within a thin black rectangular border.



# File:LogFontSize.PNG

From Win-Test Wiki

[Jump to navigation](#) [Jump to search](#)

- [File](#)
- [File history](#)
- [File usage](#)
- [Metadata](#)

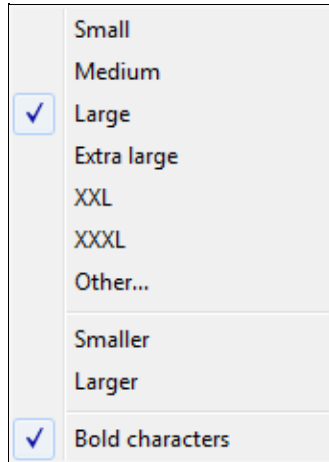

No higher resolution available.

[LogFontSize.PNG](#) (169 × 240 pixels, file size: 3 KB, MIME type: image.gif)

## File history

Click on a date/time to view the file as it appeared at that time.

	Date/Time	Thumbnail	Dimensions	User	Comment
current	<a href="#">13:23, 30 December 2021</a>		169 × 240 (3 KB)	<a href="#">Dl6rai</a> ( <a href="#">talk</a>   <a href="#">contribs</a> )	

You cannot overwrite this file.

## File usage

The following page uses this file:

- [Menu:Windows](#)

## Metadata

This file contains additional information, probably added from the digital camera or scanner used to create or digitize it.

If the file has been modified from its original state, some details may not fully reflect the modified file.

**Horizontal resolution** 37.79 dpc

**Vertical resolution** 37.79 dpc

## Namespaces

- [File](#)
- [Discussion](#)

## Variants

## Views

- [Read](#)
- [View source](#)
- [View history](#)

## More

- This page was last edited on 30 December 2021, at 13:23.

- [Privacy policy](#)
- [About Win-Test Wiki](#)
- [Disclaimers](#)

- The logo consists of a yellow sun icon on the left, followed by the text "Powered By" in a small font and "MediaWiki" in a larger font, all contained within a thin black rectangular border.

# File:log-qtcinfo.gif

From Win-Test Wiki

[Jump to navigation](#) [Jump to search](#)

- [File](#)
- [File history](#)
- [File usage](#)

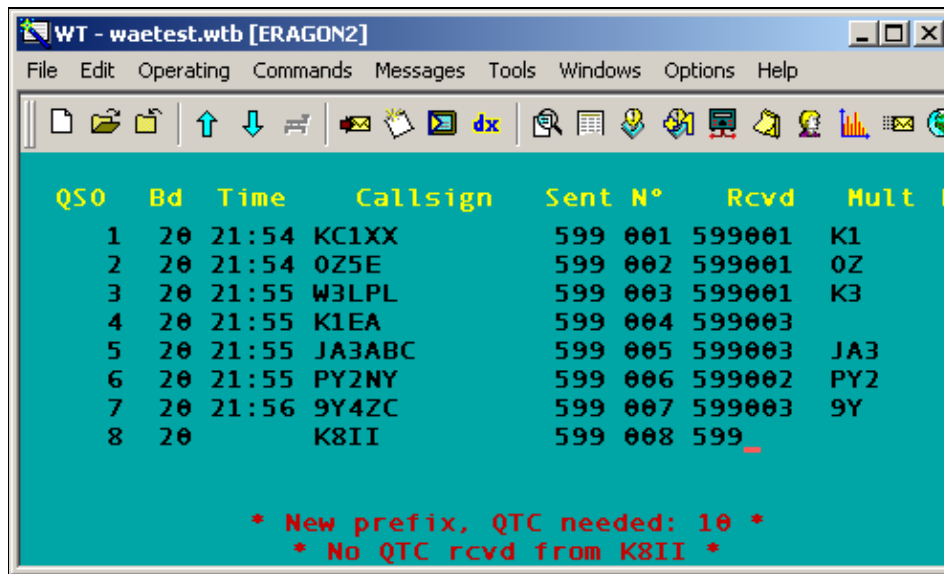

No higher resolution available.

[log-qtcinfo.gif](#) (495 × 297 pixels, file size: 12 KB, MIME type: image/gif)

WAE QTC INFOS while logging

## File history

Click on a date/time to view the file as it appeared at that time.

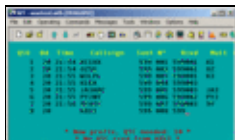
	Date/Time	Thumbnail	Dimensions	User	Comment
current	<a href="#">22:02, 23 July 2006</a>		495 × 297 (12 KB)	<a href="#">Dl4ner (talk   contribs)</a>	WAE QTC INFOS while logging

You cannot overwrite this file.

## File usage

The following page uses this file:

- [WAEDC](#)

## Namespaces

- [File](#)
- [Discussion](#)

## Variants

## Views

- [Read](#)
- [View source](#)
- [View history](#)

## More

- This page was last edited on 23 July 2006, at 22:02.
- [Privacy policy](#)
- [About Win-Test Wiki](#)
- [Disclaimers](#)



# File:log-qtcinfo.gif

From Win-Test Wiki

[Jump to navigation](#) [Jump to search](#)

- [File](#)
- [File history](#)
- [File usage](#)

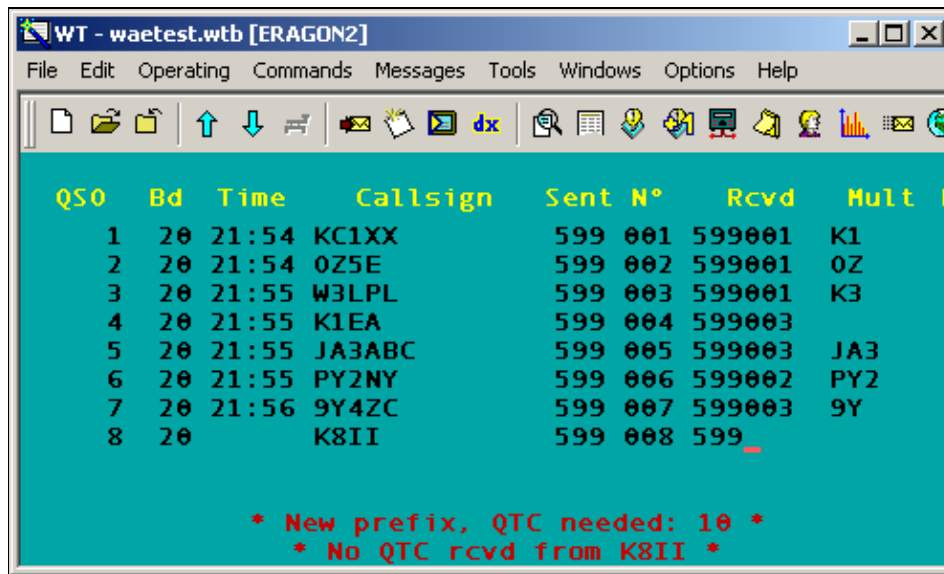

No higher resolution available.

[log-qtcinfo.gif](#) (495 × 297 pixels, file size: 12 KB, MIME type: image/gif)

WAE QTC INFOS while logging

## File history

Click on a date/time to view the file as it appeared at that time.

	Date/Time	Thumbnail	Dimensions	User	Comment
current	<a href="#">22:02, 23 July 2006</a>		495 × 297 (12 KB)	<a href="#">Dl4ner (talk   contribs)</a>	WAE QTC INFOS while logging

You cannot overwrite this file.

## File usage

The following page uses this file:

- [WAEDC](#)

## Namespaces

- [File](#)
- [Discussion](#)

## Variants

## Views

- [Read](#)
- [View source](#)
- [View history](#)

## More

- This page was last edited on 23 July 2006, at 22:02.
- [Privacy policy](#)
- [About Win-Test Wiki](#)
- [Disclaimers](#)



# File:LogSpecificExtraDataFiles.gif

From Win-Test Wiki

[Jump to navigation](#) [Jump to search](#)

- [File](#)
- [File history](#)
- [File usage](#)

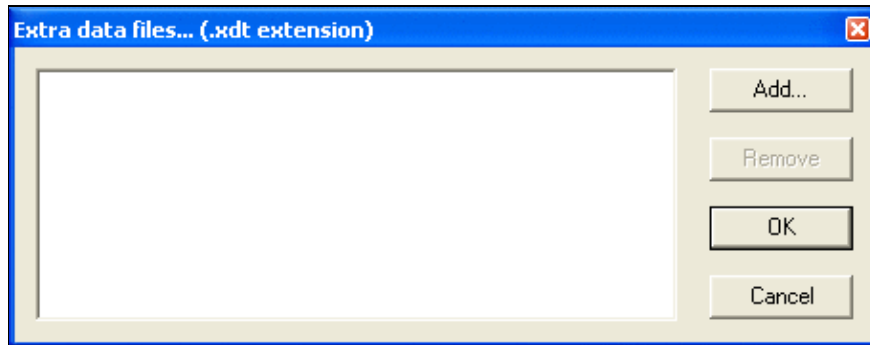

No higher resolution available.

[LogSpecificExtraDataFiles.gif](#) (455 Å 178 pixels, file size: 6 KB, MIME type: image.gif)

## File history

Click on a date/time to view the file as it appeared at that time.

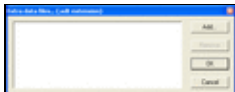
	Date/Time	Thumbnail	Dimensions	User	Comment
current	<a href="#">14:28, 26 March 2007</a>		455 Å 178 (6 KB)	<a href="#">I2WIJ</a> ( <a href="#">talk</a>   <a href="#">contribs</a> )	

You cannot overwrite this file.

## File usage

The following page uses this file:

- [Menu:Windows](#)

## Namespaces

- [File](#)
- [Discussion](#)

## Variants

## Views

- [Read](#)
- [View source](#)
- [View history](#)

## More

- This page was last edited on 26 March 2007, at 14:28.

- [Privacy policy](#)
- [About Win-Test Wiki](#)
- [Disclaimers](#)





# File:LogSpecificExtraDataFiles.gif

From Win-Test Wiki

[Jump to navigation](#) [Jump to search](#)

- [File](#)
- [File history](#)
- [File usage](#)

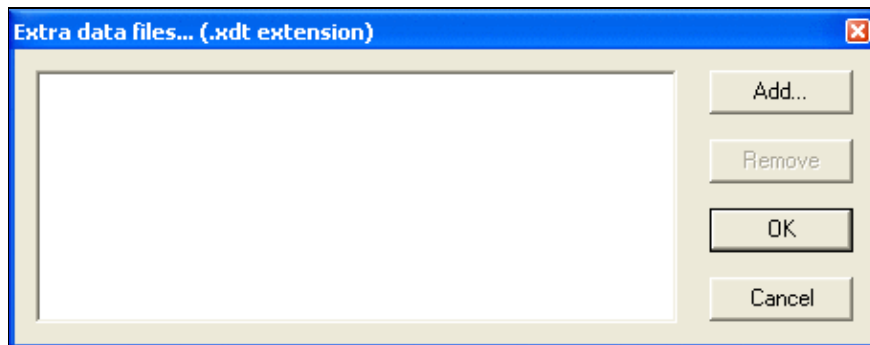

No higher resolution available.

[LogSpecificExtraDataFiles.gif](#) (455 Å 178 pixels, file size: 6 KB, MIME type: image.gif)

## File history

Click on a date/time to view the file as it appeared at that time.

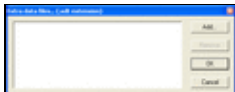
	Date/Time	Thumbnail	Dimensions	User	Comment
current	<a href="#">14:28, 26 March 2007</a>		455 Å 178 (6 KB)	<a href="#">I2WIJ</a> ( <a href="#">talk</a>   <a href="#">contribs</a> )	

You cannot overwrite this file.

## File usage

The following page uses this file:

- [Menu:Windows](#)

## Namespaces

- [File](#)
- [Discussion](#)

## Variants

## Views

- [Read](#)
- [View source](#)
- [View history](#)

## More

- This page was last edited on 26 March 2007, at 14:28.

- [Privacy policy](#)
- [About Win-Test Wiki](#)
- [Disclaimers](#)



# File:lpt1-properties.gif

From Win-Test Wiki

[Jump to navigation](#) [Jump to search](#)

- [File](#)
- [File history](#)
- [File usage](#)

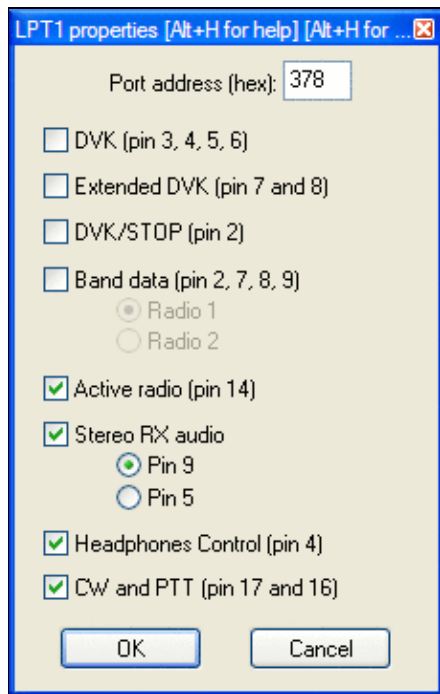



No higher resolution available.

[lpt1-properties.gif](#) (227 × 360 pixels, file size: 11 KB, MIME type: image/gif)

## File history

Click on a date/time to view the file as it appeared at that time.

	<b>Date/Time</b>	<b>Thumbnail</b>	<b>Dimensions</b>	<b>User</b>	<b>Comment</b>
current	<a href="#">04:50, 3 July 2011</a>		227 × 360 (11 KB)	<a href="#">N6TV (talk   contribs)</a>	Changed to Windows XP look instead of Windows 7

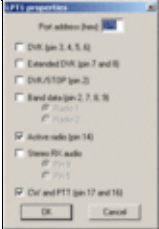
Date/Time	Thumbnail	Dimensions	User	Comment
<u>04:14, 3 July 2011</u>		237 Å 372 (15 KB)	<u>N6TV</u> ( <a href="#">talk</a>   <a href="#">contribs</a> )	Updated with dialog that includes Headphones Control on Pin 4.
<u>21:11, 26 July 2006</u>		227 Å 334 (5 KB)	<u>DL4NER</u> ( <a href="#">talk</a>   <a href="#">contribs</a> )	

You cannot overwrite this file.

## File usage

The following page uses this file:

- [Menu:Options](#)

## Namespaces

- [File](#)
- [Discussion](#)

## Variants

## Views

- [Read](#)
- [View source](#)
- [View history](#)

## More

- This page was last edited on 26 July 2006, at 21:11.

- [Privacy policy](#)
- [About Win-Test Wiki](#)
- [Disclaimers](#)



# File:LPT1Properties.gif

From Win-Test Wiki

[Jump to navigation](#) [Jump to search](#)

- [File](#)
- [File history](#)
- [File usage](#)

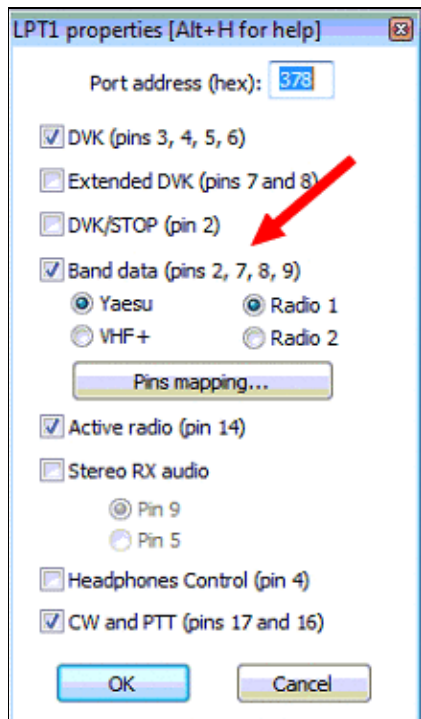

No higher resolution available.

[LPT1Properties.gif](#) (217 × 373 pixels, file size: 49 KB, MIME type: image/gif)

## File history

Click on a date/time to view the file as it appeared at that time.

	Date/Time	Thumbnail	Dimensions	User	Comment
current	<a href="#">16:34, 10 April 2023</a>		217 × 373 (49 KB)	<a href="#">Dl6rai</a> ( <a href="#">talk</a>   <a href="#">contribs</a> )	

**Date/Time**

**Thumbnail**

**Dimensions**

**User**

**Comment**

You cannot overwrite this file.

## File usage

The following page uses this file:

- [Interfaces](#)

## Namespaces

- [File](#)
- [Discussion](#)

## Variants

## Views

- [Read](#)
- [View source](#)
- [View history](#)

## More

- This page was last edited on 10 April 2023, at 16:34.

- [Privacy policy](#)
- [About Win-Test Wiki](#)
- [Disclaimers](#)

- 

# File:lpt1-properties.gif

From Win-Test Wiki

[Jump to navigation](#) [Jump to search](#)

- [File](#)
- [File history](#)
- [File usage](#)

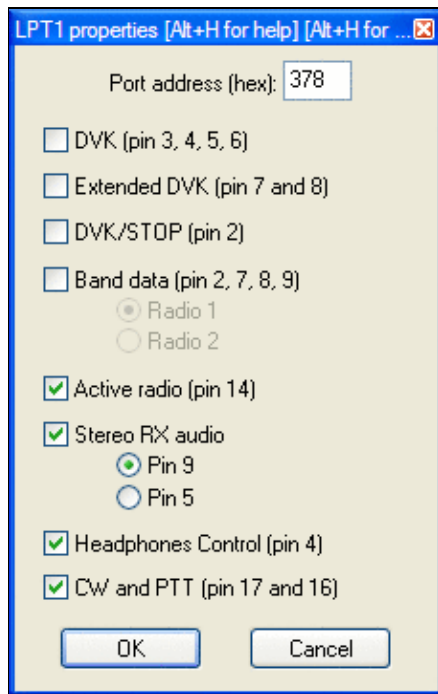



No higher resolution available.

[lpt1-properties.gif](#) (227 × 360 pixels, file size: 11 KB, MIME type: image/gif)

## File history

Click on a date/time to view the file as it appeared at that time.

	<b>Date/Time</b>	<b>Thumbnail</b>	<b>Dimensions</b>	<b>User</b>	<b>Comment</b>
current	<a href="#">04:50, 3 July 2011</a>		227 × 360 (11 KB)	<a href="#">N6TV (talk   contribs)</a>	Changed to Windows XP look instead of Windows 7

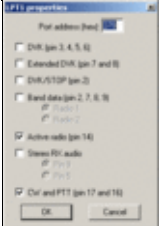
Date/Time	Thumbnail	Dimensions	User	Comment
<u>04:14, 3 July 2011</u>		237 Å 372 (15 KB)	<u>N6TV</u> ( <a href="#">talk</a>   <a href="#">contribs</a> )	Updated with dialog that includes Headphones Control on Pin 4.
<u>21:11, 26 July 2006</u>		227 Å 334 (5 KB)	<u>DL4NER</u> ( <a href="#">talk</a>   <a href="#">contribs</a> )	

You cannot overwrite this file.

## File usage

The following page uses this file:

- [Menu:Options](#)

## Namespaces

- [File](#)
- [Discussion](#)

## Variants

## Views

- [Read](#)
- [View source](#)
- [View history](#)

## More

- This page was last edited on 26 July 2006, at 21:11.

- [Privacy policy](#)
- [About Win-Test Wiki](#)
- [Disclaimers](#)





# File:LPT1Properties.gif

From Win-Test Wiki

[Jump to navigation](#) [Jump to search](#)

- [File](#)
- [File history](#)
- [File usage](#)

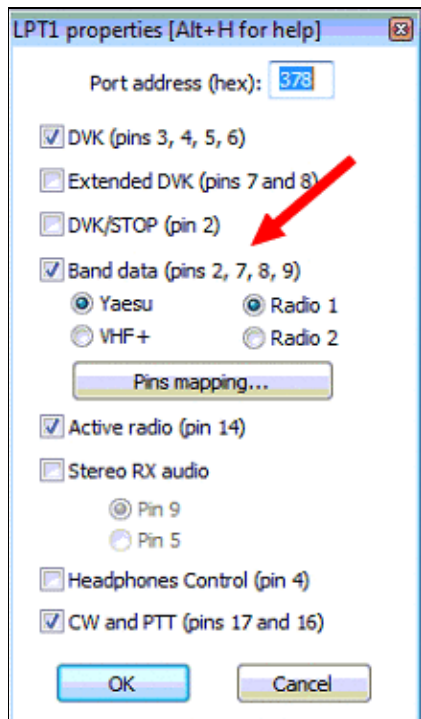

No higher resolution available.

[LPT1Properties.gif](#) (217 × 373 pixels, file size: 49 KB, MIME type: image/gif)

## File history

Click on a date/time to view the file as it appeared at that time.

	Date/Time	Thumbnail	Dimensions	User	Comment
current	<a href="#">16:34, 10 April 2023</a>		217 × 373 (49 KB)	<a href="#">Dl6rai</a> ( <a href="#">talk</a>   <a href="#">contribs</a> )	

**Date/Time**

**Thumbnail**

**Dimensions**

**User**

**Comment**

You cannot overwrite this file.

## File usage

The following page uses this file:

- [Interfaces](#)

## Namespaces

- [File](#)
- [Discussion](#)

## Variants

## Views

- [Read](#)
- [View source](#)
- [View history](#)

## More

- This page was last edited on 10 April 2023, at 16:34.

- [Privacy policy](#)
- [About Win-Test Wiki](#)
- [Disclaimers](#)



# File:LTPinsMapping.gif

From Win-Test Wiki

[Jump to navigation](#) [Jump to search](#)

- [File](#)
- [File history](#)
- [File usage](#)
- [Metadata](#)

**Band Data**

Yaesu					Signal Pin DB25-F	VHF+				
Band	D7	D6	D5	D0		Band	D7	D6	D5	D0
160m	L	L	L	H		50	L	L	L	H
80m	L	L	H	L		70	L	L	H	L
40m	L	L	H	H		144	L	L	H	H
30m	L	H	L	L		220	L	H	L	L
20m	L	H	L	H		432	L	H	L	H
17m	L	H	H	L		900	L	H	H	L
15m	L	H	H	H		1296	L	H	H	H
12m	H	L	L	L		2320	H	L	L	L
10m	H	L	L	H		3400	H	L	L	H
50	H	L	H	L		5700	H	L	H	L
144	H	L	H	H		10G	H	L	H	H
432	H	H	L	L		24G	H	H	L	L
						47G	H	H	L	H
						76G	H	H	H	L
						122G	H	H	H	H

Nonstandard  
60m

- Pins 18 to 25 DB25-F = Ground  
- L = Low Level (0V)  
- H = High Level (+5V)

**OK**

WARNING: The maximum currents available from the LPT outputs are usually low (few mA). You must use transistors or interfacing IC to drive loads like relays.

No higher resolution available.

[LPTPinsMapping.gif](#) (414 × 476 pixels, file size: 26 KB, MIME type: image/gif)

## File history

Click on a date/time to view the file as it appeared at that time.

	Date/Time	Thumbnail	Dimensions	User	Comment
current	<a href="#">05:18, 10 April 2023</a>		414 × 476 (26 KB)	<a href="#">D16rai</a> ( <a href="#">talk</a>   <a href="#">contribs</a> )	

You cannot overwrite this file.

## File usage

The following page uses this file:

- [Interfaces](#)

## Metadata

This file contains additional information, probably added from the digital camera or scanner used to create or digitize it.

If the file has been modified from its original state, some details may not fully reflect the modified file.

**Horizontal resolution** 37.79 dpc

**Vertical resolution** 37.79 dpc

## Namespaces

- [File](#)
- [Discussion](#)

## Variants

## Views

- [Read](#)
- [View source](#)
- [View history](#)

## More

- This page was last edited on 10 April 2023, at 05:18.

- [Privacy policy](#)
- [About Win-Test Wiki](#)
- [Disclaimers](#)



# File:LPTPinsMapping.gif

From Win-Test Wiki

[Jump to navigation](#) [Jump to search](#)

- [File](#)
- [File history](#)
- [File usage](#)
- [Metadata](#)

**Band Data**

Yaesu					Signal Pin DB25-F	VHF+				
Band	D7	D6	D5	D0		Band	D7	D6	D5	D0
160m	L	L	L	H		50	L	L	L	H
80m	L	L	H	L		70	L	L	H	L
40m	L	L	H	H		144	L	L	H	H
30m	L	H	L	L		220	L	H	L	L
20m	L	H	L	H		432	L	H	L	H
17m	L	H	H	L		900	L	H	H	L
15m	L	H	H	H		1296	L	H	H	H
12m	H	L	L	L		2320	H	L	L	L
10m	H	L	L	H		3400	H	L	L	H
50	H	L	H	L		5700	H	L	H	L
144	H	L	H	H		10G	H	L	H	H
432	H	H	L	L		24G	H	H	L	L
						47G	H	H	L	H
						76G	H	H	H	L
						122G	H	H	H	H

Nonstandard  
60m **L L H H (40m)**

- Pins 18 to 25 DB25-F = Ground  
- L = Low Level (0V)  
- H = High Level (+5V)

**OK**

WARNING: The maximum currents available from the LPT outputs are usually low (few mA). You must use transistors or interfacing IC to drive loads like relays.

No higher resolution available.

[LPTPinsMapping.gif](#) (414 × 476 pixels, file size: 26 KB, MIME type: image/gif)

## File history

Click on a date/time to view the file as it appeared at that time.

	Date/Time	Thumbnail	Dimensions	User	Comment
current	<a href="#">05:18, 10 April 2023</a>		414 × 476 (26 KB)	<a href="#">Dl6rai</a> ( <a href="#">talk</a>   <a href="#">contribs</a> )	

You cannot overwrite this file.

## File usage

The following page uses this file:

- [Interfaces](#)

## Metadata

This file contains additional information, probably added from the digital camera or scanner used to create or digitize it.

If the file has been modified from its original state, some details may not fully reflect the modified file.

**Horizontal resolution** 37.79 dpc

**Vertical resolution** 37.79 dpc

## Namespaces

- [File](#)
- [Discussion](#)

## Variants

## Views

- [Read](#)
- [View source](#)
- [View history](#)

## More

- This page was last edited on 10 April 2023, at 05:18.

- [Privacy policy](#)
- [About Win-Test Wiki](#)
- [Disclaimers](#)





# File:LPTSettingsForDXDoubler.gif

From Win-Test Wiki

[Jump to navigation](#) [Jump to search](#)

- [File](#)
- [File history](#)
- [File usage](#)

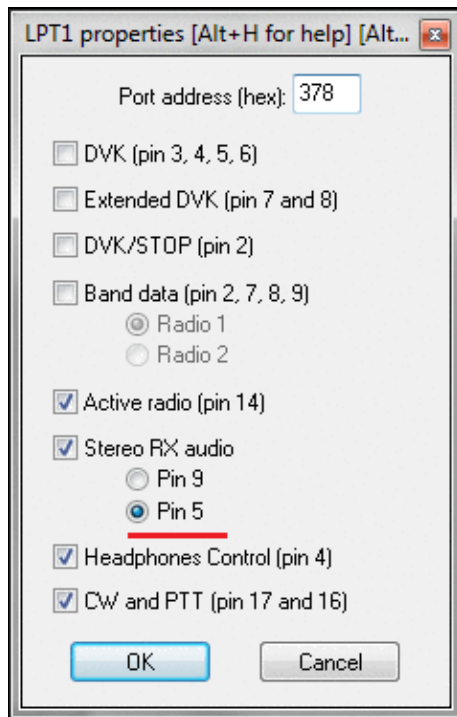

No higher resolution available.

[LPTSettingsForDXDoubler.gif](#) (237 × 372 pixels, file size: 16 KB, MIME type: image/gif)

Configuring the Win-Test LPT port for use with the DX Doubler.

## File history

Click on a date/time to view the file as it appeared at that time.

	Date/Time	Thumbnail	Dimensions	User	Comment
current	<a href="#">22:05, 12 November 2011</a>		237 × 372 (16 KB)	<a href="#">N6TV</a> ( <a href="#">talk</a>   <a href="#">contribs</a> )	Configuring the Win-Test LPT port for use with the DX Doubler.

Date/Time	Thumbnail	Dimensions	User	Comment
You cannot overwrite this file.				

## File usage

The following page uses this file:

- [Supported Accessories](#)

## Namespaces

- [File](#)
- [Discussion](#)

## Variants

## Views

- [Read](#)
- [View source](#)
- [View history](#)

## More

- This page was last edited on 12 November 2011, at 22:05.

- [Privacy policy](#)
- [About Win-Test Wiki](#)
- [Disclaimers](#)

- The logo consists of a yellow sun icon on the left, followed by the text "Powered By" in a small font, and "MediaWiki" in a larger font below it, all enclosed in a thin black rectangular border.

# File:LPTSettingsForDXDoubler.gif

From Win-Test Wiki

[Jump to navigation](#) [Jump to search](#)

- [File](#)
- [File history](#)
- [File usage](#)

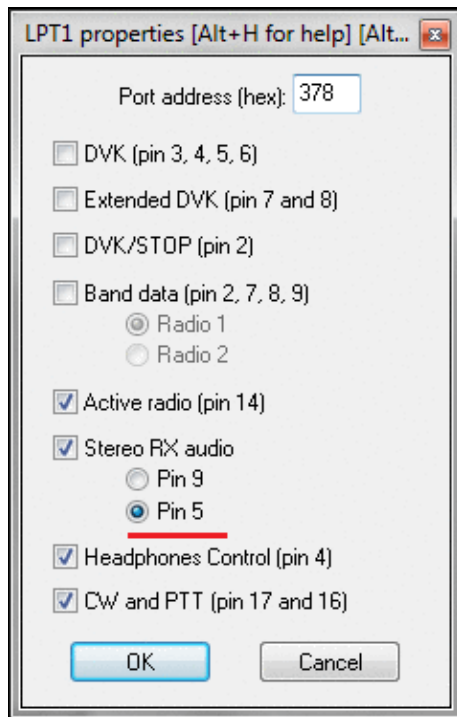

No higher resolution available.

[LPTSettingsForDXDoubler.gif](#) (237 × 372 pixels, file size: 16 KB, MIME type: image/gif)

Configuring the Win-Test LPT port for use with the DX Doubler.

## File history

Click on a date/time to view the file as it appeared at that time.

	Date/Time	Thumbnail	Dimensions	User	Comment
current	<a href="#">22:05, 12 November 2011</a>		237 × 372 (16 KB)	<a href="#">N6TV</a> ( <a href="#">talk</a>   <a href="#">contribs</a> )	Configuring the Win-Test LPT port for use with the DX Doubler.

Date/Time	Thumbnail	Dimensions	User	Comment
You cannot overwrite this file.				

## File usage

The following page uses this file:

- [Supported Accessories](#)

## Namespaces

- [File](#)
- [Discussion](#)

## Variants

## Views

- [Read](#)
- [View source](#)
- [View history](#)

## More

- This page was last edited on 12 November 2011, at 22:05.

- [Privacy policy](#)
- [About Win-Test Wiki](#)
- [Disclaimers](#)

- The logo consists of a small sun icon to the left of the text "Powered By MediaWiki".

# File:MergeFileSelect.PNG

From Win-Test Wiki

[Jump to navigation](#) [Jump to search](#)

- [File](#)
- [File history](#)
- [File usage](#)

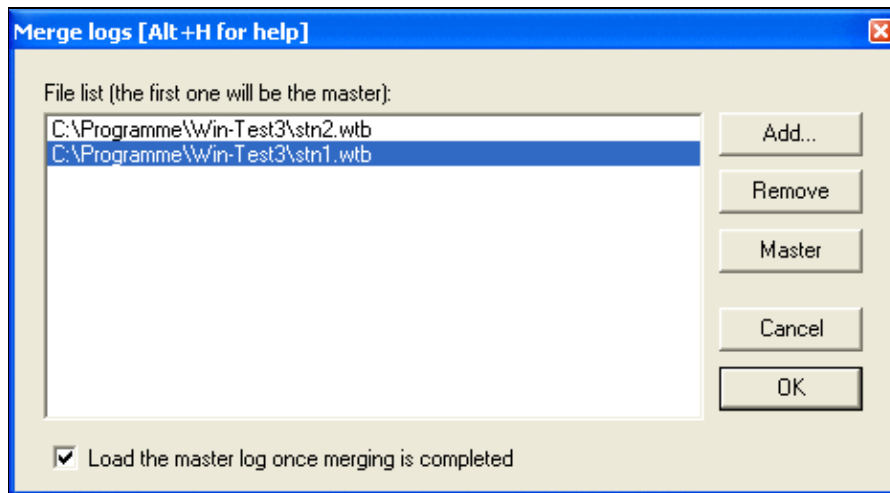



No higher resolution available.

[MergeFileSelect.PNG](#) (467 × 255 pixels, file size: 9 KB, MIME type: image.gif)

## File history

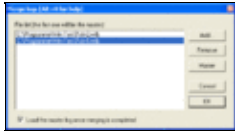
Click on a date/time to view the file as it appeared at that time.

	Date/Time	Thumbnail	Dimensions	User	Comment
current	<a href="#">12:21, 31 January 2009</a>		467 × 255 (9 KB)	<a href="#">Dl6rai</a> ( <a href="#">talk</a>   <a href="#">contribs</a> )	
	<a href="#">06:45, 15 June 2008</a>		467 × 255 (5 KB)	<a href="#">Dl6rai</a> ( <a href="#">talk</a>   <a href="#">contribs</a> )	

You cannot overwrite this file.

## File usage

The following page uses this file:

- [Menu:File new](#)

## Namespaces

- [File](#)
- [Discussion](#)

## Variants

## Views

- [Read](#)
- [View source](#)
- [View history](#)

## More

- This page was last edited on 15 June 2008, at 06:45.
- [Privacy policy](#)
- [About Win-Test Wiki](#)
- [Disclaimers](#)



# File:MergeFileSelect.PNG

From Win-Test Wiki

[Jump to navigation](#) [Jump to search](#)

- [File](#)
- [File history](#)
- [File usage](#)

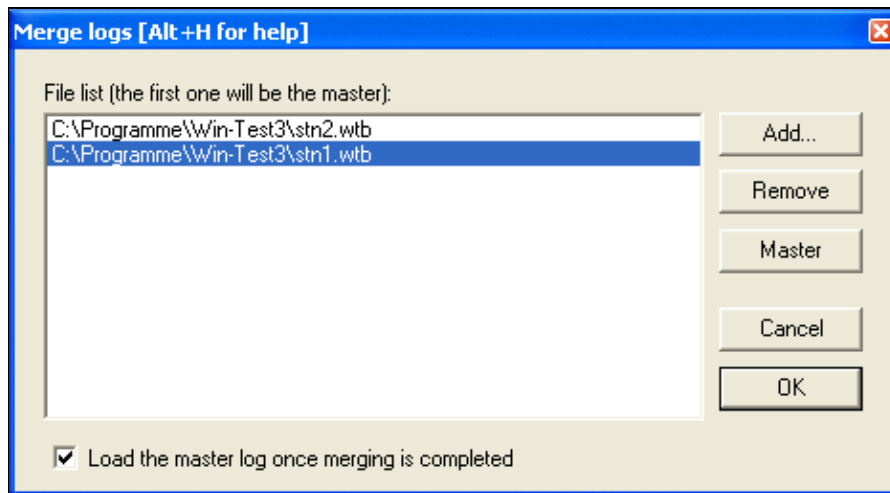



No higher resolution available.

[MergeFileSelect.PNG](#) (467 × 255 pixels, file size: 9 KB, MIME type: image.gif)

## File history

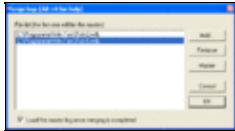
Click on a date/time to view the file as it appeared at that time.

	Date/Time	Thumbnail	Dimensions	User	Comment
current	<a href="#">12:21, 31 January 2009</a>		467 × 255 (9 KB)	<a href="#">Dl6rai</a> ( <a href="#">talk</a>   <a href="#">contribs</a> )	
	<a href="#">06:45, 15 June 2008</a>		467 × 255 (5 KB)	<a href="#">Dl6rai</a> ( <a href="#">talk</a>   <a href="#">contribs</a> )	

You cannot overwrite this file.

## File usage

The following page uses this file:

- [Menu:File new](#)

## Namespaces

- [File](#)
- [Discussion](#)

## Variants

## Views

- [Read](#)
- [View source](#)
- [View history](#)

## More

- This page was last edited on 15 June 2008, at 06:45.

- [Privacy policy](#)
- [About Win-Test Wiki](#)
- [Disclaimers](#)





# File:MergeFileStart.gif

From Win-Test Wiki

[Jump to navigation](#) [Jump to search](#)

- [File](#)
- [File history](#)
- [File usage](#)

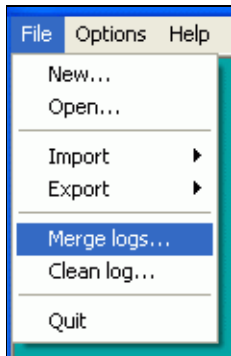

No higher resolution available.

[MergeFileStart.gif](#) (118 × 183 pixels, file size: 3 KB, MIME type: image/gif)

## File history

Click on a date/time to view the file as it appeared at that time.

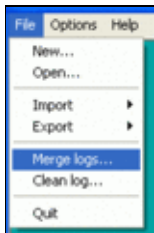
	Date/Time	Thumbnail	Dimensions	User	Comment
current	<a href="#">07:04, 3 December 2006</a>		118 × 183 (3 KB)	<a href="#">Dl6rai (talk   contribs)</a>	

You cannot overwrite this file.

## File usage

The following page uses this file:

- [Menu:File new](#)

## Namespaces

- [File](#)
- [Discussion](#)

## Variants

## Views

- [Read](#)
- [View source](#)
- [View history](#)

## More

- This page was last edited on 3 December 2006, at 07:04.

- [Privacy policy](#)
- [About Win-Test Wiki](#)
- [Disclaimers](#)



# File:MergeFileStart.gif

From Win-Test Wiki

[Jump to navigation](#) [Jump to search](#)

- [File](#)
- [File history](#)
- [File usage](#)

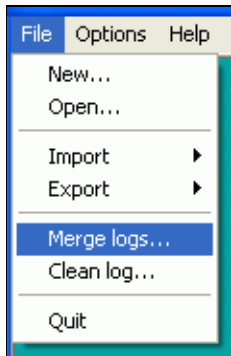

No higher resolution available.

[MergeFileStart.gif](#) (118 × 183 pixels, file size: 3 KB, MIME type: image/gif)

## File history

Click on a date/time to view the file as it appeared at that time.

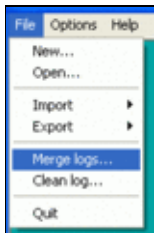
	Date/Time	Thumbnail	Dimensions	User	Comment
current	<a href="#">07:04, 3 December 2006</a>		118 × 183 (3 KB)	<a href="#">Dl6rai (talk   contribs)</a>	

You cannot overwrite this file.

## File usage

The following page uses this file:

- [Menu:File new](#)

## Namespaces

- [File](#)
- [Discussion](#)

## Variants

## Views

- [Read](#)
- [View source](#)
- [View history](#)

## More

- This page was last edited on 3 December 2006, at 07:04.

- [Privacy policy](#)
- [About Win-Test Wiki](#)
- [Disclaimers](#)



# File:MergeUnableDifferentRules.gif

From Win-Test Wiki

[Jump to navigation](#) [Jump to search](#)

- [File](#)
- [File history](#)
- [File usage](#)

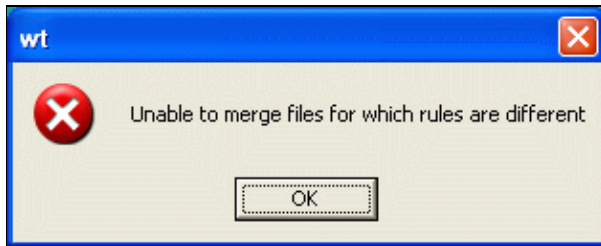

No higher resolution available.

[MergeUnableDifferentRules.gif](#) (314 × 126 pixels, file size: 8 KB, MIME type: image/gif)

## File history

Click on a date/time to view the file as it appeared at that time.

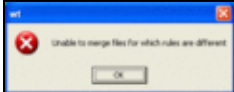
	Date/Time	Thumbnail	Dimensions	User	Comment
current	<a href="#">07:04, 3 December 2006</a>		314 × 126 (8 KB)	<a href="#">Dl6rai</a> ( <a href="#">talk</a>   <a href="#">contribs</a> )	

You cannot overwrite this file.

## File usage

The following page uses this file:

- [Menu:File new](#)

## Namespaces

- [File](#)
- [Discussion](#)

## Variants

## Views

- [Read](#)
- [View source](#)
- [View history](#)

## More

- This page was last edited on 3 December 2006, at 07:04.

- [Privacy policy](#)
- [About Win-Test Wiki](#)
- [Disclaimers](#)



# File:MergeUnableDifferentRules.gif

From Win-Test Wiki

[Jump to navigation](#) [Jump to search](#)

- [File](#)
- [File history](#)
- [File usage](#)

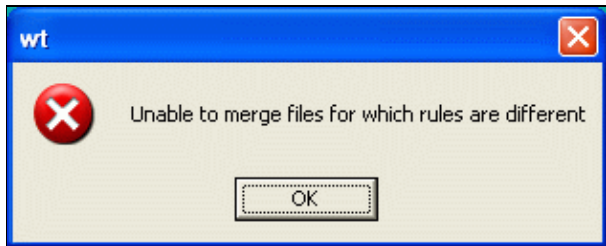

No higher resolution available.

[MergeUnableDifferentRules.gif](#) (314 × 126 pixels, file size: 8 KB, MIME type: image/gif)

## File history

Click on a date/time to view the file as it appeared at that time.

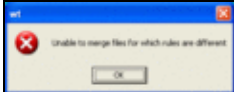
	Date/Time	Thumbnail	Dimensions	User	Comment
current	<a href="#">07:04, 3 December 2006</a>		314 × 126 (8 KB)	<a href="#">Dl6rai</a> ( <a href="#">talk</a>   <a href="#">contribs</a> )	

You cannot overwrite this file.

## File usage

The following page uses this file:

- [Menu:File new](#)

## Namespaces

- [File](#)
- [Discussion](#)

## Variants

## Views

- [Read](#)
- [View source](#)
- [View history](#)

## More

- This page was last edited on 3 December 2006, at 07:04.

- [Privacy policy](#)
- [About Win-Test Wiki](#)
- [Disclaimers](#)





# File:MicohamUsbInterfaceIC.PNG

From Win-Test Wiki

[Jump to navigation](#) [Jump to search](#)

- [File](#)
- [File history](#)
- [File usage](#)



No higher resolution available.

MicohamUsbInterfaceIC.PNG (800 Å 600 pixels, file size: 26 KB, MIME type: image.gif)

## File history

Click on a date/time to view the file as it appeared at that time.

	Date/Time	Thumbnail	Dimensions	User	Comment
current	<u>07:55, 17 May 2007</u>		800 Å 600 (26 KB)	<u>Dl6rai</u> ( <a href="#">talk</a>   <a href="#">contribs</a> )	

You cannot overwrite this file.

## File usage

The following file is a duplicate of this file ([more details](#)):

- [File:MicrohamUsbInterfaceIC.PNG](#)

There are no pages that use this file.

## Namespaces

- [File](#)
- [Discussion](#)

## Variants

## Views

- [Read](#)
- [View source](#)
- [View history](#)

## More

- This page was last edited on 17 May 2007, at 07:55.

- [Privacy policy](#)
- [About Win-Test Wiki](#)
- [Disclaimers](#)



# File:MicohamUsbInterfaceIC.PNG

From Win-Test Wiki

[Jump to navigation](#) [Jump to search](#)

- [File](#)
- [File history](#)
- [File usage](#)

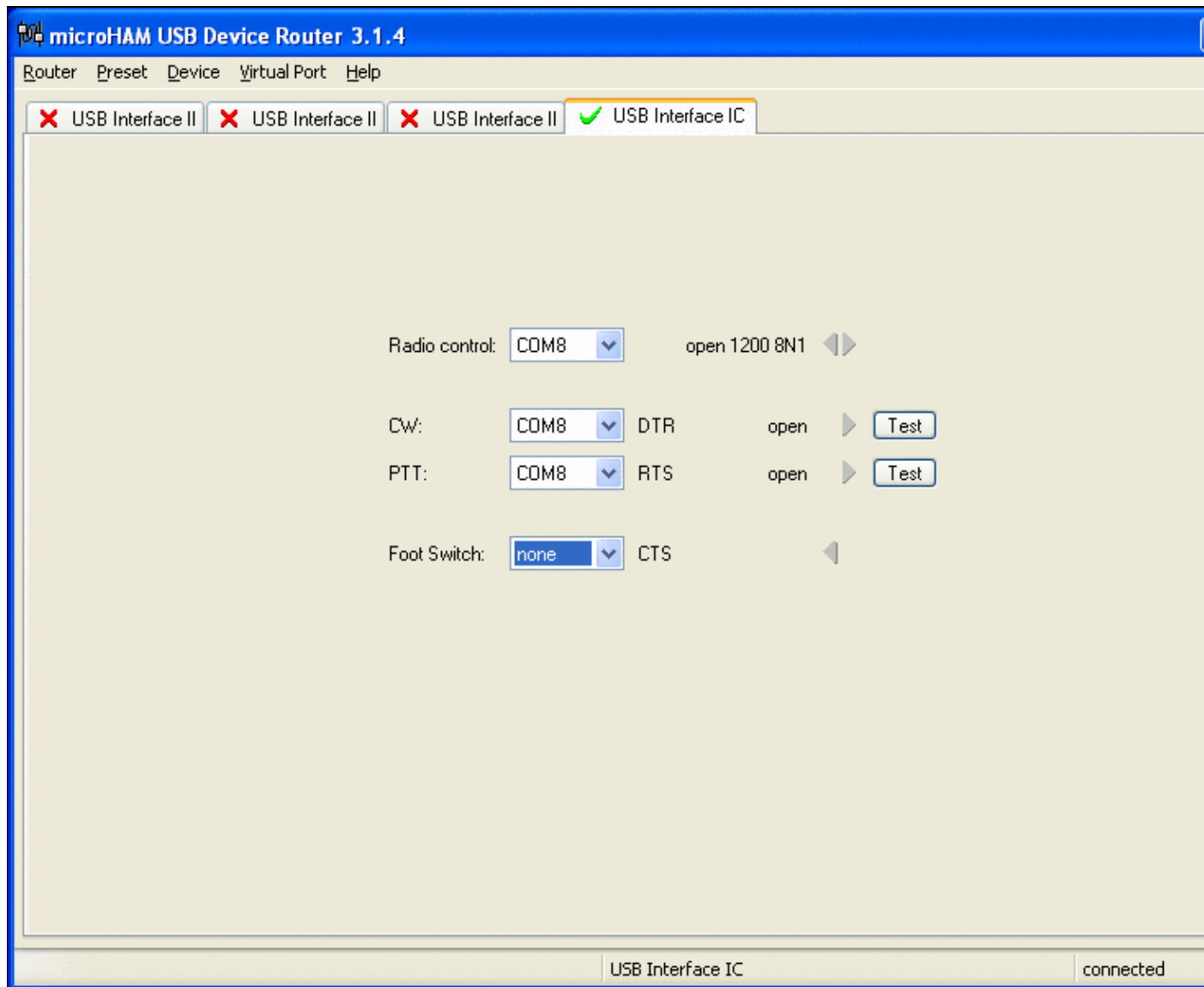

No higher resolution available.

MicohamUsbInterfaceIC.PNG (800 × 600 pixels, file size: 26 KB, MIME type: image.gif)

## File history

Click on a date/time to view the file as it appeared at that time.

	Date/Time	Thumbnail	Dimensions	User	Comment
current	<u>07:55, 17 May 2007</u>		800 × 600 (26 KB)	<u>Dl6rai</u> ( <a href="#">talk</a>   <a href="#">contribs</a> )	

You cannot overwrite this file.

## File usage

The following file is a duplicate of this file ([more details](#)):

- [File:MicrohamUsbInterfaceIC.PNG](#)

There are no pages that use this file.

## Namespaces

- [File](#)
- [Discussion](#)

## Variants

## Views

- [Read](#)
- [View source](#)
- [View history](#)

## More

- This page was last edited on 17 May 2007, at 07:55.

- [Privacy policy](#)
- [About Win-Test Wiki](#)
- [Disclaimers](#)



# File:MicrohamDeviceRouter.gif

From Win-Test Wiki

[Jump to navigation](#) [Jump to search](#)

- [File](#)
- [File history](#)
- [File usage](#)

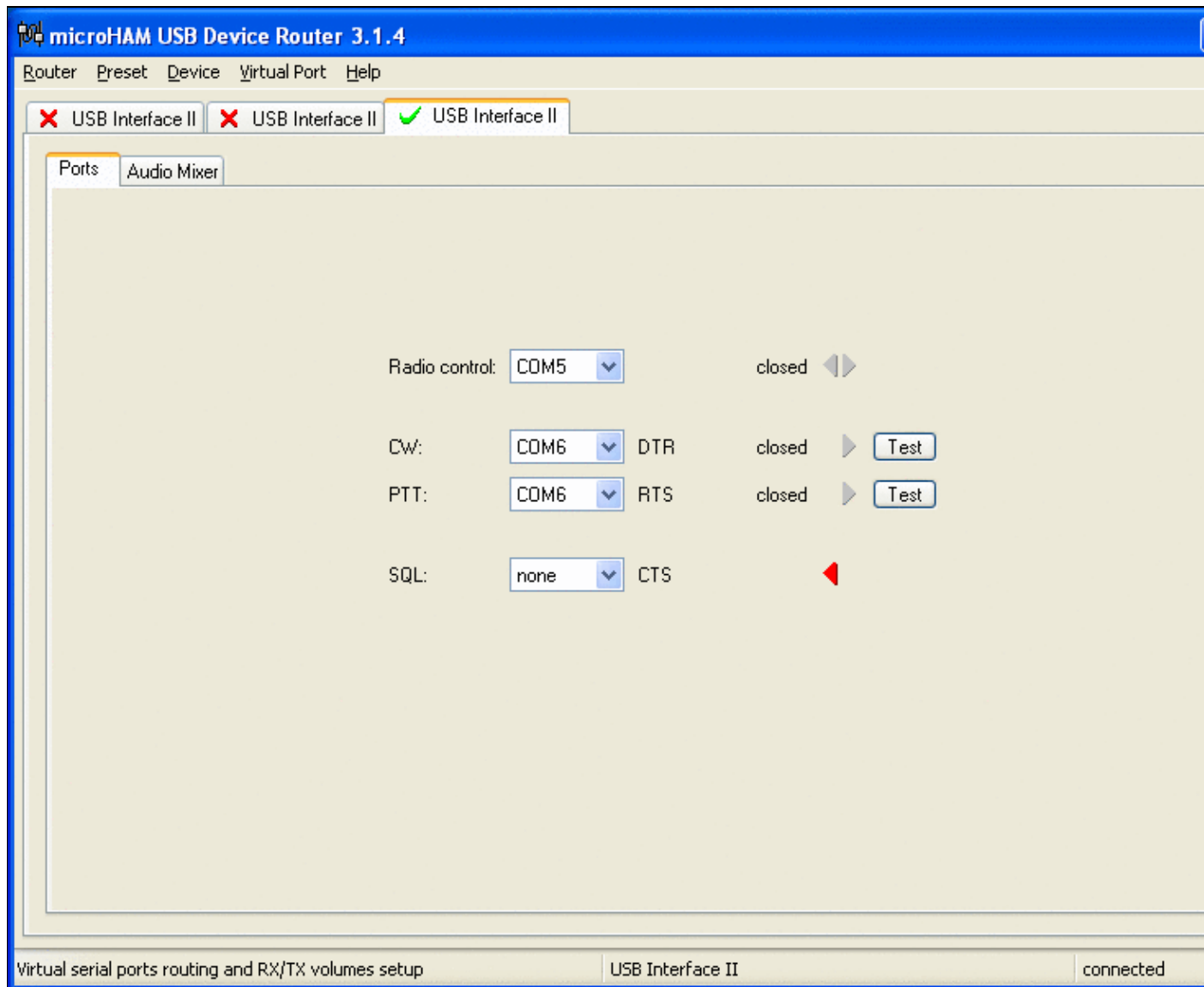

No higher resolution available.

[MicrohamDeviceRouter.gif](#) (800 × 600 pixels, file size: 28 KB, MIME type: image.gif)

## File history

Click on a date/time to view the file as it appeared at that time.

	Date/Time	Thumbnail	Dimensions	User	Comment
current	<a href="#">09:19, 4 January 2007</a>		800 × 600 (28 KB)	<a href="#">Dl6rai</a> ( <a href="#">talk</a>   <a href="#">contribs</a> )	

You cannot overwrite this file.

## File usage

The following page uses this file:

- [BestPractice1](#)

## Namespaces

- [File](#)
- [Discussion](#)

## Variants

## Views

- [Read](#)
- [View source](#)
- [View history](#)

## More

- This page was last edited on 4 January 2007, at 09:19.

- [Privacy policy](#)
- [About Win-Test Wiki](#)
- [Disclaimers](#)



# File:MicrohamDeviceRouter.gif

From Win-Test Wiki

[Jump to navigation](#) [Jump to search](#)

- [File](#)
- [File history](#)
- [File usage](#)

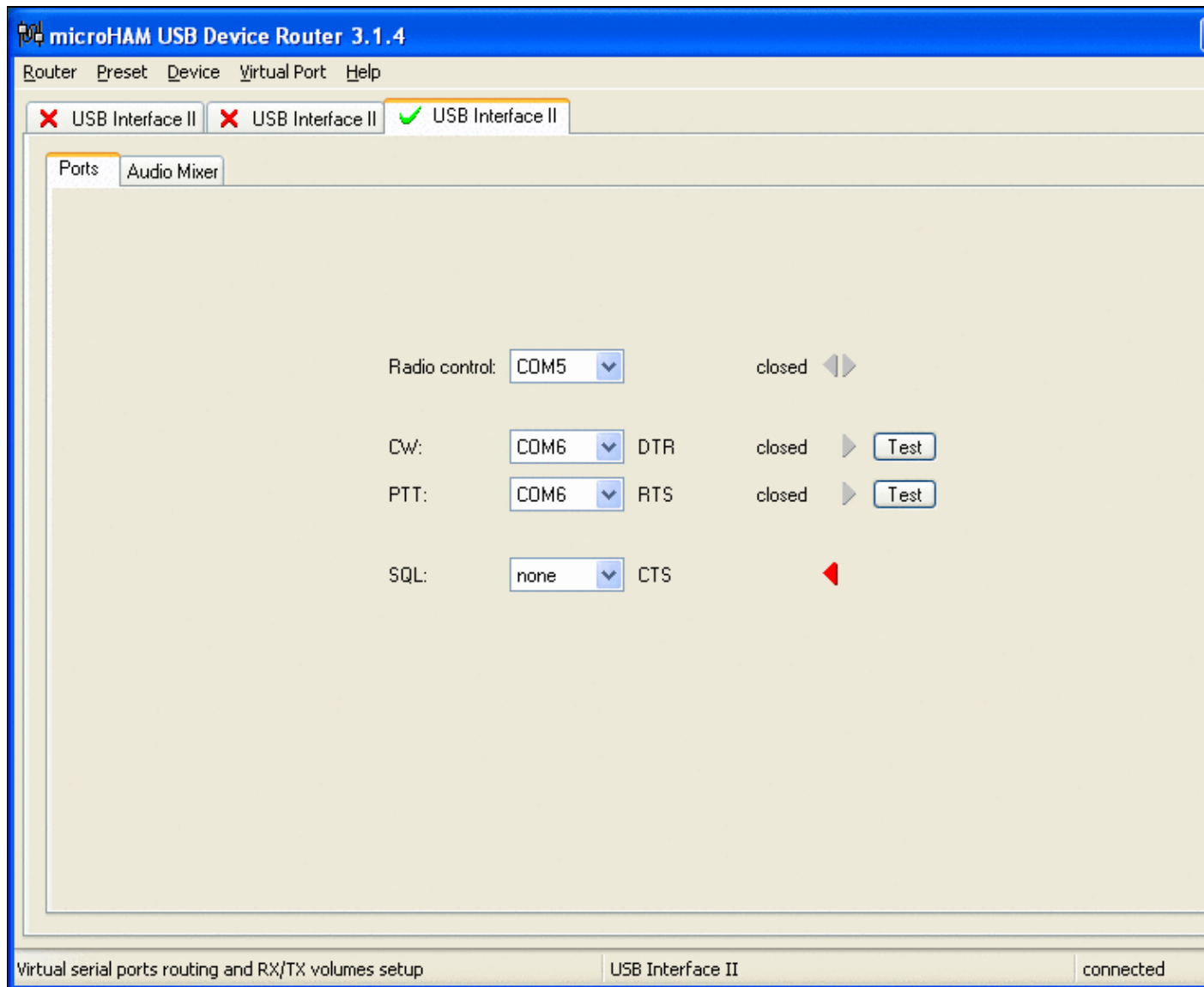

No higher resolution available.

[MicrohamDeviceRouter.gif](#) (800 × 600 pixels, file size: 28 KB, MIME type: image.gif)

## File history

Click on a date/time to view the file as it appeared at that time.

	Date/Time	Thumbnail	Dimensions	User	Comment
current	<a href="#">09:19, 4 January 2007</a>		800 × 600 (28 KB)	<a href="#">Dl6rai</a> ( <a href="#">talk</a>   <a href="#">contribs</a> )	

You cannot overwrite this file.

## File usage

The following page uses this file:

- [BestPractice1](#)

## Namespaces

- [File](#)
- [Discussion](#)

## Variants

## Views

- [Read](#)
- [View source](#)
- [View history](#)

## More

- This page was last edited on 4 January 2007, at 09:19.

- [Privacy policy](#)
- [About Win-Test Wiki](#)
- [Disclaimers](#)

- 



# File:MicrohamDeviceRouterMicrokeyer1.gif

From Win-Test Wiki

[Jump to navigation](#) [Jump to search](#)

- [File](#)
- [File history](#)
- [File usage](#)



No higher resolution available.

MicrohamDeviceRouterMicrokeyer1.gif (800 × 600 pixels, file size: 39 KB, MIME type: image.gif)

## File history

Click on a date/time to view the file as it appeared at that time.

	Date/Time	Thumbnail	Dimensions	User	Comment
current	<u>14:27, 17 November 2007</u>	Error creating thumbnail: File missing	800 × 600 (39 KB)	<u>Dl6rai</u> ( <u>talk</u>   <u>contribs</u> )	
	<u>04:08, 17 October 2007</u>		800 × 600 (23 KB)	<u>Dl6rai</u> ( <u>talk</u>   <u>contribs</u> )	

You cannot overwrite this file.

## File usage

The following page uses this file:

- BestPractice4

## Namespaces

- File
- Discussion

## Variants

## Views

- Read
- View source
- View history

## More

- This page was last edited on 17 October 2007, at 04:08.

- Privacy policy
- About Win-Test Wiki
- Disclaimers



# File:MicrohamDeviceRouterMicrokeyer1.gif

From Win-Test Wiki

[Jump to navigation](#) [Jump to search](#)

- [File](#)
- [File history](#)
- [File usage](#)



No higher resolution available.

MicrohamDeviceRouterMicrokeyer1.gif (800 × 600 pixels, file size: 39 KB, MIME type: image/gif)

## File history

Click on a date/time to view the file as it appeared at that time.

	Date/Time	Thumbnail	Dimensions	User	Comment
current	<u>14:27, 17 November 2007</u>	Error creating thumbnail: File missing	800 × 600 (39 KB)	<u>Dl6rai</u> ( <u>talk</u>   <u>contribs</u> )	
	<u>04:08, 17 October 2007</u>		800 × 600 (23 KB)	<u>Dl6rai</u> ( <u>talk</u>   <u>contribs</u> )	

You cannot overwrite this file.

## File usage

The following page uses this file:

- BestPractice4

## Namespaces

- File
- Discussion

## Variants

## Views

- Read
- View source
- View history

## More

- This page was last edited on 17 October 2007, at 04:08.

- Privacy policy
- About Win-Test Wiki
- Disclaimers



# File:MicrohamDeviceRouterMicrokeyer2.gif

From Win-Test Wiki

[Jump to navigation](#) [Jump to search](#)

- [File](#)
- [File history](#)
- [File usage](#)

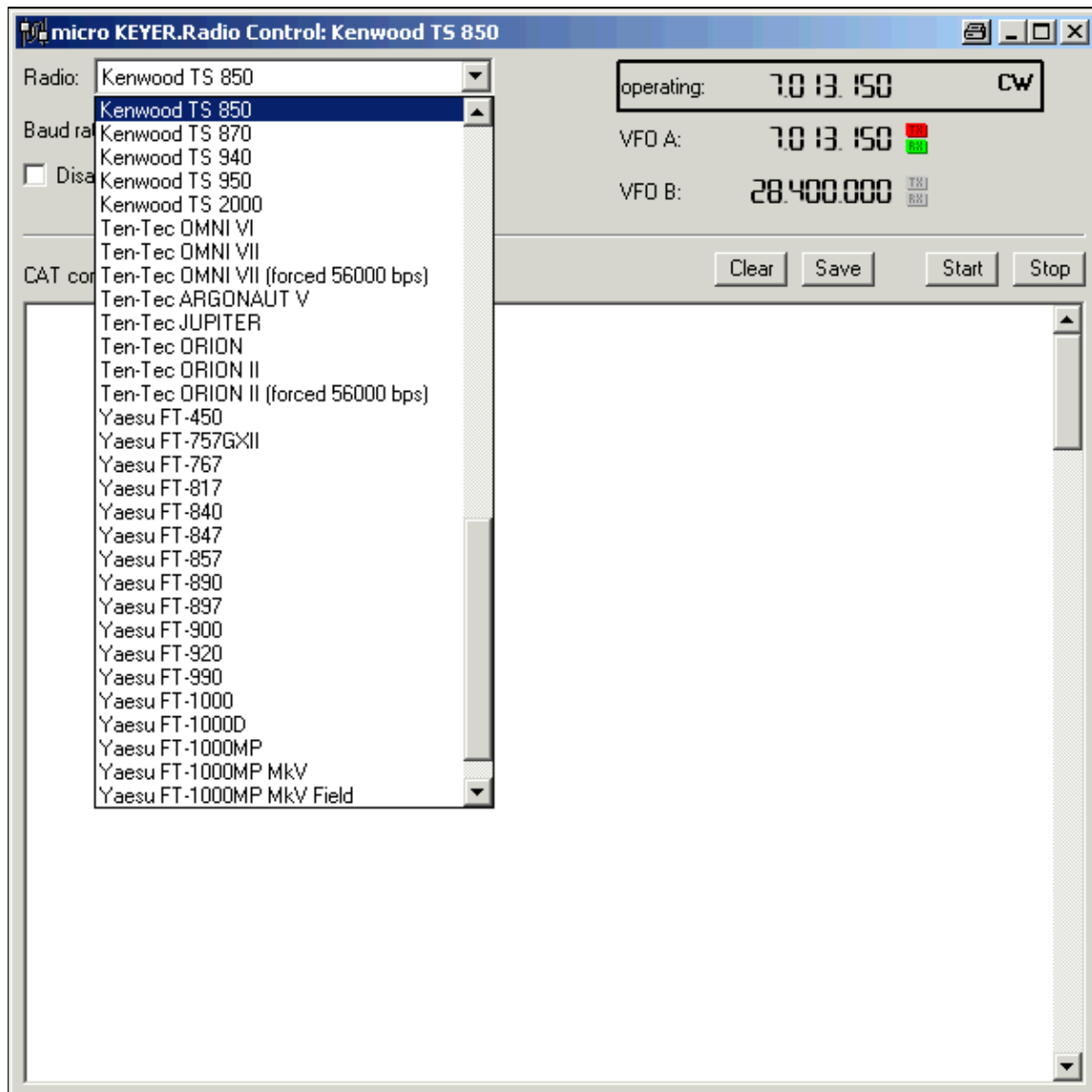

No higher resolution available.

MicrohamDeviceRouterMicrokeyer2.gif (599 × 599 pixels, file size: 23 KB, MIME type: image/gif)

## File history

Click on a date/time to view the file as it appeared at that time.

Date/Time	Thumbnail	Dimensions	User	Comment
current <a href="#">04:12, 17 October 2007</a>		599 × 599 (23 KB)	<a href="#">Dl6rai</a> ( <a href="#">talk</a>   <a href="#">contribs</a> )	

You cannot overwrite this file.

## File usage

The following 2 pages use this file:

- [BestPractice4](#)
- [BestPractice5](#)

## Namespaces

- [File](#)
- [Discussion](#)

## Variants

## Views

- [Read](#)
- [View source](#)
- [View history](#)

## More

- This page was last edited on 17 October 2007, at 04:12.

- [Privacy policy](#)
- [About Win-Test Wiki](#)
- [Disclaimers](#)



# File:MicrohamDeviceRouterMicrokeyer2-FT1000D.gif

From Win-Test Wiki

[Jump to navigation](#) [Jump to search](#)

- [File](#)
- [File history](#)
- [File usage](#)
- [Metadata](#)

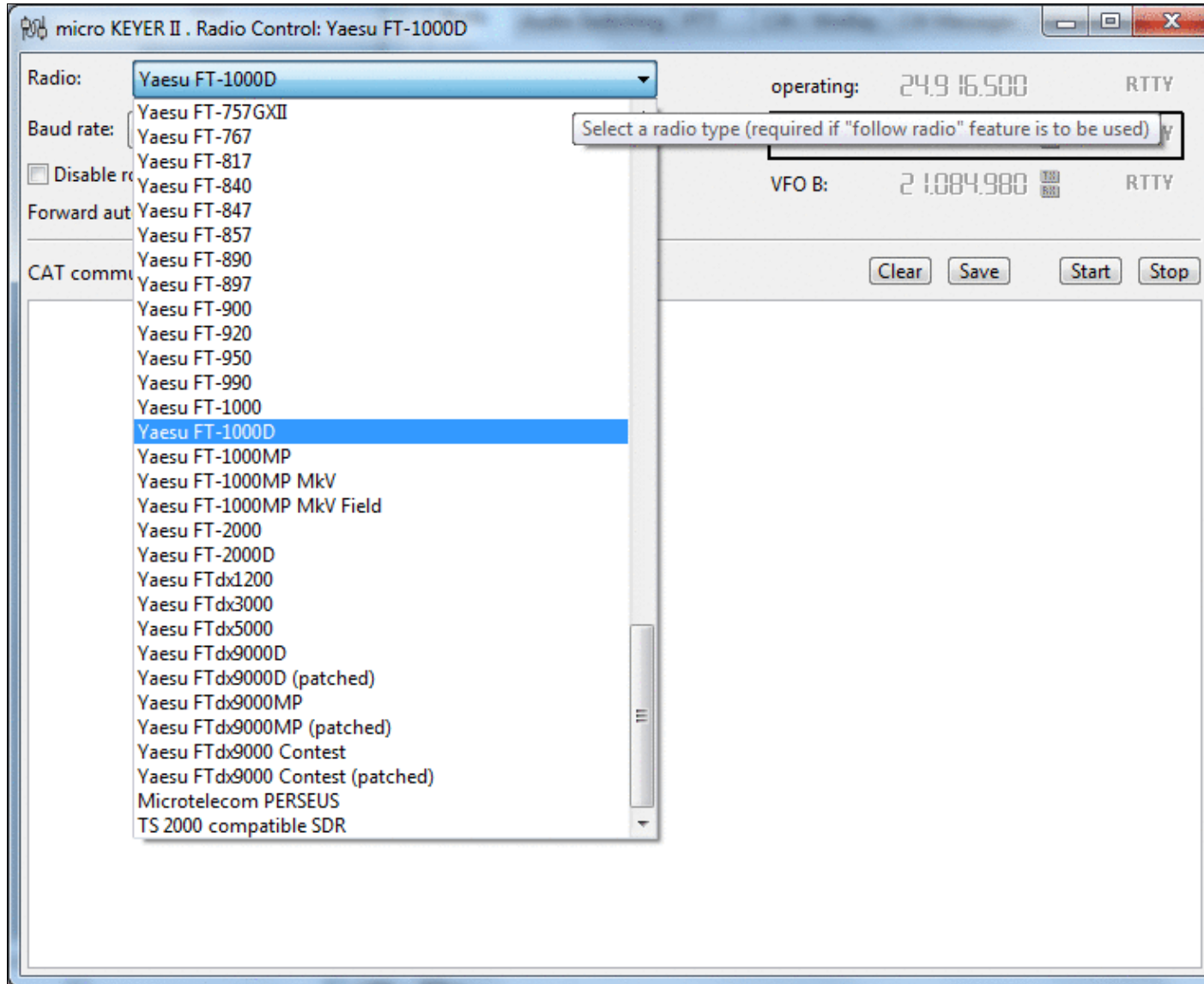

No higher resolution available.

[MicrohamDeviceRouterMicrokeyer2-FT1000D.gif](#) (740 × 600 pixels, file size: 68 KB, MIME type: image.gif)

## File history

Click on a date/time to view the file as it appeared at that time.

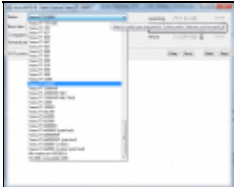
	Date/Time	Thumbnail	Dimensions	User	Comment
current	<a href="#">15:58, 18 April 2015</a>		740 × 600 (68 KB)	<a href="#">Dl6rai</a> ( <a href="#">talk</a>   <a href="#">contribs</a> )	

You cannot overwrite this file.

## File usage

The following page uses this file:

- [BestPractice6](#)

## Metadata

This file contains additional information, probably added from the digital camera or scanner used to create or digitize it.

If the file has been modified from its original state, some details may not fully reflect the modified file.

**Horizontal resolution** 37.79 dpc

**Vertical resolution** 37.79 dpc

## Namespaces

- [File](#)
- [Discussion](#)

## Variants

## Views

- [Read](#)
- [View source](#)
- [View history](#)



## More

- This page was last edited on 18 April 2015, at 15:58.

- [Privacy policy](#)
- [About Win-Test Wiki](#)
- [Disclaimers](#)



# File:MicrohamDeviceRouterMicrokeyer2-FT1000D.gif

From Win-Test Wiki

[Jump to navigation](#) [Jump to search](#)

- [File](#)
- [File history](#)
- [File usage](#)
- [Metadata](#)

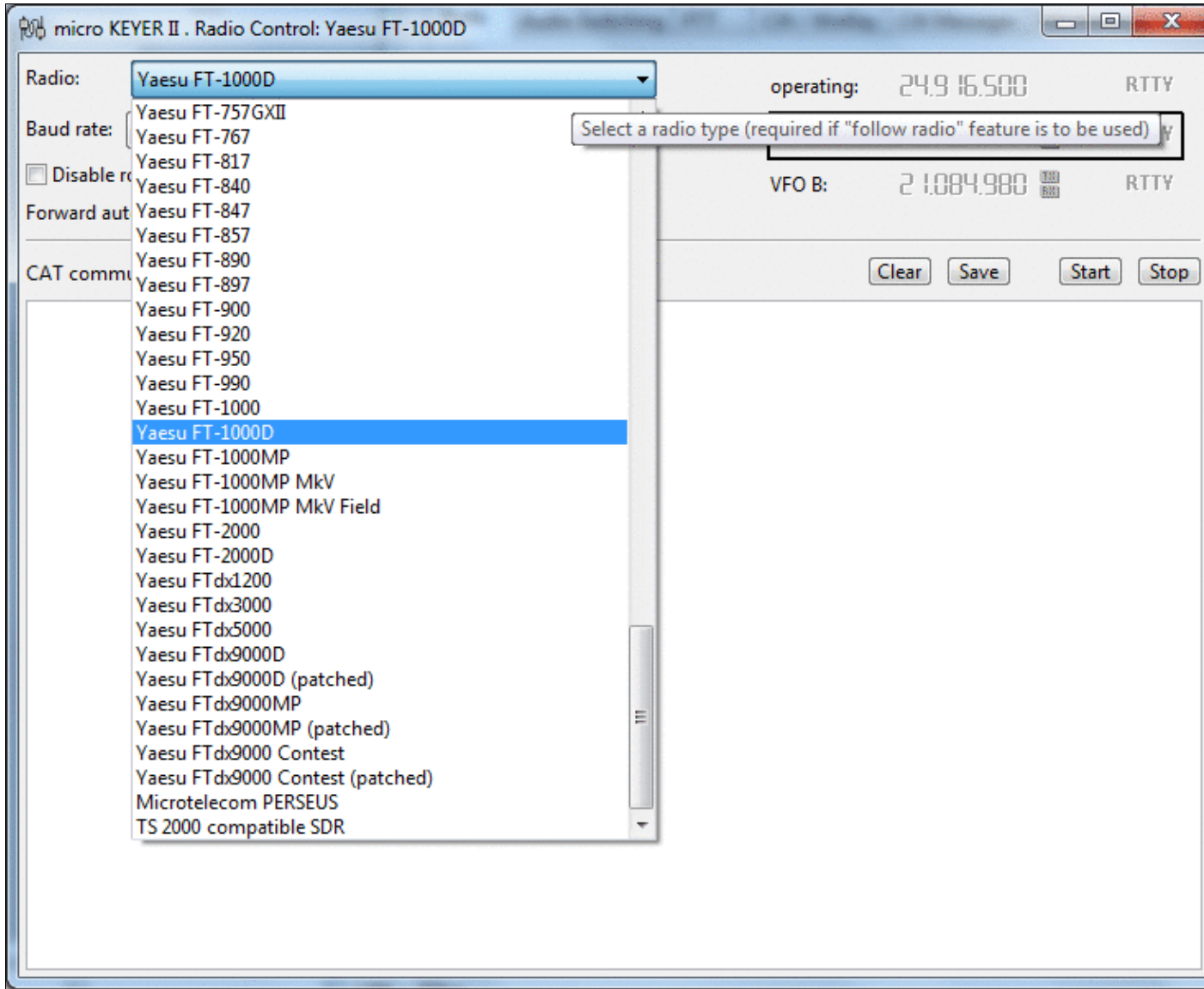

No higher resolution available.

[MicrohamDeviceRouterMicrokeyer2-FT1000D.gif](#) (740 × 600 pixels, file size: 68 KB, MIME type: image.gif)

## File history

Click on a date/time to view the file as it appeared at that time.

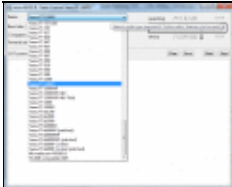
	Date/Time	Thumbnail	Dimensions	User	Comment
current	<a href="#">15:58, 18 April 2015</a>		740 × 600 (68 KB)	<a href="#">Dl6rai</a> ( <a href="#">talk</a>   <a href="#">contribs</a> )	

You cannot overwrite this file.

## File usage

The following page uses this file:

- [BestPractice6](#)

## Metadata

This file contains additional information, probably added from the digital camera or scanner used to create or digitize it.

If the file has been modified from its original state, some details may not fully reflect the modified file.

**Horizontal resolution** 37.79 dpc

**Vertical resolution** 37.79 dpc

## Namespaces

- [File](#)
- [Discussion](#)

## Variants

## Views

- [Read](#)
- [View source](#)
- [View history](#)

## More

- This page was last edited on 18 April 2015, at 15:58.

- [Privacy policy](#)
- [About Win-Test Wiki](#)
- [Disclaimers](#)



# File:MicrohamDeviceRouterMicrokeyer2.gif

From Win-Test Wiki

[Jump to navigation](#) [Jump to search](#)

- [File](#)
- [File history](#)
- [File usage](#)

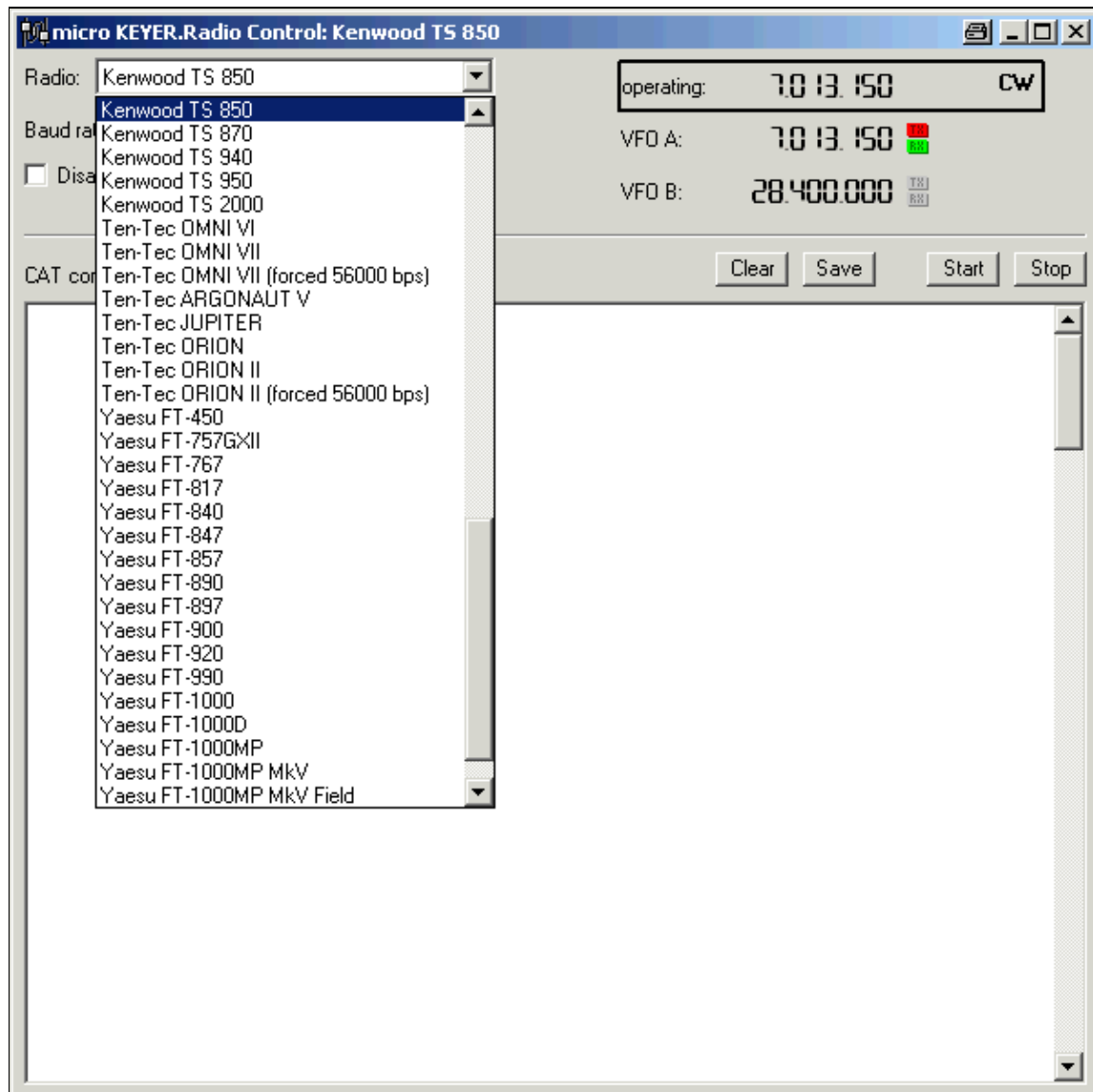

No higher resolution available.

MicrohamDeviceRouterMicrokeyer2.gif (599 × 599 pixels, file size: 23 KB, MIME type: image/gif)

## File history

Click on a date/time to view the file as it appeared at that time.

Date/Time	Thumbnail	Dimensions	User	Comment
current <a href="#">04:12, 17 October 2007</a>		599 × 599 (23 KB)	<a href="#">Dl6rai</a> ( <a href="#">talk</a>   <a href="#">contribs</a> )	

You cannot overwrite this file.

## File usage

The following 2 pages use this file:

- [BestPractice4](#)
- [BestPractice5](#)

## Namespaces

- [File](#)
- [Discussion](#)

## Variants

## Views

- [Read](#)
- [View source](#)
- [View history](#)

## More

- This page was last edited on 17 October 2007, at 04:12.

- [Privacy policy](#)
- [About Win-Test Wiki](#)
- [Disclaimers](#)



# File:MicrohamDeviceRouterMicrokeyer2-IC-7410.gif

From Win-Test Wiki

[Jump to navigation](#) [Jump to search](#)

- [File](#)
- [File history](#)
- [File usage](#)
- [Metadata](#)

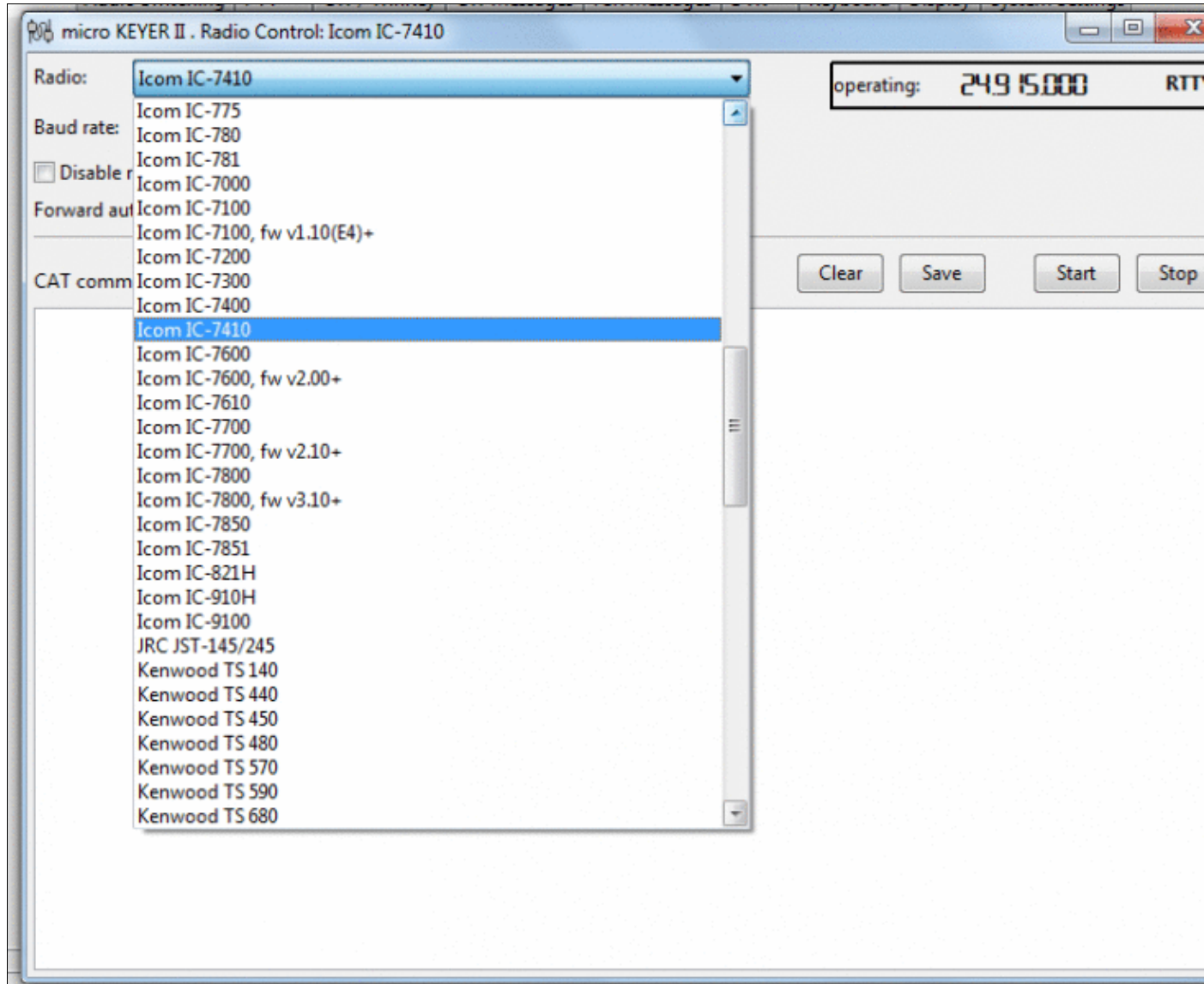

Size of this preview: [752 Å 600 pixels](#). Other resolutions: [301 Å 240 pixels](#) | [761 Å 607 pixels](#).  
[Original file](#) (761 Å 607 pixels, file size: 47 KB, MIME type: image.gif)

## File history

Click on a date/time to view the file as it appeared at that time.

	Date/Time	Thumbnail	Dimensions	User	Comment
current	<a href="#">15:42, 31 March 2020</a>		761 Å 607 (47 KB)	<a href="#">Dl6rai</a> ( <a href="#">talk</a>   <a href="#">contribs</a> )	

You cannot overwrite this file.

## File usage

The following 2 pages use this file:

- [BestPractice10](#)
- [BestPractice8](#)

## Metadata

This file contains additional information, probably added from the digital camera or scanner used to create or digitize it.

If the file has been modified from its original state, some details may not fully reflect the modified file.

**Horizontal resolution** 37.79 dpc

**Vertical resolution** 37.79 dpc

## Namespaces

- [File](#)
- [Discussion](#)

## Variants

## Views

- [Read](#)
- [View source](#)
- [View history](#)



## More

- This page was last edited on 31 March 2020, at 15:42.

- [Privacy policy](#)
- [About Win-Test Wiki](#)
- [Disclaimers](#)



# File:MicrohamDeviceRouterMicrokeyer2-IC-7410.gif

From Win-Test Wiki

[Jump to navigation](#) [Jump to search](#)

- [File](#)
- [File history](#)
- [File usage](#)
- [Metadata](#)

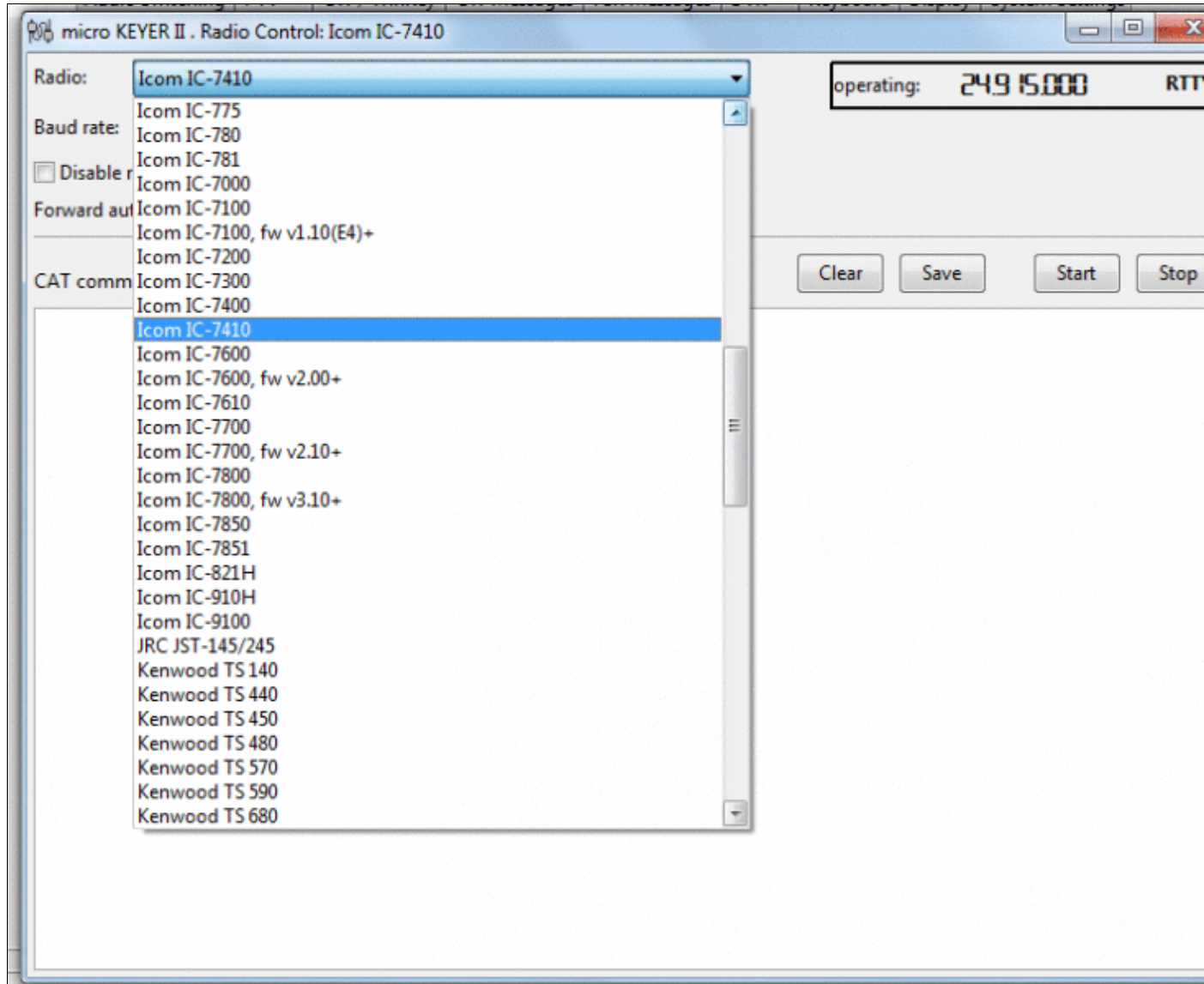

Size of this preview: [752 Å 600 pixels](#). Other resolutions: [301 Å 240 pixels](#) | [761 Å 607 pixels](#).  
[Original file](#) (761 Å 607 pixels, file size: 47 KB, MIME type: image.gif)

## File history

Click on a date/time to view the file as it appeared at that time.

	Date/Time	Thumbnail	Dimensions	User	Comment
current	<a href="#">15:42, 31 March 2020</a>		761 Å 607 (47 KB)	<a href="#">Dl6rai</a> ( <a href="#">talk</a>   <a href="#">contribs</a> )	

You cannot overwrite this file.

## File usage

The following 2 pages use this file:

- [BestPractice10](#)
- [BestPractice8](#)

## Metadata

This file contains additional information, probably added from the digital camera or scanner used to create or digitize it.

If the file has been modified from its original state, some details may not fully reflect the modified file.

**Horizontal resolution** 37.79 dpc

**Vertical resolution** 37.79 dpc

## Namespaces

- [File](#)
- [Discussion](#)

## Variants

## Views

- [Read](#)
- [View source](#)
- [View history](#)

## More

- This page was last edited on 31 March 2020, at 15:42.

- [Privacy policy](#)
- [About Win-Test Wiki](#)
- [Disclaimers](#)



# File:MicrohamDeviceRouterMicrokeyer3.gif

From Win-Test Wiki

[Jump to navigation](#) [Jump to search](#)

- [File](#)
- [File history](#)
- [File usage](#)



No higher resolution available.

[MicrohamDeviceRouterMicrokeyer3.gif](#) (800 × 600 pixels, file size: 33 KB, MIME type: image.gif)

## File history

Click on a date/time to view the file as it appeared at that time.

	Date/Time	Thumbnail	Dimensions	User	Comment
current	<a href="#">07:24, 18 November 2007</a>	Error creating thumbnail: File missing	800 × 600 (33 KB)	<a href="#">Dl6rai</a> ( <a href="#">talk</a>   <a href="#">contribs</a> )	
	<a href="#">04:26, 17 October 2007</a>		800 × 600 (45 KB)	<a href="#">Dl6rai</a> ( <a href="#">talk</a>   <a href="#">contribs</a> )	

You cannot overwrite this file.

## File usage

The following page uses this file:

- [BestPractice4](#)

## Namespaces

- [File](#)
- [Discussion](#)

## Variants

## Views

- [Read](#)
- [View source](#)
- [View history](#)

## More

- This page was last edited on 17 October 2007, at 04:26.

- [Privacy policy](#)
- [About Win-Test Wiki](#)
- [Disclaimers](#)



# File:MicrohamDeviceRouterMicrokeyer3.gif

From Win-Test Wiki

[Jump to navigation](#) [Jump to search](#)

- [File](#)
- [File history](#)
- [File usage](#)

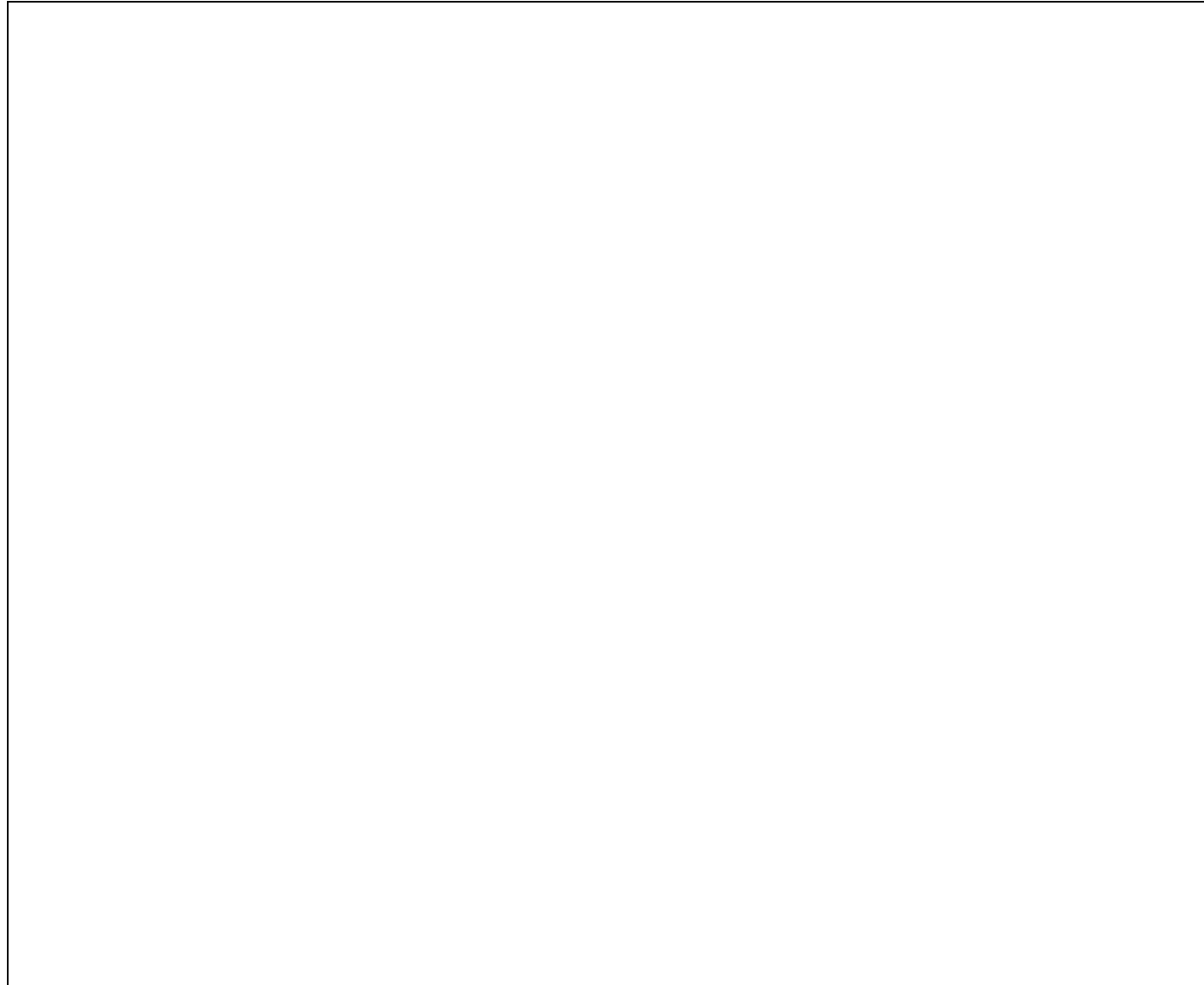

No higher resolution available.

[MicrohamDeviceRouterMicrokeyer3.gif](#) (800 × 600 pixels, file size: 33 KB, MIME type: image.gif)

## File history

Click on a date/time to view the file as it appeared at that time.

	Date/Time	Thumbnail	Dimensions	User	Comment
current	<a href="#">07:24, 18 November 2007</a>	Error creating thumbnail: File missing	800 × 600 (33 KB)	<a href="#">Dl6rai</a> ( <a href="#">talk</a>   <a href="#">contribs</a> )	
	<a href="#">04:26, 17 October 2007</a>		800 × 600 (45 KB)	<a href="#">Dl6rai</a> ( <a href="#">talk</a>   <a href="#">contribs</a> )	

You cannot overwrite this file.

## File usage

The following page uses this file:

- [BestPractice4](#)

## Namespaces

- [File](#)
- [Discussion](#)

## Variants

## Views

- [Read](#)
- [View source](#)
- [View history](#)

## More

- This page was last edited on 17 October 2007, at 04:26.

- [Privacy policy](#)
- [About Win-Test Wiki](#)
- [Disclaimers](#)





# File:MicrohamDeviceRouterMicrokeyer4.gif

From Win-Test Wiki

[Jump to navigation](#) [Jump to search](#)

- [File](#)
- [File history](#)
- [File usage](#)

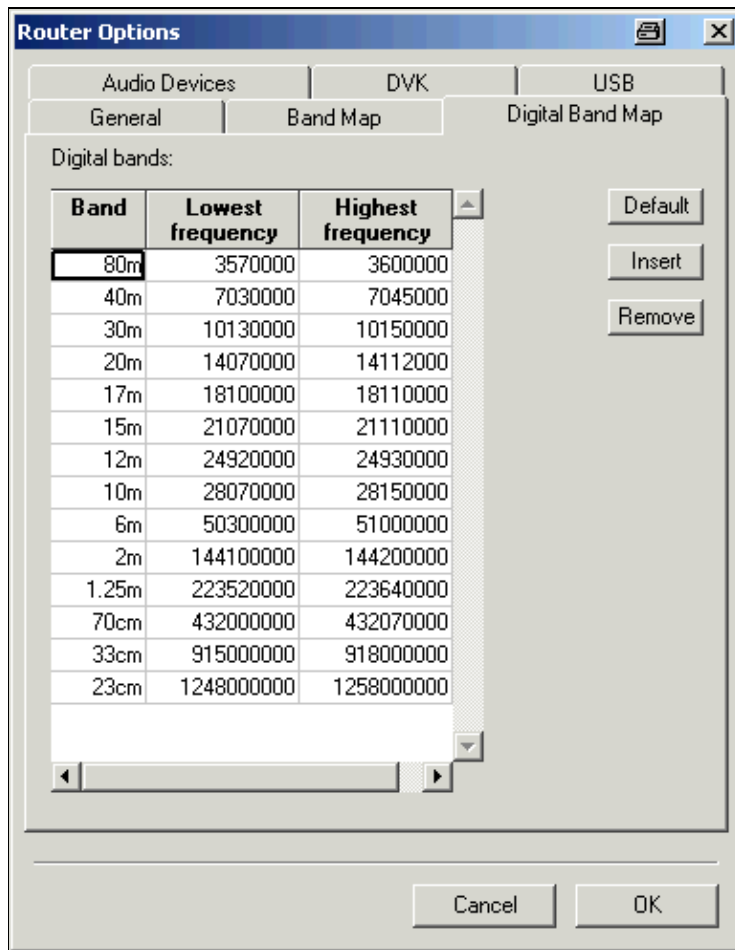

No higher resolution available.

[MicrohamDeviceRouterMicrokeyer4.gif](#) (384 × 494 pixels, file size: 14 KB, MIME type: image/gif)

## File history

Click on a date/time to view the file as it appeared at that time.

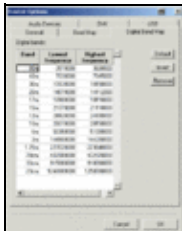
Date/Time	Thumbnail	Dimensions	User	Comment
current <a href="#">04:33, 17 October 2007</a>		384 × 494 (14 KB)	<a href="#">Dl6rai</a> ( <a href="#">talk</a>   <a href="#">contribs</a> )	

You cannot overwrite this file.

## File usage

The following 5 pages use this file:

- [BestPractice10](#)
- [BestPractice4](#)
- [BestPractice5](#)
- [BestPractice6](#)
- [BestPractice8](#)

## Namespaces

- [File](#)
- [Discussion](#)

## Variants

## Views

- [Read](#)
- [View source](#)
- [View history](#)

## More

- This page was last edited on 17 October 2007, at 04:33.
- [Privacy policy](#)
- [About Win-Test Wiki](#)
- [Disclaimers](#)



# File:MicrohamDeviceRouterMicrokeyer4.gif

From Win-Test Wiki

[Jump to navigation](#) [Jump to search](#)

- [File](#)
- [File history](#)
- [File usage](#)

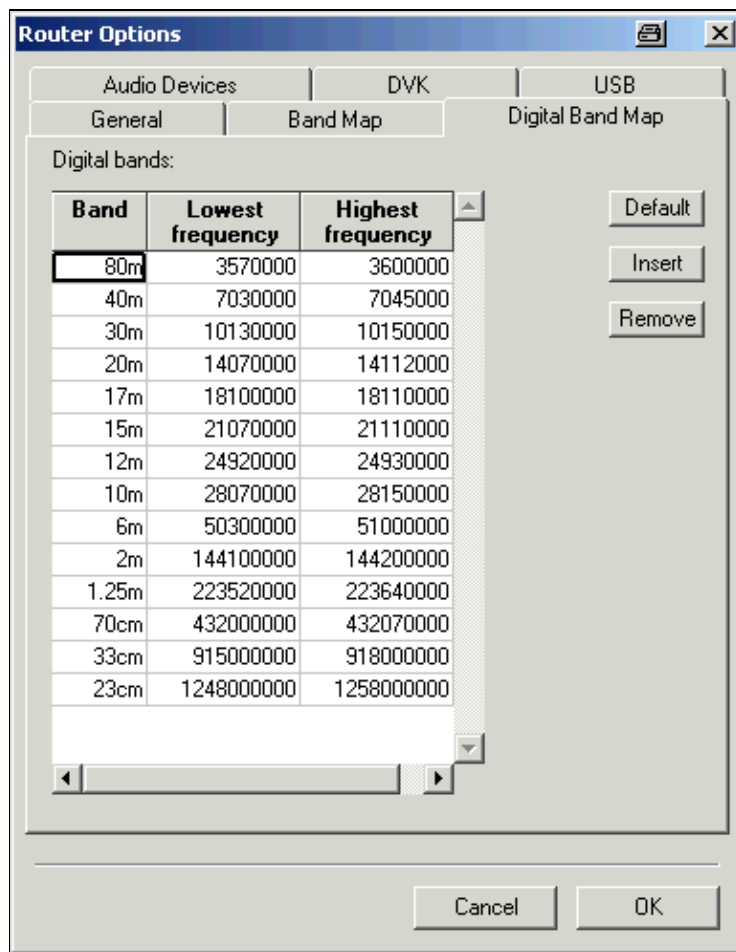

No higher resolution available.

[MicrohamDeviceRouterMicrokeyer4.gif](#) (384 × 494 pixels, file size: 14 KB, MIME type: image/gif)

## File history

Click on a date/time to view the file as it appeared at that time.

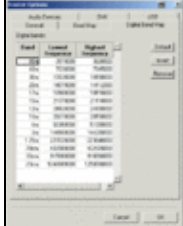
Date/Time	Thumbnail	Dimensions	User	Comment
current <a href="#">04:33, 17 October 2007</a>		384 × 494 (14 KB)	<a href="#">Dl6rai</a> ( <a href="#">talk</a>   <a href="#">contribs</a> )	

You cannot overwrite this file.

## File usage

The following 5 pages use this file:

- [BestPractice10](#)
- [BestPractice4](#)
- [BestPractice5](#)
- [BestPractice6](#)
- [BestPractice8](#)

## Namespaces

- [File](#)
- [Discussion](#)

## Variants

## Views

- [Read](#)
- [View source](#)
- [View history](#)

## More

- This page was last edited on 17 October 2007, at 04:33.
- [Privacy policy](#)
- [About Win-Test Wiki](#)
- [Disclaimers](#)



# File:MicrohamDeviceRouterMicrokeyer5.gif

From Win-Test Wiki

[Jump to navigation](#) [Jump to search](#)

- [File](#)
- [File history](#)
- [File usage](#)

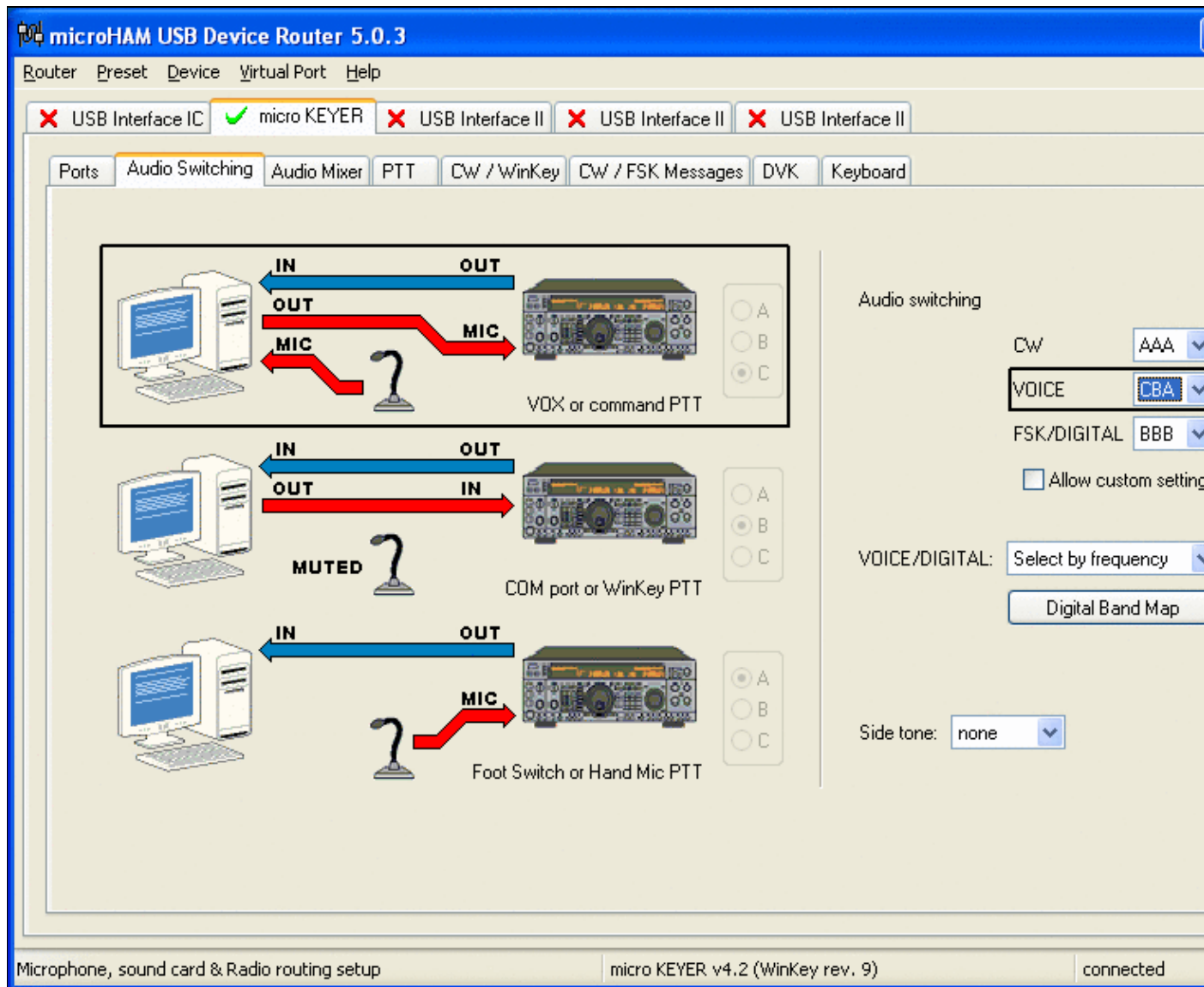



No higher resolution available.

[MicrohamDeviceRouterMicrokeyer5.gif](#) (800 Å 600 pixels, file size: 51 KB, MIME type: image.gif)

## File history

Click on a date/time to view the file as it appeared at that time.

	Date/Time	Thumbnail	Dimensions	User	Comment
current	<a href="#">08:12, 18 November 2007</a>		800 Å 600 (51 KB)	<a href="#">Dl6rai</a> ( <a href="#">talk</a>   <a href="#">contribs</a> )	
	<a href="#">14:32, 17 November 2007</a>		800 Å 600 (53 KB)	<a href="#">Dl6rai</a> ( <a href="#">talk</a>   <a href="#">contribs</a> )	
	<a href="#">04:33, 17 October 2007</a>		800 Å 600 (21 KB)	<a href="#">Dl6rai</a> ( <a href="#">talk</a>   <a href="#">contribs</a> )	

You cannot overwrite this file.

## File usage

The following page uses this file:

- [BestPractice4](#)

## Namespaces

- [File](#)
- [Discussion](#)

## Variants

## Views

- [Read](#)
- [View source](#)
- [View history](#)

## More

- This page was last edited on 17 October 2007, at 04:33.



## Win-Test Wiki

- [Privacy policy](#)
- [About Win-Test Wiki](#)
- [Disclaimers](#)



# File:MicrohamDeviceRouterMicrokeyer5.gif

From Win-Test Wiki

[Jump to navigation](#) [Jump to search](#)

- [File](#)
- [File history](#)
- [File usage](#)



The screenshot displays the 'microHAM USB Device Router 5.0.3' application window. The title bar includes the application name and a menu bar with 'Router', 'Preset', 'Device', 'Virtual Port', and 'Help'. Below the menu bar, there are status indicators for various USB interfaces: 'USB Interface IC' (disabled), 'micro KEYER' (enabled), and three 'USB Interface II' instances (disabled). The main interface has several tabs: 'Ports', 'Audio Switching' (selected), 'Audio Mixer', 'PTT', 'CW / WinKey', 'CW / FSK Messages', 'DVK', and 'Keyboard'. The 'Audio Switching' tab contains three diagrams illustrating different audio routing configurations for a computer and a radio. The top diagram is labeled 'VOX or command PTT' and shows bidirectional audio flow between the computer and the radio, with a microphone connected to the radio's MIC input. The middle diagram is labeled 'COM port or WinKey PTT' and shows the radio's COM port connected to the computer, with the microphone muted. The bottom diagram is labeled 'Foot Switch or Hand Mic PTT' and shows the radio's MIC input connected to a microphone. To the right of these diagrams are three sets of radio buttons labeled 'A', 'B', and 'C'. On the far right, there are additional settings: 'Audio switching' with dropdowns for 'CW' (AAA), 'VOICE' (CBA), and 'FSK/DIGITAL' (BBB), an 'Allow custom setting' checkbox, 'VOICE/DIGITAL' set to 'Select by frequency', a 'Digital Band Map' button, and 'Side tone' set to 'none'. The status bar at the bottom shows 'Microphone, sound card & Radio routing setup', 'micro KEYER v4.2 (WinKey rev. 9)', and 'connected'.

No higher resolution available.

[MicrohamDeviceRouterMicrokeyer5.gif](#) (800 × 600 pixels, file size: 51 KB, MIME type: image/gif)

## File history

Click on a date/time to view the file as it appeared at that time.

	Date/Time	Thumbnail	Dimensions	User	Comment
current	<a href="#">08:12, 18 November 2007</a>		800 × 600 (51 KB)	<a href="#">Dl6rai</a> ( <a href="#">talk</a>   <a href="#">contribs</a> )	
	<a href="#">14:32, 17 November 2007</a>		800 × 600 (53 KB)	<a href="#">Dl6rai</a> ( <a href="#">talk</a>   <a href="#">contribs</a> )	
	<a href="#">04:33, 17 October 2007</a>		800 × 600 (21 KB)	<a href="#">Dl6rai</a> ( <a href="#">talk</a>   <a href="#">contribs</a> )	

You cannot overwrite this file.

## File usage

The following page uses this file:

- [BestPractice4](#)

## Namespaces

- [File](#)
- [Discussion](#)

## Variants

## Views

- [Read](#)
- [View source](#)
- [View history](#)

## More

- This page was last edited on 17 October 2007, at 04:33.

## Win-Test Wiki

- [Privacy policy](#)
- [About Win-Test Wiki](#)
- [Disclaimers](#)



# File:MicrohamDeviceRouterMicrokeyer6.gif

From Win-Test Wiki

[Jump to navigation](#) [Jump to search](#)

- [File](#)
- [File history](#)
- [File usage](#)

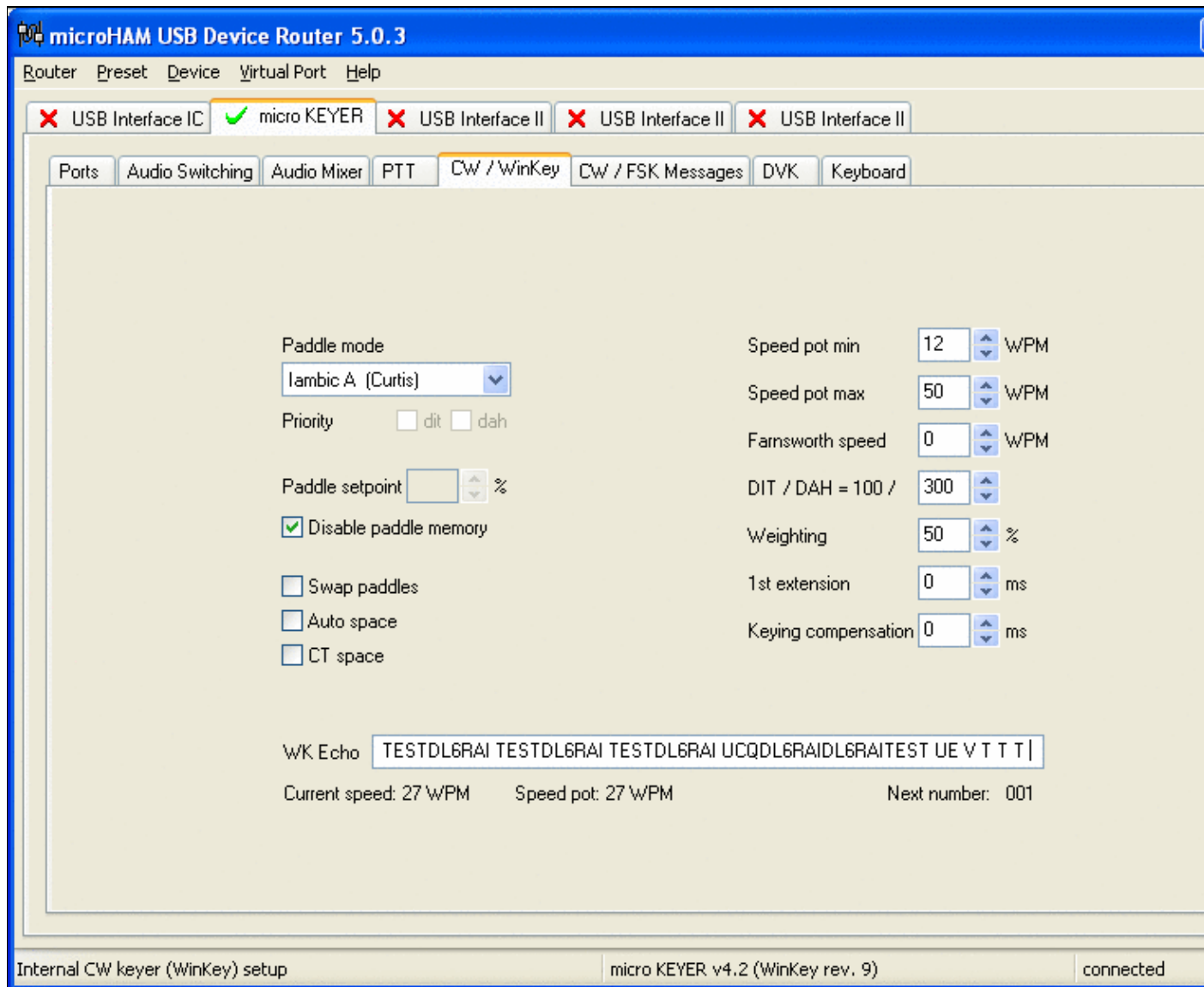



No higher resolution available.

[MicrohamDeviceRouterMicrokeyer6.gif](#) (800 Å 600 pixels, file size: 35 KB, MIME type: image.gif)

## File history

Click on a date/time to view the file as it appeared at that time.

	Date/Time	Thumbnail	Dimensions	User	Comment
current	<a href="#">07:29, 18 November 2007</a>		800 Å 600 (35 KB)	<a href="#">Dl6rai</a> ( <a href="#">talk</a>   <a href="#">contribs</a> )	
	<a href="#">04:35, 17 October 2007</a>		800 Å 600 (22 KB)	<a href="#">Dl6rai</a> ( <a href="#">talk</a>   <a href="#">contribs</a> )	

You cannot overwrite this file.

## File usage

The following page uses this file:

- [BestPractice4](#)

## Namespaces

- [File](#)
- [Discussion](#)

## Variants

## Views

- [Read](#)
- [View source](#)
- [View history](#)

## More

- This page was last edited on 17 October 2007, at 04:35.
- [Privacy policy](#)
- [About Win-Test Wiki](#)
- [Disclaimers](#)



# File:MicrohamDeviceRouterMicrokeyer6.gif

From Win-Test Wiki

[Jump to navigation](#) [Jump to search](#)

- [File](#)
- [File history](#)
- [File usage](#)

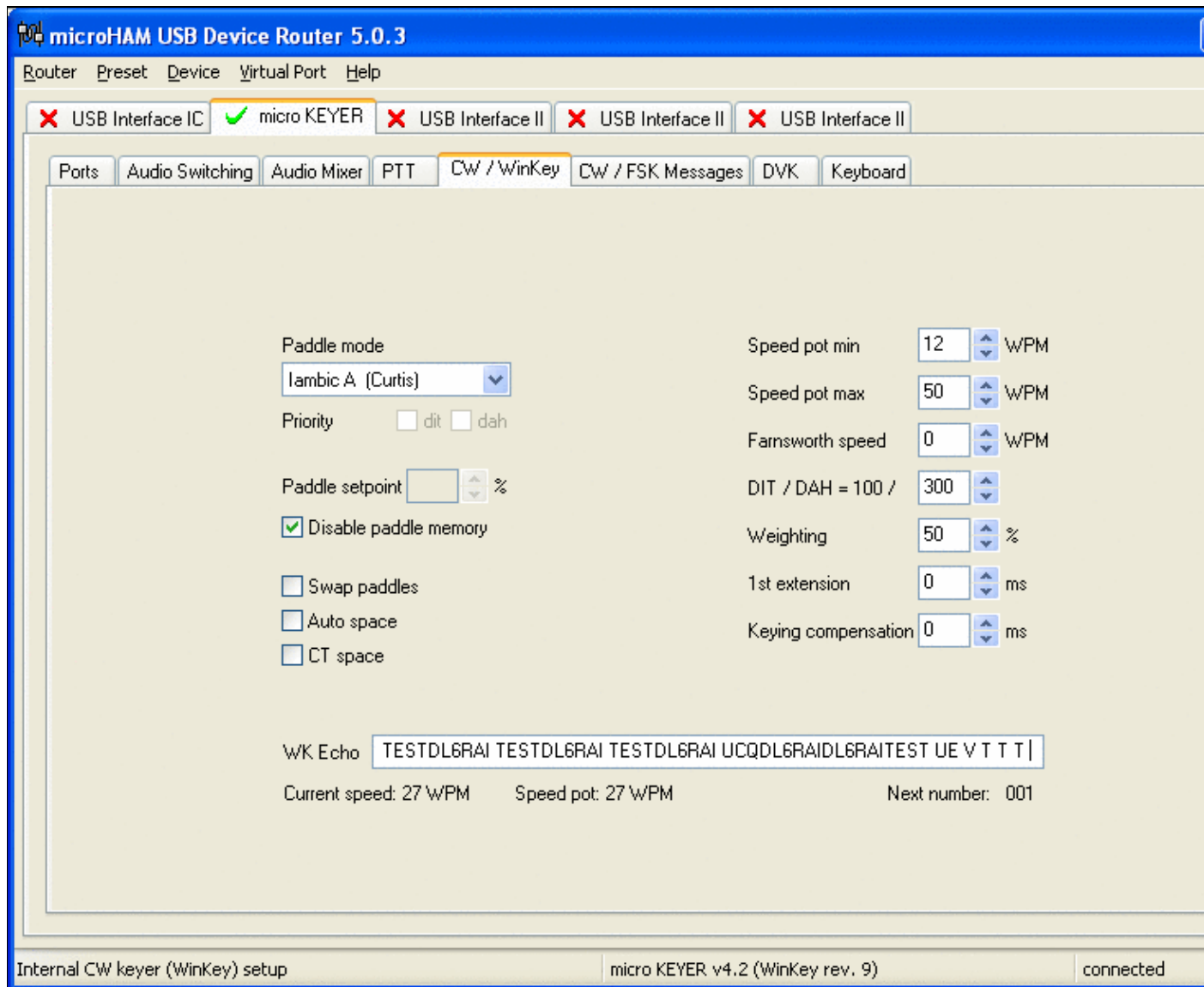



No higher resolution available.

[MicrohamDeviceRouterMicrokeyer6.gif](#) (800 Å 600 pixels, file size: 35 KB, MIME type: image.gif)

## File history

Click on a date/time to view the file as it appeared at that time.

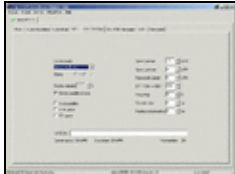
	Date/Time	Thumbnail	Dimensions	User	Comment
current	<a href="#">07:29, 18 November 2007</a>		800 Å 600 (35 KB)	<a href="#">Dl6rai</a> ( <a href="#">talk</a>   <a href="#">contribs</a> )	
	<a href="#">04:35, 17 October 2007</a>		800 Å 600 (22 KB)	<a href="#">Dl6rai</a> ( <a href="#">talk</a>   <a href="#">contribs</a> )	

You cannot overwrite this file.

## File usage

The following page uses this file:

- [BestPractice4](#)

## Namespaces

- [File](#)
- [Discussion](#)

## Variants

## Views

- [Read](#)
- [View source](#)
- [View history](#)

## More

- This page was last edited on 17 October 2007, at 04:35.
- [Privacy policy](#)
- [About Win-Test Wiki](#)
- [Disclaimers](#)



# File:MicrohamDeviceRouterMKII1.gif

From Win-Test Wiki

[Jump to navigation](#) [Jump to search](#)

- [File](#)
- [File history](#)
- [File usage](#)

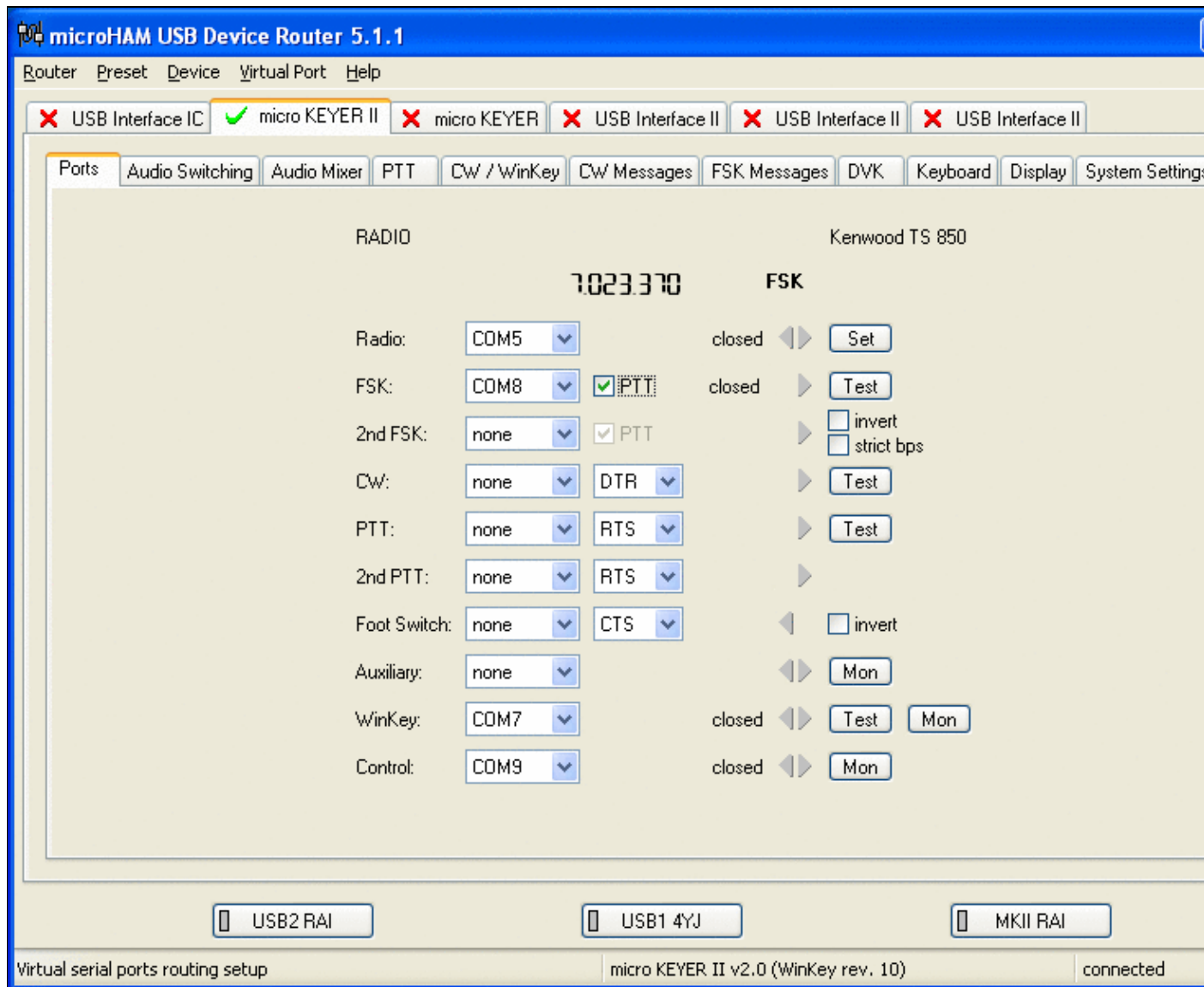

No higher resolution available.

MicrohamDeviceRouterMKII1.gif (800 × 600 pixels, file size: 42 KB, MIME type: image.gif)

## File history

Click on a date/time to view the file as it appeared at that time.

	Date/Time	Thumbnail	Dimensions	User	Comment
current	<u>19:43, 11 March 2008</u>		800 × 600 (42 KB)	<u>Dl6rai</u> ( <span><u>talk</u></span>   <span><u>contribs</u></span> )	

You cannot overwrite this file.

## File usage

The following page uses this file:

- BestPractice5

## Namespaces

- File
- Discussion

## Variants

## Views

- Read
- View source
- View history

## More

- This page was last edited on 11 March 2008, at 19:43.

- Privacy policy
- About Win-Test Wiki
- Disclaimers



# File:MicrohamDeviceRouterMKII1-FT1000D.gif

From Win-Test Wiki

[Jump to navigation](#) [Jump to search](#)

- [File](#)
- [File history](#)
- [File usage](#)
- [Metadata](#)

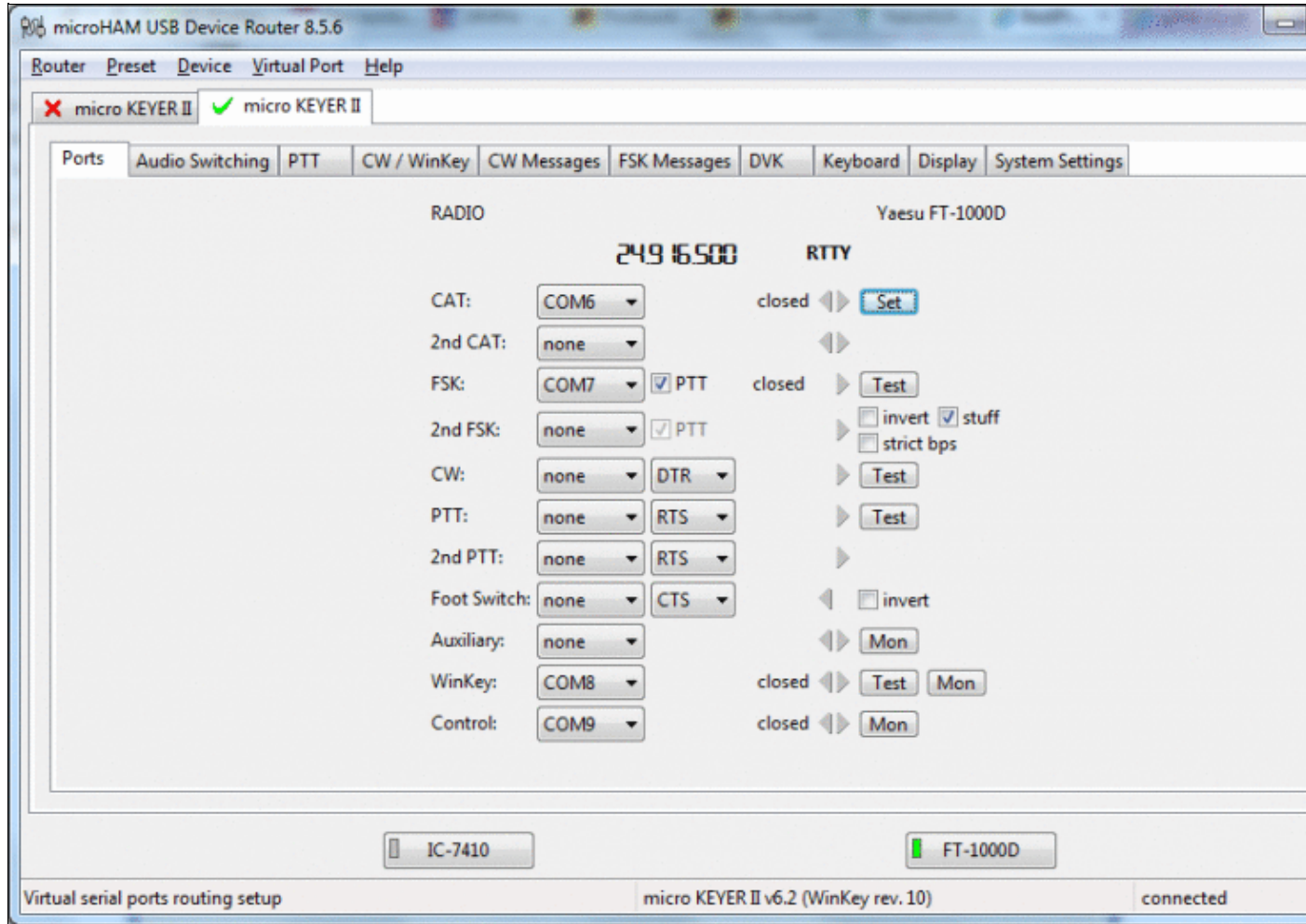

Size of this preview: 800 Å 518 pixels. Other resolutions: 320 Å 207 pixels | 926 Å 600 pixels.  
Original file (926 Å 600 pixels, file size: 83 KB, MIME type: image.gif)

## File history

Click on a date/time to view the file as it appeared at that time.

	Date/Time	Thumbnail	Dimensions	User	Comment
current	<u>15:58, 18 April 2015</u>		926 Å 600 (83 KB)	<u>Dl6rai</u> ( <a href="#">talk</a>   <a href="#">contribs</a> )	

You cannot overwrite this file.

## File usage

The following page uses this file:

- [BestPractice6](#)

## Metadata

This file contains additional information, probably added from the digital camera or scanner used to create or digitize it.

If the file has been modified from its original state, some details may not fully reflect the modified file.

**Horizontal resolution** 37.79 dpc

**Vertical resolution** 37.79 dpc

## Namespaces

- [File](#)
- [Discussion](#)

## Variants

## Views

- [Read](#)
- [View source](#)
- [View history](#)

## More

- This page was last edited on 18 April 2015, at 15:58.
- [Privacy policy](#)

## Win-Test Wiki

- [About Win-Test Wiki](#)
- [Disclaimers](#)



# File:MicrohamDeviceRouterMKII1-FT1000D.gif

From Win-Test Wiki

[Jump to navigation](#) [Jump to search](#)

- [File](#)
- [File history](#)
- [File usage](#)
- [Metadata](#)

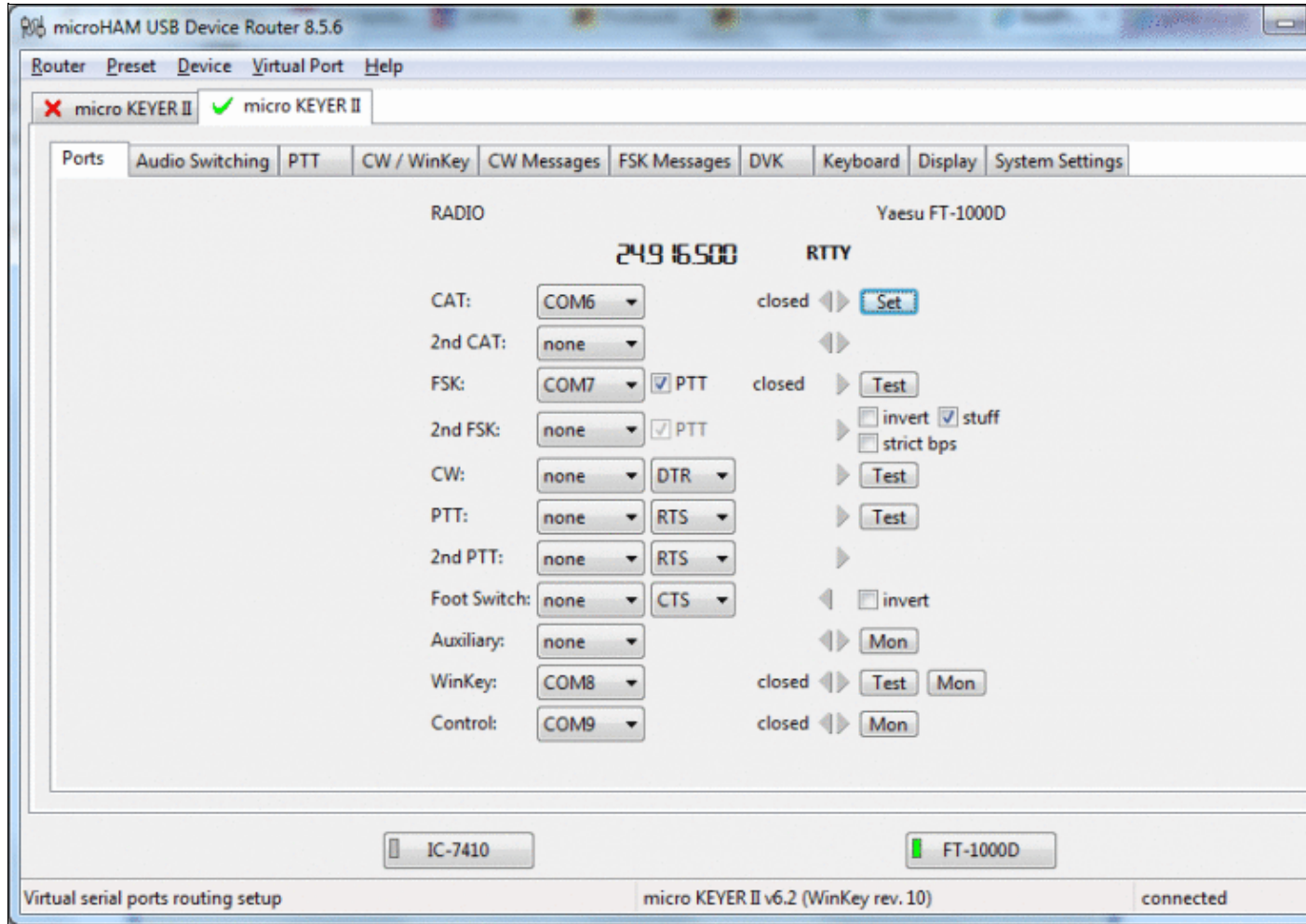



Size of this preview: 800 Å 518 pixels. Other resolutions: 320 Å 207 pixels | 926 Å 600 pixels.  
[Original file](#) (926 Å 600 pixels, file size: 83 KB, MIME type: image.gif)

## File history

Click on a date/time to view the file as it appeared at that time.

Date/Time	Thumbnail	Dimensions	User	Comment
current <u>15:58, 18 April 2015</u>		926 Å 600 (83 KB)	<a href="#">Dl6rai</a> ( <a href="#">talk</a>   <a href="#">contribs</a> )	

You cannot overwrite this file.

## File usage

The following page uses this file:

- [BestPractice6](#)

## Metadata

This file contains additional information, probably added from the digital camera or scanner used to create or digitize it.

If the file has been modified from its original state, some details may not fully reflect the modified file.

**Horizontal resolution** 37.79 dpc

**Vertical resolution** 37.79 dpc

## Namespaces

- [File](#)
- [Discussion](#)

## Variants

## Views

- [Read](#)
- [View source](#)
- [View history](#)

## More

- This page was last edited on 18 April 2015, at 15:58.
- [Privacy policy](#)

- [About Win-Test Wiki](#)
- [Disclaimers](#)



# File:MicrohamDeviceRouterMKII1.gif

From Win-Test Wiki

[Jump to navigation](#) [Jump to search](#)

- [File](#)
- [File history](#)
- [File usage](#)

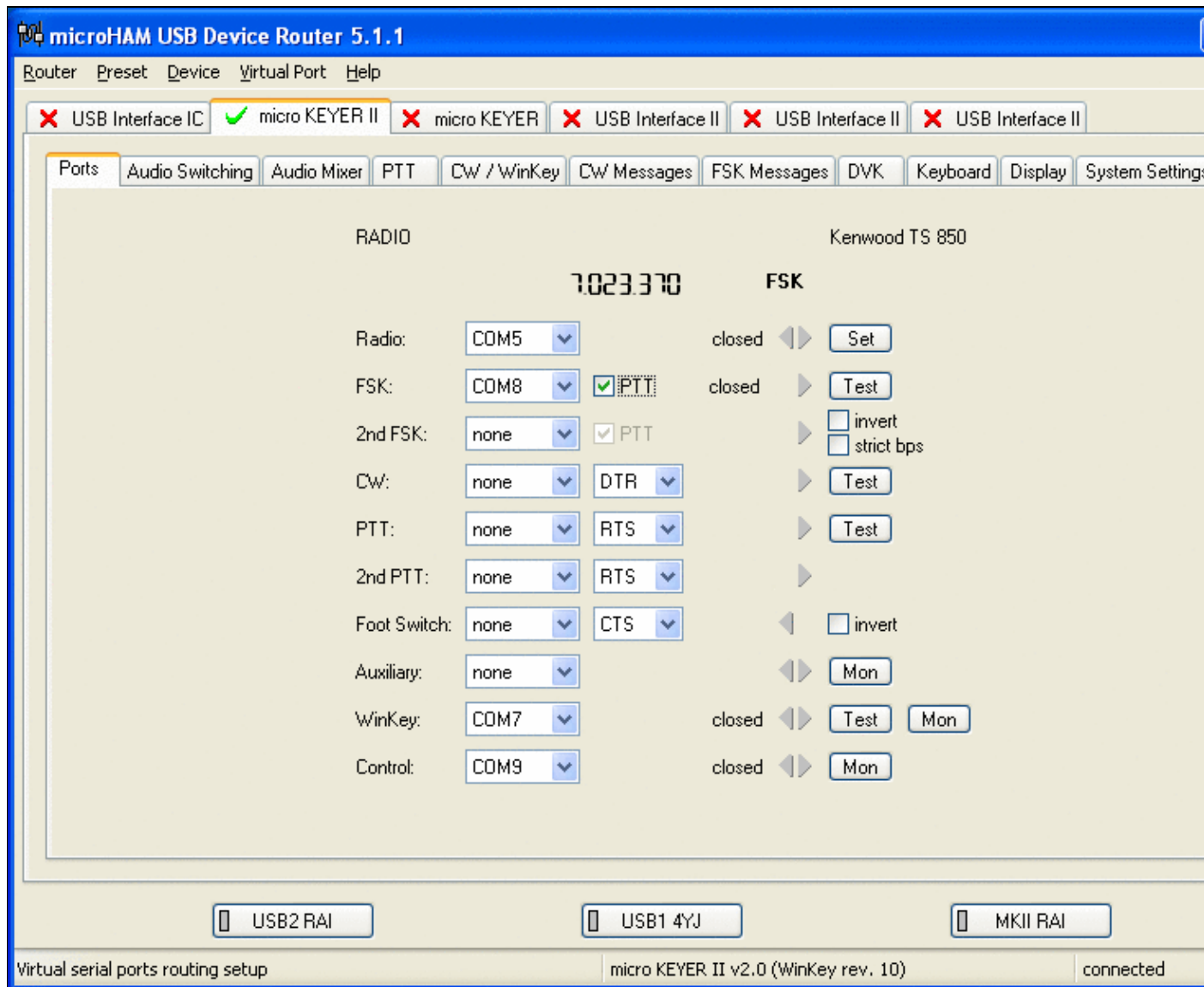

No higher resolution available.

MicrohamDeviceRouterMKII1.gif (800 × 600 pixels, file size: 42 KB, MIME type: image.gif)

## File history

Click on a date/time to view the file as it appeared at that time.

	Date/Time	Thumbnail	Dimensions	User	Comment
current	<u>19:43, 11 March 2008</u>		800 × 600 (42 KB)	<u>Dl6rai</u> ( <u>talk</u>   <u>contribs</u> )	

You cannot overwrite this file.

## File usage

The following page uses this file:

- BestPractice5

## Namespaces

- File
- Discussion

## Variants

## Views

- Read
- View source
- View history

## More

- This page was last edited on 11 March 2008, at 19:43.

- Privacy policy
- About Win-Test Wiki
- Disclaimers



# File:MicrohamDeviceRouterMKII1-IC-7410.gif

From Win-Test Wiki

[Jump to navigation](#) [Jump to search](#)

- [File](#)
- [File history](#)
- [File usage](#)
- [Metadata](#)

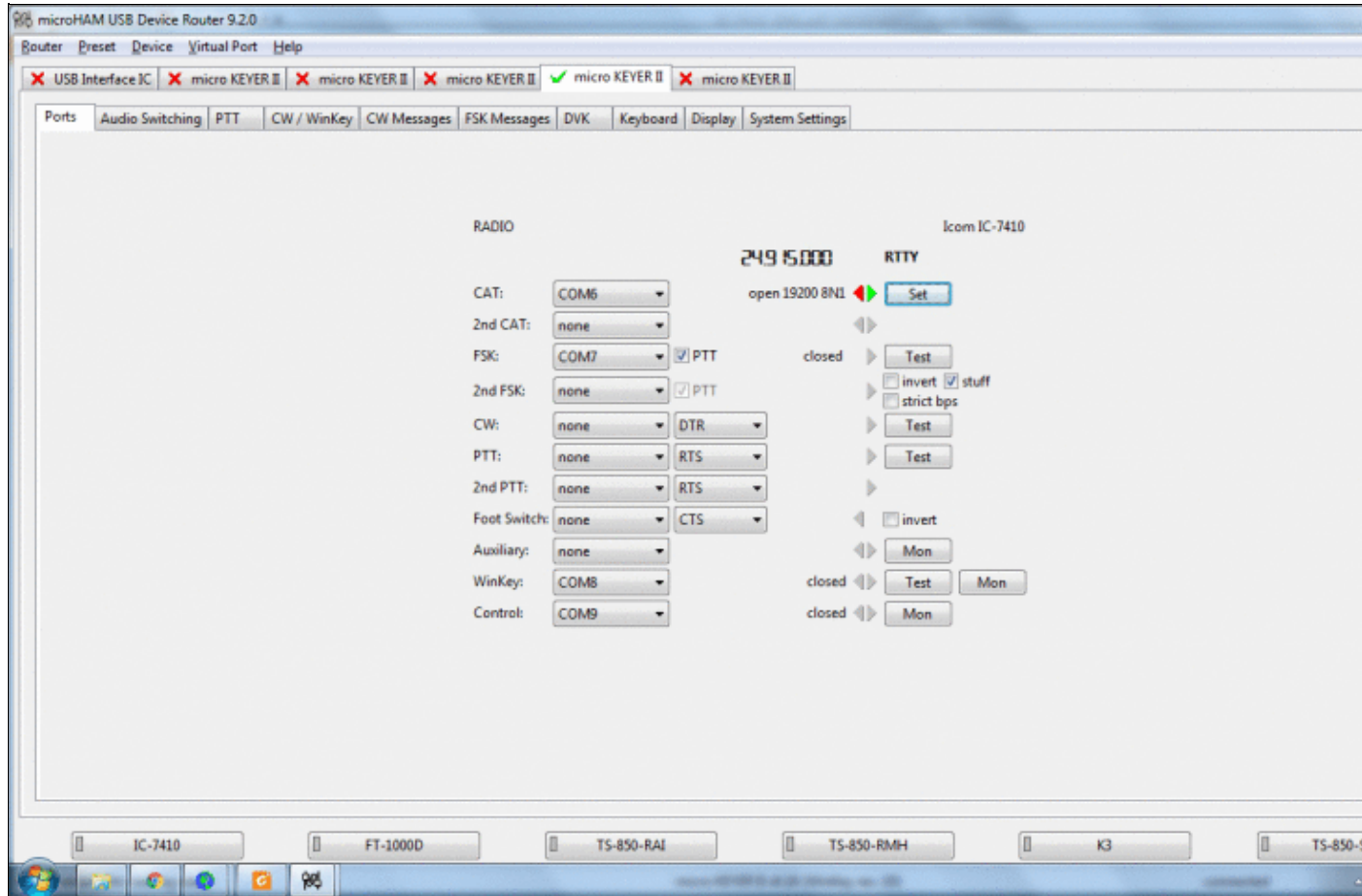

Size of this preview: [800 Å 481 pixels](#). Other resolutions: [320 Å 192 pixels](#) | [1,278 Å 768 pixels](#).  
[Original file](#) (1,278 Å 768 pixels, file size: 110 KB, MIME type: image.gif)

## File history

Click on a date/time to view the file as it appeared at that time.

	Date/Time	Thumbnail	Dimensions	User	Comment
current	<a href="#">15:40, 31 March 2020</a>		1,278 Å 768 (110 KB)	<a href="#">Dl6rai</a> ( <a href="#">talk</a>   <a href="#">contribs</a> )	

You cannot overwrite this file.

## File usage

The following 2 pages use this file:

- [BestPractice10](#)
- [BestPractice8](#)

## Metadata

This file contains additional information, probably added from the digital camera or scanner used to create or digitize it.

If the file has been modified from its original state, some details may not fully reflect the modified file.

**Horizontal resolution** 37.79 dpc

**Vertical resolution** 37.79 dpc

## Namespaces

- [File](#)
- [Discussion](#)

## Variants

## Views

- [Read](#)
- [View source](#)
- [View history](#)

## More

- This page was last edited on 31 March 2020, at 15:40.

## Win-Test Wiki

- [Privacy policy](#)
- [About Win-Test Wiki](#)
- [Disclaimers](#)



# File:MicrohamDeviceRouterMKII1-IC-7410.gif

From Win-Test Wiki

[Jump to navigation](#) [Jump to search](#)

- [File](#)
- [File history](#)
- [File usage](#)
- [Metadata](#)

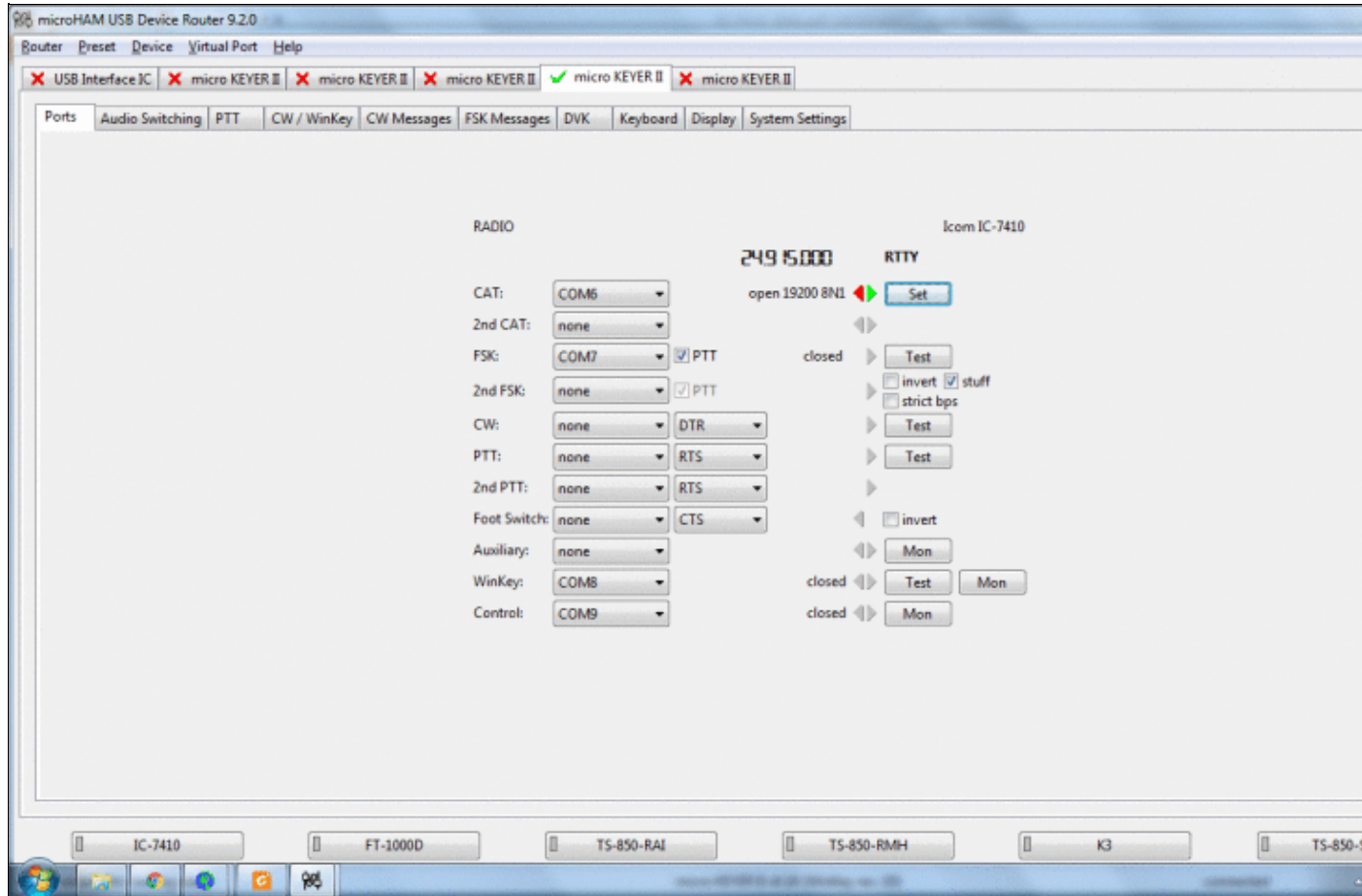



Size of this preview: [800 Å 481 pixels](#). Other resolutions: [320 Å 192 pixels](#) | [1,278 Å 768 pixels](#).  
[Original file](#) (1,278 Å 768 pixels, file size: 110 KB, MIME type: image.gif)

## File history

Click on a date/time to view the file as it appeared at that time.

	Date/Time	Thumbnail	Dimensions	User	Comment
current	<a href="#">15:40, 31 March 2020</a>		1,278 Å 768 (110 KB)	<a href="#">Dl6rai</a> ( <a href="#">talk</a>   <a href="#">contribs</a> )	

You cannot overwrite this file.

## File usage

The following 2 pages use this file:

- [BestPractice10](#)
- [BestPractice8](#)

## Metadata

This file contains additional information, probably added from the digital camera or scanner used to create or digitize it.

If the file has been modified from its original state, some details may not fully reflect the modified file.

**Horizontal resolution** 37.79 dpc

**Vertical resolution** 37.79 dpc

## Namespaces

- [File](#)
- [Discussion](#)

## Variants

## Views

- [Read](#)
- [View source](#)
- [View history](#)

## More

- This page was last edited on 31 March 2020, at 15:40.

## Win-Test Wiki

- [Privacy policy](#)
- [About Win-Test Wiki](#)
- [Disclaimers](#)



# File:MicrohamDeviceRouterMKII3.gif

From Win-Test Wiki

[Jump to navigation](#) [Jump to search](#)

- [File](#)
- [File history](#)
- [File usage](#)

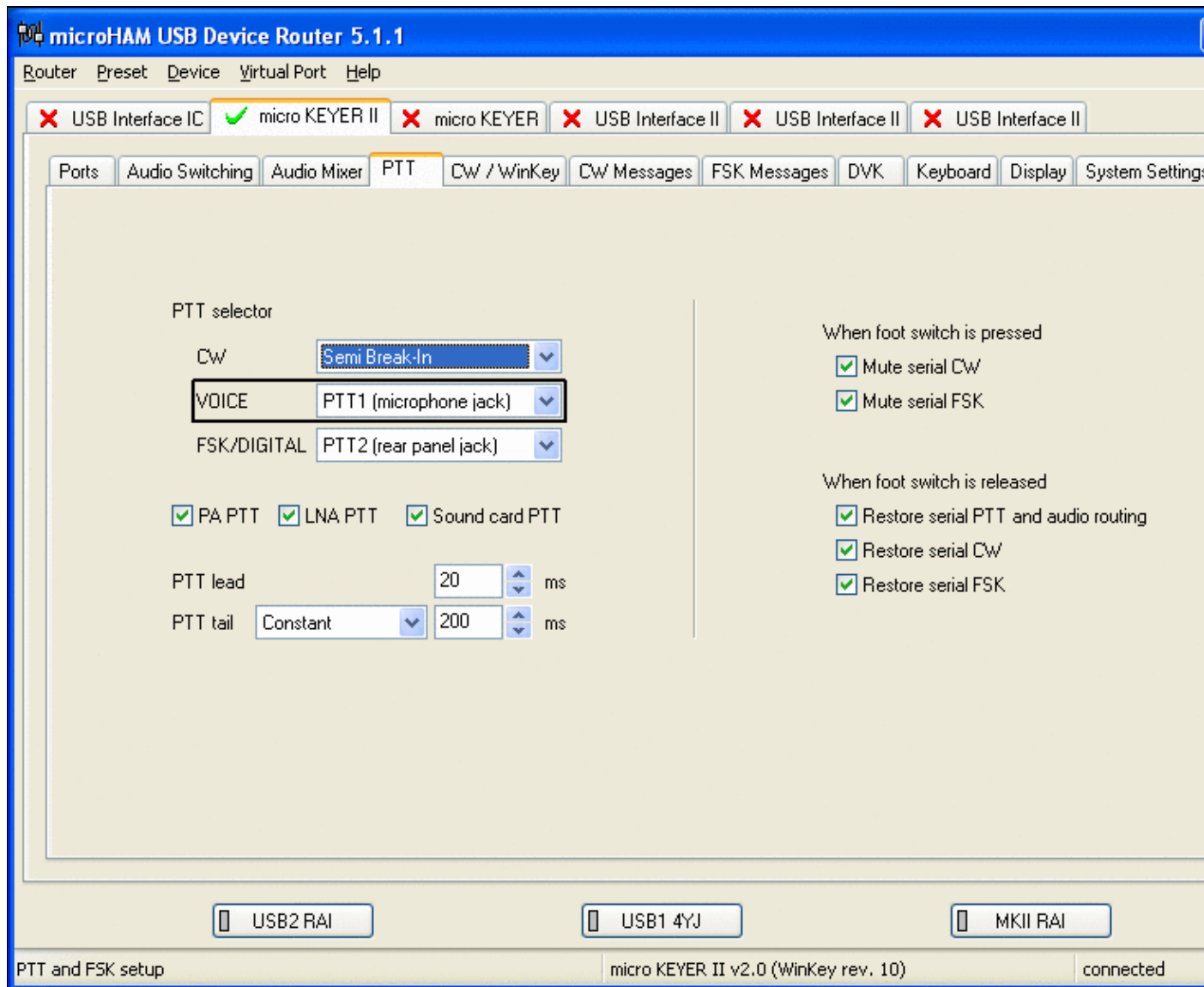

No higher resolution available.

[MicrohamDeviceRouterMKII3.gif](#) (800 × 600 pixels, file size: 35 KB, MIME type: image.gif)

## File history

Click on a date/time to view the file as it appeared at that time.

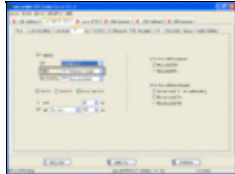
	Date/Time	Thumbnail	Dimensions	User	Comment
current	<a href="#">19:53, 11 March 2008</a>		800 × 600 (35 KB)	<a href="#">Dl6rai</a> ( <a href="#">talk</a>   <a href="#">contribs</a> )	

You cannot overwrite this file.

## File usage

The following 4 pages use this file:

- [BestPractice10](#)
- [BestPractice5](#)
- [BestPractice6](#)
- [BestPractice8](#)

## Namespaces

- [File](#)
- [Discussion](#)

## Variants

## Views

- [Read](#)
- [View source](#)
- [View history](#)

## More

- This page was last edited on 11 March 2008, at 19:53.

- [Privacy policy](#)
- [About Win-Test Wiki](#)
- [Disclaimers](#)



# File:MicrohamDeviceRouterMKII3.gif

From Win-Test Wiki

[Jump to navigation](#) [Jump to search](#)

- [File](#)
- [File history](#)
- [File usage](#)

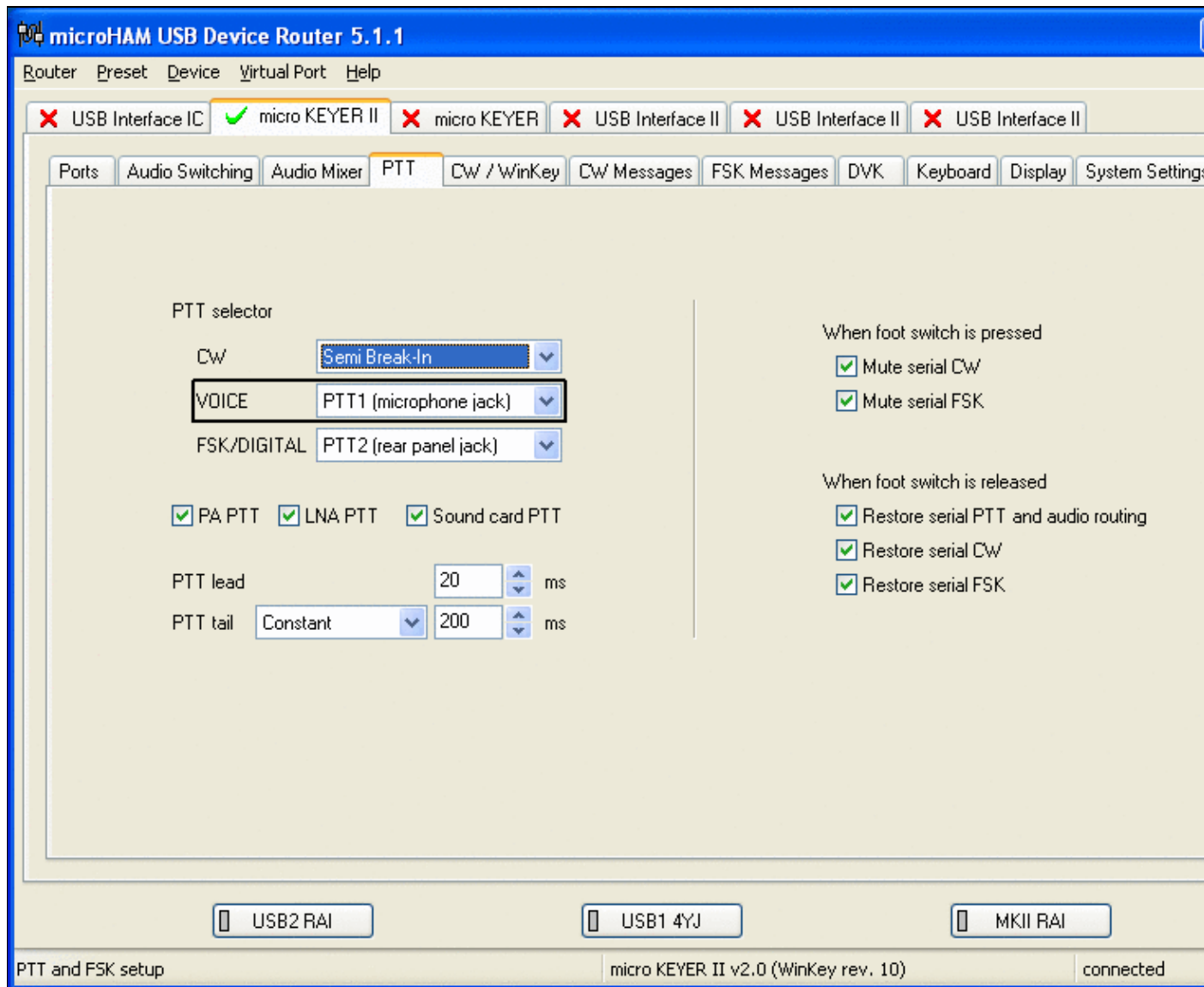

No higher resolution available.

[MicrohamDeviceRouterMKII3.gif](#) (800 × 600 pixels, file size: 35 KB, MIME type: image.gif)

## File history

Click on a date/time to view the file as it appeared at that time.

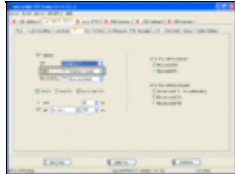
	Date/Time	Thumbnail	Dimensions	User	Comment
current	<a href="#">19:53, 11 March 2008</a>		800 × 600 (35 KB)	<a href="#">Dl6rai</a> ( <a href="#">talk</a>   <a href="#">contribs</a> )	

You cannot overwrite this file.

## File usage

The following 4 pages use this file:

- [BestPractice10](#)
- [BestPractice5](#)
- [BestPractice6](#)
- [BestPractice8](#)

## Namespaces

- [File](#)
- [Discussion](#)

## Variants

## Views

- [Read](#)
- [View source](#)
- [View history](#)

## More

- This page was last edited on 11 March 2008, at 19:53.

- [Privacy policy](#)
- [About Win-Test Wiki](#)
- [Disclaimers](#)



# File:MicrohamDeviceRouterMKII5.gif

From Win-Test Wiki

[Jump to navigation](#) [Jump to search](#)

- [File](#)
- [File history](#)
- [File usage](#)

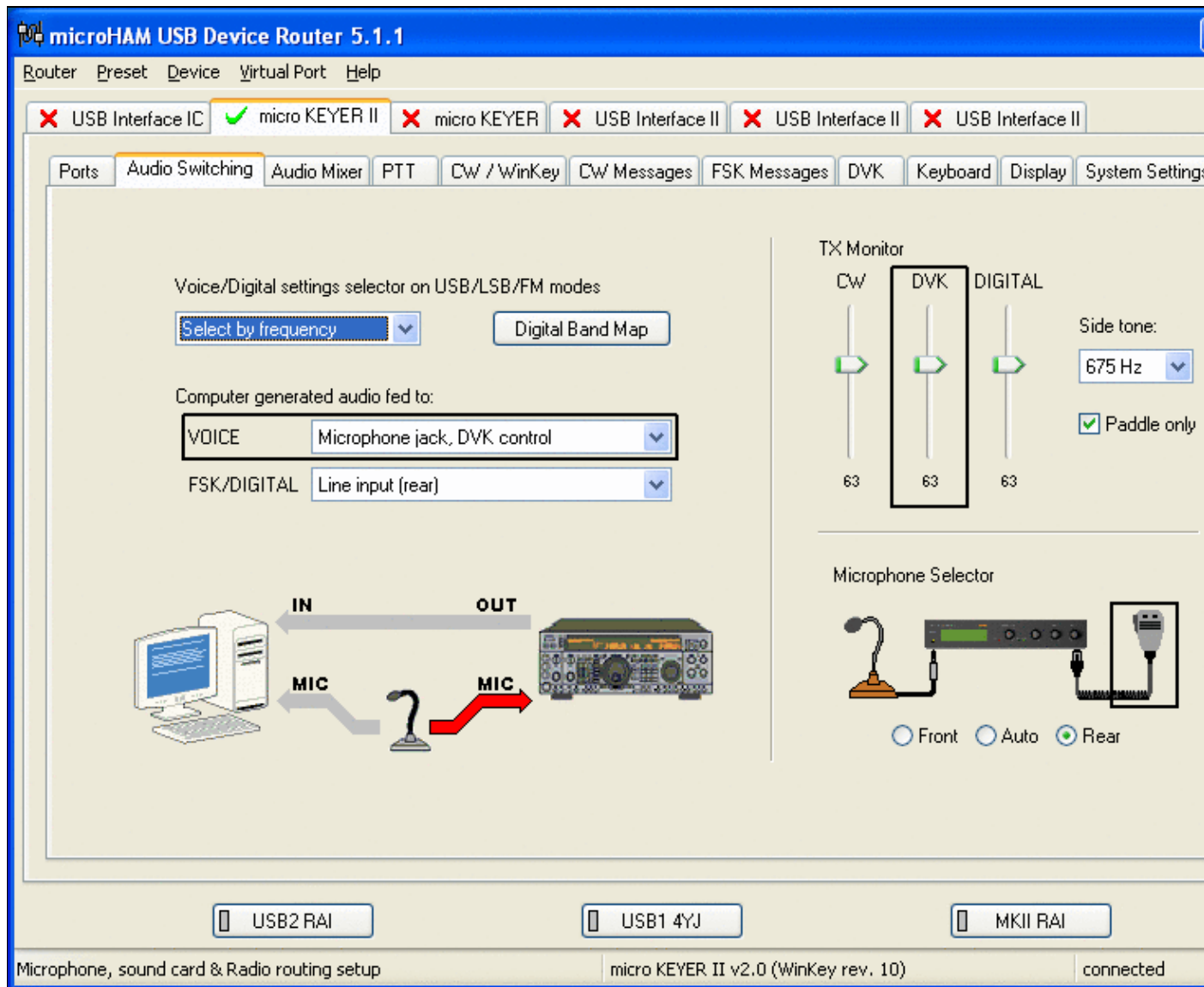

No higher resolution available.

MicrohamDeviceRouterMKII5.gif (800 × 600 pixels, file size: 44 KB, MIME type: image.gif)

## File history

Click on a date/time to view the file as it appeared at that time.

	Date/Time	Thumbnail	Dimensions	User	Comment
current	<u>19:47, 11 March 2008</u>		800 × 600 (44 KB)	<u>Dl6rai</u> ( <span><u>talk</u></span>   <span><u>contribs</u></span> )	

You cannot overwrite this file.

## File usage

The following 4 pages use this file:

- BestPractice10
- BestPractice5
- BestPractice6
- BestPractice8

## Namespaces

- File
- Discussion

## Variants

## Views

- Read
- View source
- View history

## More

- This page was last edited on 11 March 2008, at 19:47.

- Privacy policy
- About Win-Test Wiki
- Disclaimers





# File:MicrohamDeviceRouterMKII5.gif

From Win-Test Wiki

[Jump to navigation](#) [Jump to search](#)

- [File](#)
- [File history](#)
- [File usage](#)

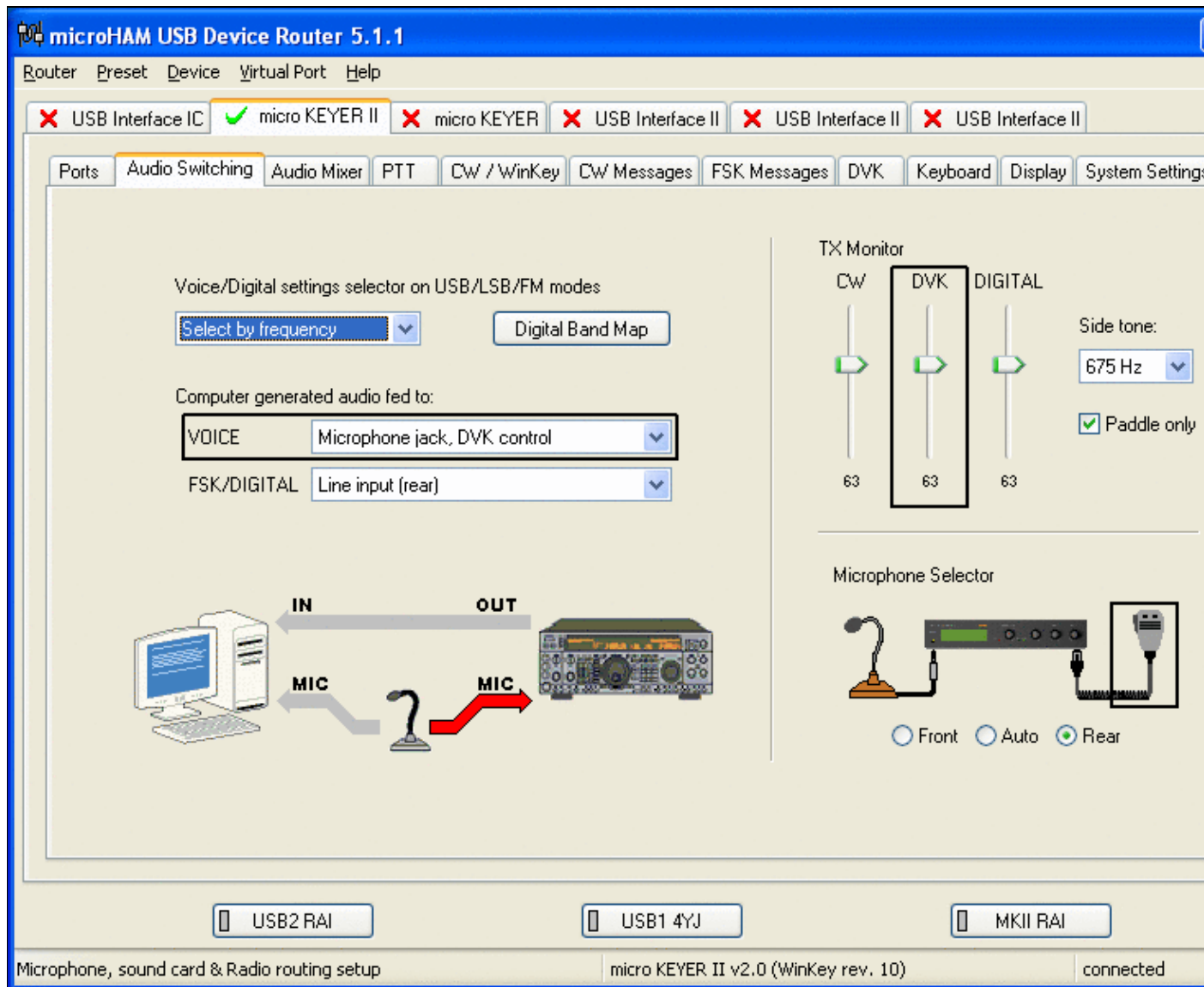

No higher resolution available.

[MicrohamDeviceRouterMKII5.gif](#) (800 × 600 pixels, file size: 44 KB, MIME type: image.gif)

## File history

Click on a date/time to view the file as it appeared at that time.

	Date/Time	Thumbnail	Dimensions	User	Comment
current	<u><a href="#">19:47, 11 March 2008</a></u>		800 × 600 (44 KB)	<u><a href="#">Dl6rai</a></u> ( <u><a href="#">talk</a></u>   <u><a href="#">contribs</a></u> )	

You cannot overwrite this file.

## File usage

The following 4 pages use this file:

- [BestPractice10](#)
- [BestPractice5](#)
- [BestPractice6](#)
- [BestPractice8](#)

## Namespaces

- [File](#)
- [Discussion](#)

## Variants

## Views

- [Read](#)
- [View source](#)
- [View history](#)

## More

- This page was last edited on 11 March 2008, at 19:47.

- [Privacy policy](#)
- [About Win-Test Wiki](#)
- [Disclaimers](#)



# File:MicrohamDeviceRouterMKII6.gif

From Win-Test Wiki

[Jump to navigation](#) [Jump to search](#)

- [File](#)
- [File history](#)
- [File usage](#)

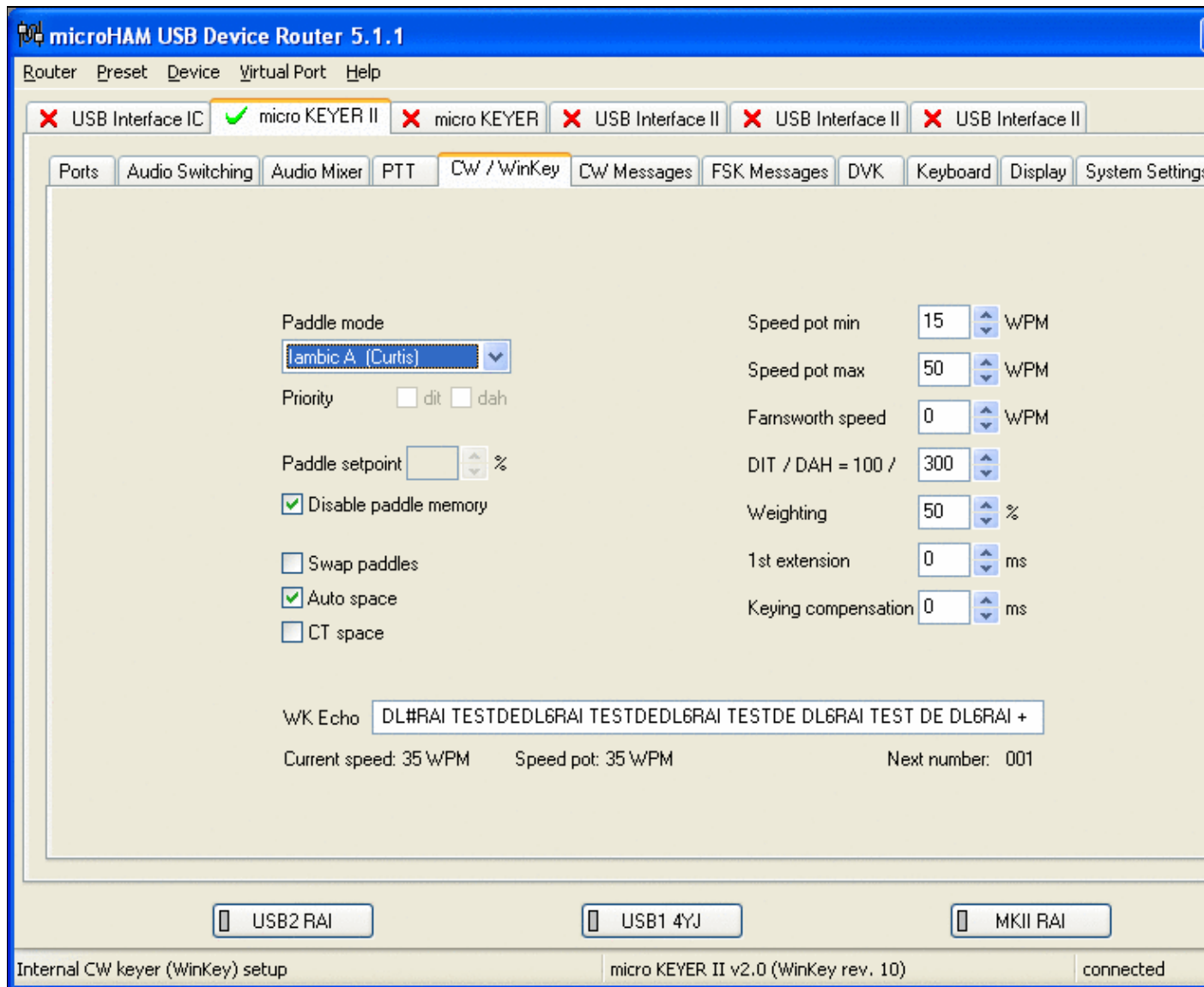

No higher resolution available.

[MicrohamDeviceRouterMKII6.gif](#) (800 × 600 pixels, file size: 37 KB, MIME type: image.gif)

## File history

Click on a date/time to view the file as it appeared at that time.

	Date/Time	Thumbnail	Dimensions	User	Comment
current	<a href="#">20:04, 11 March 2008</a>		800 × 600 (37 KB)	<a href="#">Dl6rai</a> ( <a href="#">talk</a>   <a href="#">contribs</a> )	

You cannot overwrite this file.

## File usage

The following 4 pages use this file:

- [BestPractice10](#)
- [BestPractice5](#)
- [BestPractice6](#)
- [BestPractice8](#)

## Namespaces

- [File](#)
- [Discussion](#)

## Variants

## Views

- [Read](#)
- [View source](#)
- [View history](#)

## More

- This page was last edited on 11 March 2008, at 20:04.

- [Privacy policy](#)
- [About Win-Test Wiki](#)
- [Disclaimers](#)



# File:MicrohamDeviceRouterMKII6.gif

From Win-Test Wiki

[Jump to navigation](#) [Jump to search](#)

- [File](#)
- [File history](#)
- [File usage](#)

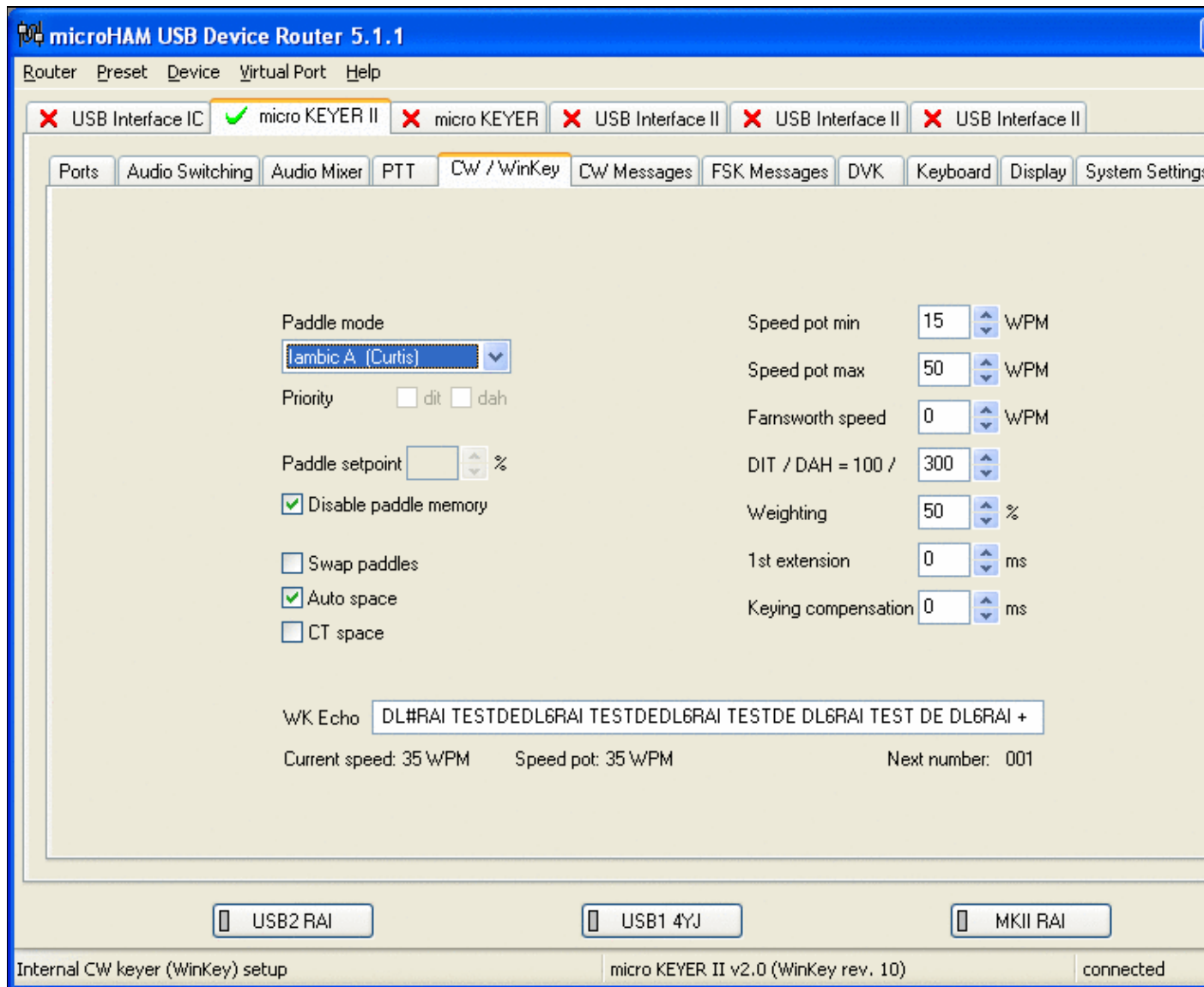

No higher resolution available.

MicrohamDeviceRouterMKII6.gif (800 × 600 pixels, file size: 37 KB, MIME type: image.gif)

## File history

Click on a date/time to view the file as it appeared at that time.

	Date/Time	Thumbnail	Dimensions	User	Comment
current	<u>20:04, 11 March 2008</u>		800 × 600 (37 KB)	<u>Dl6rai</u> ( <span><u>talk</u></span>   <span><u>contribs</u></span> )	

You cannot overwrite this file.

## File usage

The following 4 pages use this file:

- BestPractice10
- BestPractice5
- BestPractice6
- BestPractice8

## Namespaces

- File
- Discussion

## Variants

## Views

- Read
- View source
- View history

## More

- This page was last edited on 11 March 2008, at 20:04.

- Privacy policy
- About Win-Test Wiki
- Disclaimers



# File:MicrohamDeviceRouterMKII7.gif

From Win-Test Wiki

[Jump to navigation](#) [Jump to search](#)

- [File](#)
- [File history](#)
- [File usage](#)

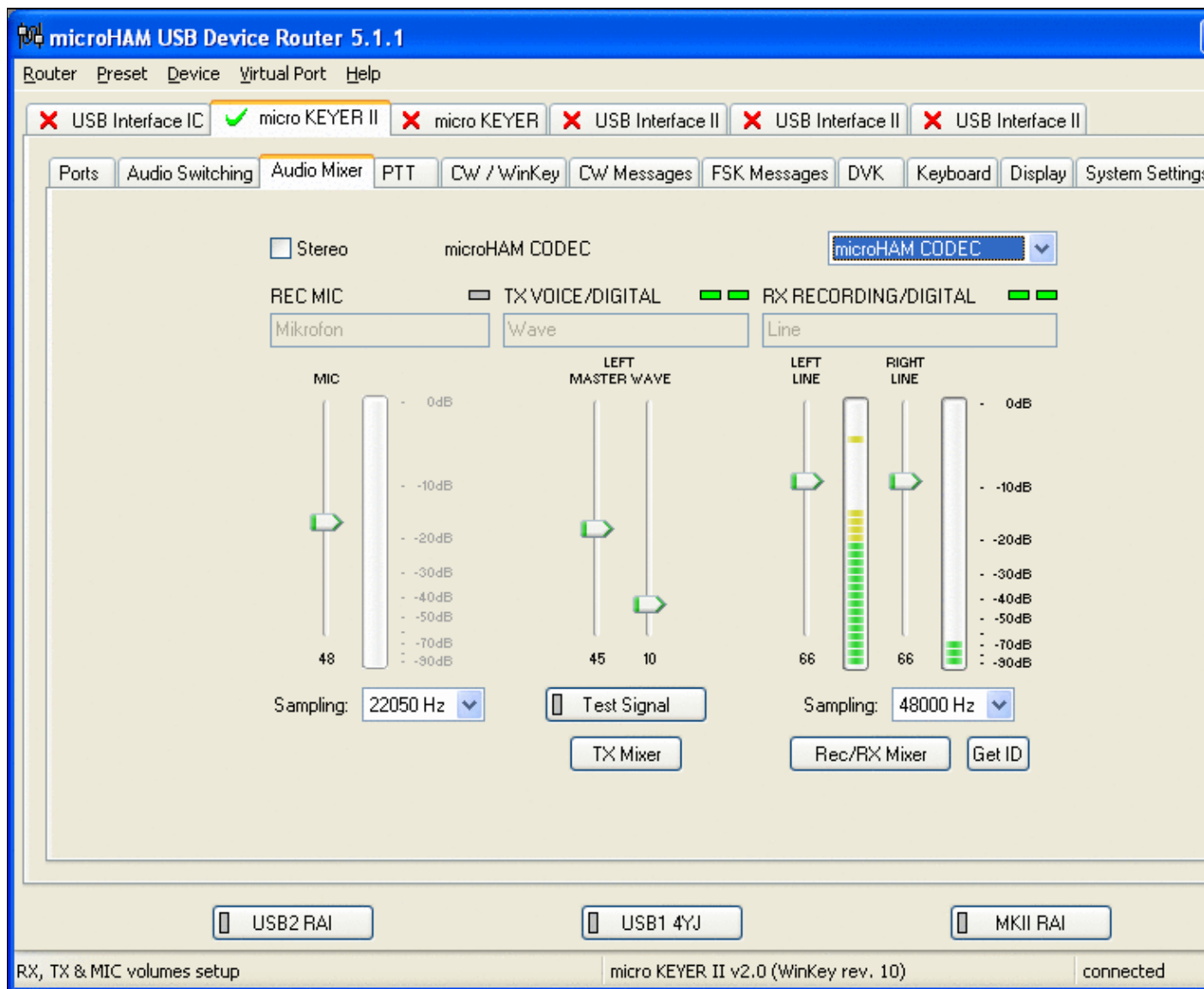

No higher resolution available.

[MicrohamDeviceRouterMKII7.gif](#) (800 × 600 pixels, file size: 38 KB, MIME type: image.gif)

## File history

Click on a date/time to view the file as it appeared at that time.

	Date/Time	Thumbnail	Dimensions	User	Comment
current	<a href="#">20:00, 11 March 2008</a>		800 × 600 (38 KB)	<a href="#">Dl6rai</a> ( <a href="#">talk</a>   <a href="#">contribs</a> )	

You cannot overwrite this file.

## File usage

The following 4 pages use this file:

- [BestPractice10](#)
- [BestPractice5](#)
- [BestPractice6](#)
- [BestPractice8](#)

## Namespaces

- [File](#)
- [Discussion](#)

## Variants

## Views

- [Read](#)
- [View source](#)
- [View history](#)

## More

- This page was last edited on 11 March 2008, at 20:00.

- [Privacy policy](#)
- [About Win-Test Wiki](#)
- [Disclaimers](#)





# File:MicrohamDeviceRouterMKII7.gif

From Win-Test Wiki

[Jump to navigation](#) [Jump to search](#)

- [File](#)
- [File history](#)
- [File usage](#)

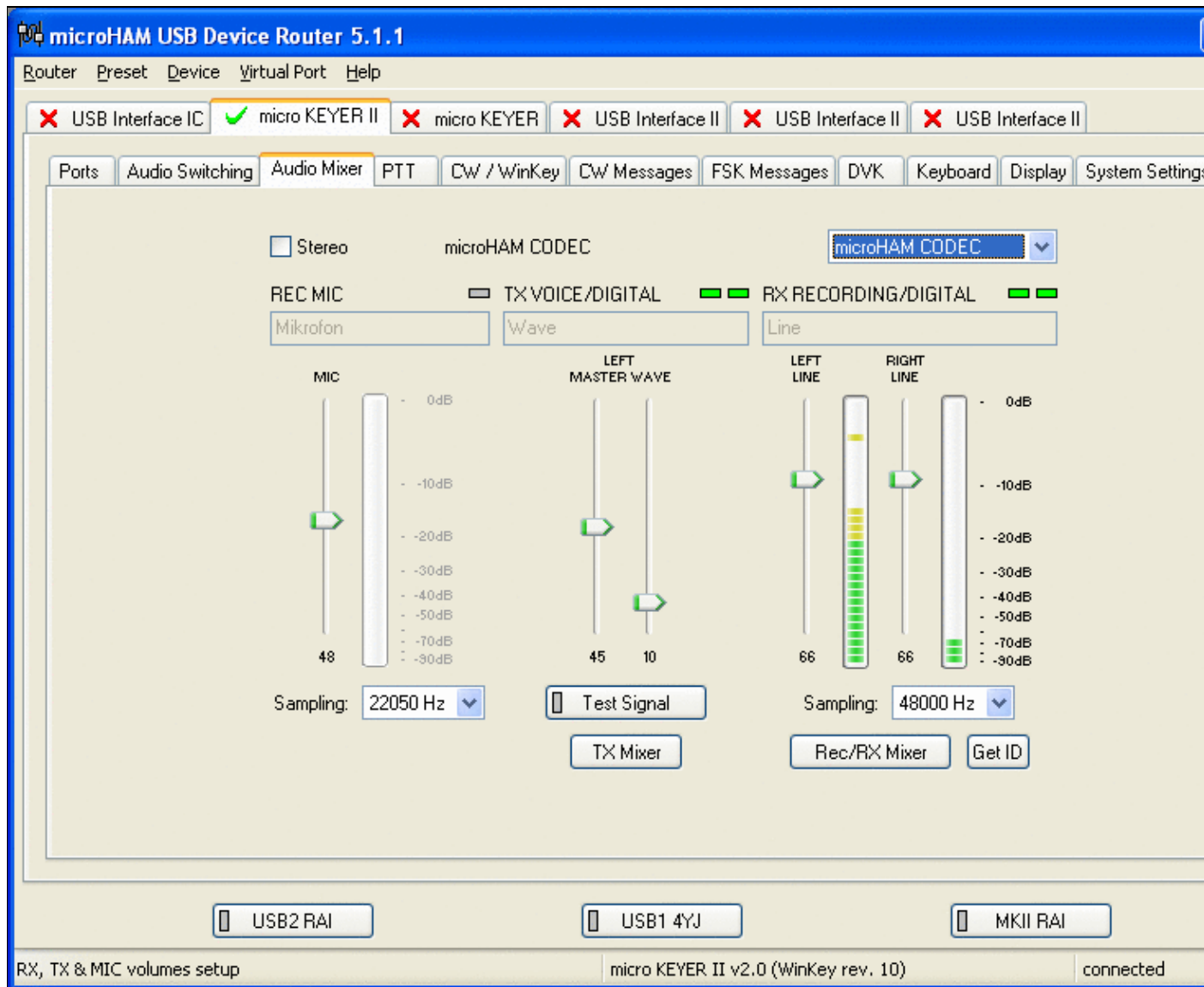

No higher resolution available.

[MicrohamDeviceRouterMKII7.gif](#) (800 × 600 pixels, file size: 38 KB, MIME type: image.gif)

## File history

Click on a date/time to view the file as it appeared at that time.

	Date/Time	Thumbnail	Dimensions	User	Comment
current	<u><a href="#">20:00, 11 March 2008</a></u>		800 × 600 (38 KB)	<u><a href="#">Dl6rai</a></u> ( <u><a href="#">talk</a></u>   <u><a href="#">contribs</a></u> )	

You cannot overwrite this file.

## File usage

The following 4 pages use this file:

- [BestPractice10](#)
- [BestPractice5](#)
- [BestPractice6](#)
- [BestPractice8](#)

## Namespaces

- [File](#)
- [Discussion](#)

## Variants

## Views

- [Read](#)
- [View source](#)
- [View history](#)

## More

- This page was last edited on 11 March 2008, at 20:00.

- [Privacy policy](#)
- [About Win-Test Wiki](#)
- [Disclaimers](#)



# File:MicrohamUsbInterfaceIC.PNG

From Win-Test Wiki

[Jump to navigation](#) [Jump to search](#)

- [File](#)
- [File history](#)
- [File usage](#)

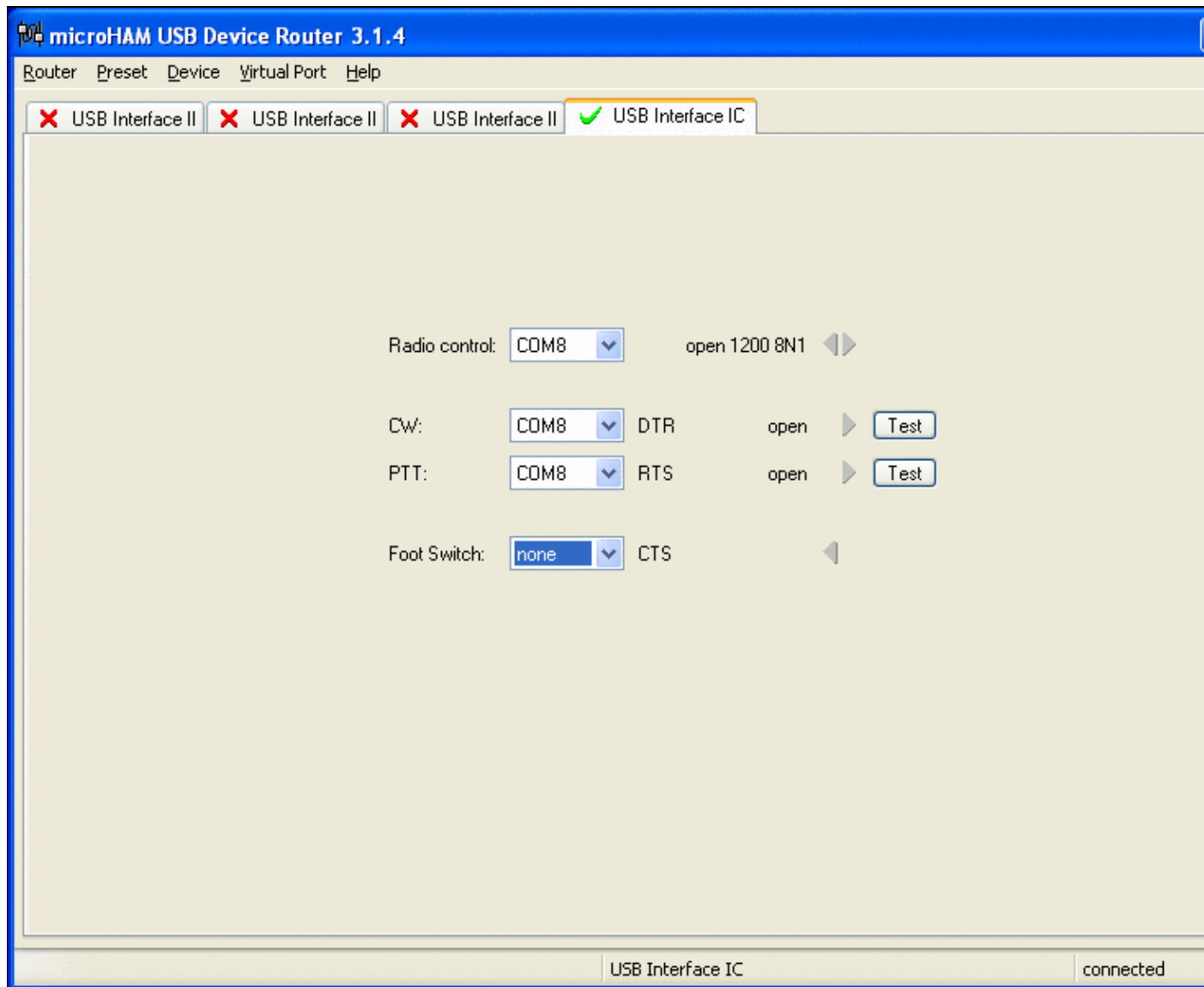



No higher resolution available.

MicrohamUsbInterfaceIC.PNG (800 × 600 pixels, file size: 26 KB, MIME type: image.gif)

## File history

Click on a date/time to view the file as it appeared at that time.

	Date/Time	Thumbnail	Dimensions	User	Comment
current	<u>10:00, 17 May 2007</u>		800 × 600 (26 KB)	<u>Dl6rai</u> ( <a href="#">talk</a>   <a href="#">contribs</a> )	
	<u>07:56, 17 May 2007</u>		800 × 600 (26 KB)	<u>Dl6rai</u> ( <a href="#">talk</a>   <a href="#">contribs</a> )	

You cannot overwrite this file.

## File usage

The following file is a duplicate of this file ([more details](#)):

- File:MicrohamUsbInterfaceIC.PNG

The following page uses this file:

- BestPractice3

## Namespaces

- File
- Discussion

## Variants

## Views

- Read
- View source
- View history

## More

- This page was last edited on 17 May 2007, at 07:56.
- Privacy policy

## Win-Test Wiki

- [About Win-Test Wiki](#)
- [Disclaimers](#)



# File:MicrohamUsbInterfaceIC.PNG

From Win-Test Wiki

[Jump to navigation](#) [Jump to search](#)

- [File](#)
- [File history](#)
- [File usage](#)

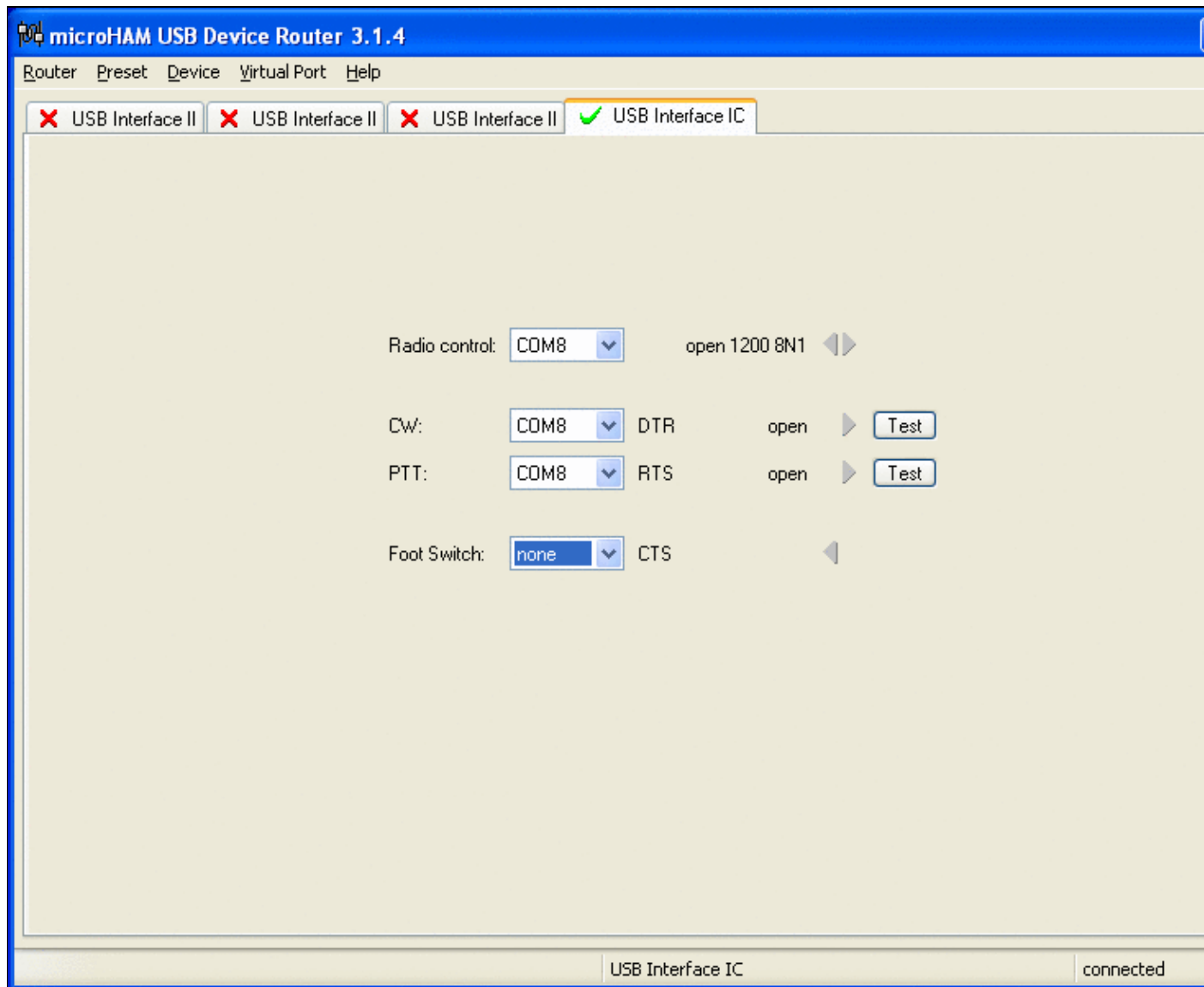



No higher resolution available.

MicrohamUsbInterfaceIC.PNG (800 × 600 pixels, file size: 26 KB, MIME type: image.gif)

## File history

Click on a date/time to view the file as it appeared at that time.

	Date/Time	Thumbnail	Dimensions	User	Comment
current	<u>10:00, 17 May 2007</u>		800 × 600 (26 KB)	<u>Dl6rai</u> ( <a href="#">talk</a>   <a href="#">contribs</a> )	
	<u>07:56, 17 May 2007</u>		800 × 600 (26 KB)	<u>Dl6rai</u> ( <a href="#">talk</a>   <a href="#">contribs</a> )	

You cannot overwrite this file.

## File usage

The following file is a duplicate of this file ([more details](#)):

- File:MicrohamUsbInterfaceIC.PNG

The following page uses this file:

- BestPractice3

## Namespaces

- File
- Discussion

## Variants

## Views

- Read
- View source
- View history

## More

- This page was last edited on 17 May 2007, at 07:56.
- Privacy policy

## Win-Test Wiki

- [About Win-Test Wiki](#)
- [Disclaimers](#)





# File:MK2Rsetup1.jpg

From Win-Test Wiki

[Jump to navigation](#) [Jump to search](#)

- [File](#)
- [File history](#)
- [File usage](#)

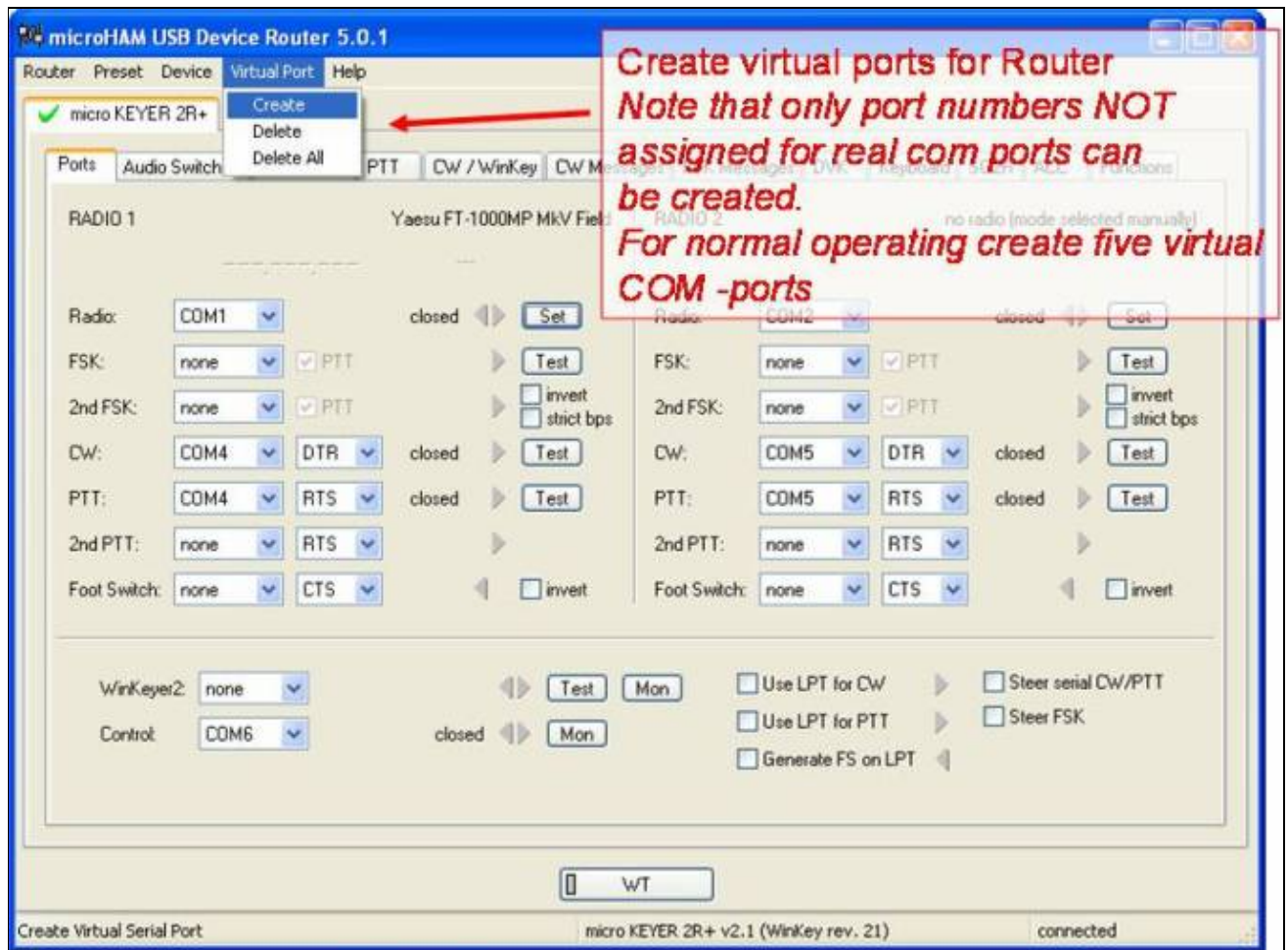



No higher resolution available.

[MK2Rsetup1.jpg](#) (681 × 506 pixels, file size: 60 KB, MIME type: image/jpeg)

MK2R Device Router com ports configuration

## File history

Click on a date/time to view the file as it appeared at that time.

	Date/Time	Thumbnail	Dimensions	User	Comment
current	<a href="#">08:29, 19 November 2007</a>		681 × 506 (60 KB)	<a href="#">I2WIJ (talk   contribs)</a>	
	<a href="#">21:16, 18 November 2007</a>		811 × 602 (90 KB)	<a href="#">I2WIJ (talk   contribs)</a>	MK2R Device Router com ports configuration

You cannot overwrite this file.

## File usage

The following page uses this file:

- [SO2R/MK2R](#)

## Namespaces

- [File](#)
- [Discussion](#)

## Variants

## Views

- [Read](#)
- [View source](#)
- [View history](#)

## More

- This page was last edited on 18 November 2007, at 21:16.
- [Privacy policy](#)
- [About Win-Test Wiki](#)
- [Disclaimers](#)



# File:MK2Rsetup14.jpg

From Win-Test Wiki

[Jump to navigation](#) [Jump to search](#)

- [File](#)
- [File history](#)
- [File usage](#)

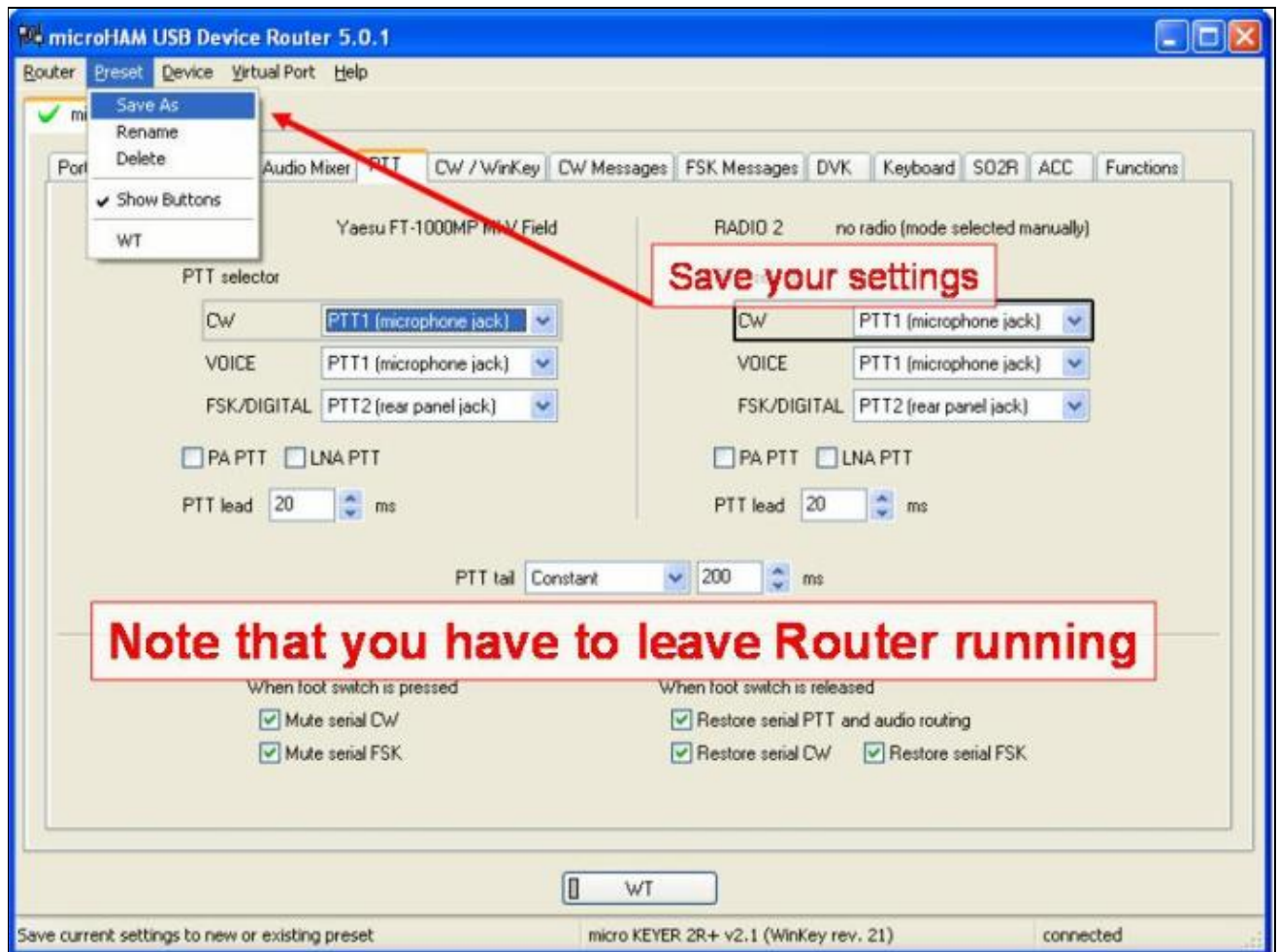



No higher resolution available.

MK2Rsetup14.jpg (682 × 512 pixels, file size: 58 KB, MIME type: image/jpeg)

MK2R Device Router SAVE Settings configuration

## File history

Click on a date/time to view the file as it appeared at that time.

	Date/Time	Thumbnail	Dimensions	User	Comment
current	<a href="#">08:32, 19 November 2007</a>		682 × 512 (58 KB)	<a href="#">I2WIJ (talk   contribs)</a>	
	<a href="#">21:28, 18 November 2007</a>		802 × 602 (89 KB)	<a href="#">I2WIJ (talk   contribs)</a>	MK2R Device Router SAVE Settings configuration

You cannot overwrite this file.

## File usage

The following page uses this file:

- [SO2R/MK2R](#)

## Namespaces

- [File](#)
- [Discussion](#)

## Variants

## Views

- [Read](#)
- [View source](#)
- [View history](#)

## More

- This page was last edited on 18 November 2007, at 21:28.
- [Privacy policy](#)
- [About Win-Test Wiki](#)
- [Disclaimers](#)



# File:MK2Rsetup14.jpg

From Win-Test Wiki

[Jump to navigation](#) [Jump to search](#)

- [File](#)
- [File history](#)
- [File usage](#)

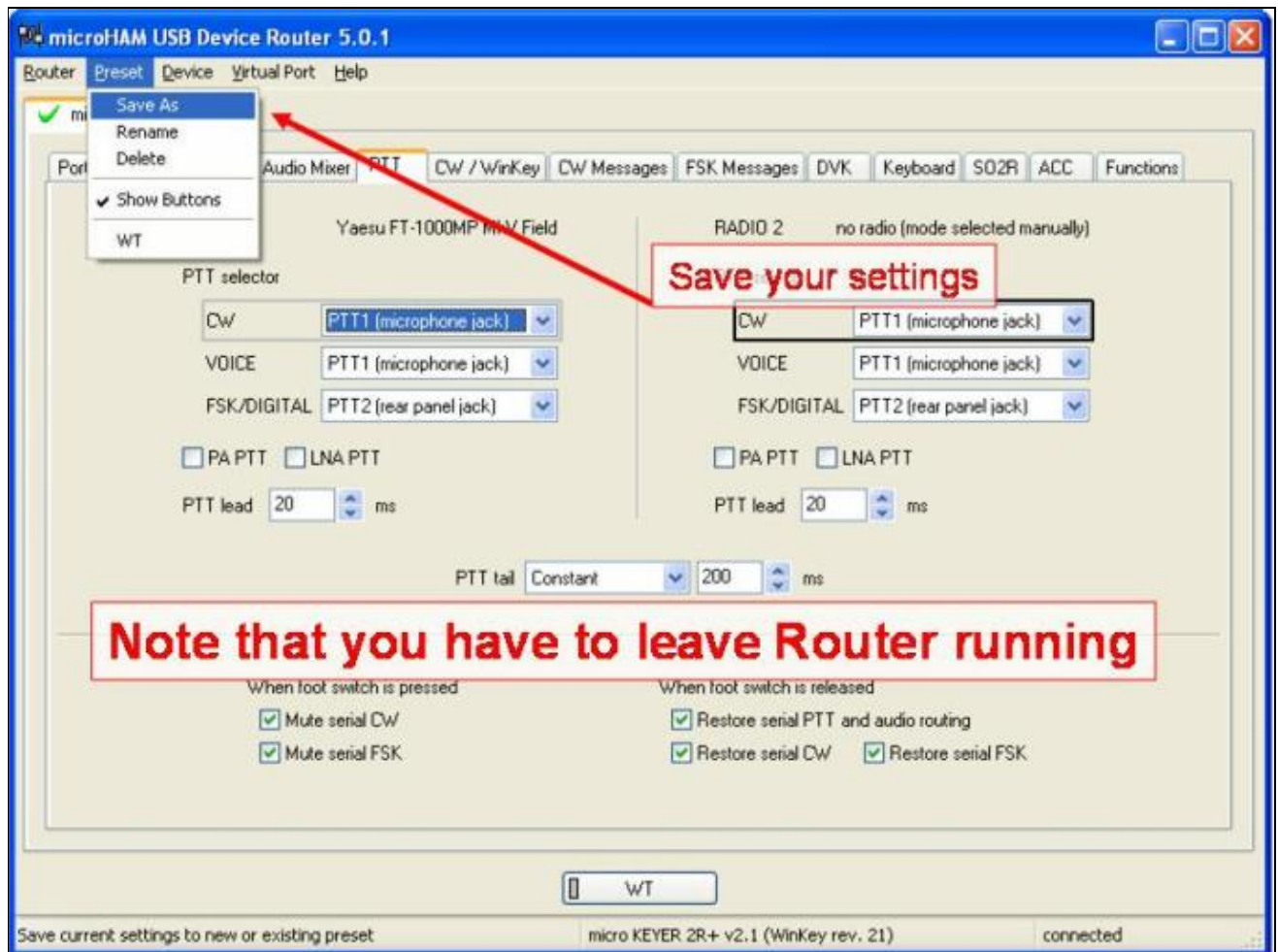



No higher resolution available.

[MK2Rsetup14.jpg](#) (682 × 512 pixels, file size: 58 KB, MIME type: image/jpeg)

MK2R Device Router SAVE Settings configuration

## File history

Click on a date/time to view the file as it appeared at that time.

	Date/Time	Thumbnail	Dimensions	User	Comment
current	<a href="#">08:32, 19 November 2007</a>		682 × 512 (58 KB)	<a href="#">I2WIJ (talk   contribs)</a>	
	<a href="#">21:28, 18 November 2007</a>		802 × 602 (89 KB)	<a href="#">I2WIJ (talk   contribs)</a>	MK2R Device Router SAVE Settings configuration

You cannot overwrite this file.

## File usage

The following page uses this file:

- [SO2R/MK2R](#)

## Namespaces

- [File](#)
- [Discussion](#)

## Variants

## Views

- [Read](#)
- [View source](#)
- [View history](#)

## More

- This page was last edited on 18 November 2007, at 21:28.
- [Privacy policy](#)
- [About Win-Test Wiki](#)
- [Disclaimers](#)





# File:MK2Rsetup15.jpg

From Win-Test Wiki

[Jump to navigation](#) [Jump to search](#)

- [File](#)
- [File history](#)
- [File usage](#)

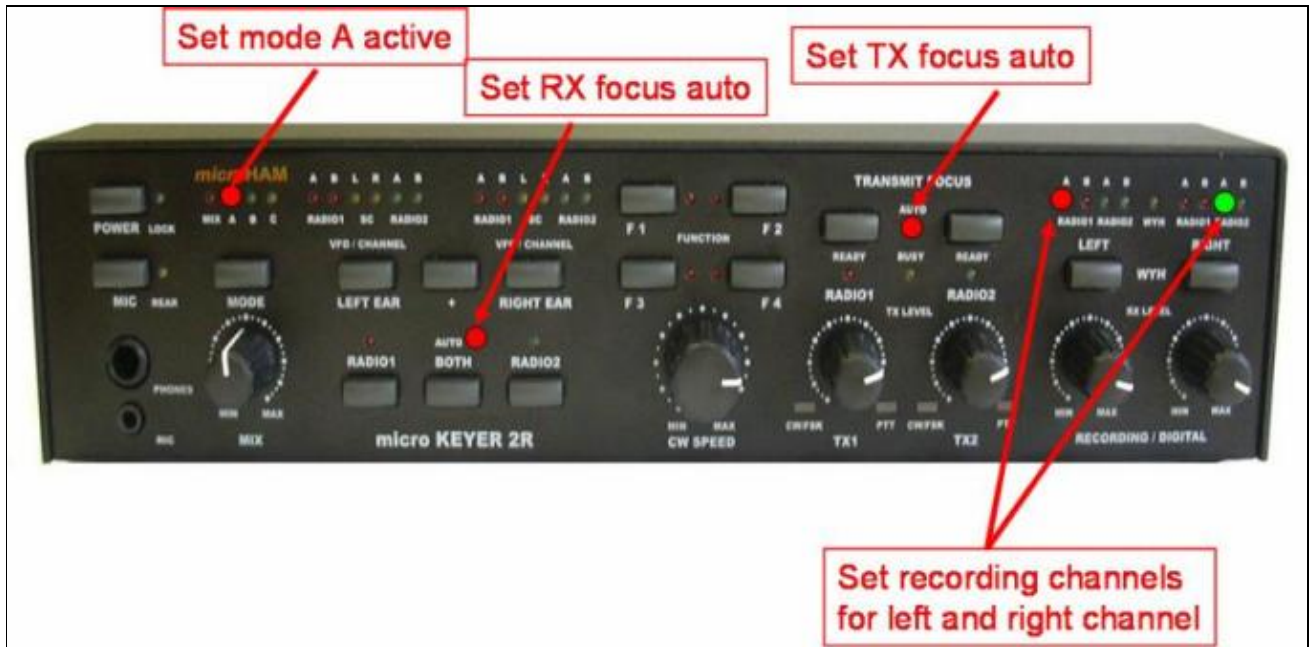



No higher resolution available.

[MK2Rsetup15.jpg](#) (680 × 336 pixels, file size: 33 KB, MIME type: image/jpeg)

MK2R Device Router overall view

## File history

Click on a date/time to view the file as it appeared at that time.

	Date/Time	Thumbnail	Dimensions	User	Comment
current	<a href="#">08:28, 19 November 2007</a>		680 × 336 (33 KB)	<a href="#">I2WIJ (talk   contribs)</a>	
	<a href="#">21:31, 18 November 2007</a>		800 × 395 (47 KB)	<a href="#">I2WIJ (talk   contribs)</a>	MK2R Device Router overall view

You cannot overwrite this file.

## File usage

The following page uses this file:

- [SO2R/MK2R](#)

## Namespaces

- [File](#)
- [Discussion](#)

## Variants

## Views

- [Read](#)
- [View source](#)
- [View history](#)

## More

- This page was last edited on 18 November 2007, at 21:31.

- [Privacy policy](#)
- [About Win-Test Wiki](#)
- [Disclaimers](#)



# File:MK2Rsetup15.jpg

From Win-Test Wiki

[Jump to navigation](#) [Jump to search](#)

- [File](#)
- [File history](#)
- [File usage](#)

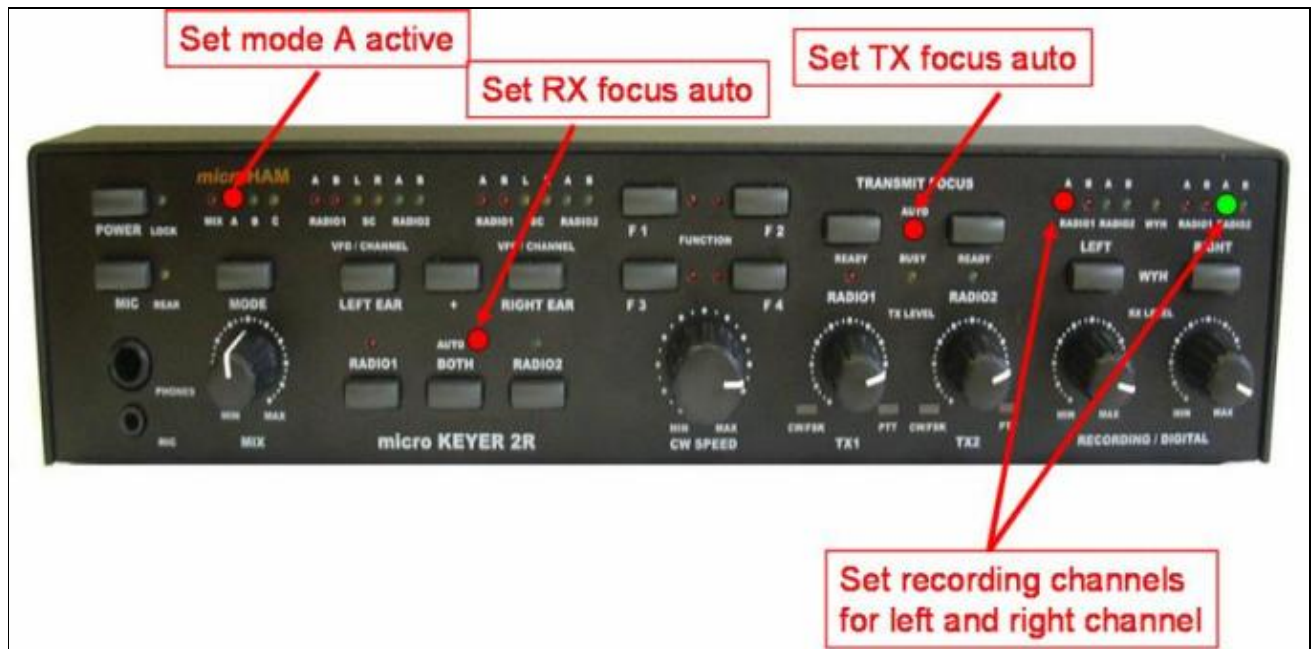



No higher resolution available.

[MK2Rsetup15.jpg](#) (680 × 336 pixels, file size: 33 KB, MIME type: image/jpeg)

MK2R Device Router overall view

## File history

Click on a date/time to view the file as it appeared at that time.

	Date/Time	Thumbnail	Dimensions	User	Comment
current	<a href="#">08:28, 19 November 2007</a>		680 × 336 (33 KB)	<a href="#">I2WIJ (talk   contribs)</a>	
	<a href="#">21:31, 18 November 2007</a>		800 × 395 (47 KB)	<a href="#">I2WIJ (talk   contribs)</a>	MK2R Device Router overall view

You cannot overwrite this file.

## File usage

The following page uses this file:

- [SO2R/MK2R](#)

## Namespaces

- [File](#)
- [Discussion](#)

## Variants

## Views

- [Read](#)
- [View source](#)
- [View history](#)

## More

- This page was last edited on 18 November 2007, at 21:31.
- [Privacy policy](#)
- [About Win-Test Wiki](#)
- [Disclaimers](#)



# File:MK2Rsetup1.jpg

From Win-Test Wiki

[Jump to navigation](#) [Jump to search](#)

- [File](#)
- [File history](#)
- [File usage](#)

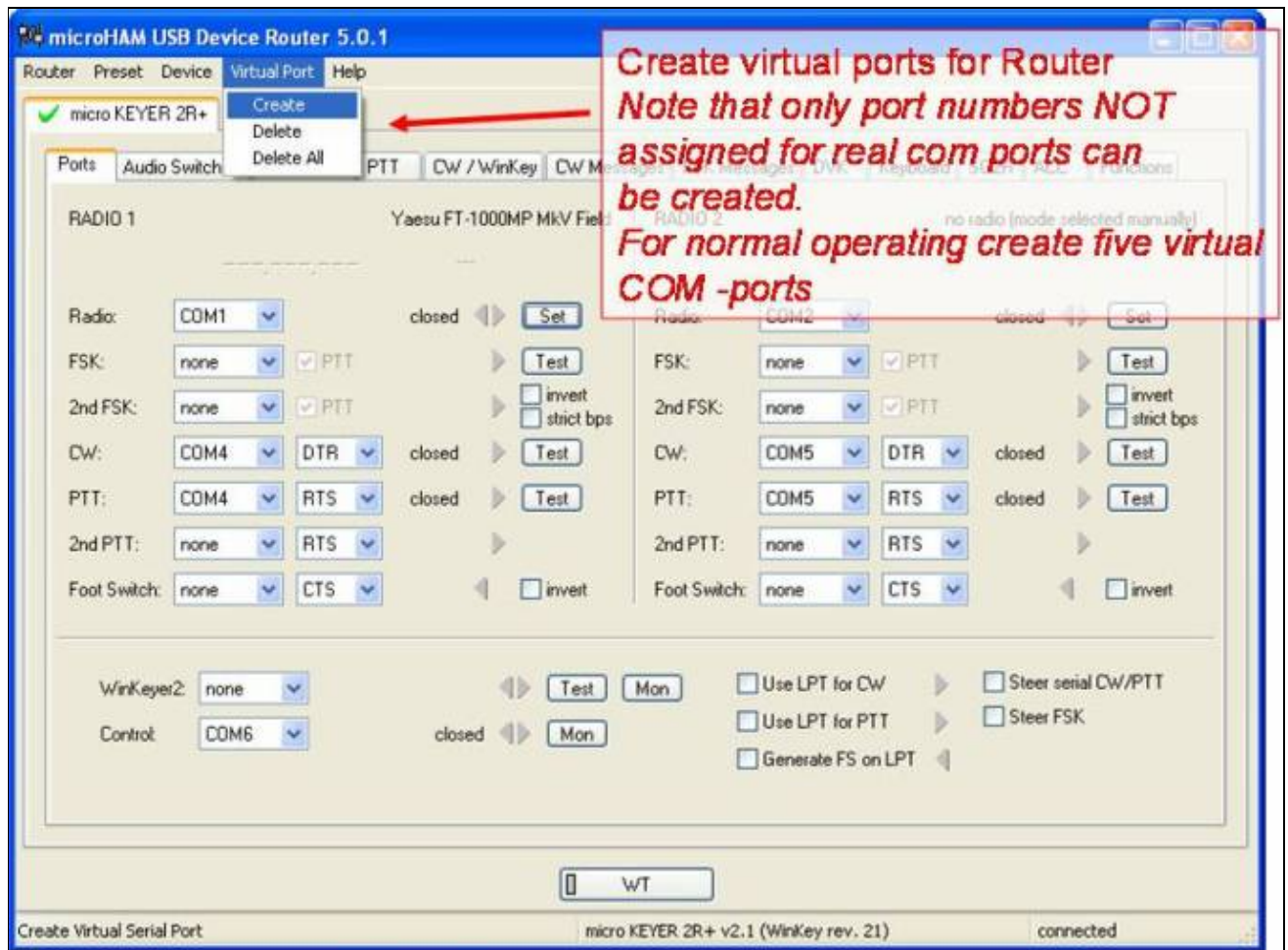



No higher resolution available.

[MK2Rsetup1.jpg](#) (681 × 506 pixels, file size: 60 KB, MIME type: image/jpeg)

MK2R Device Router com ports configuration

## File history

Click on a date/time to view the file as it appeared at that time.

	Date/Time	Thumbnail	Dimensions	User	Comment
current	<a href="#">08:29, 19 November 2007</a>		681 × 506 (60 KB)	<a href="#">I2WIJ (talk   contribs)</a>	
	<a href="#">21:16, 18 November 2007</a>		811 × 602 (90 KB)	<a href="#">I2WIJ (talk   contribs)</a>	MK2R Device Router com ports configuration

You cannot overwrite this file.

## File usage

The following page uses this file:

- [SO2R/MK2R](#)

## Namespaces

- [File](#)
- [Discussion](#)

## Variants

## Views

- [Read](#)
- [View source](#)
- [View history](#)

## More

- This page was last edited on 18 November 2007, at 21:16.
- [Privacy policy](#)
- [About Win-Test Wiki](#)
- [Disclaimers](#)





# File:MK2R Slide10.JPG

From Win-Test Wiki

[Jump to navigation](#) [Jump to search](#)

- [File](#)
- [File history](#)
- [File usage](#)

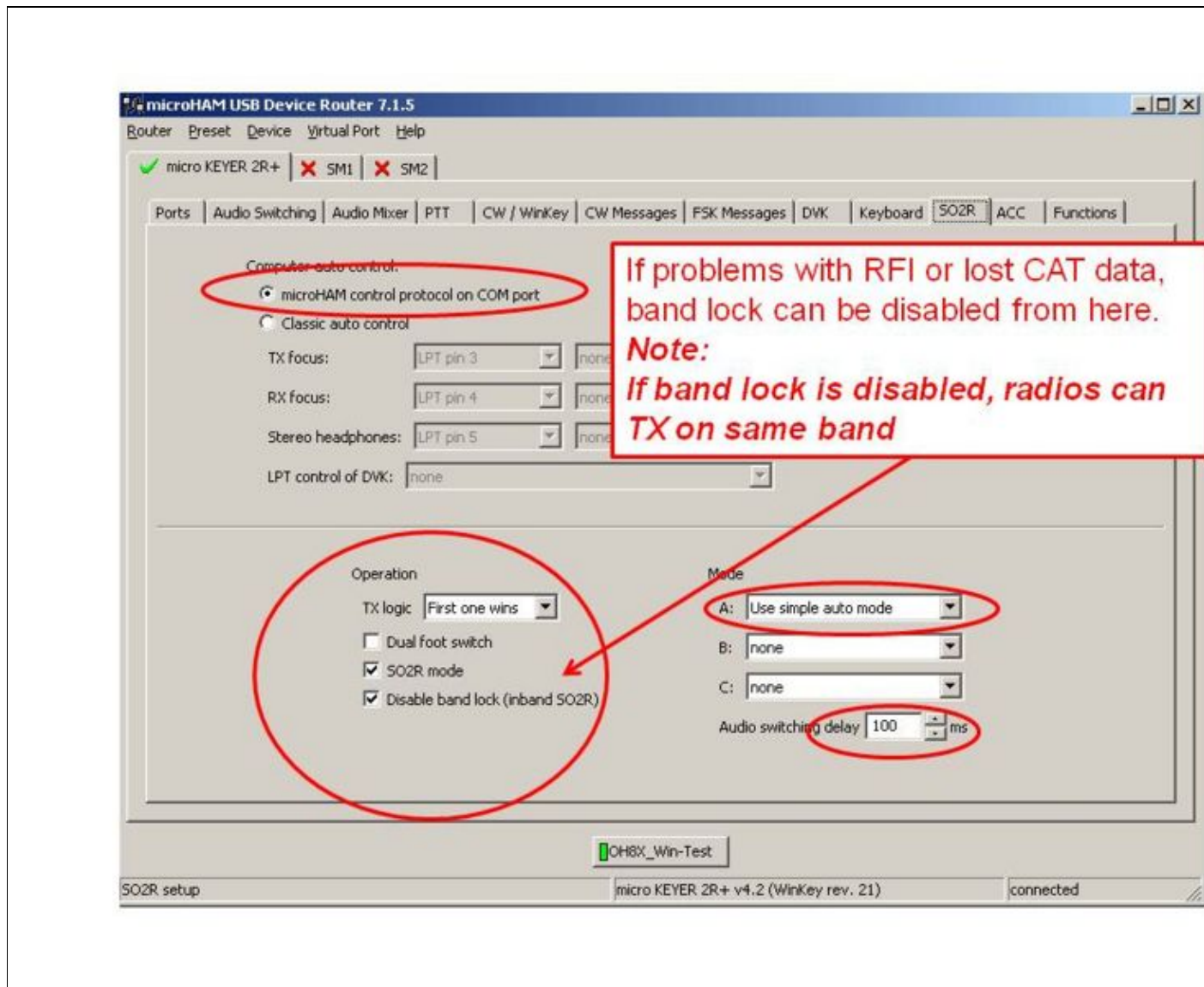

Size of this preview: [800 Å 600 pixels](#). Other resolutions: [320 Å 240 pixels](#) | [960 Å 720 pixels](#).  
[Original file](#) (960 Å 720 pixels, file size: 82 KB, MIME type: image/jpeg)

## File history

Click on a date/time to view the file as it appeared at that time.

	Date/Time	Thumbnail	Dimensions	User	Comment
current	<a href="#">08:52, 16 October 2008</a>		960 Å 720 (82 KB)	<a href="#">Oh2ua</a> ( <a href="#">talk</a>   <a href="#">contribs</a> )	

You cannot overwrite this file.

## File usage

The following page uses this file:

- [SO2R/MK2R](#)

## Namespaces

- [File](#)
- [Discussion](#)

## Variants

## Views

- [Read](#)
- [View source](#)
- [View history](#)

## More

- This page was last edited on 16 October 2008, at 08:52.

- [Privacy policy](#)
- [About Win-Test Wiki](#)
- [Disclaimers](#)



# File:MK2R Slide10.JPG

From Win-Test Wiki

[Jump to navigation](#) [Jump to search](#)

- [File](#)
- [File history](#)
- [File usage](#)

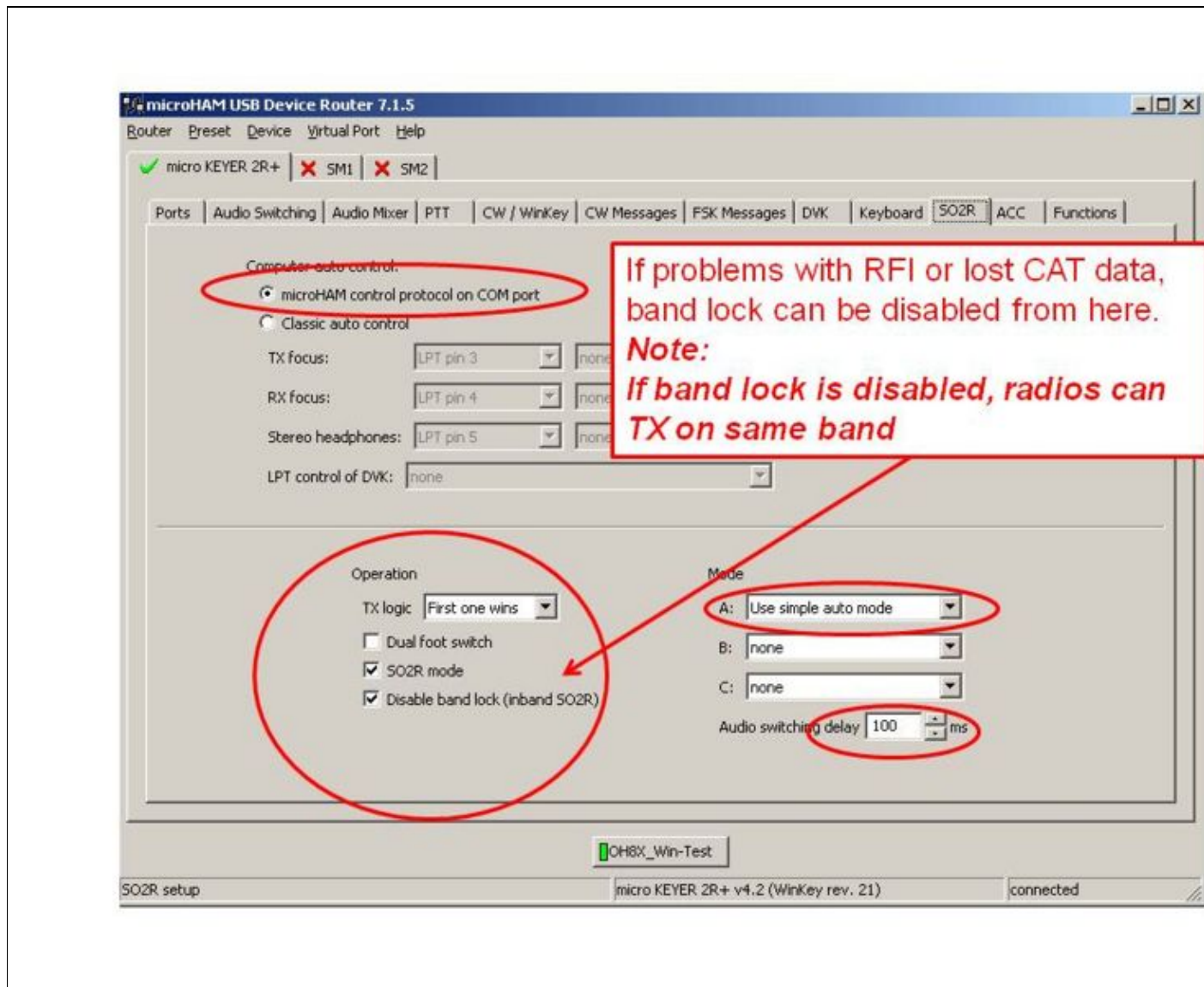

Size of this preview: [800 Å 600 pixels](#). Other resolutions: [320 Å 240 pixels](#) | [960 Å 720 pixels](#).  
[Original file](#) (960 Å 720 pixels, file size: 82 KB, MIME type: image/jpeg)

## File history

Click on a date/time to view the file as it appeared at that time.

	Date/Time	Thumbnail	Dimensions	User	Comment
current	<a href="#">08:52, 16 October 2008</a>		960 Å 720 (82 KB)	<a href="#">Oh2ua</a> ( <a href="#">talk</a>   <a href="#">contribs</a> )	

You cannot overwrite this file.

## File usage

The following page uses this file:

- [SO2R/MK2R](#)

## Namespaces

- [File](#)
- [Discussion](#)

## Variants

## Views

- [Read](#)
- [View source](#)
- [View history](#)

## More

- This page was last edited on 16 October 2008, at 08:52.

- [Privacy policy](#)
- [About Win-Test Wiki](#)
- [Disclaimers](#)



# File:MK2R Slide11.JPG

From Win-Test Wiki

[Jump to navigation](#) [Jump to search](#)

- [File](#)
- [File history](#)
- [File usage](#)

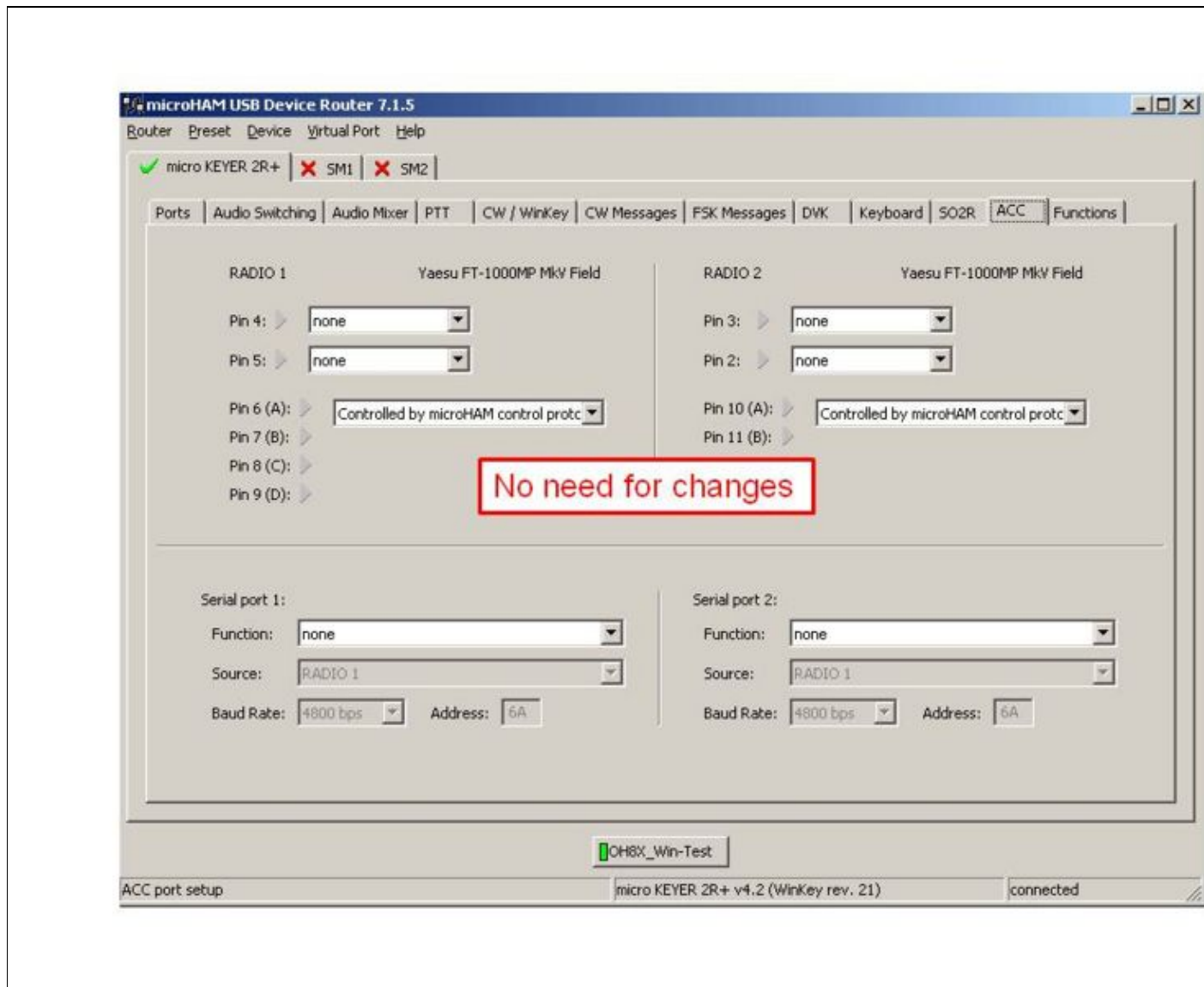

Size of this preview: [800 Å 600 pixels](#). Other resolutions: [320 Å 240 pixels](#) | [960 Å 720 pixels](#).  
[Original file](#) (960 Å 720 pixels, file size: 67 KB, MIME type: image/jpeg)

## File history

Click on a date/time to view the file as it appeared at that time.

	Date/Time	Thumbnail	Dimensions	User	Comment
current	<a href="#">08:52, 16 October 2008</a>		960 Å 720 (67 KB)	<a href="#">Oh2ua</a> ( <a href="#">talk</a>   <a href="#">contribs</a> )	

You cannot overwrite this file.

## File usage

The following page uses this file:

- [SO2R/MK2R](#)

## Namespaces

- [File](#)
- [Discussion](#)

## Variants

## Views

- [Read](#)
- [View source](#)
- [View history](#)

## More

- This page was last edited on 16 October 2008, at 08:52.

- [Privacy policy](#)
- [About Win-Test Wiki](#)
- [Disclaimers](#)



# File:MK2R Slide11.JPG

From Win-Test Wiki

[Jump to navigation](#) [Jump to search](#)

- [File](#)
- [File history](#)
- [File usage](#)

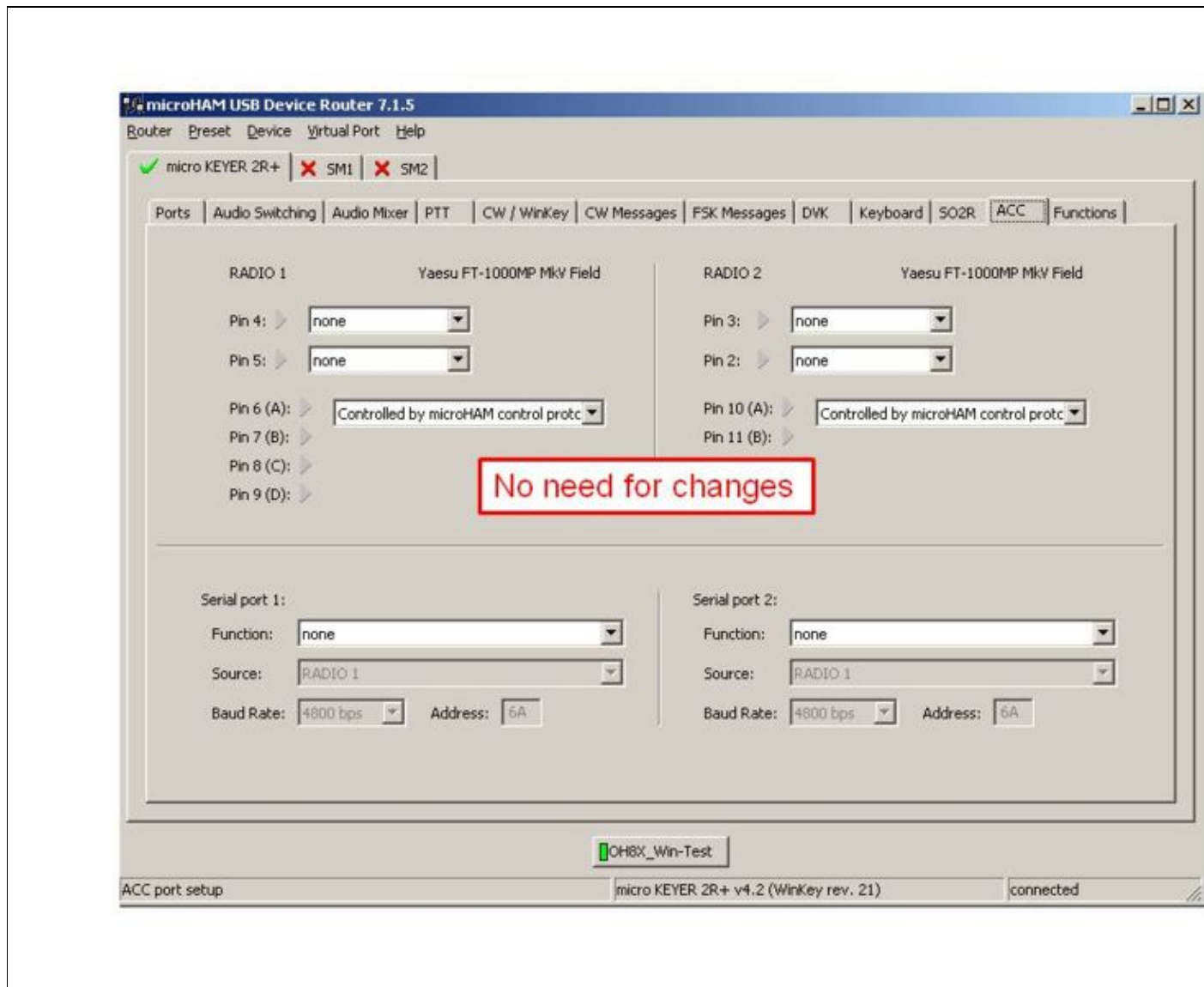

Size of this preview: [800 Å 600 pixels](#). Other resolutions: [320 Å 240 pixels](#) | [960 Å 720 pixels](#).  
[Original file](#) (960 Å 720 pixels, file size: 67 KB, MIME type: image/jpeg)

## File history

Click on a date/time to view the file as it appeared at that time.

	Date/Time	Thumbnail	Dimensions	User	Comment
current	<a href="#">08:52, 16 October 2008</a>		960 Å 720 (67 KB)	<a href="#">Oh2ua</a> ( <a href="#">talk</a>   <a href="#">contribs</a> )	

You cannot overwrite this file.

## File usage

The following page uses this file:

- [SO2R/MK2R](#)

## Namespaces

- [File](#)
- [Discussion](#)

## Variants

## Views

- [Read](#)
- [View source](#)
- [View history](#)

## More

- This page was last edited on 16 October 2008, at 08:52.

- [Privacy policy](#)
- [About Win-Test Wiki](#)
- [Disclaimers](#)





# File:MK2R Slide12.JPG

From Win-Test Wiki

[Jump to navigation](#) [Jump to search](#)

- [File](#)
- [File history](#)
- [File usage](#)

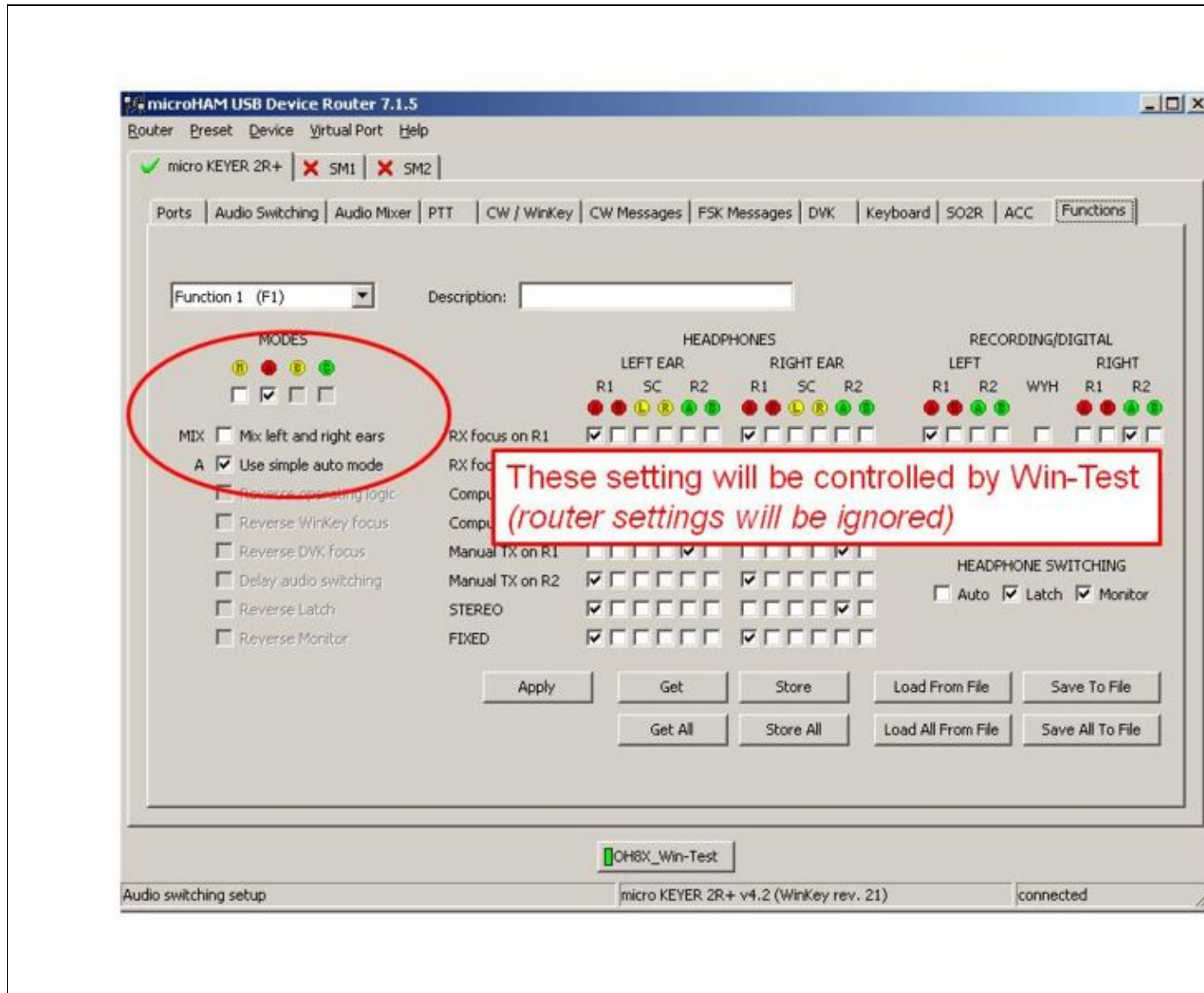

Size of this preview: [800 Å 600 pixels](#). Other resolutions: [320 Å 240 pixels](#) | [960 Å 720 pixels](#).  
[Original file](#) (960 Å 720 pixels, file size: 85 KB, MIME type: image/jpeg)

## File history

Click on a date/time to view the file as it appeared at that time.

	Date/Time	Thumbnail	Dimensions	User	Comment
current	<a href="#">08:53, 16 October 2008</a>		960 Å 720 (85 KB)	<a href="#">Oh2ua</a> ( <a href="#">talk</a>   <a href="#">contribs</a> )	

You cannot overwrite this file.

## File usage

The following page uses this file:

- [SO2R/MK2R](#)

## Namespaces

- [File](#)
- [Discussion](#)

## Variants

## Views

- [Read](#)
- [View source](#)
- [View history](#)

## More

- This page was last edited on 16 October 2008, at 08:53.

- [Privacy policy](#)
- [About Win-Test Wiki](#)
- [Disclaimers](#)



# File:MK2R Slide12.JPG

From Win-Test Wiki

[Jump to navigation](#) [Jump to search](#)

- [File](#)
- [File history](#)
- [File usage](#)

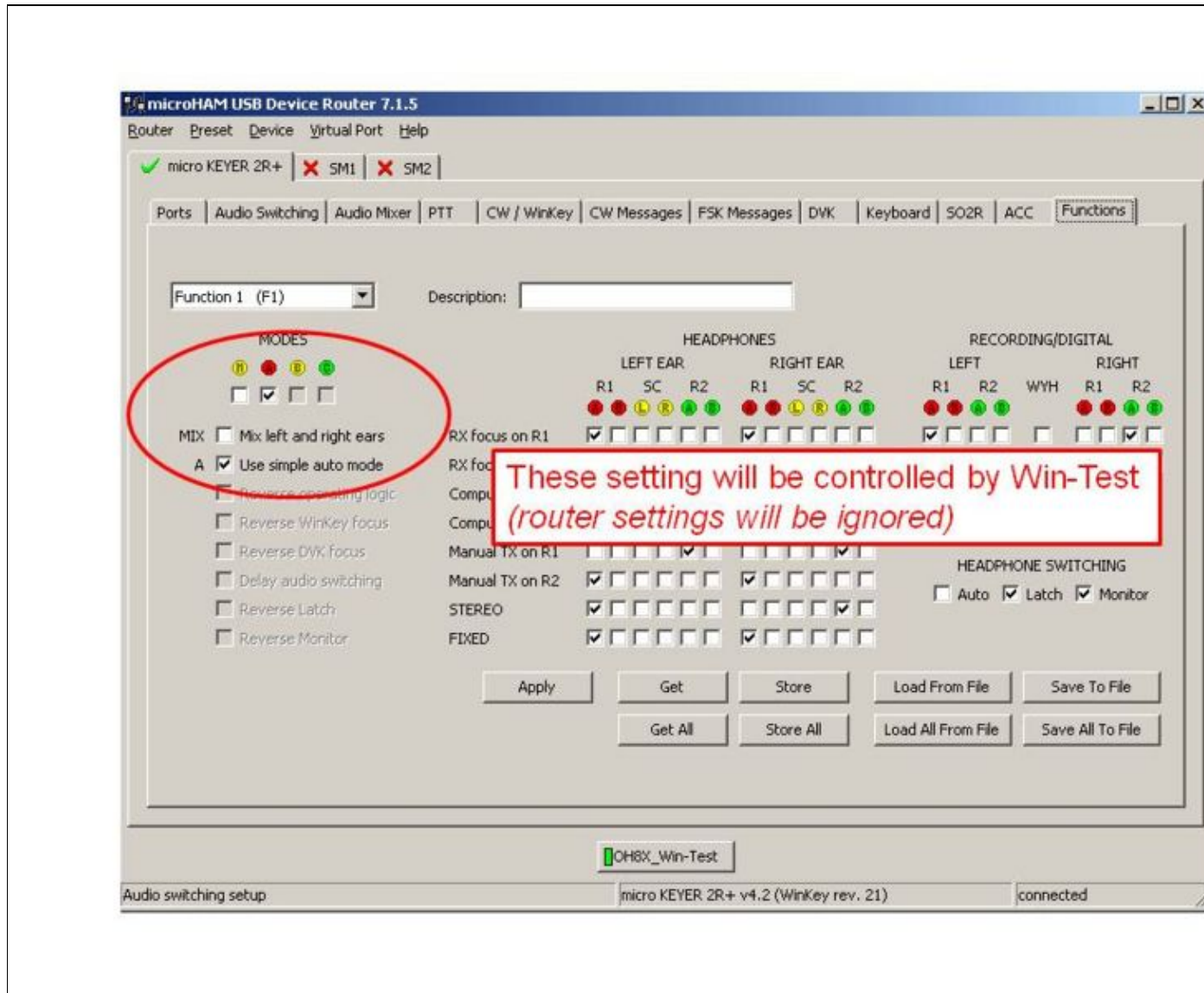

Size of this preview: [800 Å 600 pixels](#). Other resolutions: [320 Å 240 pixels](#) | [960 Å 720 pixels](#).  
[Original file](#) (960 Å 720 pixels, file size: 85 KB, MIME type: image/jpeg)

## File history

Click on a date/time to view the file as it appeared at that time.

	Date/Time	Thumbnail	Dimensions	User	Comment
current	<a href="#">08:53, 16 October 2008</a>		960 Å 720 (85 KB)	<a href="#">Oh2ua</a> ( <a href="#">talk</a>   <a href="#">contribs</a> )	

You cannot overwrite this file.

## File usage

The following page uses this file:

- [SO2R/MK2R](#)

## Namespaces

- [File](#)
- [Discussion](#)

## Variants

## Views

- [Read](#)
- [View source](#)
- [View history](#)

## More

- This page was last edited on 16 October 2008, at 08:53.

- [Privacy policy](#)
- [About Win-Test Wiki](#)
- [Disclaimers](#)



# File:MK2R Slide13.JPG

From Win-Test Wiki

[Jump to navigation](#) [Jump to search](#)

- [File](#)
- [File history](#)
- [File usage](#)

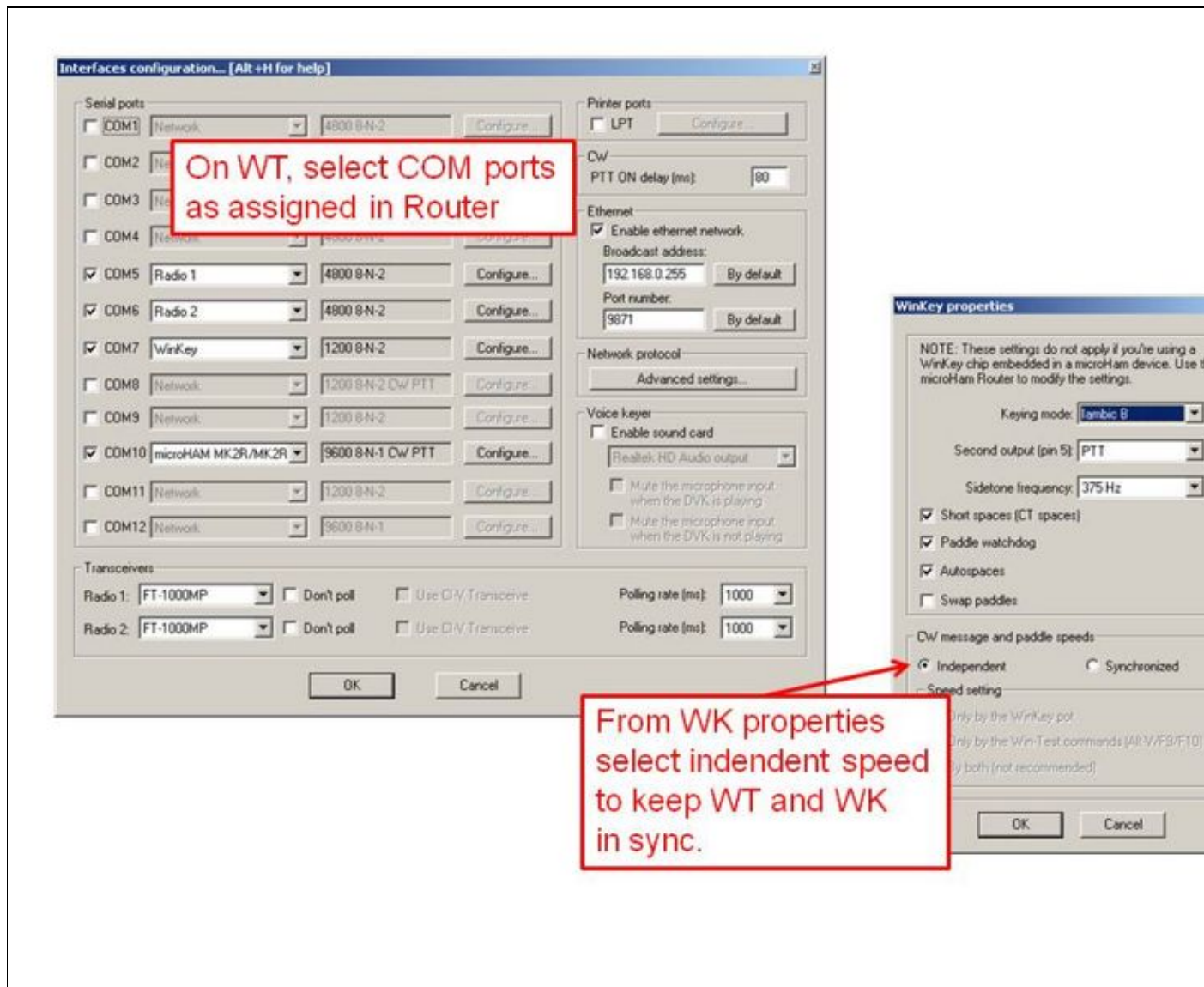

Size of this preview: [800 Å 600 pixels](#). Other resolutions: [320 Å 240 pixels](#) | [960 Å 720 pixels](#).  
[Original file](#) (960 Å 720 pixels, file size: 88 KB, MIME type: image/jpeg)

## File history

Click on a date/time to view the file as it appeared at that time.

	Date/Time	Thumbnail	Dimensions	User	Comment
current	<a href="#">08:53, 16 October 2008</a>		960 Å 720 (88 KB)	<a href="#">Oh2ua</a> ( <a href="#">talk</a>   <a href="#">contribs</a> )	

You cannot overwrite this file.

## File usage

The following page uses this file:

- [SO2R/MK2R](#)

## Namespaces

- [File](#)
- [Discussion](#)

## Variants

## Views

- [Read](#)
- [View source](#)
- [View history](#)

## More

- This page was last edited on 16 October 2008, at 08:53.

- [Privacy policy](#)
- [About Win-Test Wiki](#)
- [Disclaimers](#)



# File:MK2R Slide13.JPG

From Win-Test Wiki

[Jump to navigation](#) [Jump to search](#)

- [File](#)
- [File history](#)
- [File usage](#)

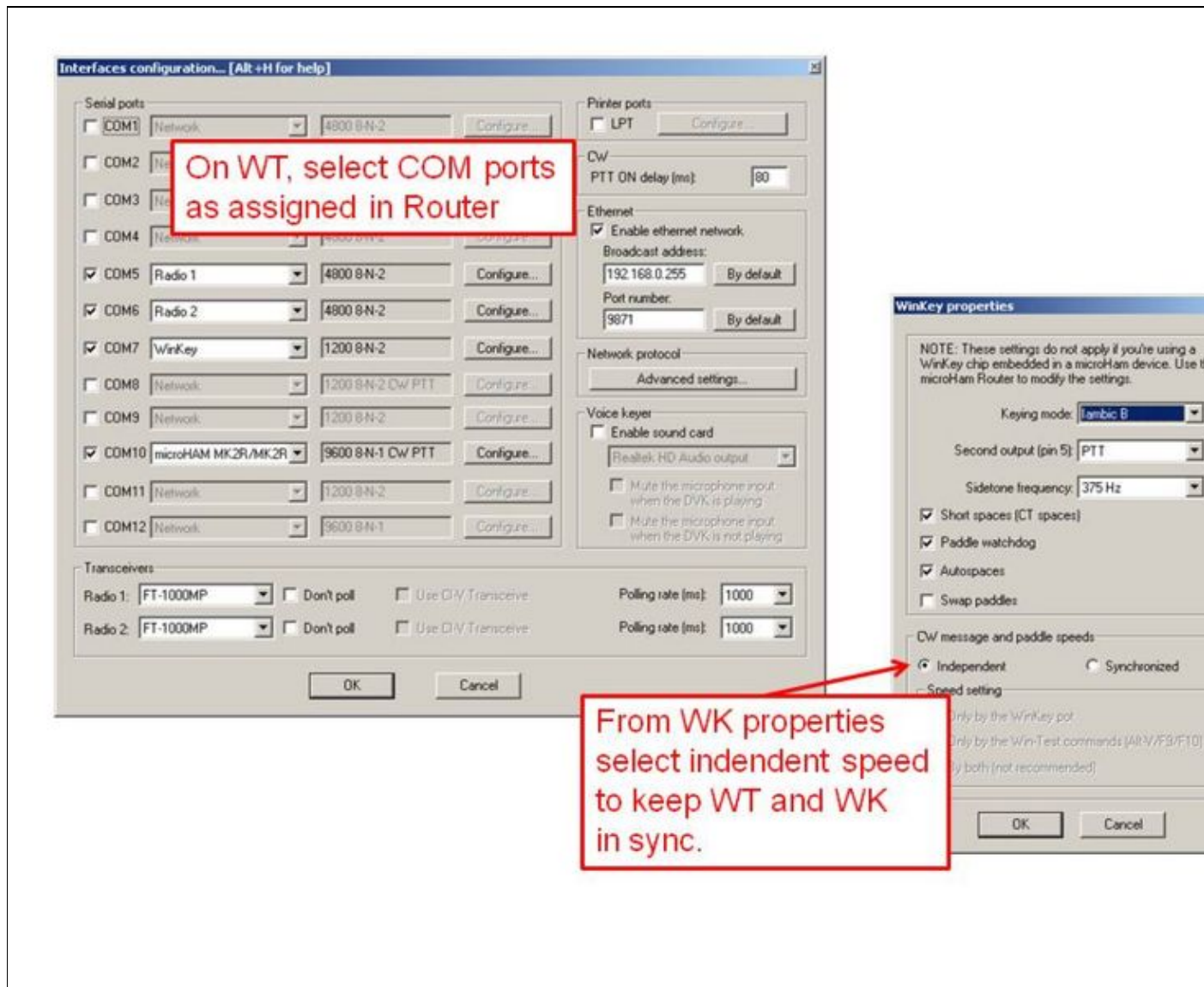

Size of this preview: [800 Å 600 pixels](#). Other resolutions: [320 Å 240 pixels](#) | [960 Å 720 pixels](#).  
[Original file](#) (960 Å 720 pixels, file size: 88 KB, MIME type: image/jpeg)

## File history

Click on a date/time to view the file as it appeared at that time.

	Date/Time	Thumbnail	Dimensions	User	Comment
current	<a href="#">08:53, 16 October 2008</a>		960 Å 720 (88 KB)	<a href="#">Oh2ua</a> ( <a href="#">talk</a>   <a href="#">contribs</a> )	

You cannot overwrite this file.

## File usage

The following page uses this file:

- [SO2R/MK2R](#)

## Namespaces

- [File](#)
- [Discussion](#)

## Variants

## Views

- [Read](#)
- [View source](#)
- [View history](#)

## More

- This page was last edited on 16 October 2008, at 08:53.

- [Privacy policy](#)
- [About Win-Test Wiki](#)
- [Disclaimers](#)





# File:MK2R Slide1.JPG

From Win-Test Wiki

[Jump to navigation](#) [Jump to search](#)

- [File](#)
- [File history](#)
- [File usage](#)



Size of this preview: [800 Å 600 pixels](#). Other resolutions: [320 Å 240 pixels](#) | [960 Å 720 pixels](#).  
[Original file](#) (960 Å 720 pixels, file size: 89 KB, MIME type: image/jpeg)

## File history

Click on a date/time to view the file as it appeared at that time.

	Date/Time	Thumbnail	Dimensions	User	Comment
current	<a href="#">08:51, 16 October 2008</a>		960 Å 720 (89 KB)	<a href="#">Oh2ua</a> ( <a href="#">talk</a>   <a href="#">contribs</a> )	

You cannot overwrite this file.

## File usage

The following page uses this file:

- [SO2R/MK2R](#)

## Namespaces

- [File](#)
- [Discussion](#)

## Variants

## Views

- [Read](#)
- [View source](#)
- [View history](#)

## More

- This page was last edited on 16 October 2008, at 08:51.

- [Privacy policy](#)
- [About Win-Test Wiki](#)
- [Disclaimers](#)



# File:MK2R Slide1.JPG

From Win-Test Wiki

[Jump to navigation](#) [Jump to search](#)

- [File](#)
- [File history](#)
- [File usage](#)

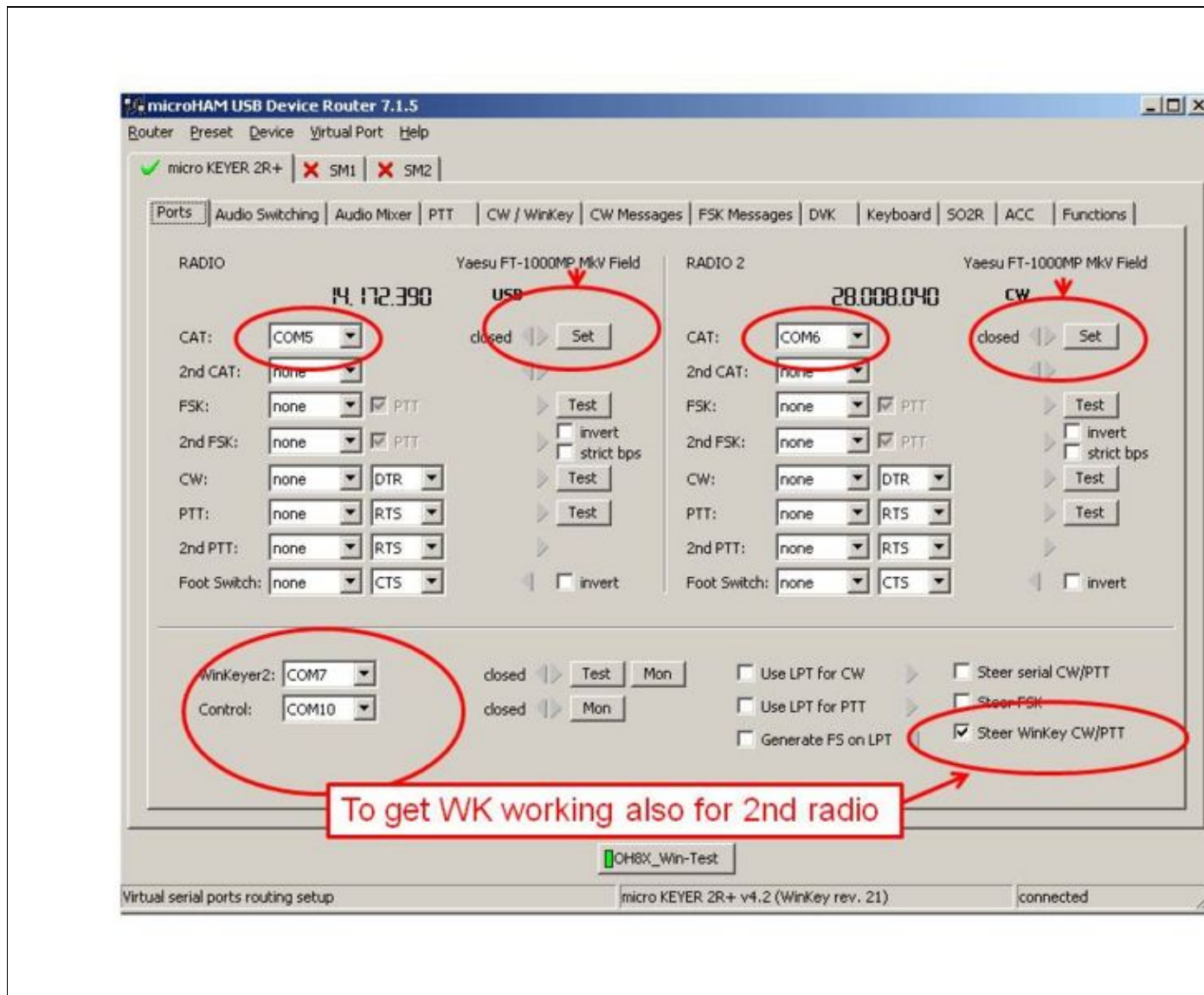

Size of this preview: [800 Å 600 pixels](#). Other resolutions: [320 Å 240 pixels](#) | [960 Å 720 pixels](#).  
[Original file](#) (960 Å 720 pixels, file size: 89 KB, MIME type: image/jpeg)

## File history

Click on a date/time to view the file as it appeared at that time.

	Date/Time	Thumbnail	Dimensions	User	Comment
current	<a href="#">08:51, 16 October 2008</a>		960 Å 720 (89 KB)	<a href="#">Oh2ua</a> ( <a href="#">talk</a>   <a href="#">contribs</a> )	

You cannot overwrite this file.

## File usage

The following page uses this file:

- [SO2R/MK2R](#)

## Namespaces

- [File](#)
- [Discussion](#)

## Variants

## Views

- [Read](#)
- [View source](#)
- [View history](#)

## More

- This page was last edited on 16 October 2008, at 08:51.

- [Privacy policy](#)
- [About Win-Test Wiki](#)
- [Disclaimers](#)



# File:MK2R Slide2.JPG

From Win-Test Wiki

[Jump to navigation](#) [Jump to search](#)

- [File](#)
- [File history](#)
- [File usage](#)

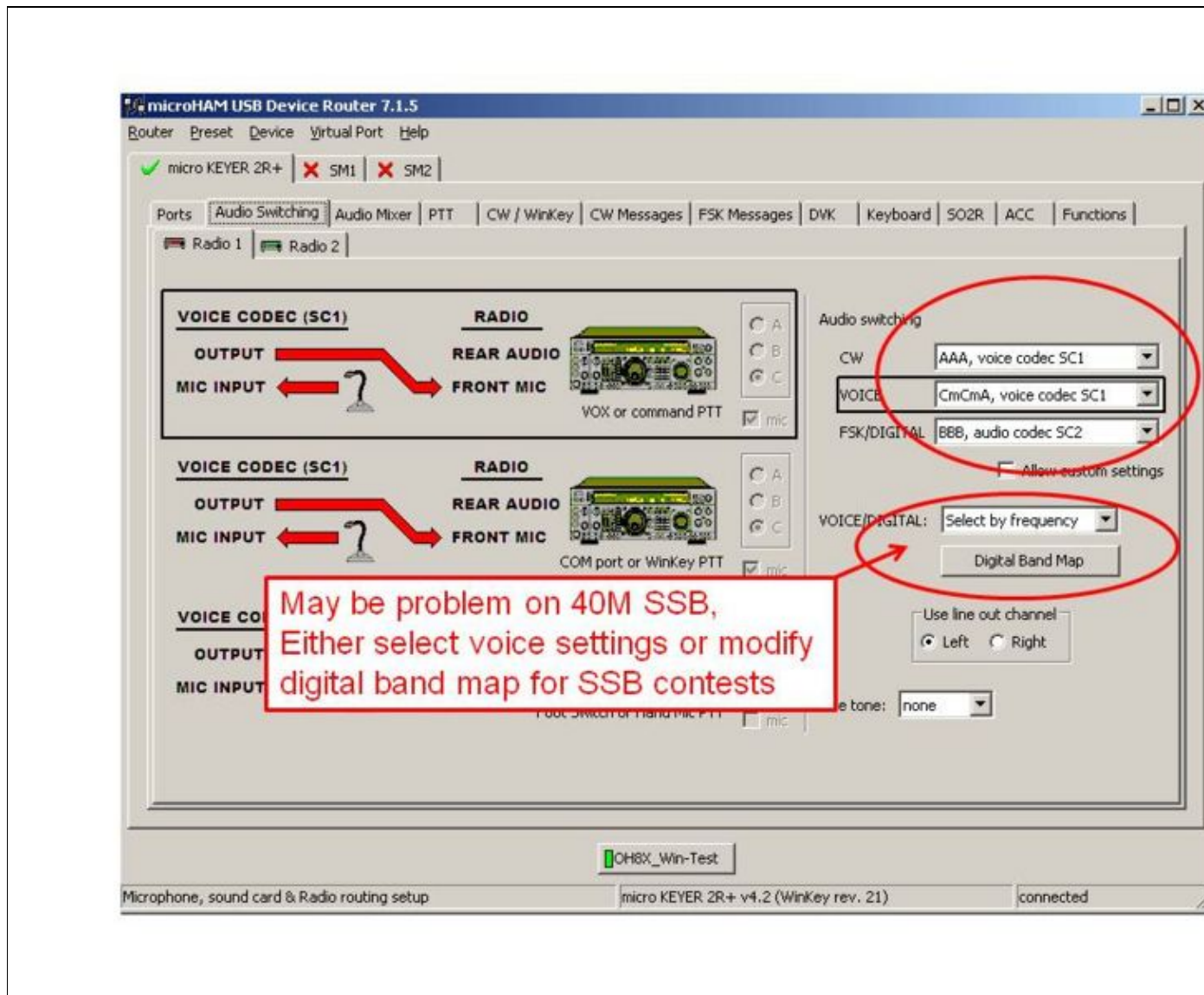

Size of this preview: [800 Å 600 pixels](#). Other resolutions: [320 Å 240 pixels](#) | [960 Å 720 pixels](#).  
[Original file](#) (960 Å 720 pixels, file size: 95 KB, MIME type: image/jpeg)

## File history

Click on a date/time to view the file as it appeared at that time.

	Date/Time	Thumbnail	Dimensions	User	Comment
current	<a href="#">08:51, 16 October 2008</a>		960 Å 720 (95 KB)	<a href="#">Oh2ua</a> ( <a href="#">talk</a>   <a href="#">contribs</a> )	

You cannot overwrite this file.

## File usage

The following page uses this file:

- [SO2R/MK2R](#)

## Namespaces

- [File](#)
- [Discussion](#)

## Variants

## Views

- [Read](#)
- [View source](#)
- [View history](#)

## More

- This page was last edited on 16 October 2008, at 08:51.

- [Privacy policy](#)
- [About Win-Test Wiki](#)
- [Disclaimers](#)



# File:MK2R Slide2.JPG

From Win-Test Wiki

[Jump to navigation](#) [Jump to search](#)

- [File](#)
- [File history](#)
- [File usage](#)

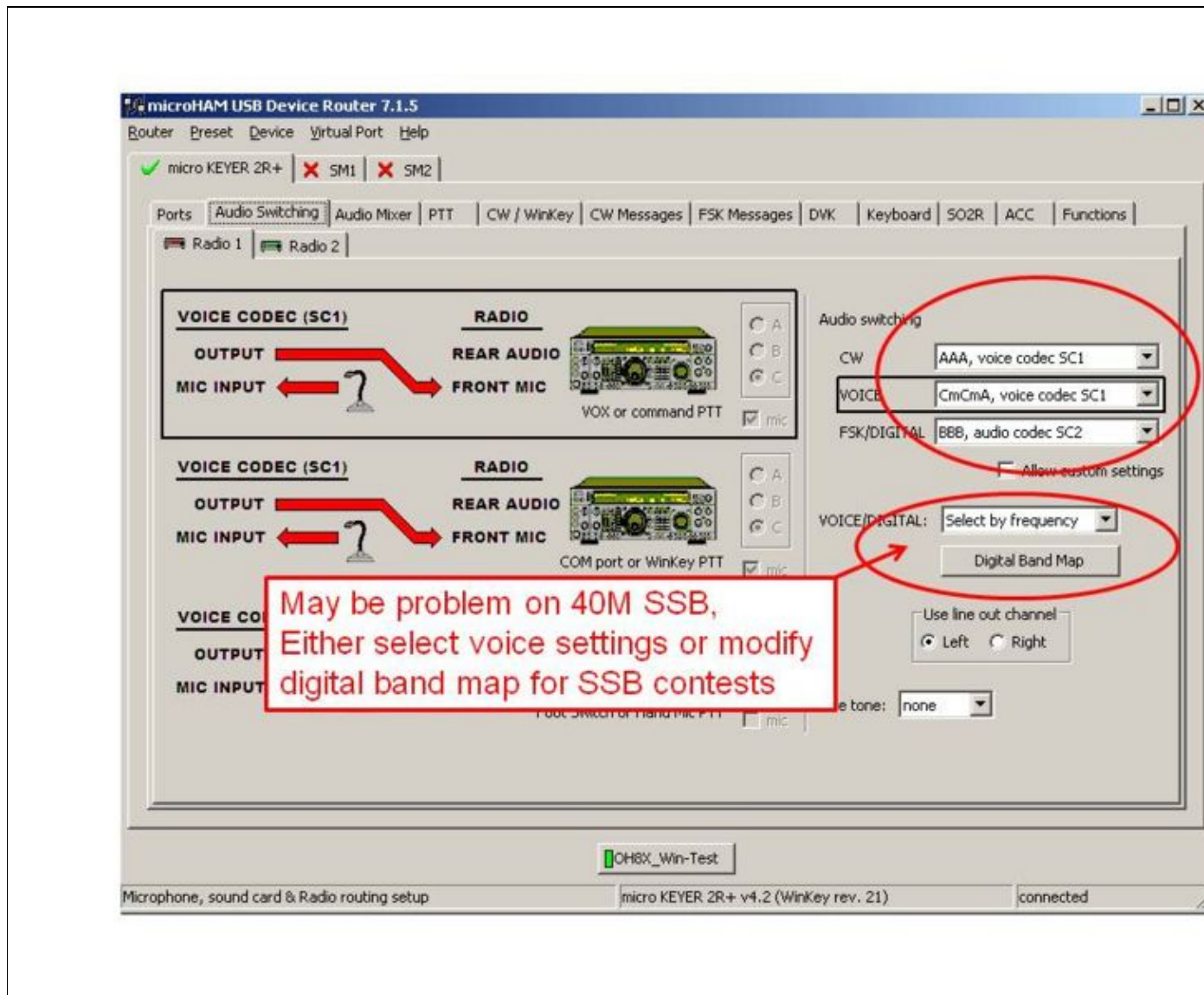

Size of this preview: [800 Å 600 pixels](#). Other resolutions: [320 Å 240 pixels](#) | [960 Å 720 pixels](#).  
[Original file](#) (960 Å 720 pixels, file size: 95 KB, MIME type: image/jpeg)

## File history

Click on a date/time to view the file as it appeared at that time.

	Date/Time	Thumbnail	Dimensions	User	Comment
current	<a href="#">08:51, 16 October 2008</a>		960 Å 720 (95 KB)	<a href="#">Oh2ua</a> ( <a href="#">talk</a>   <a href="#">contribs</a> )	

You cannot overwrite this file.

## File usage

The following page uses this file:

- [SO2R/MK2R](#)

## Namespaces

- [File](#)
- [Discussion](#)

## Variants

## Views

- [Read](#)
- [View source](#)
- [View history](#)

## More

- This page was last edited on 16 October 2008, at 08:51.

- [Privacy policy](#)
- [About Win-Test Wiki](#)
- [Disclaimers](#)

- 



# File:MK2R Slide3.JPG

From Win-Test Wiki

[Jump to navigation](#) [Jump to search](#)

- [File](#)
- [File history](#)
- [File usage](#)



Size of this preview: [800 Å 600 pixels](#). Other resolutions: [320 Å 240 pixels](#) | [960 Å 720 pixels](#).  
[Original file](#) (960 Å 720 pixels, file size: 91 KB, MIME type: image/jpeg)

## File history

Click on a date/time to view the file as it appeared at that time.

	Date/Time	Thumbnail	Dimensions	User	Comment
current	<a href="#">08:51, 16 October 2008</a>		960 Å 720 (91 KB)	<a href="#">Oh2ua</a> ( <a href="#">talk</a>   <a href="#">contribs</a> )	

You cannot overwrite this file.

## File usage

The following page uses this file:

- [SO2R/MK2R](#)

## Namespaces

- [File](#)
- [Discussion](#)

## Variants

## Views

- [Read](#)
- [View source](#)
- [View history](#)

## More

- This page was last edited on 16 October 2008, at 08:51.

- [Privacy policy](#)
- [About Win-Test Wiki](#)
- [Disclaimers](#)



# File:MK2R Slide3.JPG

From Win-Test Wiki

[Jump to navigation](#) [Jump to search](#)

- [File](#)
- [File history](#)
- [File usage](#)

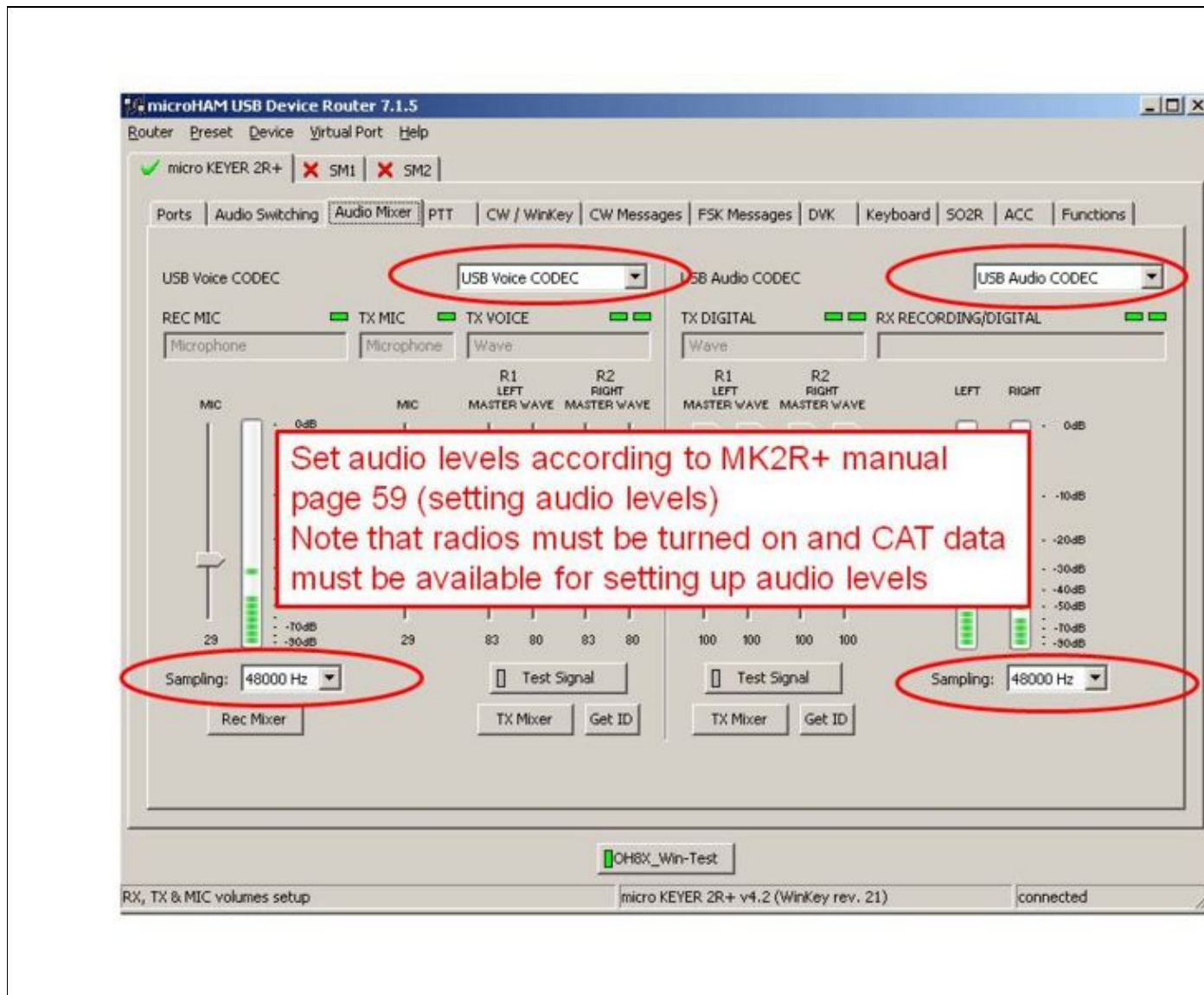

Size of this preview: [800 Å 600 pixels](#). Other resolutions: [320 Å 240 pixels](#) | [960 Å 720 pixels](#).  
[Original file](#) (960 Å 720 pixels, file size: 91 KB, MIME type: image/jpeg)

## File history

Click on a date/time to view the file as it appeared at that time.

	Date/Time	Thumbnail	Dimensions	User	Comment
current	<a href="#">08:51, 16 October 2008</a>		960 Å 720 (91 KB)	<a href="#">Oh2ua</a> ( <a href="#">talk</a>   <a href="#">contribs</a> )	

You cannot overwrite this file.

## File usage

The following page uses this file:

- [SO2R/MK2R](#)

## Namespaces

- [File](#)
- [Discussion](#)

## Variants

## Views

- [Read](#)
- [View source](#)
- [View history](#)

## More

- This page was last edited on 16 October 2008, at 08:51.

- [Privacy policy](#)
- [About Win-Test Wiki](#)
- [Disclaimers](#)



# File:MK2R Slide4.JPG

From Win-Test Wiki

[Jump to navigation](#) [Jump to search](#)

- [File](#)
- [File history](#)
- [File usage](#)

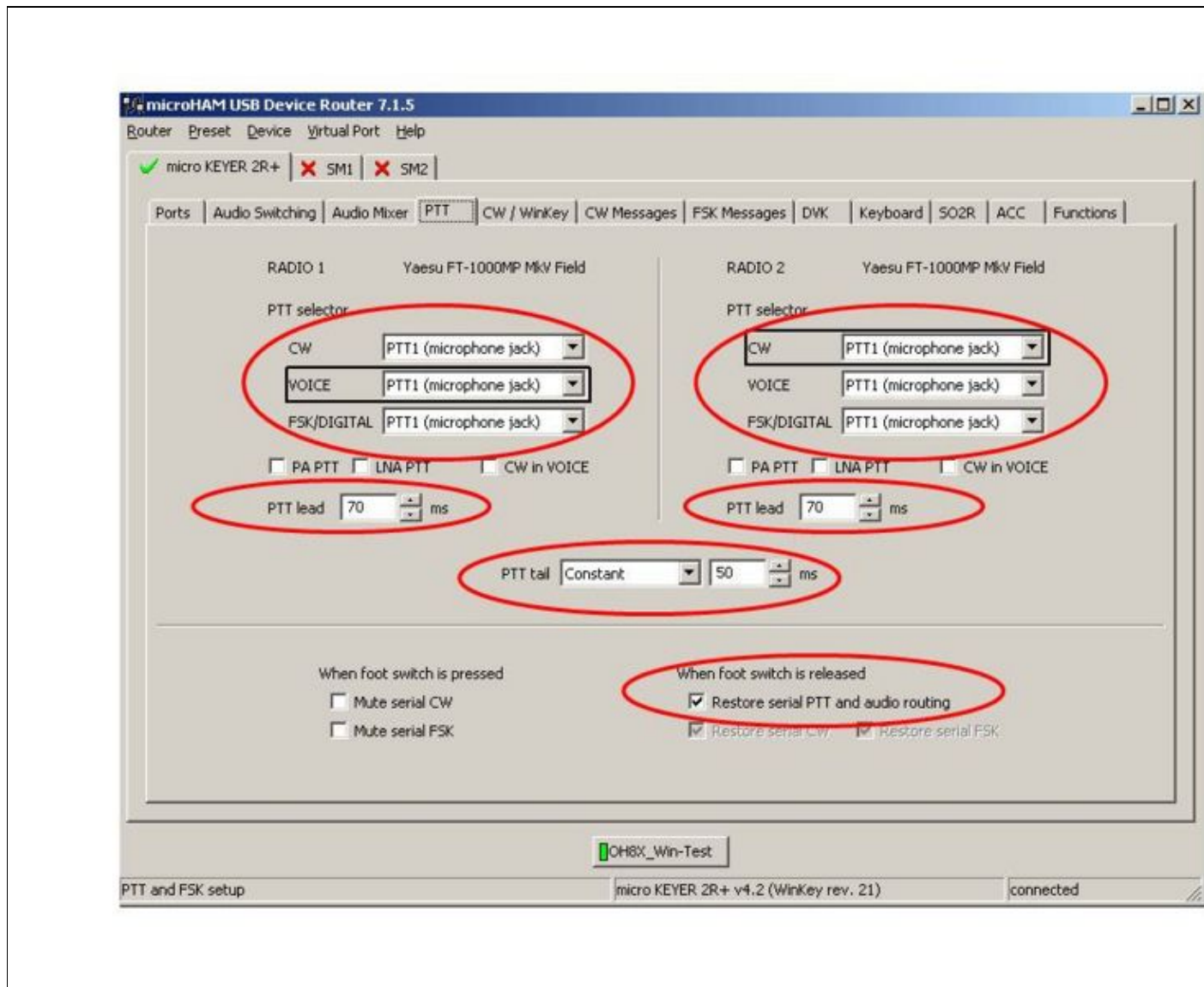

Size of this preview: [800 Å 600 pixels](#). Other resolutions: [320 Å 240 pixels](#) | [960 Å 720 pixels](#).  
[Original file](#) (960 Å 720 pixels, file size: 79 KB, MIME type: image/jpeg)

## File history

Click on a date/time to view the file as it appeared at that time.

	Date/Time	Thumbnail	Dimensions	User	Comment
current	<a href="#">08:51, 16 October 2008</a>		960 Å 720 (79 KB)	<a href="#">Oh2ua</a> ( <a href="#">talk</a>   <a href="#">contribs</a> )	

You cannot overwrite this file.

## File usage

The following page uses this file:

- [SO2R/MK2R](#)

## Namespaces

- [File](#)
- [Discussion](#)

## Variants

## Views

- [Read](#)
- [View source](#)
- [View history](#)

## More

- This page was last edited on 16 October 2008, at 08:51.

- [Privacy policy](#)
- [About Win-Test Wiki](#)
- [Disclaimers](#)

- 

# File:MK2R Slide4.JPG

From Win-Test Wiki

[Jump to navigation](#) [Jump to search](#)

- [File](#)
- [File history](#)
- [File usage](#)

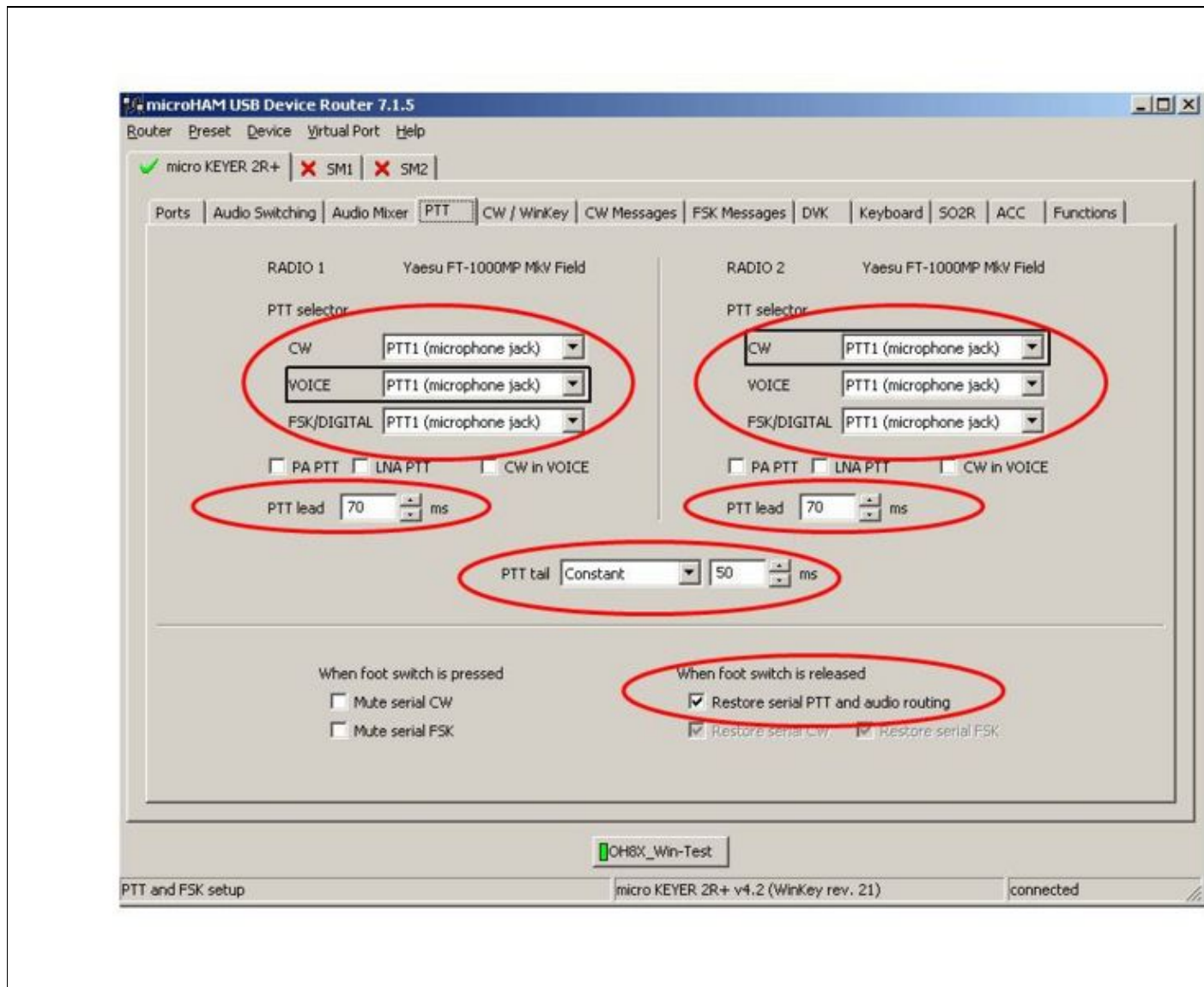

Size of this preview: [800 Å 600 pixels](#). Other resolutions: [320 Å 240 pixels](#) | [960 Å 720 pixels](#).  
[Original file](#) (960 Å 720 pixels, file size: 79 KB, MIME type: image/jpeg)

## File history

Click on a date/time to view the file as it appeared at that time.

	Date/Time	Thumbnail	Dimensions	User	Comment
current	<a href="#">08:51, 16 October 2008</a>		960 Å 720 (79 KB)	<a href="#">Oh2ua</a> ( <a href="#">talk</a>   <a href="#">contribs</a> )	

You cannot overwrite this file.

## File usage

The following page uses this file:

- [SO2R/MK2R](#)

## Namespaces

- [File](#)
- [Discussion](#)

## Variants

## Views

- [Read](#)
- [View source](#)
- [View history](#)

## More

- This page was last edited on 16 October 2008, at 08:51.

- [Privacy policy](#)
- [About Win-Test Wiki](#)
- [Disclaimers](#)

- 



# File:MK2R Slide5.JPG

From Win-Test Wiki

[Jump to navigation](#) [Jump to search](#)

- [File](#)
- [File history](#)
- [File usage](#)

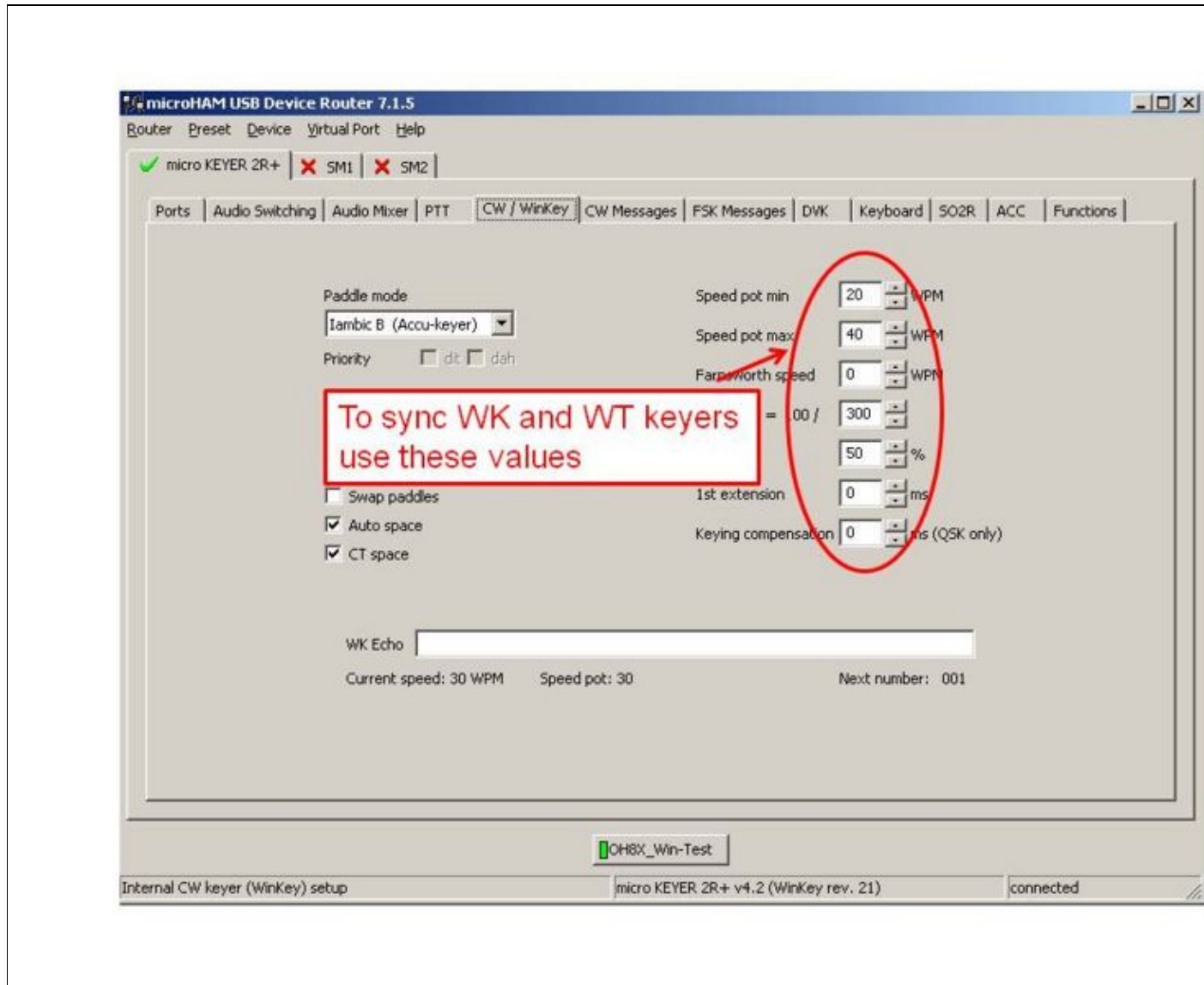

Size of this preview: [800 Å 600 pixels](#). Other resolutions: [320 Å 240 pixels](#) | [960 Å 720 pixels](#).  
[Original file](#) (960 Å 720 pixels, file size: 62 KB, MIME type: image/jpeg)

## File history

Click on a date/time to view the file as it appeared at that time.

	Date/Time	Thumbnail	Dimensions	User	Comment
current	<a href="#">08:51, 16 October 2008</a>		960 Å 720 (62 KB)	<a href="#">Oh2ua</a> ( <a href="#">talk</a>   <a href="#">contribs</a> )	

You cannot overwrite this file.

## File usage

The following page uses this file:

- [SO2R/MK2R](#)

## Namespaces

- [File](#)
- [Discussion](#)

## Variants

## Views

- [Read](#)
- [View source](#)
- [View history](#)

## More

- This page was last edited on 16 October 2008, at 08:51.

- [Privacy policy](#)
- [About Win-Test Wiki](#)
- [Disclaimers](#)



# File:MK2R Slide5.JPG

From Win-Test Wiki

[Jump to navigation](#) [Jump to search](#)

- [File](#)
- [File history](#)
- [File usage](#)

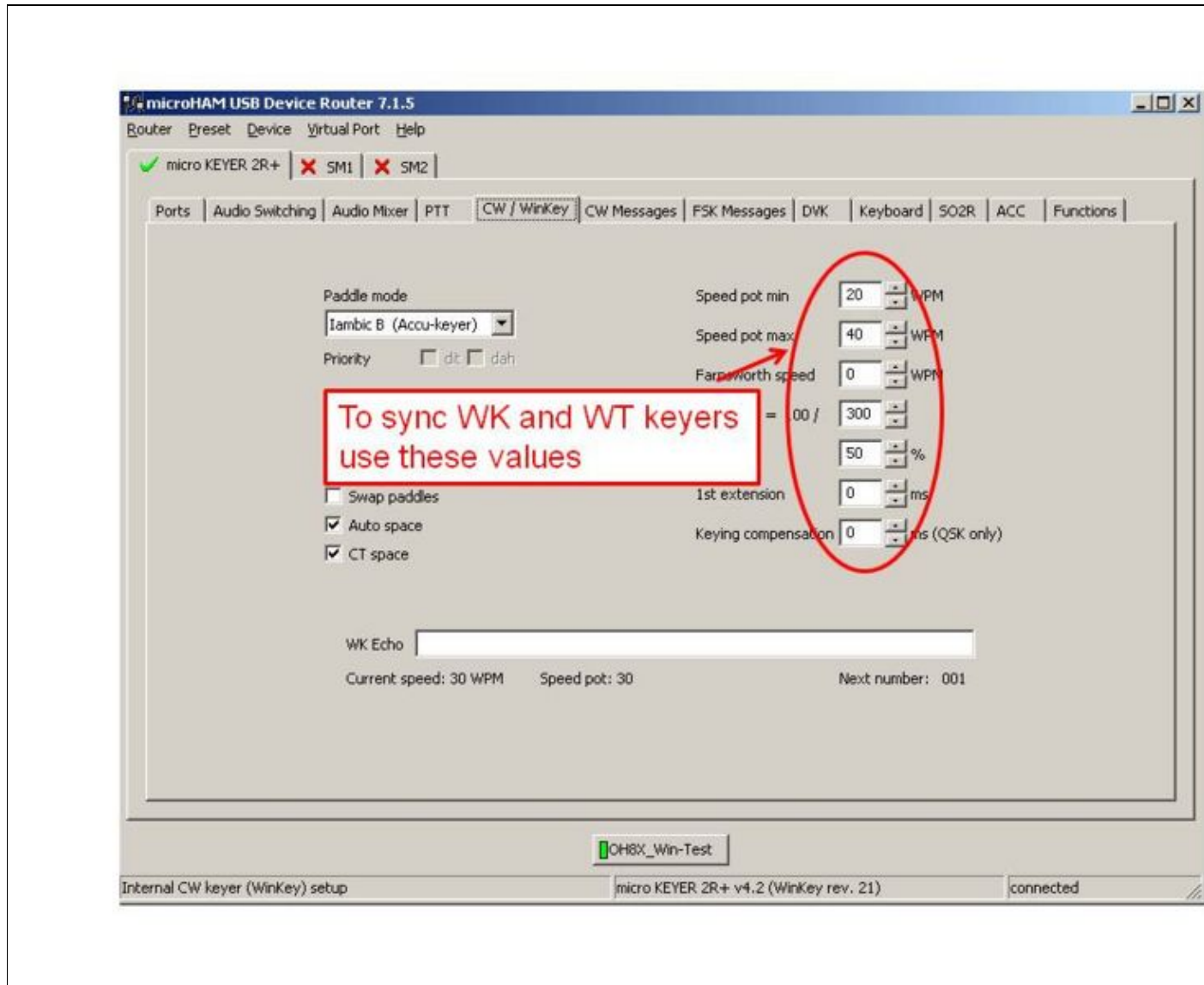

Size of this preview: [800 Å 600 pixels](#). Other resolutions: [320 Å 240 pixels](#) | [960 Å 720 pixels](#).  
[Original file](#) (960 Å 720 pixels, file size: 62 KB, MIME type: image/jpeg)

## File history

Click on a date/time to view the file as it appeared at that time.

	Date/Time	Thumbnail	Dimensions	User	Comment
current	<a href="#">08:51, 16 October 2008</a>		960 Å 720 (62 KB)	<a href="#">Oh2ua</a> ( <a href="#">talk</a>   <a href="#">contribs</a> )	

You cannot overwrite this file.

## File usage

The following page uses this file:

- [SO2R/MK2R](#)

## Namespaces

- [File](#)
- [Discussion](#)

## Variants

## Views

- [Read](#)
- [View source](#)
- [View history](#)

## More

- This page was last edited on 16 October 2008, at 08:51.

- [Privacy policy](#)
- [About Win-Test Wiki](#)
- [Disclaimers](#)

- 

# File:MK2R Slide6.JPG

From Win-Test Wiki

[Jump to navigation](#) [Jump to search](#)

- [File](#)
- [File history](#)
- [File usage](#)

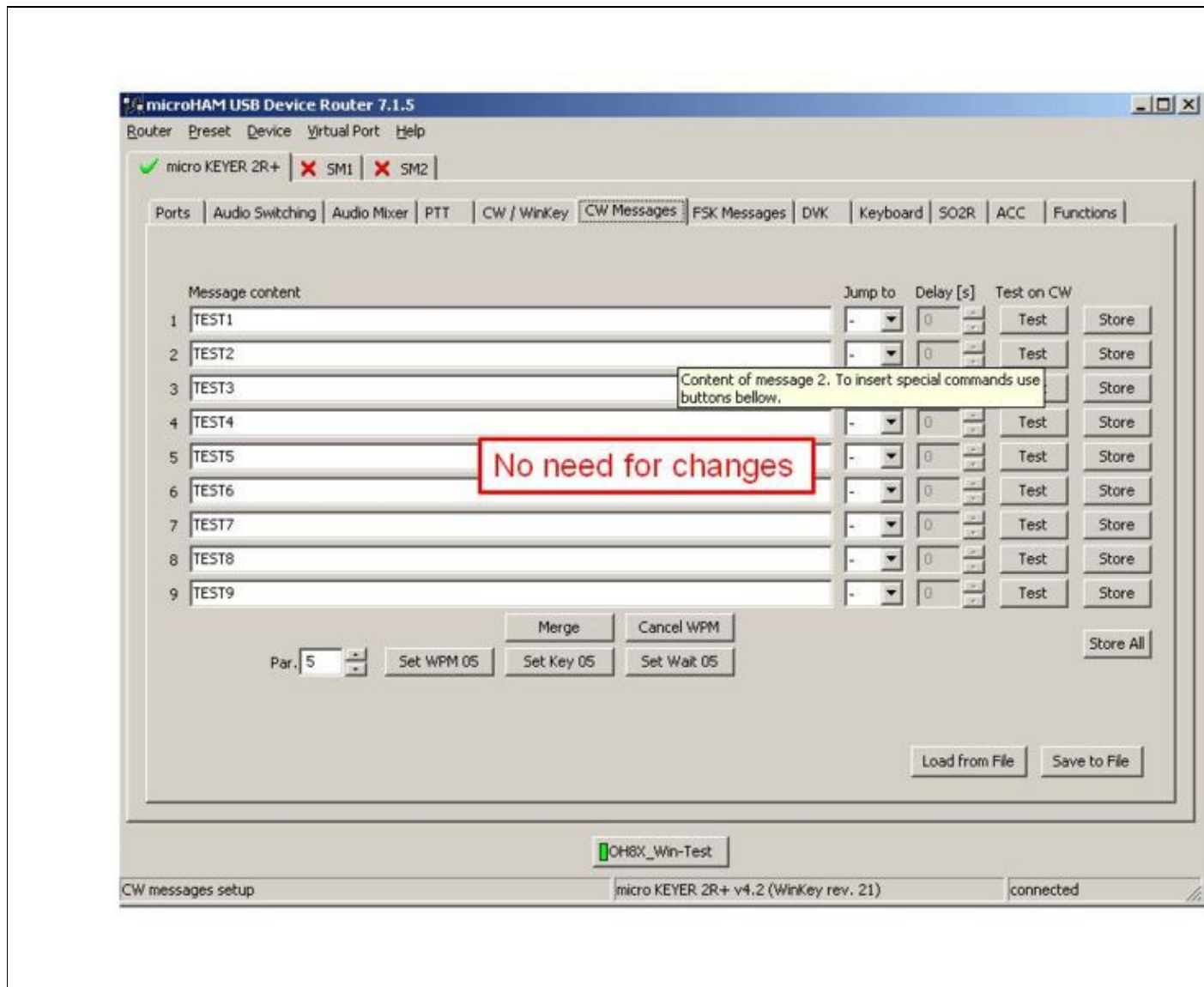

Size of this preview: [800 Å 600 pixels](#). Other resolutions: [320 Å 240 pixels](#) | [960 Å 720 pixels](#).  
[Original file](#) (960 Å 720 pixels, file size: 80 KB, MIME type: image/jpeg)

## File history

Click on a date/time to view the file as it appeared at that time.

	Date/Time	Thumbnail	Dimensions	User	Comment
current	<a href="#">08:52, 16 October 2008</a>		960 Å 720 (80 KB)	<a href="#">Oh2ua</a> ( <a href="#">talk</a>   <a href="#">contribs</a> )	

You cannot overwrite this file.

## File usage

The following page uses this file:

- [SO2R/MK2R](#)

## Namespaces

- [File](#)
- [Discussion](#)

## Variants

## Views

- [Read](#)
- [View source](#)
- [View history](#)

## More

- This page was last edited on 16 October 2008, at 08:52.

- [Privacy policy](#)
- [About Win-Test Wiki](#)
- [Disclaimers](#)



# File:MK2R Slide6.JPG

From Win-Test Wiki

[Jump to navigation](#) [Jump to search](#)

- [File](#)
- [File history](#)
- [File usage](#)

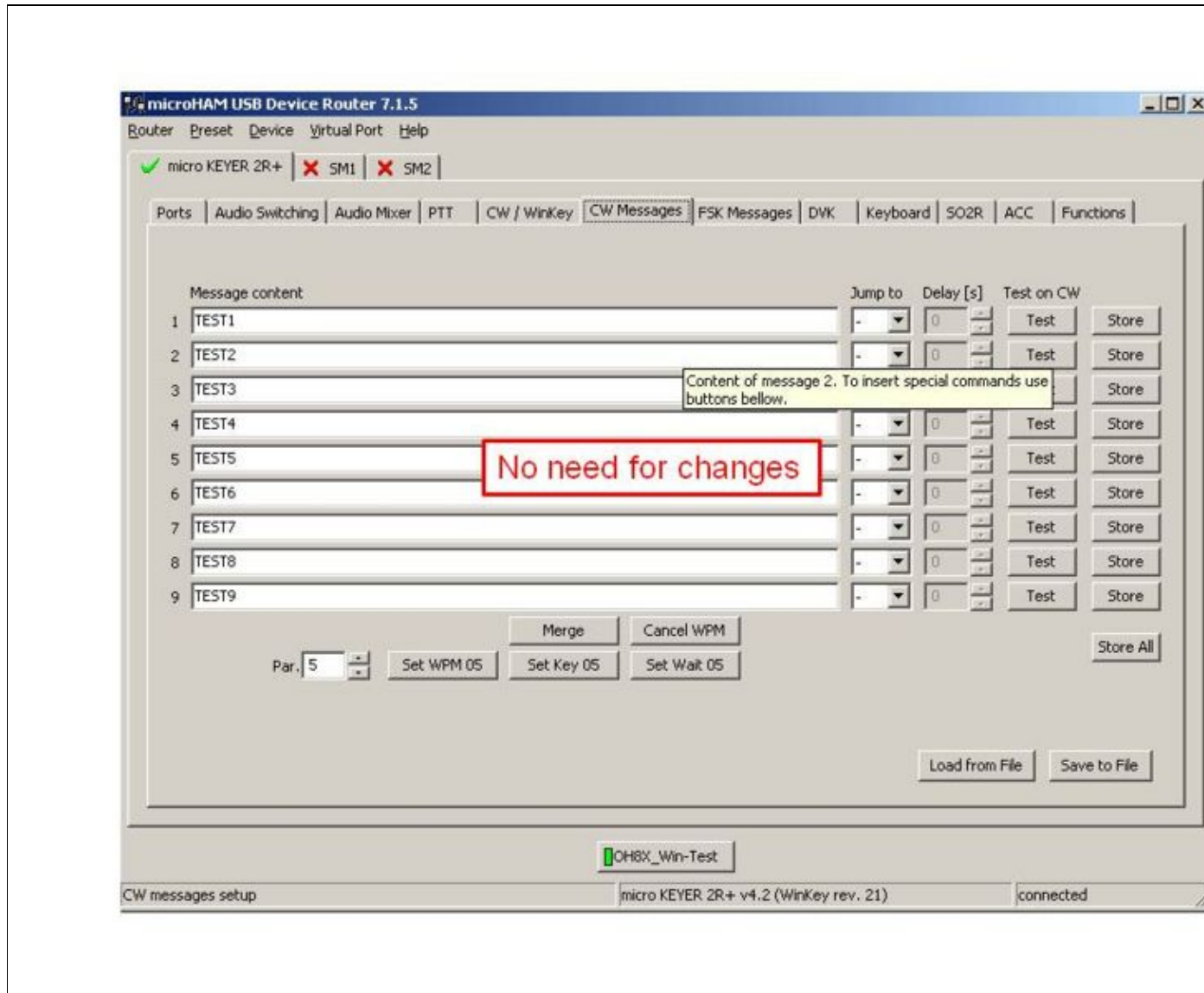

Size of this preview: [800 Å 600 pixels](#). Other resolutions: [320 Å 240 pixels](#) | [960 Å 720 pixels](#).  
[Original file](#) (960 Å 720 pixels, file size: 80 KB, MIME type: image/jpeg)

## File history

Click on a date/time to view the file as it appeared at that time.

	Date/Time	Thumbnail	Dimensions	User	Comment
current	<a href="#">08:52, 16 October 2008</a>		960 Å 720 (80 KB)	<a href="#">Oh2ua</a> ( <a href="#">talk</a>   <a href="#">contribs</a> )	

You cannot overwrite this file.

## File usage

The following page uses this file:

- [SO2R/MK2R](#)

## Namespaces

- [File](#)
- [Discussion](#)

## Variants

## Views

- [Read](#)
- [View source](#)
- [View history](#)

## More

- This page was last edited on 16 October 2008, at 08:52.

- [Privacy policy](#)
- [About Win-Test Wiki](#)
- [Disclaimers](#)





# File:MK2R Slide7.JPG

From Win-Test Wiki

[Jump to navigation](#) [Jump to search](#)

- [File](#)
- [File history](#)
- [File usage](#)

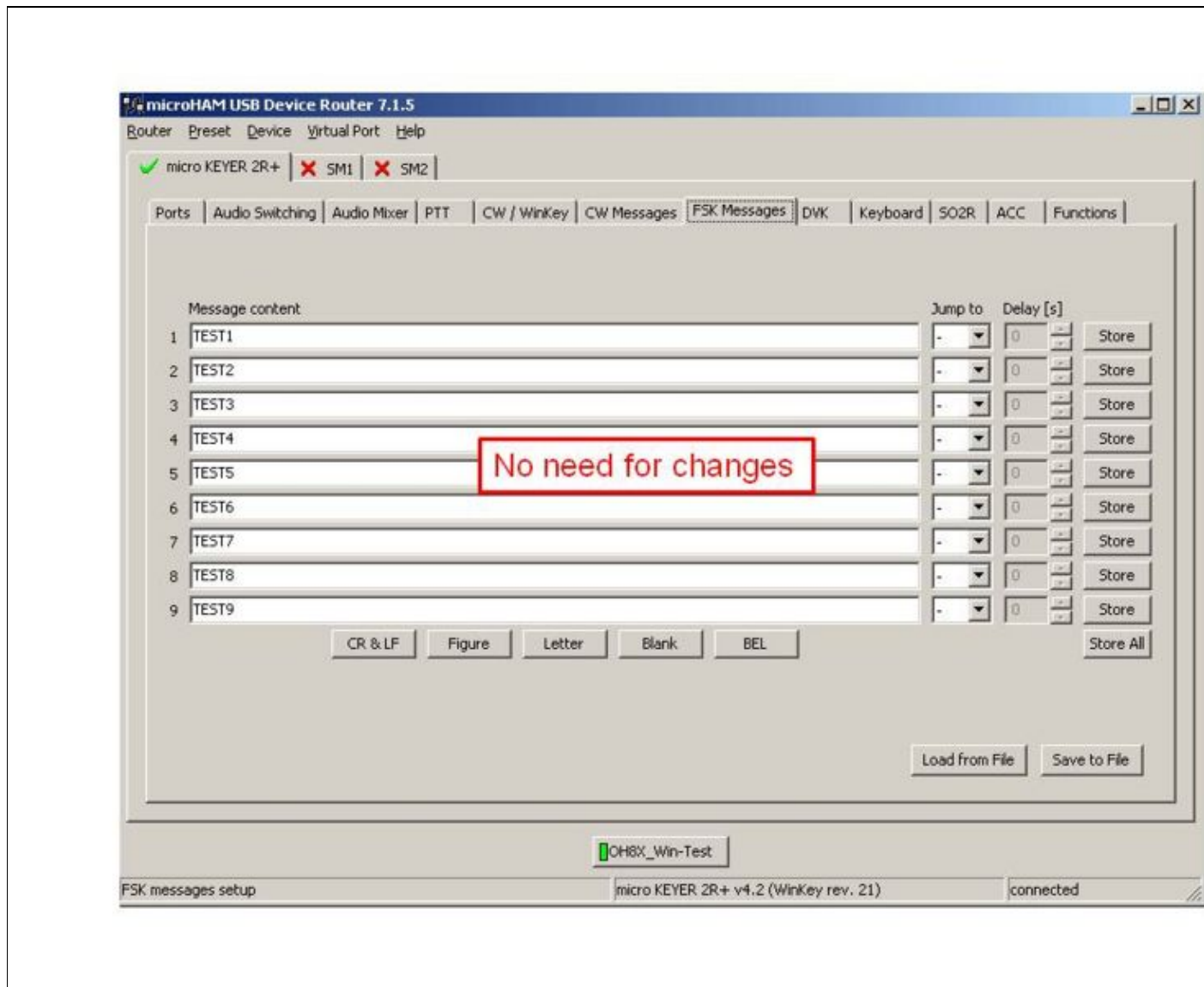

Size of this preview: [800 Å 600 pixels](#). Other resolutions: [320 Å 240 pixels](#) | [960 Å 720 pixels](#).  
[Original file](#) (960 Å 720 pixels, file size: 74 KB, MIME type: image/jpeg)

## File history

Click on a date/time to view the file as it appeared at that time.

	Date/Time	Thumbnail	Dimensions	User	Comment
current	<a href="#">08:52, 16 October 2008</a>		960 Å 720 (74 KB)	<a href="#">Oh2ua</a> ( <a href="#">talk</a>   <a href="#">contribs</a> )	

You cannot overwrite this file.

## File usage

The following page uses this file:

- [SO2R/MK2R](#)

## Namespaces

- [File](#)
- [Discussion](#)

## Variants

## Views

- [Read](#)
- [View source](#)
- [View history](#)

## More

- This page was last edited on 16 October 2008, at 08:52.

- [Privacy policy](#)
- [About Win-Test Wiki](#)
- [Disclaimers](#)



# File:MK2R Slide7.JPG

From Win-Test Wiki

[Jump to navigation](#) [Jump to search](#)

- [File](#)
- [File history](#)
- [File usage](#)

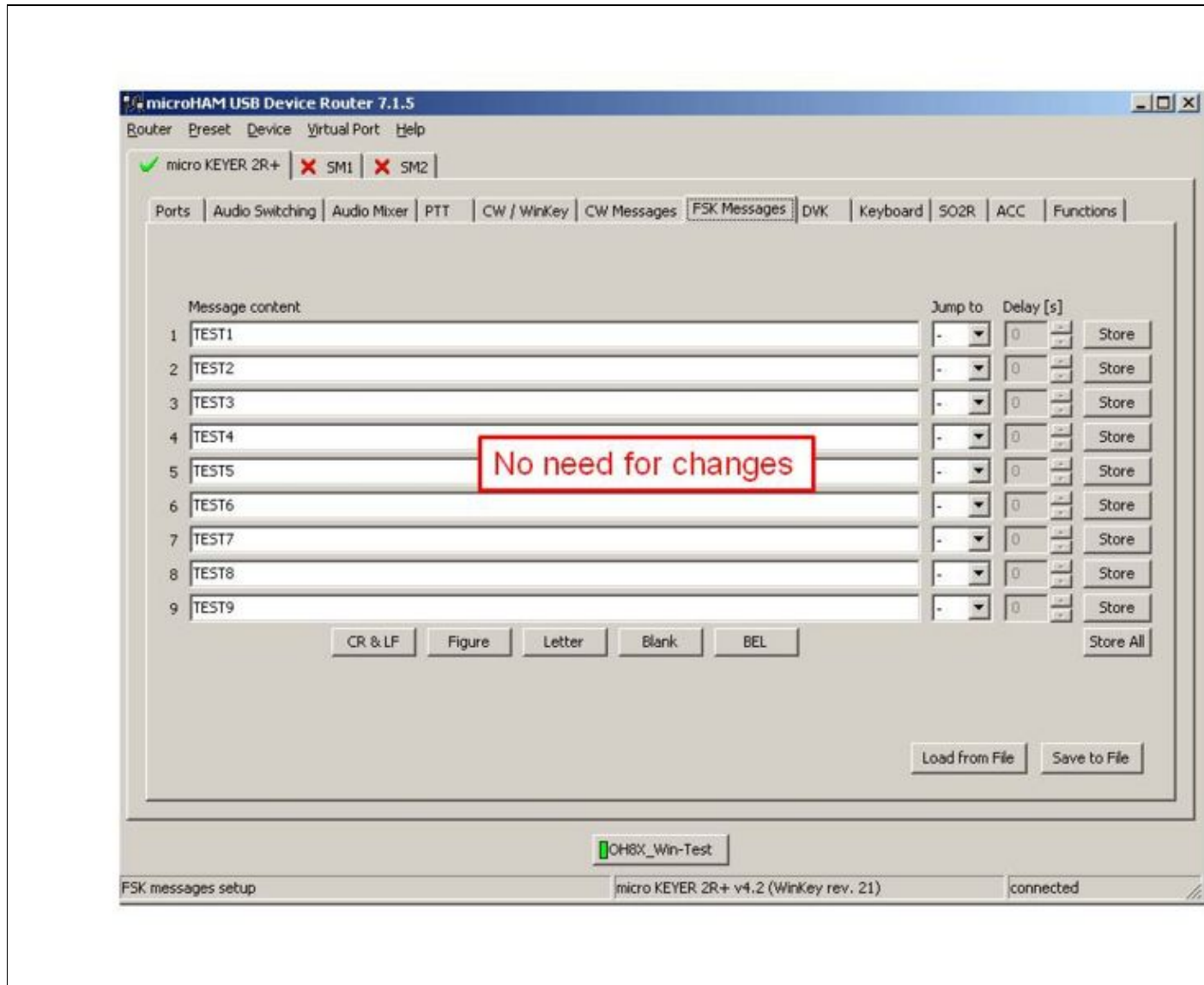

Size of this preview: [800 Å 600 pixels](#). Other resolutions: [320 Å 240 pixels](#) | [960 Å 720 pixels](#).  
[Original file](#) (960 Å 720 pixels, file size: 74 KB, MIME type: image/jpeg)

## File history

Click on a date/time to view the file as it appeared at that time.

	Date/Time	Thumbnail	Dimensions	User	Comment
current	<a href="#">08:52, 16 October 2008</a>		960 Å 720 (74 KB)	<a href="#">Oh2ua</a> ( <a href="#">talk</a>   <a href="#">contribs</a> )	

You cannot overwrite this file.

## File usage

The following page uses this file:

- [SO2R/MK2R](#)

## Namespaces

- [File](#)
- [Discussion](#)

## Variants

## Views

- [Read](#)
- [View source](#)
- [View history](#)

## More

- This page was last edited on 16 October 2008, at 08:52.

- [Privacy policy](#)
- [About Win-Test Wiki](#)
- [Disclaimers](#)



# File:MK2R Slide8.JPG

From Win-Test Wiki

[Jump to navigation](#) [Jump to search](#)

- [File](#)
- [File history](#)
- [File usage](#)

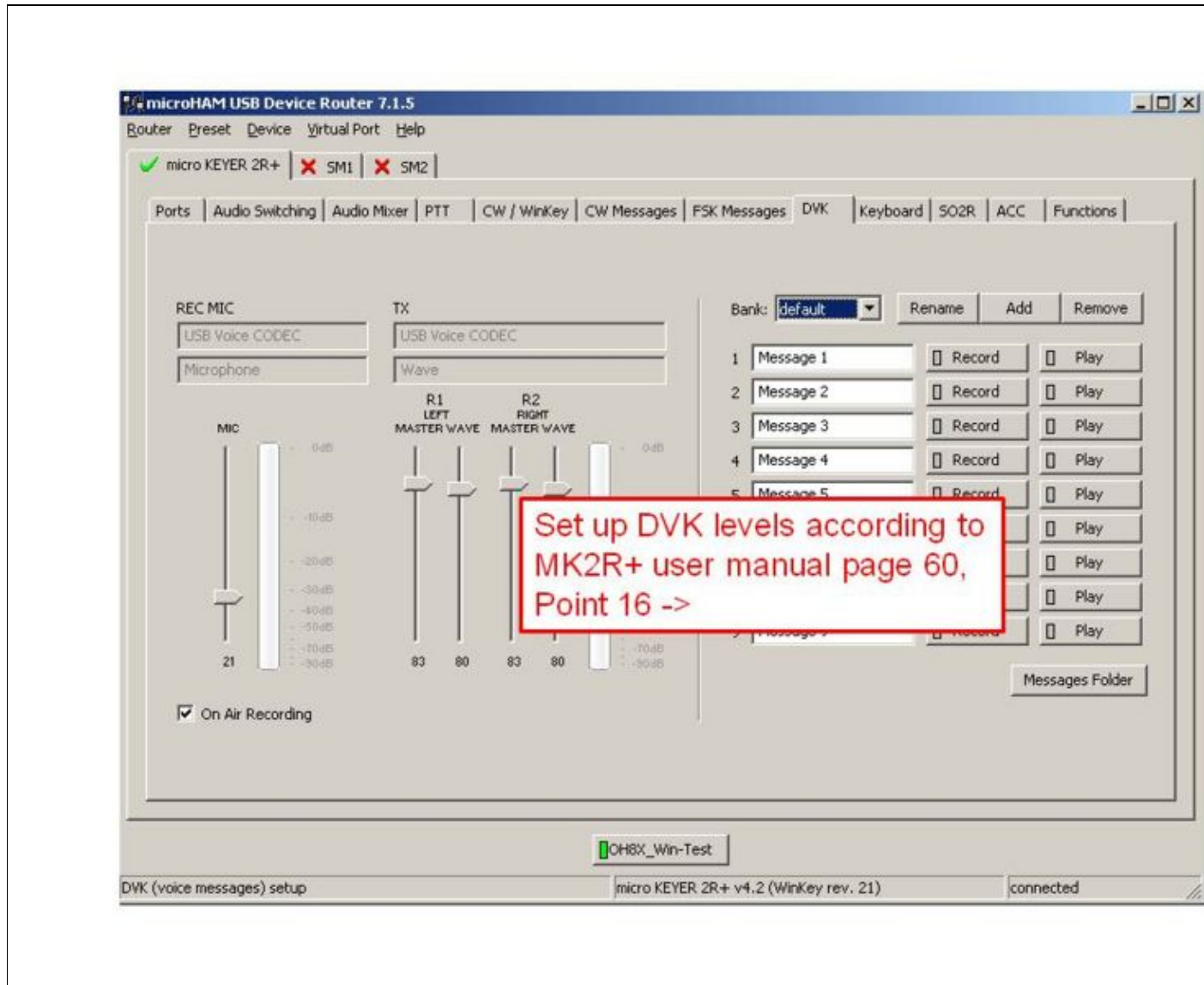

Size of this preview: [800 Å 600 pixels](#). Other resolutions: [320 Å 240 pixels](#) | [960 Å 720 pixels](#).  
[Original file](#) (960 Å 720 pixels, file size: 76 KB, MIME type: image/jpeg)

## File history

Click on a date/time to view the file as it appeared at that time.

	Date/Time	Thumbnail	Dimensions	User	Comment
current	<a href="#">08:52, 16 October 2008</a>		960 Å 720 (76 KB)	<a href="#">Oh2ua</a> ( <a href="#">talk</a>   <a href="#">contribs</a> )	

You cannot overwrite this file.

## File usage

The following page uses this file:

- [SO2R/MK2R](#)

## Namespaces

- [File](#)
- [Discussion](#)

## Variants

## Views

- [Read](#)
- [View source](#)
- [View history](#)

## More

- This page was last edited on 16 October 2008, at 08:52.

- [Privacy policy](#)
- [About Win-Test Wiki](#)
- [Disclaimers](#)

- 

# File:MK2R Slide8.JPG

From Win-Test Wiki

[Jump to navigation](#) [Jump to search](#)

- [File](#)
- [File history](#)
- [File usage](#)

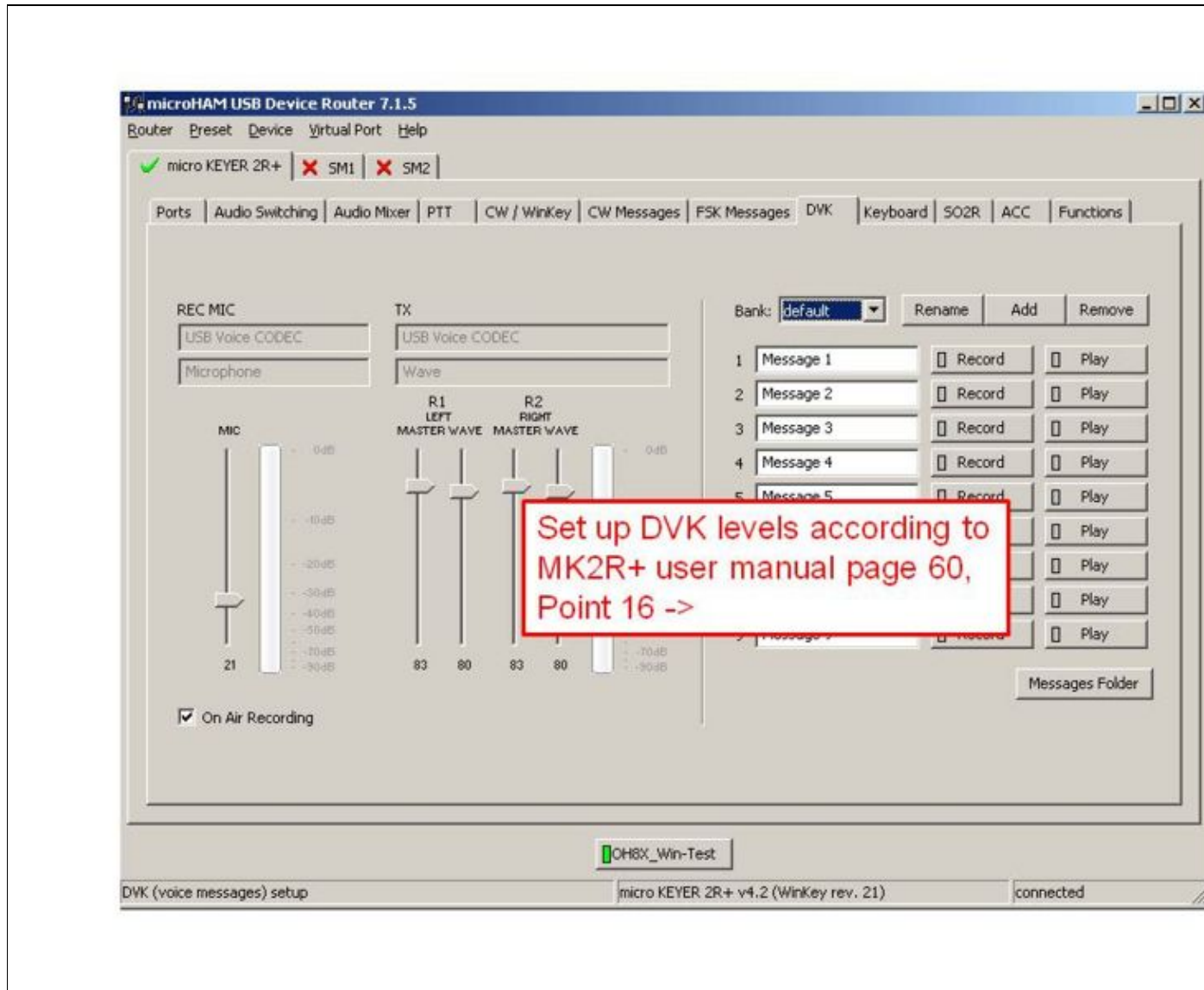

Size of this preview: [800 Å 600 pixels](#). Other resolutions: [320 Å 240 pixels](#) | [960 Å 720 pixels](#).  
[Original file](#) (960 Å 720 pixels, file size: 76 KB, MIME type: image/jpeg)

## File history

Click on a date/time to view the file as it appeared at that time.

	Date/Time	Thumbnail	Dimensions	User	Comment
current	<a href="#">08:52, 16 October 2008</a>		960 Å 720 (76 KB)	<a href="#">Oh2ua</a> ( <a href="#">talk</a>   <a href="#">contribs</a> )	

You cannot overwrite this file.

## File usage

The following page uses this file:

- [SO2R/MK2R](#)

## Namespaces

- [File](#)
- [Discussion](#)

## Variants

## Views

- [Read](#)
- [View source](#)
- [View history](#)

## More

- This page was last edited on 16 October 2008, at 08:52.

- [Privacy policy](#)
- [About Win-Test Wiki](#)
- [Disclaimers](#)

- 



# File:MK2R Slide9.JPG

From Win-Test Wiki

[Jump to navigation](#) [Jump to search](#)

- [File](#)
- [File history](#)
- [File usage](#)

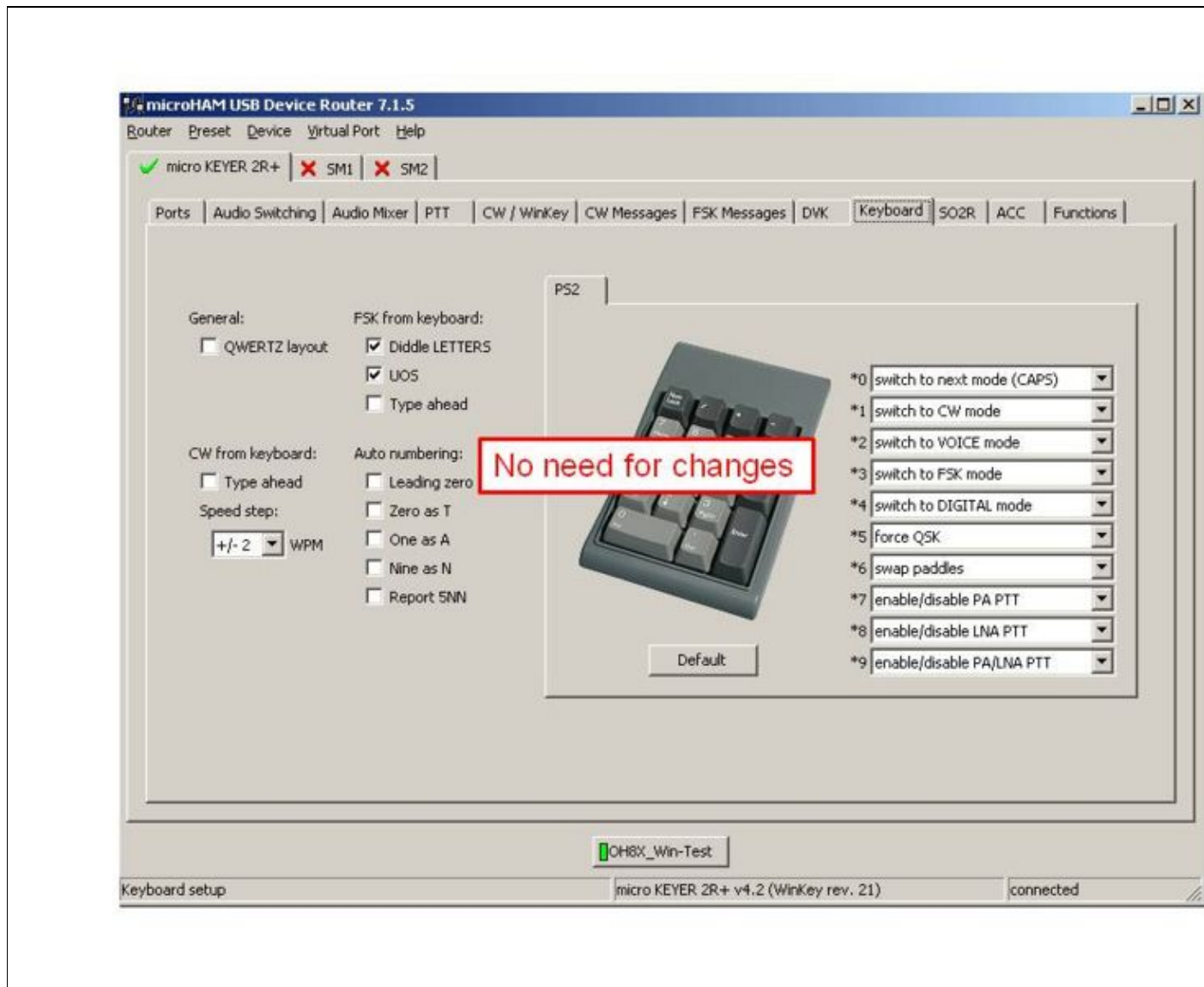

Size of this preview: [800 Å 600 pixels](#). Other resolutions: [320 Å 240 pixels](#) | [960 Å 720 pixels](#).  
[Original file](#) (960 Å 720 pixels, file size: 73 KB, MIME type: image/jpeg)

## File history

Click on a date/time to view the file as it appeared at that time.

	Date/Time	Thumbnail	Dimensions	User	Comment
current	<a href="#">08:52, 16 October 2008</a>		960 Å 720 (73 KB)	<a href="#">Oh2ua</a> ( <a href="#">talk</a>   <a href="#">contribs</a> )	

You cannot overwrite this file.

## File usage

The following page uses this file:

- [SO2R/MK2R](#)

## Namespaces

- [File](#)
- [Discussion](#)

## Variants

## Views

- [Read](#)
- [View source](#)
- [View history](#)

## More

- This page was last edited on 16 October 2008, at 08:52.

- [Privacy policy](#)
- [About Win-Test Wiki](#)
- [Disclaimers](#)



# File:MK2R Slide9.JPG

From Win-Test Wiki

[Jump to navigation](#) [Jump to search](#)

- [File](#)
- [File history](#)
- [File usage](#)

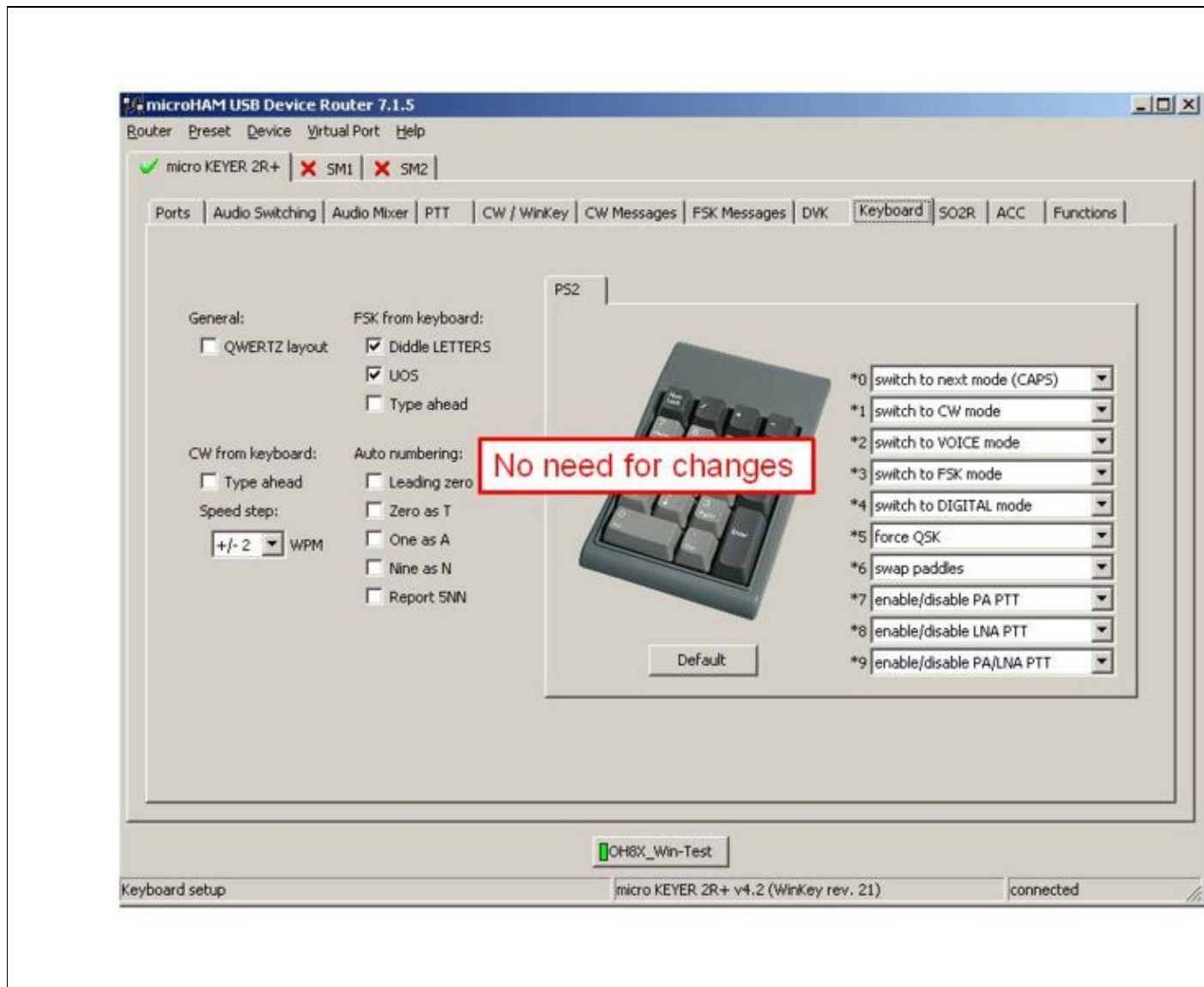

Size of this preview: [800 Å 600 pixels](#). Other resolutions: [320 Å 240 pixels](#) | [960 Å 720 pixels](#).  
[Original file](#) (960 Å 720 pixels, file size: 73 KB, MIME type: image/jpeg)

## File history

Click on a date/time to view the file as it appeared at that time.

	Date/Time	Thumbnail	Dimensions	User	Comment
current	<a href="#">08:52, 16 October 2008</a>		960 Å 720 (73 KB)	<a href="#">Oh2ua</a> ( <a href="#">talk</a>   <a href="#">contribs</a> )	

You cannot overwrite this file.

## File usage

The following page uses this file:

- [SO2R/MK2R](#)

## Namespaces

- [File](#)
- [Discussion](#)

## Variants

## Views

- [Read](#)
- [View source](#)
- [View history](#)

## More

- This page was last edited on 16 October 2008, at 08:52.

- [Privacy policy](#)
- [About Win-Test Wiki](#)
- [Disclaimers](#)



# File:MK MKII MK2R.PNG

From Win-Test Wiki

[Jump to navigation](#) [Jump to search](#)

- [File](#)
- [File history](#)
- [File usage](#)

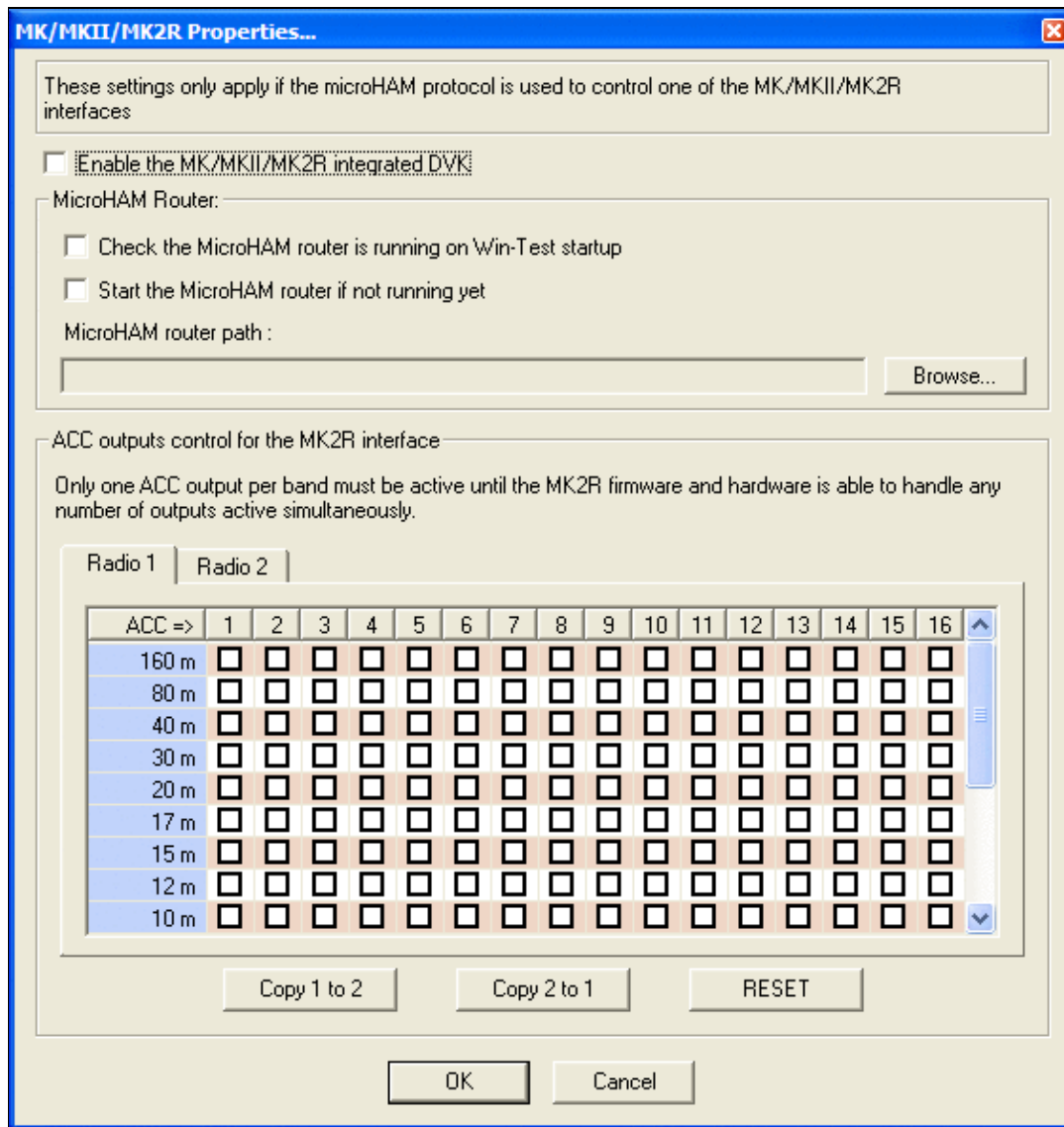

No higher resolution available.

[MK\\_MKII\\_MK2R.PNG](#) (563 × 593 pixels, file size: 22 KB, MIME type: image.gif)

## File history

Click on a date/time to view the file as it appeared at that time.

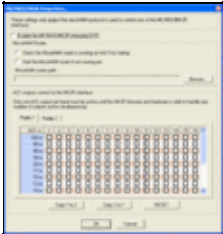
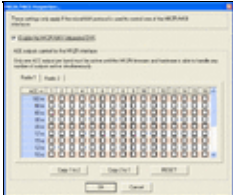
	Date/Time	Thumbnail	Dimensions	User	Comment
current	<u><a href="#">20:57, 6 September 2008</a></u>		563 × 593 (22 KB)	<u><a href="#">N6TV</a></u> ( <a href="#">talk</a>   <a href="#">contribs</a> )	Updated to WT 3.22 version with new options
	<u><a href="#">20:22, 14 November 2007</a></u>		563 × 477 (18 KB)	<u><a href="#">Dl6rai</a></u> ( <a href="#">talk</a>   <a href="#">contribs</a> )	

You cannot overwrite this file.

## File usage

The following page uses this file:

- [Menu:Options](#)

## Namespaces

- [File](#)
- [Discussion](#)

## Variants

## Views

- [Read](#)
- [View source](#)
- [View history](#)

## More

- This page was last edited on 14 November 2007, at 20:22.
- [Privacy policy](#)
- [About Win-Test Wiki](#)
- [Disclaimers](#)



# File:MK MKII MK2R.PNG

From Win-Test Wiki

[Jump to navigation](#) [Jump to search](#)

- [File](#)
- [File history](#)
- [File usage](#)

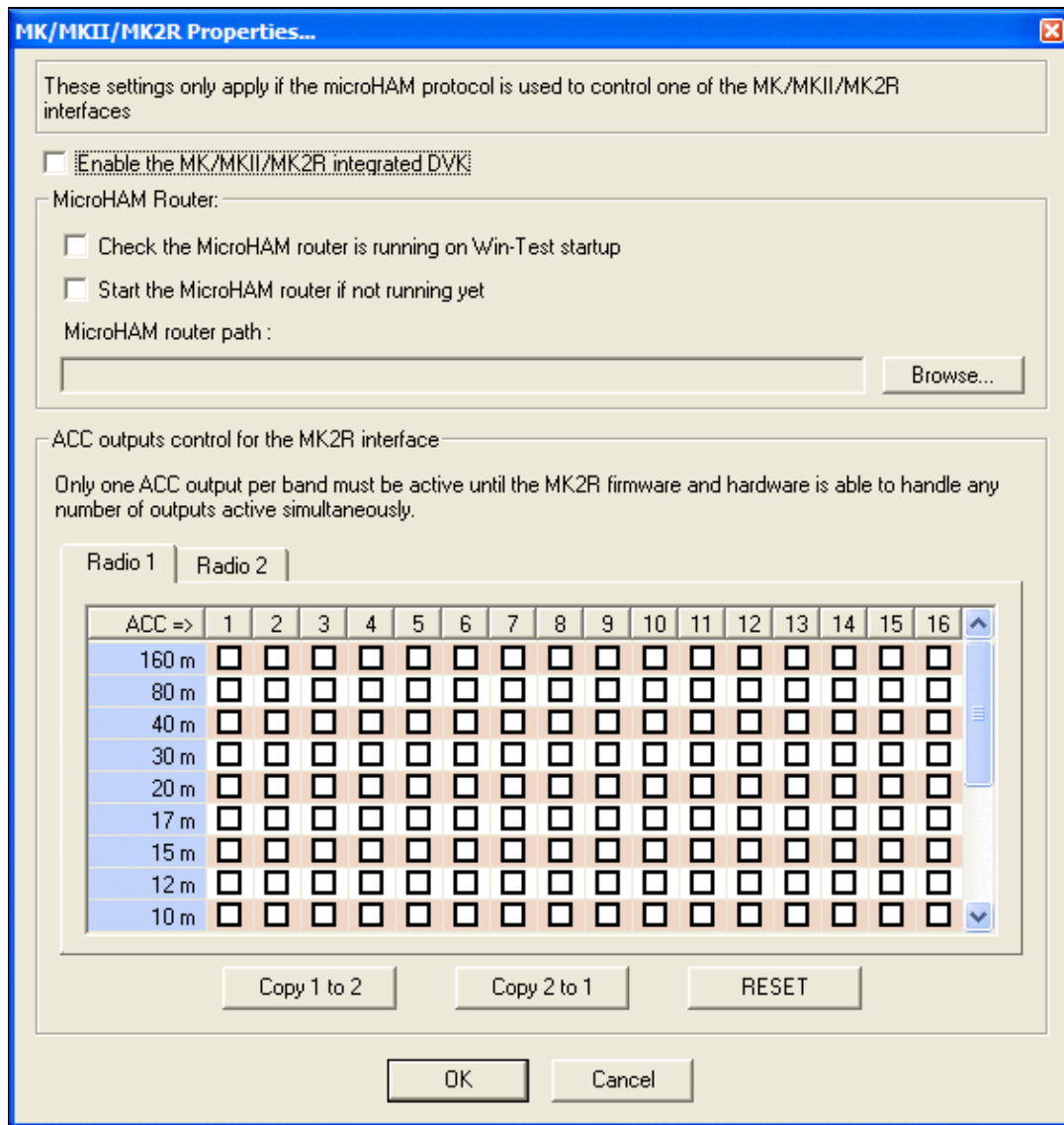



No higher resolution available.

[MK\\_MKII\\_MK2R.PNG](#) (563 × 593 pixels, file size: 22 KB, MIME type: image.gif)

## File history

Click on a date/time to view the file as it appeared at that time.

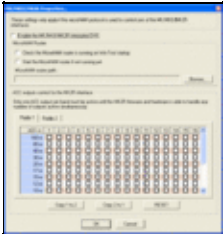
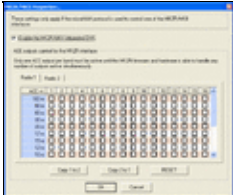
	Date/Time	Thumbnail	Dimensions	User	Comment
current	<u><a href="#">20:57, 6 September 2008</a></u>		563 × 593 (22 KB)	<u><a href="#">N6TV</a></u> ( <a href="#">talk</a>   <a href="#">contribs</a> )	Updated to WT 3.22 version with new options
	<u><a href="#">20:22, 14 November 2007</a></u>		563 × 477 (18 KB)	<u><a href="#">Dl6rai</a></u> ( <a href="#">talk</a>   <a href="#">contribs</a> )	

You cannot overwrite this file.

## File usage

The following page uses this file:

- [Menu:Options](#)

## Namespaces

- [File](#)
- [Discussion](#)

## Variants

## Views

- [Read](#)
- [View source](#)
- [View history](#)

## More

- This page was last edited on 14 November 2007, at 20:22.
- [Privacy policy](#)
- [About Win-Test Wiki](#)
- [Disclaimers](#)



# File:MmttyAfcAtcPllSetup.gif

From Win-Test Wiki

[Jump to navigation](#) [Jump to search](#)

- [File](#)
- [File history](#)
- [File usage](#)

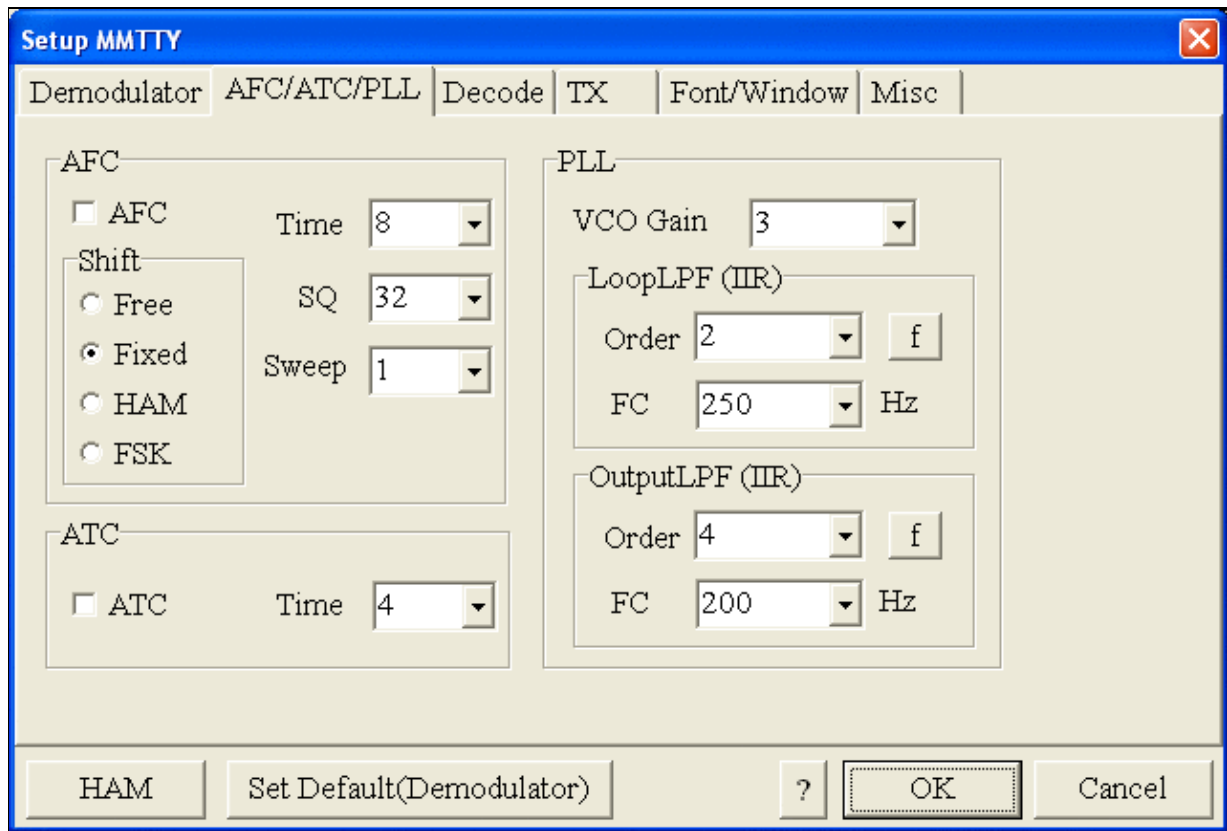

No higher resolution available.

[MmttyAfcAtcPIISetup.gif](#) (638 × 431 pixels, file size: 22 KB, MIME type: image.gif)

## File history

Click on a date/time to view the file as it appeared at that time.

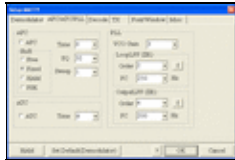
	Date/Time	Thumbnail	Dimensions	User	Comment
current	<a href="#">09:19, 4 January 2007</a>		638 × 431 (22 KB)	<a href="#">D16rai (talk   contribs)</a>	

You cannot overwrite this file.

## File usage

The following 7 pages use this file:

- [BestPractice1](#)
- [BestPractice10](#)
- [BestPractice4](#)
- [BestPractice5](#)
- [BestPractice6](#)
- [BestPractice7](#)
- [BestPractice8](#)

## Namespaces

- [File](#)
- [Discussion](#)

## Variants

## Views

- [Read](#)
- [View source](#)
- [View history](#)

## More

- This page was last edited on 4 January 2007, at 09:19.
- [Privacy policy](#)
- [About Win-Test Wiki](#)
- [Disclaimers](#)



# File:MmttyAfcAtcPllSetup.gif

From Win-Test Wiki

[Jump to navigation](#) [Jump to search](#)

- [File](#)
- [File history](#)
- [File usage](#)

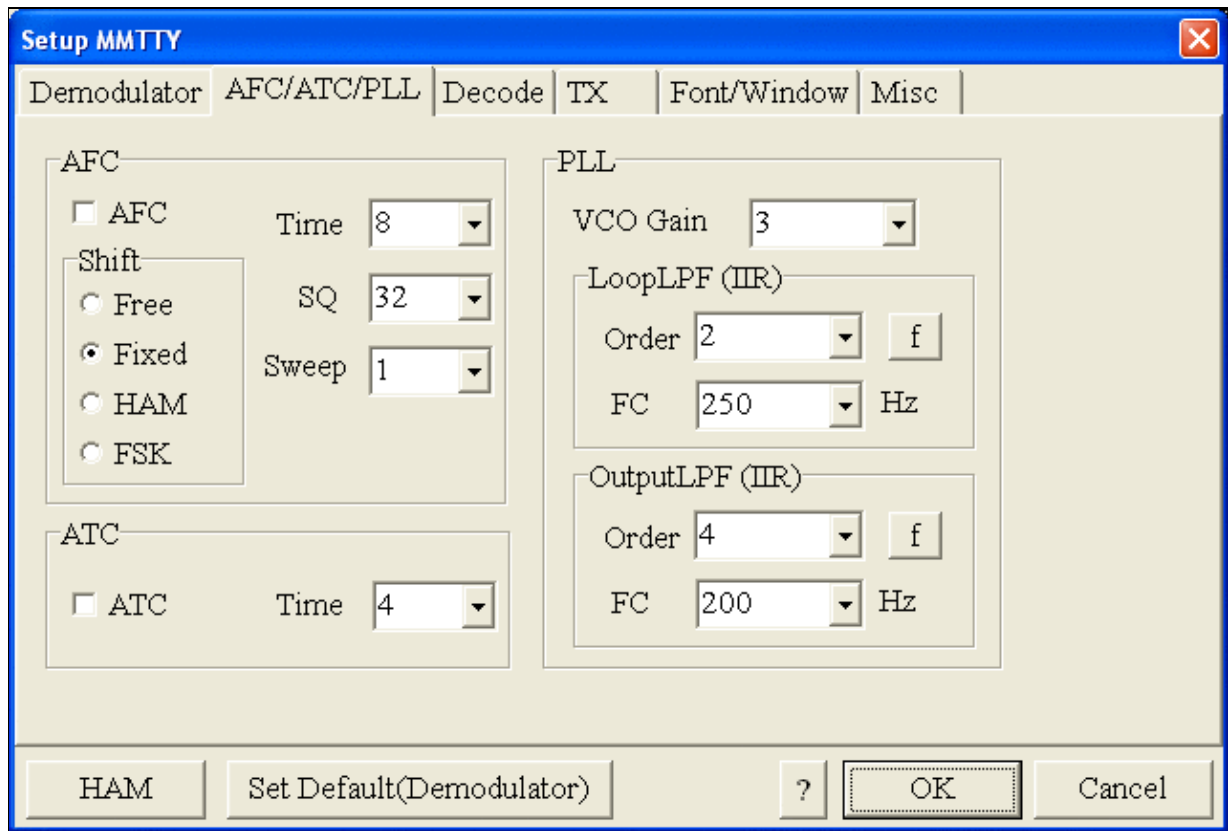

No higher resolution available.

[MmttyAfcAtcPIISetup.gif](#) (638 × 431 pixels, file size: 22 KB, MIME type: image.gif)

## File history

Click on a date/time to view the file as it appeared at that time.

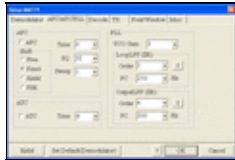
	Date/Time	Thumbnail	Dimensions	User	Comment
current	<a href="#">09:19, 4 January 2007</a>		638 × 431 (22 KB)	<a href="#">D16rai (talk   contribs)</a>	

You cannot overwrite this file.

## File usage

The following 7 pages use this file:

- [BestPractice1](#)
- [BestPractice10](#)
- [BestPractice4](#)
- [BestPractice5](#)
- [BestPractice6](#)
- [BestPractice7](#)
- [BestPractice8](#)

## Namespaces

- [File](#)
- [Discussion](#)

## Variants

## Views

- [Read](#)
- [View source](#)
- [View history](#)

## More

- This page was last edited on 4 January 2007, at 09:19.
- [Privacy policy](#)
- [About Win-Test Wiki](#)
- [Disclaimers](#)





# File:MmttyDemodulatorSetup.gif

From Win-Test Wiki

[Jump to navigation](#) [Jump to search](#)

- [File](#)
- [File history](#)
- [File usage](#)

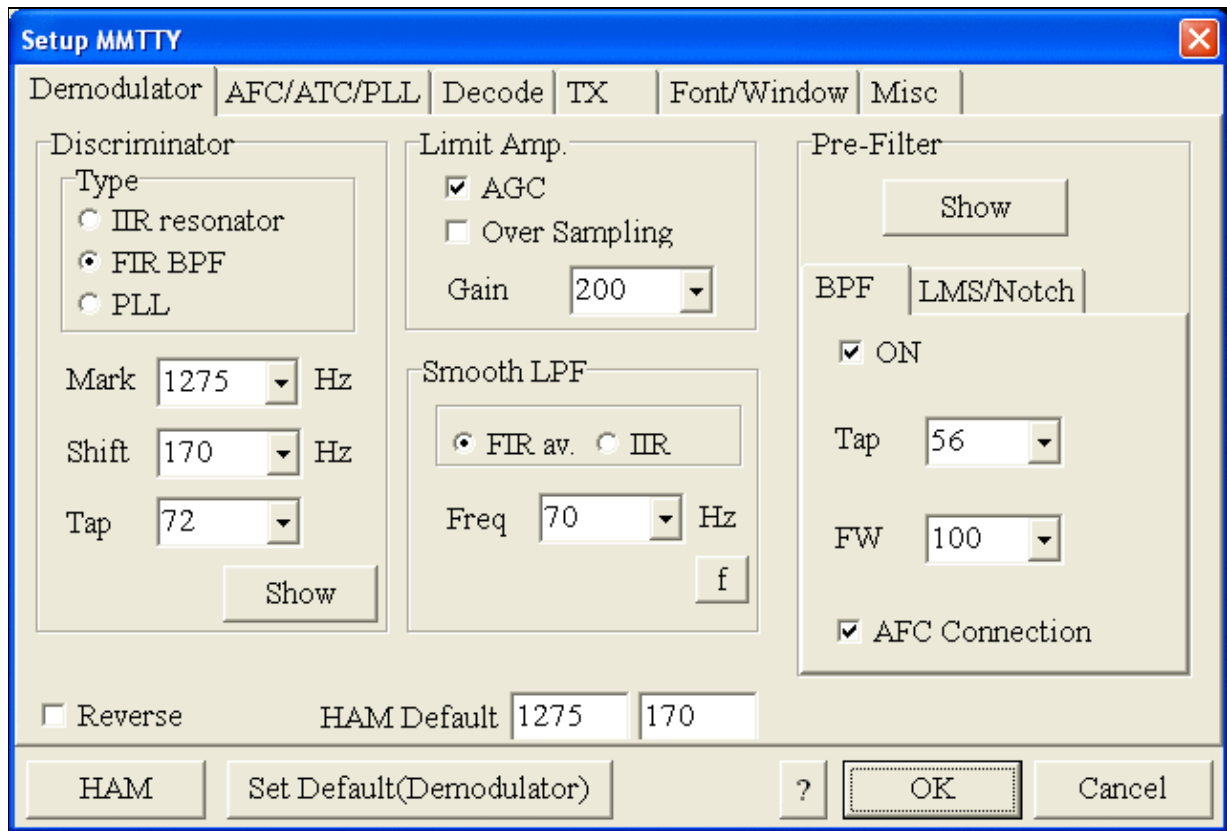

No higher resolution available.

[MmttyDemodulatorSetup.gif](#) (638 × 431 pixels, file size: 24 KB, MIME type: image/gif)

## File history

Click on a date/time to view the file as it appeared at that time.

	Date/Time	Thumbnail	Dimensions	User	Comment
current	<a href="#">09:19, 4 January 2007</a>		638 × 431 (24 KB)	<a href="#">D16rai</a> ( <a href="#">talk</a>   <a href="#">contribs</a> )	

You cannot overwrite this file.

## File usage

The following 7 pages use this file:

- [BestPractice1](#)
- [BestPractice10](#)
- [BestPractice4](#)
- [BestPractice5](#)
- [BestPractice6](#)
- [BestPractice7](#)
- [BestPractice8](#)

## Namespaces

- [File](#)
- [Discussion](#)

## Variants

## Views

- [Read](#)
- [View source](#)
- [View history](#)

## More

- This page was last edited on 4 January 2007, at 09:19.
- [Privacy policy](#)
- [About Win-Test Wiki](#)
- [Disclaimers](#)



# File:MmttyDemodulatorSetup.gif

From Win-Test Wiki

[Jump to navigation](#) [Jump to search](#)

- [File](#)
- [File history](#)
- [File usage](#)

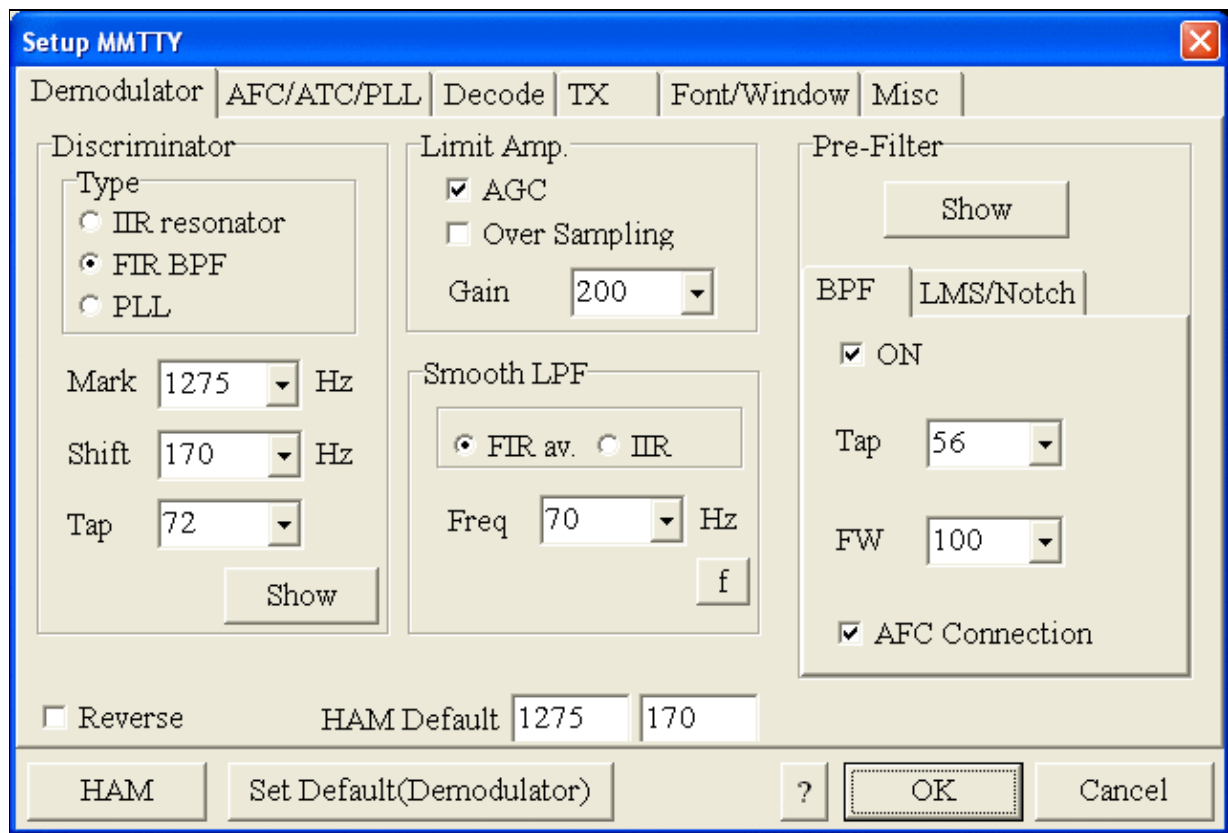

No higher resolution available.

[MmttyDemodulatorSetup.gif](#) (638 × 431 pixels, file size: 24 KB, MIME type: image.gif)

## File history

Click on a date/time to view the file as it appeared at that time.

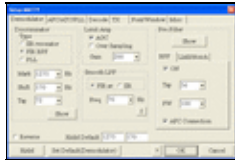
	Date/Time	Thumbnail	Dimensions	User	Comment
current	<a href="#">09:19, 4 January 2007</a>		638 × 431 (24 KB)	<a href="#">D16rai (talk   contribs)</a>	

You cannot overwrite this file.

## File usage

The following 7 pages use this file:

- [BestPractice1](#)
- [BestPractice10](#)
- [BestPractice4](#)
- [BestPractice5](#)
- [BestPractice6](#)
- [BestPractice7](#)
- [BestPractice8](#)

## Namespaces

- [File](#)
- [Discussion](#)

## Variants

## Views

- [Read](#)
- [View source](#)
- [View history](#)

## More

- This page was last edited on 4 January 2007, at 09:19.
- [Privacy policy](#)
- [About Win-Test Wiki](#)
- [Disclaimers](#)



# File:MmttyMiscSetup.gif

From Win-Test Wiki

[Jump to navigation](#) [Jump to search](#)

- [File](#)
- [File history](#)
- [File usage](#)

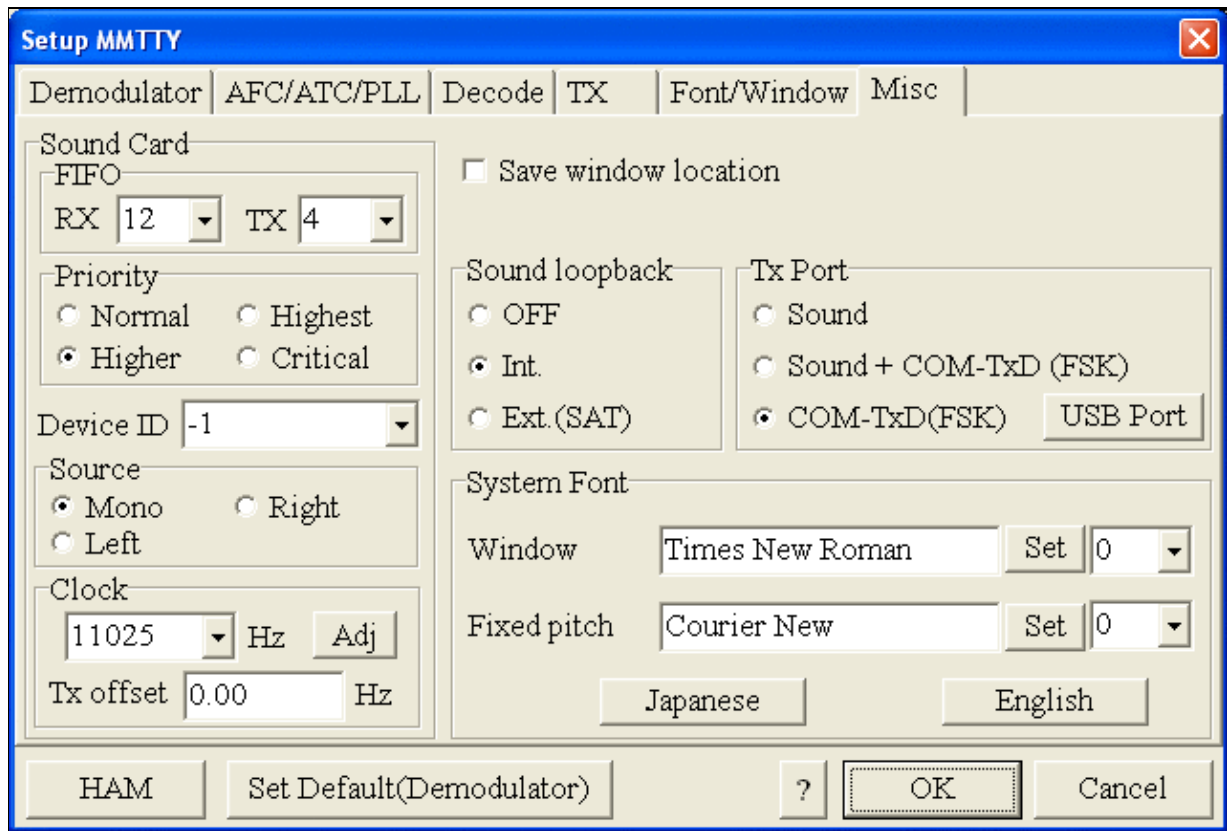

No higher resolution available.

[MmttyMiscSetup.gif](#) (638 × 431 pixels, file size: 25 KB, MIME type: image.gif)

## File history

Click on a date/time to view the file as it appeared at that time.

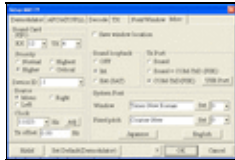
	Date/Time	Thumbnail	Dimensions	User	Comment
current	<u>09:20, 4 January 2007</u>		638 × 431 (25 KB)	<a href="#">D16rai</a> ( <a href="#">talk</a>   <a href="#">contribs</a> )	

You cannot overwrite this file.

## File usage

The following 6 pages use this file:

- [BestPractice1](#)
- [BestPractice10](#)
- [BestPractice4](#)
- [BestPractice5](#)
- [BestPractice6](#)
- [BestPractice8](#)

## Namespaces

- [File](#)
- [Discussion](#)

## Variants

## Views

- [Read](#)
- [View source](#)
- [View history](#)

## More

- This page was last edited on 4 January 2007, at 09:20.

- [Privacy policy](#)
- [About Win-Test Wiki](#)
- [Disclaimers](#)





# File:MmttyMiscSetup-FSK.gif

From Win-Test Wiki

[Jump to navigation](#) [Jump to search](#)

- [File](#)
- [File history](#)
- [File usage](#)

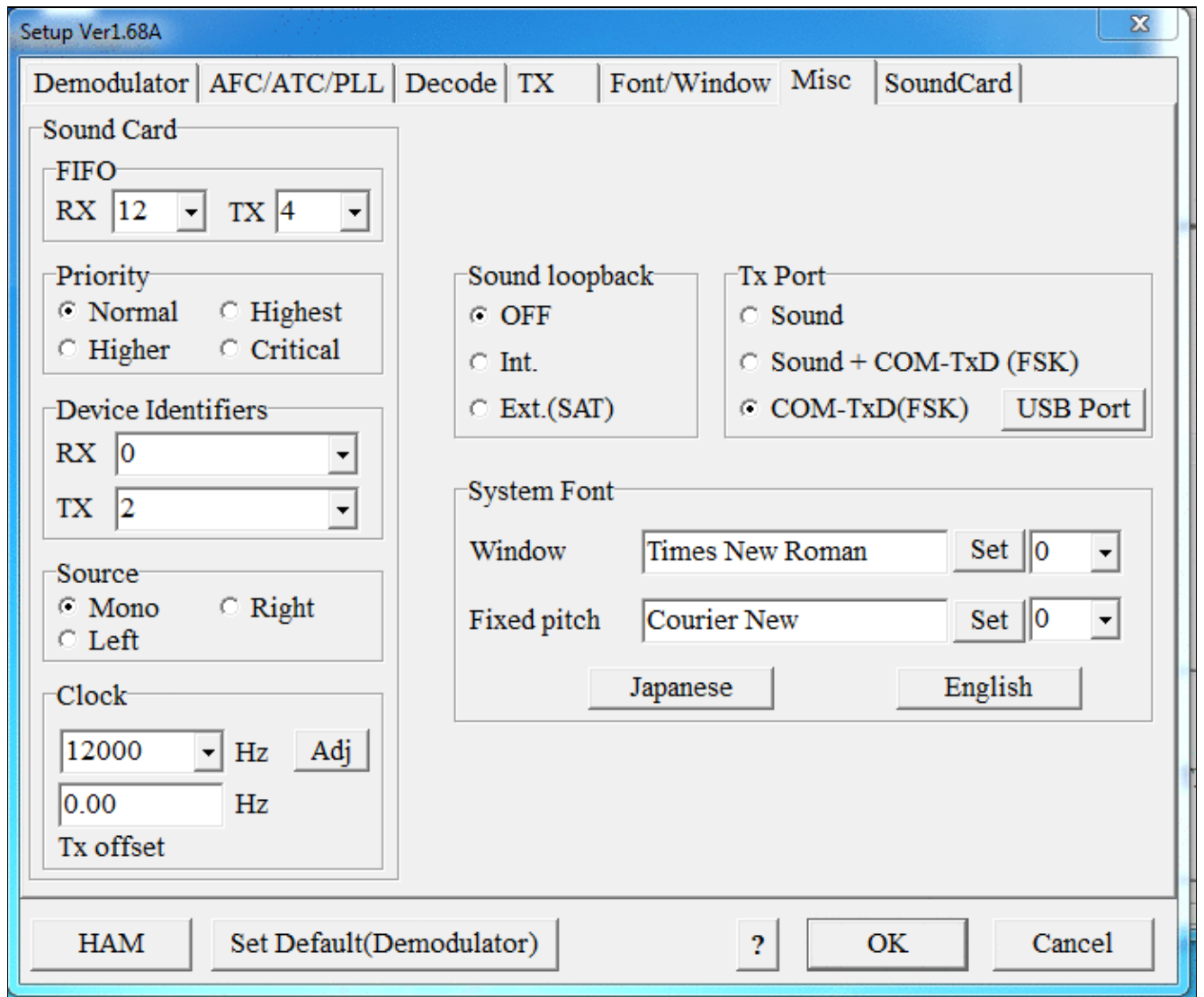

No higher resolution available.

[MmtyMiscSetup-FSK.gif](#) (690 × 578 pixels, file size: 63 KB, MIME type: image/gif)

## File history

Click on a date/time to view the file as it appeared at that time.

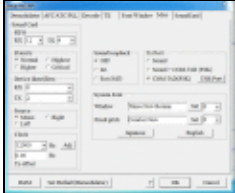
	Date/Time	Thumbnail	Dimensions	User	Comment
current	<a href="#">10:46, 8 February 2020</a>		690 × 578 (63 KB)	<a href="#">D16rai</a> ( <a href="#">talk</a>   <a href="#">contribs</a> )	

You cannot overwrite this file.

## File usage

The following page uses this file:

- [BestPractice7](#)

## Namespaces

- [File](#)
- [Discussion](#)

## Variants

## Views

- [Read](#)
- [View source](#)
- [View history](#)

## More

- This page was last edited on 8 February 2020, at 10:46.
- [Privacy policy](#)
- [About Win-Test Wiki](#)
- [Disclaimers](#)



# File:MmttyMiscSetup-FSK.gif

From Win-Test Wiki

[Jump to navigation](#) [Jump to search](#)

- [File](#)
- [File history](#)
- [File usage](#)

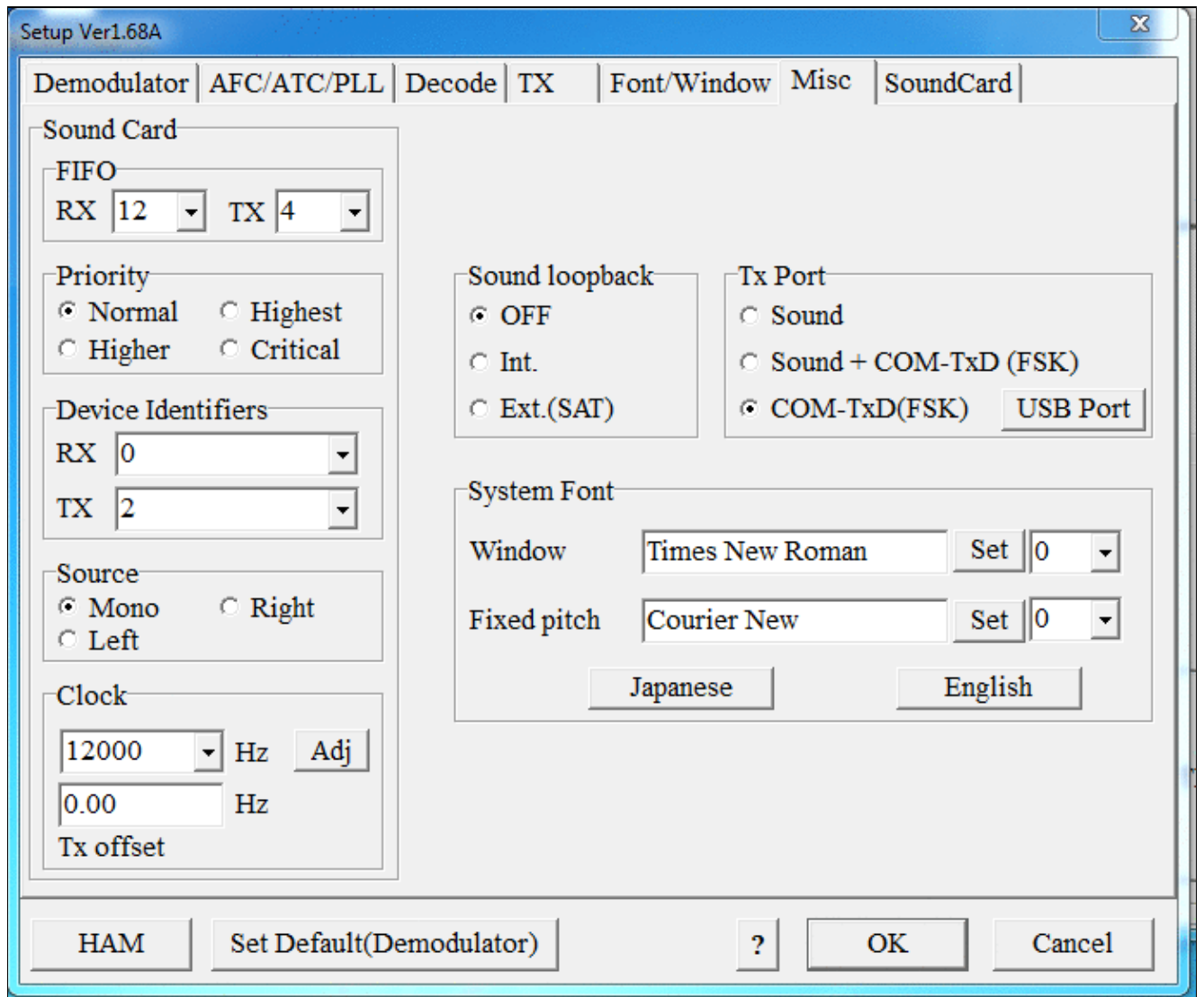

No higher resolution available.

[MmtyMiscSetup-FSK.gif](#) (690 × 578 pixels, file size: 63 KB, MIME type: image.gif)

## File history

Click on a date/time to view the file as it appeared at that time.

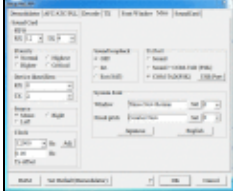
	Date/Time	Thumbnail	Dimensions	User	Comment
current	<a href="#">10:46, 8 February 2020</a>		690 × 578 (63 KB)	<a href="#">Dl6rai</a> ( <a href="#">talk</a>   <a href="#">contribs</a> )	

You cannot overwrite this file.

## File usage

The following page uses this file:

- [BestPractice7](#)

## Namespaces

- [File](#)
- [Discussion](#)

## Variants

## Views

- [Read](#)
- [View source](#)
- [View history](#)

## More

- This page was last edited on 8 February 2020, at 10:46.
- [Privacy policy](#)
- [About Win-Test Wiki](#)
- [Disclaimers](#)



# File:MmttyMiscSetup.gif

From Win-Test Wiki

[Jump to navigation](#) [Jump to search](#)

- [File](#)
- [File history](#)
- [File usage](#)

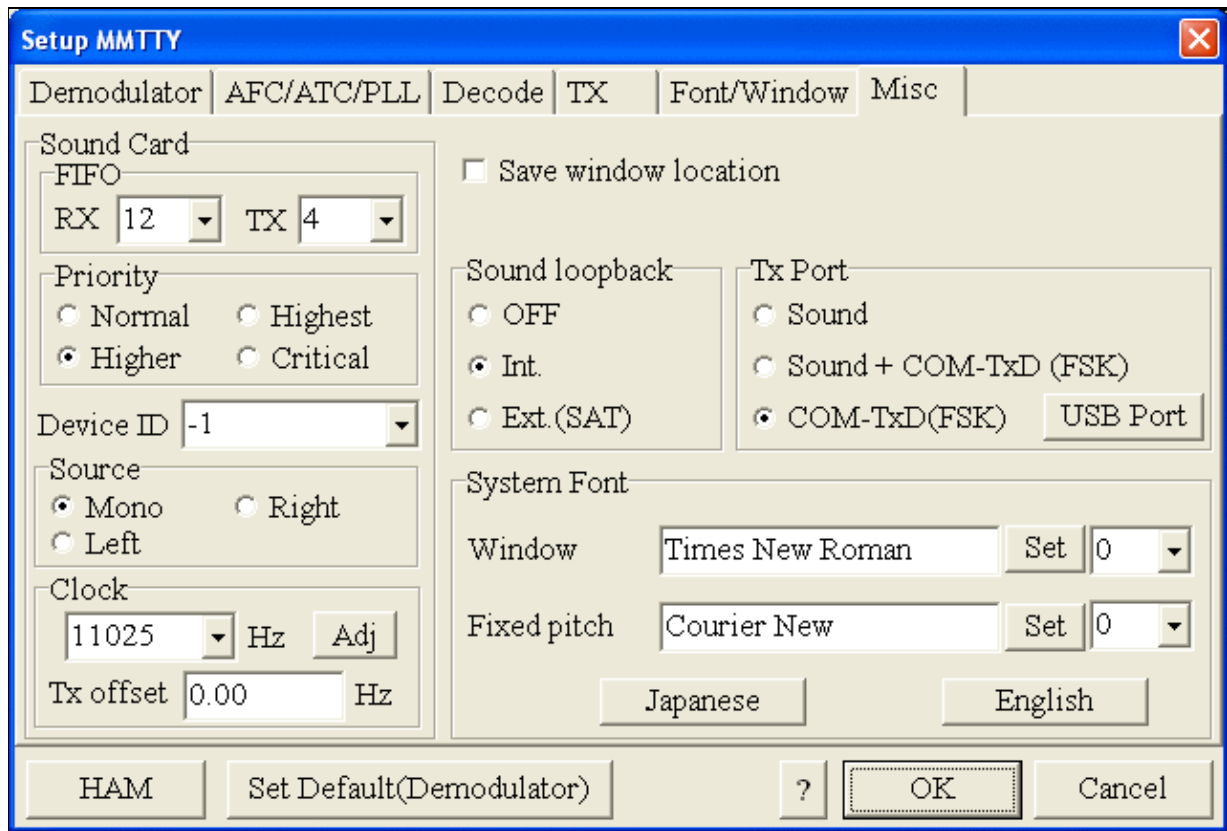

No higher resolution available.

[MmttyMiscSetup.gif](#) (638 × 431 pixels, file size: 25 KB, MIME type: image.gif)

## File history

Click on a date/time to view the file as it appeared at that time.

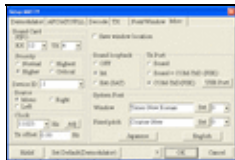
	Date/Time	Thumbnail	Dimensions	User	Comment
current	<a href="#">09:20, 4 January 2007</a>		638 × 431 (25 KB)	<a href="#">D16rai</a> ( <a href="#">talk</a>   <a href="#">contribs</a> )	

You cannot overwrite this file.

## File usage

The following 6 pages use this file:

- [BestPractice1](#)
- [BestPractice10](#)
- [BestPractice4](#)
- [BestPractice5](#)
- [BestPractice6](#)
- [BestPractice8](#)

## Namespaces

- [File](#)
- [Discussion](#)

## Variants

## Views

- [Read](#)
- [View source](#)
- [View history](#)

## More

- This page was last edited on 4 January 2007, at 09:20.

- [Privacy policy](#)
- [About Win-Test Wiki](#)
- [Disclaimers](#)



# File:MMTTY PTT Port.gif

From Win-Test Wiki

[Jump to navigation](#) [Jump to search](#)

- [File](#)
- [File history](#)
- [File usage](#)
- [Metadata](#)

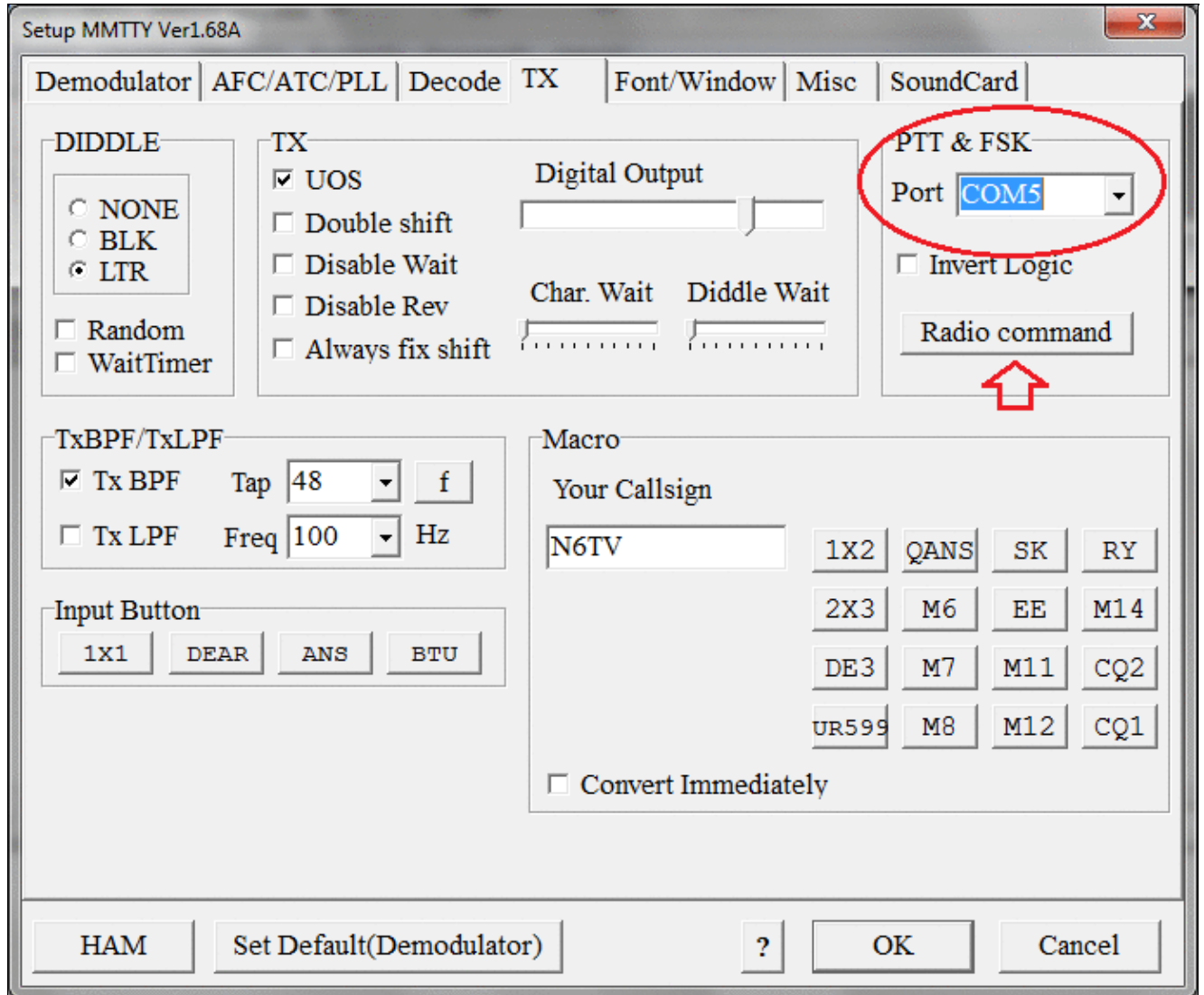

No higher resolution available.

[MMTTY\\_PTT\\_Port.gif](#) (688 × 576 pixels, file size: 58 KB, MIME type: image/gif)

MMTTY PTT port with Radio Command Button indicated. Goes with next image  
MMTTY\_Radio\_Command\_Port.

## File history

Click on a date/time to view the file as it appeared at that time.

Date/Time	Thumbnail	Dimensions	User	Comment
<u><a href="#">21:54, 20 December 2014</a></u>		688 × 576 (58 KB)	<u><a href="#">N6TV</a></u> ( <u><a href="#">talk</a></u>   <u><a href="#">contribs</a></u> )	MMTTY PTT port with Radio Command Button indicated. Goes with next image MMTTY_Radio_Command_Port.

You cannot overwrite this file.

## File usage

The following page uses this file:

- [RTTY](#)

## Metadata

This file contains additional information, probably added from the digital camera or scanner used to create or digitize it.

If the file has been modified from its original state, some details may not fully reflect the modified file.

**Horizontal resolution** 37.79 dpc

**Vertical resolution** 37.79 dpc

## Namespaces

- [File](#)
- [Discussion](#)

## Variants

## Views

- [Read](#)
- [View source](#)
- [View history](#)



## More

- This page was last edited on 20 December 2014, at 21:54.

- [Privacy policy](#)
- [About Win-Test Wiki](#)
- [Disclaimers](#)



# File:MMTTY PTT Port.gif

From Win-Test Wiki

[Jump to navigation](#) [Jump to search](#)

- [File](#)
- [File history](#)
- [File usage](#)
- [Metadata](#)

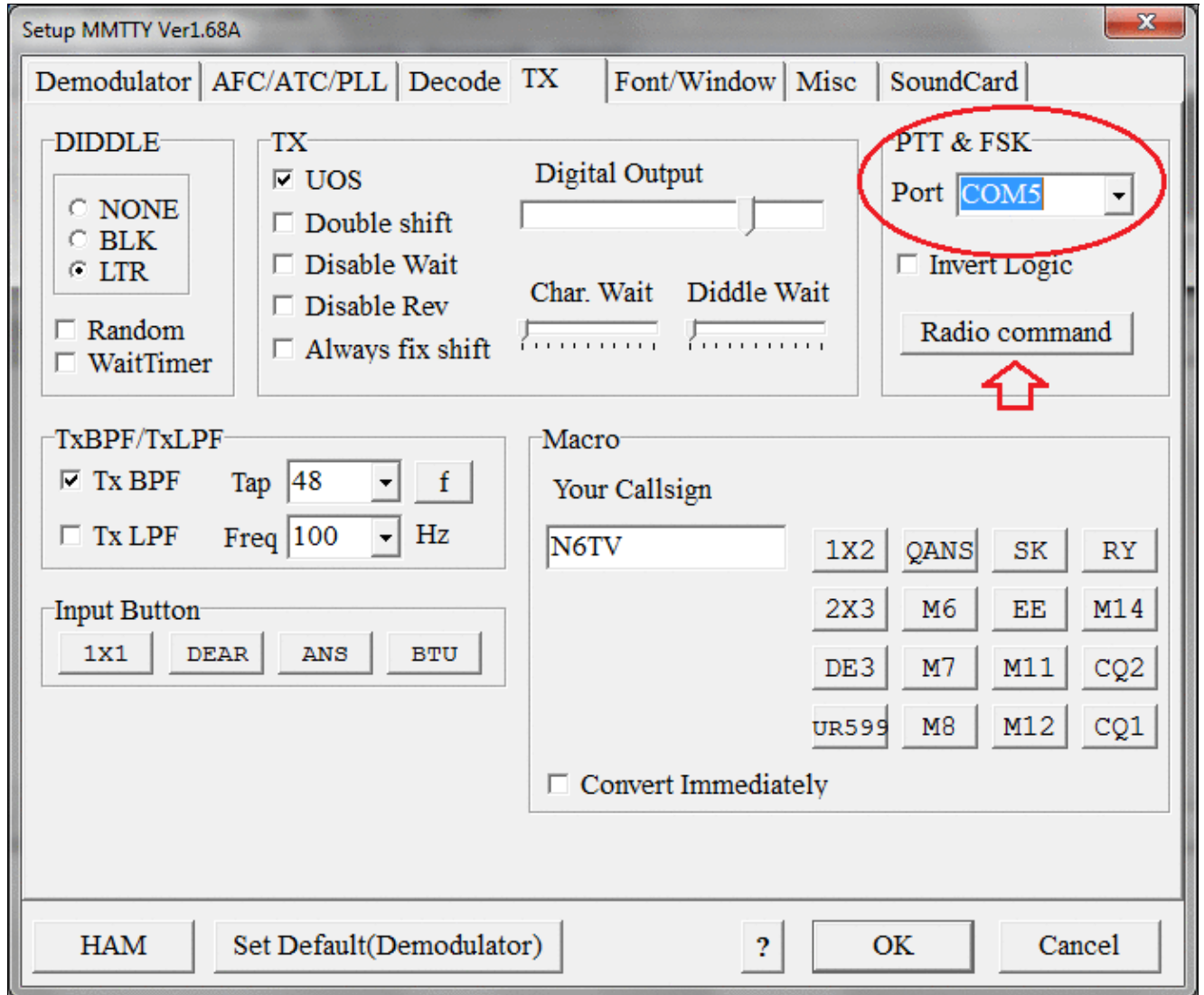

No higher resolution available.

MMTTY\_PTT\_Port.gif (688 × 576 pixels, file size: 58 KB, MIME type: image/gif)

MMTTY PTT port with Radio Command Button indicated. Goes with next image  
 MMTTY\_Radio\_Command\_Port.

## File history

Click on a date/time to view the file as it appeared at that time.

Date/Time	Thumbnail	Dimensions	User	Comment
<u>21:54, 20</u> current <u>December</u> <u>2014</u>		688 × 576 (58 KB)	<u>N6TV</u> ( <u>talk</u>   <u>contribs</u> )	MMTTY PTT port with Radio Command Button indicated. Goes with next image MMTTY_Radio_Command_Port.

You cannot overwrite this file.

## File usage

The following page uses this file:

- RTTY

## Metadata

This file contains additional information, probably added from the digital camera or scanner used to create or digitize it.

If the file has been modified from its original state, some details may not fully reflect the modified file.

**Horizontal resolution** 37.79 dpc

**Vertical resolution** 37.79 dpc

## Namespaces

- File
- Discussion

## Variants

## Views

- Read
- View source
- View history

## More

- This page was last edited on 20 December 2014, at 21:54.

- [Privacy policy](#)
- [About Win-Test Wiki](#)
- [Disclaimers](#)



# File:MMTTY Radio Command Port.gif

From Win-Test Wiki

[Jump to navigation](#) [Jump to search](#)

- [File](#)
- [File history](#)
- [File usage](#)
- [Metadata](#)

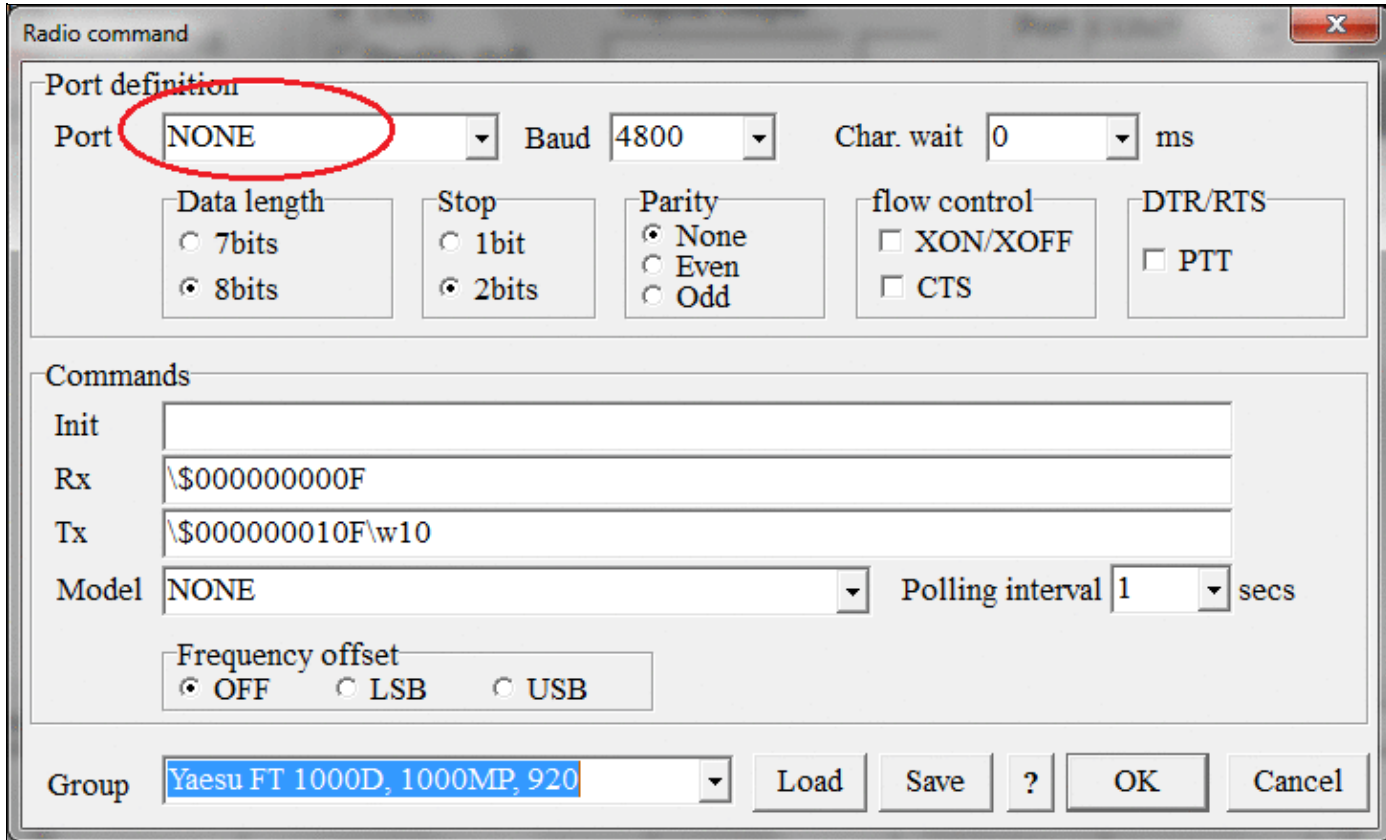

No higher resolution available.

MMTTY Radio Command Port.gif (725 Å 438 pixels, file size: 43 KB, MIME type: image.gif)

MMTTY Radio Command Dialog the Radio port set to NONE as required in most cases

## File history

Click on a date/time to view the file as it appeared at that time.

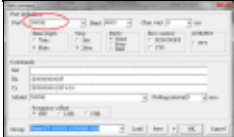
	Date/Time	Thumbnail	Dimensions	User	Comment
current	<u>21:55, 20 December 2014</u>		725 Å 438 (43 KB)	<u>N6TV (talk   contribs)</u>	MMTTY Radio Command Dialog the Radio port set to NONE as required in most cases

You cannot overwrite this file.

## File usage

The following page uses this file:

- RTTY

## Metadata

This file contains additional information, probably added from the digital camera or scanner used to create or digitize it.

If the file has been modified from its original state, some details may not fully reflect the modified file.

**Horizontal resolution** 37.79 dpc

**Vertical resolution** 37.79 dpc

## Namespaces

- File
- Discussion

## Variants

## Views

- Read
- View source
- View history

## More

- This page was last edited on 20 December 2014, at 21:55.

- [Privacy policy](#)
- [About Win-Test Wiki](#)
- [Disclaimers](#)



# File:MMTTY Radio Command Port.gif

From Win-Test Wiki

[Jump to navigation](#) [Jump to search](#)

- [File](#)
- [File history](#)
- [File usage](#)
- [Metadata](#)

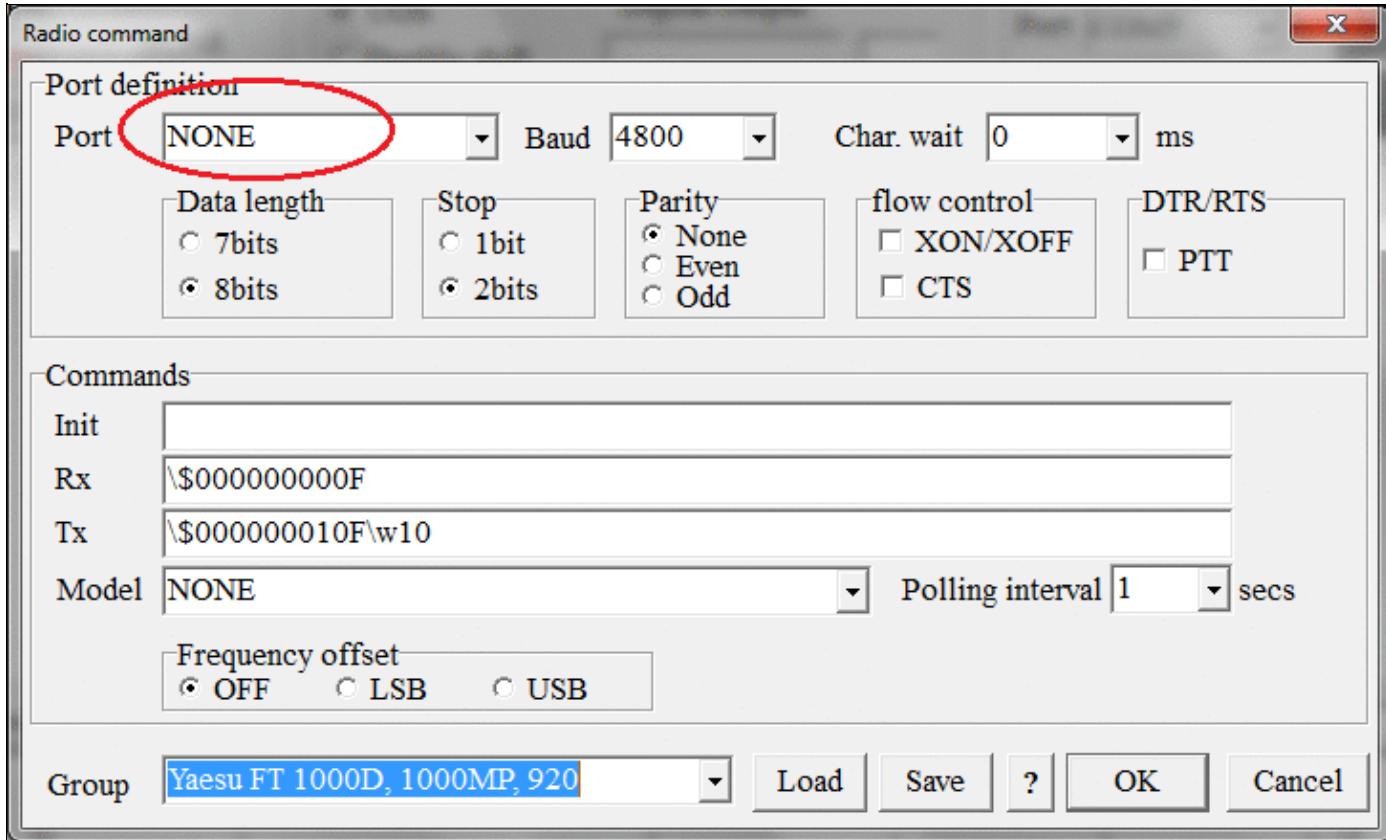



No higher resolution available.

[MMTTY Radio Command Port.gif](#) (725 Å 438 pixels, file size: 43 KB, MIME type: image.gif)

MMTTY Radio Command Dialog the Radio port set to NONE as required in most cases

## File history

Click on a date/time to view the file as it appeared at that time.

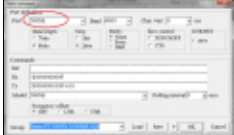
	Date/Time	Thumbnail	Dimensions	User	Comment
current	<u><a href="#">21:55, 20 December 2014</a></u>		725 Å 438 (43 KB)	<u><a href="#">N6TV</a></u> ( <u><a href="#">talk</a></u>   <u><a href="#">contribs</a></u> )	MMTTY Radio Command Dialog the Radio port set to NONE as required in most cases

You cannot overwrite this file.

## File usage

The following page uses this file:

- [RTTY](#)

## Metadata

This file contains additional information, probably added from the digital camera or scanner used to create or digitize it.

If the file has been modified from its original state, some details may not fully reflect the modified file.

**Horizontal resolution** 37.79 dpc

**Vertical resolution** 37.79 dpc

## Namespaces

- [File](#)
- [Discussion](#)

## Variants

## Views

- [Read](#)
- [View source](#)
- [View history](#)

## More

- This page was last edited on 20 December 2014, at 21:55.

- [Privacy policy](#)
- [About Win-Test Wiki](#)
- [Disclaimers](#)



# File:MmttySoudCardSetup.gif

From Win-Test Wiki

[Jump to navigation](#) [Jump to search](#)

- [File](#)
- [File history](#)
- [File usage](#)

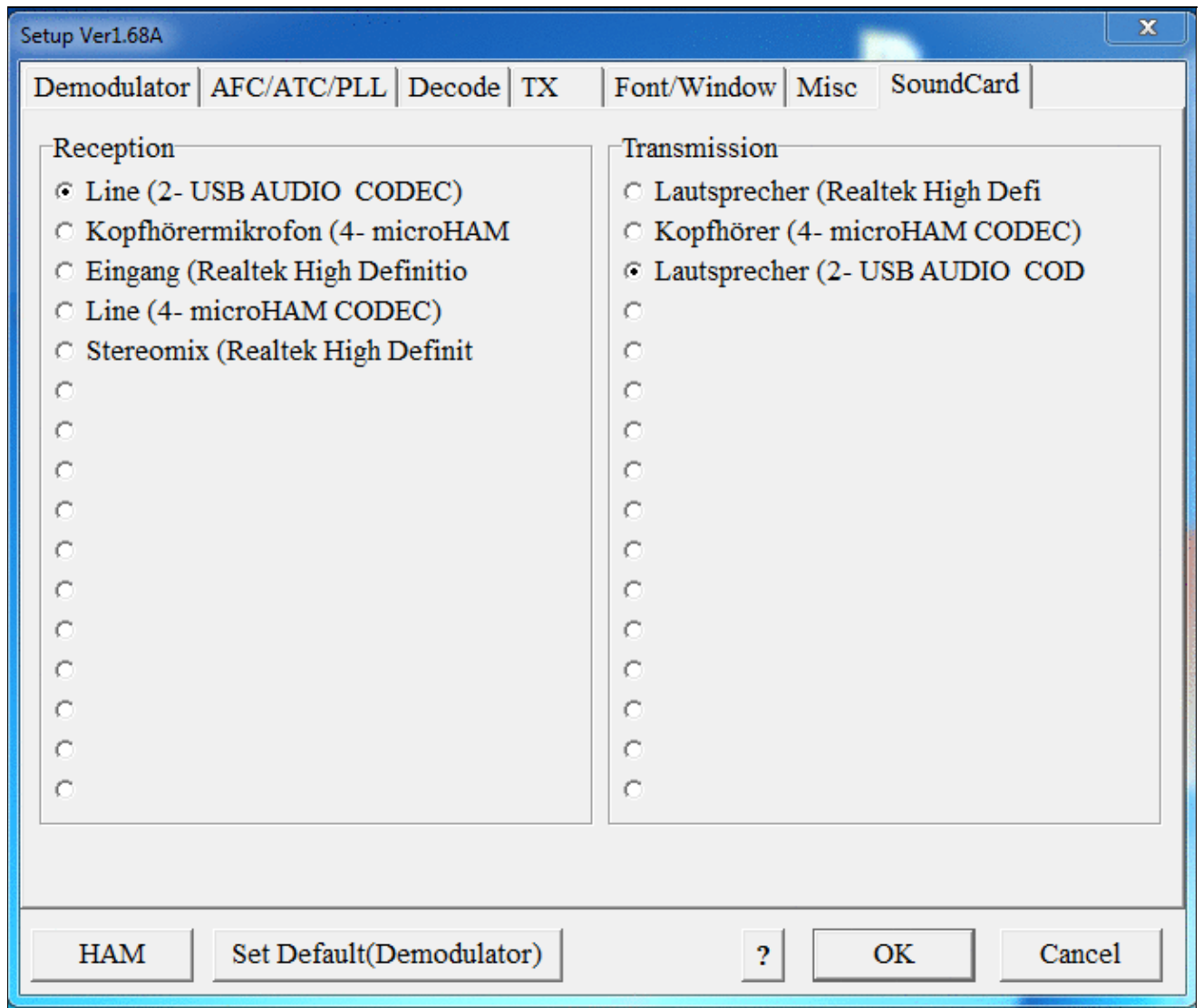

No higher resolution available.

[MmtySoudCardSetup.gif](#) (685 × 580 pixels, file size: 53 KB, MIME type: image.gif)

## File history

Click on a date/time to view the file as it appeared at that time.

	Date/Time	Thumbnail	Dimensions	User	Comment
current	<a href="#">10:26, 8 February 2020</a>		685 × 580 (53 KB)	<a href="#">Dl6rai</a> ( <a href="#">talk</a>   <a href="#">contribs</a> )	

You cannot overwrite this file.

## File usage

The following page uses this file:

- [BestPractice7](#)

## Namespaces

- [File](#)
- [Discussion](#)

## Variants

## Views

- [Read](#)
- [View source](#)
- [View history](#)

## More

- This page was last edited on 8 February 2020, at 10:26.
- [Privacy policy](#)
- [About Win-Test Wiki](#)
- [Disclaimers](#)



# File:MmttySoudCardSetup.gif

From Win-Test Wiki

[Jump to navigation](#) [Jump to search](#)

- [File](#)
- [File history](#)
- [File usage](#)

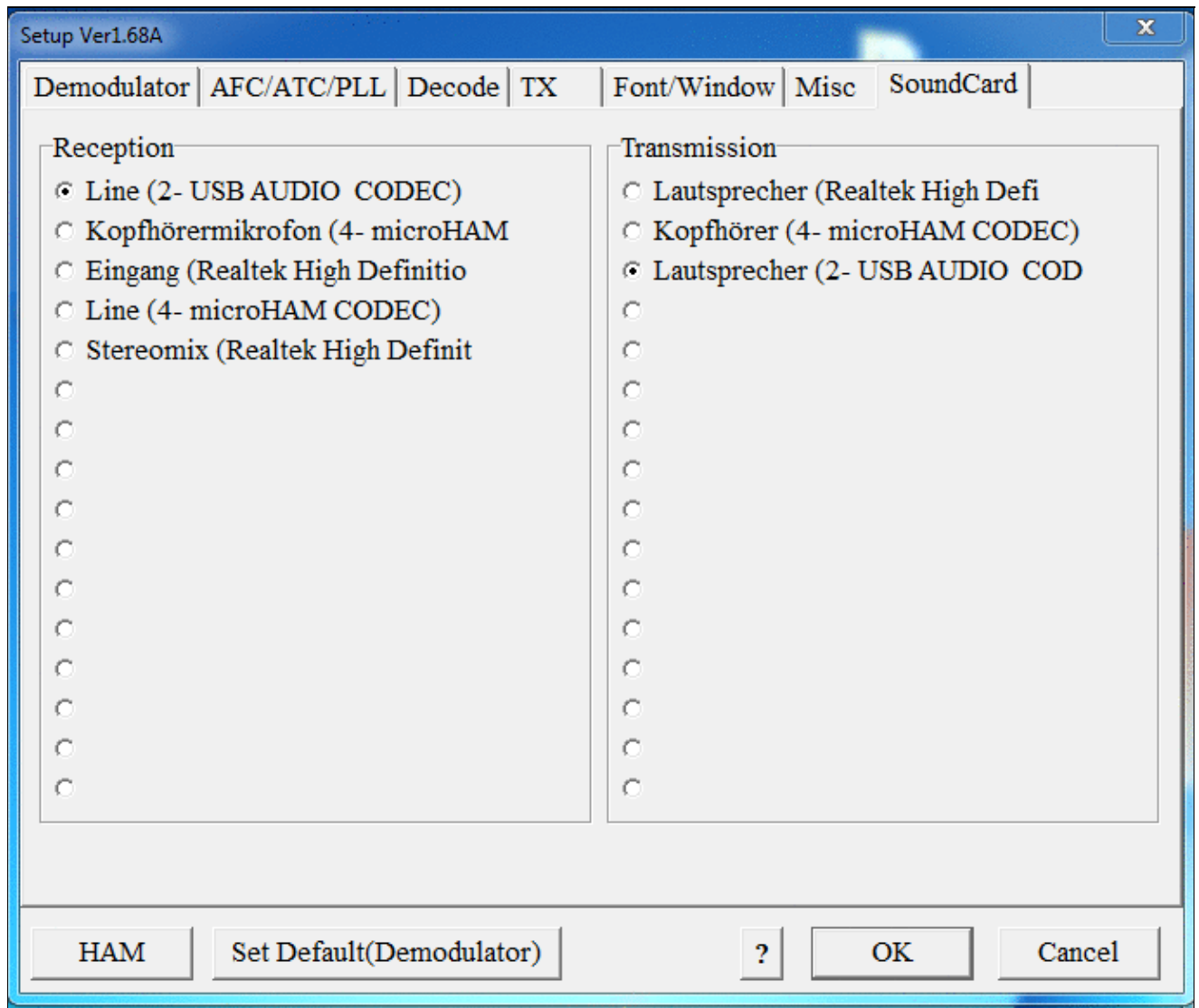

No higher resolution available.

MmttySoudCardSetup.gif (685 × 580 pixels, file size: 53 KB, MIME type: image.gif)

## File history

Click on a date/time to view the file as it appeared at that time.

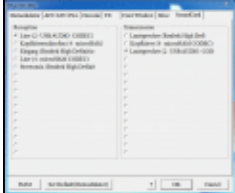
	Date/Time	Thumbnail	Dimensions	User	Comment
current	<u>10:26, 8 February 2020</u>		685 × 580 (53 KB)	<u>D16rai</u> ( <a href="#">talk</a>   <a href="#">contribs</a> )	

You cannot overwrite this file.

## File usage

The following page uses this file:

- BestPractice7

## Namespaces

- File
- Discussion

## Variants

## Views

- Read
- View source
- View history

## More

- This page was last edited on 8 February 2020, at 10:26.

- Privacy policy
- About Win-Test Wiki
- Disclaimers



# File:MmttyTxSetup.gif

From Win-Test Wiki

[Jump to navigation](#) [Jump to search](#)

- [File](#)
- [File history](#)
- [File usage](#)

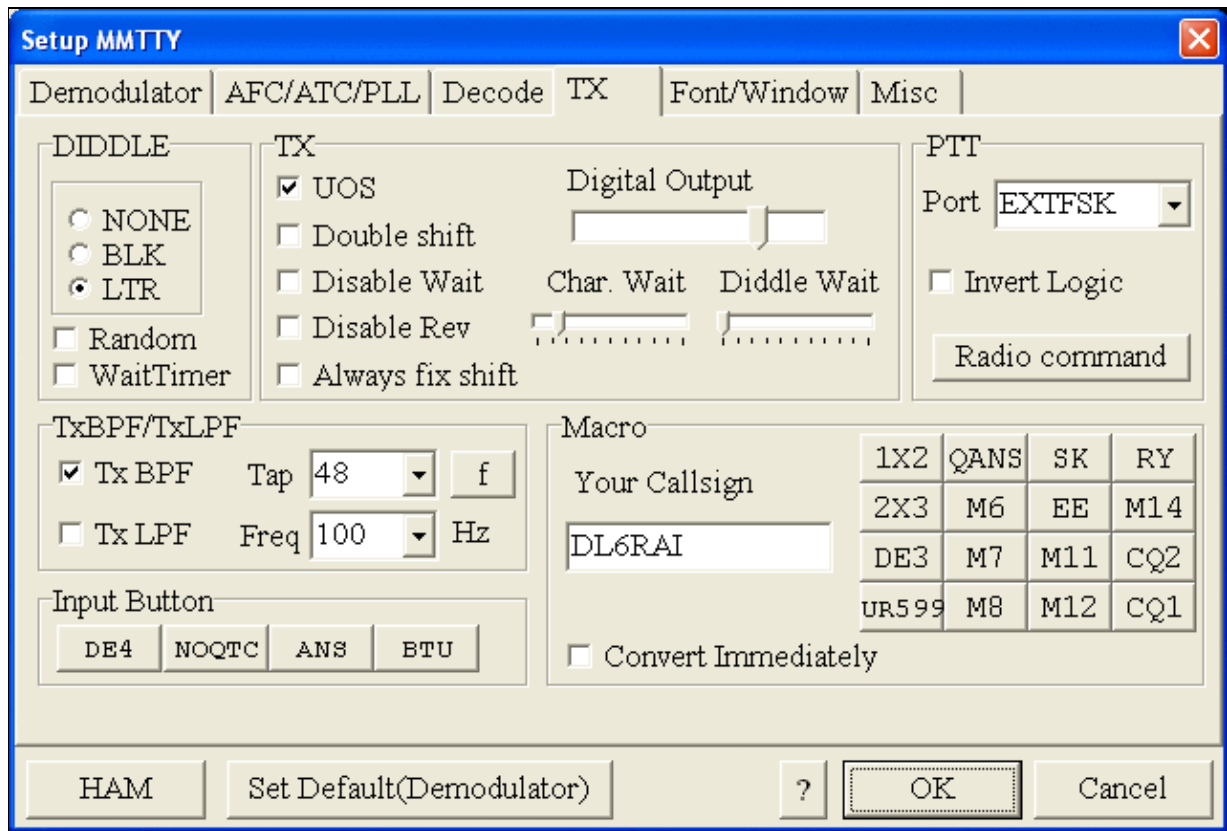

No higher resolution available.

MmttyTxSetup.gif (638 × 431 pixels, file size: 25 KB, MIME type: image.gif)

## File history

Click on a date/time to view the file as it appeared at that time.

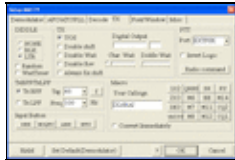
	Date/Time	Thumbnail	Dimensions	User	Comment
current	<u>09:20, 4 January 2007</u>		638 × 431 (25 KB)	<u>D16rai</u> ( <u>talk</u>   <u>contribs</u> )	

You cannot overwrite this file.

## File usage

The following page uses this file:

- BestPractice1

## Namespaces

- File
- Discussion

## Variants

## Views

- Read
- View source
- View history

## More

- This page was last edited on 4 January 2007, at 09:20.

- Privacy policy
- About Win-Test Wiki
- Disclaimers





# File:MmttyTxSetup COM8.gif

From Win-Test Wiki

[Jump to navigation](#) [Jump to search](#)

- [File](#)
- [File history](#)
- [File usage](#)

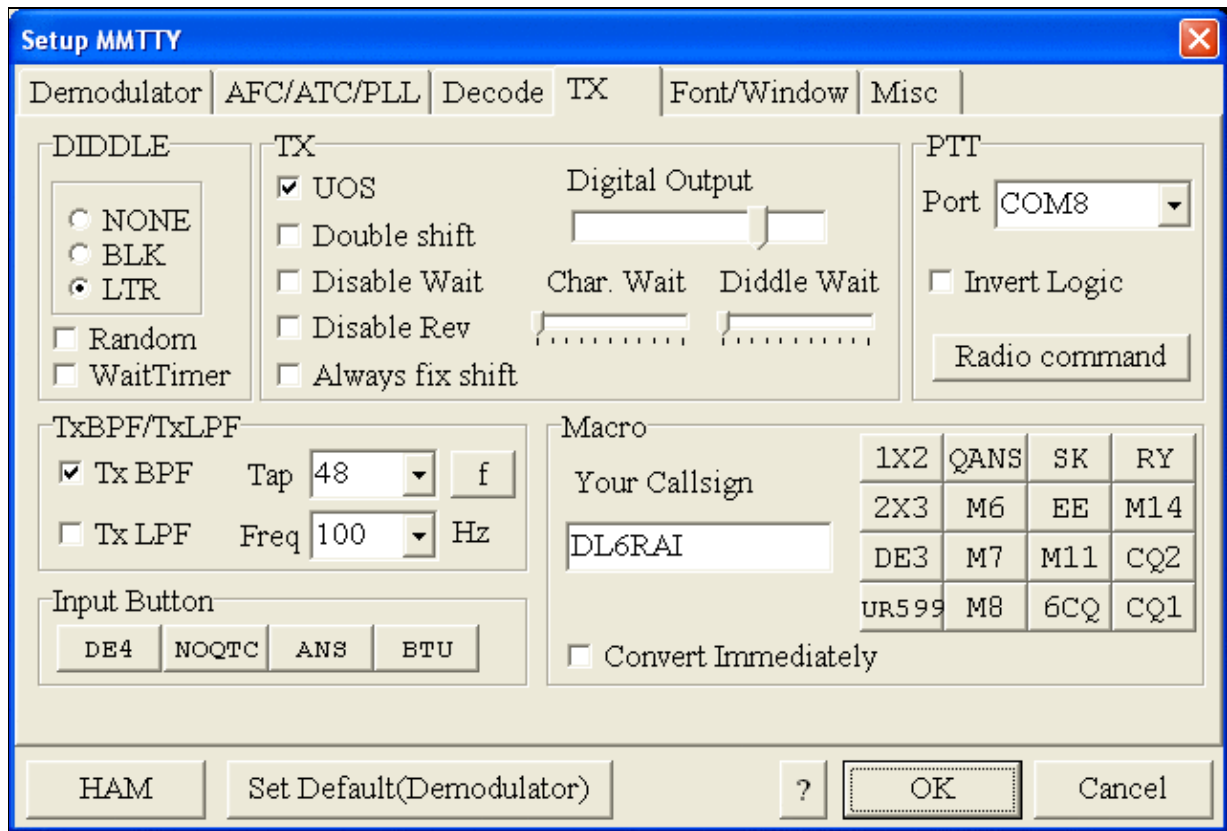

No higher resolution available.

MmttyTxSetup\_COM8.gif (638 × 431 pixels, file size: 25 KB, MIME type: image/gif)

## File history

Click on a date/time to view the file as it appeared at that time.

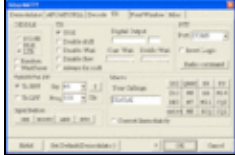
	Date/Time	Thumbnail	Dimensions	User	Comment
current	<u>20:22, 14 November 2007</u>		638 × 431 (25 KB)	<u>D16rai</u> ( <a href="#">talk</a>   <a href="#">contribs</a> )	

You cannot overwrite this file.

## File usage

The following 5 pages use this file:

- [BestPractice10](#)
- [BestPractice4](#)
- [BestPractice5](#)
- [BestPractice6](#)
- [BestPractice8](#)

## Namespaces

- [File](#)
- [Discussion](#)

## Variants

## Views

- [Read](#)
- [View source](#)
- [View history](#)

## More

- This page was last edited on 14 November 2007, at 20:22.
- [Privacy policy](#)
- [About Win-Test Wiki](#)
- [Disclaimers](#)



# File:MmttyTxSetup COM8.gif

From Win-Test Wiki

[Jump to navigation](#) [Jump to search](#)

- [File](#)
- [File history](#)
- [File usage](#)

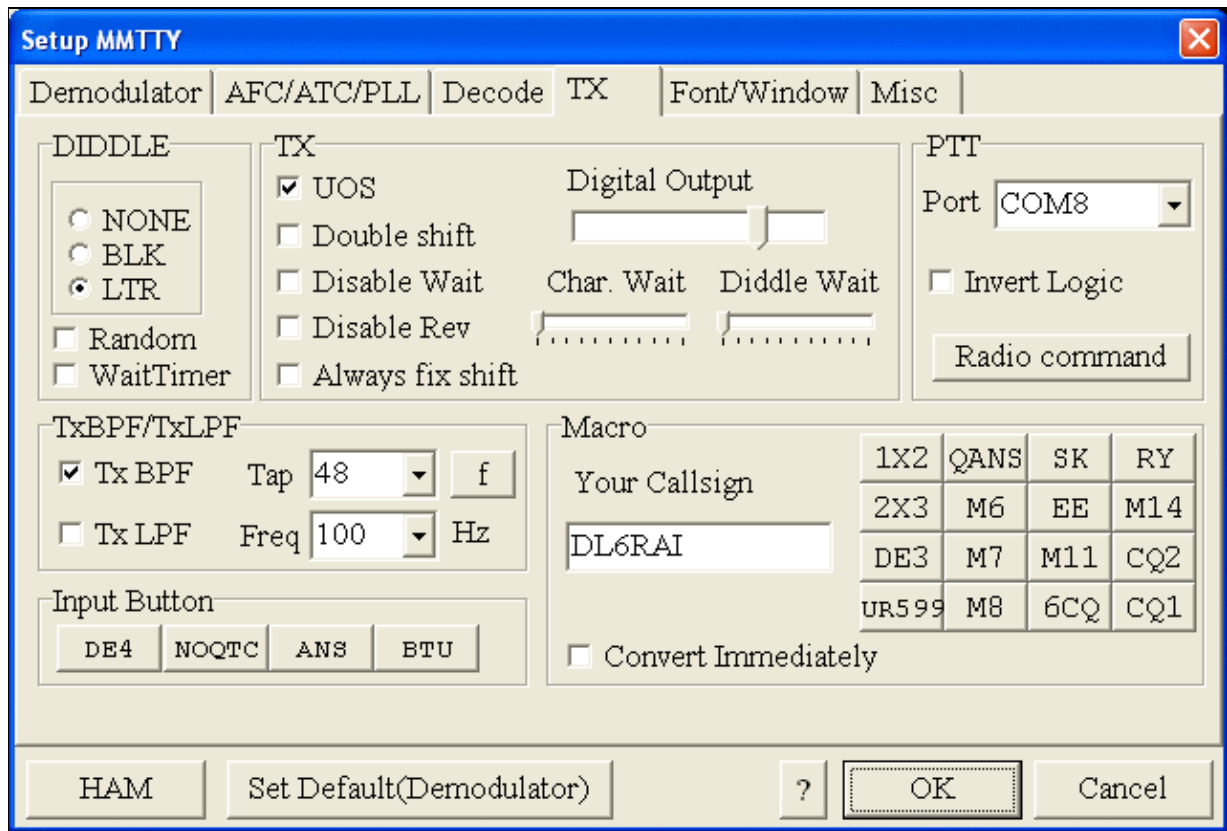

No higher resolution available.

MmttyTxSetup\_COM8.gif (638 × 431 pixels, file size: 25 KB, MIME type: image/gif)

## File history

Click on a date/time to view the file as it appeared at that time.

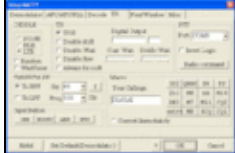
	Date/Time	Thumbnail	Dimensions	User	Comment
current	<u>20:22, 14 November 2007</u>		638 × 431 (25 KB)	<u>D16rai</u> ( <a href="#">talk</a>   <a href="#">contribs</a> )	

You cannot overwrite this file.

## File usage

The following 5 pages use this file:

- [BestPractice10](#)
- [BestPractice4](#)
- [BestPractice5](#)
- [BestPractice6](#)
- [BestPractice8](#)

## Namespaces

- [File](#)
- [Discussion](#)

## Variants

## Views

- [Read](#)
- [View source](#)
- [View history](#)

## More

- This page was last edited on 14 November 2007, at 20:22.

- [Privacy policy](#)
- [About Win-Test Wiki](#)
- [Disclaimers](#)



# File:MmttyTxSetup-EXTFSK-1.gif

From Win-Test Wiki

[Jump to navigation](#) [Jump to search](#)

- [File](#)
- [File history](#)
- [File usage](#)

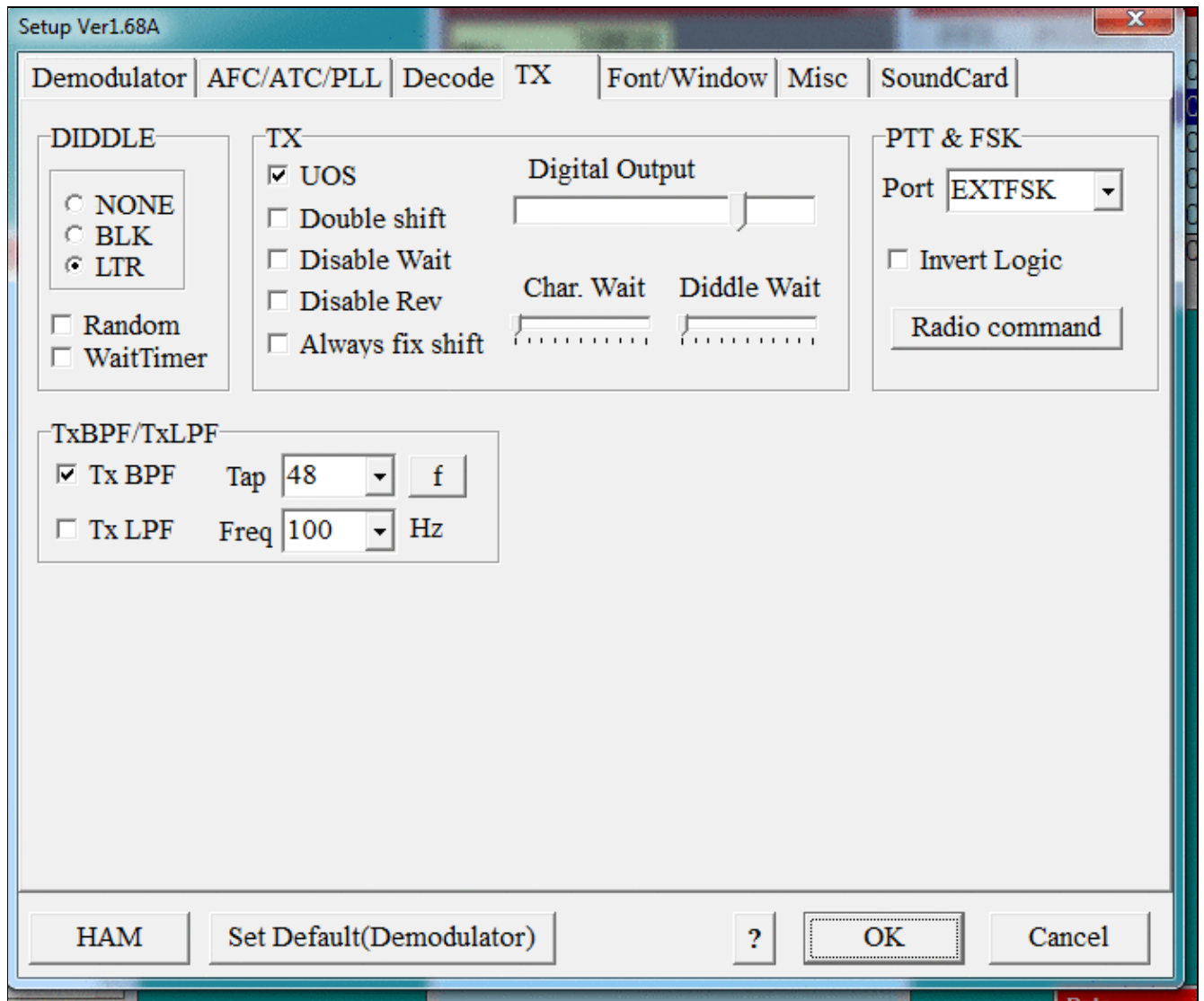

No higher resolution available.

MmttyTxSetup-EXTFSK-1.gif (692 × 580 pixels, file size: 51 KB, MIME type: image.gif)

## File history

Click on a date/time to view the file as it appeared at that time.

	Date/Time	Thumbnail	Dimensions	User	Comment
current	<u>10:05, 8 February 2020</u>		692 × 580 (51 KB)	<u>D16rai</u> ( <a href="#">talk</a>   <a href="#">contribs</a> )	

You cannot overwrite this file.

## File usage

The following page uses this file:

- [BestPractice7](#)

## Namespaces

- [File](#)
- [Discussion](#)

## Variants

## Views

- [Read](#)
- [View source](#)
- [View history](#)

## More

- This page was last edited on 8 February 2020, at 10:05.
- [Privacy policy](#)
- [About Win-Test Wiki](#)
- [Disclaimers](#)



# File:MmttyTxSetup-EXTFSK-1.gif

From Win-Test Wiki

[Jump to navigation](#) [Jump to search](#)

- [File](#)
- [File history](#)
- [File usage](#)

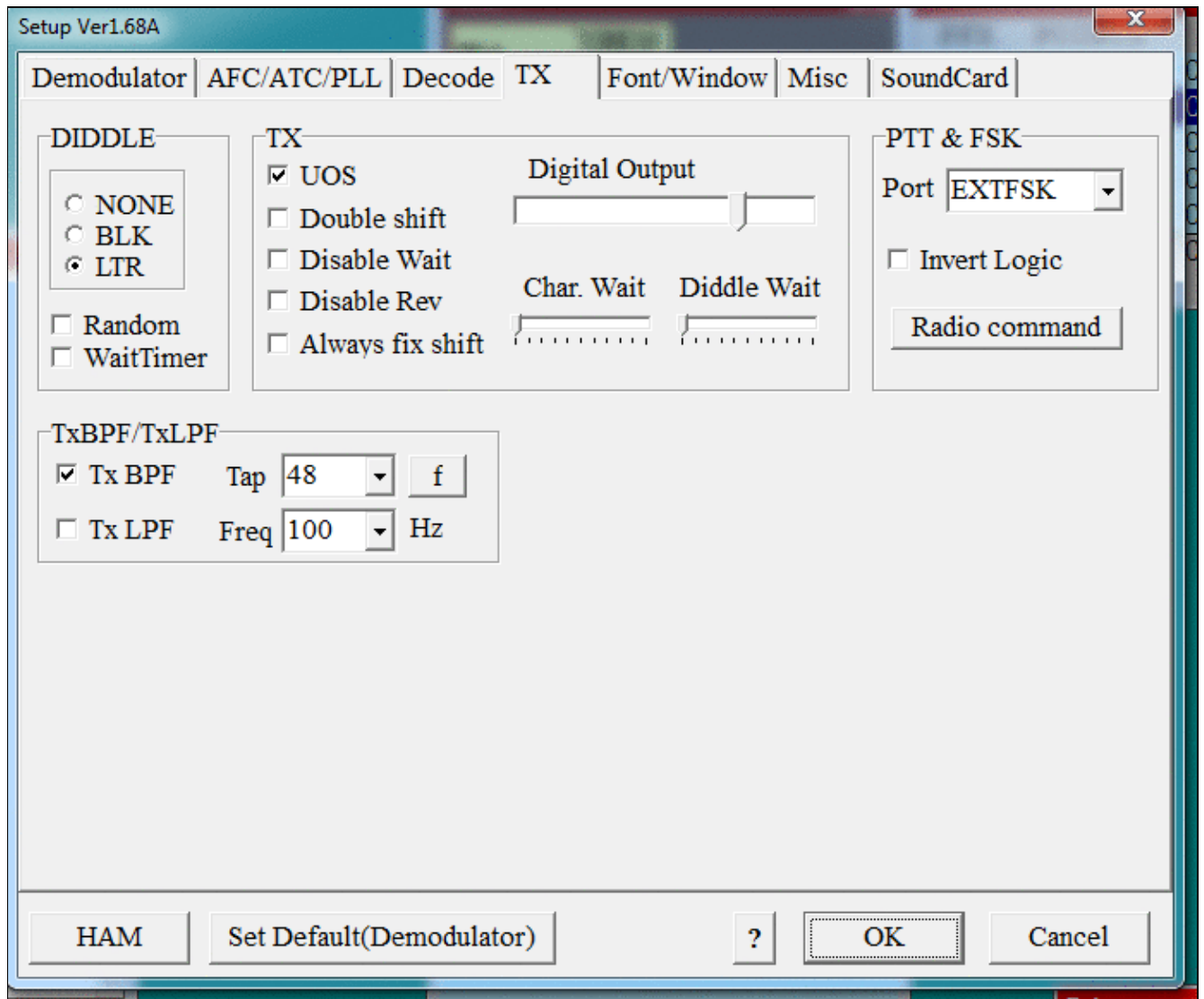

No higher resolution available.

[MmTTYTxSetup-EXTFSK-1.gif](#) (692 × 580 pixels, file size: 51 KB, MIME type: image.gif)

## File history

Click on a date/time to view the file as it appeared at that time.

	Date/Time	Thumbnail	Dimensions	User	Comment
current	<a href="#">10:05, 8 February 2020</a>		692 × 580 (51 KB)	<a href="#">Dl6rai</a> ( <a href="#">talk</a>   <a href="#">contribs</a> )	

You cannot overwrite this file.

## File usage

The following page uses this file:

- [BestPractice7](#)

## Namespaces

- [File](#)
- [Discussion](#)

## Variants

## Views

- [Read](#)
- [View source](#)
- [View history](#)

## More

- This page was last edited on 8 February 2020, at 10:05.
- [Privacy policy](#)
- [About Win-Test Wiki](#)
- [Disclaimers](#)





# File:MmttyTxSetup-EXTFSK-2.gif

From Win-Test Wiki

[Jump to navigation](#) [Jump to search](#)

- [File](#)
- [File history](#)
- [File usage](#)
- [Metadata](#)

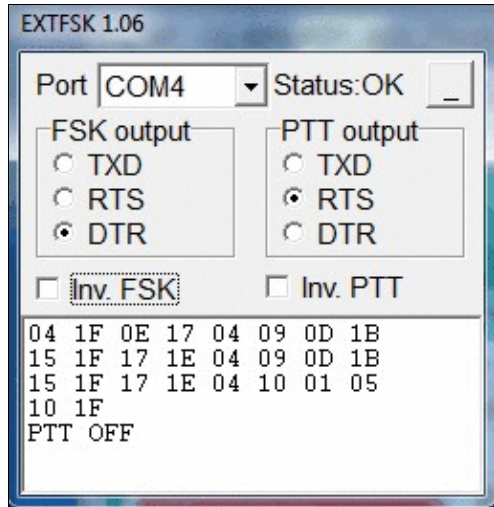

No higher resolution available.

[MmttyTxSetup-EXTFSK-2.gif](#) (256 × 264 pixels, file size: 79 KB, MIME type: image/gif)

## File history

Click on a date/time to view the file as it appeared at that time.

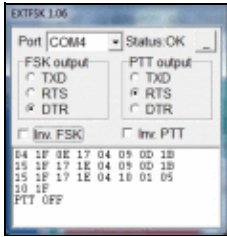
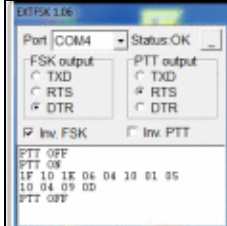
	Date/Time	Thumbnail	Dimensions	User	Comment
current	<a href="#">14:39, 8 February 2020</a>		256 × 264 (79 KB)	<a href="#">Dl6rai</a> ( <a href="#">talk</a>   <a href="#">contribs</a> )	
	<a href="#">10:05, 8 February 2020</a>		256 × 264 (16 KB)	<a href="#">Dl6rai</a> ( <a href="#">talk</a>   <a href="#">contribs</a> )	

Date/Time	Thumbnail	Dimensions	User	Comment
You cannot overwrite this file.				

## File usage

The following page uses this file:

- [BestPractice7](#)

## Metadata

This file contains additional information, probably added from the digital camera or scanner used to create or digitize it.

If the file has been modified from its original state, some details may not fully reflect the modified file.

**Horizontal resolution** 37.79 dpc

**Vertical resolution** 37.79 dpc

## Namespaces

- [File](#)
- [Discussion](#)

## Variants

## Views

- [Read](#)
- [View source](#)
- [View history](#)

## More

- This page was last edited on 8 February 2020, at 14:39.

- [Privacy policy](#)
- [About Win-Test Wiki](#)
- [Disclaimers](#)



# File:MmttyTxSetup-EXTFSK-2.gif

From Win-Test Wiki

[Jump to navigation](#) [Jump to search](#)

- [File](#)
- [File history](#)
- [File usage](#)
- [Metadata](#)

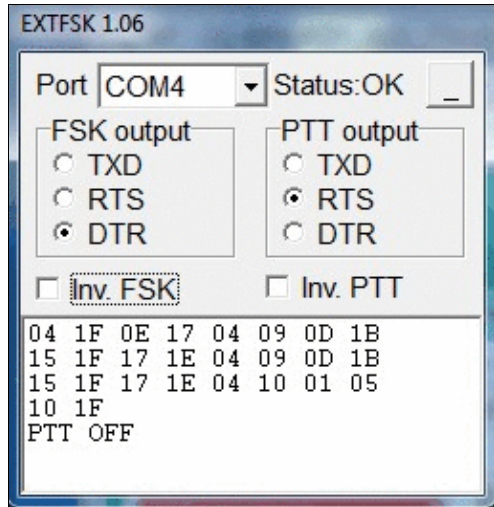

No higher resolution available.

[MmttyTxSetup-EXTFSK-2.gif](#) (256 × 264 pixels, file size: 79 KB, MIME type: image/gif)

## File history

Click on a date/time to view the file as it appeared at that time.

	Date/Time	Thumbnail	Dimensions	User	Comment
current	<a href="#">14:39, 8 February 2020</a>		256 × 264 (79 KB)	<a href="#">Dl6rai</a> ( <a href="#">talk</a>   <a href="#">contribs</a> )	
	<a href="#">10:05, 8 February 2020</a>		256 × 264 (16 KB)	<a href="#">Dl6rai</a> ( <a href="#">talk</a>   <a href="#">contribs</a> )	

Date/Time	Thumbnail	Dimensions	User	Comment
You cannot overwrite this file.				

## File usage

The following page uses this file:

- [BestPractice7](#)

## Metadata

This file contains additional information, probably added from the digital camera or scanner used to create or digitize it.

If the file has been modified from its original state, some details may not fully reflect the modified file.

**Horizontal resolution** 37.79 dpc

**Vertical resolution** 37.79 dpc

## Namespaces

- [File](#)
- [Discussion](#)

## Variants

## Views

- [Read](#)
- [View source](#)
- [View history](#)

## More

- This page was last edited on 8 February 2020, at 14:39.

- [Privacy policy](#)
- [About Win-Test Wiki](#)
- [Disclaimers](#)



# File:MmttyTxSetup.gif

From Win-Test Wiki

[Jump to navigation](#) [Jump to search](#)

- [File](#)
- [File history](#)
- [File usage](#)

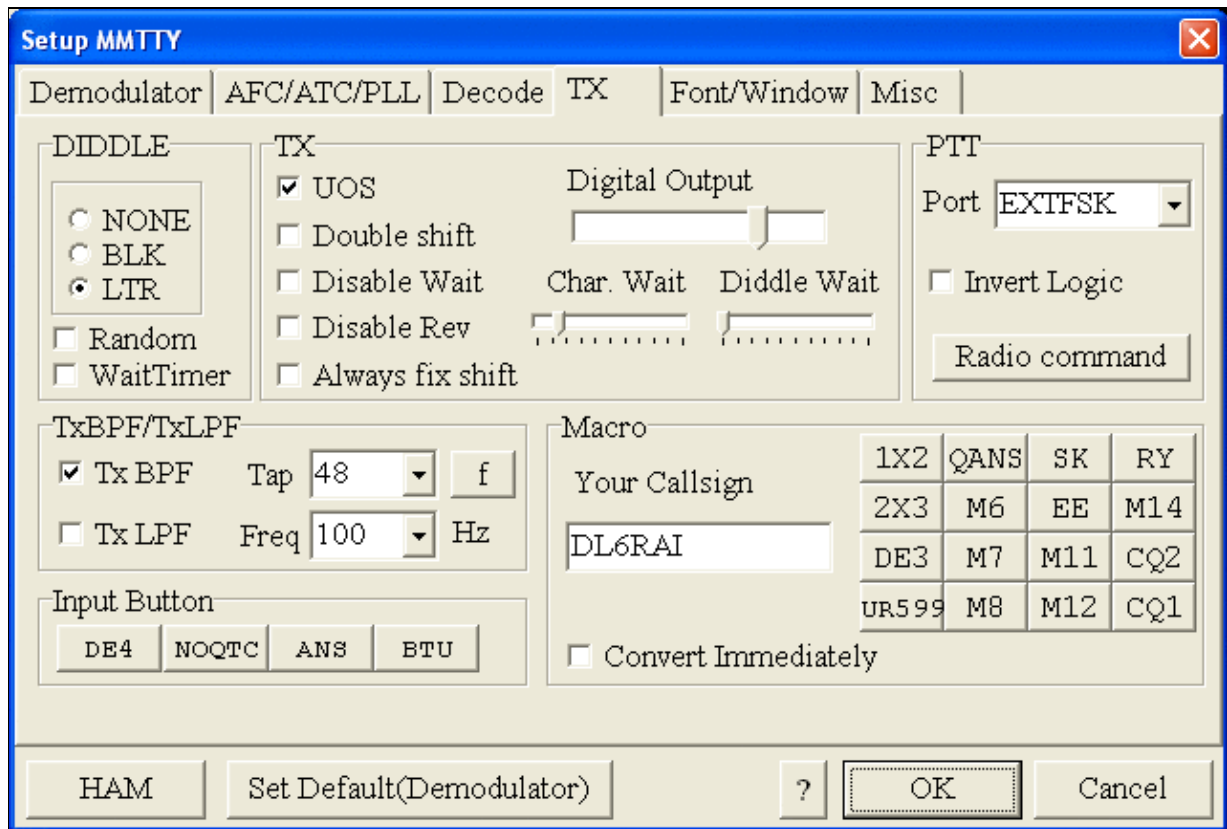

No higher resolution available.

MmttyTxSetup.gif (638 × 431 pixels, file size: 25 KB, MIME type: image.gif)

## File history

Click on a date/time to view the file as it appeared at that time.

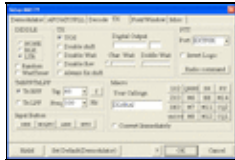
	Date/Time	Thumbnail	Dimensions	User	Comment
current	<u>09:20, 4 January 2007</u>		638 × 431 (25 KB)	<u>D16rai</u> ( <a href="#">talk</a>   <a href="#">contribs</a> )	

You cannot overwrite this file.

## File usage

The following page uses this file:

- [BestPractice1](#)

## Namespaces

- [File](#)
- [Discussion](#)

## Variants

## Views

- [Read](#)
- [View source](#)
- [View history](#)

## More

- This page was last edited on 4 January 2007, at 09:20.

- [Privacy policy](#)
- [About Win-Test Wiki](#)
- [Disclaimers](#)



# File:MMTTY-USB-Port-Option.gif

From Win-Test Wiki

[Jump to navigation](#) [Jump to search](#)

- [File](#)
- [File history](#)
- [File usage](#)

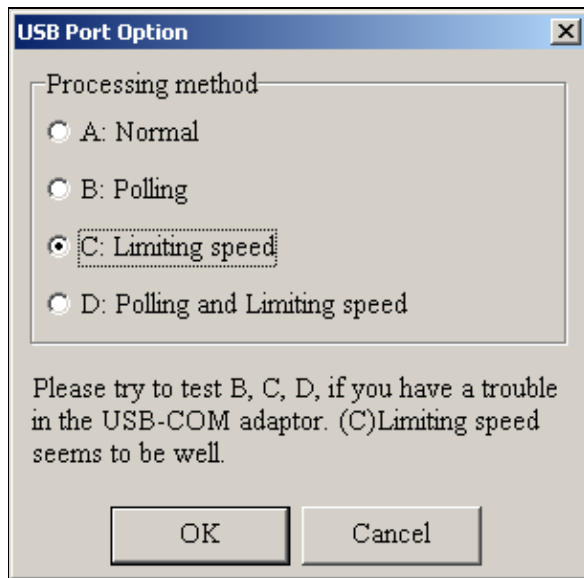

No higher resolution available.

[MMTTY-USB-Port-Option.gif](#) (304 × 299 pixels, file size: 7 KB, MIME type: image/gif)

## File history

Click on a date/time to view the file as it appeared at that time.

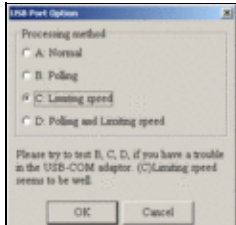
	Date/Time	Thumbnail	Dimensions	User	Comment
current	<a href="#">22:36, 13 November 2007</a>		304 × 299 (7 KB)	<a href="#">DL4NER</a> ( <a href="#">talk</a>   <a href="#">contribs</a> )	

You cannot overwrite this file.

## File usage

The following 6 pages use this file:

- [BestPractice10](#)
- [BestPractice4](#)

- [BestPractice5](#)
- [BestPractice6](#)
- [BestPractice8](#)
- [RTTY](#)

## Namespaces

- [File](#)
- [Discussion](#)

## Variants

## Views

- [Read](#)
- [View source](#)
- [View history](#)

## More

- This page was last edited on 13 November 2007, at 22:36.

- [Privacy policy](#)
- [About Win-Test Wiki](#)
- [Disclaimers](#)





# File:MMTTY-USB-Port-Option.gif

From Win-Test Wiki

[Jump to navigation](#) [Jump to search](#)

- [File](#)
- [File history](#)
- [File usage](#)

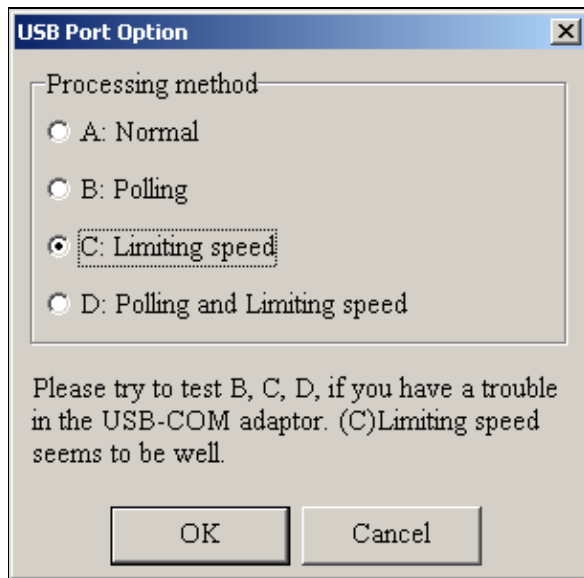

No higher resolution available.

[MMTTY-USB-Port-Option.gif](#) (304 × 299 pixels, file size: 7 KB, MIME type: image/gif)

## File history

Click on a date/time to view the file as it appeared at that time.

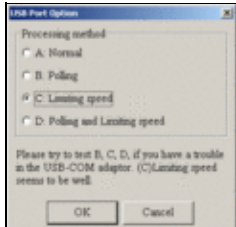
	Date/Time	Thumbnail	Dimensions	User	Comment
current	<a href="#">22:36, 13 November 2007</a>		304 × 299 (7 KB)	<a href="#">DL4NER</a> ( <a href="#">talk</a>   <a href="#">contribs</a> )	

You cannot overwrite this file.

## File usage

The following 6 pages use this file:

- [BestPractice10](#)
- [BestPractice4](#)

- [BestPractice5](#)
- [BestPractice6](#)
- [BestPractice8](#)
- [RTTY](#)

## Namespaces

- [File](#)
- [Discussion](#)

## Variants

## Views

- [Read](#)
- [View source](#)
- [View history](#)

## More

- This page was last edited on 13 November 2007, at 22:36.

- [Privacy policy](#)
- [About Win-Test Wiki](#)
- [Disclaimers](#)



# File:MmttyXyScope.gif

From Win-Test Wiki

[Jump to navigation](#) [Jump to search](#)

- [File](#)
- [File history](#)
- [File usage](#)
- [Metadata](#)

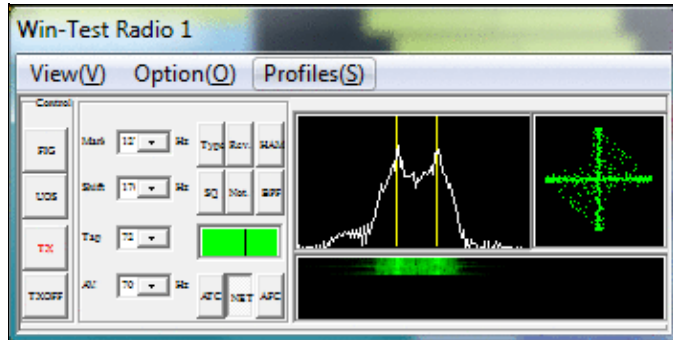

No higher resolution available.

[MmttyXyScope.gif](#) (350 × 176 pixels, file size: 27 KB, MIME type: image.gif)

## File history

Click on a date/time to view the file as it appeared at that time.

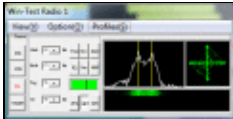
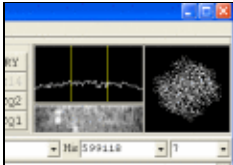
	Date/Time	Thumbnail	Dimensions	User	Comment
current	<a href="#">18:09, 8 February 2020</a>		350 × 176 (27 KB)	<a href="#">D16rai (talk   contribs)</a>	
	<a href="#">09:31, 4 January 2007</a>		309 × 221 (14 KB)	<a href="#">D16rai (talk   contribs)</a>	

You cannot overwrite this file.

## File usage

The following 7 pages use this file:

- [BestPractice1](#)
- [BestPractice10](#)
- [BestPractice4](#)
- [BestPractice5](#)
- [BestPractice6](#)

- [BestPractice7](#)
- [BestPractice8](#)

## Metadata

This file contains additional information, probably added from the digital camera or scanner used to create or digitize it.

If the file has been modified from its original state, some details may not fully reflect the modified file.

**Horizontal resolution** 37.79 dpc

**Vertical resolution** 37.79 dpc

## Namespaces

- [File](#)
- [Discussion](#)

## Variants

## Views

- [Read](#)
- [View source](#)
- [View history](#)

## More

- This page was last edited on 8 February 2020, at 18:09.

- [Privacy policy](#)
- [About Win-Test Wiki](#)
- [Disclaimers](#)

-  The logo consists of a yellow sun icon on the left, followed by the text "Powered By" in a small font, and "MediaWiki" in a larger font below it, all enclosed in a thin black border.

# File:MmttyXyScope.gif

From Win-Test Wiki

[Jump to navigation](#) [Jump to search](#)

- [File](#)
- [File history](#)
- [File usage](#)
- [Metadata](#)

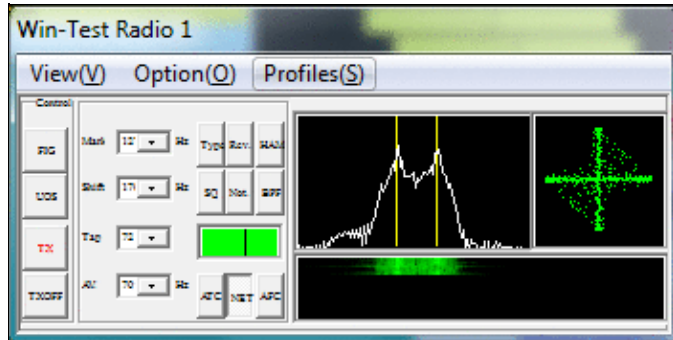

No higher resolution available.

[MmttyXyScope.gif](#) (350 × 176 pixels, file size: 27 KB, MIME type: image.gif)

## File history

Click on a date/time to view the file as it appeared at that time.

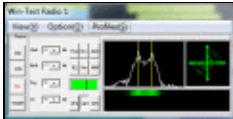
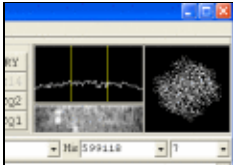
	Date/Time	Thumbnail	Dimensions	User	Comment
current	<a href="#">18:09, 8 February 2020</a>		350 × 176 (27 KB)	<a href="#">D16rai (talk   contribs)</a>	
	<a href="#">09:31, 4 January 2007</a>		309 × 221 (14 KB)	<a href="#">D16rai (talk   contribs)</a>	

You cannot overwrite this file.

## File usage

The following 7 pages use this file:

- [BestPractice1](#)
- [BestPractice10](#)
- [BestPractice4](#)
- [BestPractice5](#)
- [BestPractice6](#)

- [BestPractice7](#)
- [BestPractice8](#)

## Metadata

This file contains additional information, probably added from the digital camera or scanner used to create or digitize it.

If the file has been modified from its original state, some details may not fully reflect the modified file.

**Horizontal resolution** 37.79 dpc

**Vertical resolution** 37.79 dpc

## Namespaces

- [File](#)
- [Discussion](#)

## Variants

## Views

- [Read](#)
- [View source](#)
- [View history](#)

## More

- This page was last edited on 8 February 2020, at 18:09.

- [Privacy policy](#)
- [About Win-Test Wiki](#)
- [Disclaimers](#)

-  The logo consists of a blue square with a white sun-like icon on the left and the text "Powered By MediaWiki" in blue on the right.

# File:MmttyXyScopeOnly.gif

From Win-Test Wiki

[Jump to navigation](#) [Jump to search](#)

- [File](#)
- [File history](#)
- [File usage](#)

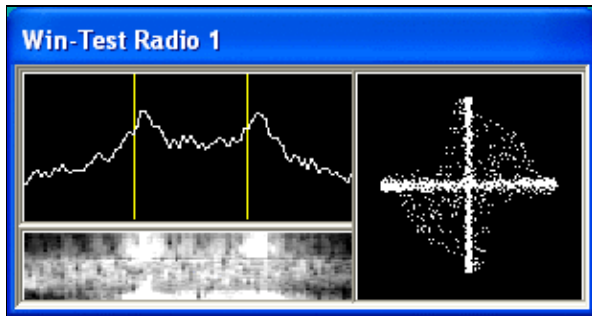

No higher resolution available.

[MmttyXyScopeOnly.gif](#) (308 × 162 pixels, file size: 11 KB, MIME type: image.gif)

## File history

Click on a date/time to view the file as it appeared at that time.

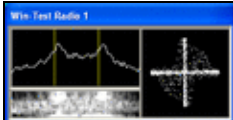
	Date/Time	Thumbnail	Dimensions	User	Comment
current	<a href="#">09:17, 21 January 2007</a>		308 × 162 (11 KB)	<a href="#">D16rai</a> ( <a href="#">talk</a>   <a href="#">contribs</a> )	

You cannot overwrite this file.

## File usage

The following page uses this file:

- [RTTY](#)

## Namespaces

- [File](#)
- [Discussion](#)

## Variants

## Views

- [Read](#)
- [View source](#)
- [View history](#)

## More

- This page was last edited on 21 January 2007, at 09:17.

- [Privacy policy](#)
- [About Win-Test Wiki](#)
- [Disclaimers](#)





# File:MmttyXyScopeOnly.gif

From Win-Test Wiki

[Jump to navigation](#) [Jump to search](#)

- [File](#)
- [File history](#)
- [File usage](#)

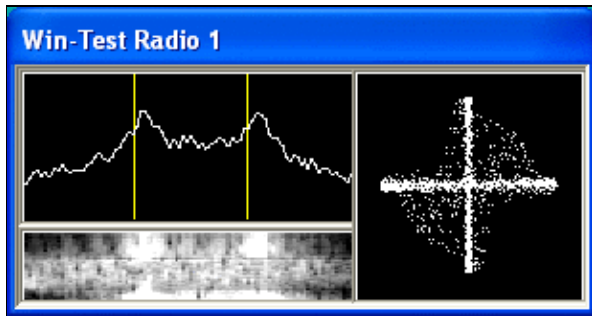

No higher resolution available.

[MmttyXyScopeOnly.gif](#) (308 × 162 pixels, file size: 11 KB, MIME type: image.gif)

## File history

Click on a date/time to view the file as it appeared at that time.

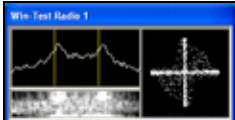
	Date/Time	Thumbnail	Dimensions	User	Comment
current	<a href="#">09:17, 21 January 2007</a>		308 × 162 (11 KB)	<a href="#">Dl6rai</a> ( <a href="#">talk</a>   <a href="#">contribs</a> )	

You cannot overwrite this file.

## File usage

The following page uses this file:

- [RTTY](#)

## Namespaces

- [File](#)
- [Discussion](#)

## Variants

## Views

- [Read](#)
- [View source](#)
- [View history](#)

## More

- This page was last edited on 21 January 2007, at 09:17.

- [Privacy policy](#)
- [About Win-Test Wiki](#)
- [Disclaimers](#)



# File:NA Sprint Messages.PNG

From Win-Test Wiki

[Jump to navigation](#) [Jump to search](#)

- [File](#)
- [File history](#)
- [File usage](#)
- [Metadata](#)

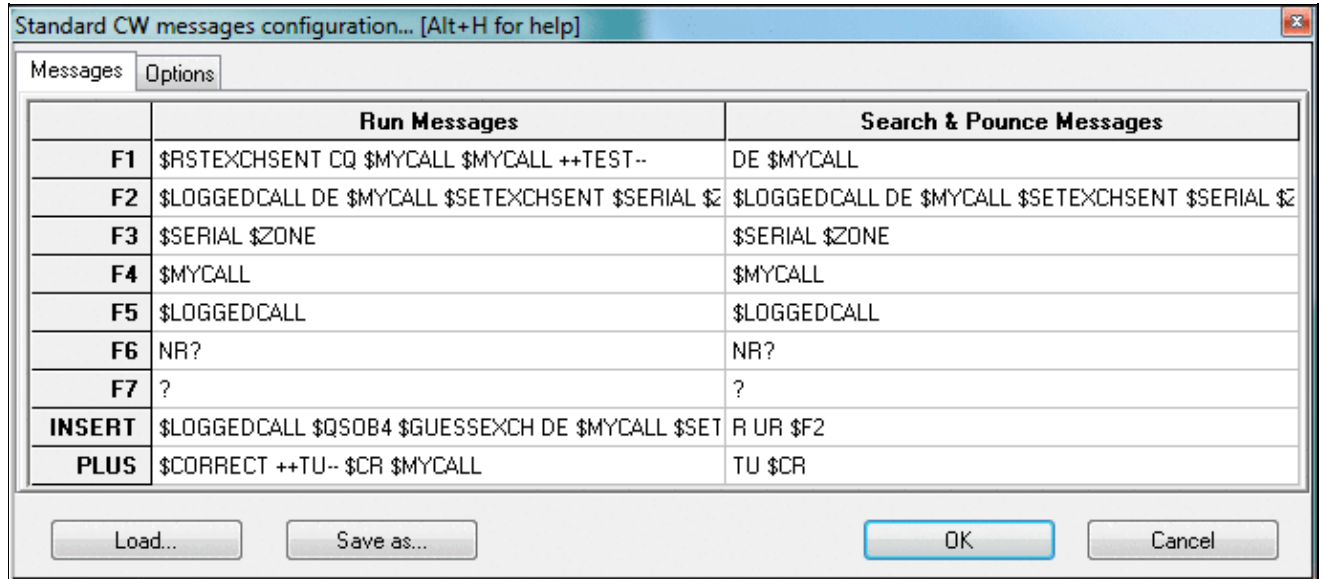

No higher resolution available.

[NA Sprint Messages.PNG](#) (684 × 302 pixels, file size: 23 KB, MIME type: image.gif)

Sample message setting for the NA Sprint

## File history

Click on a date/time to view the file as it appeared at that time.

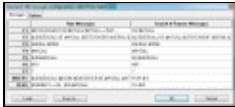
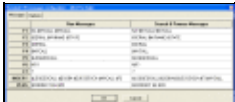
	Date/Time	Thumbnail	Dimensions	User	Comment
current	<a href="#">18:04, 17 December 2016</a>		684 × 302 (23 KB)	<a href="#">Dl6rai</a> ( <a href="#">talk</a>   <a href="#">contribs</a> )	
	<a href="#">22:14, 8 June 2008</a>		684 × 300 (14 KB)	<a href="#">N6TV</a> ( <a href="#">talk</a>   <a href="#">contribs</a> )	Sample message setting for the NA Sprint

You cannot overwrite this file.

## File usage

The following page uses this file:

- [Menu:Options](#)

## Metadata

This file contains additional information, probably added from the digital camera or scanner used to create or digitize it.

If the file has been modified from its original state, some details may not fully reflect the modified file.

**Horizontal resolution** 37.79 dpc

**Vertical resolution** 37.79 dpc

## Namespaces

- [File](#)
- [Discussion](#)

## Variants

## Views

- [Read](#)
- [View source](#)
- [View history](#)

## More

- This page was last edited on 17 December 2016, at 18:04.

- [Privacy policy](#)
- [About Win-Test Wiki](#)
- [Disclaimers](#)



# File:NA Sprint Messages.PNG

From Win-Test Wiki

[Jump to navigation](#) [Jump to search](#)

- [File](#)
- [File history](#)
- [File usage](#)
- [Metadata](#)

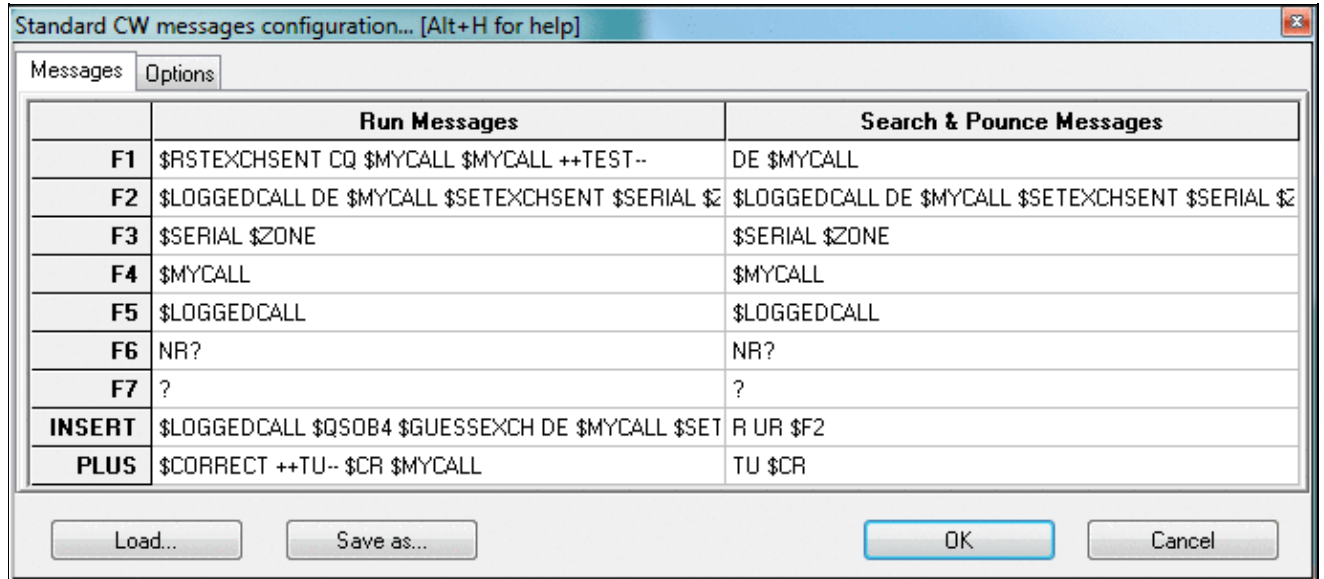

No higher resolution available.

[NA Sprint Messages.PNG](#) (684 × 302 pixels, file size: 23 KB, MIME type: image/gif)

Sample message setting for the NA Sprint

## File history

Click on a date/time to view the file as it appeared at that time.

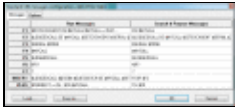
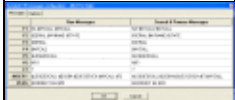
	Date/Time	Thumbnail	Dimensions	User	Comment
current	<a href="#">18:04, 17 December 2016</a>		684 × 302 (23 KB)	<a href="#">Dl6rai</a> ( <a href="#">talk</a>   <a href="#">contribs</a> )	
	<a href="#">22:14, 8 June 2008</a>		684 × 300 (14 KB)	<a href="#">N6TV</a> ( <a href="#">talk</a>   <a href="#">contribs</a> )	Sample message setting for the NA Sprint

You cannot overwrite this file.

## File usage

The following page uses this file:

- [Menu:Options](#)

## Metadata

This file contains additional information, probably added from the digital camera or scanner used to create or digitize it.

If the file has been modified from its original state, some details may not fully reflect the modified file.

**Horizontal resolution** 37.79 dpc

**Vertical resolution** 37.79 dpc

## Namespaces

- [File](#)
- [Discussion](#)

## Variants

## Views

- [Read](#)
- [View source](#)
- [View history](#)

## More

- This page was last edited on 17 December 2016, at 18:04.

- [Privacy policy](#)
- [About Win-Test Wiki](#)
- [Disclaimers](#)



# File:Networking multiop.gif

From Win-Test Wiki

[Jump to navigation](#) [Jump to search](#)

- [File](#)
- [File history](#)
- [File usage](#)

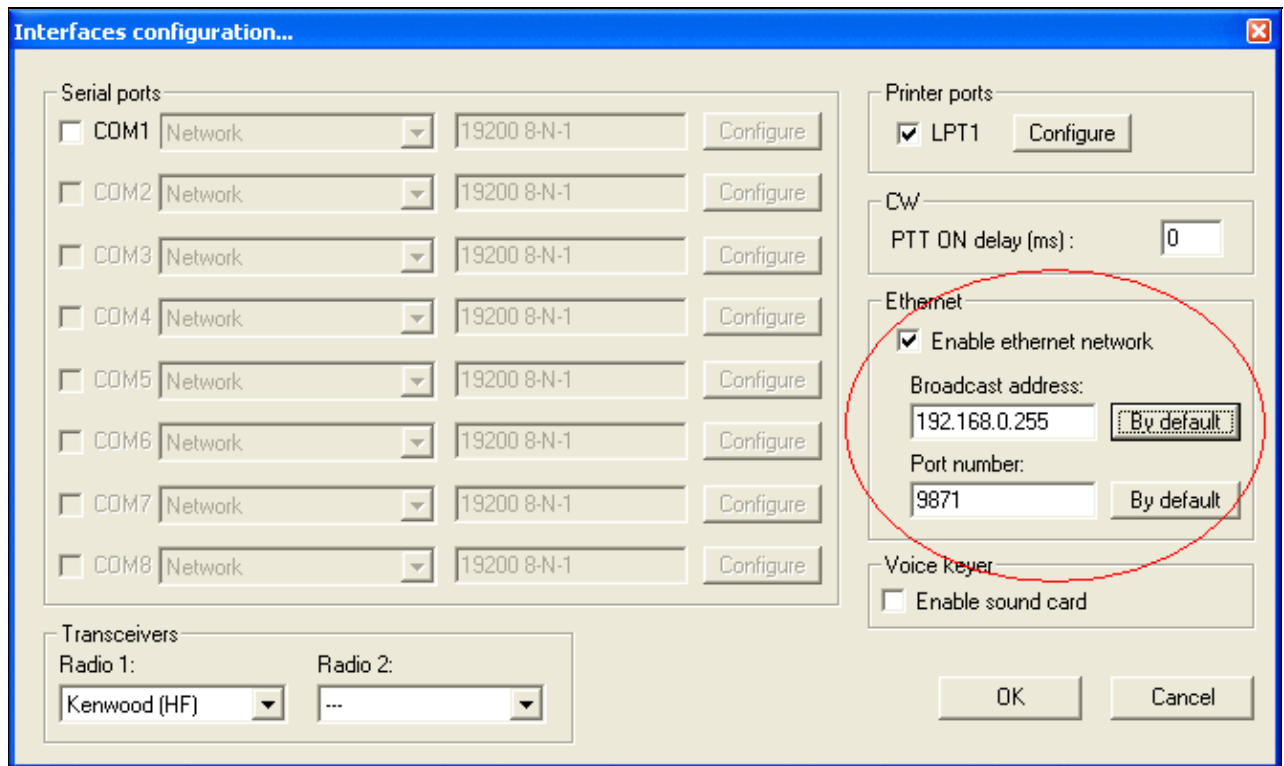

No higher resolution available.

[Networking\\_multiop.gif](#) (665 × 398 pixels, file size: 23 KB, MIME type: image.gif)

Networking configuration screenshot (multi-op scenario)

## File history

Click on a date/time to view the file as it appeared at that time.

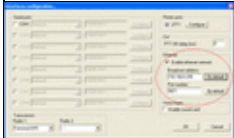
	Date/Time	Thumbnail	Dimensions	User	Comment
current	<a href="#">14:14, 5 January 2006</a>		665 × 398 (23 KB)	<a href="#">MOCLW (talk   contribs)</a>	Networking configuration screenshot (multi-op scenario)

You cannot overwrite this file.

## File usage

The following 3 pages use this file:

- [DX Cluster/Telnet](#)
- [Networking](#)
- [Rotators](#)

## Namespaces

- [File](#)
- [Discussion](#)

## Variants

## Views

- [Read](#)
- [View source](#)
- [View history](#)

## More

- This page was last edited on 5 January 2006, at 14:14.

- [Privacy policy](#)
- [About Win-Test Wiki](#)
- [Disclaimers](#)





# File:Networking multiop.gif

From Win-Test Wiki

[Jump to navigation](#) [Jump to search](#)

- [File](#)
- [File history](#)
- [File usage](#)

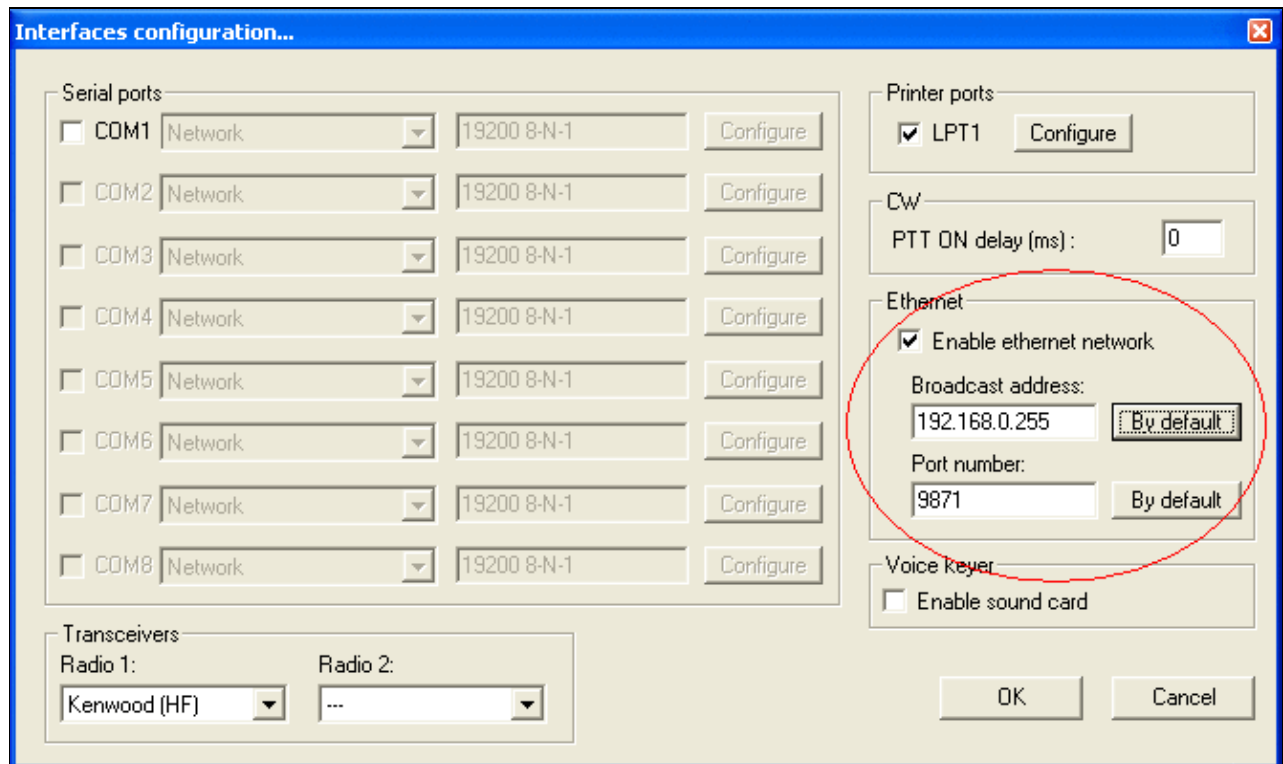

No higher resolution available.

[Networking\\_multiop.gif](#) (665 × 398 pixels, file size: 23 KB, MIME type: image.gif)

Networking configuration screenshot (multi-op scenario)

## File history

Click on a date/time to view the file as it appeared at that time.

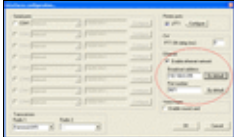
	Date/Time	Thumbnail	Dimensions	User	Comment
current	<a href="#">14:14, 5 January 2006</a>		665 × 398 (23 KB)	<a href="#">MOCLW</a> ( <a href="#">talk</a>   <a href="#">contribs</a> )	Networking configuration screenshot (multi-op scenario)

You cannot overwrite this file.

## File usage

The following 3 pages use this file:

- [DX Cluster/Telnet](#)
- [Networking](#)
- [Rotators](#)

## Namespaces

- [File](#)
- [Discussion](#)

## Variants

## Views

- [Read](#)
- [View source](#)
- [View history](#)

## More

- This page was last edited on 5 January 2006, at 14:14.

- [Privacy policy](#)
- [About Win-Test Wiki](#)
- [Disclaimers](#)



# File:NetworkProtocolAdvancedSettings.gif

From Win-Test Wiki

[Jump to navigation](#) [Jump to search](#)

- [File](#)
- [File history](#)
- [File usage](#)
- [Metadata](#)

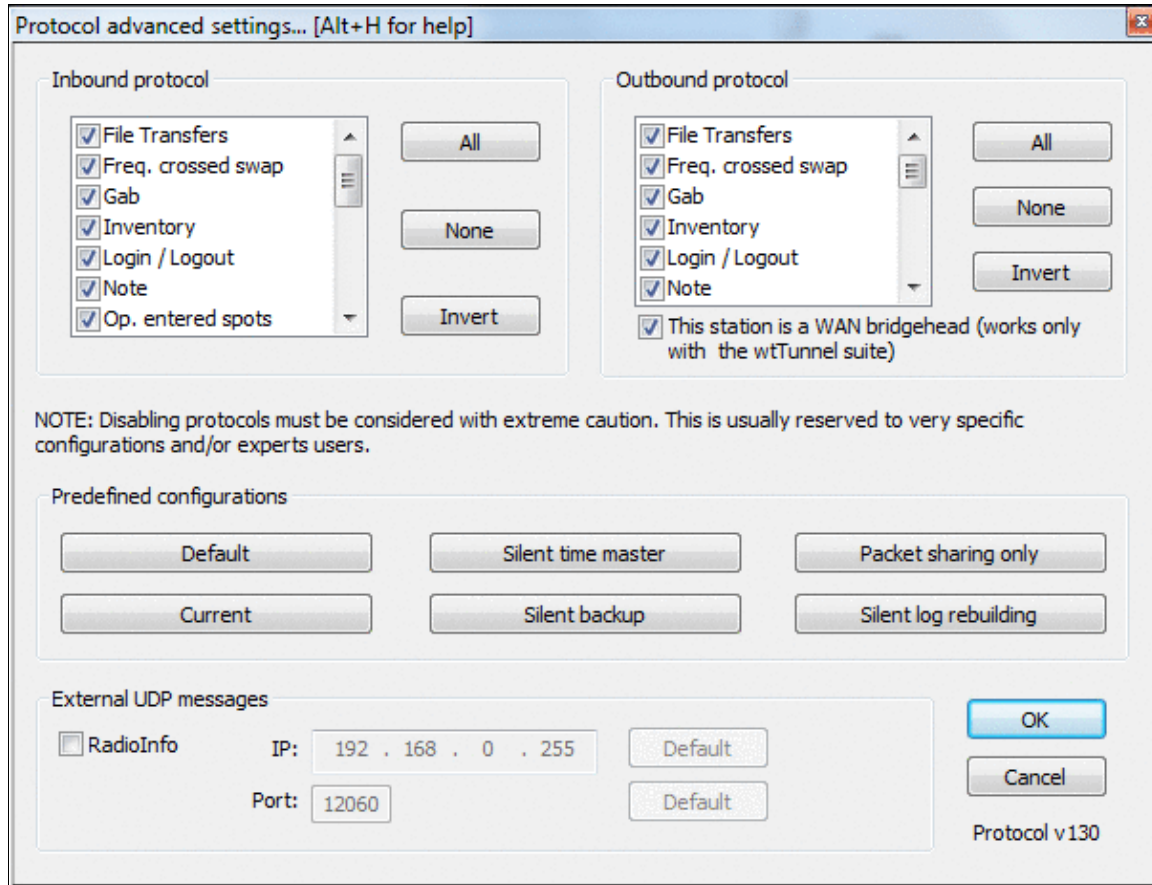





No higher resolution available.

[NetworkProtocolAdvancedSettings.gif](#) (603 × 463 pixels, file size: 34 KB, MIME type: image.gif)

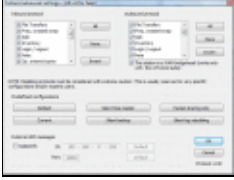
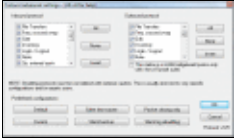
## File history

Click on a date/time to view the file as it appeared at that time.

	Date/Time	Thumbnail	Dimensions	User	Comment
current	<a href="#">06:20, 10 April 2023</a>		603 × 463 (34 KB)	<a href="#">Dl6rai (talk   contribs)</a>	
	<a href="#">16:44, 17 December 2016</a>		603 × 359 (27 KB)	<a href="#">Dl6rai (talk   contribs)</a>	
	<a href="#">05:50, 3 July 2009</a>		603 × 365 (21 KB)	<a href="#">N6TV (talk   contribs)</a>	Updated to match Win-Test version 3.26 dialog
	<a href="#">21:32, 9 July 2007</a>		603 × 358 (15 KB)	<a href="#">Dl6rai (talk   contribs)</a>	
	<a href="#">22:50, 15 September 2006</a>		561 × 334 (12 KB)	<a href="#">Dl6rai (talk   contribs)</a>	

You cannot overwrite this file.

## File usage

The following page uses this file:

- [Menu:Options](#)

## Metadata

This file contains additional information, probably added from the digital camera or scanner used to create or digitize it.

If the file has been modified from its original state, some details may not fully reflect the modified file.

**Horizontal resolution** 37.79 dpc

**Vertical resolution** 37.79 dpc

## Namespaces

- [File](#)
- [Discussion](#)

## Variants

## Views

- [Read](#)
- [View source](#)
- [View history](#)

## More

- This page was last edited on 10 April 2023, at 06:20.

- [Privacy policy](#)
- [About Win-Test Wiki](#)
- [Disclaimers](#)

- The logo for MediaWiki, featuring a sun icon and the text "Powered By MediaWiki".

# File:NetworkProtocolAdvancedSettings.gif

From Win-Test Wiki

[Jump to navigation](#) [Jump to search](#)

- [File](#)
- [File history](#)
- [File usage](#)
- [Metadata](#)

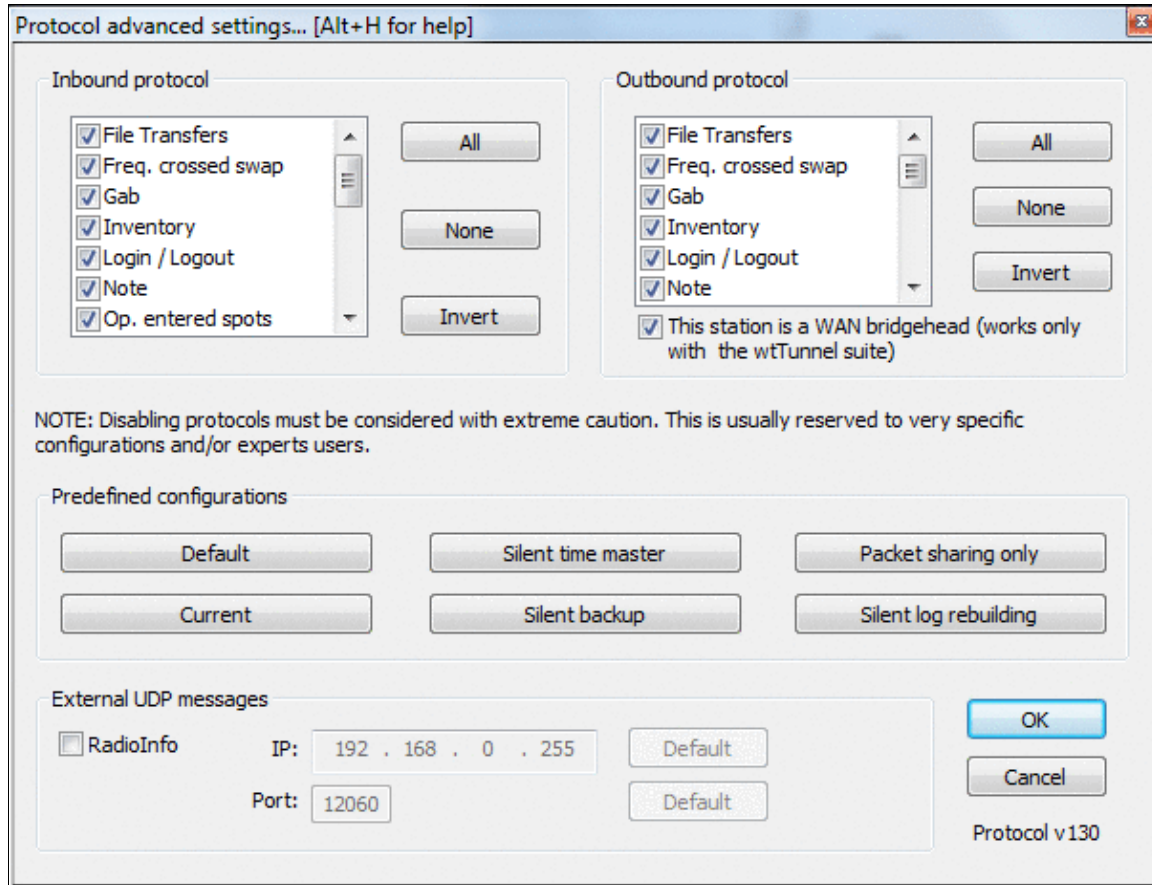





No higher resolution available.

[NetworkProtocolAdvancedSettings.gif](#) (603 × 463 pixels, file size: 34 KB, MIME type: image.gif)

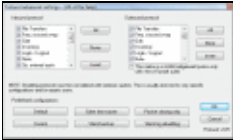
## File history

Click on a date/time to view the file as it appeared at that time.

	Date/Time	Thumbnail	Dimensions	User	Comment
current	<a href="#">06:20, 10 April 2023</a>		603 × 463 (34 KB)	<a href="#">Dl6rai (talk   contribs)</a>	
	<a href="#">16:44, 17 December 2016</a>		603 × 359 (27 KB)	<a href="#">Dl6rai (talk   contribs)</a>	
	<a href="#">05:50, 3 July 2009</a>		603 × 365 (21 KB)	<a href="#">N6TV (talk   contribs)</a>	Updated to match Win-Test version 3.26 dialog
	<a href="#">21:32, 9 July 2007</a>		603 × 358 (15 KB)	<a href="#">Dl6rai (talk   contribs)</a>	
	<a href="#">22:50, 15 September 2006</a>		561 × 334 (12 KB)	<a href="#">Dl6rai (talk   contribs)</a>	

You cannot overwrite this file.

## File usage

The following page uses this file:

- [Menu:Options](#)

## Metadata

This file contains additional information, probably added from the digital camera or scanner used to create or digitize it.

If the file has been modified from its original state, some details may not fully reflect the modified file.

**Horizontal resolution** 37.79 dpc

**Vertical resolution** 37.79 dpc

## Namespaces

- [File](#)
- [Discussion](#)

## Variants

## Views

- [Read](#)
- [View source](#)
- [View history](#)

## More

- This page was last edited on 10 April 2023, at 06:20.

- [Privacy policy](#)
- [About Win-Test Wiki](#)
- [Disclaimers](#)

- The logo for MediaWiki, featuring a sun icon and the text "Powered By MediaWiki".



# File:Network singleop.gif

From Win-Test Wiki

[Jump to navigation](#) [Jump to search](#)

- [File](#)
- [File history](#)
- [File usage](#)

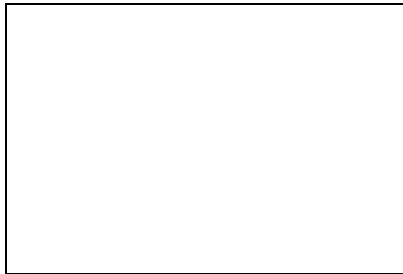

No higher resolution available.

[Network\\_singleop.gif](#) (208 × 140 pixels, file size: 3 KB, MIME type: image.gif)

## File history

Click on a date/time to view the file as it appeared at that time.

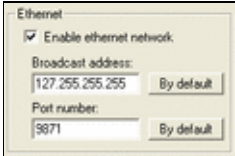
	Date/Time	Thumbnail	Dimensions	User	Comment
current	<a href="#">14:18, 5 January 2006</a>		208 × 140 (3 KB)	<a href="#">M0CLW</a> ( <a href="#">talk</a>   <a href="#">contribs</a> )	Networking configuration (wtDxTelnet + Win-Test + single-op)

You cannot overwrite this file.

## File usage

The following file is a duplicate of this file ([more details](#)):

- [File:network singleop.gif](#)

There are no pages that use this file.

## Namespaces

- [File](#)
- [Discussion](#)

## Variants

## Views

- [Read](#)

## More

- [Privacy policy](#)
- [About Win-Test Wiki](#)
- [Disclaimers](#)



# File:Network singleop.gif

From Win-Test Wiki

[Jump to navigation](#) [Jump to search](#)

- [File](#)
- [File history](#)
- [File usage](#)

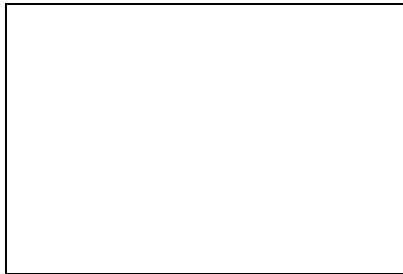

No higher resolution available.

[Network\\_singleop.gif](#) (208 × 140 pixels, file size: 3 KB, MIME type: image.gif)

## File history

Click on a date/time to view the file as it appeared at that time.

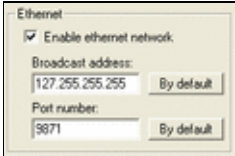
	Date/Time	Thumbnail	Dimensions	User	Comment
current	<a href="#">14:18, 5 January 2006</a>		208 × 140 (3 KB)	<a href="#">M0CLW</a> ( <a href="#">talk</a>   <a href="#">contribs</a> )	Networking configuration (wtDxTelnet + Win-Test + single-op)

You cannot overwrite this file.

## File usage

The following file is a duplicate of this file ([more details](#)):

- [File:network singleop.gif](#)

There are no pages that use this file.

## Namespaces

- [File](#)
- [Discussion](#)

## Variants

## Views

- [Read](#)

## More

- [Privacy policy](#)
- [About Win-Test Wiki](#)
- [Disclaimers](#)



# File:network singleop.gif

From Win-Test Wiki

[Jump to navigation](#) [Jump to search](#)

- [File](#)
- [File history](#)
- [File usage](#)

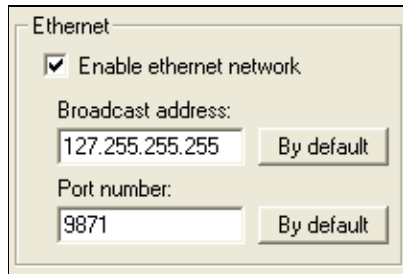

No higher resolution available.

[network\\_singleop.gif](#) (208 × 140 pixels, file size: 3 KB, MIME type: image.gif)

## File history

Click on a date/time to view the file as it appeared at that time.

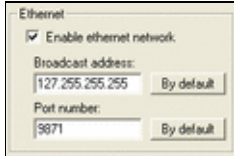
	Date/Time	Thumbnail	Dimensions	User	Comment
current	<a href="#">09:52, 17 January 2006</a>		208 × 140 (3 KB)	<a href="#">M0CLW</a> ( <a href="#">talk</a>   <a href="#">contribs</a> )	

You cannot overwrite this file.

## File usage

The following file is a duplicate of this file ([more details](#)):

- [File:Network singleop.gif](#)

The following 2 pages use this file:

- [DX Cluster/Telnet](#)
- [Rotators](#)

## Namespaces

- [File](#)
- [Discussion](#)

## Variants

## Views

- [Read](#)
- [View source](#)
- [View history](#)

## More

- This page was last edited on 17 January 2006, at 09:52.

- [Privacy policy](#)
- [About Win-Test Wiki](#)
- [Disclaimers](#)



# File:network singleop.gif

From Win-Test Wiki

[Jump to navigation](#) [Jump to search](#)

- [File](#)
- [File history](#)
- [File usage](#)

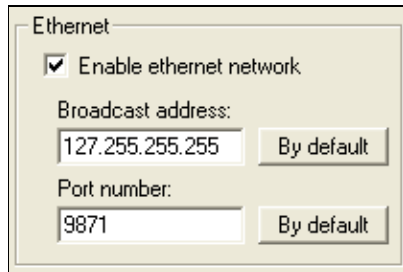

No higher resolution available.

[network\\_singleop.gif](#) (208 × 140 pixels, file size: 3 KB, MIME type: image.gif)

## File history

Click on a date/time to view the file as it appeared at that time.

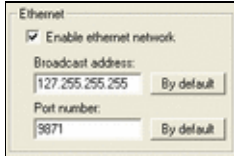
	Date/Time	Thumbnail	Dimensions	User	Comment
current	<a href="#">09:52, 17 January 2006</a>		208 × 140 (3 KB)	<a href="#">M0CLW</a> ( <a href="#">talk</a>   <a href="#">contribs</a> )	

You cannot overwrite this file.

## File usage

The following file is a duplicate of this file ([more details](#)):

- [File:Network singleop.gif](#)

The following 2 pages use this file:

- [DX Cluster/Telnet](#)
- [Rotators](#)

## Namespaces

- [File](#)
- [Discussion](#)

## Variants

## Views

- [Read](#)
- [View source](#)
- [View history](#)

## More

- This page was last edited on 17 January 2006, at 09:52.

- [Privacy policy](#)
- [About Win-Test Wiki](#)
- [Disclaimers](#)





# File:NewContestFileProperties.gif

From Win-Test Wiki

[Jump to navigation](#) [Jump to search](#)

- [File](#)
- [File history](#)
- [File usage](#)

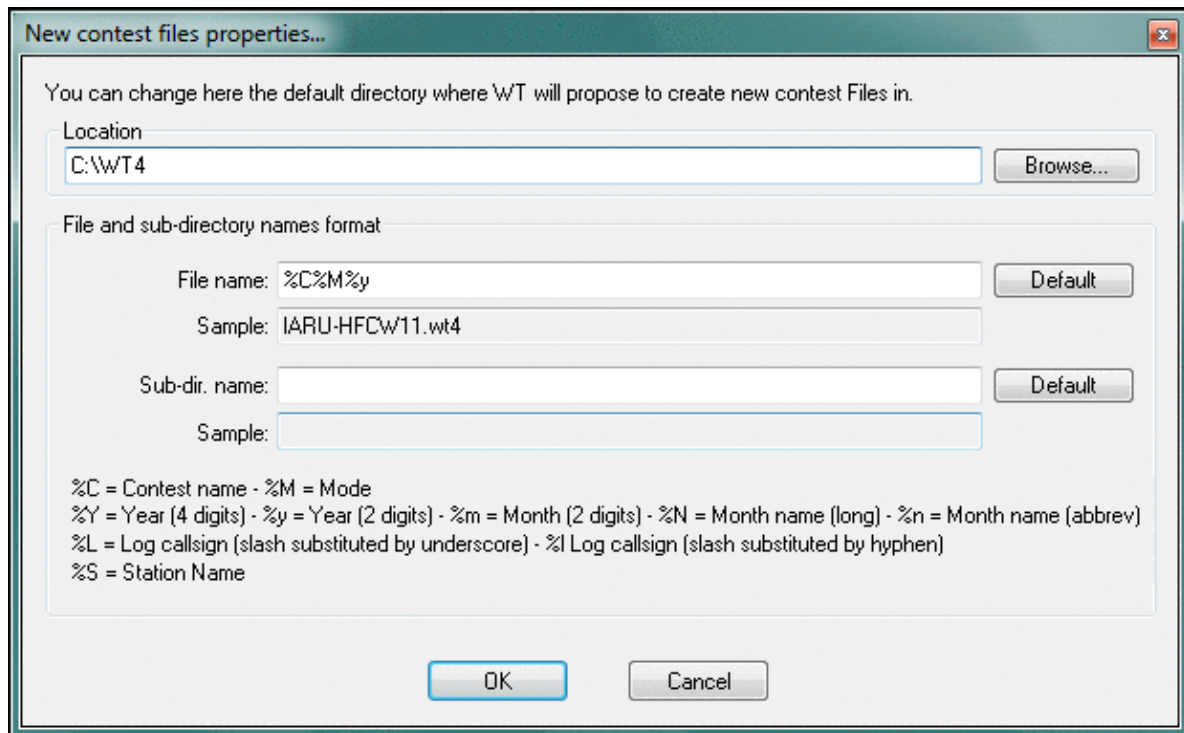



No higher resolution available.

[NewContestFileProperties.gif](#) (618 × 382 pixels, file size: 26 KB, MIME type: image.gif)

Changing the new contest file properties and default location for new files.

## File history

Click on a date/time to view the file as it appeared at that time.

	Date/Time	Thumbnail	Dimensions	User	Comment
current	<a href="#">23:19, 16 October 2011</a>		618 × 382 (26 KB)	<a href="#">N6TV (talk   contribs)</a>	Same as prior version, with distracting cursor removed.
	<a href="#">23:18, 16 October 2011</a>		618 × 382 (28 KB)	<a href="#">N6TV (talk   contribs)</a>	Updated to show IARU Contest name for consistency with prior dialog.
	<a href="#">22:56, 16 October 2011</a>		618 × 382 (28 KB)	<a href="#">N6TV (talk   contribs)</a>	Changing the new contest file properties and default location for new files.

You cannot overwrite this file.

## File usage

The following page uses this file:

- [Menu:File new](#)

## Namespaces

- [File](#)
- [Discussion](#)

## Variants

## Views

- [Read](#)
- [View source](#)
- [View history](#)

## More

- This page was last edited on 16 October 2011, at 23:19.

- [Privacy policy](#)
- [About Win-Test Wiki](#)
- [Disclaimers](#)



# File:NewContestFileProperties.gif

From Win-Test Wiki

[Jump to navigation](#) [Jump to search](#)

- [File](#)
- [File history](#)
- [File usage](#)

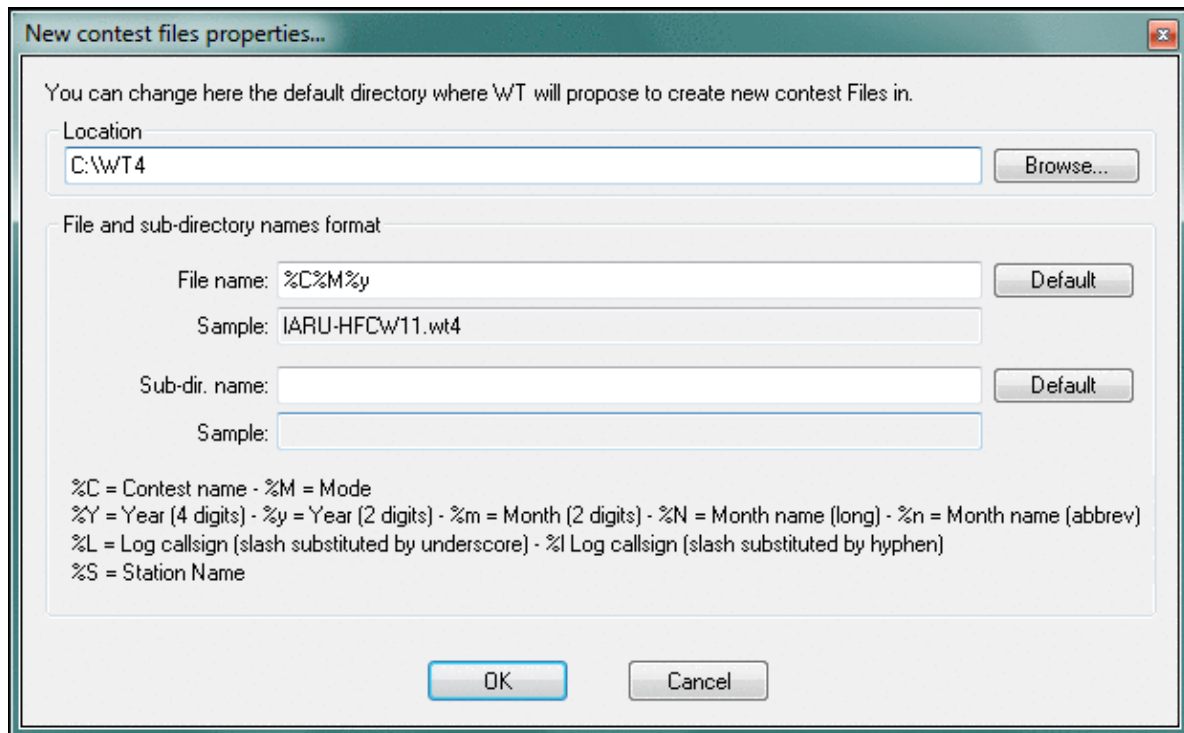



No higher resolution available.

[NewContestFileProperties.gif](#) (618 × 382 pixels, file size: 26 KB, MIME type: image.gif)

Changing the new contest file properties and default location for new files.

## File history

Click on a date/time to view the file as it appeared at that time.

	Date/Time	Thumbnail	Dimensions	User	Comment
current	<a href="#">23:19, 16 October 2011</a>		618 × 382 (26 KB)	<a href="#">N6TV</a> ( <a href="#">talk</a>   <a href="#">contribs</a> )	Same as prior version, with distracting cursor removed.
	<a href="#">23:18, 16 October 2011</a>		618 × 382 (28 KB)	<a href="#">N6TV</a> ( <a href="#">talk</a>   <a href="#">contribs</a> )	Updated to show IARU Contest name for consistency with prior dialog.
	<a href="#">22:56, 16 October 2011</a>		618 × 382 (28 KB)	<a href="#">N6TV</a> ( <a href="#">talk</a>   <a href="#">contribs</a> )	Changing the new contest file properties and default location for new files.

You cannot overwrite this file.

## File usage

The following page uses this file:

- [Menu:File new](#)

## Namespaces

- [File](#)
- [Discussion](#)

## Variants

## Views

- [Read](#)
- [View source](#)
- [View history](#)

## More

- This page was last edited on 16 October 2011, at 23:19.

## Win-Test Wiki

- [Privacy policy](#)
- [About Win-Test Wiki](#)
- [Disclaimers](#)



# File:OperatorLogin1.PNG

From Win-Test Wiki

[Jump to navigation](#) [Jump to search](#)

- [File](#)
- [File history](#)
- [File usage](#)

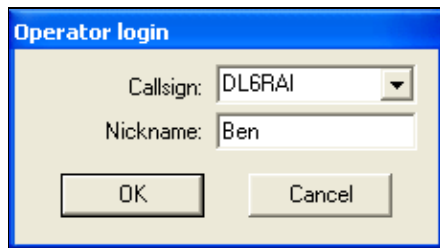

No higher resolution available.

[OperatorLogin1.PNG](#) (227 × 126 pixels, file size: 4 KB, MIME type: image/gif)

## File history

Click on a date/time to view the file as it appeared at that time.

Date/Time	Thumbnail	Dimensions	User	Comment
current <a href="#">06:35, 19 January 2008</a>		227 × 126 (4 KB)	<a href="#">Dl6rai</a> ( <a href="#">talk</a>   <a href="#">contribs</a> )	

You cannot overwrite this file.

## File usage

The following page uses this file:

- [Menu:Commands](#)

## Namespaces

- [File](#)
- [Discussion](#)

## Variants

## Views

- [Read](#)
- [View source](#)

- [View history](#)

## More

- This page was last edited on 19 January 2008, at 06:35.

- [Privacy policy](#)
- [About Win-Test Wiki](#)
- [Disclaimers](#)





# File:OperatorLogin1.PNG

From Win-Test Wiki

[Jump to navigation](#) [Jump to search](#)

- [File](#)
- [File history](#)
- [File usage](#)

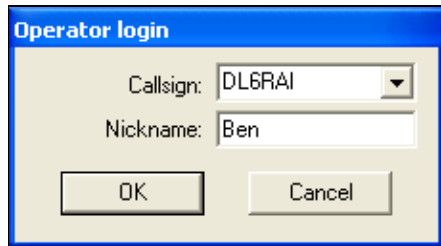

No higher resolution available.

[OperatorLogin1.PNG](#) (227 × 126 pixels, file size: 4 KB, MIME type: image/gif)

## File history

Click on a date/time to view the file as it appeared at that time.

Date/Time	Thumbnail	Dimensions	User	Comment
current <a href="#">06:35, 19 January 2008</a>		227 × 126 (4 KB)	<a href="#">Dl6rai</a> ( <a href="#">talk</a>   <a href="#">contribs</a> )	

You cannot overwrite this file.

## File usage

The following page uses this file:

- [Menu:Commands](#)

## Namespaces

- [File](#)
- [Discussion](#)

## Variants

## Views

- [Read](#)
- [View source](#)

- [View history](#)

## More

- This page was last edited on 19 January 2008, at 06:35.

- [Privacy policy](#)
- [About Win-Test Wiki](#)
- [Disclaimers](#)



# File:OperatorLogin2.PNG

From Win-Test Wiki

[Jump to navigation](#) [Jump to search](#)

- [File](#)
- [File history](#)
- [File usage](#)

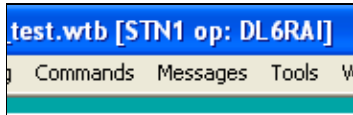

No higher resolution available.

[OperatorLogin2.PNG](#) (181 × 58 pixels, file size: 2 KB, MIME type: image/gif)

## File history

Click on a date/time to view the file as it appeared at that time.

Date/Time	Thumbnail	Dimensions	User	Comment
current <a href="#">06:34, 19 January 2008</a>		181 × 58 (2 KB)	<a href="#">Dl6rai</a> ( <a href="#">talk</a>   <a href="#">contribs</a> )	

You cannot overwrite this file.

## File usage

The following page uses this file:

- [Menu:Commands](#)

## Namespaces

- [File](#)
- [Discussion](#)

## Variants

## Views

- [Read](#)
- [View source](#)
- [View history](#)

## More

- This page was last edited on 19 January 2008, at 06:34.

- [Privacy policy](#)
- [About Win-Test Wiki](#)
- [Disclaimers](#)



# File:OperatorLogin2.PNG

From Win-Test Wiki

[Jump to navigation](#) [Jump to search](#)

- [File](#)
- [File history](#)
- [File usage](#)

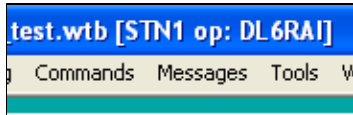

No higher resolution available.

[OperatorLogin2.PNG](#) (181 × 58 pixels, file size: 2 KB, MIME type: image/gif)

## File history

Click on a date/time to view the file as it appeared at that time.

Date/Time	Thumbnail	Dimensions	User	Comment
current <a href="#">06:34, 19 January 2008</a>		181 × 58 (2 KB)	<a href="#">Dl6rai</a> ( <a href="#">talk</a>   <a href="#">contribs</a> )	

You cannot overwrite this file.

## File usage

The following page uses this file:

- [Menu:Commands](#)

## Namespaces

- [File](#)
- [Discussion](#)

## Variants

## Views

- [Read](#)
- [View source](#)
- [View history](#)

## More

- This page was last edited on 19 January 2008, at 06:34.

- [Privacy policy](#)
- [About Win-Test Wiki](#)
- [Disclaimers](#)



# File:OptionsCwAutosending.gif

From Win-Test Wiki

[Jump to navigation](#) [Jump to search](#)

- [File](#)
- [File history](#)
- [File usage](#)

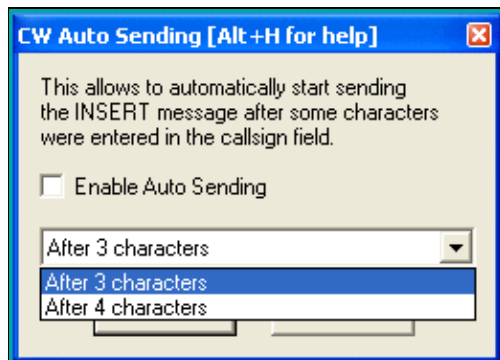

No higher resolution available.

[OptionsCwAutosending.gif](#) (259 × 185 pixels, file size: 7 KB, MIME type: image/gif)

## File history

Click on a date/time to view the file as it appeared at that time.

Date/Time	Thumbnail	Dimensions	User	Comment
current <a href="#">06:04, 21 January 2009</a>		259 × 185 (7 KB)	<a href="#">Dl6rai</a> ( <a href="#">talk</a>   <a href="#">contribs</a> )	

You cannot overwrite this file.

## File usage

The following file is a duplicate of this file ([more details](#)):

- [File:OptionsCwAutoSending.gif](#)

There are no pages that use this file.

## Namespaces

- [File](#)
- [Discussion](#)

## Variants

## Views

- [Read](#)
- [View source](#)
- [View history](#)

## More

- This page was last edited on 21 January 2009, at 06:04.

- [Privacy policy](#)
- [About Win-Test Wiki](#)
- [Disclaimers](#)





# File:OptionsCwAutoSending.gif

From Win-Test Wiki

[Jump to navigation](#) [Jump to search](#)

- [File](#)
- [File history](#)
- [File usage](#)

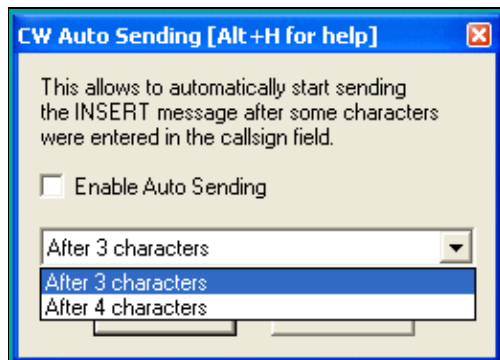

No higher resolution available.

[OptionsCwAutoSending.gif](#) (259 Å 185 pixels, file size: 7 KB, MIME type: image.gif)

## File history

Click on a date/time to view the file as it appeared at that time.

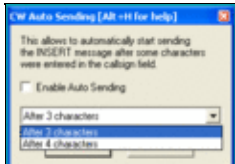
Date/Time	Thumbnail	Dimensions	User	Comment
current <a href="#">06:07, 21 January 2009</a>		259 Å 185 (7 KB)	<a href="#">Dl6rai</a> ( <a href="#">talk</a>   <a href="#">contribs</a> )	

You cannot overwrite this file.

## File usage

The following file is a duplicate of this file ([more details](#)):

- [File:OptionsCwAutosending.gif](#)

The following page uses this file:

- [Menu:Options](#)

## Namespaces

- [File](#)
- [Discussion](#)

## Variants

## Views

- [Read](#)
- [View source](#)
- [View history](#)

## More

- This page was last edited on 21 January 2009, at 06:07.
- [Privacy policy](#)
- [About Win-Test Wiki](#)
- [Disclaimers](#)



# File:OptionsCwAutosending.gif

From Win-Test Wiki

[Jump to navigation](#) [Jump to search](#)

- [File](#)
- [File history](#)
- [File usage](#)

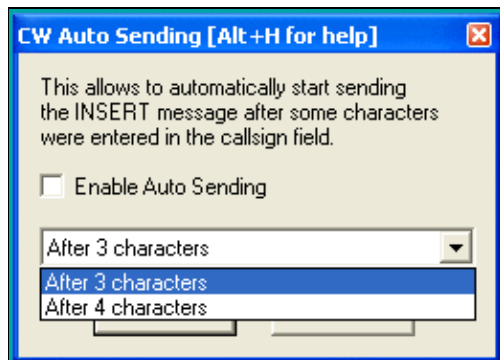

No higher resolution available.

[OptionsCwAutosending.gif](#) (259 × 185 pixels, file size: 7 KB, MIME type: image.gif)

## File history

Click on a date/time to view the file as it appeared at that time.

Date/Time	Thumbnail	Dimensions	User	Comment
current <a href="#">06:04, 21 January 2009</a>		259 × 185 (7 KB)	<a href="#">Dl6rai</a> ( <a href="#">talk</a>   <a href="#">contribs</a> )	

You cannot overwrite this file.

## File usage

The following file is a duplicate of this file ([more details](#)):

- [File:OptionsCwAutoSending.gif](#)

There are no pages that use this file.

## Namespaces

- [File](#)
- [Discussion](#)

## Variants

## Views

- [Read](#)
- [View source](#)
- [View history](#)

## More

- This page was last edited on 21 January 2009, at 06:04.

- [Privacy policy](#)
- [About Win-Test Wiki](#)
- [Disclaimers](#)



# File:OptionsCwAutoSending.gif

From Win-Test Wiki

[Jump to navigation](#) [Jump to search](#)

- [File](#)
- [File history](#)
- [File usage](#)

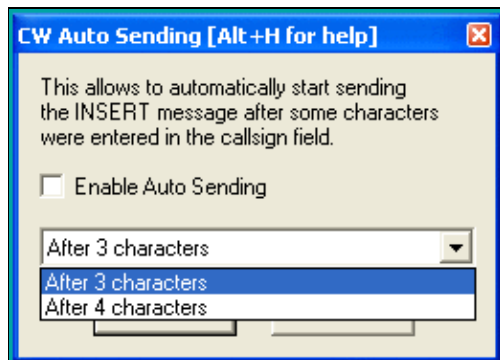

No higher resolution available.

[OptionsCwAutoSending.gif](#) (259 Å 185 pixels, file size: 7 KB, MIME type: image.gif)

## File history

Click on a date/time to view the file as it appeared at that time.

Date/Time	Thumbnail	Dimensions	User	Comment
current <a href="#">06:07, 21 January 2009</a>		259 Å 185 (7 KB)	<a href="#">Dl6rai</a> ( <a href="#">talk</a>   <a href="#">contribs</a> )	

You cannot overwrite this file.

## File usage

The following file is a duplicate of this file ([more details](#)):

- [File:OptionsCwAutosending.gif](#)

The following page uses this file:

- [Menu:Options](#)

## Namespaces

- [File](#)
- [Discussion](#)

## Variants

## Views

- [Read](#)
- [View source](#)
- [View history](#)

## More

- This page was last edited on 21 January 2009, at 06:07.
- [Privacy policy](#)
- [About Win-Test Wiki](#)
- [Disclaimers](#)



# File:OptionsCWCcustomVariables.PNG

From Win-Test Wiki

[Jump to navigation](#) [Jump to search](#)

- [File](#)
- [File history](#)
- [File usage](#)

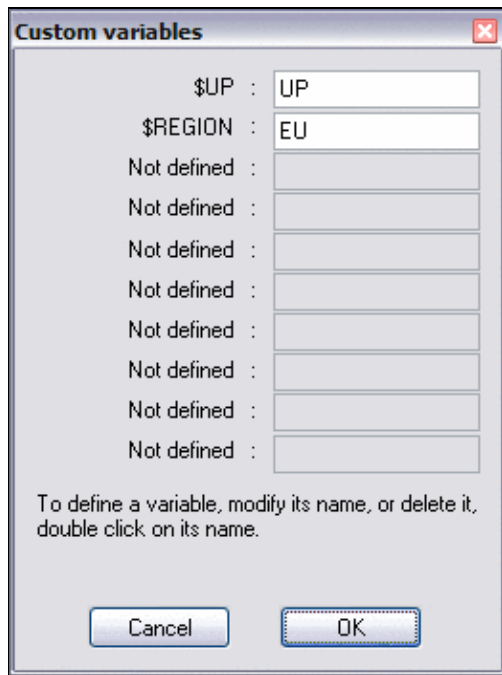

No higher resolution available.

[OptionsCWCcustomVariables.PNG](#) (260 × 349 pixels, file size: 8 KB, MIME type: image.gif)

Custom message variable dialog (Options | CW | Custom variables ...)

## File history

Click on a date/time to view the file as it appeared at that time.

	Date/Time	Thumbnail	Dimensions	User	Comment
current	<a href="#">18:38, 16 November 2009</a>		260 × 349 (8 KB)	<a href="#">N6TV (talk   contribs)</a>	Custom message variable dialog (Options   CW   Custom variables ...)

Date/Time	Thumbnail	Dimensions	User	Comment
You cannot overwrite this file.				

## File usage

The following page uses this file:

- [Menu:Options](#)

## Namespaces

- [File](#)
- [Discussion](#)

## Variants

## Views

- [Read](#)
- [View source](#)
- [View history](#)

## More

- This page was last edited on 16 November 2009, at 18:38.

- [Privacy policy](#)
- [About Win-Test Wiki](#)
- [Disclaimers](#)

- The logo consists of a yellow sun icon on the left, followed by the text "Powered By" in a small font, and "MediaWiki" in a larger font below it, all enclosed in a thin black rectangular border.



# File:OptionsCWCcustomVariables.PNG

From Win-Test Wiki

[Jump to navigation](#) [Jump to search](#)

- [File](#)
- [File history](#)
- [File usage](#)

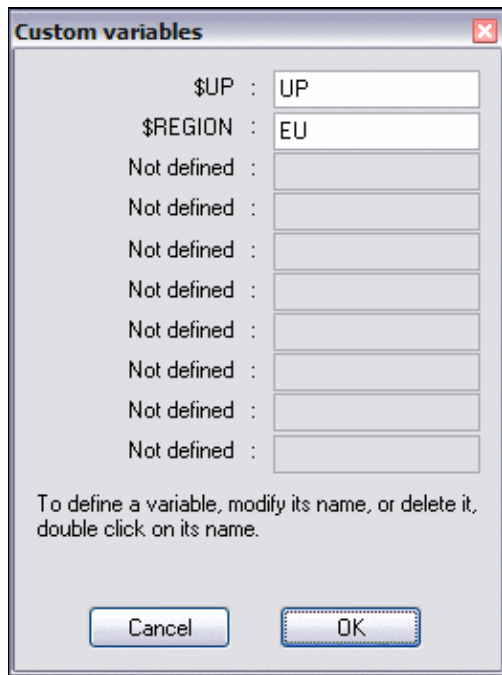

No higher resolution available.

[OptionsCWCcustomVariables.PNG](#) (260 × 349 pixels, file size: 8 KB, MIME type: image.gif)

Custom message variable dialog (Options | CW | Custom variables ...)

## File history

Click on a date/time to view the file as it appeared at that time.

	Date/Time	Thumbnail	Dimensions	User	Comment
current	<a href="#">18:38, 16 November 2009</a>		260 × 349 (8 KB)	<a href="#">N6TV (talk   contribs)</a>	Custom message variable dialog (Options   CW   Custom variables ...)

Date/Time	Thumbnail	Dimensions	User	Comment
You cannot overwrite this file.				

## File usage

The following page uses this file:

- [Menu:Options](#)

## Namespaces

- [File](#)
- [Discussion](#)

## Variants

## Views

- [Read](#)
- [View source](#)
- [View history](#)

## More

- This page was last edited on 16 November 2009, at 18:38.

- [Privacy policy](#)
- [About Win-Test Wiki](#)
- [Disclaimers](#)

- 

# File:OptionsDataFileExchangeDB.gif

From Win-Test Wiki

[Jump to navigation](#) [Jump to search](#)

- [File](#)
- [File history](#)
- [File usage](#)
- [Metadata](#)

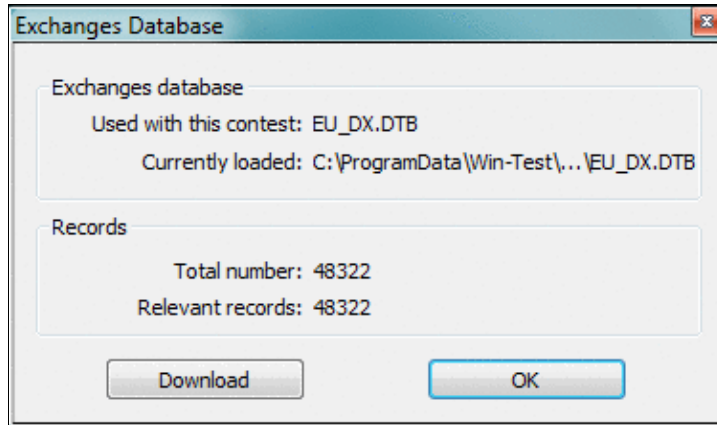

No higher resolution available.

[OptionsDataFileExchangeDB.gif](#) (375 Å 221 pixels, file size: 13 KB, MIME type: image.gif)

## File history

Click on a date/time to view the file as it appeared at that time.

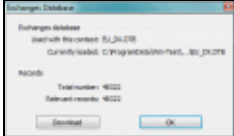
	Date/Time	Thumbnail	Dimensions	User	Comment
current	<a href="#">18:01, 11 February 2021</a>		375 Å 221 (13 KB)	<a href="#">Dl6rai</a> ( <a href="#">talk</a>   <a href="#">contribs</a> )	

You cannot overwrite this file.

## File usage

The following page uses this file:

- [Menu:Options](#)

## Metadata

This file contains additional information, probably added from the digital camera or scanner used to create or digitize it.

If the file has been modified from its original state, some details may not fully reflect the modified file.

**Horizontal resolution** 37.79 dpc

**Vertical resolution** 37.79 dpc

## Namespaces

- [File](#)
- [Discussion](#)

## Variants

## Views

- [Read](#)
- [View source](#)
- [View history](#)

## More

- This page was last edited on 11 February 2021, at 18:01.

- [Privacy policy](#)
- [About Win-Test Wiki](#)
- [Disclaimers](#)

- The logo for MediaWiki, featuring a sun icon and the text "Powered By MediaWiki".

# File:OptionsDataFileExchangeDB.gif

From Win-Test Wiki

[Jump to navigation](#) [Jump to search](#)

- [File](#)
- [File history](#)
- [File usage](#)
- [Metadata](#)

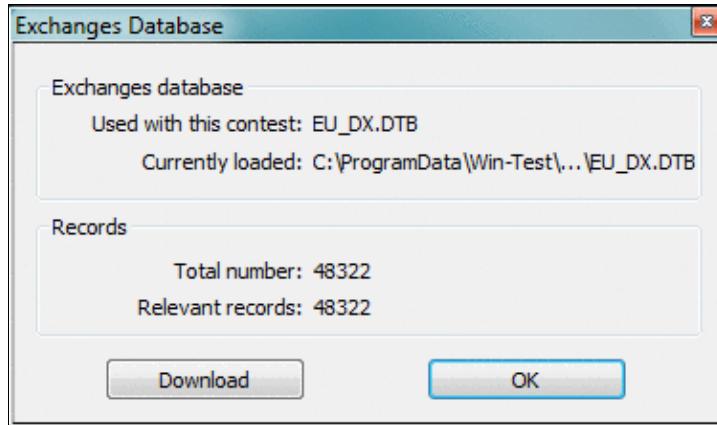

No higher resolution available.

[OptionsDataFileExchangeDB.gif](#) (375 Å 221 pixels, file size: 13 KB, MIME type: image.gif)

## File history

Click on a date/time to view the file as it appeared at that time.

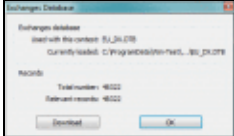
	Date/Time	Thumbnail	Dimensions	User	Comment
current	<a href="#">18:01, 11 February 2021</a>		375 Å 221 (13 KB)	<a href="#">Dl6rai</a> ( <a href="#">talk</a>   <a href="#">contribs</a> )	

You cannot overwrite this file.

## File usage

The following page uses this file:

- [Menu:Options](#)

## Metadata

This file contains additional information, probably added from the digital camera or scanner used to create or digitize it.

If the file has been modified from its original state, some details may not fully reflect the modified file.

**Horizontal resolution** 37.79 dpc

**Vertical resolution** 37.79 dpc

## Namespaces

- [File](#)
- [Discussion](#)

## Variants

## Views

- [Read](#)
- [View source](#)
- [View history](#)

## More

- This page was last edited on 11 February 2021, at 18:01.

- [Privacy policy](#)
- [About Win-Test Wiki](#)
- [Disclaimers](#)

-  The logo consists of a small sun icon to the left of the text "Powered By MediaWiki".

# File:OptionsDataFileMasterfile.gif

From Win-Test Wiki

[Jump to navigation](#) [Jump to search](#)

- [File](#)
- [File history](#)
- [File usage](#)
- [Metadata](#)

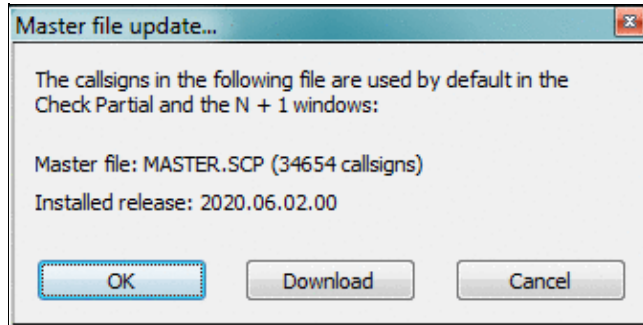

No higher resolution available.

[OptionsDataFileMasterfile.gif](#) (335 Å 169 pixels, file size: 12 KB, MIME type: image.gif)

## File history

Click on a date/time to view the file as it appeared at that time.

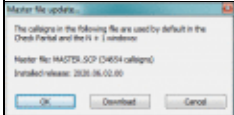
	Date/Time	Thumbnail	Dimensions	User	Comment
current	<a href="#">17:59, 11 February 2021</a>		335 Å 169 (12 KB)	<a href="#">Dl6rai</a> ( <a href="#">talk</a>   <a href="#">contribs</a> )	

You cannot overwrite this file.

## File usage

The following page uses this file:

- [Menu:Options](#)

## Metadata

This file contains additional information, probably added from the digital camera or scanner used to create or digitize it.

If the file has been modified from its original state, some details may not fully reflect the modified file.

**Horizontal resolution** 37.79 dpc

Vertical resolution 37.79 dpc

## Namespaces

- [File](#)
- [Discussion](#)

## Variants

## Views

- [Read](#)
- [View source](#)
- [View history](#)

## More

- This page was last edited on 11 February 2021, at 17:59.
- [Privacy policy](#)
- [About Win-Test Wiki](#)
- [Disclaimers](#)





# File:OptionsDataFileMasterfile.gif

From Win-Test Wiki

[Jump to navigation](#) [Jump to search](#)

- [File](#)
- [File history](#)
- [File usage](#)
- [Metadata](#)

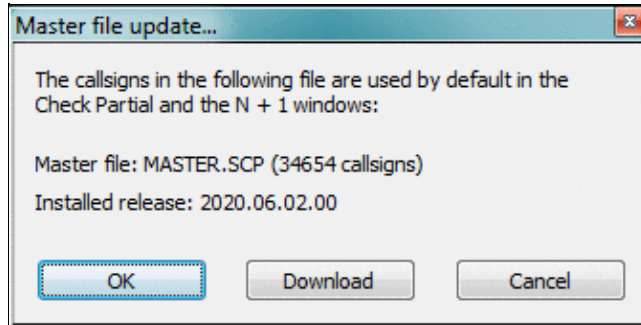

No higher resolution available.

[OptionsDataFileMasterfile.gif](#) (335 Å 169 pixels, file size: 12 KB, MIME type: image.gif)

## File history

Click on a date/time to view the file as it appeared at that time.

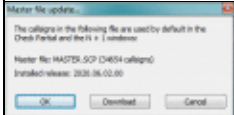
	Date/Time	Thumbnail	Dimensions	User	Comment
current	<a href="#">17:59, 11 February 2021</a>		335 Å 169 (12 KB)	<a href="#">Dl6rai</a> ( <a href="#">talk</a>   <a href="#">contribs</a> )	

You cannot overwrite this file.

## File usage

The following page uses this file:

- [Menu:Options](#)

## Metadata

This file contains additional information, probably added from the digital camera or scanner used to create or digitize it.

If the file has been modified from its original state, some details may not fully reflect the modified file.

**Horizontal resolution** 37.79 dpc

Vertical resolution 37.79 dpc

## Namespaces

- [File](#)
- [Discussion](#)

## Variants

## Views

- [Read](#)
- [View source](#)
- [View history](#)

## More

- This page was last edited on 11 February 2021, at 17:59.
- [Privacy policy](#)
- [About Win-Test Wiki](#)
- [Disclaimers](#)



# File:OptionsDataFiles.gif

From Win-Test Wiki

[Jump to navigation](#) [Jump to search](#)

- [File](#)
- [File history](#)
- [File usage](#)
- [Metadata](#)

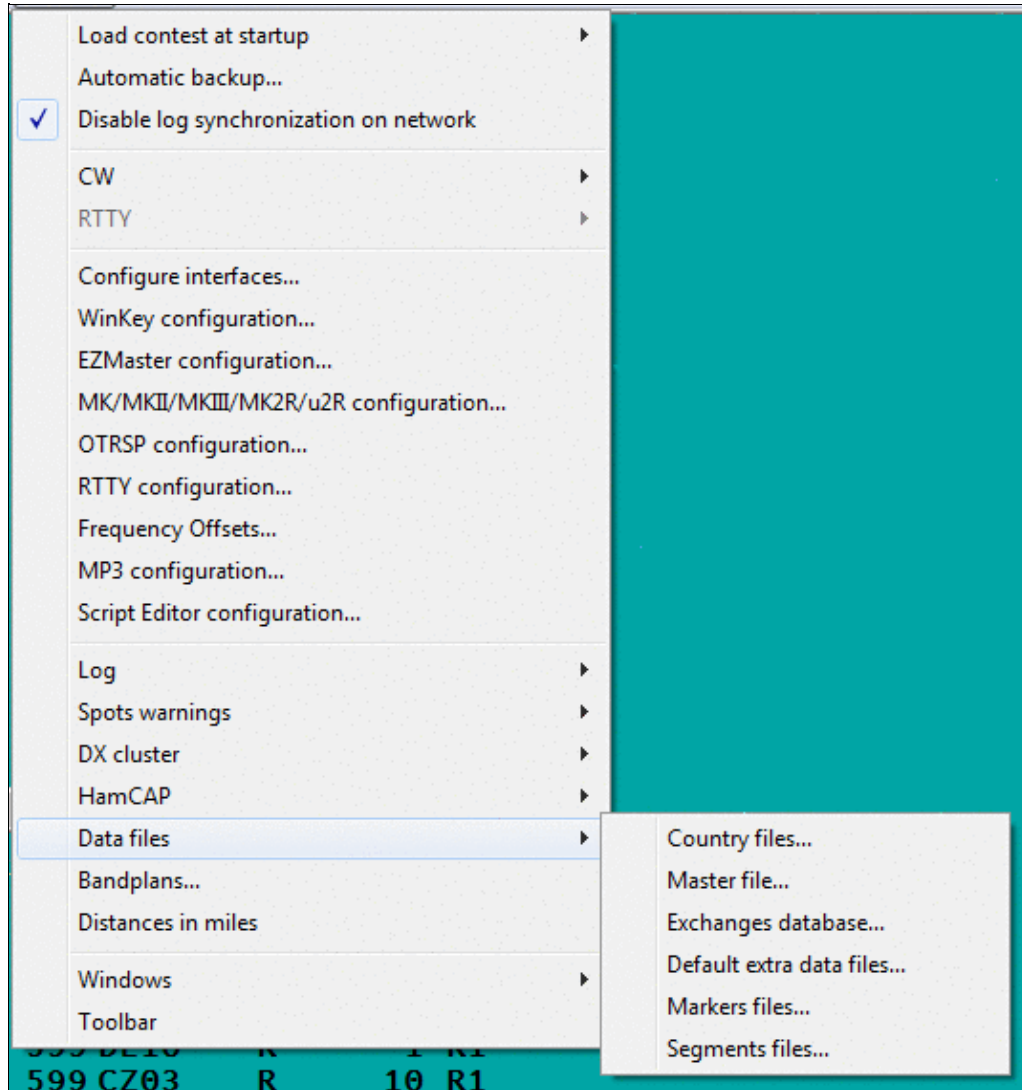

No higher resolution available.

OptionsDataFiles.gif (535 × 569 pixels, file size: 19 KB, MIME type: image.gif)

## File history

Click on a date/time to view the file as it appeared at that time.

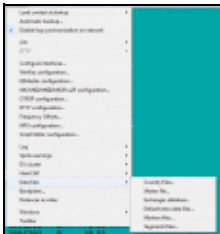
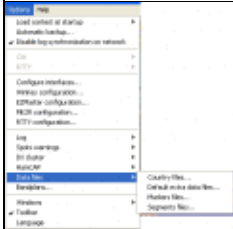
	Date/Time	Thumbnail	Dimensions	User	Comment
current	<u>17:42, 11 February 2021</u>		535 × 569 (19 KB)	<u>DI6rai</u> ( <a href="#">talk</a>   <a href="#">contribs</a> )	
	<u>12:29, 26 March 2007</u>		392 × 389 (11 KB)	<u>I2WIJ</u> ( <a href="#">talk</a>   <a href="#">contribs</a> )	

You cannot overwrite this file.

## File usage

The following page uses this file:

- [Menu:Options](#)

## Metadata

This file contains additional information, probably added from the digital camera or scanner used to create or digitize it.

If the file has been modified from its original state, some details may not fully reflect the modified file.

**Horizontal resolution** 37.79 dpc

**Vertical resolution** 37.79 dpc

## Namespaces

- [File](#)
- [Discussion](#)

## Variants

## Views

- [Read](#)
- [View source](#)
- [View history](#)

## More

- This page was last edited on 11 February 2021, at 17:42.

- [Privacy policy](#)
- [About Win-Test Wiki](#)
- [Disclaimers](#)



# File:OptionsDataFiles.gif

From Win-Test Wiki

[Jump to navigation](#) [Jump to search](#)

- [File](#)
- [File history](#)
- [File usage](#)
- [Metadata](#)

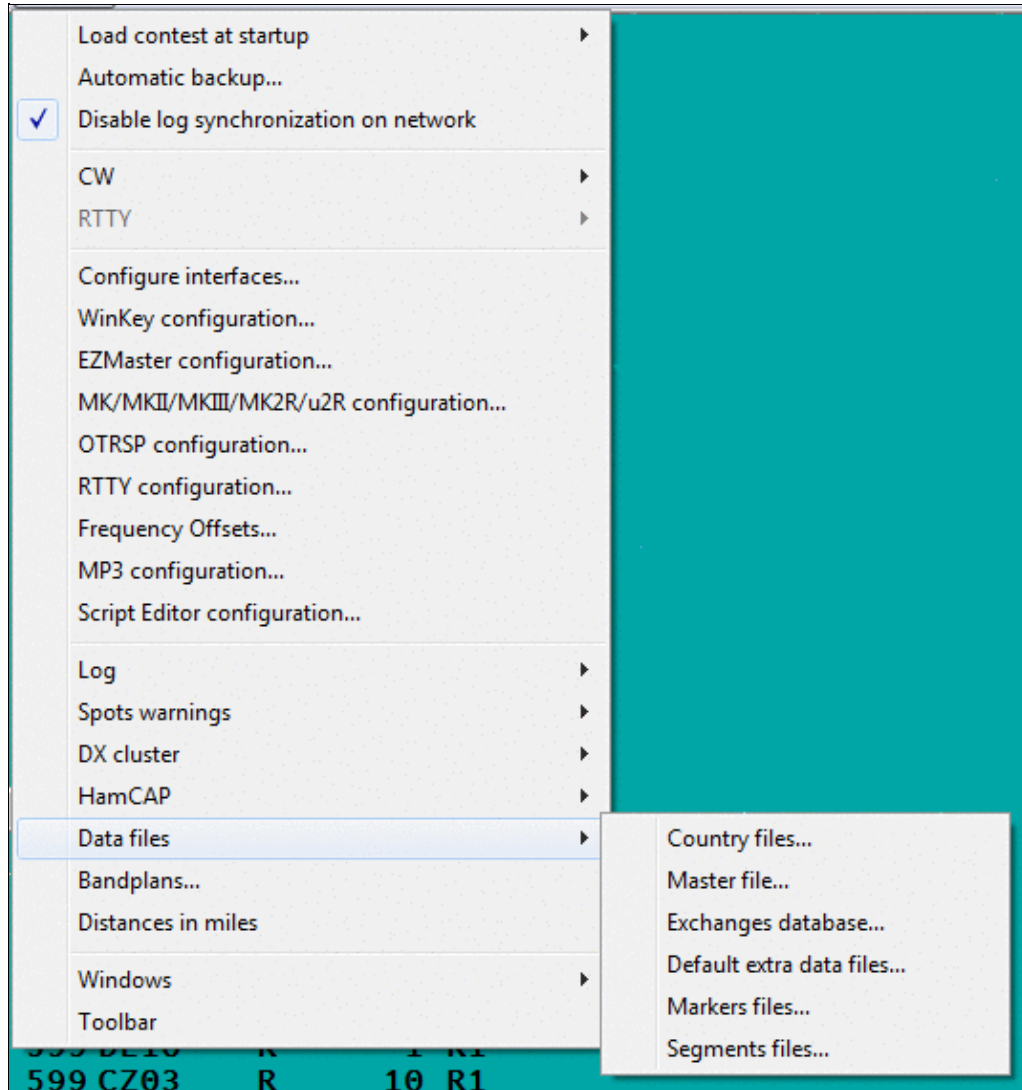

No higher resolution available.

[OptionsDataFiles.gif](#) (535 × 569 pixels, file size: 19 KB, MIME type: image.gif)

## File history

Click on a date/time to view the file as it appeared at that time.

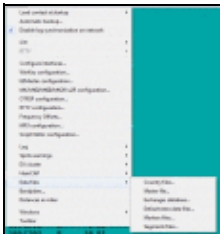
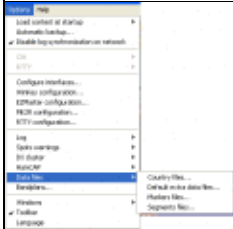
	Date/Time	Thumbnail	Dimensions	User	Comment
current	<a href="#">17:42, 11 February 2021</a>		535 × 569 (19 KB)	<a href="#">Dl6rai</a> ( <a href="#">talk</a>   <a href="#">contribs</a> )	
	<a href="#">12:29, 26 March 2007</a>		392 × 389 (11 KB)	<a href="#">I2WIJ</a> ( <a href="#">talk</a>   <a href="#">contribs</a> )	

You cannot overwrite this file.

## File usage

The following page uses this file:

- [Menu:Options](#)

## Metadata

This file contains additional information, probably added from the digital camera or scanner used to create or digitize it.

If the file has been modified from its original state, some details may not fully reflect the modified file.

**Horizontal resolution** 37.79 dpc

**Vertical resolution** 37.79 dpc

## Namespaces

- [File](#)
- [Discussion](#)

## Variants

## Views

- [Read](#)
- [View source](#)
- [View history](#)

## More

- This page was last edited on 11 February 2021, at 17:42.

- [Privacy policy](#)
- [About Win-Test Wiki](#)
- [Disclaimers](#)





# File:OptionsDxClusterSyntax.gif

From Win-Test Wiki

[Jump to navigation](#) [Jump to search](#)

- [File](#)
- [File history](#)
- [File usage](#)

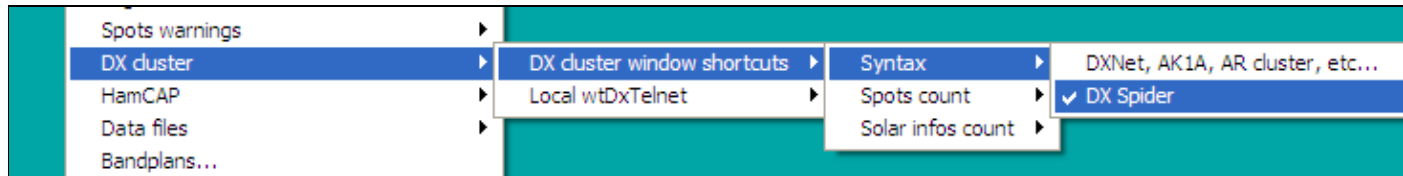

No higher resolution available.

[OptionsDxClusterSyntax.gif](#) (764 × 90 pixels, file size: 8 KB, MIME type: image/gif)

Menu options to select the DX Cluster syntax

## File history

Click on a date/time to view the file as it appeared at that time.

	Date/Time	Thumbnail	Dimensions	User	Comment
current	<a href="#">22:11, 26 November 2007</a>		764 × 90 (8 KB)	<a href="#">N6TV (talk   contribs)</a>	Menu options to select the DX Cluster syntax

You cannot overwrite this file.

## File usage

The following page uses this file:

- [Menu:Options](#)

## Namespaces

- [File](#)
- [Discussion](#)

## Variants

## Views

- [Read](#)
- [View source](#)
- [View history](#)

## More

- This page was last edited on 26 November 2007, at 22:11.

- [Privacy policy](#)
- [About Win-Test Wiki](#)
- [Disclaimers](#)



# File:OptionsDxClusterSyntax.gif

From Win-Test Wiki

[Jump to navigation](#) [Jump to search](#)

- [File](#)
- [File history](#)
- [File usage](#)

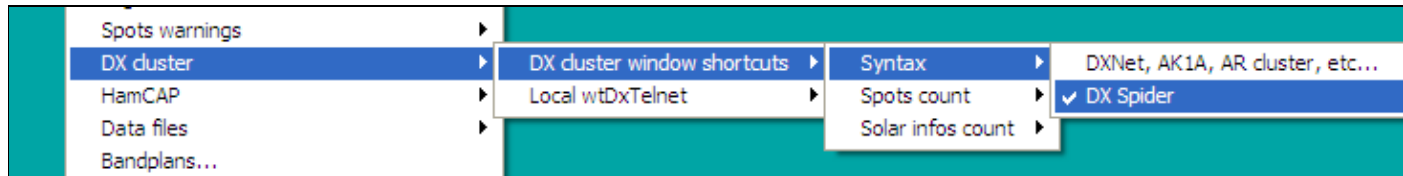

No higher resolution available.

[OptionsDxClusterSyntax.gif](#) (764 × 90 pixels, file size: 8 KB, MIME type: image/gif)

Menu options to select the DX Cluster syntax

## File history

Click on a date/time to view the file as it appeared at that time.

	Date/Time	Thumbnail	Dimensions	User	Comment
current	<a href="#">22:11, 26 November 2007</a>		764 × 90 (8 KB)	<a href="#">N6TV (talk   contribs)</a>	Menu options to select the DX Cluster syntax

You cannot overwrite this file.

## File usage

The following page uses this file:

- [Menu:Options](#)

## Namespaces

- [File](#)
- [Discussion](#)

## Variants

## Views

- [Read](#)
- [View source](#)
- [View history](#)

## More

- This page was last edited on 26 November 2007, at 22:11.

- [Privacy policy](#)
- [About Win-Test Wiki](#)
- [Disclaimers](#)



# File:OptionsFrequencyOffsets.gif

From Win-Test Wiki

[Jump to navigation](#) [Jump to search](#)

- [File](#)
- [File history](#)
- [File usage](#)

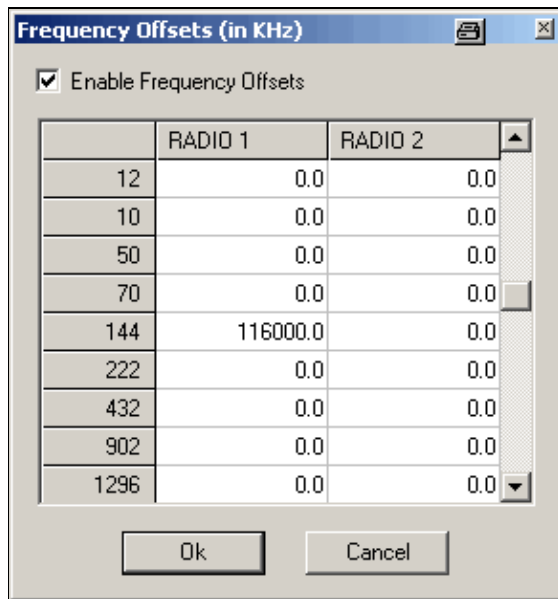

No higher resolution available.

[OptionsFrequencyOffsets.gif](#) (290 × 310 pixels, file size: 5 KB, MIME type: image.gif)

## File history

Click on a date/time to view the file as it appeared at that time.

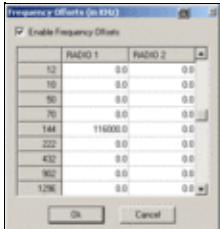
	Date/Time	Thumbnail	Dimensions	User	Comment
current	<a href="#">21:31, 9 July 2007</a>		290 × 310 (5 KB)	<a href="#">Dl6rai</a> ( <a href="#">talk</a>   <a href="#">contribs</a> )	

You cannot overwrite this file.

## File usage

The following page uses this file:

- [Menu:Options](#)

## Namespaces

- [File](#)
- [Discussion](#)

## Variants

## Views

- [Read](#)
- [View source](#)
- [View history](#)

## More

- This page was last edited on 9 July 2007, at 21:31.
- [Privacy policy](#)
- [About Win-Test Wiki](#)
- [Disclaimers](#)



# File:OptionsFrequencyOffsets.gif

From Win-Test Wiki

[Jump to navigation](#) [Jump to search](#)

- [File](#)
- [File history](#)
- [File usage](#)

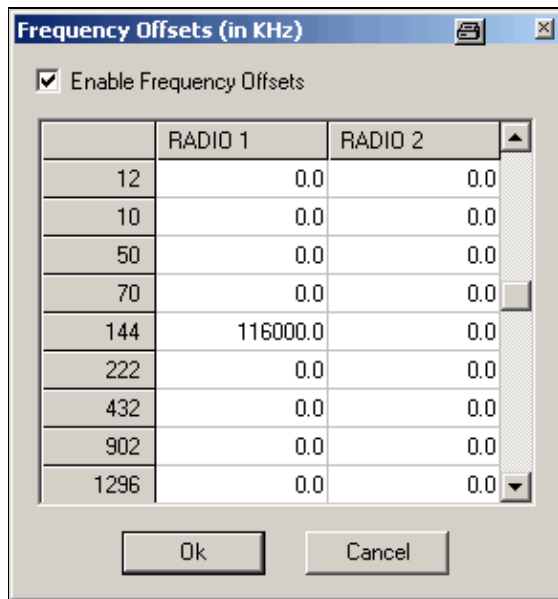

No higher resolution available.

[OptionsFrequencyOffsets.gif](#) (290 × 310 pixels, file size: 5 KB, MIME type: image.gif)

## File history

Click on a date/time to view the file as it appeared at that time.

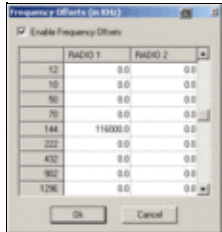
Date/Time	Thumbnail	Dimensions	User	Comment
current <a href="#">21:31, 9 July 2007</a>		290 × 310 (5 KB)	<a href="#">Dl6rai</a> ( <a href="#">talk</a>   <a href="#">contribs</a> )	

You cannot overwrite this file.

## File usage

The following page uses this file:

- [Menu:Options](#)

## Namespaces

- [File](#)
- [Discussion](#)

## Variants

## Views

- [Read](#)
- [View source](#)
- [View history](#)

## More

- This page was last edited on 9 July 2007, at 21:31.
- [Privacy policy](#)
- [About Win-Test Wiki](#)
- [Disclaimers](#)





# File:OptionsHamCapBackground.gif

From Win-Test Wiki

[Jump to navigation](#) [Jump to search](#)

- [File](#)
- [File history](#)
- [File usage](#)

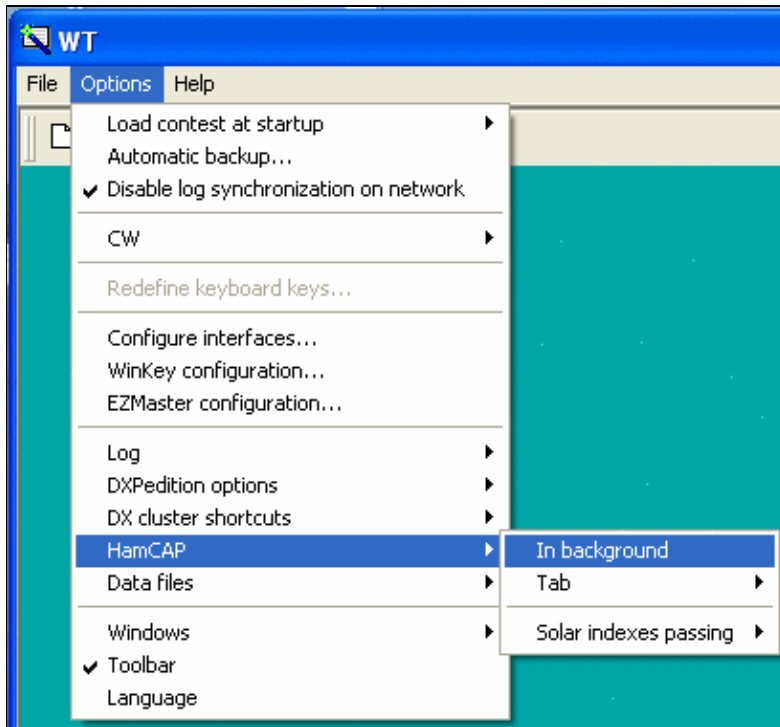

No higher resolution available.

[OptionsHamCapBackground.gif](#) (409 × 378 pixels, file size: 15 KB, MIME type: image/gif)

## File history

Click on a date/time to view the file as it appeared at that time.

	Date/Time	Thumbnail	Dimensions	User	Comment
current	<a href="#">13:51, 10 August 2006</a>		409 × 378 (15 KB)	<a href="#">I2WII</a> ( <a href="#">talk</a>   <a href="#">contribs</a> )	

Date/Time	Thumbnail	Dimensions	User	Comment
You cannot overwrite this file.				

## File usage

The following page uses this file:

- [Menu:Options](#)

## Namespaces

- [File](#)
- [Discussion](#)

## Variants

## Views

- [Read](#)
- [View source](#)
- [View history](#)

## More

- This page was last edited on 10 August 2006, at 13:51.

- [Privacy policy](#)
- [About Win-Test Wiki](#)
- [Disclaimers](#)



# File:OptionsHamCapBackground.gif

From Win-Test Wiki

[Jump to navigation](#) [Jump to search](#)

- [File](#)
- [File history](#)
- [File usage](#)

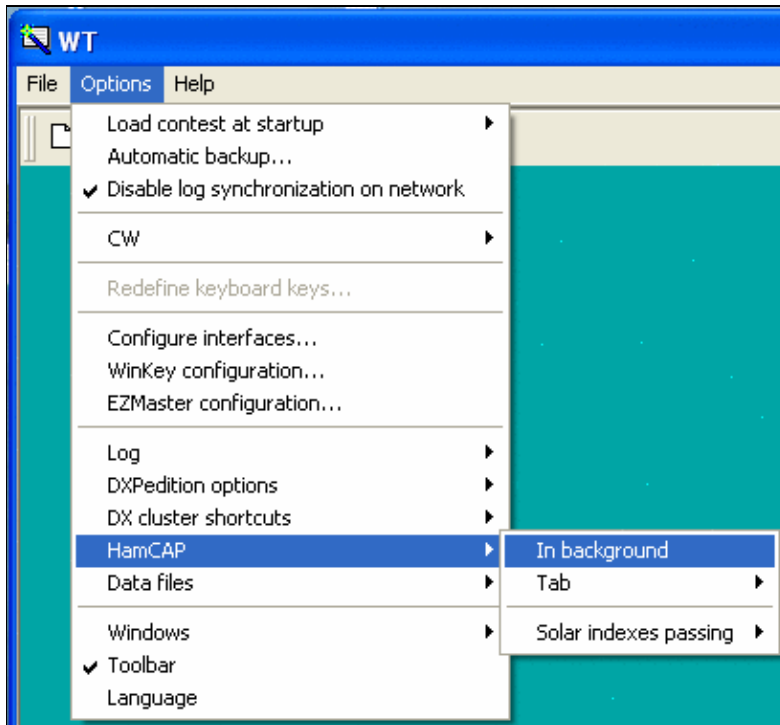

No higher resolution available.

[OptionsHamCapBackground.gif](#) (409 × 378 pixels, file size: 15 KB, MIME type: image.gif)

## File history

Click on a date/time to view the file as it appeared at that time.

	Date/Time	Thumbnail	Dimensions	User	Comment
current	<a href="#">13:51, 10 August 2006</a>		409 × 378 (15 KB)	<a href="#">I2WII</a> ( <a href="#">talk</a>   <a href="#">contribs</a> )	

Date/Time	Thumbnail	Dimensions	User	Comment
You cannot overwrite this file.				

## File usage

The following page uses this file:

- [Menu:Options](#)

## Namespaces

- [File](#)
- [Discussion](#)

## Variants

## Views

- [Read](#)
- [View source](#)
- [View history](#)

## More

- This page was last edited on 10 August 2006, at 13:51.

- [Privacy policy](#)
- [About Win-Test Wiki](#)
- [Disclaimers](#)

- 

# File:OptionsHamCapSolar.gif

From Win-Test Wiki

[Jump to navigation](#) [Jump to search](#)

- [File](#)
- [File history](#)
- [File usage](#)

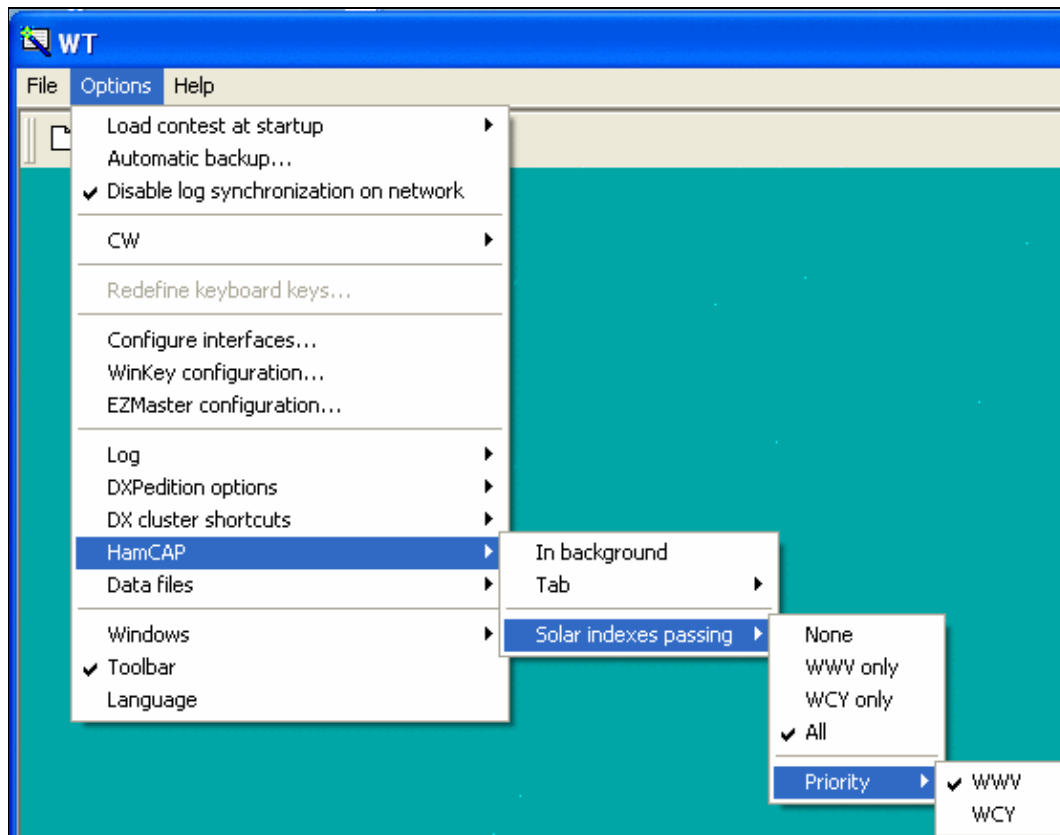

No higher resolution available.

[OptionsHamCapSolar.gif](#) (556 × 435 pixels, file size: 18 KB, MIME type: image.gif)

## File history

Click on a date/time to view the file as it appeared at that time.

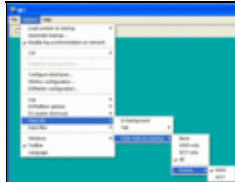
	Date/Time	Thumbnail	Dimensions	User	Comment
current	<a href="#">13:51, 10 August 2006</a>		556 × 435 (18 KB)	<a href="#">I2WIJ</a> ( <a href="#">talk</a>   <a href="#">contribs</a> )	

You cannot overwrite this file.

## File usage

The following page uses this file:

- [Menu:Options](#)

## Namespaces

- [File](#)
- [Discussion](#)

## Variants

## Views

- [Read](#)
- [View source](#)
- [View history](#)

## More

- This page was last edited on 10 August 2006, at 13:51.

- [Privacy policy](#)
- [About Win-Test Wiki](#)
- [Disclaimers](#)



# File:OptionsHamCapSolar.gif

From Win-Test Wiki

[Jump to navigation](#) [Jump to search](#)

- [File](#)
- [File history](#)
- [File usage](#)

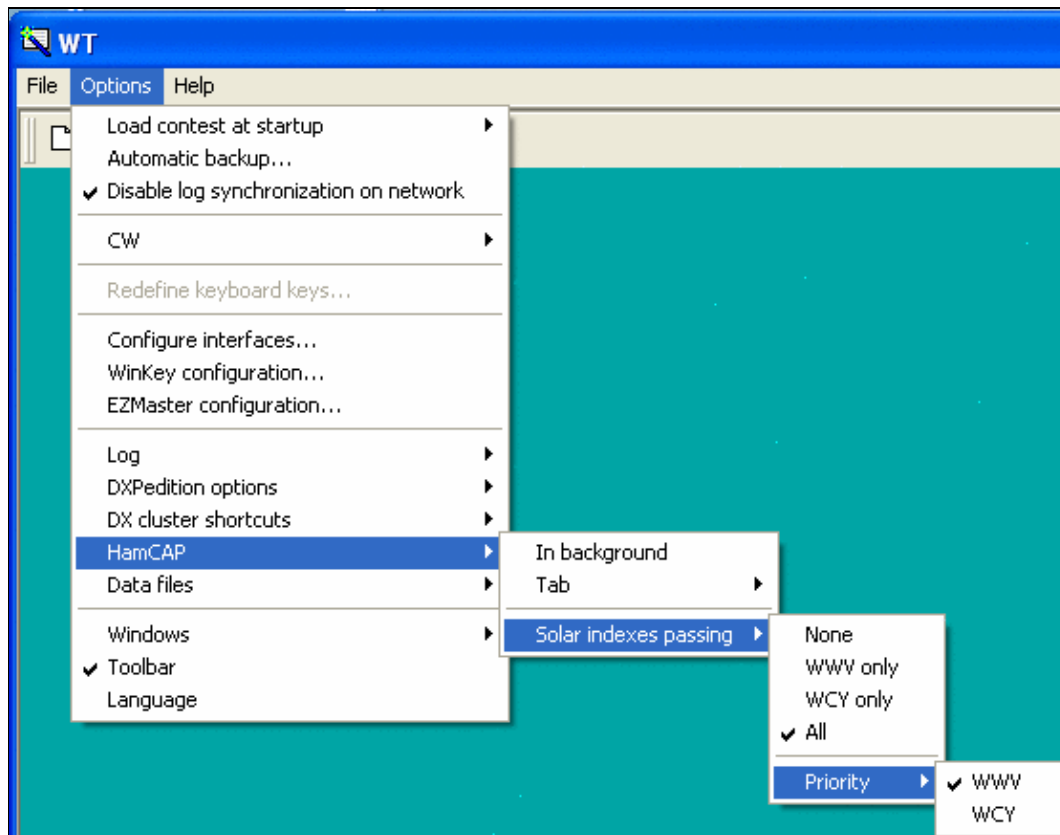

No higher resolution available.

OptionsHamCapSolar.gif (556 × 435 pixels, file size: 18 KB, MIME type: image.gif)

## File history

Click on a date/time to view the file as it appeared at that time.

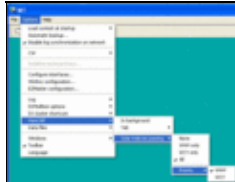
	Date/Time	Thumbnail	Dimensions	User	Comment
current	<u>13:51, 10 August 2006</u>		556 × 435 (18 KB)	<u>I2WIJ</u> ( <a href="#">talk</a>   <a href="#">contribs</a> )	

You cannot overwrite this file.

## File usage

The following page uses this file:

- [Menu:Options](#)

## Namespaces

- [File](#)
- [Discussion](#)

## Variants

## Views

- [Read](#)
- [View source](#)
- [View history](#)

## More

- This page was last edited on 10 August 2006, at 13:51.

- [Privacy policy](#)
- [About Win-Test Wiki](#)
- [Disclaimers](#)





# File:OptionsHamCapTab.gif

From Win-Test Wiki

[Jump to navigation](#) [Jump to search](#)

- [File](#)
- [File history](#)
- [File usage](#)

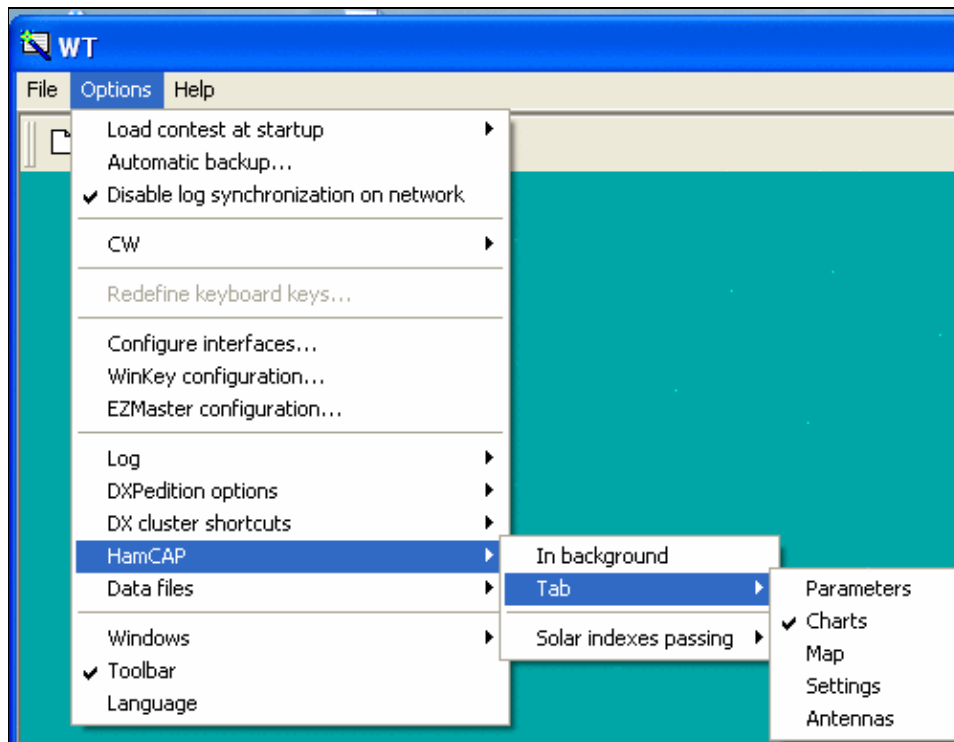

No higher resolution available.

[OptionsHamCapTab.gif](#) (500 × 386 pixels, file size: 18 KB, MIME type: image.gif)

## File history

Click on a date/time to view the file as it appeared at that time.

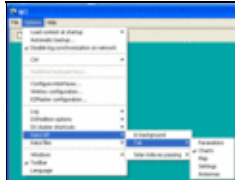
	Date/Time	Thumbnail	Dimensions	User	Comment
current	<a href="#">13:51, 10 August 2006</a>		500 × 386 (18 KB)	<a href="#">I2WIJ</a> ( <a href="#">talk</a>   <a href="#">contribs</a> )	

You cannot overwrite this file.

## File usage

The following page uses this file:

- [Menu:Options](#)

## Namespaces

- [File](#)
- [Discussion](#)

## Variants

## Views

- [Read](#)
- [View source](#)
- [View history](#)

## More

- This page was last edited on 10 August 2006, at 13:51.

- [Privacy policy](#)
- [About Win-Test Wiki](#)
- [Disclaimers](#)



# File:OptionsHamCapTab.gif

From Win-Test Wiki

[Jump to navigation](#) [Jump to search](#)

- [File](#)
- [File history](#)
- [File usage](#)

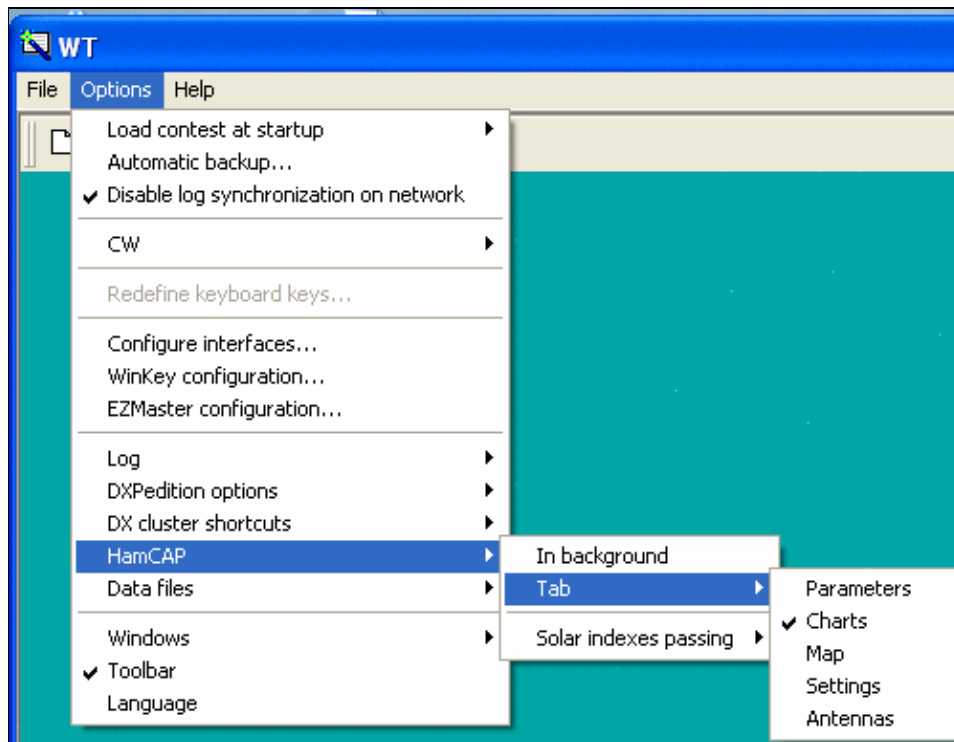

No higher resolution available.

[OptionsHamCapTab.gif](#) (500 × 386 pixels, file size: 18 KB, MIME type: image.gif)

## File history

Click on a date/time to view the file as it appeared at that time.

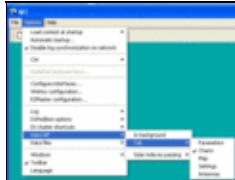
	Date/Time	Thumbnail	Dimensions	User	Comment
current	<a href="#">13:51, 10 August 2006</a>		500 × 386 (18 KB)	<a href="#">I2WIJ</a> ( <a href="#">talk</a>   <a href="#">contribs</a> )	

You cannot overwrite this file.

## File usage

The following page uses this file:

- [Menu:Options](#)

## Namespaces

- [File](#)
- [Discussion](#)

## Variants

## Views

- [Read](#)
- [View source](#)
- [View history](#)

## More

- This page was last edited on 10 August 2006, at 13:51.

- [Privacy policy](#)
- [About Win-Test Wiki](#)
- [Disclaimers](#)



# File:OptionsLanguageSelection.PNG

From Win-Test Wiki

[Jump to navigation](#) [Jump to search](#)

- [File](#)
- [File history](#)
- [File usage](#)





No higher resolution available.

[OptionsLanguageSelection.PNG](#) (126 × 161 pixels, file size: 5 KB, MIME type: image.gif)

## File history

Click on a date/time to view the file as it appeared at that time.

Date/Time	Thumbnail	Dimensions	User	Comment
current <a href="#">06:56, 18 April 2010</a>		126 × 161 (5 KB)	<a href="#">Dl6rai</a> ( <a href="#">talk</a>   <a href="#">contribs</a> )	
<a href="#">13:42, 31 January 2009</a>		126 × 144 (4 KB)	<a href="#">Dl6rai</a> ( <a href="#">talk</a>   <a href="#">contribs</a> )	

You cannot overwrite this file.

## File usage

The following page uses this file:

- [Menu:Options](#)

## Namespaces

- [File](#)
- [Discussion](#)

## Variants

## Views

- [Read](#)
- [View source](#)
- [View history](#)

## More

- This page was last edited on 31 January 2009, at 13:42.
- [Privacy policy](#)
- [About Win-Test Wiki](#)
- [Disclaimers](#)



# File:OptionsLanguageSelection.PNG

From Win-Test Wiki

[Jump to navigation](#) [Jump to search](#)

- [File](#)
- [File history](#)
- [File usage](#)





No higher resolution available.

[OptionsLanguageSelection.PNG](#) (126 × 161 pixels, file size: 5 KB, MIME type: image.gif)

## File history

Click on a date/time to view the file as it appeared at that time.

Date/Time	Thumbnail	Dimensions	User	Comment
current <a href="#">06:56, 18 April 2010</a>		126 × 161 (5 KB)	<a href="#">Dl6rai</a> ( <a href="#">talk</a>   <a href="#">contribs</a> )	
<a href="#">13:42, 31 January 2009</a>		126 × 144 (4 KB)	<a href="#">Dl6rai</a> ( <a href="#">talk</a>   <a href="#">contribs</a> )	

You cannot overwrite this file.

## File usage

The following page uses this file:

- [Menu:Options](#)

## Namespaces

- [File](#)
- [Discussion](#)

## Variants

## Views

- [Read](#)
- [View source](#)
- [View history](#)

## More

- This page was last edited on 31 January 2009, at 13:42.
- [Privacy policy](#)
- [About Win-Test Wiki](#)
- [Disclaimers](#)





# File:OptionsLog.PNG

From Win-Test Wiki

[Jump to navigation](#) [Jump to search](#)

- [File](#)
- [File history](#)
- [File usage](#)
- [Metadata](#)

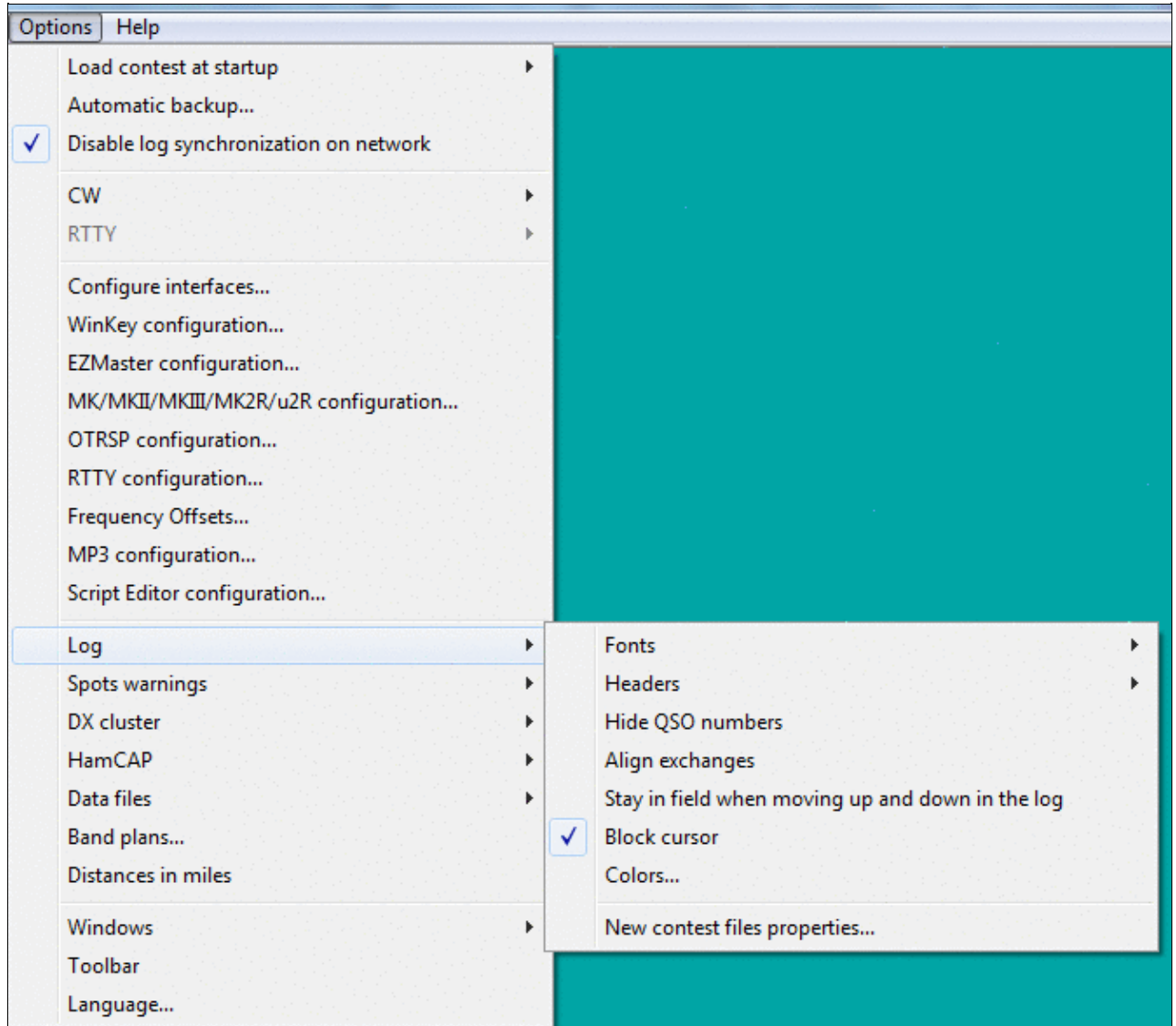

No higher resolution available.

OptionsLog.PNG (667 × 589 pixels, file size: 27 KB, MIME type: image.gif)

Main logging window options.

## File history

Click on a date/time to view the file as it appeared at that time.

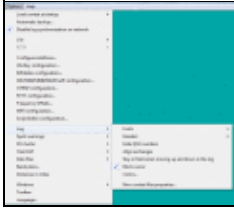
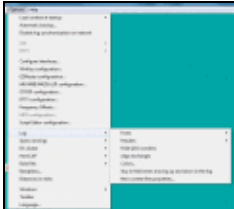
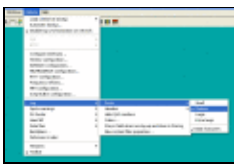
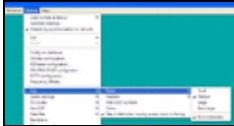
	Date/Time	Thumbnail	Dimensions	User	Comment
current	<u>06:58, 10 April 2023</u>		667 × 589 (27 KB)	<u>D16rai (talk   contribs)</u>	
	<u>16:28, 30 October 2016</u>		663 × 601 (28 KB)	<u>D16rai (talk   contribs)</u>	
	<u>20:26, 4 October 2009</u>		688 × 456 (17 KB)	<u>D16rai (talk   contribs)</u>	
	<u>01:59, 15 February 2009</u>		674 × 359 (17 KB)	<u>N6TV (talk   contribs)</u>	Main logging window options.

You cannot overwrite this file.

## File usage

The following page uses this file:

- Menu:Options

## Metadata

This file contains additional information, probably added from the digital camera or scanner used to create or digitize it.

If the file has been modified from its original state, some details may not fully reflect the modified file.

**Horizontal resolution** 37.79 dpc

**Vertical resolution** 37.79 dpc

## Namespaces

- [File](#)
- [Discussion](#)

## Variants

## Views

- [Read](#)
- [View source](#)
- [View history](#)

## More

- This page was last edited on 10 April 2023, at 06:58.

- [Privacy policy](#)
- [About Win-Test Wiki](#)
- [Disclaimers](#)

- The logo for MediaWiki, featuring a sun icon and the text "Powered By MediaWiki".

# File:OptionsLog.PNG

From Win-Test Wiki

[Jump to navigation](#) [Jump to search](#)

- [File](#)
- [File history](#)
- [File usage](#)
- [Metadata](#)

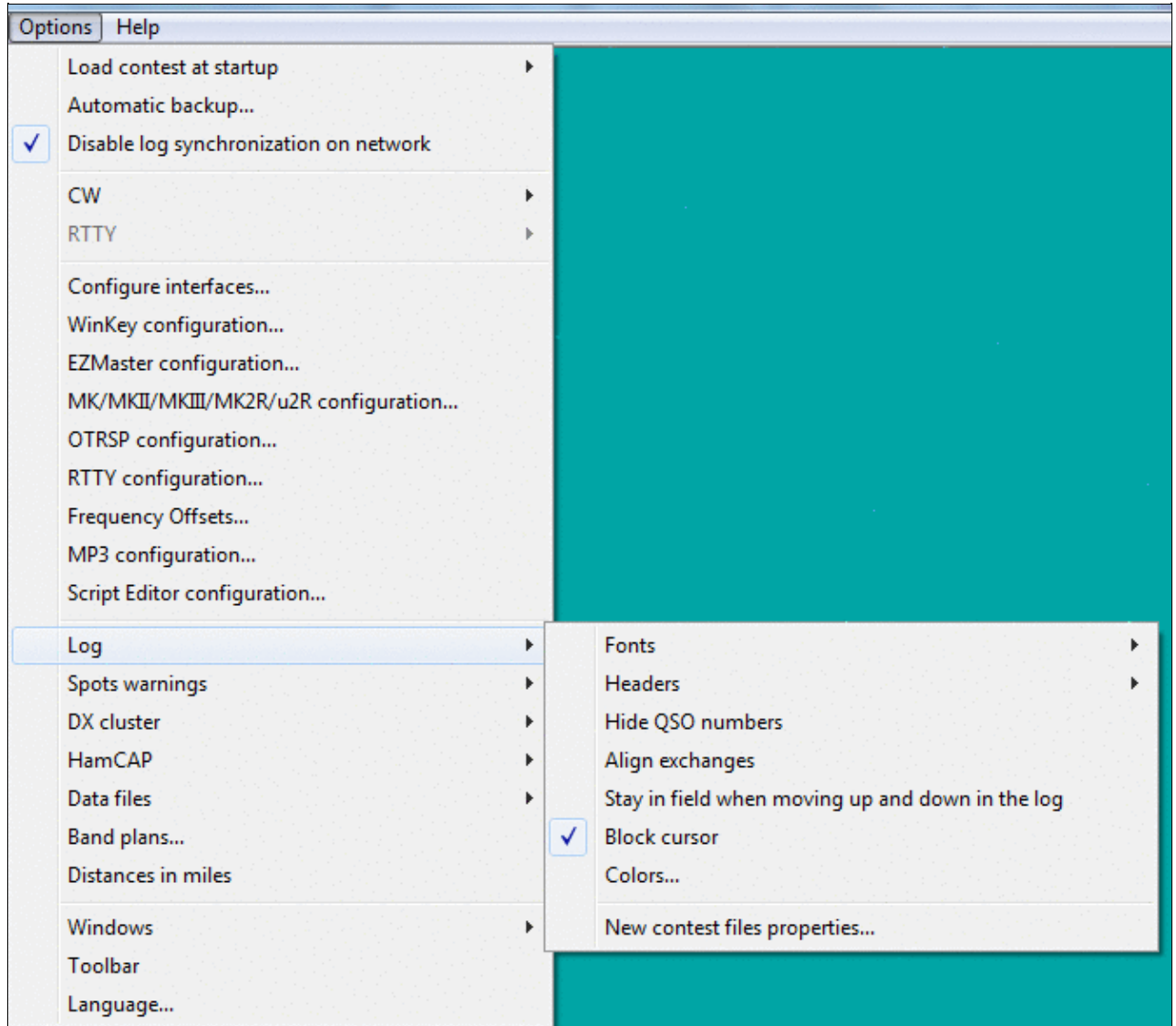

No higher resolution available.

OptionsLog.PNG (667 × 589 pixels, file size: 27 KB, MIME type: image.gif)

Main logging window options.

## File history

Click on a date/time to view the file as it appeared at that time.

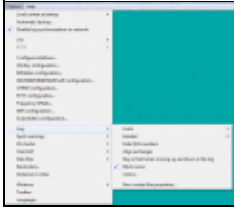
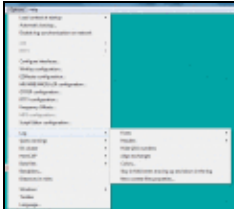
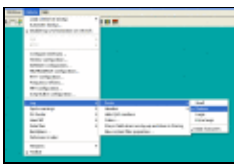
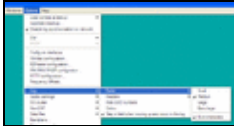
	Date/Time	Thumbnail	Dimensions	User	Comment
current	<u>06:58, 10 April 2023</u>		667 × 589 (27 KB)	<a href="#">Dl6rai (talk   contribs)</a>	
	<u>16:28, 30 October 2016</u>		663 × 601 (28 KB)	<a href="#">Dl6rai (talk   contribs)</a>	
	<u>20:26, 4 October 2009</u>		688 × 456 (17 KB)	<a href="#">Dl6rai (talk   contribs)</a>	
	<u>01:59, 15 February 2009</u>		674 × 359 (17 KB)	<a href="#">N6TV (talk   contribs)</a>	Main logging window options.

You cannot overwrite this file.

## File usage

The following page uses this file:

- [Menu:Options](#)

## Metadata

This file contains additional information, probably added from the digital camera or scanner used to create or digitize it.

If the file has been modified from its original state, some details may not fully reflect the modified file.

**Horizontal resolution** 37.79 dpc

**Vertical resolution** 37.79 dpc

## Namespaces

- [File](#)
- [Discussion](#)

## Variants

## Views

- [Read](#)
- [View source](#)
- [View history](#)

## More

- This page was last edited on 10 April 2023, at 06:58.

- [Privacy policy](#)
- [About Win-Test Wiki](#)
- [Disclaimers](#)

- The logo for MediaWiki, featuring a sun icon and the text "Powered By MediaWiki".

# File:OptionsLogNewContestFileProperties.PNG

From Win-Test Wiki

[Jump to navigation](#) [Jump to search](#)

- [File](#)
- [File history](#)
- [File usage](#)

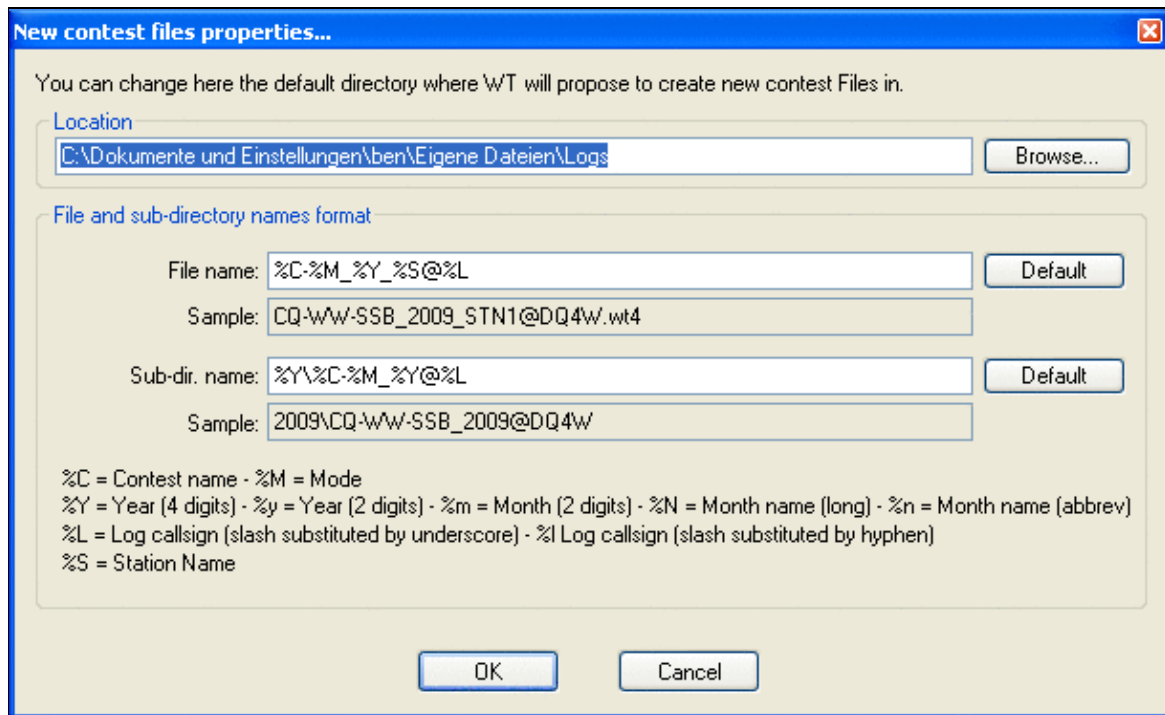

No higher resolution available.

[OptionsLogNewContestFileProperties.PNG](#) (608 × 372 pixels, file size: 18 KB, MIME type: image.gif)

## File history

Click on a date/time to view the file as it appeared at that time.

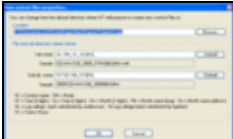
Date/Time	Thumbnail	Dimensions	User	Comment
current <a href="#">20:17, 4 October 2009</a>		608 × 372 (18 KB)	<a href="#">Dl6rai</a> ( <a href="#">talk</a>   <a href="#">contribs</a> )	

You cannot overwrite this file.

## File usage

The following page uses this file:

- [Menu:Options](#)

## Namespaces

- [File](#)
- [Discussion](#)

## Variants

## Views

- [Read](#)
- [View source](#)
- [View history](#)

## More

- This page was last edited on 4 October 2009, at 20:17.

- [Privacy policy](#)
- [About Win-Test Wiki](#)
- [Disclaimers](#)





# File:OptionsLogNewContestFileProperties.PNG

From Win-Test Wiki

[Jump to navigation](#) [Jump to search](#)

- [File](#)
- [File history](#)
- [File usage](#)

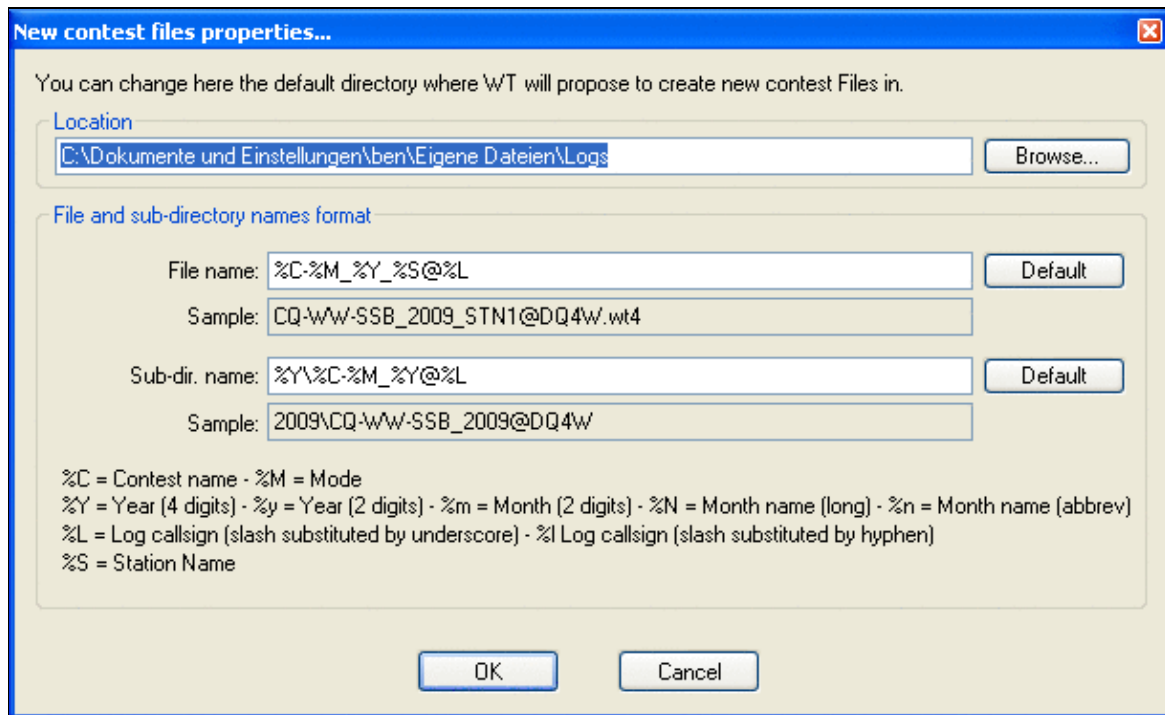

No higher resolution available.

[OptionsLogNewContestFileProperties.PNG](#) (608 × 372 pixels, file size: 18 KB, MIME type: image.gif)

## File history

Click on a date/time to view the file as it appeared at that time.

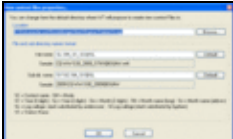
Date/Time	Thumbnail	Dimensions	User	Comment
current <a href="#">20:17, 4 October 2009</a>		608 × 372 (18 KB)	<a href="#">Dl6rai</a> ( <a href="#">talk</a>   <a href="#">contribs</a> )	

You cannot overwrite this file.

## File usage

The following page uses this file:

- [Menu:Options](#)

## Namespaces

- [File](#)
- [Discussion](#)

## Variants

## Views

- [Read](#)
- [View source](#)
- [View history](#)

## More

- This page was last edited on 4 October 2009, at 20:17.

- [Privacy policy](#)
- [About Win-Test Wiki](#)
- [Disclaimers](#)



# File:OptionsMP3Configuration.PNG

From Win-Test Wiki

[Jump to navigation](#) [Jump to search](#)

- [File](#)
- [File history](#)
- [File usage](#)
- [Metadata](#)

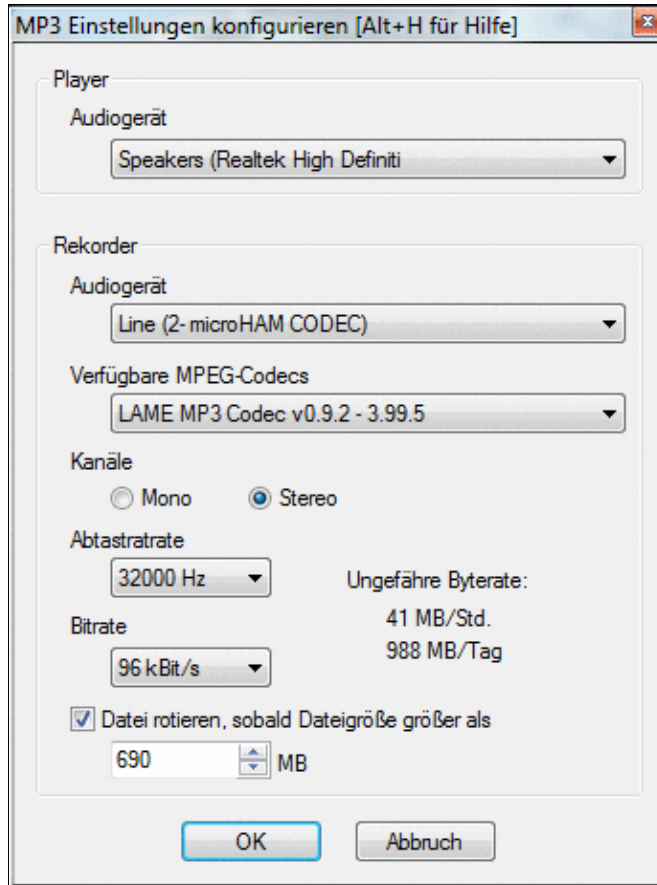



No higher resolution available.

[OptionsMP3Configuration.PNG](#) (344 × 463 pixels, file size: 25 KB, MIME type: image/gif)

## File history

Click on a date/time to view the file as it appeared at that time.

	Date/Time	Thumbnail	Dimensions	User	Comment
current	<u><a href="#">09:49, 13 November 2020</a></u>		344 × 463 (25 KB)	<u><a href="#">Dl6rai</a></u> ( <a href="#">talk</a>   <a href="#">contribs</a> )	
	<u><a href="#">21:23, 2 August 2009</a></u>		344 × 461 (11 KB)	<u><a href="#">DL4NER</a></u> ( <a href="#">talk</a>   <a href="#">contribs</a> )	

You cannot overwrite this file.

## File usage

The following page uses this file:

- [Menu:Options](#)

## Metadata

This file contains additional information, probably added from the digital camera or scanner used to create or digitize it.

If the file has been modified from its original state, some details may not fully reflect the modified file.

**Horizontal resolution** 37.79 dpc

**Vertical resolution** 37.79 dpc

## Namespaces

- [File](#)
- [Discussion](#)

## Variants

## Views

- [Read](#)
- [View source](#)
- [View history](#)

## More

- This page was last edited on 13 November 2020, at 09:49.

- [Privacy policy](#)
- [About Win-Test Wiki](#)
- [Disclaimers](#)



# File:OptionsRttyAdditionalMessages.PNG

From Win-Test Wiki

[Jump to navigation](#) [Jump to search](#)

- [File](#)
- [File history](#)
- [File usage](#)

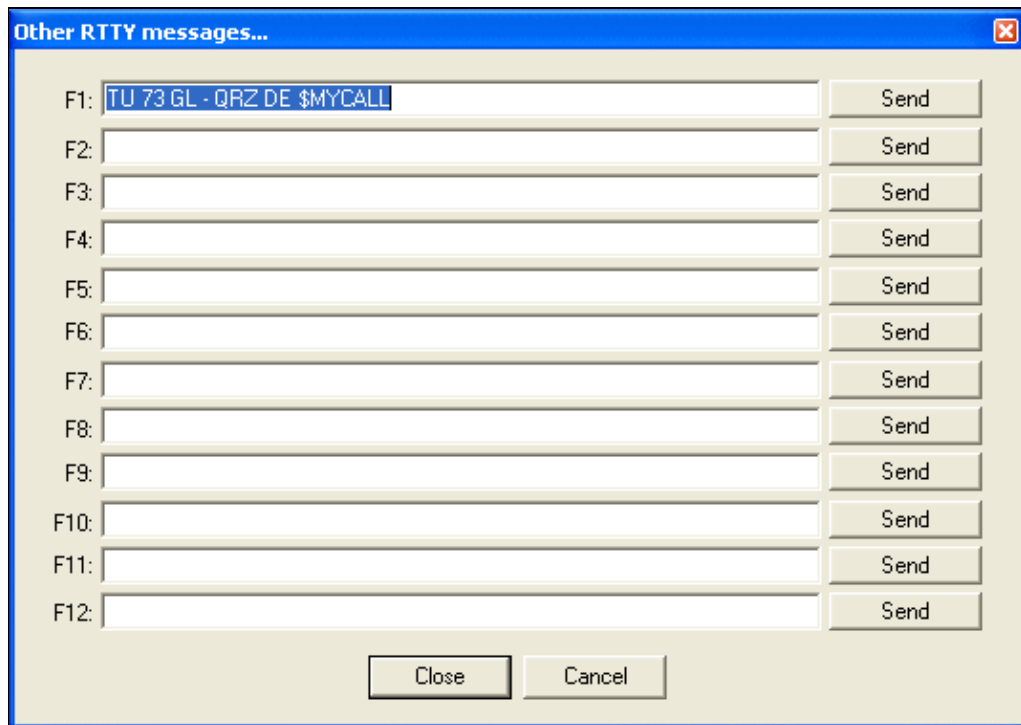

No higher resolution available.

[OptionsRttyAdditionalMessages.PNG](#) (533 × 377 pixels, file size: 11 KB, MIME type: image.gif)

## File history

Click on a date/time to view the file as it appeared at that time.

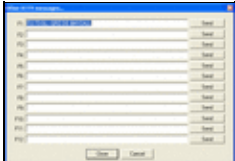
	Date/Time	Thumbnail	Dimensions	User	Comment
current	<a href="#">09:11, 21 January 2007</a>		533 × 377 (11 KB)	<a href="#">Dl6rai</a> ( <a href="#">talk</a>   <a href="#">contribs</a> )	

You cannot overwrite this file.

## File usage

The following page uses this file:

File:OptionsRttyAdditionalMessages.PNG

- [Menu:Options](#)

## Namespaces

- [File](#)
- [Discussion](#)

## Variants

## Views

- [Read](#)
- [View source](#)
- [View history](#)

## More

- This page was last edited on 21 January 2007, at 09:11.

- [Privacy policy](#)
- [About Win-Test Wiki](#)
- [Disclaimers](#)



# File:OptionsRttyAdditionalMessages.PNG

From Win-Test Wiki

[Jump to navigation](#) [Jump to search](#)

- [File](#)
- [File history](#)
- [File usage](#)

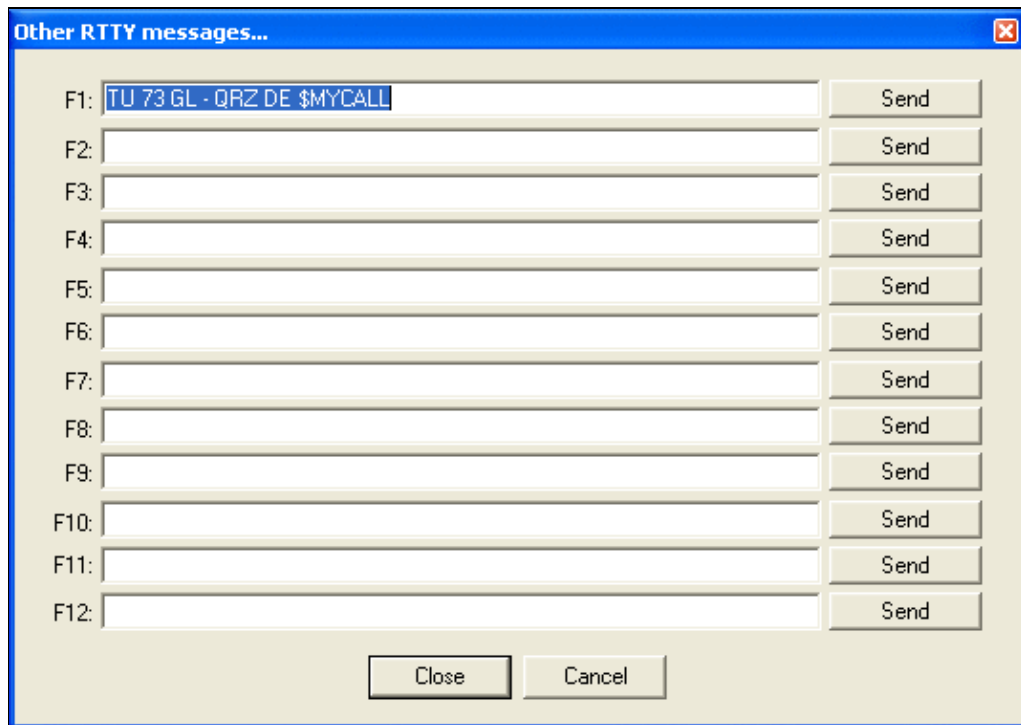

No higher resolution available.

[OptionsRttyAdditionalMessages.PNG](#) (533 × 377 pixels, file size: 11 KB, MIME type: image.gif)

## File history

Click on a date/time to view the file as it appeared at that time.

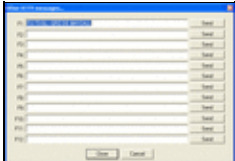
	Date/Time	Thumbnail	Dimensions	User	Comment
current	<a href="#">09:11, 21 January 2007</a>		533 × 377 (11 KB)	<a href="#">Dl6rai</a> ( <a href="#">talk</a>   <a href="#">contribs</a> )	

You cannot overwrite this file.

## File usage

The following page uses this file:

File:OptionsRttyAdditionalMessages.PNG



- [Menu:Options](#)

## Namespaces

- [File](#)
- [Discussion](#)

## Variants

## Views

- [Read](#)
- [View source](#)
- [View history](#)

## More

- This page was last edited on 21 January 2007, at 09:11.

- [Privacy policy](#)
- [About Win-Test Wiki](#)
- [Disclaimers](#)



# File:OptionsRttyConfiguration.PNG

From Win-Test Wiki

[Jump to navigation](#) [Jump to search](#)

- [File](#)
- [File history](#)
- [File usage](#)

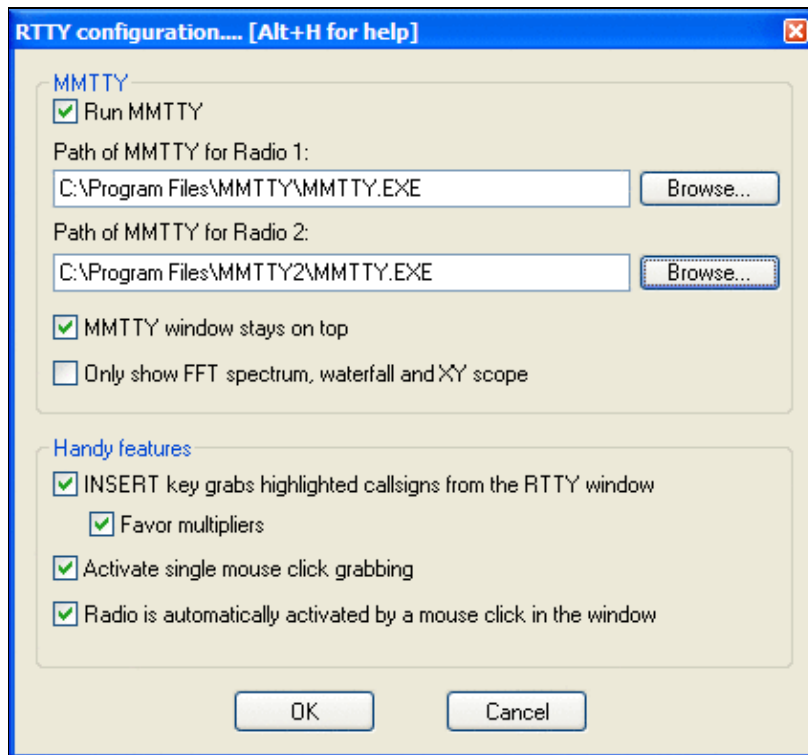

No higher resolution available.

OptionsRttyConfiguration.PNG (423 × 393 pixels, file size: 15 KB, MIME type: image/gif)

## File history

Click on a date/time to view the file as it appeared at that time.

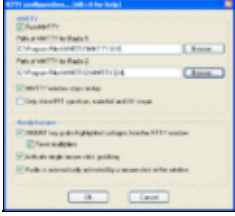
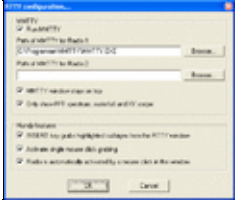
Date/Time	Thumbnail	Dimensions	User	Comment
<a href="#">19:18, 6 September 2009</a> current		423 × 393 (15 KB)	<a href="#">N6TV</a> ( <a href="#">talk</a>   <a href="#">contribs</a> )	Update shows common paths to two copies of MMTTY, and new sub-option for INSERT key.
<a href="#">09:00, 21 January 2007</a>		423 × 367 (12 KB)	<a href="#">D16rai</a> ( <a href="#">talk</a>   <a href="#">contribs</a> )	

You cannot overwrite this file.

## File usage

The following 2 pages use this file:

- [Menu:Options](#)
- [RTTY](#)

## Namespaces

- [File](#)
- [Discussion](#)

## Variants

## Views

- [Read](#)
- [View source](#)
- [View history](#)

## More

- This page was last edited on 21 January 2007, at 09:00.
- [Privacy policy](#)
- [About Win-Test Wiki](#)

- Disclaimers



# File:OptionsRttyStandardMessages.PNG

From Win-Test Wiki

[Jump to navigation](#) [Jump to search](#)

- [File](#)
- [File history](#)
- [File usage](#)

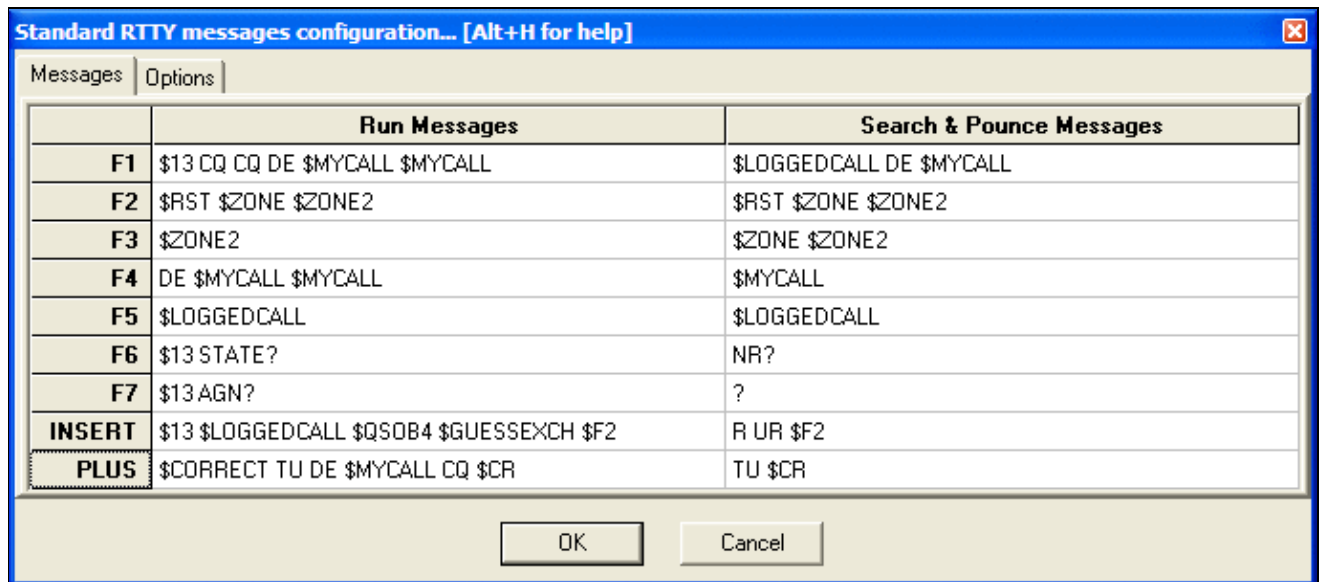

No higher resolution available.

[OptionsRttyStandardMessages.PNG](#) (684 × 302 pixels, file size: 15 KB, MIME type: image.gif)

## File history

Click on a date/time to view the file as it appeared at that time.

	Date/Time	Thumbnail	Dimensions	User	Comment
current	<a href="#">00:34, 10 November 2008</a>		684 × 302 (15 KB)	<a href="#">N6TV</a> ( <a href="#">talk</a>   <a href="#">contribs</a> )	Updated version (has new Options Tab)
	<a href="#">09:10, 21 January 2007</a>		545 × 365 (13 KB)	<a href="#">Dl6rai</a> ( <a href="#">talk</a>   <a href="#">contribs</a> )	

You cannot overwrite this file.

## File usage

The following page uses this file:

- [Menu:Options](#)

## Namespaces

- [File](#)
- [Discussion](#)

## Variants

## Views

- [Read](#)
- [View source](#)
- [View history](#)

## More

- This page was last edited on 21 January 2007, at 09:10.

- [Privacy policy](#)
- [About Win-Test Wiki](#)
- [Disclaimers](#)



# File:OptionsRttyStandardMessages.PNG

From Win-Test Wiki

[Jump to navigation](#) [Jump to search](#)

- [File](#)
- [File history](#)
- [File usage](#)

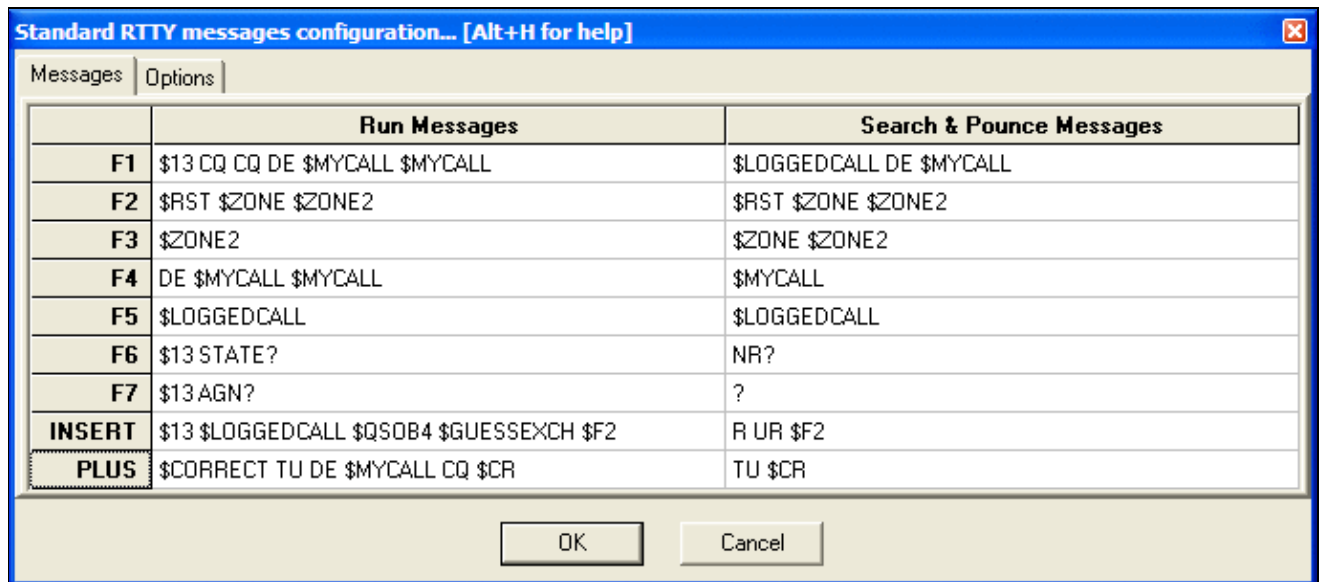

No higher resolution available.

[OptionsRttyStandardMessages.PNG](#) (684 × 302 pixels, file size: 15 KB, MIME type: image.gif)

## File history

Click on a date/time to view the file as it appeared at that time.

	Date/Time	Thumbnail	Dimensions	User	Comment
current	<a href="#">00:34, 10 November 2008</a>		684 × 302 (15 KB)	<a href="#">N6TV</a> ( <a href="#">talk</a>   <a href="#">contribs</a> )	Updated version (has new Options Tab)
	<a href="#">09:10, 21 January 2007</a>		545 × 365 (13 KB)	<a href="#">Dl6rai</a> ( <a href="#">talk</a>   <a href="#">contribs</a> )	

You cannot overwrite this file.

## File usage

The following page uses this file:

- [Menu:Options](#)

## Namespaces

- [File](#)
- [Discussion](#)

## Variants

## Views

- [Read](#)
- [View source](#)
- [View history](#)

## More

- This page was last edited on 21 January 2007, at 09:10.

- [Privacy policy](#)
- [About Win-Test Wiki](#)
- [Disclaimers](#)





# File:OptionsScriptEditorConfiguration.PNG

From Win-Test Wiki

[Jump to navigation](#) [Jump to search](#)

- [File](#)
- [File history](#)
- [File usage](#)

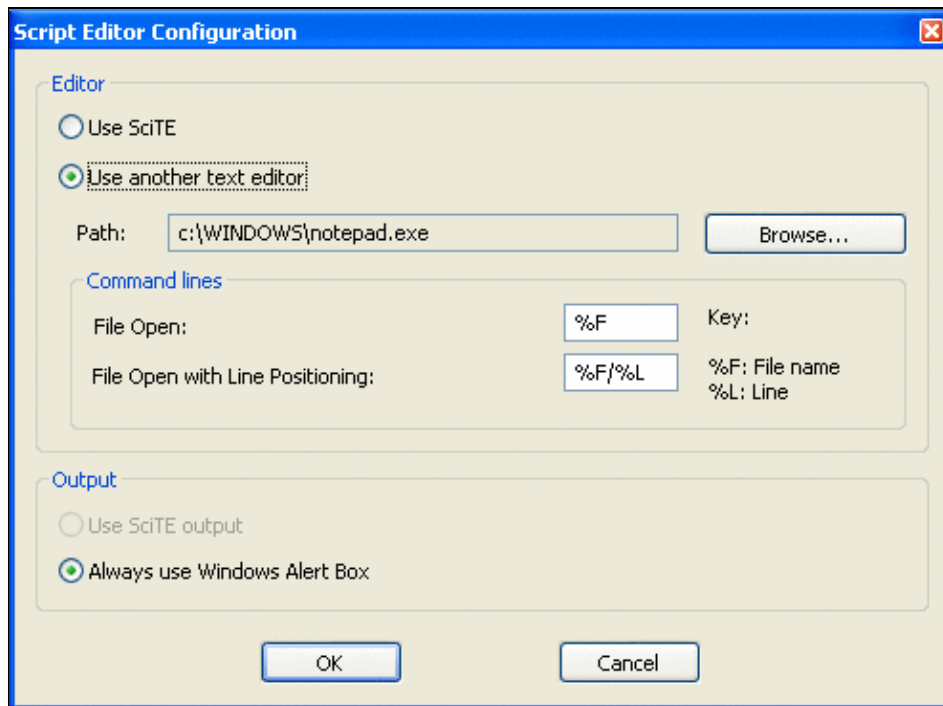

No higher resolution available.

[OptionsScriptEditorConfiguration.PNG](#) (494 × 367 pixels, file size: 13 KB, MIME type: image.gif)

## File history

Click on a date/time to view the file as it appeared at that time.

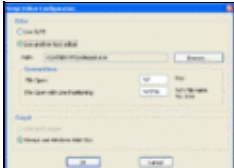
Date/Time	Thumbnail	Dimensions	User	Comment
current <a href="#">17:53, 4 October 2009</a>		494 × 367 (13 KB)	<a href="#">Dl6rai</a> ( <a href="#">talk</a>   <a href="#">contribs</a> )	

You cannot overwrite this file.

## File usage

The following page uses this file:

File:OptionsScriptEditorConfiguration.PNG

1525

- [Menu:Options](#)

## Namespaces

- [File](#)
- [Discussion](#)

## Variants

## Views

- [Read](#)
- [View source](#)
- [View history](#)

## More

- This page was last edited on 4 October 2009, at 17:53.

- [Privacy policy](#)
- [About Win-Test Wiki](#)
- [Disclaimers](#)



# File:OptionsStartStopWtDxTelnet.gif

From Win-Test Wiki

[Jump to navigation](#) [Jump to search](#)

- [File](#)
- [File history](#)
- [File usage](#)

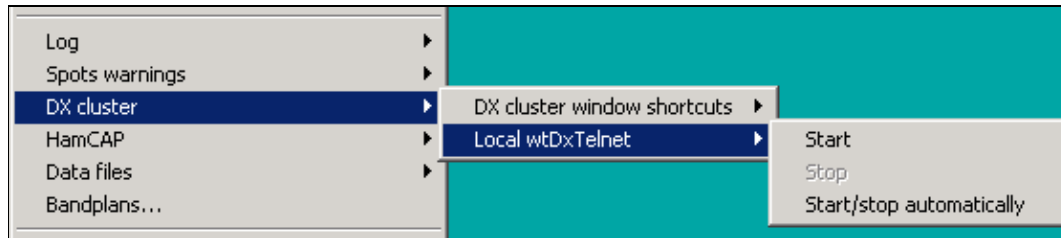

No higher resolution available.

[OptionsStartStopWtDxTelnet.gif](#) (556 × 121 pixels, file size: 3 KB, MIME type: image/gif)

## File history

Click on a date/time to view the file as it appeared at that time.

	Date/Time	Thumbnail	Dimensions	User	Comment
current	<a href="#">11:49, 10 October 2006</a>		556 × 121 (3 KB)	<a href="#">Dl6rai</a> ( <a href="#">talk</a>   <a href="#">contribs</a> )	

You cannot overwrite this file.

## File usage

The following page uses this file:

- [Menu:Options](#)

## Namespaces

- [File](#)
- [Discussion](#)

## Variants

## Views

- [Read](#)
- [View source](#)
- [View history](#)

## More

- This page was last edited on 10 October 2006, at 11:49.

- [Privacy policy](#)
- [About Win-Test Wiki](#)
- [Disclaimers](#)



# File:OptionsStartStopWtDxTelnet.gif

From Win-Test Wiki

[Jump to navigation](#) [Jump to search](#)

- [File](#)
- [File history](#)
- [File usage](#)

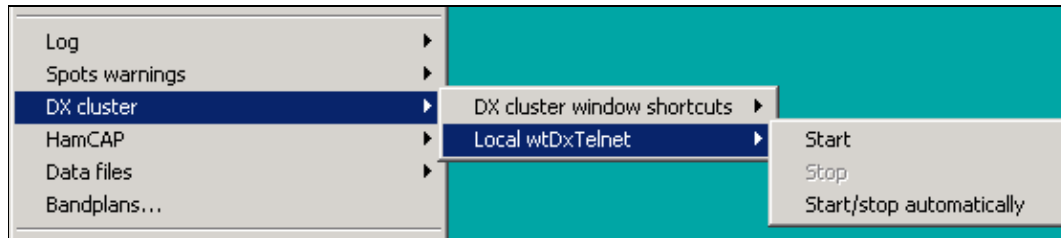

No higher resolution available.

[OptionsStartStopWtDxTelnet.gif](#) (556 × 121 pixels, file size: 3 KB, MIME type: image/gif)

## File history

Click on a date/time to view the file as it appeared at that time.

	Date/Time	Thumbnail	Dimensions	User	Comment
current	<a href="#">11:49, 10 October 2006</a>		556 × 121 (3 KB)	<a href="#">Dl6rai</a> ( <a href="#">talk</a>   <a href="#">contribs</a> )	

You cannot overwrite this file.

## File usage

The following page uses this file:

- [Menu:Options](#)

## Namespaces

- [File](#)
- [Discussion](#)

## Variants

## Views

- [Read](#)
- [View source](#)
- [View history](#)

## More

- This page was last edited on 10 October 2006, at 11:49.

- [Privacy policy](#)
- [About Win-Test Wiki](#)
- [Disclaimers](#)



# File:OptionsWindowsMenu.gif

From Win-Test Wiki

[Jump to navigation](#) [Jump to search](#)

- [File](#)
- [File history](#)
- [File usage](#)

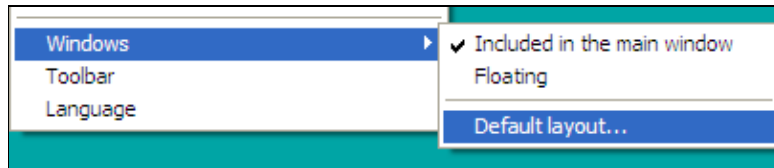

No higher resolution available.

[OptionsWindowsMenu.gif](#) (405 × 85 pixels, file size: 3 KB, MIME type: image/gif)

Shows the sub-options of the Options | Windows menu item

## File history

Click on a date/time to view the file as it appeared at that time.

	Date/Time	Thumbnail	Dimensions	User	Comment
current	<a href="#">22:47, 1 June 2008</a>		405 × 85 (3 KB)	<a href="#">N6TV</a> ( <a href="#">talk</a>   <a href="#">contribs</a> )	Shows the sub-options of the Options   Windows menu item

You cannot overwrite this file.

## File usage

The following page uses this file:

- [Menu:Options](#)

## Namespaces

- [File](#)
- [Discussion](#)

## Variants

## Views

- [Read](#)
- [View source](#)
- [View history](#)

## More

- This page was last edited on 1 June 2008, at 22:47.

- [Privacy policy](#)
- [About Win-Test Wiki](#)
- [Disclaimers](#)





# File:OptionsWindowsMenu.gif

From Win-Test Wiki

[Jump to navigation](#) [Jump to search](#)

- [File](#)
- [File history](#)
- [File usage](#)

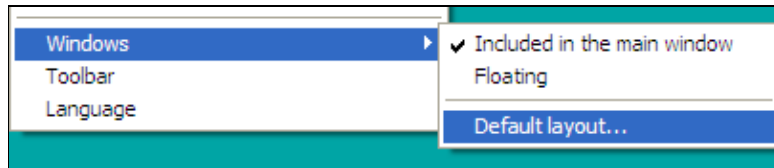

No higher resolution available.

[OptionsWindowsMenu.gif](#) (405 × 85 pixels, file size: 3 KB, MIME type: image/gif)

Shows the sub-options of the Options | Windows menu item

## File history

Click on a date/time to view the file as it appeared at that time.

	Date/Time	Thumbnail	Dimensions	User	Comment
current	<a href="#">22:47, 1 June 2008</a>		405 × 85 (3 KB)	<a href="#">N6TV</a> ( <a href="#">talk</a>   <a href="#">contribs</a> )	Shows the sub-options of the Options   Windows menu item

You cannot overwrite this file.

## File usage

The following page uses this file:

- [Menu:Options](#)

## Namespaces

- [File](#)
- [Discussion](#)

## Variants

## Views

- [Read](#)
- [View source](#)
- [View history](#)

## More

- This page was last edited on 1 June 2008, at 22:47.

- [Privacy policy](#)
- [About Win-Test Wiki](#)
- [Disclaimers](#)



# File:OTSRP.PNG

From Win-Test Wiki

[Jump to navigation](#) [Jump to search](#)

- [File](#)
- [File history](#)
- [File usage](#)

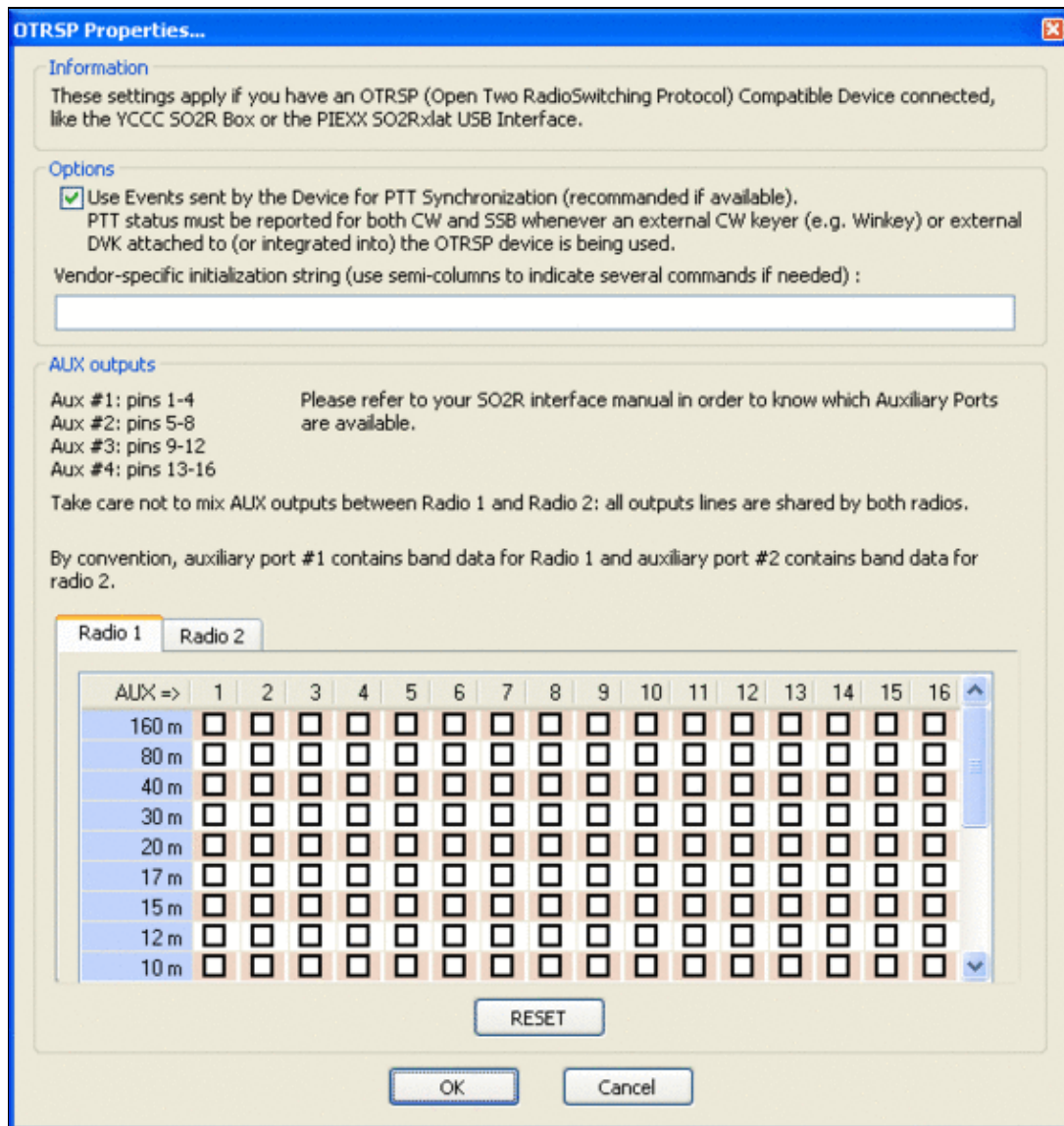

Size of this preview: 568 Å 599 pixels. Other resolutions: 227 Å 240 pixels | 599 Å 632 pixels.  
[Original file](#) (599 Å 632 pixels, file size: 28 KB, MIME type: image.gif)

## File history

Click on a date/time to view the file as it appeared at that time.

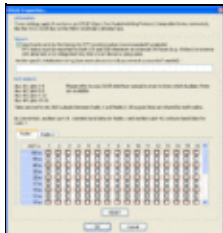
	Date/Time	Thumbnail	Dimensions	User	Comment
current	<u>07:58, 30 December 2010</u>		599 Å 632 (28 KB)	<a href="#">Dl6rai</a> ( <a href="#">talk</a>   <a href="#">contribs</a> )	

You cannot overwrite this file.

## File usage

The following page uses this file:

- [Menu:Options](#)

## Namespaces

- [File](#)
- [Discussion](#)

## Variants

## Views

- [Read](#)
- [View source](#)
- [View history](#)

## More

- This page was last edited on 30 December 2010, at 07:58.
- [Privacy policy](#)
- [About Win-Test Wiki](#)
- [Disclaimers](#)



# File:OTSRP.PNG

From Win-Test Wiki

[Jump to navigation](#) [Jump to search](#)

- [File](#)
- [File history](#)
- [File usage](#)

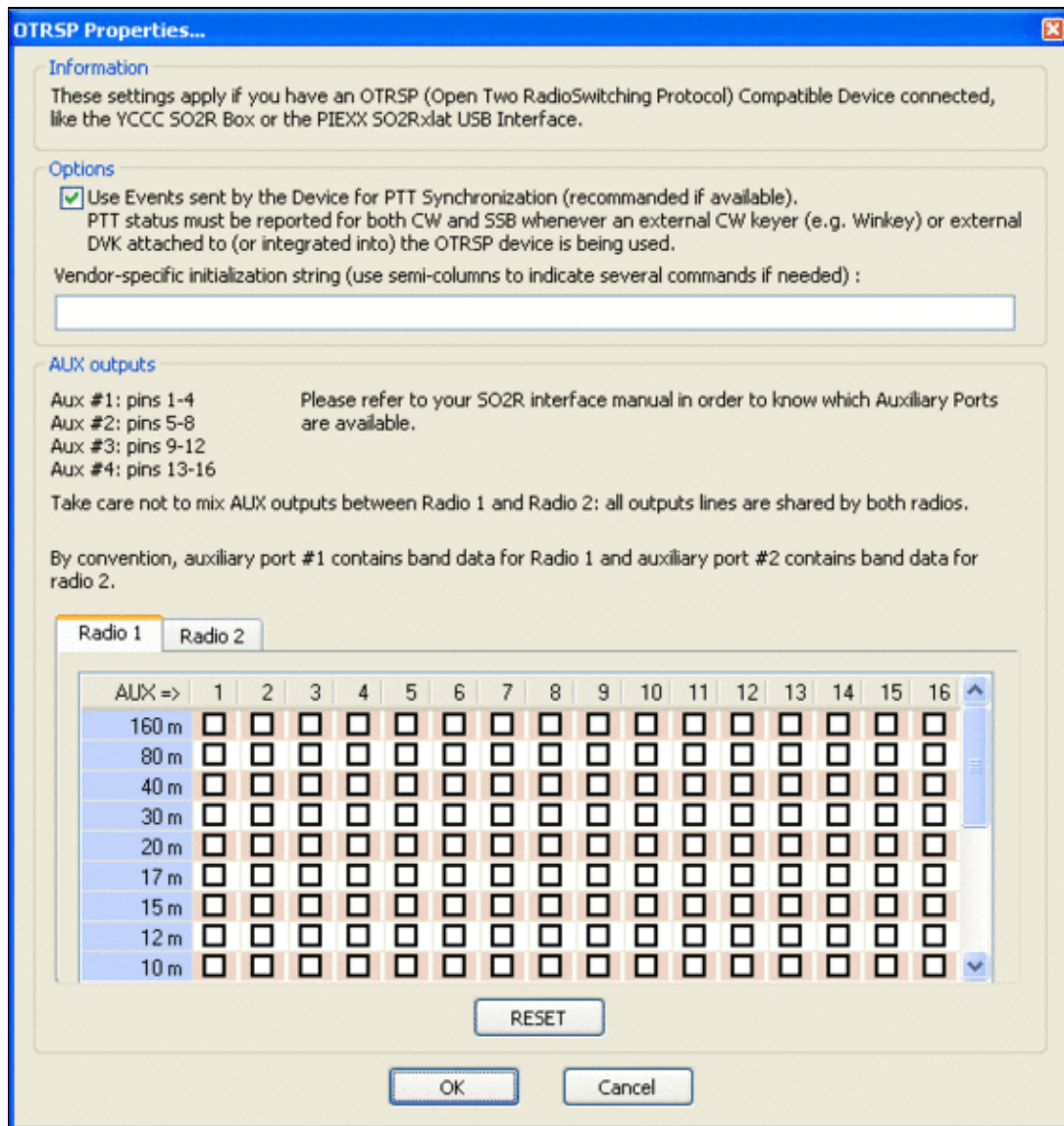

Size of this preview: 568 Å 599 pixels. Other resolutions: 227 Å 240 pixels | 599 Å 632 pixels.  
[Original file](#) (599 Å 632 pixels, file size: 28 KB, MIME type: image.gif)

## File history

Click on a date/time to view the file as it appeared at that time.

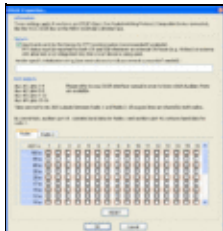
	Date/Time	Thumbnail	Dimensions	User	Comment
current	<u>07:58, 30 December 2010</u>		599 Å 632 (28 KB)	<a href="#">Dl6rai</a> ( <a href="#">talk</a>   <a href="#">contribs</a> )	

You cannot overwrite this file.

## File usage

The following page uses this file:

- [Menu:Options](#)

## Namespaces

- [File](#)
- [Discussion](#)

## Variants

## Views

- [Read](#)
- [View source](#)
- [View history](#)

## More

- This page was last edited on 30 December 2010, at 07:58.
- [Privacy policy](#)
- [About Win-Test Wiki](#)
- [Disclaimers](#)



# File:PartnerWindow.gif

From Win-Test Wiki

[Jump to navigation](#) [Jump to search](#)

- [File](#)
- [File history](#)
- [File usage](#)





No higher resolution available.

[PartnerWindow.gif](#) (148 Å 159 pixels, file size: 2 KB, MIME type: image/gif)

## File history

Click on a date/time to view the file as it appeared at that time.

	Date/Time	Thumbnail	Dimensions	User	Comment
current	<a href="#">21:33, 11 September 2006</a>		148 Å 159 (2 KB)	<a href="#">Dl6rai</a> ( <a href="#">talk</a>   <a href="#">contribs</a> )	
	<a href="#">21:22, 11 September 2006</a>		148 Å 159 (24 KB)	<a href="#">Dl6rai</a> ( <a href="#">talk</a>   <a href="#">contribs</a> )	

You cannot overwrite this file.

## File usage

The following page uses this file:

- [Menu:Windows](#)

## Namespaces

- [File](#)
- [Discussion](#)

## Variants

## Views

- [Read](#)
- [View source](#)
- [View history](#)

## More

- This page was last edited on 11 September 2006, at 21:22.
- [Privacy policy](#)
- [About Win-Test Wiki](#)
- [Disclaimers](#)





# File:PartnerWindow.gif

From Win-Test Wiki

[Jump to navigation](#) [Jump to search](#)

- [File](#)
- [File history](#)
- [File usage](#)



No higher resolution available.

[PartnerWindow.gif](#) (148 Å 159 pixels, file size: 2 KB, MIME type: image/gif)

## File history

Click on a date/time to view the file as it appeared at that time.

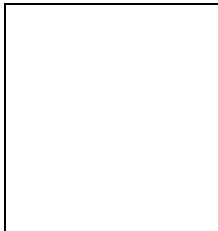
	Date/Time	Thumbnail	Dimensions	User	Comment
current	<a href="#">21:33, 11 September 2006</a>		148 Å 159 (2 KB)	<a href="#">Dl6rai</a> ( <a href="#">talk</a>   <a href="#">contribs</a> )	
	<a href="#">21:22, 11 September 2006</a>		148 Å 159 (24 KB)	<a href="#">Dl6rai</a> ( <a href="#">talk</a>   <a href="#">contribs</a> )	

You cannot overwrite this file.

## File usage

The following page uses this file:

- [Menu:Windows](#)

## Namespaces

- [File](#)
- [Discussion](#)

## Variants

## Views

- [Read](#)
- [View source](#)
- [View history](#)

## More

- This page was last edited on 11 September 2006, at 21:22.
- [Privacy policy](#)
- [About Win-Test Wiki](#)
- [Disclaimers](#)



# File:passstation.gif

From Win-Test Wiki

[Jump to navigation](#) [Jump to search](#)

- [File](#)
- [File history](#)
- [File usage](#)

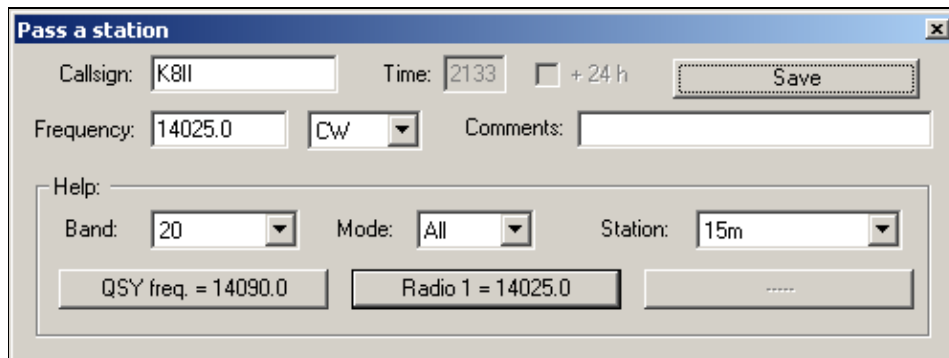

No higher resolution available.

[passstation.gif](#) (497 × 185 pixels, file size: 5 KB, MIME type: image.gif)

## File history

Click on a date/time to view the file as it appeared at that time.

	Date/Time	Thumbnail	Dimensions	User	Comment
current	<a href="#">21:34, 29 July 2006</a>		497 × 185 (5 KB)	<a href="#">DL4NER</a> ( <a href="#">talk</a>   <a href="#">contribs</a> )	

You cannot overwrite this file.

## File usage

The following page uses this file:

- [Menu:Commands](#)

## Namespaces

- [File](#)
- [Discussion](#)

## Variants

## Views

- [Read](#)
- [View source](#)
- [View history](#)

## More

- This page was last edited on 29 July 2006, at 21:34.

- [Privacy policy](#)
- [About Win-Test Wiki](#)
- [Disclaimers](#)



# File:passstation.gif

From Win-Test Wiki

[Jump to navigation](#) [Jump to search](#)

- [File](#)
- [File history](#)
- [File usage](#)

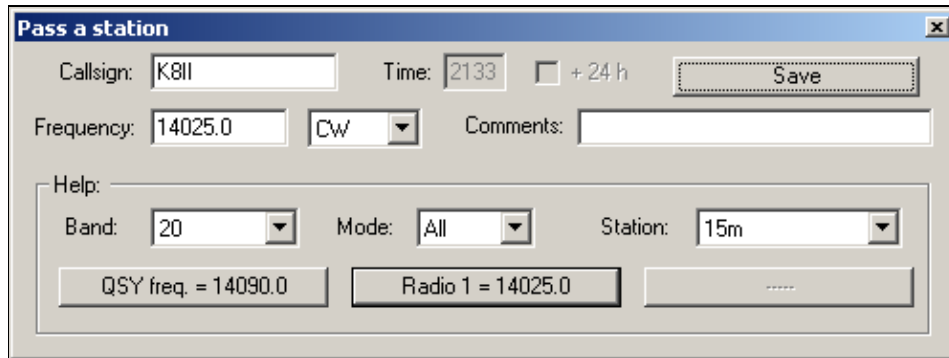

No higher resolution available.

[passstation.gif](#) (497 × 185 pixels, file size: 5 KB, MIME type: image.gif)

## File history

Click on a date/time to view the file as it appeared at that time.

	Date/Time	Thumbnail	Dimensions	User	Comment
current	<a href="#">21:34, 29 July 2006</a>		497 × 185 (5 KB)	<a href="#">DL4NER</a> ( <a href="#">talk</a>   <a href="#">contribs</a> )	

You cannot overwrite this file.

## File usage

The following page uses this file:

- [Menu:Commands](#)

## Namespaces

- [File](#)
- [Discussion](#)

## Variants

## Views

- [Read](#)
- [View source](#)
- [View history](#)

## More

- This page was last edited on 29 July 2006, at 21:34.

- [Privacy policy](#)
- [About Win-Test Wiki](#)
- [Disclaimers](#)



# File:PassStation.gif

From Win-Test Wiki

[Jump to navigation](#) [Jump to search](#)

- [File](#)
- [File history](#)
- [File usage](#)

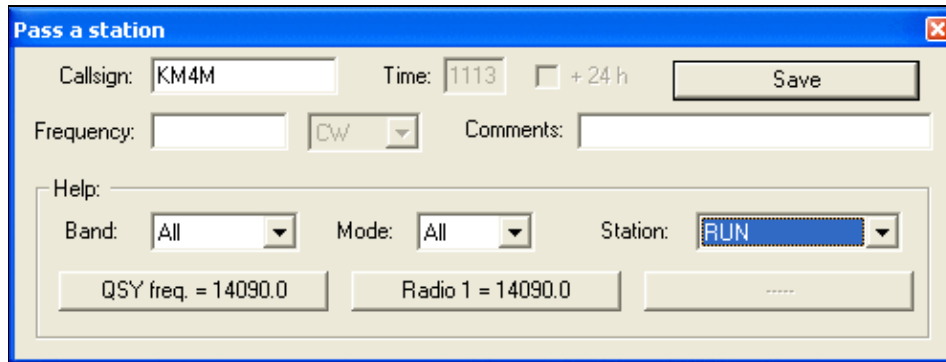

No higher resolution available.

[PassStation.gif](#) (496 × 187 pixels, file size: 8 KB, MIME type: image/gif)

'Pass a station' screenshot

## File history

Click on a date/time to view the file as it appeared at that time.

	Date/Time	Thumbnail	Dimensions	User	Comment
current	<a href="#">14:23, 5 January 2006</a>		496 × 187 (8 KB)	<a href="#">MOCLW (talk   contribs)</a>	'Pass a station' screenshot

You cannot overwrite this file.

## File usage

The following page uses this file:

- [Multi-op/Passing](#)

## Namespaces

- [File](#)
- [Discussion](#)

## Variants

## Views

- [Read](#)
- [View source](#)
- [View history](#)

## More

- This page was last edited on 5 January 2006, at 14:23.

- [Privacy policy](#)
- [About Win-Test Wiki](#)
- [Disclaimers](#)





# File:PassStation.gif

From Win-Test Wiki

[Jump to navigation](#) [Jump to search](#)

- [File](#)
- [File history](#)
- [File usage](#)

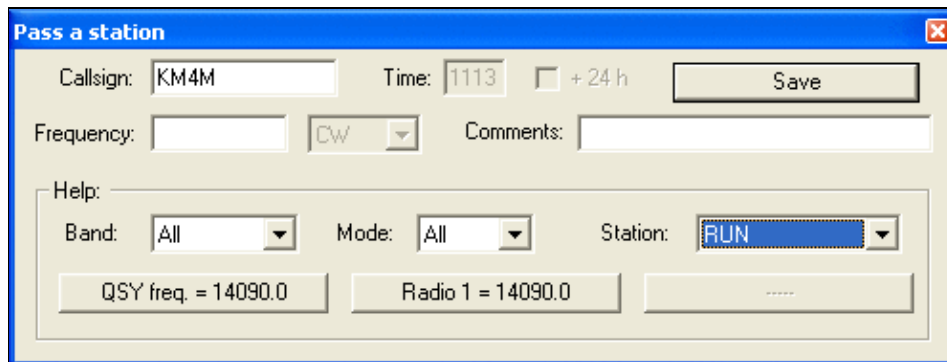

No higher resolution available.

[PassStation.gif](#) (496 × 187 pixels, file size: 8 KB, MIME type: image/gif)

'Pass a station' screenshot

## File history

Click on a date/time to view the file as it appeared at that time.

	Date/Time	Thumbnail	Dimensions	User	Comment
current	<a href="#">14:23, 5 January 2006</a>		496 × 187 (8 KB)	<a href="#">MOCLW (talk   contribs)</a>	'Pass a station' screenshot

You cannot overwrite this file.

## File usage

The following page uses this file:

- [Multi-op/Passing](#)

## Namespaces

- [File](#)
- [Discussion](#)

## Variants

## Views

- [Read](#)
- [View source](#)
- [View history](#)

## More

- This page was last edited on 5 January 2006, at 14:23.

- [Privacy policy](#)
- [About Win-Test Wiki](#)
- [Disclaimers](#)



# File:Port95NT.exe Properties.gif

From Win-Test Wiki

[Jump to navigation](#) [Jump to search](#)

- [File](#)
- [File history](#)
- [File usage](#)
- [Metadata](#)

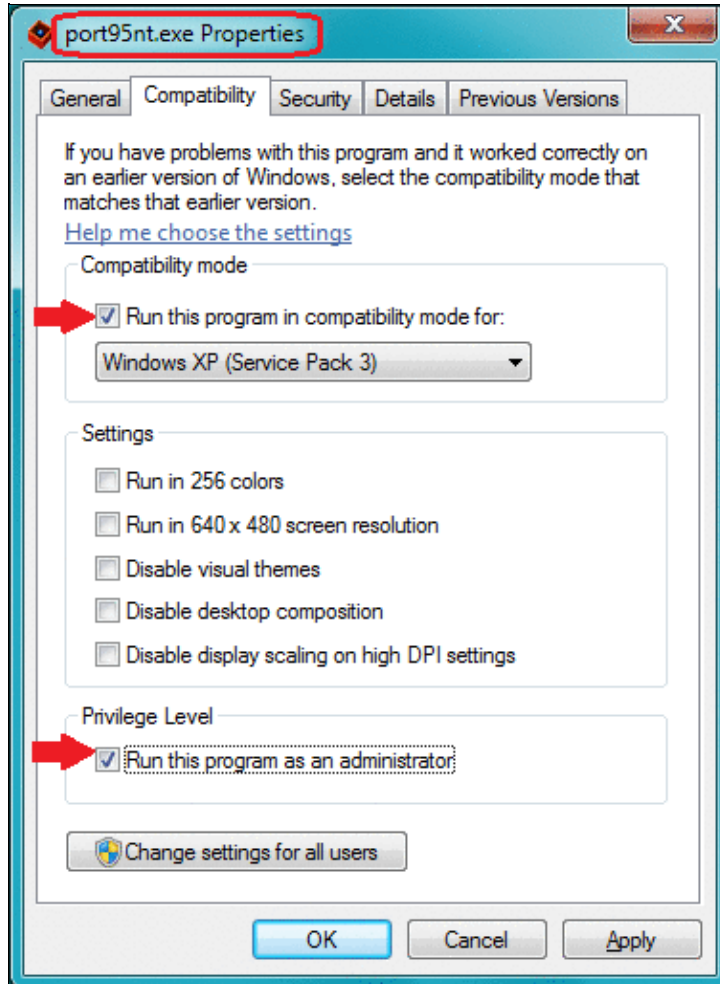

No higher resolution available.

[Port95NT.exe Properties.gif](#) (377 Å 515 pixels, file size: 37 KB, MIME type: image.gif)

Image showing how to run port95nt.exe on Windows Vista or Windows 7 (32-bit only)

## File history

Click on a date/time to view the file as it appeared at that time.

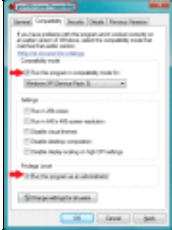
	Date/Time	Thumbnail	Dimensions	User	Comment
current	<a href="#">00:44, 12 December 2013</a>		377 Å 515 (37 KB)	<a href="#">N6TV (talk   contribs)</a>	Image showing how to run port95nt.exe on Windows Vista or Windows 7 (32-bit only)

You cannot overwrite this file.

## File usage

The following page uses this file:

- [FAQ:User Interface](#)

## Metadata

This file contains additional information, probably added from the digital camera or scanner used to create or digitize it.

If the file has been modified from its original state, some details may not fully reflect the modified file.

**Horizontal resolution** 37.79 dpc

**Vertical resolution** 37.79 dpc

## Namespaces

- [File](#)
- [Discussion](#)

## Variants

## Views

- [Read](#)
- [View source](#)
- [View history](#)

## More

- This page was last edited on 12 December 2013, at 00:44.

- [Privacy policy](#)
- [About Win-Test Wiki](#)
- [Disclaimers](#)



# File:Port95NT.exe Properties.gif

From Win-Test Wiki

[Jump to navigation](#) [Jump to search](#)

- [File](#)
- [File history](#)
- [File usage](#)
- [Metadata](#)

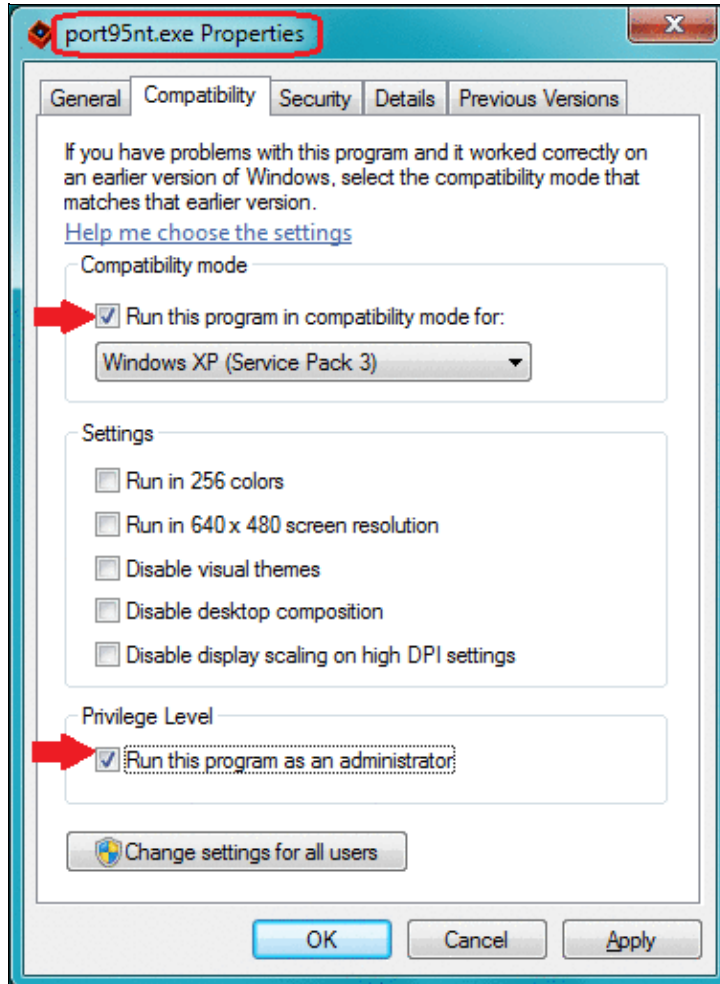

No higher resolution available.

[Port95NT.exe Properties.gif](#) (377 Å 515 pixels, file size: 37 KB, MIME type: image.gif)

Image showing how to run port95nt.exe on Windows Vista or Windows 7 (32-bit only)

## File history

Click on a date/time to view the file as it appeared at that time.

	Date/Time	Thumbnail	Dimensions	User	Comment
current	<a href="#">00:44, 12 December 2013</a>		377 Å 515 (37 KB)	<a href="#">N6TV</a> ( <a href="#">talk</a>   <a href="#">contribs</a> )	Image showing how to run port95nt.exe on Windows Vista or Windows 7 (32-bit only)

You cannot overwrite this file.

## File usage

The following page uses this file:

- [FAQ:User Interface](#)

## Metadata

This file contains additional information, probably added from the digital camera or scanner used to create or digitize it.

If the file has been modified from its original state, some details may not fully reflect the modified file.

**Horizontal resolution** 37.79 dpc

**Vertical resolution** 37.79 dpc

## Namespaces

- [File](#)
- [Discussion](#)

## Variants

## Views

- [Read](#)
- [View source](#)
- [View history](#)

## More

- This page was last edited on 12 December 2013, at 00:44.

- [Privacy policy](#)
- [About Win-Test Wiki](#)
- [Disclaimers](#)





# File:Qsy10minrun.gif

From Win-Test Wiki

[Jump to navigation](#) [Jump to search](#)

- [File](#)
- [File history](#)
- [File usage](#)

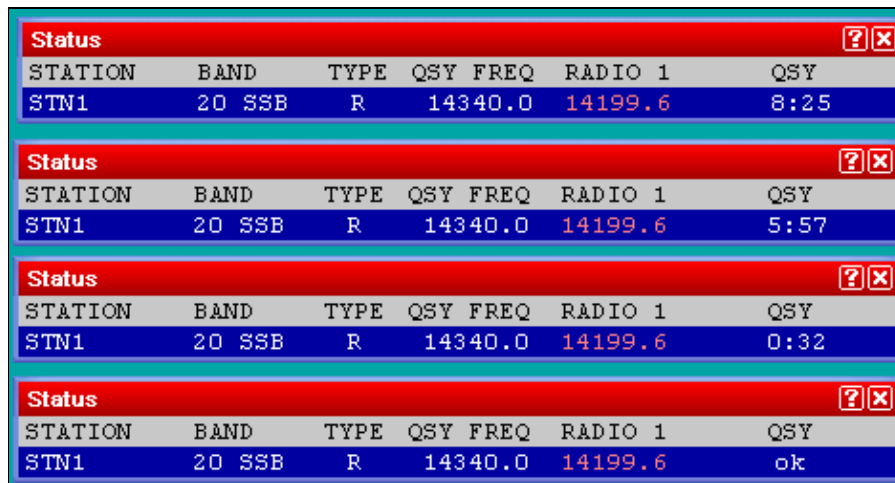

No higher resolution available.

[Qsy10minrun.gif](#) (469 × 249 pixels, file size: 10 KB, MIME type: image.gif)

qsy countdown timer

## File history

Click on a date/time to view the file as it appeared at that time.

	Date/Time	Thumbnail	Dimensions	User	Comment
current	<a href="#">13:39, 2 February 2007</a>		469 × 249 (10 KB)	<a href="#">I2WIJ</a> ( <a href="#">talk</a>   <a href="#">contribs</a> )	qsy countdown timer

You cannot overwrite this file.

## File usage

The following page uses this file:

- [Multi-op/Status window](#)

## Namespaces

- [File](#)
- [Discussion](#)

## Variants

## Views

- [Read](#)
- [View source](#)
- [View history](#)

## More

- This page was last edited on 2 February 2007, at 13:39.
- [Privacy policy](#)
- [About Win-Test Wiki](#)
- [Disclaimers](#)



# File:Qsy10minrun.gif

From Win-Test Wiki

[Jump to navigation](#) [Jump to search](#)

- [File](#)
- [File history](#)
- [File usage](#)

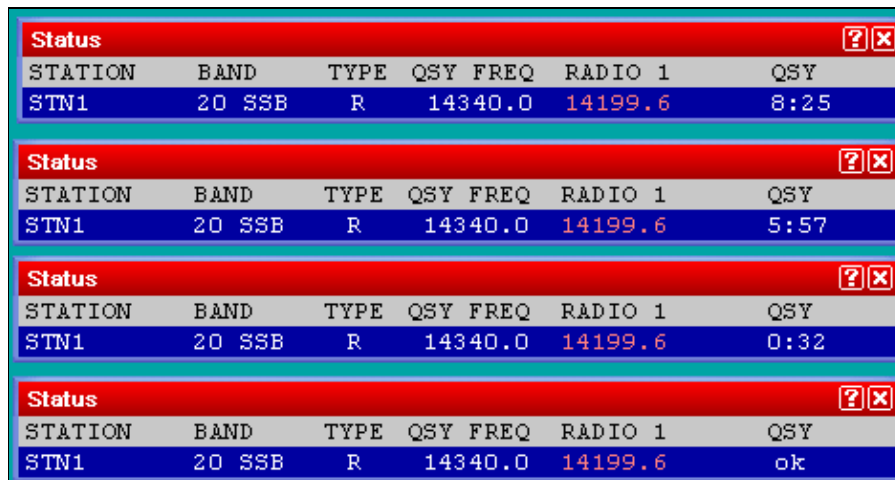

No higher resolution available.

[Qsy10minrun.gif](#) (469 × 249 pixels, file size: 10 KB, MIME type: image.gif)

qsy countdown timer

## File history

Click on a date/time to view the file as it appeared at that time.

	Date/Time	Thumbnail	Dimensions	User	Comment
current	<a href="#">13:39, 2 February 2007</a>		469 × 249 (10 KB)	<a href="#">I2WIJ</a> ( <a href="#">talk</a>   <a href="#">contribs</a> )	qsy countdown timer

You cannot overwrite this file.

## File usage

The following page uses this file:

- [Multi-op/Status window](#)

## Namespaces

- [File](#)
- [Discussion](#)

## Variants

## Views

- [Read](#)
- [View source](#)
- [View history](#)

## More

- This page was last edited on 2 February 2007, at 13:39.
- [Privacy policy](#)
- [About Win-Test Wiki](#)
- [Disclaimers](#)



# File:qsyfrequency.gif

From Win-Test Wiki

[Jump to navigation](#) [Jump to search](#)

- [File](#)
- [File history](#)
- [File usage](#)



No higher resolution available.

[qsyfrequency.gif](#) (248 × 42 pixels, file size: 2 KB, MIME type: image.gif)

## File history

Click on a date/time to view the file as it appeared at that time.

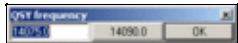
	Date/Time	Thumbnail	Dimensions	User	Comment
current	<a href="#">21:25, 29 July 2006</a>		248 × 42 (2 KB)	<a href="#">DL4NER</a> ( <a href="#">talk</a>   <a href="#">contribs</a> )	

You cannot overwrite this file.

## File usage

The following page uses this file:

- [Menu:Commands](#)

## Namespaces

- [File](#)
- [Discussion](#)

## Variants

## Views

- [Read](#)
- [View source](#)
- [View history](#)

## More

- This page was last edited on 29 July 2006, at 21:25.
- [Privacy policy](#)

## Win-Test Wiki

- [About Win-Test Wiki](#)
- [Disclaimers](#)



# File:qsyfrequency.gif

From Win-Test Wiki

[Jump to navigation](#) [Jump to search](#)

- [File](#)
- [File history](#)
- [File usage](#)



No higher resolution available.

[qsyfrequency.gif](#) (248 × 42 pixels, file size: 2 KB, MIME type: image.gif)

## File history

Click on a date/time to view the file as it appeared at that time.

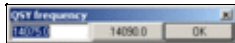
	Date/Time	Thumbnail	Dimensions	User	Comment
current	<a href="#">21:25, 29 July 2006</a>		248 × 42 (2 KB)	<a href="#">DL4NER</a> ( <a href="#">talk</a>   <a href="#">contribs</a> )	

You cannot overwrite this file.

## File usage

The following page uses this file:

- [Menu:Commands](#)

## Namespaces

- [File](#)
- [Discussion](#)

## Variants

## Views

- [Read](#)
- [View source](#)
- [View history](#)

## More

- This page was last edited on 29 July 2006, at 21:25.
- [Privacy policy](#)

- [About Win-Test Wiki](#)
- [Disclaimers](#)





# File:qtc-bandmap1.gif

From Win-Test Wiki

[Jump to navigation](#) [Jump to search](#)

- [File](#)
- [File history](#)
- [File usage](#)

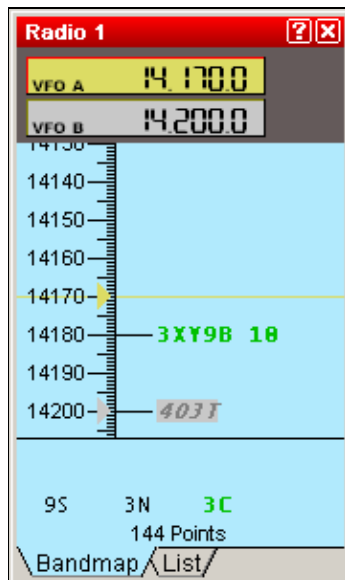

No higher resolution available.

[qtc-bandmap1.gif](#) (178 × 300 pixels, file size: 4 KB, MIME type: image/gif)

## File history

Click on a date/time to view the file as it appeared at that time.

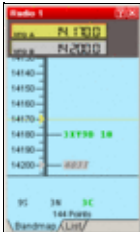
Date/Time	Thumbnail	Dimensions	User	Comment
current <a href="#">21:05, 2 August 2006</a>		178 × 300 (4 KB)	<a href="#">DL4NER</a> ( <a href="#">talk</a>   <a href="#">contribs</a> )	

You cannot overwrite this file.

## File usage

The following page uses this file:

- [WAEDC](#)

## Namespaces

- [File](#)
- [Discussion](#)

## Variants

## Views

- [Read](#)
- [View source](#)
- [View history](#)

## More

- This page was last edited on 2 August 2006, at 21:05.

- [Privacy policy](#)
- [About Win-Test Wiki](#)
- [Disclaimers](#)

- The logo for MediaWiki, featuring a sun icon and the text "Powered By MediaWiki".

# File:qtc-bandmap1.gif

From Win-Test Wiki

[Jump to navigation](#) [Jump to search](#)

- [File](#)
- [File history](#)
- [File usage](#)

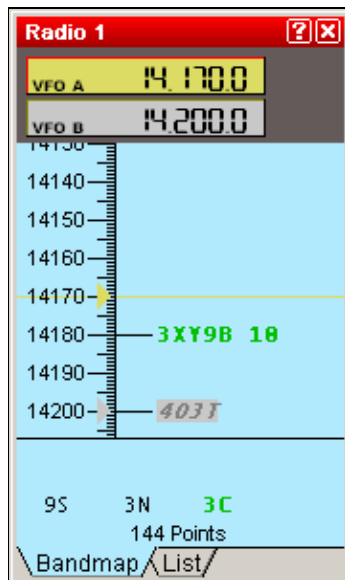

No higher resolution available.

[qtc-bandmap1.gif](#) (178 × 300 pixels, file size: 4 KB, MIME type: image/gif)

## File history

Click on a date/time to view the file as it appeared at that time.

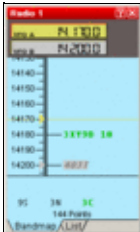
Date/Time	Thumbnail	Dimensions	User	Comment
current <a href="#">21:05, 2 August 2006</a>		178 × 300 (4 KB)	<a href="#">DL4NER</a> ( <a href="#">talk</a>   <a href="#">contribs</a> )	

You cannot overwrite this file.

## File usage

The following page uses this file:

- [WAEDC](#)

## Namespaces

- [File](#)
- [Discussion](#)

## Variants

## Views

- [Read](#)
- [View source](#)
- [View history](#)

## More

- This page was last edited on 2 August 2006, at 21:05.

- [Privacy policy](#)
- [About Win-Test Wiki](#)
- [Disclaimers](#)

- The logo for MediaWiki, featuring a sun icon and the text "Powered By MediaWiki".

# File:qtc-bandmap2.gif

From Win-Test Wiki

[Jump to navigation](#) [Jump to search](#)

- [File](#)
- [File history](#)
- [File usage](#)



No higher resolution available.

[qtc-bandmap2.gif](#) (178 × 300 pixels, file size: 4 KB, MIME type: image/gif)

## File history

Click on a date/time to view the file as it appeared at that time.

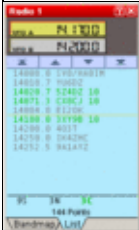
Date/Time	Thumbnail	Dimensions	User	Comment
current <a href="#">21:05, 2 August 2006</a>		178 × 300 (4 KB)	<a href="#">DL4NER</a> ( <a href="#">talk</a>   <a href="#">contribs</a> )	

You cannot overwrite this file.

## File usage

The following page uses this file:

- [WAEDC](#)

## Namespaces

- [File](#)
- [Discussion](#)

## Variants

## Views

- [Read](#)
- [View source](#)
- [View history](#)

## More

- This page was last edited on 2 August 2006, at 21:05.
- [Privacy policy](#)
- [About Win-Test Wiki](#)
- [Disclaimers](#)



# File:qtc-bandmap2.gif

From Win-Test Wiki

[Jump to navigation](#) [Jump to search](#)

- [File](#)
- [File history](#)
- [File usage](#)



No higher resolution available.

[qtc-bandmap2.gif](#) (178 Å 300 pixels, file size: 4 KB, MIME type: image/gif)

## File history

Click on a date/time to view the file as it appeared at that time.

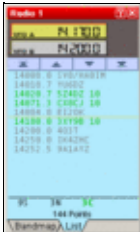
Date/Time	Thumbnail	Dimensions	User	Comment
current <a href="#">21:05, 2 August 2006</a>		178 Å 300 (4 KB)	<a href="#">DL4NER</a> ( <a href="#">talk</a>   <a href="#">contribs</a> )	

You cannot overwrite this file.

## File usage

The following page uses this file:

- [WAEDC](#)

## Namespaces

- [File](#)
- [Discussion](#)

## Variants

## Views

- [Read](#)
- [View source](#)
- [View history](#)

## More

- This page was last edited on 2 August 2006, at 21:05.

- [Privacy policy](#)
- [About Win-Test Wiki](#)
- [Disclaimers](#)

- The logo for MediaWiki, featuring a sun icon and the text "Powered By MediaWiki".



# File:qtc-rx.gif

From Win-Test Wiki

[Jump to navigation](#) [Jump to search](#)

- [File](#)
- [File history](#)
- [File usage](#)

Station: **VE3KR**

	Gr/Num	Time	Callsign	Serial
1				
2				
3				
4				
5				
6				
7				
8				
9				
10				

Space: change field (Time, Callsign, Serial)  
Tab: same as space + Gr/Num  
Ctrl+Arrows: change line or column  
Alt+K: enter keyboard mode (CW)  
Alt+F9 & Alt+F10: change speed (CW)  
Alt+L: exit without saving

F1 ... QTC?  
F2 ... QRV  
F5 ... TIME?  
F6 ... CL?  
F7 ... NR?  
F8 ... AGN  
F9 ... QSL + gr/nr  
F10 ... QSL ALL  
CR ... R & Next  
+ ... TU & Valid  
Validate

No higher resolution available.

[qtc-rx.gif](#) (450 Å 438 pixels, file size: 12 KB, MIME type: image/gif)

QTC RX window

## File history

Click on a date/time to view the file as it appeared at that time.

	Date/Time	Thumbnail	Dimensions	User	Comment
current	<a href="#">22:08, 23 July 2006</a>		450 Å 438 (12 KB)	<a href="#">Dl4ner (talk   contribs)</a>	QTC RX window

You cannot overwrite this file.

## File usage

The following page uses this file:

- [Menu:Commands](#)

## Namespaces

- [File](#)
- [Discussion](#)

## Variants

## Views

- [Read](#)
- [View source](#)
- [View history](#)

## More

- This page was last edited on 23 July 2006, at 22:08.
- [Privacy policy](#)
- [About Win-Test Wiki](#)
- [Disclaimers](#)



# File:QtcRx.gif

From Win-Test Wiki

[Jump to navigation](#) [Jump to search](#)

- [File](#)
- [File history](#)
- [File usage](#)
- [Metadata](#)

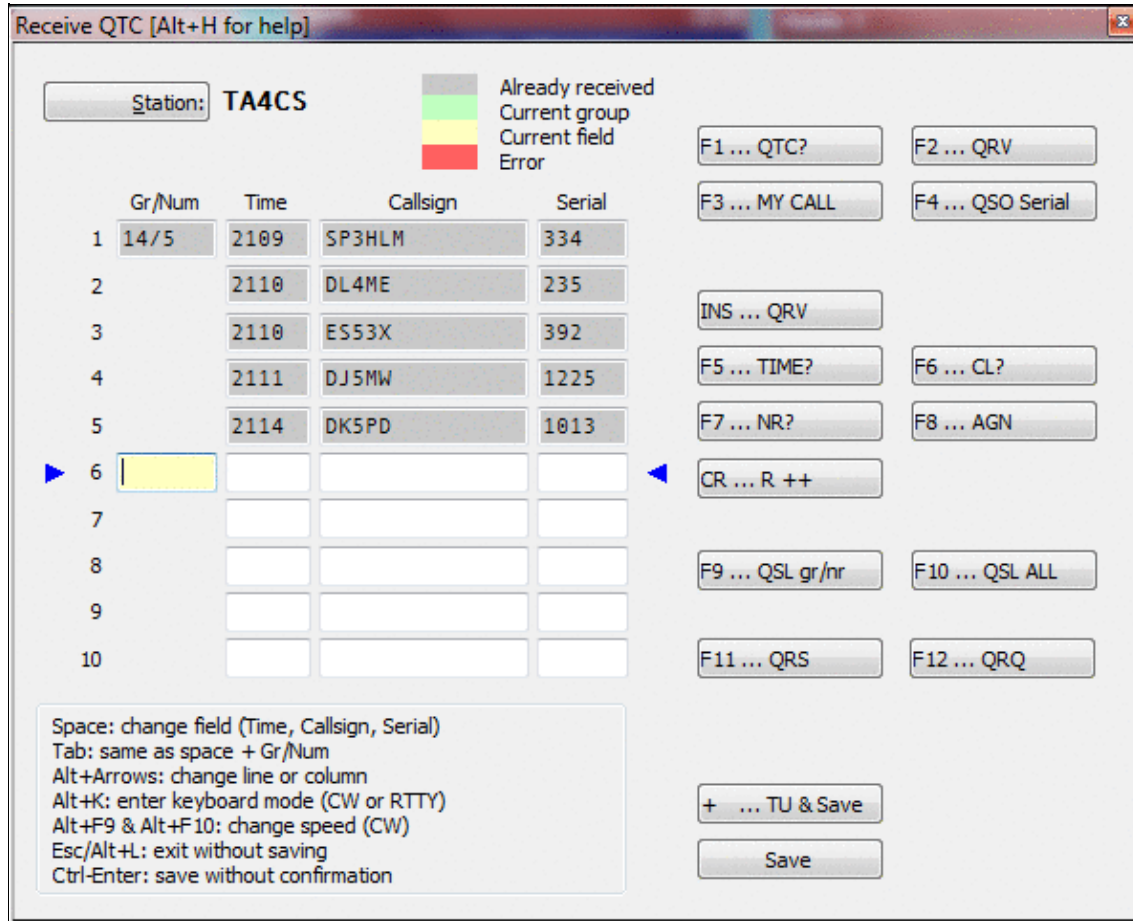



No higher resolution available.

[OtcRx.gif](#) (593 Å 481 pixels, file size: 42 KB, MIME type: image.gif)

## File history

Click on a date/time to view the file as it appeared at that time.

	Date/Time	Thumbnail	Dimensions	User	Comment
current	<a href="#">11:31, 30 December 2021</a>		593 Å 481 (42 KB)	<a href="#">Dl6rai</a> ( <a href="#">talk</a>   <a href="#">contribs</a> )	
	<a href="#">08:20, 14 August 2007</a>		471 Å 440 (16 KB)	<a href="#">Dl6rai</a> ( <a href="#">talk</a>   <a href="#">contribs</a> )	

You cannot overwrite this file.

## File usage

The following page uses this file:

- [WAEDC](#)

## Metadata

This file contains additional information, probably added from the digital camera or scanner used to create or digitize it.

If the file has been modified from its original state, some details may not fully reflect the modified file.

**Horizontal resolution** 37.79 dpc

**Vertical resolution** 37.79 dpc

## Namespaces

- [File](#)
- [Discussion](#)

## Variants

## Views

- [Read](#)
- [View source](#)

- [View history](#)

## More

- This page was last edited on 30 December 2021, at 11:31.

- [Privacy policy](#)
- [About Win-Test Wiki](#)
- [Disclaimers](#)



# File:qtc-rx.gif

From Win-Test Wiki

[Jump to navigation](#) [Jump to search](#)

- [File](#)
- [File history](#)
- [File usage](#)

Station: **VE3KR**

	Gr/Num	Time	Callsign	Serial
1				
2				
3				
4				
5				
6				
7				
8				
9				
10				

Space: change field (Time, Callsign, Serial)  
Tab: same as space + Gr/Num  
Ctrl+Arrows: change line or column  
Alt+K: enter keyboard mode (CW)  
Alt+F9 & Alt+F10: change speed (CW)  
Alt+L: exit without saving

F1 ... QTC?  
F2 ... QRV  
F5 ... TIME?  
F6 ... CL?  
F7 ... NR?  
F8 ... AGN  
F9 ... QSL + gr/nr  
F10 ... QSL ALL  
CR ... R & Next  
+ ... TU & Valid  
Validate

No higher resolution available.

[qtc-rx.gif](#) (450 Å 438 pixels, file size: 12 KB, MIME type: image/gif)

QTC RX window

## File history

Click on a date/time to view the file as it appeared at that time.

	Date/Time	Thumbnail	Dimensions	User	Comment
current	<a href="#">22:08, 23 July 2006</a>		450 Å 438 (12 KB)	<a href="#">Dl4ner (talk   contribs)</a>	QTC RX window

You cannot overwrite this file.

## File usage

The following page uses this file:

- [Menu:Commands](#)

## Namespaces

- [File](#)
- [Discussion](#)

## Variants

## Views

- [Read](#)
- [View source](#)
- [View history](#)

## More

- This page was last edited on 23 July 2006, at 22:08.
- [Privacy policy](#)
- [About Win-Test Wiki](#)
- [Disclaimers](#)



# File:QtcRx.gif

From Win-Test Wiki

[Jump to navigation](#) [Jump to search](#)

- [File](#)
- [File history](#)
- [File usage](#)
- [Metadata](#)

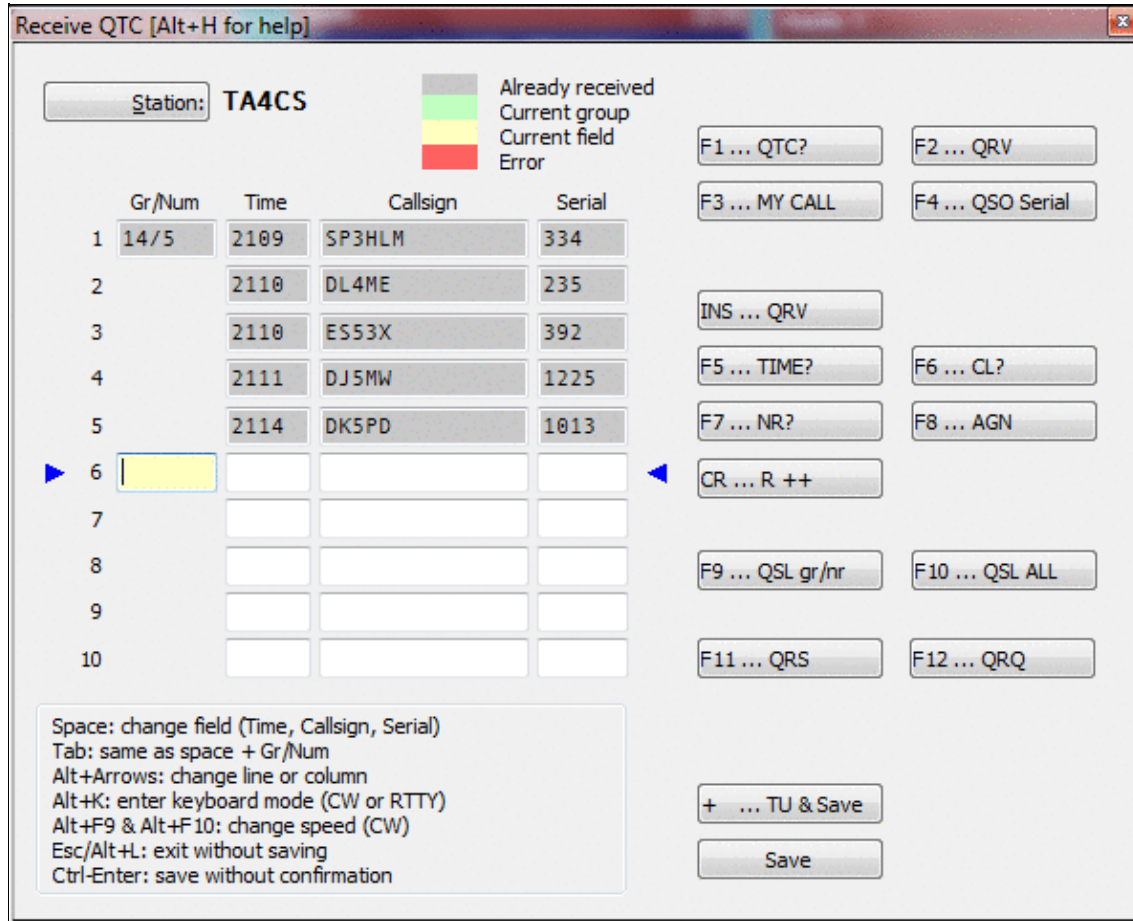





No higher resolution available.

[OtcRx.gif](#) (593 Å 481 pixels, file size: 42 KB, MIME type: image.gif)

## File history

Click on a date/time to view the file as it appeared at that time.

	Date/Time	Thumbnail	Dimensions	User	Comment
current	<a href="#">11:31, 30 December 2021</a>		593 Å 481 (42 KB)	<a href="#">Dl6rai</a> ( <a href="#">talk</a>   <a href="#">contribs</a> )	
	<a href="#">08:20, 14 August 2007</a>		471 Å 440 (16 KB)	<a href="#">Dl6rai</a> ( <a href="#">talk</a>   <a href="#">contribs</a> )	

You cannot overwrite this file.

## File usage

The following page uses this file:

- [WAEDC](#)

## Metadata

This file contains additional information, probably added from the digital camera or scanner used to create or digitize it.

If the file has been modified from its original state, some details may not fully reflect the modified file.

**Horizontal resolution** 37.79 dpc

**Vertical resolution** 37.79 dpc

## Namespaces

- [File](#)
- [Discussion](#)

## Variants

## Views

- [Read](#)
- [View source](#)

- [View history](#)

## More

- This page was last edited on 30 December 2021, at 11:31.

- [Privacy policy](#)
- [About Win-Test Wiki](#)
- [Disclaimers](#)



# File:qtc-tx-1.gif

From Win-Test Wiki

[Jump to navigation](#) [Jump to search](#)

- [File](#)
- [File history](#)
- [File usage](#)

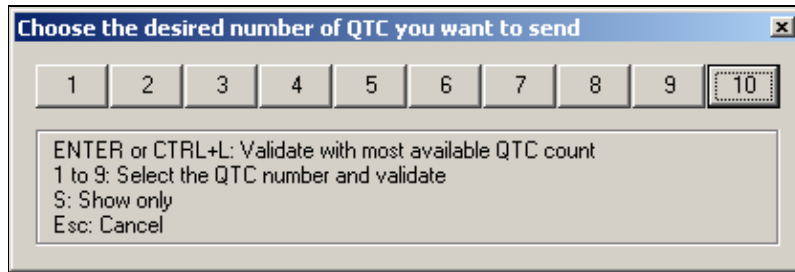

No higher resolution available.

[qtc-tx-1.gif](#) (416 × 139 pixels, file size: 7 KB, MIME type: image/gif)

Selecting Number of QTCs for Transmit

## File history

Click on a date/time to view the file as it appeared at that time.

	Date/Time	Thumbnail	Dimensions	User	Comment
current	<a href="#">22:12, 23 July 2006</a>		416 × 139 (7 KB)	<a href="#">Dl4ner</a> ( <a href="#">talk</a>   <a href="#">contribs</a> )	Selecting Number of QTCs for Transmit

You cannot overwrite this file.

## File usage

The following page uses this file:

- [Menu:Commands](#)

## Namespaces

- [File](#)
- [Discussion](#)

## Variants

## Views

- [Read](#)
- [View source](#)
- [View history](#)

## More

- This page was last edited on 23 July 2006, at 22:12.

- [Privacy policy](#)
- [About Win-Test Wiki](#)
- [Disclaimers](#)



# File:qtc-tx-1.gif

From Win-Test Wiki

[Jump to navigation](#) [Jump to search](#)

- [File](#)
- [File history](#)
- [File usage](#)

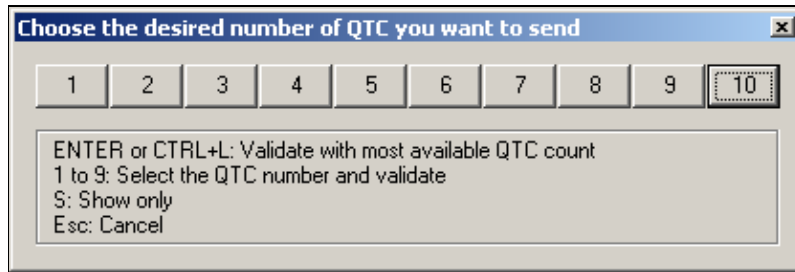

No higher resolution available.

[qtc-tx-1.gif](#) (416 × 139 pixels, file size: 7 KB, MIME type: image/gif)

Selecting Number of QTCs for Transmit

## File history

Click on a date/time to view the file as it appeared at that time.

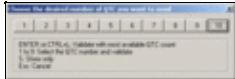
	Date/Time	Thumbnail	Dimensions	User	Comment
current	<a href="#">22:12, 23 July 2006</a>		416 × 139 (7 KB)	<a href="#">Dl4ner</a> ( <a href="#">talk</a>   <a href="#">contribs</a> )	Selecting Number of QTCs for Transmit

You cannot overwrite this file.

## File usage

The following page uses this file:

- [Menu:Commands](#)

## Namespaces

- [File](#)
- [Discussion](#)

## Variants

## Views

- [Read](#)
- [View source](#)
- [View history](#)

## More

- This page was last edited on 23 July 2006, at 22:12.

- [Privacy policy](#)
- [About Win-Test Wiki](#)
- [Disclaimers](#)



# File:qtc-tx-2.gif

From Win-Test Wiki

[Jump to navigation](#) [Jump to search](#)

- [File](#)
- [File history](#)
- [File usage](#)

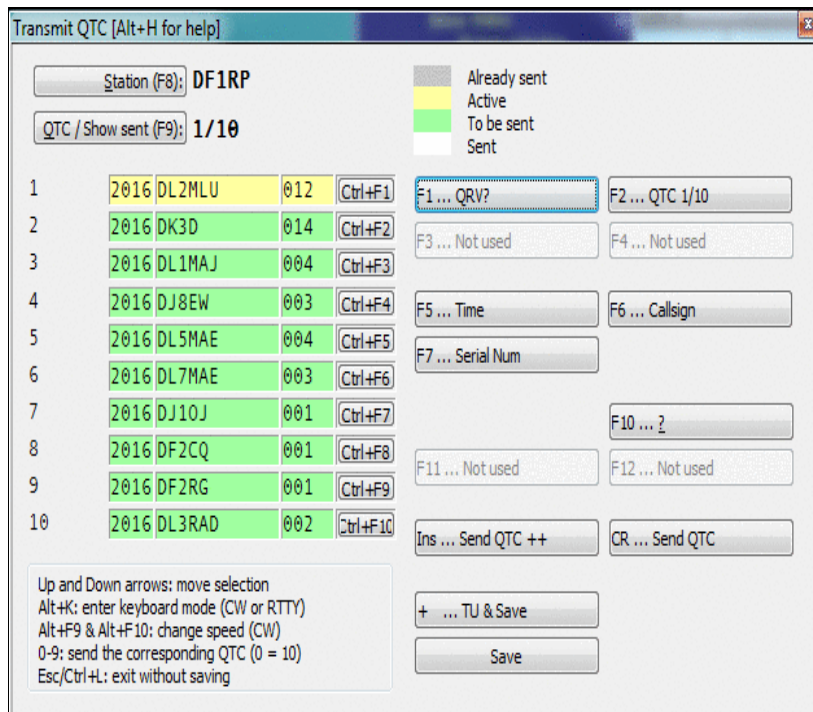

No higher resolution available.

[qtc-tx-2.gif](#) (425 × 371 pixels, file size: 13 KB, MIME type: image/gif)

Transmitting QTCs

## File history

Click on a date/time to view the file as it appeared at that time.

	Date/Time	Thumbnail	Dimensions	User	Comment
current	<a href="#">22:12, 23 July 2006</a>		425 × 371 (13 KB)	<a href="#">Dl4ner</a> ( <a href="#">talk</a>   <a href="#">contribs</a> )	Transmitting QTCs

Date/Time	Thumbnail	Dimensions	User	Comment
You cannot overwrite this file.				

## File usage

The following page uses this file:

- [Menu:Commands](#)

## Namespaces

- [File](#)
- [Discussion](#)

## Variants

## Views

- [Read](#)
- [View source](#)
- [View history](#)

## More

- This page was last edited on 23 July 2006, at 22:12.

- [Privacy policy](#)
- [About Win-Test Wiki](#)
- [Disclaimers](#)

- 



# File:qtc-tx-2.gif

From Win-Test Wiki

[Jump to navigation](#) [Jump to search](#)

- [File](#)
- [File history](#)
- [File usage](#)
- [Metadata](#)

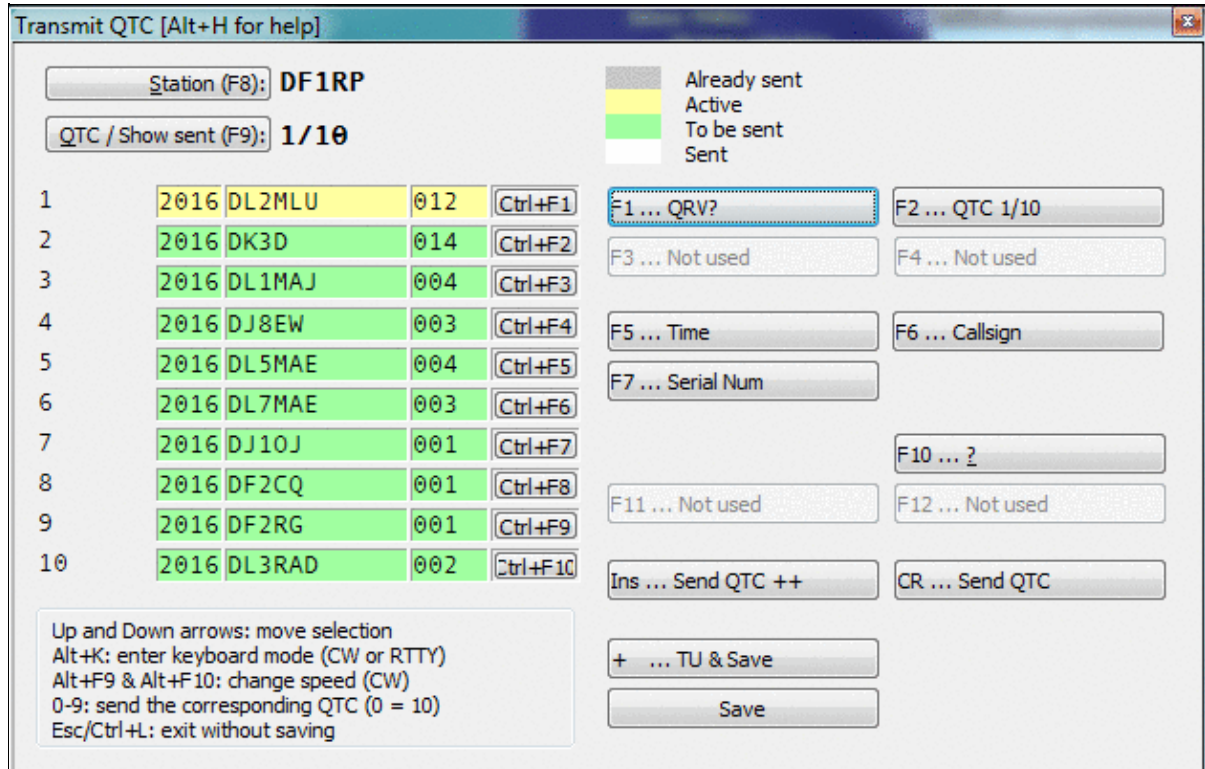

No higher resolution available.

[qtc-tx-2.gif](#) (627 Å 403 pixels, file size: 42 KB, MIME type: image.gif)

## File history

Click on a date/time to view the file as it appeared at that time.

	Date/Time	Thumbnail	Dimensions	User	Comment
current	<a href="#">11:35, 30 December 2021</a>		627 Å 403 (42 KB)	<a href="#">Dl6rai</a> ( <a href="#">talk</a>   <a href="#">contribs</a> )	

You cannot overwrite this file.

## File usage

The following page uses this file:

- [WAEDC](#)

## Metadata

This file contains additional information, probably added from the digital camera or scanner used to create or digitize it.

If the file has been modified from its original state, some details may not fully reflect the modified file.

**Horizontal resolution** 37.79 dpc

**Vertical resolution** 37.79 dpc

## Namespaces

- [File](#)
- [Discussion](#)

## Variants

## Views

- [Read](#)
- [View source](#)
- [View history](#)

## More

- This page was last edited on 30 December 2021, at 11:35.
- [Privacy policy](#)

- [About Win-Test Wiki](#)
- [Disclaimers](#)



# File:qtc-tx-2.gif

From Win-Test Wiki

[Jump to navigation](#) [Jump to search](#)

- [File](#)
- [File history](#)
- [File usage](#)
- [Metadata](#)

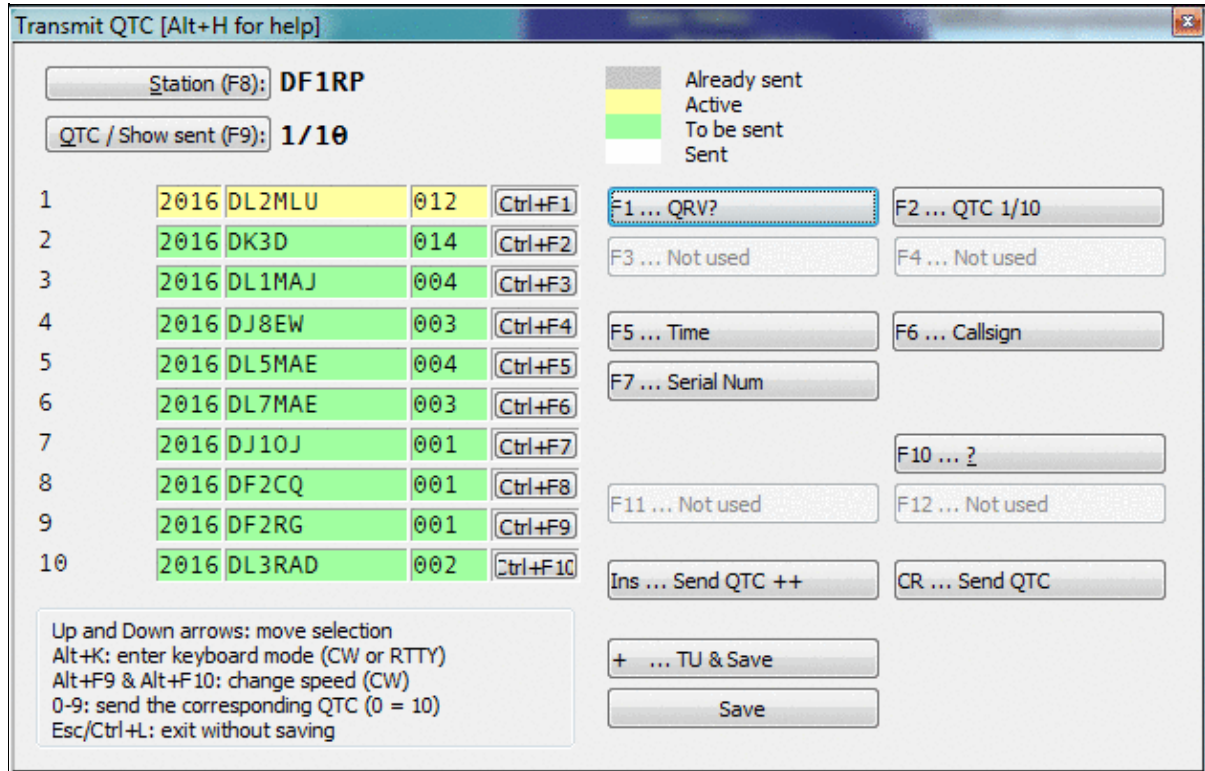

No higher resolution available.

[qtc-tx-2.gif](#) (627 Å 403 pixels, file size: 42 KB, MIME type: image.gif)

## File history

Click on a date/time to view the file as it appeared at that time.

	Date/Time	Thumbnail	Dimensions	User	Comment
current	<a href="#">11:35, 30 December 2021</a>		627 Å 403 (42 KB)	<a href="#">Dl6rai</a> ( <a href="#">talk</a>   <a href="#">contribs</a> )	

You cannot overwrite this file.

## File usage

The following page uses this file:

- [WAEDC](#)

## Metadata

This file contains additional information, probably added from the digital camera or scanner used to create or digitize it.

If the file has been modified from its original state, some details may not fully reflect the modified file.

**Horizontal resolution** 37.79 dpc

**Vertical resolution** 37.79 dpc

## Namespaces

- [File](#)
- [Discussion](#)

## Variants

## Views

- [Read](#)
- [View source](#)
- [View history](#)

## More

- This page was last edited on 30 December 2021, at 11:35.
- [Privacy policy](#)

## Win-Test Wiki

- [About Win-Test Wiki](#)
- [Disclaimers](#)



# File:qtc-tx-2.gif

From Win-Test Wiki

[Jump to navigation](#) [Jump to search](#)

- [File](#)
- [File history](#)
- [File usage](#)

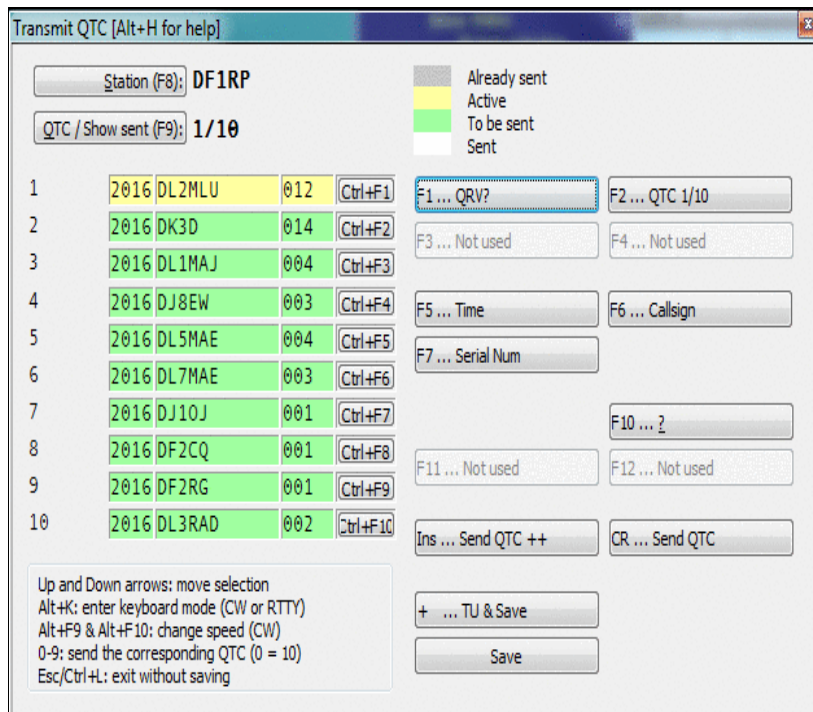

No higher resolution available.

[qtc-tx-2.gif](#) (425 × 371 pixels, file size: 13 KB, MIME type: image/gif)

Transmitting QTCs

## File history

Click on a date/time to view the file as it appeared at that time.

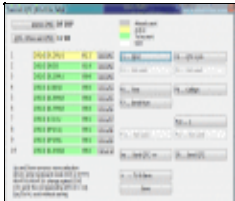
	Date/Time	Thumbnail	Dimensions	User	Comment
current	<a href="#">22:12, 23 July 2006</a>		425 × 371 (13 KB)	<a href="#">Dl4ner</a> ( <a href="#">talk</a>   <a href="#">contribs</a> )	Transmitting QTCs

Date/Time	Thumbnail	Dimensions	User	Comment
You cannot overwrite this file.				

## File usage

The following page uses this file:

- [Menu:Commands](#)

## Namespaces

- [File](#)
- [Discussion](#)

## Variants

## Views

- [Read](#)
- [View source](#)
- [View history](#)

## More

- This page was last edited on 23 July 2006, at 22:12.

- [Privacy policy](#)
- [About Win-Test Wiki](#)
- [Disclaimers](#)

- 



# File:RecordStop.gif

From Win-Test Wiki

[Jump to navigation](#) [Jump to search](#)

- [File](#)
- [File history](#)
- [File usage](#)

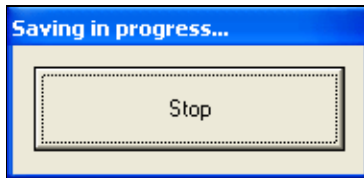

No higher resolution available.

[RecordStop.gif](#) (189 × 91 pixels, file size: 3 KB, MIME type: image.gif)

Button to stop recording

## File history

Click on a date/time to view the file as it appeared at that time.

	Date/Time	Thumbnail	Dimensions	User	Comment
current	<a href="#">10:50, 1 February 2007</a>		189 × 91 (3 KB)	<a href="#">I2WIJ</a> ( <a href="#">talk</a>   <a href="#">contribs</a> )	Button to stop recording

You cannot overwrite this file.

## File usage

The following page uses this file:

- [DVK CW RTTY Messaging](#)

## Namespaces

- [File](#)
- [Discussion](#)

## Variants

## Views

- [Read](#)
- [View source](#)

- [View history](#)

## More

- This page was last edited on 1 February 2007, at 10:50.

- [Privacy policy](#)
- [About Win-Test Wiki](#)
- [Disclaimers](#)



# File:RecordStop.gif

From Win-Test Wiki

[Jump to navigation](#) [Jump to search](#)

- [File](#)
- [File history](#)
- [File usage](#)

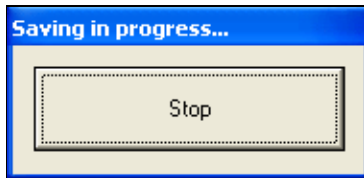

No higher resolution available.

[RecordStop.gif](#) (189 × 91 pixels, file size: 3 KB, MIME type: image.gif)

Button to stop recording

## File history

Click on a date/time to view the file as it appeared at that time.

	Date/Time	Thumbnail	Dimensions	User	Comment
current	<a href="#">10:50, 1 February 2007</a>		189 × 91 (3 KB)	<a href="#">I2WIJ (talk   contribs)</a>	Button to stop recording

You cannot overwrite this file.

## File usage

The following page uses this file:

- [DVK CW RTTY Messaging](#)

## Namespaces

- [File](#)
- [Discussion](#)

## Variants

## Views

- [Read](#)
- [View source](#)

- [View history](#)

## More

- This page was last edited on 1 February 2007, at 10:50.

- [Privacy policy](#)
- [About Win-Test Wiki](#)
- [Disclaimers](#)



# File:RemoteCommandDialog.gif

From Win-Test Wiki

[Jump to navigation](#) [Jump to search](#)

- [File](#)
- [File history](#)
- [File usage](#)

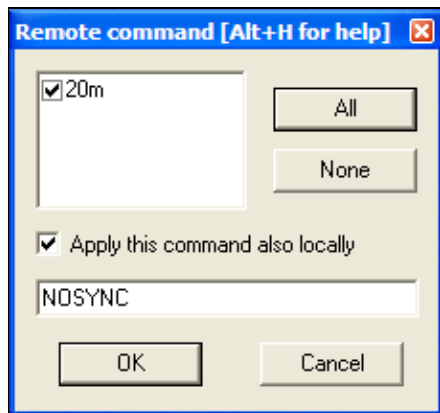

No higher resolution available.

[RemoteCommandDialog.gif](#) (227 × 213 pixels, file size: 7 KB, MIME type: image/gif)

Dialog presented when you enter the REMOTE text command.

## File history

Click on a date/time to view the file as it appeared at that time.

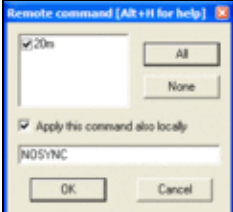
	Date/Time	Thumbnail	Dimensions	User	Comment
current	<a href="#">06:05, 23 November 2007</a>		227 × 213 (7 KB)	<a href="#">N6TV (talk   contribs)</a>	Dialog presented when you enter the REMOTE text command.

You cannot overwrite this file.

## File usage

The following 2 pages use this file:

- [Menu:Commands](#)
- [Multi-op/Clearing all logs before the start](#)

## Namespaces

- [File](#)
- [Discussion](#)

## Variants

## Views

- [Read](#)
- [View source](#)
- [View history](#)

## More

- This page was last edited on 23 November 2007, at 06:05.

- [Privacy policy](#)
- [About Win-Test Wiki](#)
- [Disclaimers](#)



# File:RemoteCommandDialog.gif

From Win-Test Wiki

[Jump to navigation](#) [Jump to search](#)

- [File](#)
- [File history](#)
- [File usage](#)

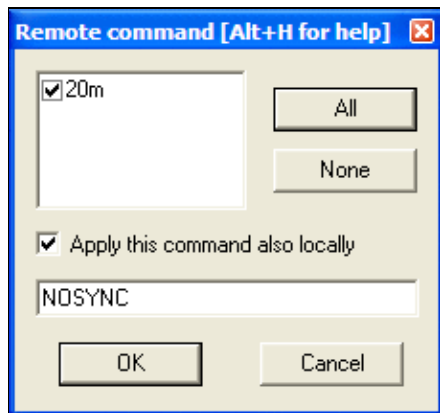

No higher resolution available.

[RemoteCommandDialog.gif](#) (227 × 213 pixels, file size: 7 KB, MIME type: image/gif)

Dialog presented when you enter the REMOTE text command.

## File history

Click on a date/time to view the file as it appeared at that time.

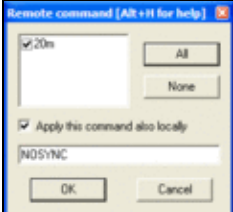
	Date/Time	Thumbnail	Dimensions	User	Comment
current	<a href="#">06:05, 23 November 2007</a>		227 × 213 (7 KB)	<a href="#">N6TV (talk   contribs)</a>	Dialog presented when you enter the REMOTE text command.

You cannot overwrite this file.

## File usage

The following 2 pages use this file:

- [Menu:Commands](#)
- [Multi-op/Clearing all logs before the start](#)

## Namespaces

- [File](#)
- [Discussion](#)

## Variants

## Views

- [Read](#)
- [View source](#)
- [View history](#)

## More

- This page was last edited on 23 November 2007, at 06:05.

- [Privacy policy](#)
- [About Win-Test Wiki](#)
- [Disclaimers](#)

- The logo for MediaWiki, featuring a sun icon and the text "Powered By MediaWiki".



# File:Rtty config rightclick.gif

From Win-Test Wiki

[Jump to navigation](#) [Jump to search](#)

- [File](#)
- [File history](#)
- [File usage](#)

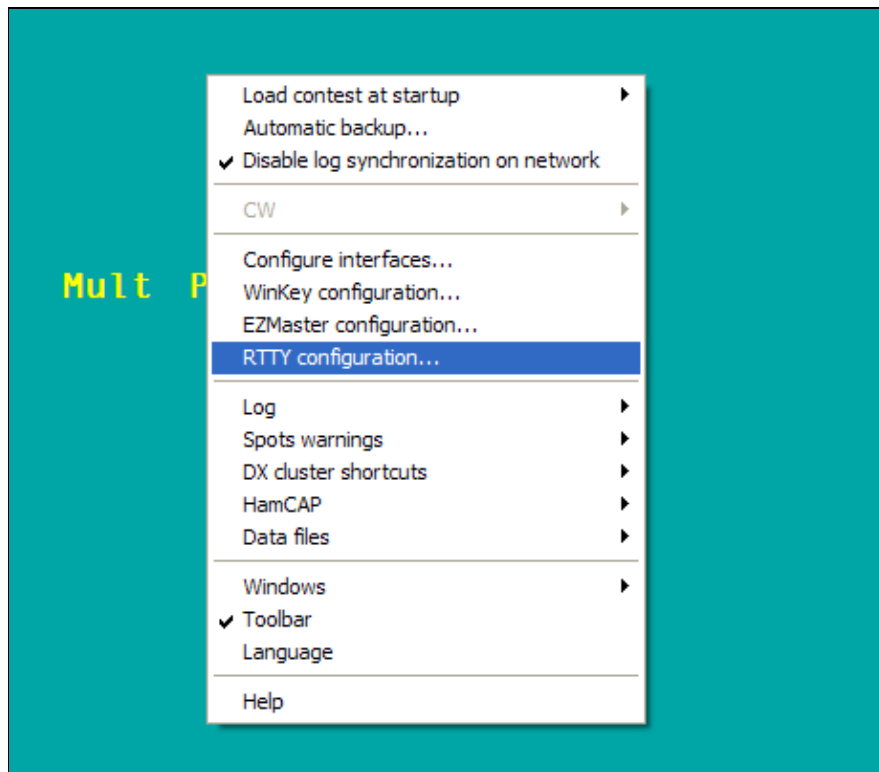

No higher resolution available.

[Rtty\\_config\\_rightclick.gif](#) (461 × 401 pixels, file size: 8 KB, MIME type: image/gif)

Open RTTY configuration box

## File history

Click on a date/time to view the file as it appeared at that time.

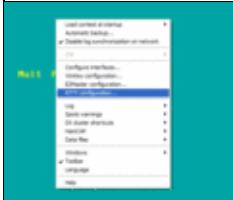
	Date/Time	Thumbnail	Dimensions	User	Comment
current	<a href="#">22:22, 24 July 2006</a>		461 × 401 (8 KB)	<a href="#">M3php</a> ( <a href="#">talk</a>   <a href="#">contribs</a> )	Open RTTY configuration box

You cannot overwrite this file.

## File usage

The following page uses this file:

- [RTTY](#)

## Namespaces

- [File](#)
- [Discussion](#)

## Variants

## Views

- [Read](#)
- [View source](#)
- [View history](#)

## More

- This page was last edited on 24 July 2006, at 22:22.

- [Privacy policy](#)
- [About Win-Test Wiki](#)
- [Disclaimers](#)



# File:Rtty config rightclick.gif

From Win-Test Wiki

[Jump to navigation](#) [Jump to search](#)

- [File](#)
- [File history](#)
- [File usage](#)

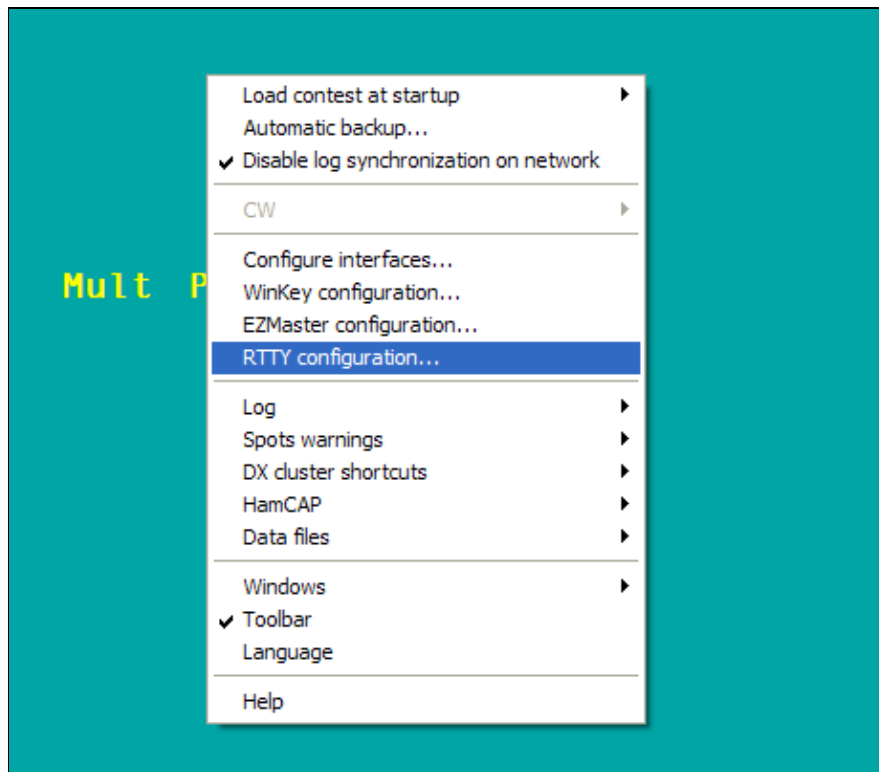

No higher resolution available.

[Rtty\\_config\\_rightclick.gif](#) (461 × 401 pixels, file size: 8 KB, MIME type: image/gif)

Open RTTY configuration box

## File history

Click on a date/time to view the file as it appeared at that time.

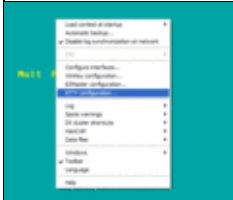
	Date/Time	Thumbnail	Dimensions	User	Comment
current	<a href="#">22:22, 24 July 2006</a>		461 × 401 (8 KB)	<a href="#">M3php</a> ( <a href="#">talk</a>   <a href="#">contribs</a> )	Open RTTY configuration box

You cannot overwrite this file.

## File usage

The following page uses this file:

- [RTTY](#)

## Namespaces

- [File](#)
- [Discussion](#)

## Variants

## Views

- [Read](#)
- [View source](#)
- [View history](#)

## More

- This page was last edited on 24 July 2006, at 22:22.

- [Privacy policy](#)
- [About Win-Test Wiki](#)
- [Disclaimers](#)

- 

# File:Rtty macros.gif

From Win-Test Wiki

[Jump to navigation](#) [Jump to search](#)

- [File](#)
- [File history](#)
- [File usage](#)



No higher resolution available.

[Rtty macros.gif](#) (528 × 44 pixels, file size: 5 KB, MIME type: image/gif)

RTTY Macros

## File history

Click on a date/time to view the file as it appeared at that time.

	Date/Time	Thumbnail	Dimensions	User	Comment
current	<a href="#">20:25, 27 July 2006</a>		528 × 44 (5 KB)	<a href="#">M3php</a> ( <a href="#">talk</a>   <a href="#">contribs</a> )	RTTY Macros

You cannot overwrite this file.

## File usage

The following 2 pages use this file:

- [DVK CW RTTY Messaging](#)
- [RTTY](#)

## Namespaces

- [File](#)
- [Discussion](#)

## Variants

## Views

- [Read](#)
- [View source](#)
- [View history](#)

## More

- This page was last edited on 27 July 2006, at 20:25.

- [Privacy policy](#)
- [About Win-Test Wiki](#)
- [Disclaimers](#)



# File:Rtty macros.gif

From Win-Test Wiki

[Jump to navigation](#) [Jump to search](#)

- [File](#)
- [File history](#)
- [File usage](#)



No higher resolution available.

[Rtty macros.gif](#) (528 × 44 pixels, file size: 5 KB, MIME type: image/gif)

RTTY Macros

## File history

Click on a date/time to view the file as it appeared at that time.

	Date/Time	Thumbnail	Dimensions	User	Comment
current	<a href="#">20:25, 27 July 2006</a>		528 × 44 (5 KB)	<a href="#">M3php</a> ( <a href="#">talk</a>   <a href="#">contribs</a> )	RTTY Macros

You cannot overwrite this file.

## File usage

The following 2 pages use this file:

- [DVK CW RTTY Messaging](#)
- [RTTY](#)

## Namespaces

- [File](#)
- [Discussion](#)

## Variants

## Views

- [Read](#)
- [View source](#)
- [View history](#)

## More

- This page was last edited on 27 July 2006, at 20:25.

- [Privacy policy](#)
- [About Win-Test Wiki](#)
- [Disclaimers](#)





# File:RttyMessagingTypical.PNG

From Win-Test Wiki

[Jump to navigation](#) [Jump to search](#)

- [File](#)
- [File history](#)
- [File usage](#)

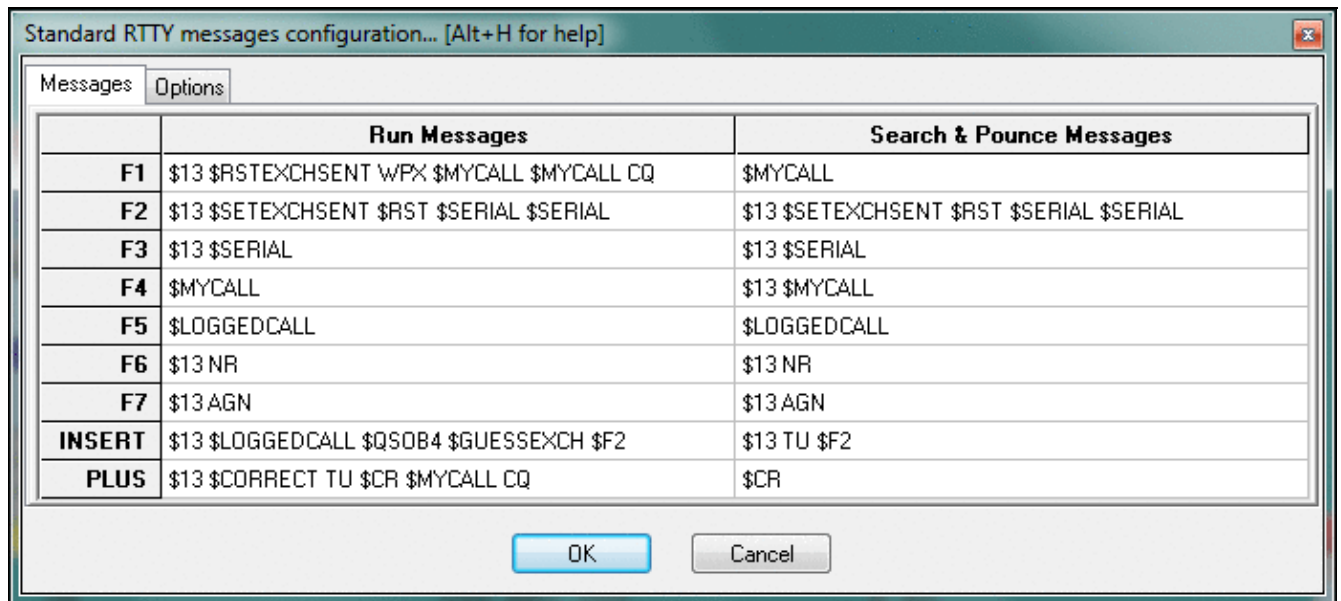

No higher resolution available.

[RttyMessagingTypical.PNG](#) (694 × 312 pixels, file size: 32 KB, MIME type: image/gif)

## File history

Click on a date/time to view the file as it appeared at that time.

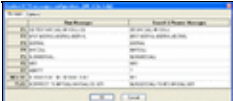
	Date/Time	Thumbnail	Dimensions	User	Comment
current	<a href="#">06:50, 31 October 2010</a>		694 × 312 (32 KB)	<a href="#">N6TV (talk   contribs)</a>	W0YK-recommended RTTY contest messages.
	<a href="#">18:33, 3 January 2010</a>		684 × 302 (15 KB)	<a href="#">Dl6rai (talk   contribs)</a>	

You cannot overwrite this file.

## File usage

The following page uses this file:

- [DVK CW RTTY Messaging](#)

## Namespaces

- [File](#)
- [Discussion](#)

## Variants

## Views

- [Read](#)
- [View source](#)
- [View history](#)

## More

- This page was last edited on 3 January 2010, at 18:33.

- [Privacy policy](#)
- [About Win-Test Wiki](#)
- [Disclaimers](#)

- The logo for MediaWiki, featuring a sun icon and the text "Powered By MediaWiki".

# File:RttyMessagingTypical.PNG

From Win-Test Wiki

[Jump to navigation](#) [Jump to search](#)

- [File](#)
- [File history](#)
- [File usage](#)

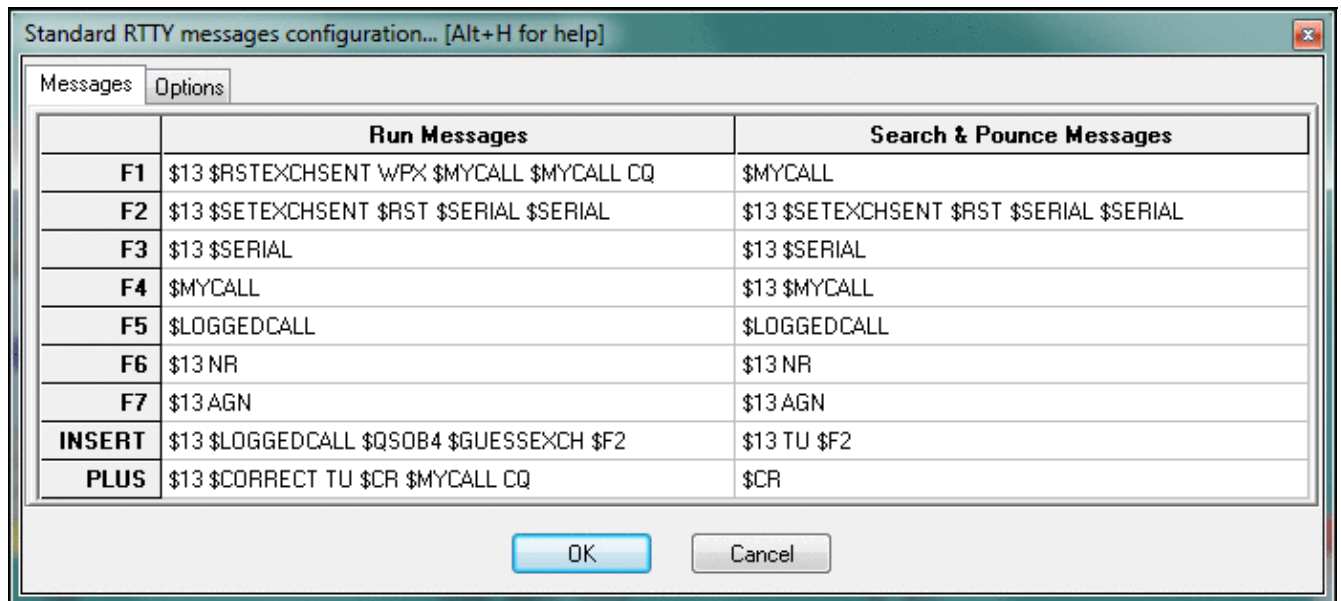

No higher resolution available.

[RttyMessagingTypical.PNG](#) (694 × 312 pixels, file size: 32 KB, MIME type: image/gif)

## File history

Click on a date/time to view the file as it appeared at that time.

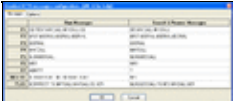
	Date/Time	Thumbnail	Dimensions	User	Comment
current	<a href="#">06:50, 31 October 2010</a>		694 × 312 (32 KB)	<a href="#">N6TV (talk   contribs)</a>	W0YK-recommended RTTY contest messages.
	<a href="#">18:33, 3 January 2010</a>		684 × 302 (15 KB)	<a href="#">Dl6rai (talk   contribs)</a>	

You cannot overwrite this file.

## File usage

The following page uses this file:

- [DVK CW RTTY Messaging](#)

## Namespaces

- [File](#)
- [Discussion](#)

## Variants

## Views

- [Read](#)
- [View source](#)
- [View history](#)

## More

- This page was last edited on 3 January 2010, at 18:33.

- [Privacy policy](#)
- [About Win-Test Wiki](#)
- [Disclaimers](#)



# File:Rtty mmtty.gif

From Win-Test Wiki

[Jump to navigation](#) [Jump to search](#)

- [File](#)
- [File history](#)
- [File usage](#)

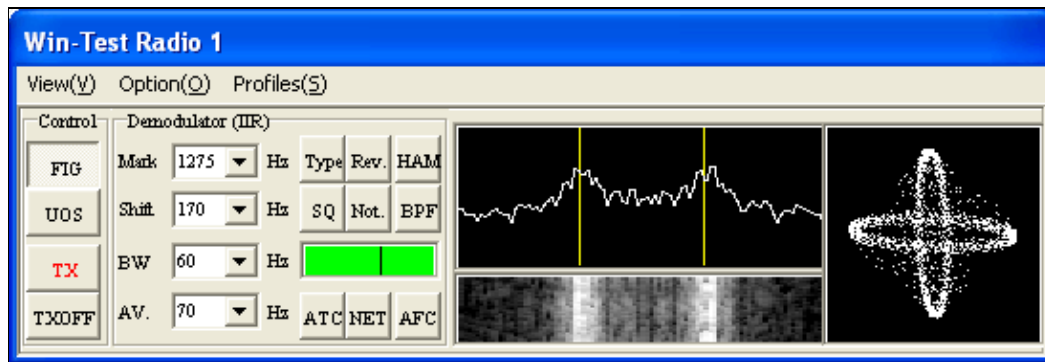

No higher resolution available.

[Rtty mmtty.gif](#) (547 × 186 pixels, file size: 16 KB, MIME type: image/gif)

MMTTY Window Screenshot

## File history

Click on a date/time to view the file as it appeared at that time.

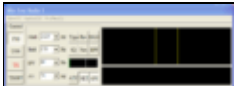
	Date/Time	Thumbnail	Dimensions	User	Comment
current	<a href="#">22:34, 29 September 2006</a>		547 × 186 (16 KB)	<a href="#">Dl6rai (talk   contribs)</a>	
	<a href="#">20:07, 27 July 2006</a>		648 × 235 (13 KB)	<a href="#">M3php (talk   contribs)</a>	MMTTY Window Screenshot

You cannot overwrite this file.

## File usage

The following page uses this file:

- [RTTY](#)

## Namespaces

- [File](#)
- [Discussion](#)

## Variants

## Views

- [Read](#)
- [View source](#)
- [View history](#)

## More

- This page was last edited on 27 July 2006, at 20:07.

- [Privacy policy](#)
- [About Win-Test Wiki](#)
- [Disclaimers](#)



# File:Rtty mmtty.gif

From Win-Test Wiki

[Jump to navigation](#) [Jump to search](#)

- [File](#)
- [File history](#)
- [File usage](#)

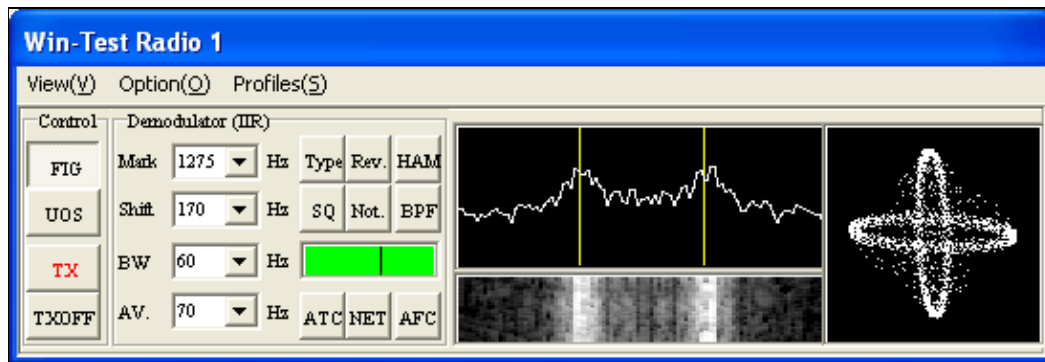

No higher resolution available.

[Rtty mmtty.gif](#) (547 × 186 pixels, file size: 16 KB, MIME type: image/gif)

MMTTY Window Screenshot

## File history

Click on a date/time to view the file as it appeared at that time.

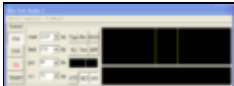
	Date/Time	Thumbnail	Dimensions	User	Comment
current	<a href="#">22:34, 29 September 2006</a>		547 × 186 (16 KB)	<a href="#">Dl6rai (talk   contribs)</a>	
	<a href="#">20:07, 27 July 2006</a>		648 × 235 (13 KB)	<a href="#">M3php (talk   contribs)</a>	MMTTY Window Screenshot

You cannot overwrite this file.

## File usage

The following page uses this file:

- [RTTY](#)

## Namespaces

- [File](#)
- [Discussion](#)

## Variants

## Views

- [Read](#)
- [View source](#)
- [View history](#)

## More

- This page was last edited on 27 July 2006, at 20:07.

- [Privacy policy](#)
- [About Win-Test Wiki](#)
- [Disclaimers](#)





# File:RttyStandardMessagesOptions.PNG

From Win-Test Wiki

[Jump to navigation](#) [Jump to search](#)

- [File](#)
- [File history](#)
- [File usage](#)

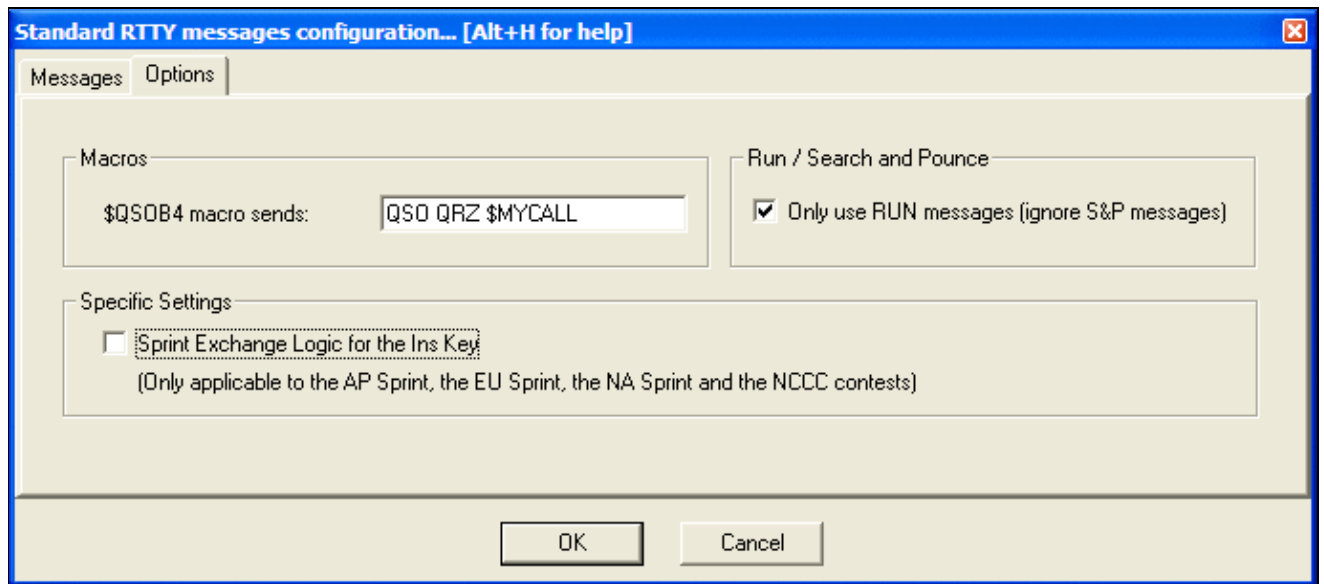

No higher resolution available.

[RttyStandardMessagesOptions.PNG](#) (684 × 302 pixels, file size: 13 KB, MIME type: image.gif)

Options tab for RTTY Standard Messages

## File history

Click on a date/time to view the file as it appeared at that time.

	Date/Time	Thumbnail	Dimensions	User	Comment
current	<a href="#">00:36, 10 November 2008</a>		684 × 302 (13 KB)	<a href="#">N6TV</a> ( <a href="#">talk</a>   <a href="#">contribs</a> )	Options tab for RTTY Standard Messages

You cannot overwrite this file.

## File usage

The following page uses this file:

- [Menu:Options](#)

## Namespaces

- [File](#)
- [Discussion](#)

## Variants

## Views

- [Read](#)
- [View source](#)
- [View history](#)

## More

- This page was last edited on 10 November 2008, at 00:36.

- [Privacy policy](#)
- [About Win-Test Wiki](#)
- [Disclaimers](#)

- The logo consists of a small sun icon on the left, followed by the text "Powered By" in a smaller font above "MediaWiki" in a larger font, all contained within a thin black rectangular border.

# File:RttyStandardMessagesOptions.PNG

From Win-Test Wiki

[Jump to navigation](#) [Jump to search](#)

- [File](#)
- [File history](#)
- [File usage](#)

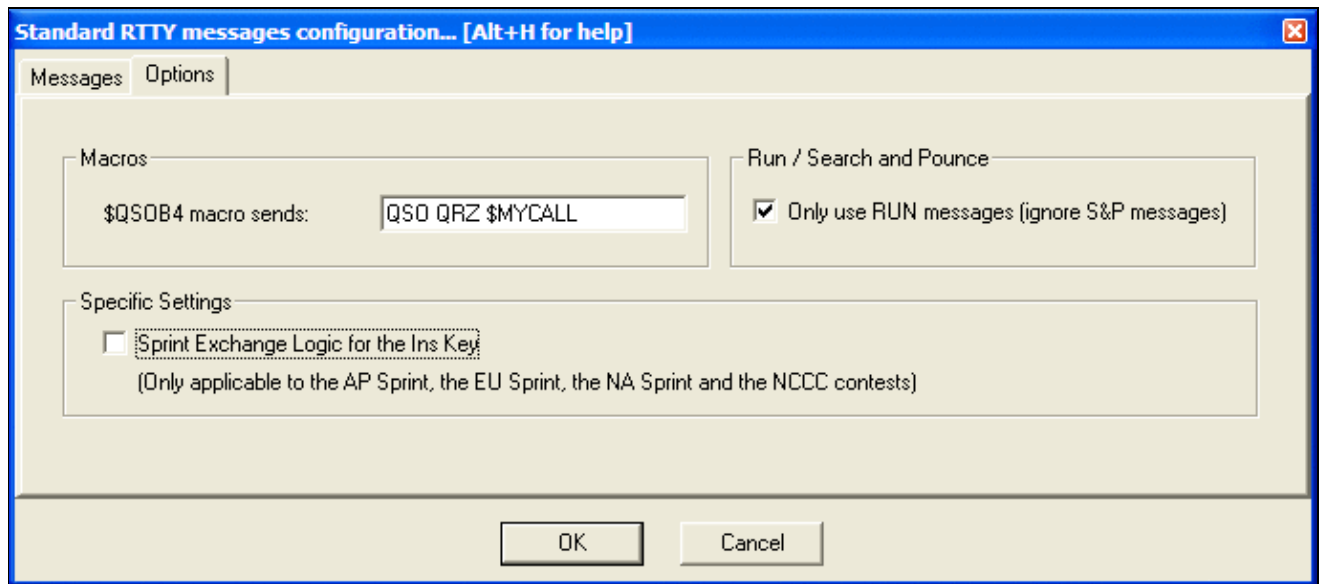

No higher resolution available.

[RttyStandardMessagesOptions.PNG](#) (684 × 302 pixels, file size: 13 KB, MIME type: image.gif)

Options tab for RTTY Standard Messages

## File history

Click on a date/time to view the file as it appeared at that time.

	Date/Time	Thumbnail	Dimensions	User	Comment
current	<a href="#">00:36, 10 November 2008</a>		684 × 302 (13 KB)	<a href="#">N6TV</a> ( <a href="#">talk</a>   <a href="#">contribs</a> )	Options tab for RTTY Standard Messages

You cannot overwrite this file.

## File usage

The following page uses this file:

- [Menu:Options](#)

## Namespaces

- [File](#)
- [Discussion](#)

## Variants

## Views

- [Read](#)
- [View source](#)
- [View history](#)

## More

- This page was last edited on 10 November 2008, at 00:36.
- [Privacy policy](#)
- [About Win-Test Wiki](#)
- [Disclaimers](#)



# File:RttyWindow.PNG

From Win-Test Wiki

[Jump to navigation](#) [Jump to search](#)

- [File](#)
- [File history](#)
- [File usage](#)

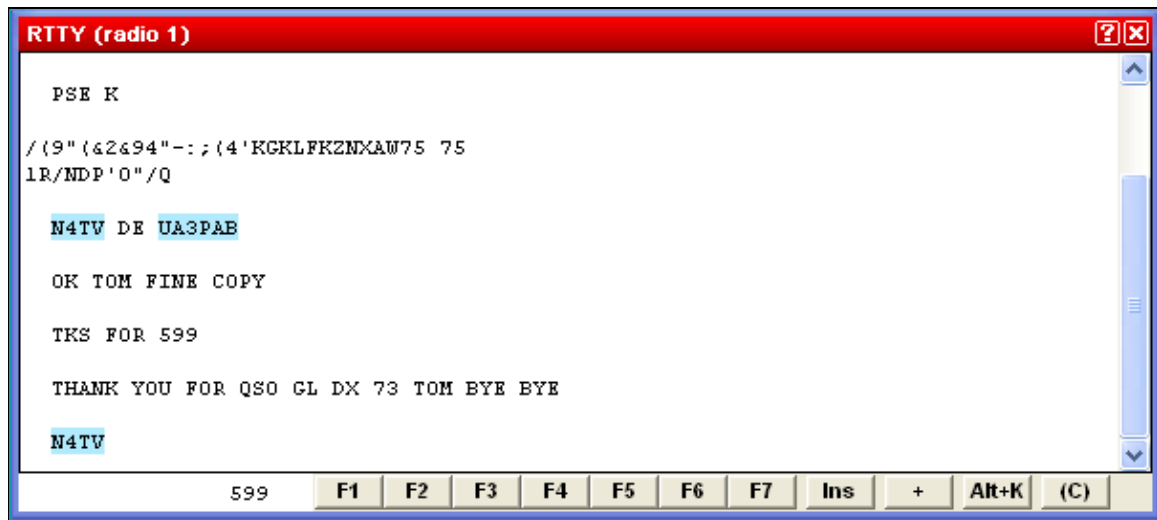

No higher resolution available.

[RttyWindow.PNG](#) (603 × 269 pixels, file size: 10 KB, MIME type: image/gif)

## File history

Click on a date/time to view the file as it appeared at that time.

Date/Time	Thumbnail	Dimensions	User	Comment
current <a href="#">20:50, 3 June 2008</a>		603 × 269 (10 KB)	<a href="#">Dl6rai</a> ( <a href="#">talk</a>   <a href="#">contribs</a> )	

You cannot overwrite this file.

## File usage

The following 2 pages use this file:

- [Menu:Windows](#)
- [RTTY](#)

## Namespaces

- [File](#)

- [Discussion](#)

## Variants

## Views

- [Read](#)
- [View source](#)
- [View history](#)

## More

- This page was last edited on 3 June 2008, at 20:50.

- [Privacy policy](#)
- [About Win-Test Wiki](#)
- [Disclaimers](#)



# File:RttyWindowContextMenu.gif

From Win-Test Wiki

[Jump to navigation](#) [Jump to search](#)

- [File](#)
- [File history](#)
- [File usage](#)
- [Metadata](#)

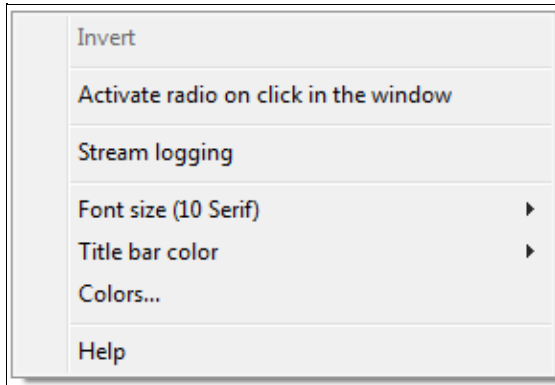

No higher resolution available.

[RttyWindowContextMenu.gif](#) (289 × 200 pixels, file size: 3 KB, MIME type: image.gif)

## File history

Click on a date/time to view the file as it appeared at that time.

Date/Time	Thumbnail	Dimensions	User	Comment
current <a href="#">16:47, 8 April 2021</a>		289 × 200 (3 KB)	<a href="#">Dl6rai</a> ( <a href="#">talk</a>   <a href="#">contribs</a> )	

You cannot overwrite this file.

## File usage

The following page uses this file:

- [RTTY](#)

## Metadata

This file contains additional information, probably added from the digital camera or scanner used to create or digitize it.

If the file has been modified from its original state, some details may not fully reflect the modified file.

**Horizontal resolution** 37.79 dpc

**Vertical resolution** 37.79 dpc

## Namespaces

- [File](#)
- [Discussion](#)

## Variants

## Views

- [Read](#)
- [View source](#)
- [View history](#)

## More

- This page was last edited on 8 April 2021, at 16:47.

- [Privacy policy](#)
- [About Win-Test Wiki](#)
- [Disclaimers](#)





# File:RttyWindowContextMenu.gif

From Win-Test Wiki

[Jump to navigation](#) [Jump to search](#)

- [File](#)
- [File history](#)
- [File usage](#)
- [Metadata](#)

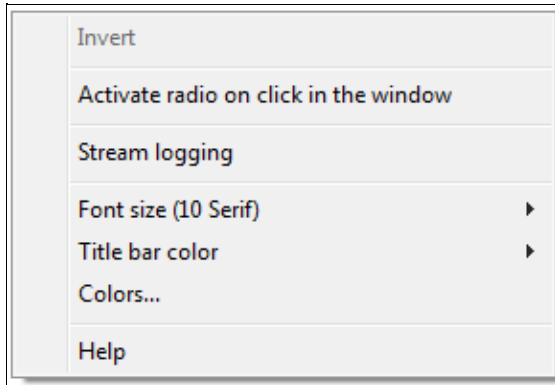

No higher resolution available.

[RttyWindowContextMenu.gif](#) (289 × 200 pixels, file size: 3 KB, MIME type: image.gif)

## File history

Click on a date/time to view the file as it appeared at that time.

Date/Time	Thumbnail	Dimensions	User	Comment
current <a href="#">16:47, 8 April 2021</a>		289 × 200 (3 KB)	<a href="#">Dl6rai</a> ( <a href="#">talk</a>   <a href="#">contribs</a> )	

You cannot overwrite this file.

## File usage

The following page uses this file:

- [RTTY](#)

## Metadata

This file contains additional information, probably added from the digital camera or scanner used to create or digitize it.

If the file has been modified from its original state, some details may not fully reflect the modified file.

**Horizontal resolution** 37.79 dpc

**Vertical resolution** 37.79 dpc

## Namespaces

- [File](#)
- [Discussion](#)

## Variants

## Views

- [Read](#)
- [View source](#)
- [View history](#)

## More

- This page was last edited on 8 April 2021, at 16:47.

- [Privacy policy](#)
- [About Win-Test Wiki](#)
- [Disclaimers](#)

- The logo for MediaWiki, featuring a sun icon and the text "Powered By MediaWiki".

# File:RttyWindow.PNG

From Win-Test Wiki

[Jump to navigation](#) [Jump to search](#)

- [File](#)
- [File history](#)
- [File usage](#)

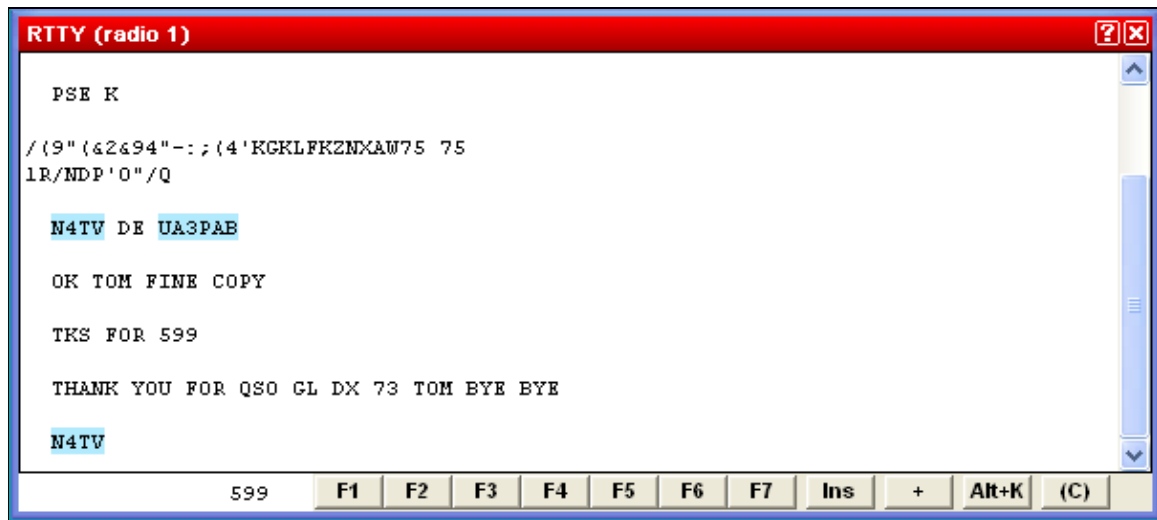

No higher resolution available.

[RttyWindow.PNG](#) (603 × 269 pixels, file size: 10 KB, MIME type: image/gif)

## File history

Click on a date/time to view the file as it appeared at that time.

Date/Time	Thumbnail	Dimensions	User	Comment
current <a href="#">20:50, 3 June 2008</a>		603 × 269 (10 KB)	<a href="#">Dl6rai</a> ( <a href="#">talk</a>   <a href="#">contribs</a> )	

You cannot overwrite this file.

## File usage

The following 2 pages use this file:

- [Menu:Windows](#)
- [RTTY](#)

## Namespaces

- [File](#)

- [Discussion](#)

## Variants

## Views

- [Read](#)
- [View source](#)
- [View history](#)

## More

- This page was last edited on 3 June 2008, at 20:50.
- [Privacy policy](#)
- [About Win-Test Wiki](#)
- [Disclaimers](#)



# File:Scenarios.PNG

From Win-Test Wiki

[Jump to navigation](#) [Jump to search](#)

- [File](#)
- [File history](#)
- [File usage](#)

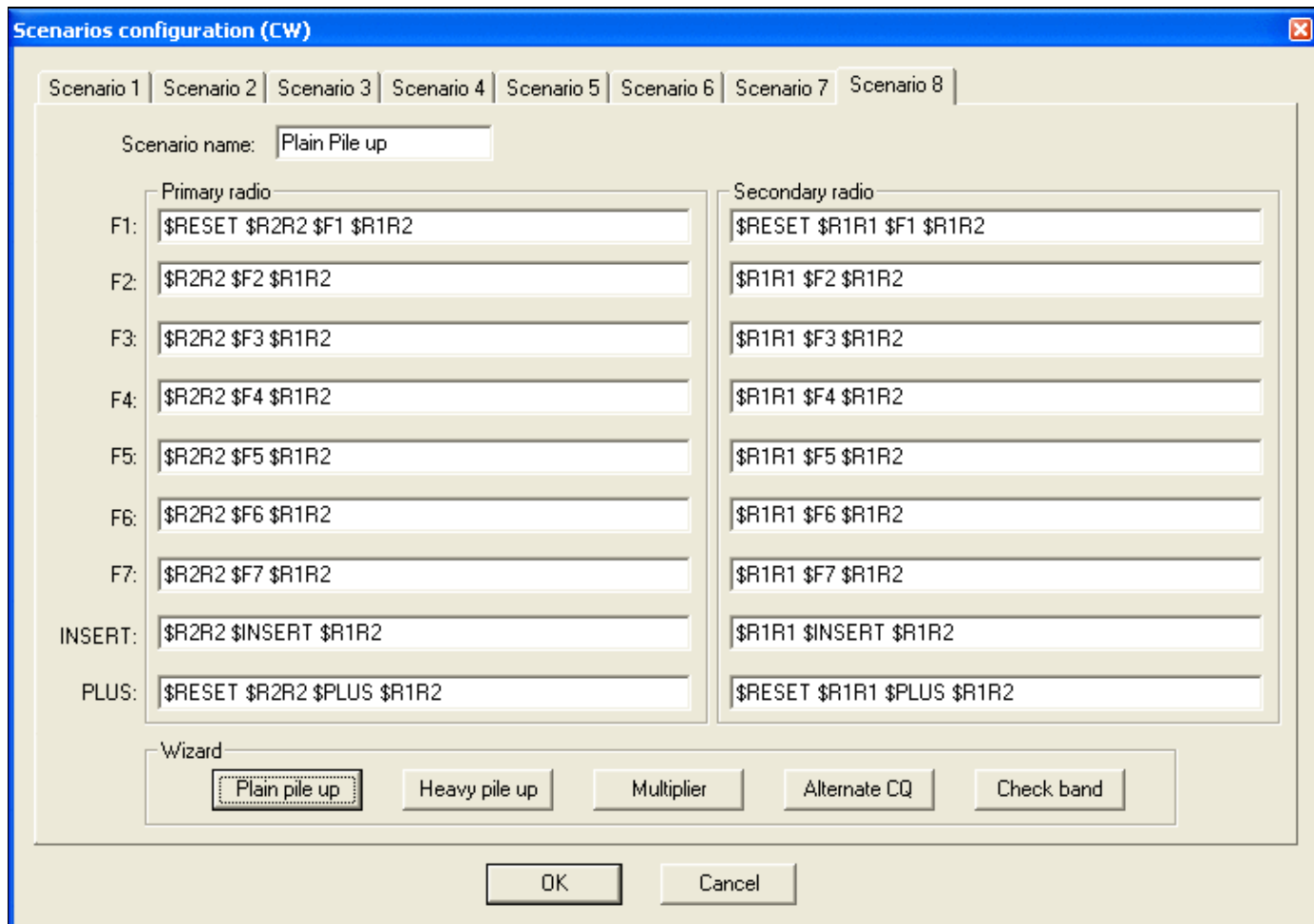

No higher resolution available.

Scenarios.PNG (723 × 508 pixels, file size: 21 KB, MIME type: image.gif)

## File history

Click on a date/time to view the file as it appeared at that time.

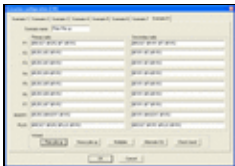
Date/Time	Thumbnail	Dimensions	User	Comment
current <a href="#">07:38, 6 October 2006</a>		723 × 508 (21 KB)	<a href="#">Ct1boh</a> ( <a href="#">talk</a>   <a href="#">contribs</a> )	

You cannot overwrite this file.

## File usage

The following 2 pages use this file:

- [Menu:Operating](#)
- [SO2R/Advanced SO2R](#)

## Namespaces

- [File](#)
- [Discussion](#)

## Variants

## Views

- [Read](#)
- [View source](#)
- [View history](#)

## More

- This page was last edited on 6 October 2006, at 07:38.
- [Privacy policy](#)
- [About Win-Test Wiki](#)
- [Disclaimers](#)



# File:Scenarios.PNG

From Win-Test Wiki

[Jump to navigation](#) [Jump to search](#)

- [File](#)
- [File history](#)
- [File usage](#)

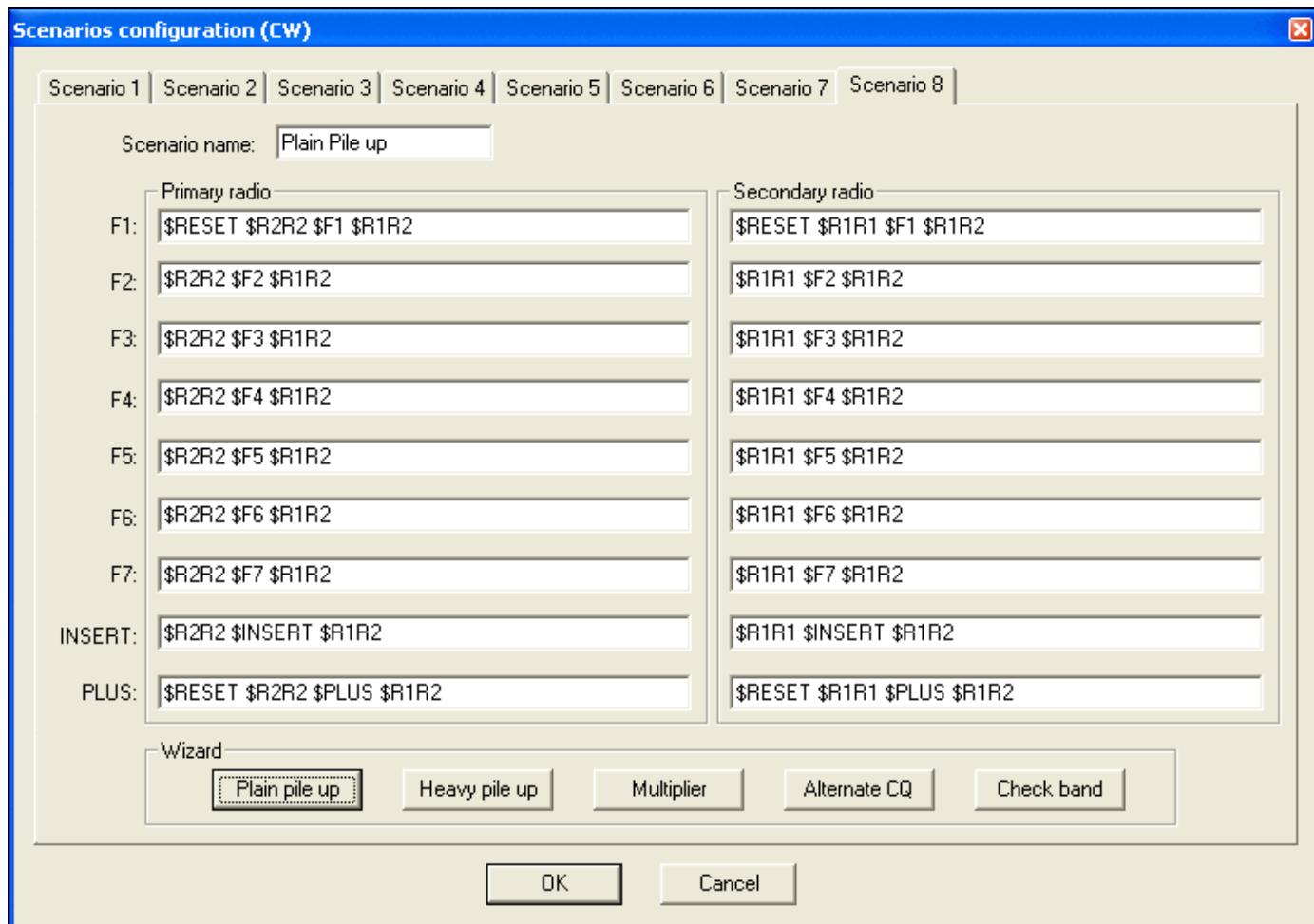

No higher resolution available.

Scenarios.PNG (723 × 508 pixels, file size: 21 KB, MIME type: image.gif)

## File history

Click on a date/time to view the file as it appeared at that time.

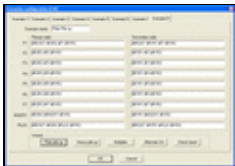
Date/Time	Thumbnail	Dimensions	User	Comment
current <u>07:38, 6 October 2006</u>		723 × 508 (21 KB)	<u>Ct1boh</u> ( <a href="#">talk</a>   <a href="#">contribs</a> )	

You cannot overwrite this file.

## File usage

The following 2 pages use this file:

- [Menu:Operating](#)
- [SO2R/Advanced SO2R](#)

## Namespaces

- [File](#)
- [Discussion](#)

## Variants

## Views

- [Read](#)
- [View source](#)
- [View history](#)

## More

- This page was last edited on 6 October 2006, at 07:38.
- [Privacy policy](#)
- [About Win-Test Wiki](#)
- [Disclaimers](#)





# File:Schema InterfaceCW.gif

From Win-Test Wiki

[Jump to navigation](#) [Jump to search](#)

- [File](#)
- [File history](#)
- [File usage](#)

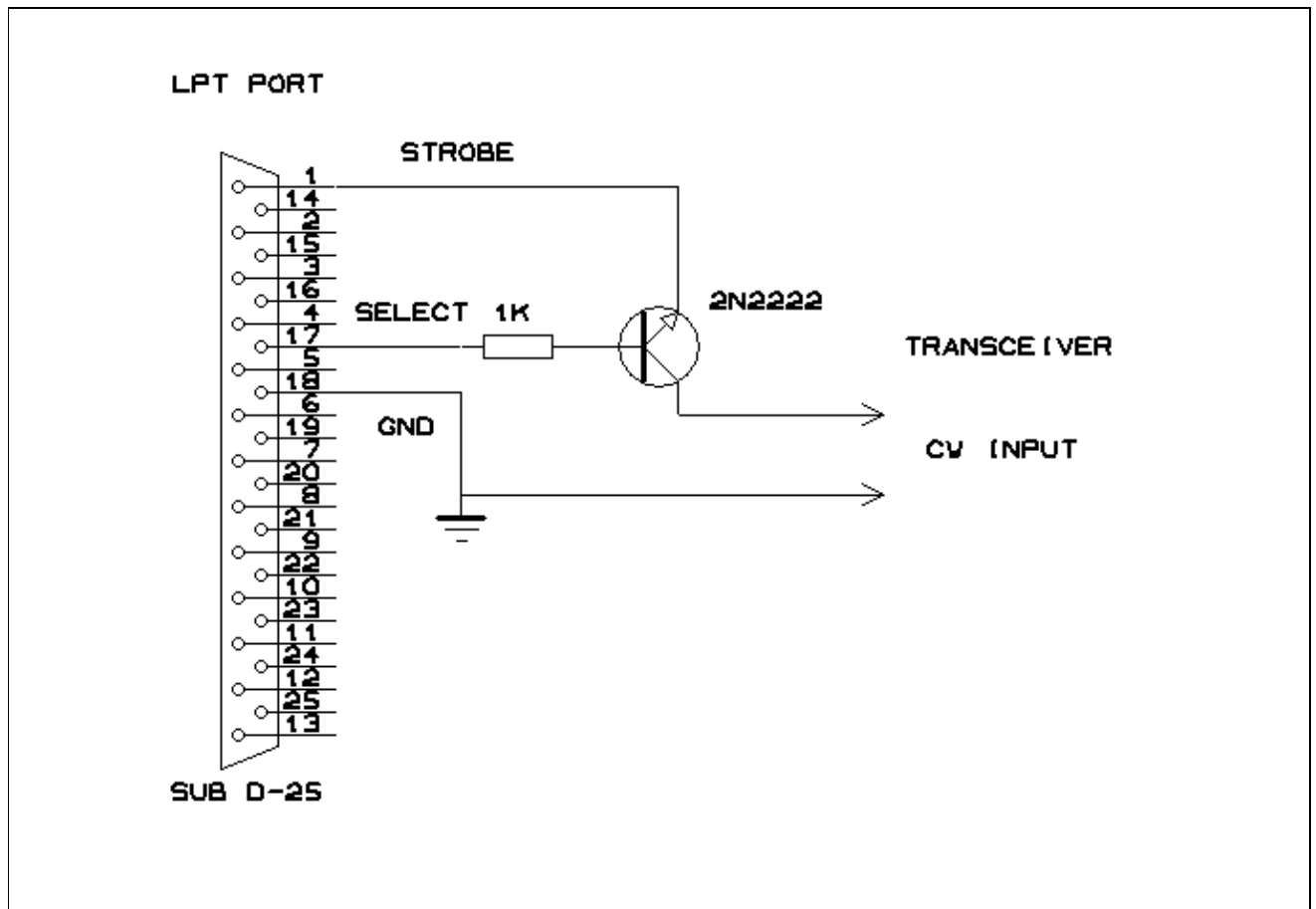

No higher resolution available.

Schema InterfaceCW.gif (683 Å 476 pixels, file size: 5 KB, MIME type: image/gif)

COM Port CW Interface

## File history

Click on a date/time to view the file as it appeared at that time.

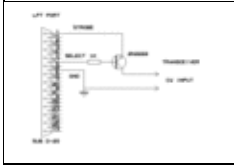
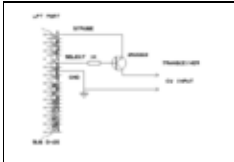
	Date/Time	Thumbnail	Dimensions	User	Comment
current	<a href="#">20:10, 24 August 2006</a>		683 Å 476 (5 KB)	<a href="#">Dl6rai (talk   contribs)</a>	LPT Port CW Interface
	<a href="#">20:08, 24 August 2006</a>		683 Å 476 (5 KB)	<a href="#">Dl6rai (talk   contribs)</a>	COM Port CW Interface

You cannot overwrite this file.

## File usage

The following page uses this file:

- [Interfaces](#)

## Namespaces

- [File](#)
- [Discussion](#)

## Variants

## Views

- [Read](#)
- [View source](#)
- [View history](#)

## More

- This page was last edited on 24 August 2006, at 20:08.
- [Privacy policy](#)
- [About Win-Test Wiki](#)
- [Disclaimers](#)



# File:Schema InterfaceCW.gif

From Win-Test Wiki

[Jump to navigation](#) [Jump to search](#)

- [File](#)
- [File history](#)
- [File usage](#)

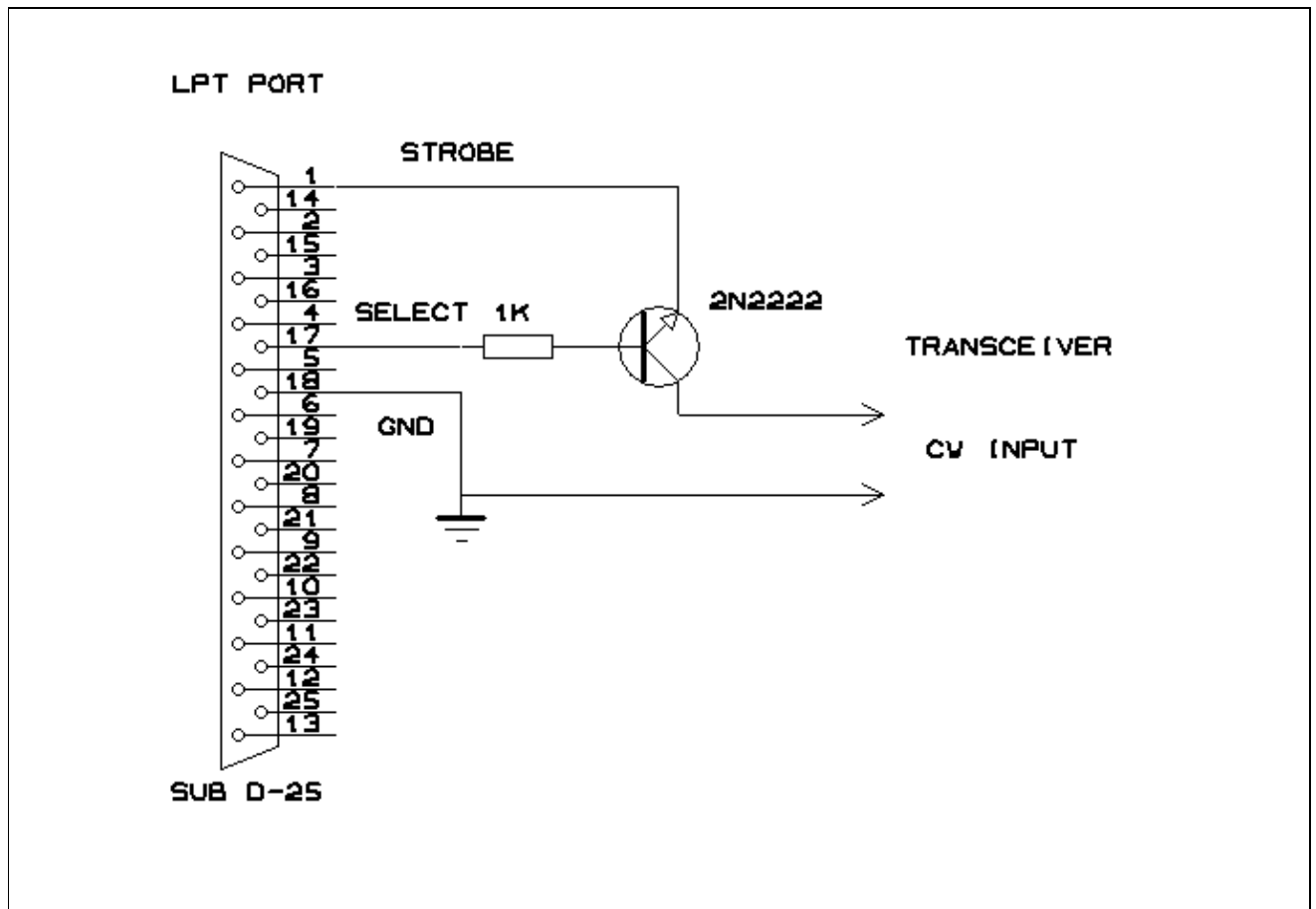

No higher resolution available.

Schema InterfaceCW.gif (683 Å 476 pixels, file size: 5 KB, MIME type: image/gif)

COM Port CW Interface

## File history

Click on a date/time to view the file as it appeared at that time.

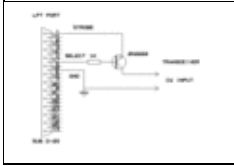
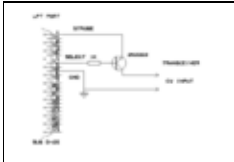
	Date/Time	Thumbnail	Dimensions	User	Comment
current	<a href="#">20:10, 24 August 2006</a>		683 Å 476 (5 KB)	<a href="#">Dl6rai (talk   contribs)</a>	LPT Port CW Interface
	<a href="#">20:08, 24 August 2006</a>		683 Å 476 (5 KB)	<a href="#">Dl6rai (talk   contribs)</a>	COM Port CW Interface

You cannot overwrite this file.

## File usage

The following page uses this file:

- [Interfaces](#)

## Namespaces

- [File](#)
- [Discussion](#)

## Variants

## Views

- [Read](#)
- [View source](#)
- [View history](#)

## More

- This page was last edited on 24 August 2006, at 20:08.
- [Privacy policy](#)
- [About Win-Test Wiki](#)
- [Disclaimers](#)



# File:Schema InterfaceDVK.gif

From Win-Test Wiki

[Jump to navigation](#) [Jump to search](#)

- [File](#)
- [File history](#)
- [File usage](#)

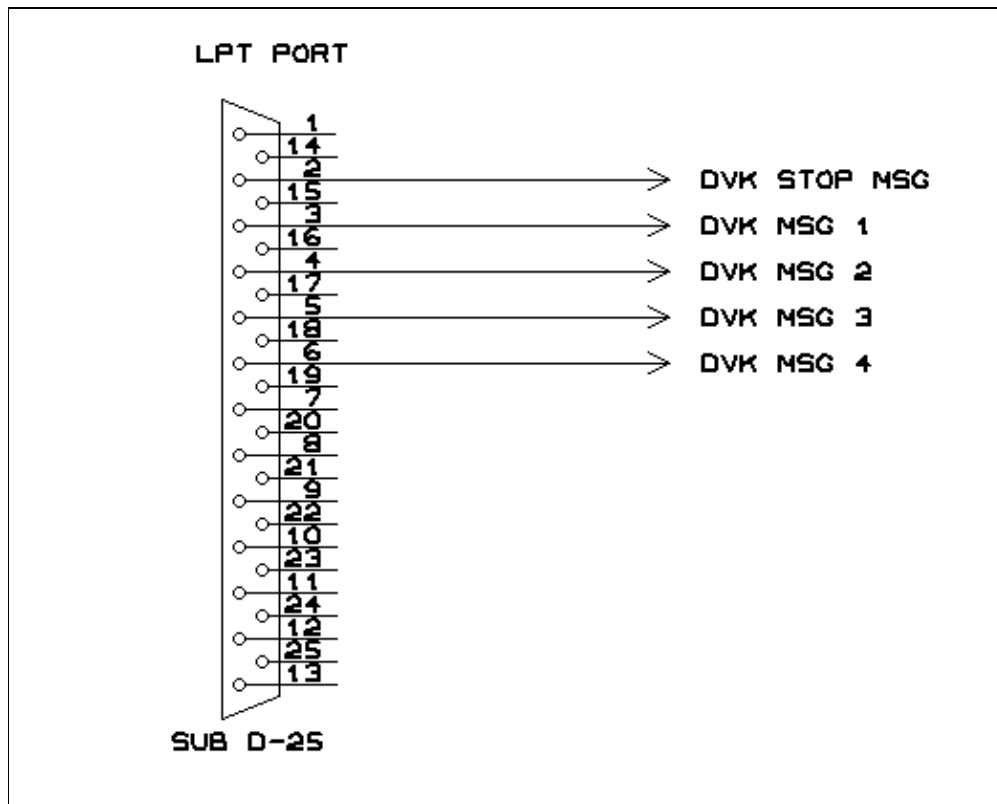

No higher resolution available.

[Schema\\_InterfaceDVK.gif](#) (522 × 419 pixels, file size: 4 KB, MIME type: image/gif)

Controlling an external digital voice keyer

## File history

Click on a date/time to view the file as it appeared at that time.

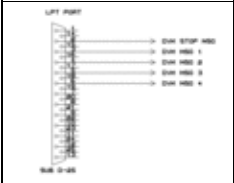
	Date/Time	Thumbnail	Dimensions	User	Comment
current	<a href="#">20:21, 24 August 2006</a>		522 × 419 (4 KB)	<a href="#">Dl6rai (talk   contribs)</a>	Controlling an external digital voice keyer

You cannot overwrite this file.

## File usage

The following page uses this file:

- [Interfaces](#)

## Namespaces

- [File](#)
- [Discussion](#)

## Variants

## Views

- [Read](#)
- [View source](#)
- [View history](#)

## More

- This page was last edited on 24 August 2006, at 20:21.
- [Privacy policy](#)
- [About Win-Test Wiki](#)
- [Disclaimers](#)





# File:Schema InterfaceDVK.gif

From Win-Test Wiki

[Jump to navigation](#) [Jump to search](#)

- [File](#)
- [File history](#)
- [File usage](#)

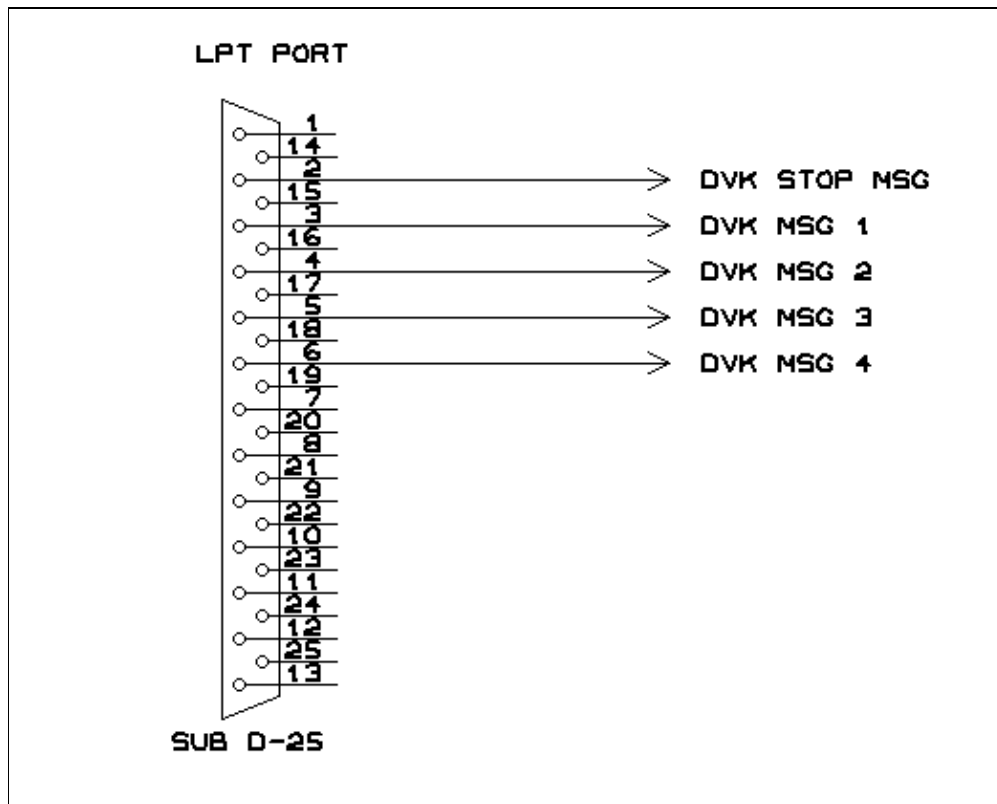

No higher resolution available.

Schema\_InterfaceDVK.gif (522 × 419 pixels, file size: 4 KB, MIME type: image/gif)

Controlling an external digital voice keyer

## File history

Click on a date/time to view the file as it appeared at that time.

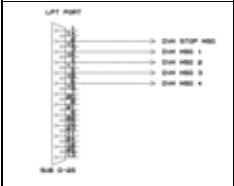
	Date/Time	Thumbnail	Dimensions	User	Comment
current	<u>20:21, 24 August 2006</u>		522 × 419 (4 KB)	<u>DI6rai</u> ( <a href="#">talk</a>   <a href="#">contribs</a> )	Controlling an external digital voice keyer

You cannot overwrite this file.

## File usage

The following page uses this file:

- [Interfaces](#)

## Namespaces

- [File](#)
- [Discussion](#)

## Variants

## Views

- [Read](#)
- [View source](#)
- [View history](#)

## More

- This page was last edited on 24 August 2006, at 20:21.

- [Privacy policy](#)
- [About Win-Test Wiki](#)
- [Disclaimers](#)



# File:Schema Interface SoundCard.gif

From Win-Test Wiki

[Jump to navigation](#) [Jump to search](#)

- [File](#)
- [File history](#)
- [File usage](#)

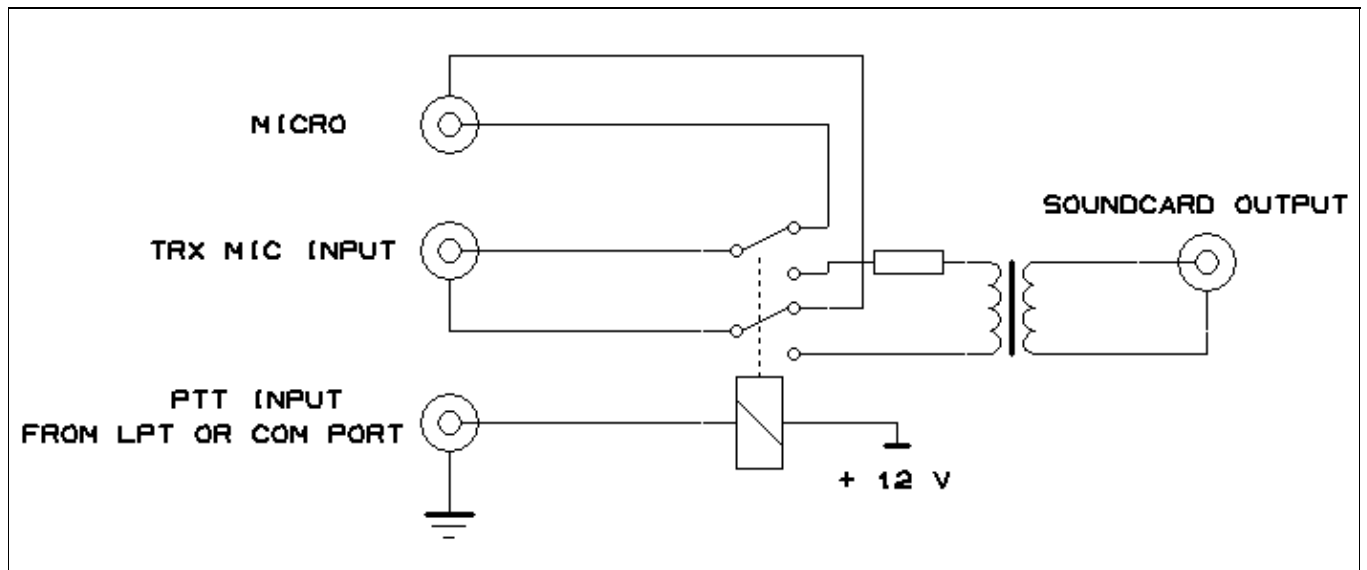

No higher resolution available.

[Schema Interface SoundCard.gif](#) (706 × 295 pixels, file size: 4 KB, MIME type: image/gif)

Interface for sound card voice replay

## File history

Click on a date/time to view the file as it appeared at that time.

	Date/Time	Thumbnail	Dimensions	User	Comment
current	<a href="#">20:22, 24 August 2006</a>		706 × 295 (4 KB)	<a href="#">D16rai (talk   contribs)</a>	Interface for sound card voice replay

You cannot overwrite this file.

## File usage

The following page uses this file:

- [Interfaces](#)

## Namespaces

- [File](#)
- [Discussion](#)

## Variants

## Views

- [Read](#)
- [View source](#)
- [View history](#)

## More

- This page was last edited on 24 August 2006, at 20:22.
- [Privacy policy](#)
- [About Win-Test Wiki](#)
- [Disclaimers](#)



# File:Schema Interface SoundCard.gif

From Win-Test Wiki

[Jump to navigation](#) [Jump to search](#)

- [File](#)
- [File history](#)
- [File usage](#)

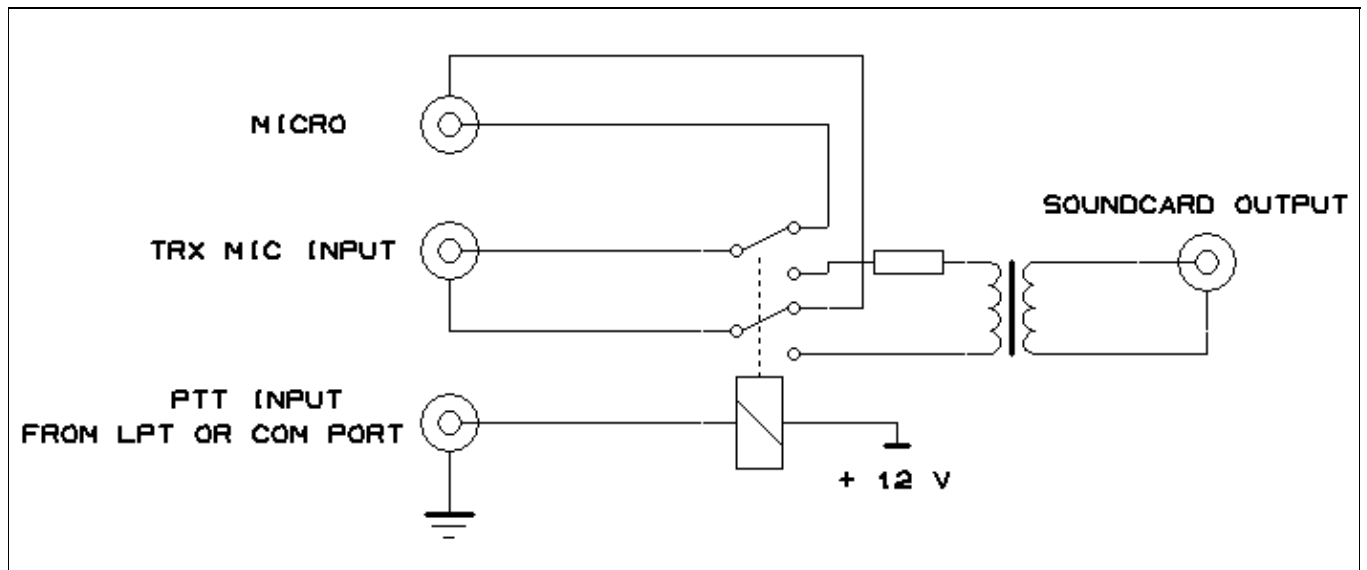

No higher resolution available.

[Schema Interface SoundCard.gif](#) (706 × 295 pixels, file size: 4 KB, MIME type: image/gif)

Interface for sound card voice replay

## File history

Click on a date/time to view the file as it appeared at that time.

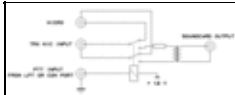
	Date/Time	Thumbnail	Dimensions	User	Comment
current	<a href="#">20:22, 24 August 2006</a>		706 × 295 (4 KB)	<a href="#">Dl6rai</a> ( <a href="#">talk</a>   <a href="#">contribs</a> )	Interface for sound card voice replay

You cannot overwrite this file.

## File usage

The following page uses this file:

- [Interfaces](#)

## Namespaces

- [File](#)
- [Discussion](#)

## Variants

## Views

- [Read](#)
- [View source](#)
- [View history](#)

## More

- This page was last edited on 24 August 2006, at 20:22.
- [Privacy policy](#)
- [About Win-Test Wiki](#)
- [Disclaimers](#)



# File:SearchForPossibleBadExchanges.PNG

From Win-Test Wiki

[Jump to navigation](#) [Jump to search](#)

- [File](#)
- [File history](#)
- [File usage](#)

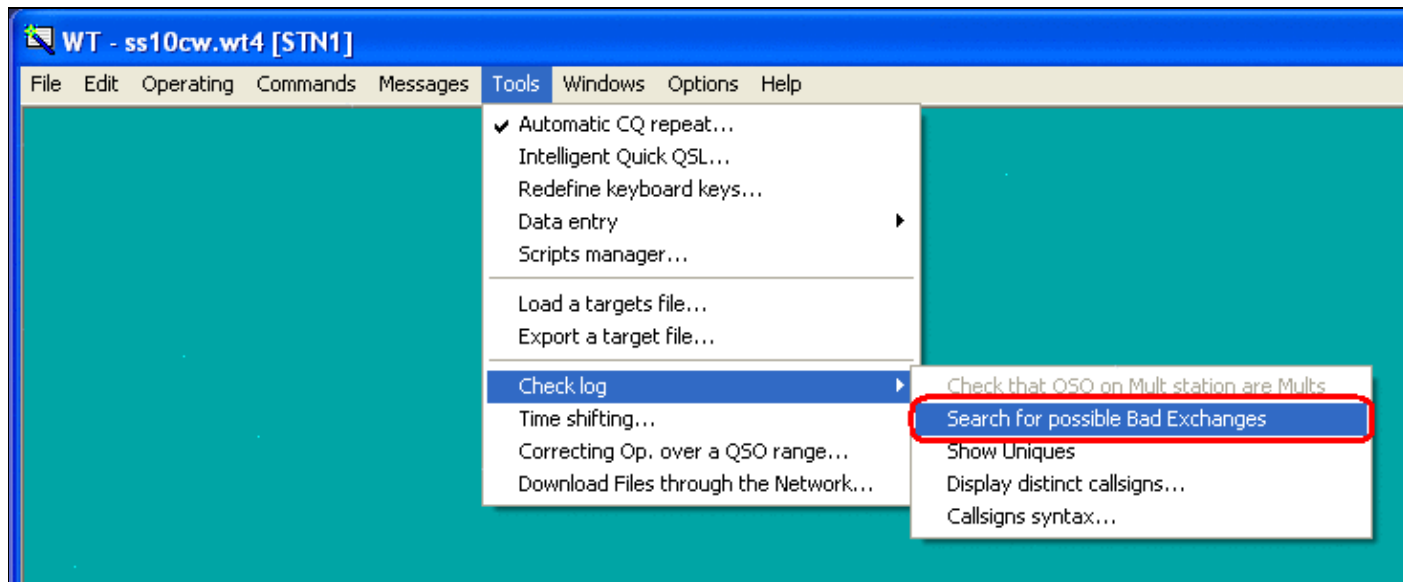

No higher resolution available.

[SearchForPossibleBadExchanges.PNG](#) (744 × 301 pixels, file size: 15 KB, MIME type: image.gif)

Menu to select Check for Possible bad exchanges

## File history

Click on a date/time to view the file as it appeared at that time.

	Date/Time	Thumbnail	Dimensions	User	Comment
current	<a href="#">18:15, 9 November 2010</a>		744 × 301 (15 KB)	<a href="#">N6TV</a> ( <a href="#">talk</a>   <a href="#">contribs</a> )	Menu to select Check for Possible bad exchanges

You cannot overwrite this file.

## File usage

The following page uses this file:

- [Sweepstakes](#)

## Namespaces

- [File](#)
- [Discussion](#)

## Variants

## Views

- [Read](#)
- [View source](#)
- [View history](#)

## More

- This page was last edited on 9 November 2010, at 18:15.
- [Privacy policy](#)
- [About Win-Test Wiki](#)
- [Disclaimers](#)





# File:SearchForPossibleBadExchanges.PNG

From Win-Test Wiki

[Jump to navigation](#) [Jump to search](#)

- [File](#)
- [File history](#)
- [File usage](#)

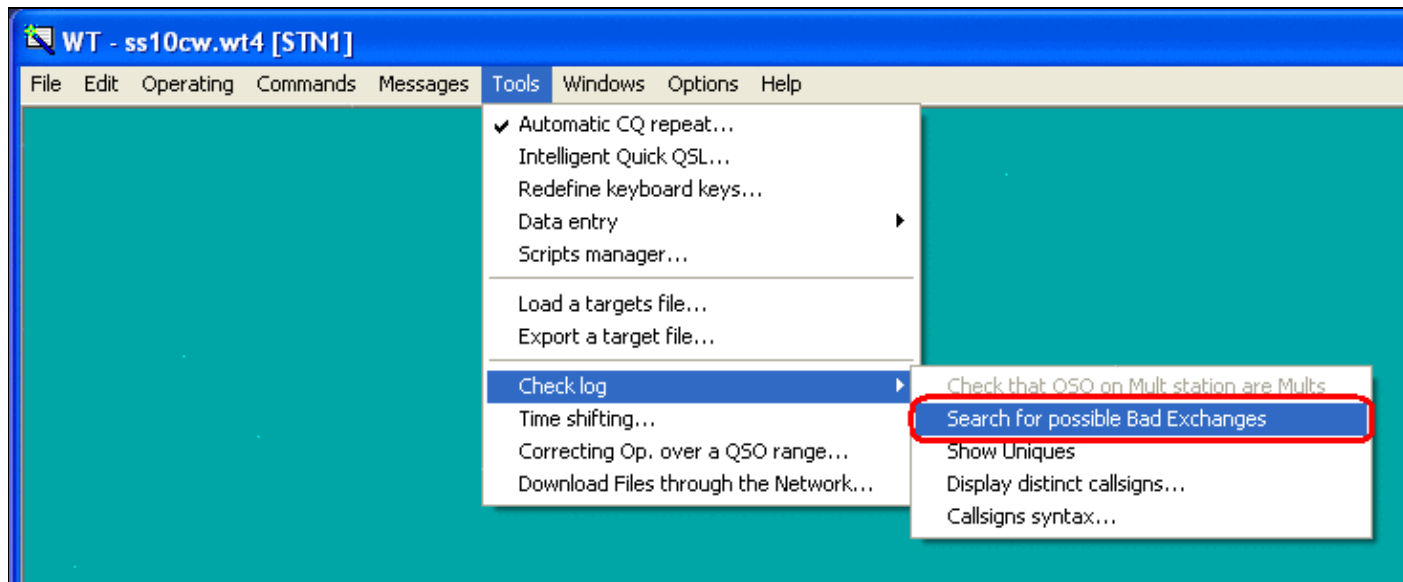

No higher resolution available.

[SearchForPossibleBadExchanges.PNG](#) (744 × 301 pixels, file size: 15 KB, MIME type: image.gif)

Menu to select Check for Possible bad exchanges

## File history

Click on a date/time to view the file as it appeared at that time.

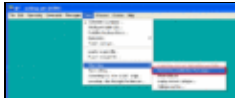
	Date/Time	Thumbnail	Dimensions	User	Comment
current	<a href="#">18:15, 9 November 2010</a>		744 × 301 (15 KB)	<a href="#">N6TV</a> ( <a href="#">talk</a>   <a href="#">contribs</a> )	Menu to select Check for Possible bad exchanges

You cannot overwrite this file.

## File usage

The following page uses this file:

- [Sweepstakes](#)

## Namespaces

- [File](#)
- [Discussion](#)

## Variants

## Views

- [Read](#)
- [View source](#)
- [View history](#)

## More

- This page was last edited on 9 November 2010, at 18:15.
- [Privacy policy](#)
- [About Win-Test Wiki](#)
- [Disclaimers](#)



# File:SearchForPossibleBadExchangesReport.PNG

From Win-Test Wiki

[Jump to navigation](#) [Jump to search](#)

- [File](#)
- [File history](#)
- [File usage](#)

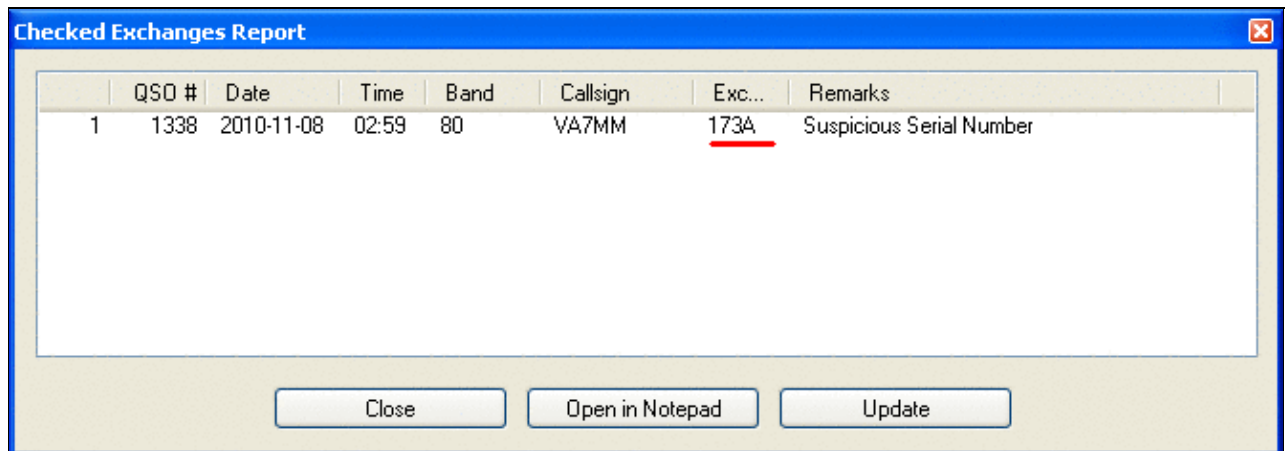

No higher resolution available.

[SearchForPossibleBadExchangesReport.PNG](#) (666 Å 234 pixels, file size: 9 KB, MIME type: image.gif)

ARRL Sweepstakes report, search for possible bad exchanges.

## File history

Click on a date/time to view the file as it appeared at that time.

	Date/Time	Thumbnail	Dimensions	User	Comment
current	<a href="#">18:16, 9 November 2010</a>		666 Å 234 (9 KB)	<a href="#">N6TV</a> ( <a href="#">talk</a>   <a href="#">contribs</a> )	ARRL Sweepstakes report, search for possible bad exchanges.

You cannot overwrite this file.

## File usage

The following page uses this file:

- [Sweepstakes](#)

## Namespaces

- [File](#)
- [Discussion](#)

## Variants

## Views

- [Read](#)
- [View source](#)
- [View history](#)

## More

- This page was last edited on 9 November 2010, at 18:16.

- [Privacy policy](#)
- [About Win-Test Wiki](#)
- [Disclaimers](#)



# File:SearchForPossibleBadExchangesReport.PNG

From Win-Test Wiki

[Jump to navigation](#) [Jump to search](#)

- [File](#)
- [File history](#)
- [File usage](#)

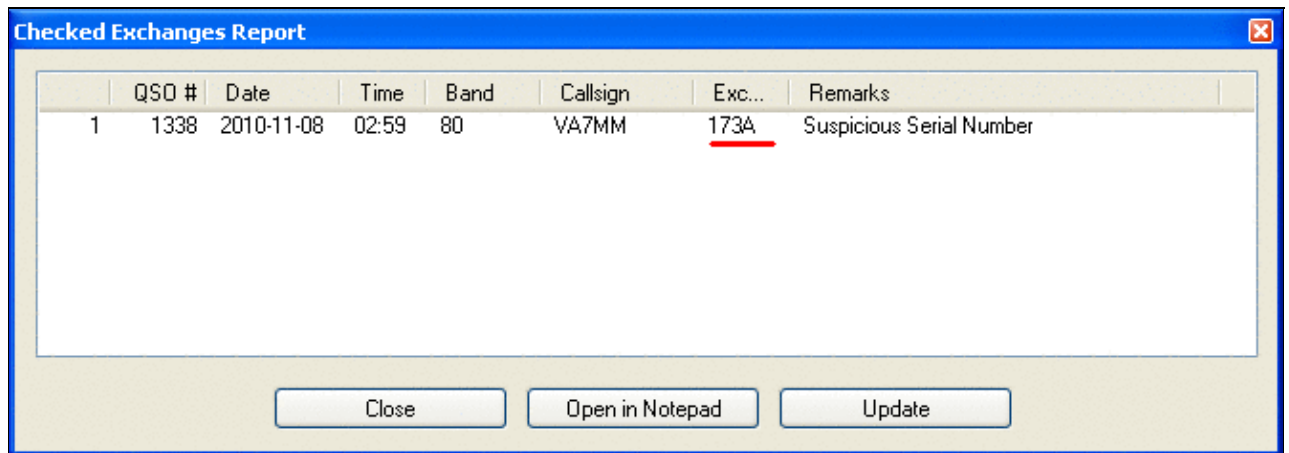

No higher resolution available.

[SearchForPossibleBadExchangesReport.PNG](#) (666 Å 234 pixels, file size: 9 KB, MIME type: image.gif)

ARRL Sweepstakes report, search for possible bad exchanges.

## File history

Click on a date/time to view the file as it appeared at that time.

	Date/Time	Thumbnail	Dimensions	User	Comment
current	<a href="#">18:16, 9 November 2010</a>		666 Å 234 (9 KB)	<a href="#">N6TV</a> ( <a href="#">talk</a>   <a href="#">contribs</a> )	ARRL Sweepstakes report, search for possible bad exchanges.

You cannot overwrite this file.

## File usage

The following page uses this file:

- [Sweepstakes](#)

## Namespaces

- [File](#)
- [Discussion](#)

## Variants

## Views

- [Read](#)
- [View source](#)
- [View history](#)

## More

- This page was last edited on 9 November 2010, at 18:16.

- [Privacy policy](#)
- [About Win-Test Wiki](#)
- [Disclaimers](#)



# File:SecondaryRadioRunSandP.gif

From Win-Test Wiki

[Jump to navigation](#) [Jump to search](#)

- [File](#)
- [File history](#)
- [File usage](#)



No higher resolution available.

[SecondaryRadioRunSandP.gif](#) (408 × 227 pixels, file size: 8 KB, MIME type: image/gif)

Secondary radio window with Run and S&P options visible.

## File history

Click on a date/time to view the file as it appeared at that time.

	Date/Time	Thumbnail	Dimensions	User	Comment
current	<a href="#">19:19, 15 January 2008</a>		408 × 227 (8 KB)	<a href="#">N6TV (talk   contribs)</a>	Secondary radio window with Run and S&P options visible.

You cannot overwrite this file.

## File usage

The following page uses this file:

- [SO2R/Second radio window](#)

## Namespaces

- [File](#)
- [Discussion](#)

## Variants

## Views

- [Read](#)
- [View source](#)
- [View history](#)

## More

- This page was last edited on 15 January 2008, at 19:19.

- [Privacy policy](#)
- [About Win-Test Wiki](#)
- [Disclaimers](#)





# File:SecondaryRadioRunSandP.gif

From Win-Test Wiki

[Jump to navigation](#) [Jump to search](#)

- [File](#)
- [File history](#)
- [File usage](#)



No higher resolution available.

[SecondaryRadioRunSandP.gif](#) (408 × 227 pixels, file size: 8 KB, MIME type: image/gif)

Secondary radio window with Run and S&P options visible.

## File history

Click on a date/time to view the file as it appeared at that time.

	Date/Time	Thumbnail	Dimensions	User	Comment
current	<a href="#">19:19, 15 January 2008</a>		408 × 227 (8 KB)	<a href="#">N6TV (talk   contribs)</a>	Secondary radio window with Run and S&P options visible.

You cannot overwrite this file.

## File usage

The following page uses this file:

- [SO2R/Second radio window](#)

## Namespaces

- [File](#)
- [Discussion](#)

## Variants

## Views

- [Read](#)
- [View source](#)
- [View history](#)

## More

- This page was last edited on 15 January 2008, at 19:19.

- [Privacy policy](#)
- [About Win-Test Wiki](#)
- [Disclaimers](#)



# File:secondary window.PNG

From Win-Test Wiki

[Jump to navigation](#) [Jump to search](#)

- [File](#)
- [File history](#)
- [File usage](#)



No higher resolution available.

[secondary\\_window.PNG](#) (407 × 199 pixels, file size: 6 KB, MIME type: image/gif)

Secondary radio window

## File history

Click on a date/time to view the file as it appeared at that time.

	Date/Time	Thumbnail	Dimensions	User	Comment
current	<a href="#">08:33, 5 October 2006</a>		407 × 199 (6 KB)	<a href="#">Ct1boh (talk   contribs)</a>	Secondary radio window
	<a href="#">08:32, 5 October 2006</a>		407 × 199 (6 KB)	<a href="#">Ct1boh (talk   contribs)</a>	Secondary radio window

You cannot overwrite this file.

## File usage

The following file is a duplicate of this file ([more details](#)):

- [File:WindowsSecondaryRadio.gif](#)

The following 2 pages use this file:

- [Menu:Windows](#)

File:secondary window.PNG

1663

- [SO2R/Second radio window](#)

## Namespaces

- [File](#)
- [Discussion](#)

## Variants

## Views

- [Read](#)
- [View source](#)
- [View history](#)

## More

- This page was last edited on 5 October 2006, at 08:32.

- [Privacy policy](#)
- [About Win-Test Wiki](#)
- [Disclaimers](#)



# File:secondary window.PNG

From Win-Test Wiki

[Jump to navigation](#) [Jump to search](#)

- [File](#)
- [File history](#)
- [File usage](#)

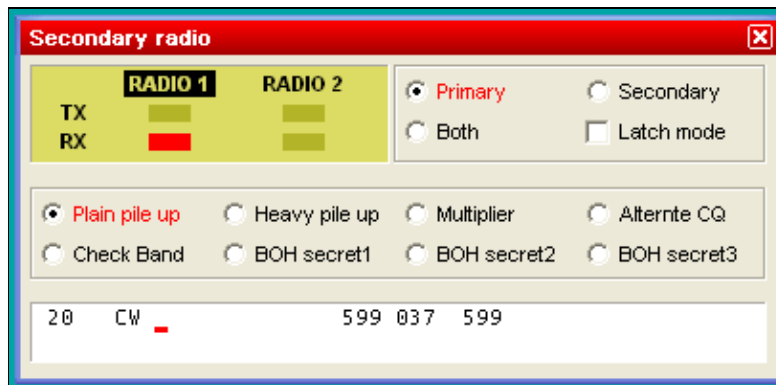

No higher resolution available.

[secondary\\_window.PNG](#) (407 × 199 pixels, file size: 6 KB, MIME type: image/gif)

Secondary radio window

## File history

Click on a date/time to view the file as it appeared at that time.

	Date/Time	Thumbnail	Dimensions	User	Comment
current	<a href="#">08:33, 5 October 2006</a>		407 × 199 (6 KB)	<a href="#">Ct1boh (talk   contribs)</a>	Secondary radio window
	<a href="#">08:32, 5 October 2006</a>		407 × 199 (6 KB)	<a href="#">Ct1boh (talk   contribs)</a>	Secondary radio window

You cannot overwrite this file.

## File usage

The following file is a duplicate of this file ([more details](#)):

- [File:WindowsSecondaryRadio.gif](#)

The following 2 pages use this file:

- [Menu:Windows](#)

File:secondary window.PNG

1665

- [SO2R/Second radio window](#)

## Namespaces

- [File](#)
- [Discussion](#)

## Variants

## Views

- [Read](#)
- [View source](#)
- [View history](#)

## More

- This page was last edited on 5 October 2006, at 08:32.

- [Privacy policy](#)
- [About Win-Test Wiki](#)
- [Disclaimers](#)



# File:SetupConfigureMKControl.gif

From Win-Test Wiki

[Jump to navigation](#) [Jump to search](#)

- [File](#)
- [File history](#)
- [File usage](#)

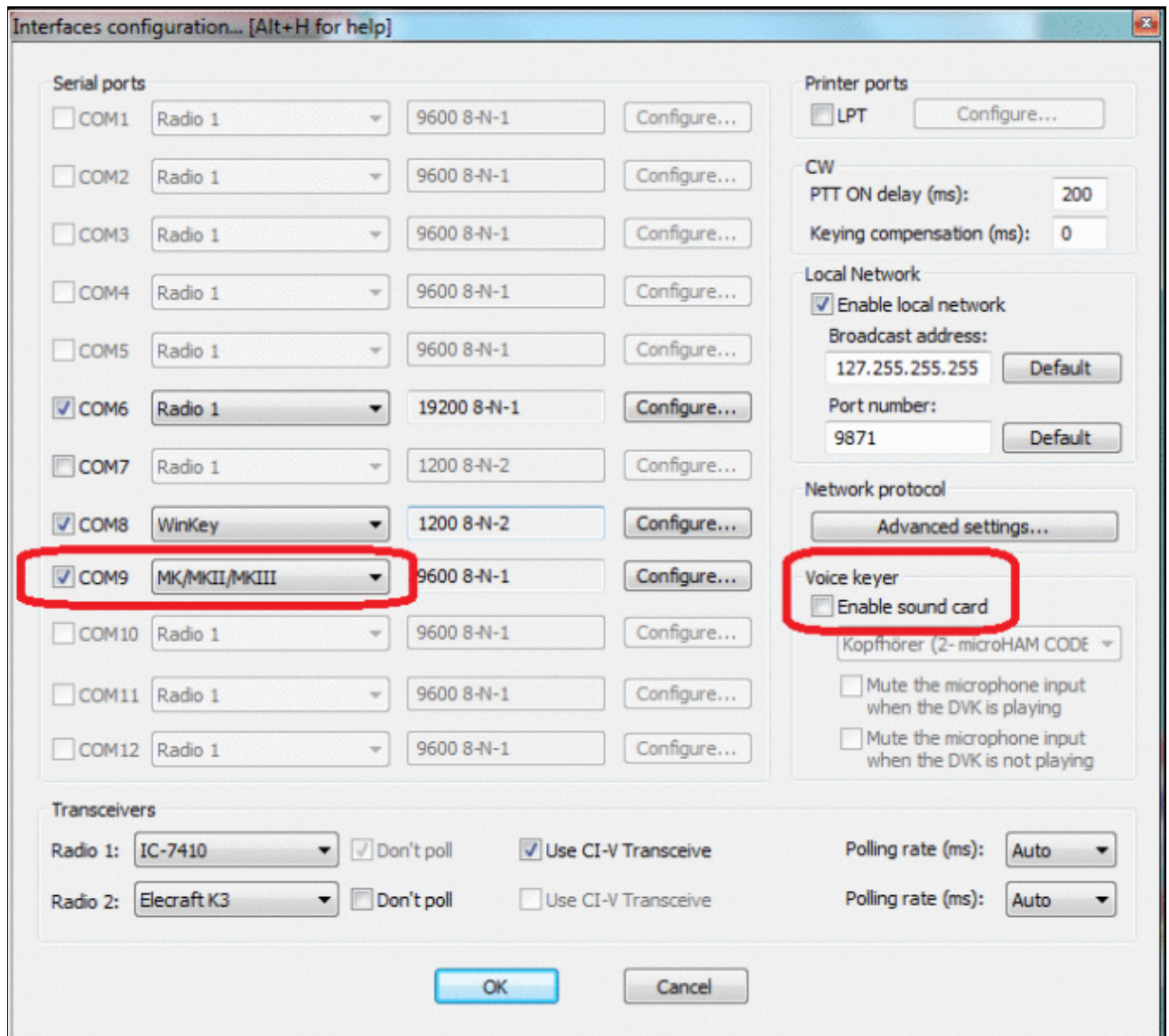

Size of this preview: [670 × 600 pixels](#). Other resolutions: [268 × 240 pixels](#) | [678 × 607 pixels](#).  
[Original file](#) (678 × 607 pixels, file size: 83 KB, MIME type: image.gif)

## File history

Click on a date/time to view the file as it appeared at that time.

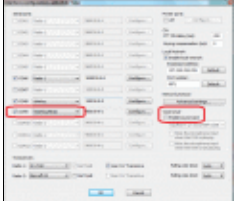
Date/Time	Thumbnail	Dimensions	User	Comment
current <a href="#">07:58, 2 March 2021</a>		<a href="#">678 × 607</a> (83 KB)	<a href="#">Dl6rai</a> ( <a href="#">talk</a>   <a href="#">contribs</a> )	

You cannot overwrite this file.

## File usage

The following page uses this file:

- [DVK CW RTTY Messaging](#)

## Namespaces

- [File](#)
- [Discussion](#)

## Variants

## Views

- [Read](#)
- [View source](#)
- [View history](#)

## More

- This page was last edited on 2 March 2021, at 07:58.

- [Privacy policy](#)
- [About Win-Test Wiki](#)
- [Disclaimers](#)





# File:SetupConfigureMKControl.gif

From Win-Test Wiki

[Jump to navigation](#) [Jump to search](#)

- [File](#)
- [File history](#)
- [File usage](#)

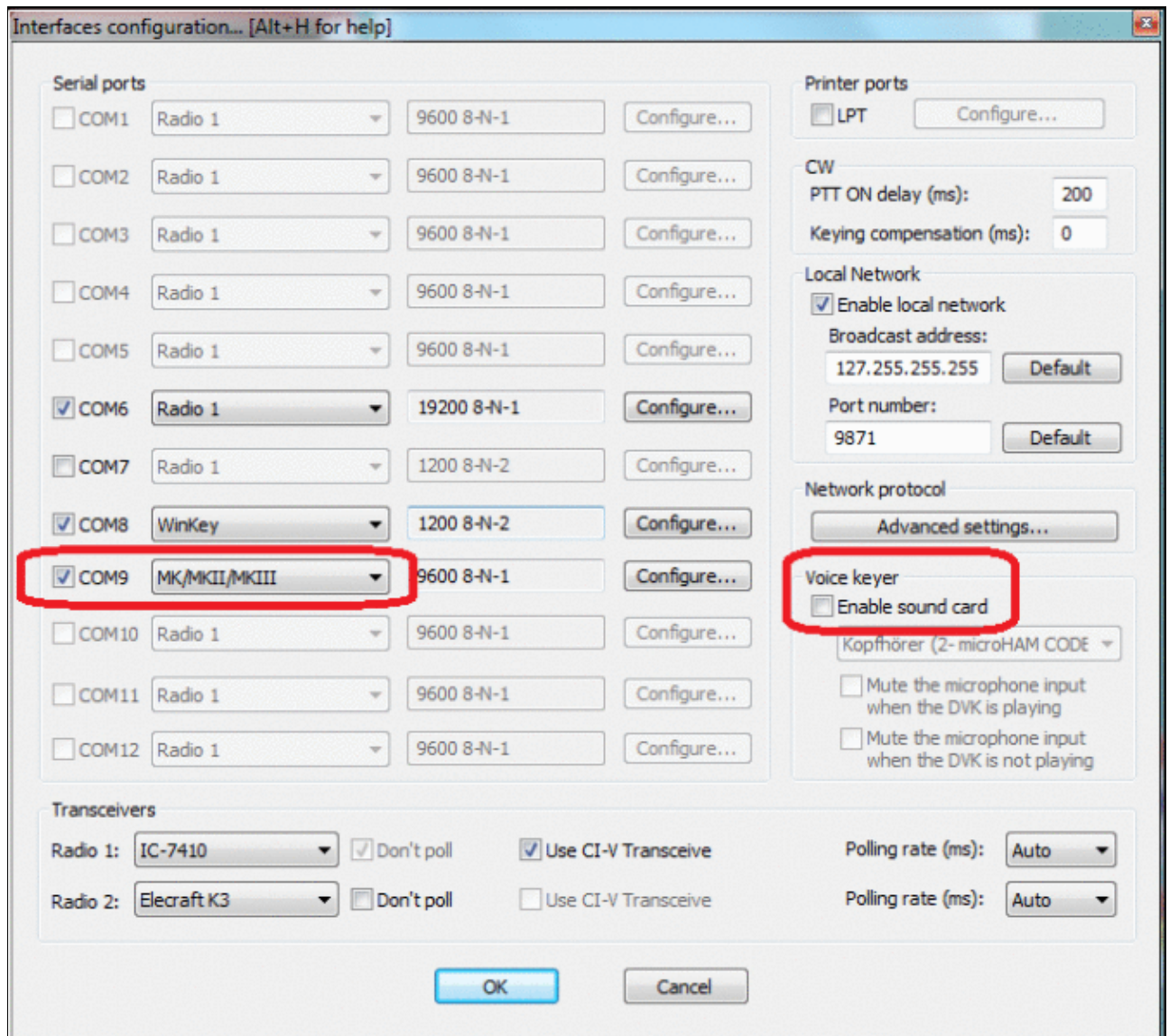

Size of this preview: 670 Å 600 pixels. Other resolutions: 268 Å 240 pixels | 678 Å 607 pixels. Original file (678 Å 607 pixels, file size: 83 KB, MIME type: image.gif)

## File history

Click on a date/time to view the file as it appeared at that time.

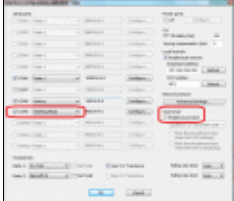
Date/Time	Thumbnail	Dimensions	User	Comment
current <u>07:58, 2 March 2021</u>		678 Å 607 (83 KB)	<u>Dl6rai</u> ( <a href="#">talk</a>   <a href="#">contribs</a> )	

You cannot overwrite this file.

## File usage

The following page uses this file:

- DVK CW RTTY Messaging

## Namespaces

- File
- Discussion

## Variants

## Views

- Read
- View source
- View history

## More

- This page was last edited on 2 March 2021, at 07:58.

- Privacy policy
- About Win-Test Wiki
- Disclaimers



# File:SigmaTelAudioDialog1.gif

From Win-Test Wiki

[Jump to navigation](#) [Jump to search](#)

- [File](#)
- [File history](#)
- [File usage](#)

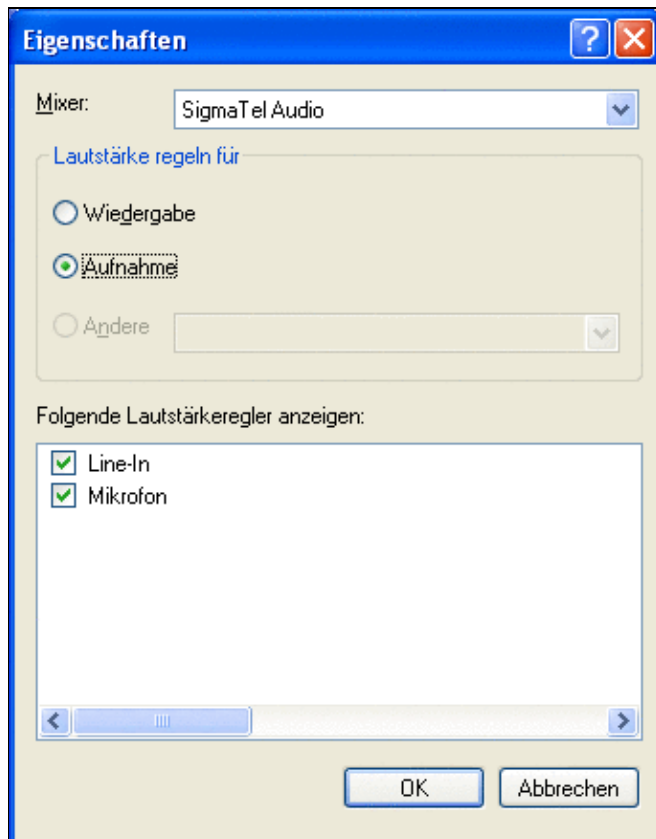



No higher resolution available.

[SigmaTelAudioDialog1.gif](#) (342 × 438 pixels, file size: 15 KB, MIME type: image/gif)

## File history

Click on a date/time to view the file as it appeared at that time.

Date/Time	Thumbnail	Dimensions	User	Comment
current <a href="#">09:19, 5 January 2007</a>		342 × 438 (15 KB)	<a href="#">Dl6rai</a> ( <a href="#">talk</a>   <a href="#">contribs</a> )	
<a href="#">09:18, 5 January 2007</a>		342 × 438 (15 KB)	<a href="#">Dl6rai</a> ( <a href="#">talk</a>   <a href="#">contribs</a> )	

You cannot overwrite this file.

## File usage

The following 2 pages use this file:

- [BestPractice1](#)
- [BestPractice4](#)

## Namespaces

- [File](#)
- [Discussion](#)

## Variants

## Views

- [Read](#)
- [View source](#)
- [View history](#)

## More

- This page was last edited on 5 January 2007, at 09:18.
- [Privacy policy](#)

## Win-Test Wiki

- [About Win-Test Wiki](#)
- [Disclaimers](#)



# File:SigmaTelAudioDialog1.gif

From Win-Test Wiki

[Jump to navigation](#) [Jump to search](#)

- [File](#)
- [File history](#)
- [File usage](#)

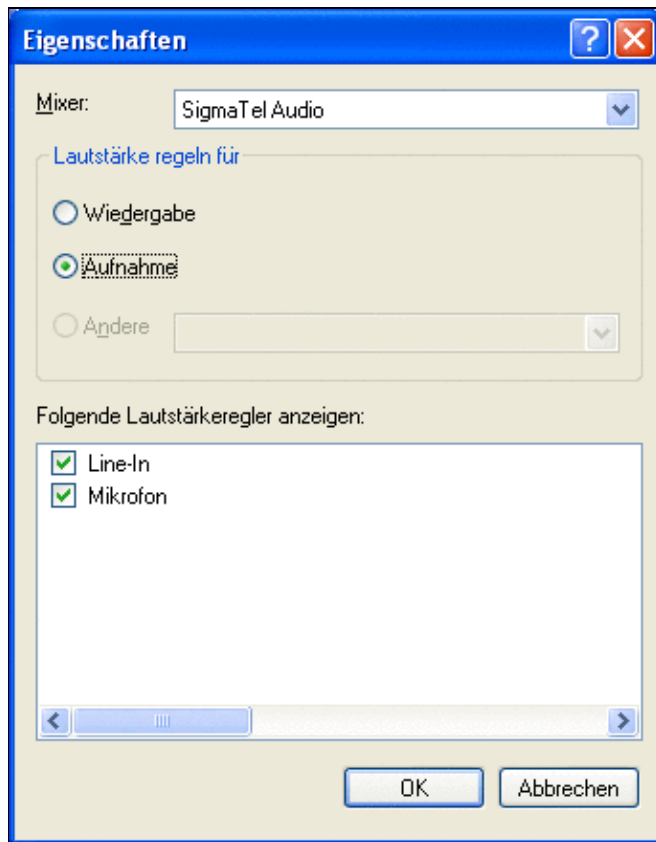



No higher resolution available.

[SigmaTelAudioDialog1.gif](#) (342 × 438 pixels, file size: 15 KB, MIME type: image.gif)

## File history

Click on a date/time to view the file as it appeared at that time.

Date/Time	Thumbnail	Dimensions	User	Comment
current <a href="#">09:19, 5 January 2007</a>		342 × 438 (15 KB)	<a href="#">Dl6rai</a> ( <a href="#">talk</a>   <a href="#">contribs</a> )	
<a href="#">09:18, 5 January 2007</a>		342 × 438 (15 KB)	<a href="#">Dl6rai</a> ( <a href="#">talk</a>   <a href="#">contribs</a> )	

You cannot overwrite this file.

## File usage

The following 2 pages use this file:

- [BestPractice1](#)
- [BestPractice4](#)

## Namespaces

- [File](#)
- [Discussion](#)

## Variants

## Views

- [Read](#)
- [View source](#)
- [View history](#)

## More

- This page was last edited on 5 January 2007, at 09:18.
- [Privacy policy](#)

- [About Win-Test Wiki](#)
- [Disclaimers](#)





# File:SigmaTelAudioDialog2.gif

From Win-Test Wiki

[Jump to navigation](#) [Jump to search](#)

- [File](#)
- [File history](#)
- [File usage](#)

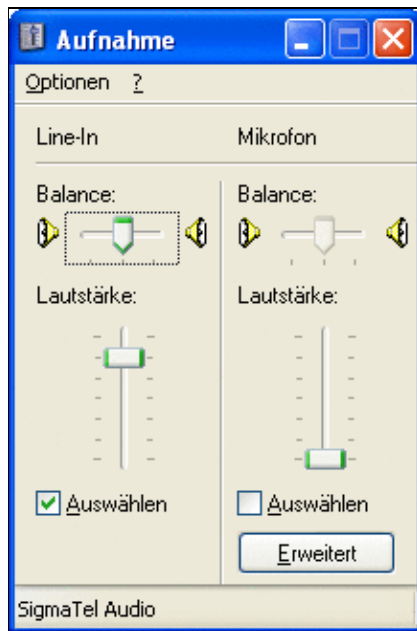

No higher resolution available.

[SigmaTelAudioDialog2.gif](#) (216 × 327 pixels, file size: 14 KB, MIME type: image.gif)

## File history

Click on a date/time to view the file as it appeared at that time.

Date/Time	Thumbnail	Dimensions	User	Comment
current <a href="#">09:19, 5 January 2007</a>		216 × 327 (14 KB)	<a href="#">Dl6rai</a> ( <a href="#">talk</a>   <a href="#">contribs</a> )	

You cannot overwrite this file.

## File usage

The following 2 pages use this file:

- [BestPractice1](#)
- [BestPractice4](#)

## Namespaces

- [File](#)
- [Discussion](#)

## Variants

## Views

- [Read](#)
- [View source](#)
- [View history](#)

## More

- This page was last edited on 5 January 2007, at 09:19.

- [Privacy policy](#)
- [About Win-Test Wiki](#)
- [Disclaimers](#)



# File:SigmaTelAudioDialog2.gif

From Win-Test Wiki

[Jump to navigation](#) [Jump to search](#)

- [File](#)
- [File history](#)
- [File usage](#)

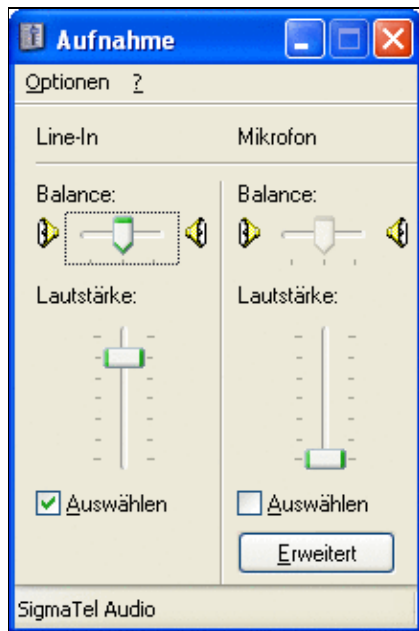

No higher resolution available.

[SigmaTelAudioDialog2.gif](#) (216 × 327 pixels, file size: 14 KB, MIME type: image/gif)

## File history

Click on a date/time to view the file as it appeared at that time.

Date/Time	Thumbnail	Dimensions	User	Comment
current <a href="#">09:19, 5 January 2007</a>		216 × 327 (14 KB)	<a href="#">Dl6rai</a> ( <a href="#">talk</a>   <a href="#">contribs</a> )	

You cannot overwrite this file.

## File usage

The following 2 pages use this file:

File:SigmaTelAudioDialog2.gif

1679

- [BestPractice1](#)
- [BestPractice4](#)

## Namespaces

- [File](#)
- [Discussion](#)

## Variants

## Views

- [Read](#)
- [View source](#)
- [View history](#)

## More

- This page was last edited on 5 January 2007, at 09:19.

- [Privacy policy](#)
- [About Win-Test Wiki](#)
- [Disclaimers](#)



# File:SkedsWindow.gif

From Win-Test Wiki

[Jump to navigation](#) [Jump to search](#)

- [File](#)
- [File history](#)
- [File usage](#)

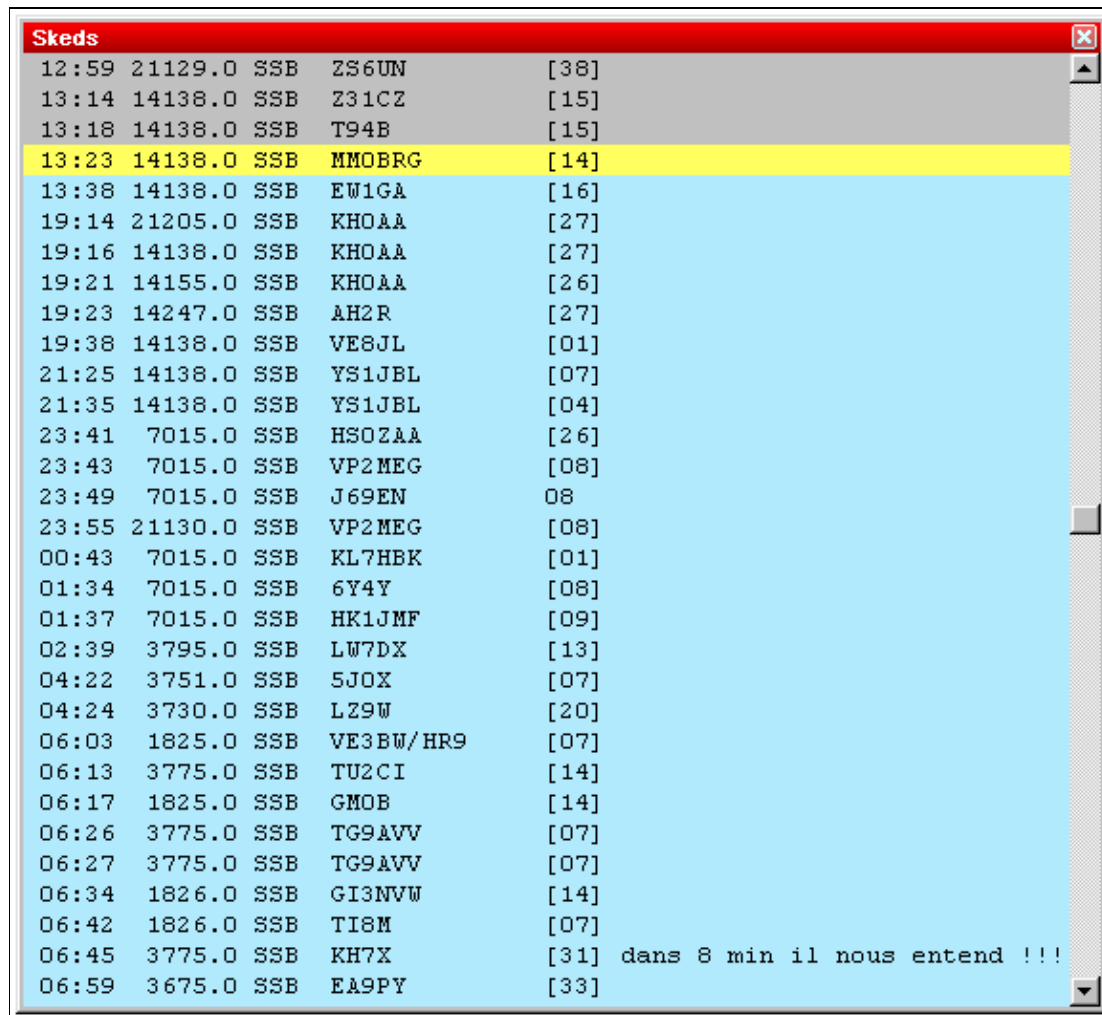

Time	Freq	Mode	Call Sign	Duration
12:59	21129.0	SSB	ZS6UN	[38]
13:14	14138.0	SSB	Z31CZ	[15]
13:18	14138.0	SSB	T94B	[15]
13:23	14138.0	SSB	MMOBRG	[14]
13:38	14138.0	SSB	EW1GA	[16]
19:14	21205.0	SSB	KHOAA	[27]
19:16	14138.0	SSB	KHOAA	[27]
19:21	14155.0	SSB	KHOAA	[26]
19:23	14247.0	SSB	AH2R	[27]
19:38	14138.0	SSB	VE8JL	[01]
21:25	14138.0	SSB	YS1JBL	[07]
21:35	14138.0	SSB	YS1JBL	[04]
23:41	7015.0	SSB	HSOZAA	[26]
23:43	7015.0	SSB	VP2MEG	[08]
23:49	7015.0	SSB	J69EN	08
23:55	21130.0	SSB	VP2MEG	[08]
00:43	7015.0	SSB	KL7HBK	[01]
01:34	7015.0	SSB	6Y4Y	[08]
01:37	7015.0	SSB	HK1JMF	[09]
02:39	3795.0	SSB	LW7DX	[13]
04:22	3751.0	SSB	5JOX	[07]
04:24	3730.0	SSB	LZ9W	[20]
06:03	1825.0	SSB	VE3BW/HR9	[07]
06:13	3775.0	SSB	TU2CI	[14]
06:17	1825.0	SSB	GMOB	[14]
06:26	3775.0	SSB	TG9AVV	[07]
06:27	3775.0	SSB	TG9AVV	[07]
06:34	1826.0	SSB	GI3NVW	[14]
06:42	1826.0	SSB	TI8M	[07]
06:45	3775.0	SSB	KH7X	[31] dans 8 min il nous entend !!!
06:59	3675.0	SSB	EA9PY	[33]

No higher resolution available.

[SkedsWindow.gif](#) (577 × 530 pixels, file size: 13 KB, MIME type: image/gif)

Skeds window

## File history

Click on a date/time to view the file as it appeared at that time.

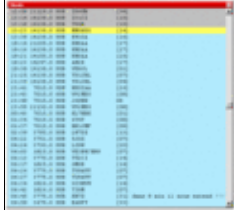
	Date/Time	Thumbnail	Dimensions	User	Comment
current	<a href="#">14:23, 5 January 2006</a>		577 × 530 (13 KB)	<a href="#">M0CLW</a> ( <a href="#">talk</a>   <a href="#">contribs</a> )	Skeds window

You cannot overwrite this file.

## File usage

The following file is a duplicate of this file ([more details](#)):

- [File:WindowsSked.gif](#)

The following page uses this file:

- [Multi-op/Passing](#)

## Namespaces

- [File](#)
- [Discussion](#)

## Variants

## Views

- [Read](#)
- [View source](#)
- [View history](#)

## More

- This page was last edited on 5 January 2006, at 14:23.
- [Privacy policy](#)
- [About Win-Test Wiki](#)
- [Disclaimers](#)



# File:SkedsWindow.gif

From Win-Test Wiki

[Jump to navigation](#) [Jump to search](#)

- [File](#)
- [File history](#)
- [File usage](#)

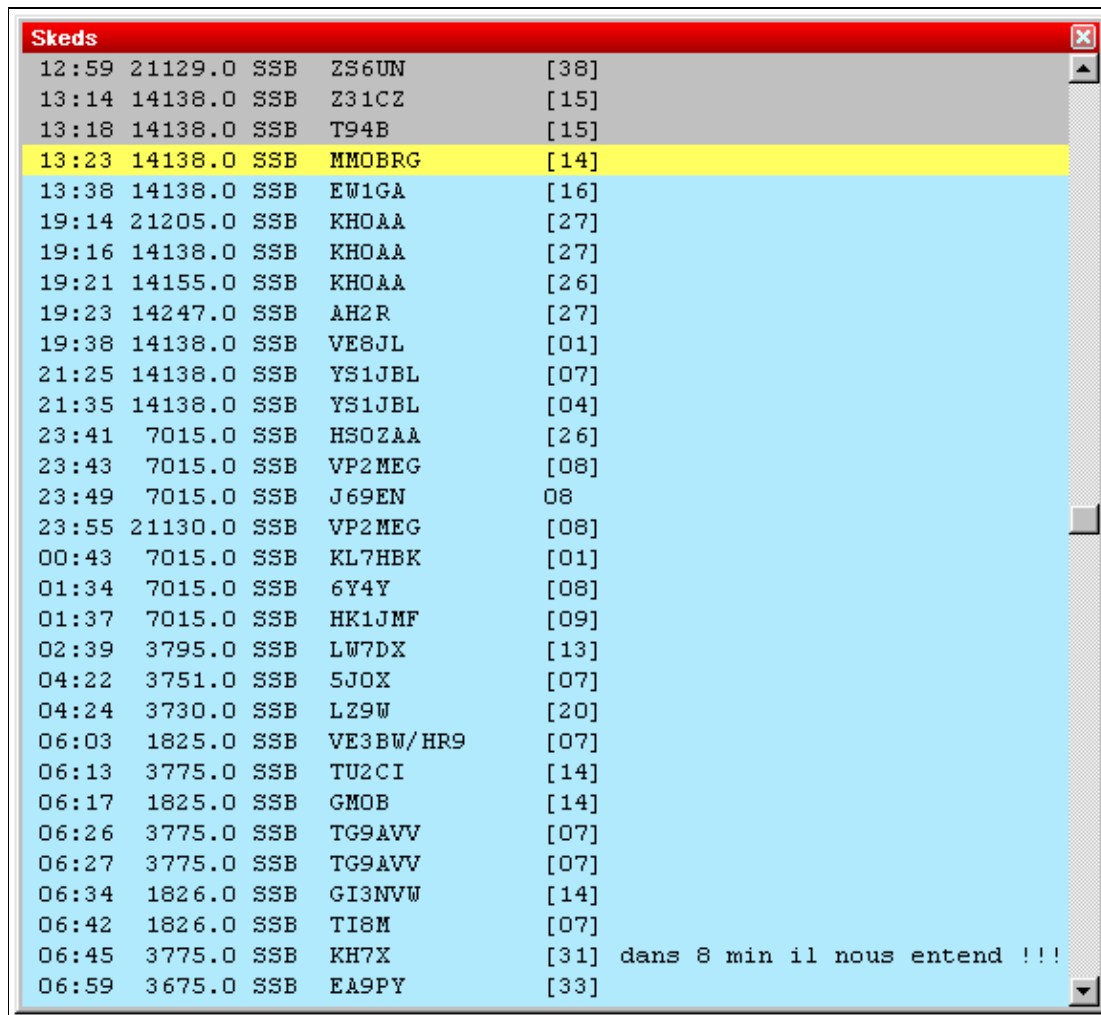

Time	Freq	Mode	Call Sign	Duration
12:59	21129.0	SSB	ZS6UN	[38]
13:14	14138.0	SSB	Z31CZ	[15]
13:18	14138.0	SSB	T94B	[15]
13:23	14138.0	SSB	MMOBRG	[14]
13:38	14138.0	SSB	EW1GA	[16]
19:14	21205.0	SSB	KHOAA	[27]
19:16	14138.0	SSB	KHOAA	[27]
19:21	14155.0	SSB	KHOAA	[26]
19:23	14247.0	SSB	AH2R	[27]
19:38	14138.0	SSB	VE8JL	[01]
21:25	14138.0	SSB	YS1JBL	[07]
21:35	14138.0	SSB	YS1JBL	[04]
23:41	7015.0	SSB	HSOZAA	[26]
23:43	7015.0	SSB	VP2MEG	[08]
23:49	7015.0	SSB	J69EN	08
23:55	21130.0	SSB	VP2MEG	[08]
00:43	7015.0	SSB	KL7HBK	[01]
01:34	7015.0	SSB	6Y4Y	[08]
01:37	7015.0	SSB	HK1JMF	[09]
02:39	3795.0	SSB	LW7DX	[13]
04:22	3751.0	SSB	5JOX	[07]
04:24	3730.0	SSB	LZ9W	[20]
06:03	1825.0	SSB	VE3BW/HR9	[07]
06:13	3775.0	SSB	TU2CI	[14]
06:17	1825.0	SSB	GMOB	[14]
06:26	3775.0	SSB	TG9AVV	[07]
06:27	3775.0	SSB	TG9AVV	[07]
06:34	1826.0	SSB	GI3NVW	[14]
06:42	1826.0	SSB	TI8M	[07]
06:45	3775.0	SSB	KH7X	[31] dans 8 min il nous entend !!!
06:59	3675.0	SSB	EA9PY	[33]



No higher resolution available.

[SkedsWindow.gif](#) (577 × 530 pixels, file size: 13 KB, MIME type: image/gif)

Skeds window

## File history

Click on a date/time to view the file as it appeared at that time.

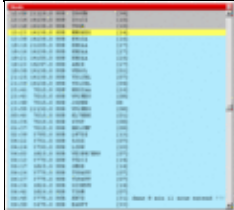
	Date/Time	Thumbnail	Dimensions	User	Comment
current	<a href="#">14:23, 5 January 2006</a>		577 × 530 (13 KB)	<a href="#">M0CLW (talk   contribs)</a>	Skeds window

You cannot overwrite this file.

## File usage

The following file is a duplicate of this file ([more details](#)):

- [File:WindowsSked.gif](#)

The following page uses this file:

- [Multi-op/Passing](#)

## Namespaces

- [File](#)
- [Discussion](#)

## Variants

## Views

- [Read](#)
- [View source](#)
- [View history](#)

## More

- This page was last edited on 5 January 2006, at 14:23.
- [Privacy policy](#)
- [About Win-Test Wiki](#)
- [Disclaimers](#)



# File:SkedsWindow simple.gif

From Win-Test Wiki

[Jump to navigation](#) [Jump to search](#)

- [File](#)
- [File history](#)
- [File usage](#)

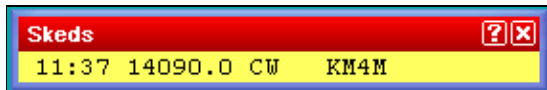

No higher resolution available.

[SkedsWindow simple.gif](#) (284 × 44 pixels, file size: 2 KB, MIME type: image.gif)

skeds window screenshot (simplified version)

## File history

Click on a date/time to view the file as it appeared at that time.

	Date/Time	Thumbnail	Dimensions	User	Comment
current	<a href="#">14:24, 5 January 2006</a>		284 × 44 (2 KB)	<a href="#">M0CLW</a> ( <a href="#">talk</a>   <a href="#">contribs</a> )	skeds window screenshot (simplified version)

You cannot overwrite this file.

## File usage

The following page uses this file:

- [Multi-op/Passing](#)

## Namespaces

- [File](#)
- [Discussion](#)

## Variants

## Views

- [Read](#)
- [View source](#)
- [View history](#)

## More

- This page was last edited on 5 January 2006, at 14:24.

- [Privacy policy](#)
- [About Win-Test Wiki](#)
- [Disclaimers](#)



# File:SkedsWindow simple.gif

From Win-Test Wiki

[Jump to navigation](#) [Jump to search](#)

- [File](#)
- [File history](#)
- [File usage](#)

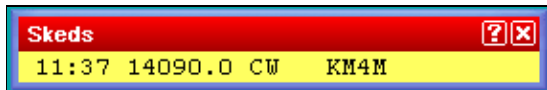

No higher resolution available.

[SkedsWindow simple.gif](#) (284 × 44 pixels, file size: 2 KB, MIME type: image.gif)

skeds window screenshot (simplified version)

## File history

Click on a date/time to view the file as it appeared at that time.

	Date/Time	Thumbnail	Dimensions	User	Comment
current	<a href="#">14:24, 5 January 2006</a>		284 × 44 (2 KB)	<a href="#">M0CLW</a> ( <a href="#">talk</a>   <a href="#">contribs</a> )	skeds window screenshot (simplified version)

You cannot overwrite this file.

## File usage

The following page uses this file:

- [Multi-op/Passing](#)

## Namespaces

- [File](#)
- [Discussion](#)

## Variants

## Views

- [Read](#)
- [View source](#)
- [View history](#)

## More

- This page was last edited on 5 January 2006, at 14:24.

- [Privacy policy](#)
- [About Win-Test Wiki](#)
- [Disclaimers](#)



# File:SoundcardInterface.gif

From Win-Test Wiki

[Jump to navigation](#) [Jump to search](#)

- [File](#)
- [File history](#)
- [File usage](#)

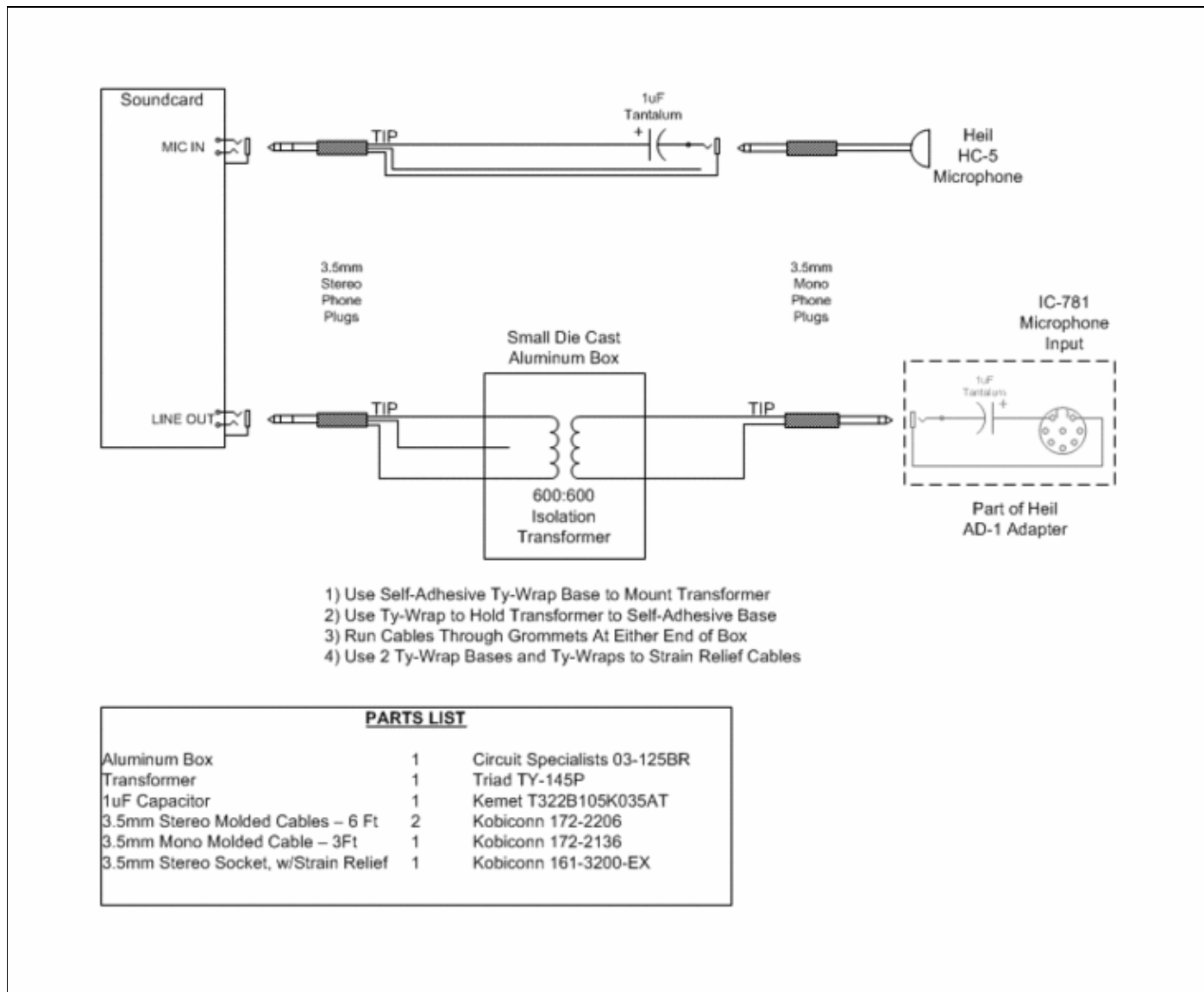

Size of this preview: [786 Å 600 pixels](#). Other resolutions: [315 Å 240 pixels](#) | [839 Å 640 pixels](#).  
[Original file](#) (839 Å 640 pixels, file size: 20 KB, MIME type: image/gif)

## File history

Click on a date/time to view the file as it appeared at that time.

Date/Time	Thumbnail	Dimensions	User	Comment
current <a href="#">15:56, 16 October 2006</a>		839 Å 640 (20 KB)	<a href="#">Dl6rai</a> ( <a href="#">talk</a>   <a href="#">contribs</a> )	

You cannot overwrite this file.

## File usage

The following page uses this file:

- [Interfaces](#)

## Namespaces

- [File](#)
- [Discussion](#)

## Variants

## Views

- [Read](#)
- [View source](#)
- [View history](#)

## More

- This page was last edited on 16 October 2006, at 15:57.

- [Privacy policy](#)
- [About Win-Test Wiki](#)
- [Disclaimers](#)





# File:SoundcardInterface.gif

From Win-Test Wiki

[Jump to navigation](#) [Jump to search](#)

- [File](#)
- [File history](#)
- [File usage](#)

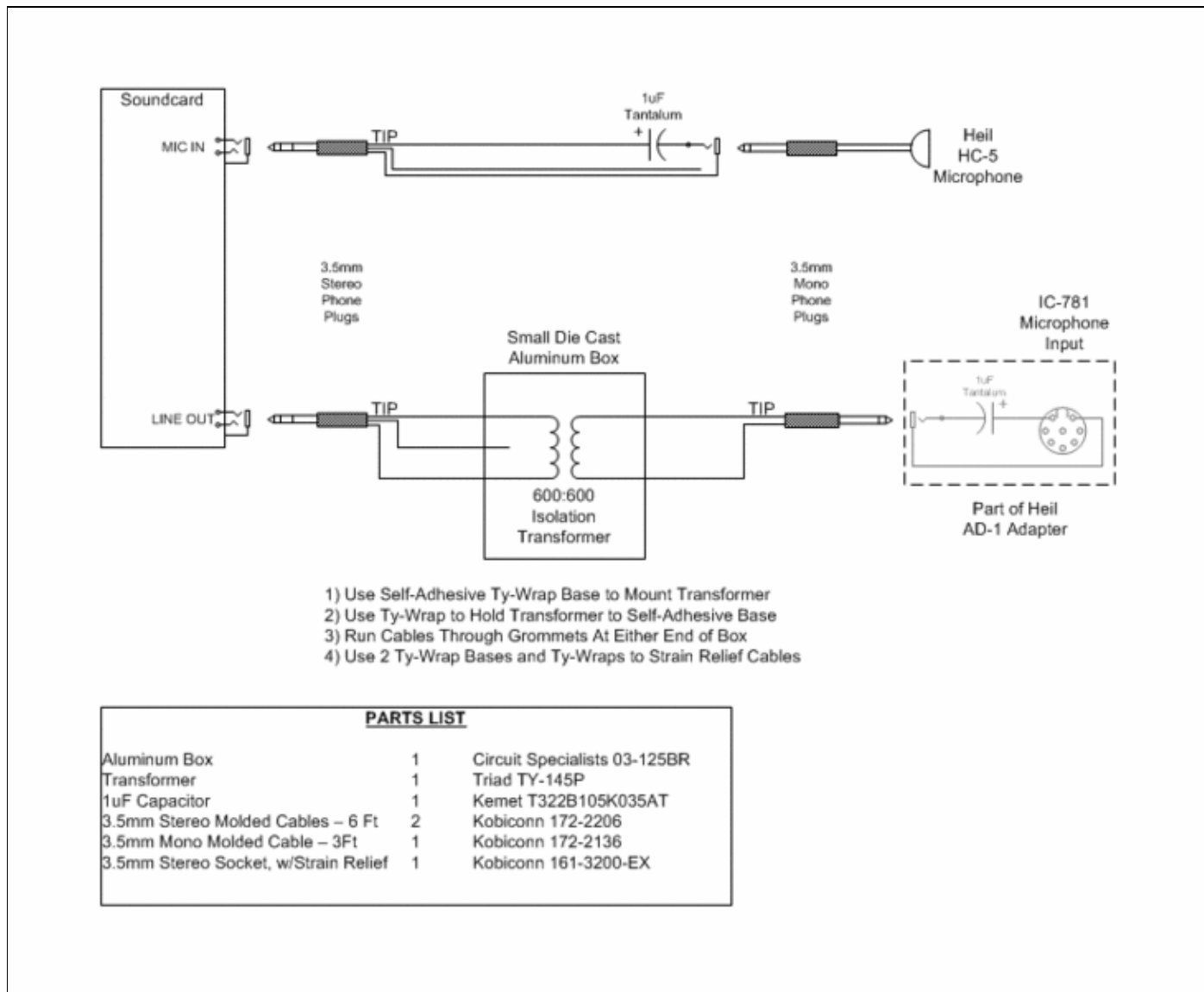

Size of this preview: [786 Å 600 pixels](#). Other resolutions: [315 Å 240 pixels](#) | [839 Å 640 pixels](#).  
[Original file](#) (839 Å 640 pixels, file size: 20 KB, MIME type: image/gif)

## File history

Click on a date/time to view the file as it appeared at that time.

Date/Time	Thumbnail	Dimensions	User	Comment
current <a href="#">15:56, 16 October 2006</a>		839 Å 640 (20 KB)	<a href="#">Dl6rai</a> ( <a href="#">talk</a>   <a href="#">contribs</a> )	

You cannot overwrite this file.

## File usage

The following page uses this file:

- [Interfaces](#)

## Namespaces

- [File](#)
- [Discussion](#)

## Variants

## Views

- [Read](#)
- [View source](#)
- [View history](#)

## More

- This page was last edited on 16 October 2006, at 15:57.

- [Privacy policy](#)
- [About Win-Test Wiki](#)
- [Disclaimers](#)



# File:split.gif

From Win-Test Wiki

[Jump to navigation](#) [Jump to search](#)

- [File](#)
- [File history](#)
- [File usage](#)



No higher resolution available.

[split.gif](#) (165 × 42 pixels, file size: 1 KB, MIME type: image.gif)

## File history

Click on a date/time to view the file as it appeared at that time.

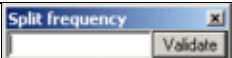
	Date/Time	Thumbnail	Dimensions	User	Comment
current	<a href="#">21:24, 29 July 2006</a>		165 × 42 (1 KB)	<a href="#">DL4NER</a> ( <a href="#">talk</a>   <a href="#">contribs</a> )	

You cannot overwrite this file.

## File usage

The following page uses this file:

- [Menu:Commands](#)

## Namespaces

- [File](#)
- [Discussion](#)

## Variants

## Views

- [Read](#)
- [View source](#)
- [View history](#)

## More

- This page was last edited on 29 July 2006, at 21:24.

## Win-Test Wiki

- [Privacy policy](#)
- [About Win-Test Wiki](#)
- [Disclaimers](#)



# File:split.gif

From Win-Test Wiki

[Jump to navigation](#) [Jump to search](#)

- [File](#)
- [File history](#)
- [File usage](#)



No higher resolution available.

[split.gif](#) (165 × 42 pixels, file size: 1 KB, MIME type: image.gif)

## File history

Click on a date/time to view the file as it appeared at that time.

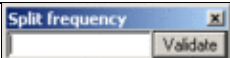
	Date/Time	Thumbnail	Dimensions	User	Comment
current	<a href="#">21:24, 29 July 2006</a>		165 × 42 (1 KB)	<a href="#">DL4NER</a> ( <a href="#">talk</a>   <a href="#">contribs</a> )	

You cannot overwrite this file.

## File usage

The following page uses this file:

- [Menu:Commands](#)

## Namespaces

- [File](#)
- [Discussion](#)

## Variants

## Views

- [Read](#)
- [View source](#)
- [View history](#)

## More

- This page was last edited on 29 July 2006, at 21:24.

## Win-Test Wiki

- [Privacy policy](#)
- [About Win-Test Wiki](#)
- [Disclaimers](#)



# File:spotastation.gif

From Win-Test Wiki

[Jump to navigation](#) [Jump to search](#)

- [File](#)
- [File history](#)
- [File usage](#)



No higher resolution available.

[spotastation.gif](#) (525 × 42 pixels, file size: 2 KB, MIME type: image.gif)

## File history

Click on a date/time to view the file as it appeared at that time.

	Date/Time	Thumbnail	Dimensions	User	Comment
current	<a href="#">21:37, 29 July 2006</a>		525 × 42 (2 KB)	<a href="#">DL4NER</a> ( <a href="#">talk</a>   <a href="#">contribs</a> )	

You cannot overwrite this file.

## File usage

The following page uses this file:

- [Menu:Commands](#)

## Namespaces

- [File](#)
- [Discussion](#)

## Variants

## Views

- [Read](#)
- [View source](#)
- [View history](#)

## More

- This page was last edited on 29 July 2006, at 21:37.
- [Privacy policy](#)

## Win-Test Wiki

- [About Win-Test Wiki](#)
- [Disclaimers](#)





# File:spotastation.gif

From Win-Test Wiki

[Jump to navigation](#) [Jump to search](#)

- [File](#)
- [File history](#)
- [File usage](#)



No higher resolution available.

[spotastation.gif](#) (525 × 42 pixels, file size: 2 KB, MIME type: image.gif)

## File history

Click on a date/time to view the file as it appeared at that time.

	Date/Time	Thumbnail	Dimensions	User	Comment
current	<a href="#">21:37, 29 July 2006</a>		525 × 42 (2 KB)	<a href="#">DL4NER</a> ( <a href="#">talk</a>   <a href="#">contribs</a> )	

You cannot overwrite this file.

## File usage

The following page uses this file:

- [Menu:Commands](#)

## Namespaces

- [File](#)
- [Discussion](#)

## Variants

## Views

- [Read](#)
- [View source](#)
- [View history](#)

## More

- This page was last edited on 29 July 2006, at 21:37.
- [Privacy policy](#)

## Win-Test Wiki

- [About Win-Test Wiki](#)
- [Disclaimers](#)



# File:StatisticsContinents.PNG

From Win-Test Wiki

[Jump to navigation](#) [Jump to search](#)

- [File](#)
- [File history](#)
- [File usage](#)

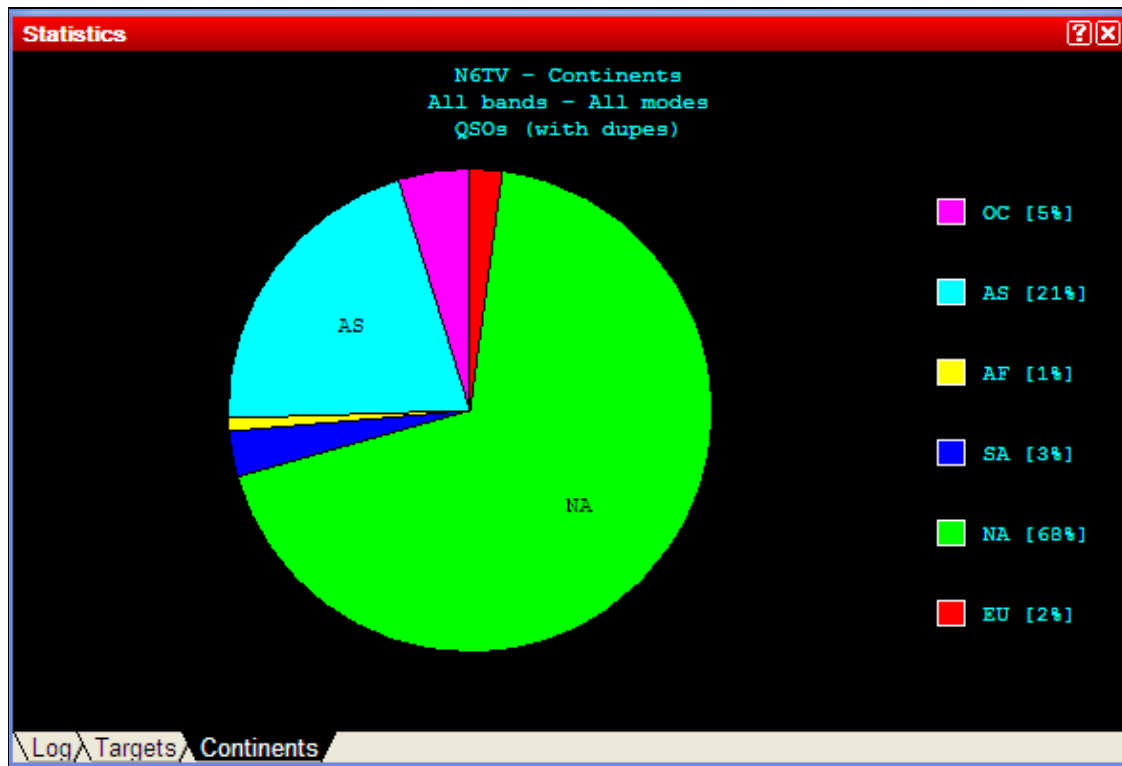

No higher resolution available.

[StatisticsContinents.PNG](#) (587 × 398 pixels, file size: 13 KB, MIME type: image.gif)

Continents tab on the statistics menu

## File history

Click on a date/time to view the file as it appeared at that time.

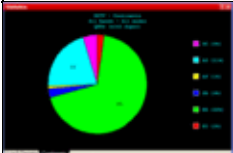
	Date/Time	Thumbnail	Dimensions	User	Comment
current	<a href="#">22:20, 19 July 2008</a>		587 × 398 (13 KB)	<a href="#">N6TV (talk   contribs)</a>	Continents tab on the statistics menu

You cannot overwrite this file.

## File usage

The following page uses this file:

- [Menu:Windows](#)

## Namespaces

- [File](#)
- [Discussion](#)

## Variants

## Views

- [Read](#)
- [View source](#)
- [View history](#)

## More

- This page was last edited on 19 July 2008, at 22:20.
- [Privacy policy](#)
- [About Win-Test Wiki](#)
- [Disclaimers](#)



# File:StatisticsContinents.PNG

From Win-Test Wiki

[Jump to navigation](#) [Jump to search](#)

- [File](#)
- [File history](#)
- [File usage](#)

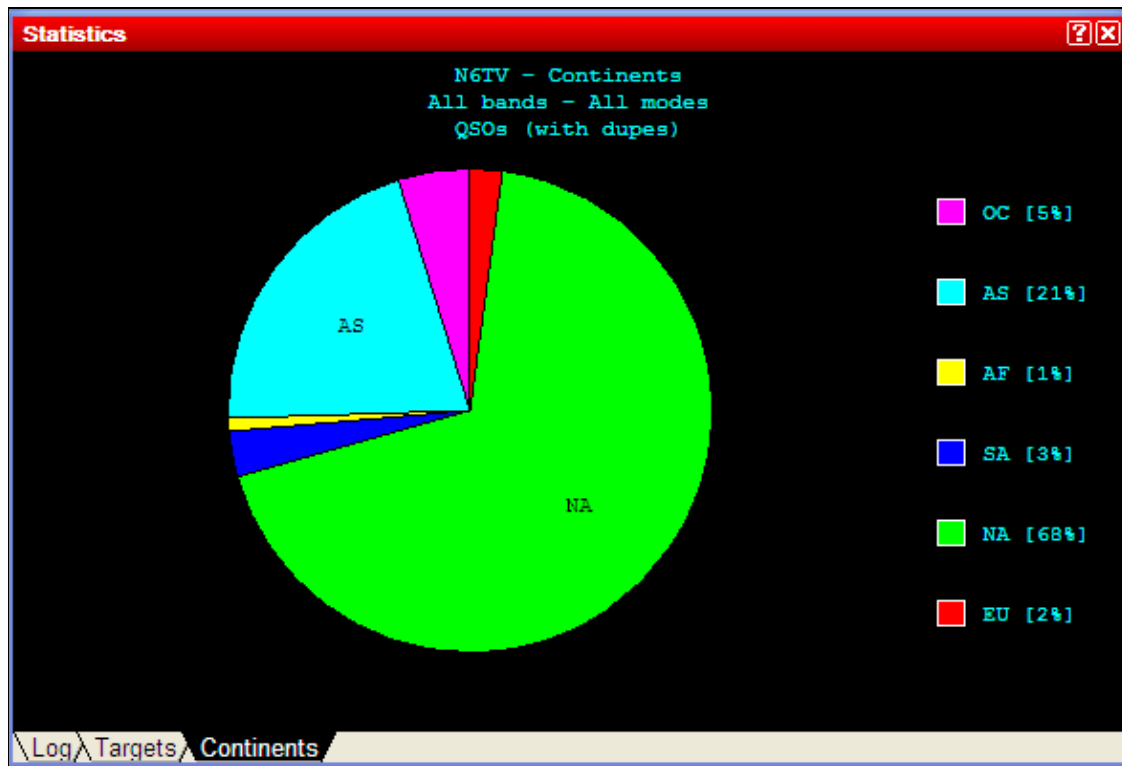

No higher resolution available.

StatisticsContinents.PNG (587 Å 398 pixels, file size: 13 KB, MIME type: image.gif)

Continents tab on the statistics menu

## File history

Click on a date/time to view the file as it appeared at that time.

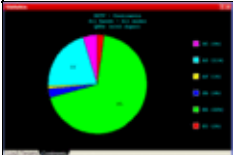
	Date/Time	Thumbnail	Dimensions	User	Comment
current	<a href="#">22:20, 19 July 2008</a>		587 Å 398 (13 KB)	<a href="#">N6TV (talk   contribs)</a>	Continents tab on the statistics menu

You cannot overwrite this file.

## File usage

The following page uses this file:

- [Menu:Windows](#)

## Namespaces

- [File](#)
- [Discussion](#)

## Variants

## Views

- [Read](#)
- [View source](#)
- [View history](#)

## More

- This page was last edited on 19 July 2008, at 22:20.

- [Privacy policy](#)
- [About Win-Test Wiki](#)
- [Disclaimers](#)



# File:StatisticsHourlyQSOTargets.PNG

From Win-Test Wiki

[Jump to navigation](#) [Jump to search](#)

- [File](#)
- [File history](#)
- [File usage](#)

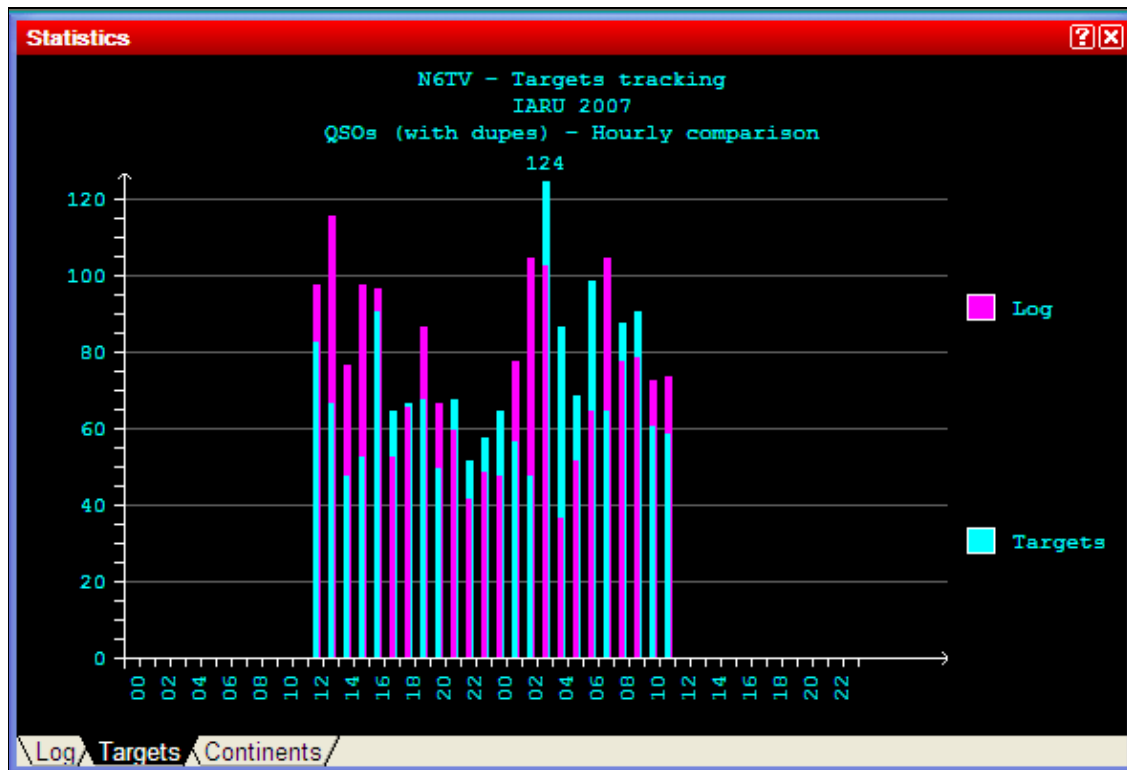

No higher resolution available.

StatisticsHourlyQSOTargets.PNG (589 × 400 pixels, file size: 13 KB, MIME type: image.gif)

Statistics Window showing hour by hour QSOs vs. targets

## File history

Click on a date/time to view the file as it appeared at that time.

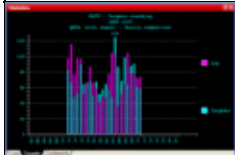
	Date/Time	Thumbnail	Dimensions	User	Comment
current	<a href="#">21:19, 19 July 2008</a>		589 × 400 (13 KB)	<a href="#">N6TV (talk   contribs)</a>	Statistics Window showing hour by hour QSOs vs. targets

You cannot overwrite this file.

## File usage

The following page uses this file:

- [Menu:Windows](#)

## Namespaces

- [File](#)
- [Discussion](#)

## Variants

## Views

- [Read](#)
- [View source](#)
- [View history](#)

## More

- This page was last edited on 19 July 2008, at 21:19.
- [Privacy policy](#)
- [About Win-Test Wiki](#)
- [Disclaimers](#)





# File:StatisticsHourlyQSOTargets.PNG

From Win-Test Wiki

[Jump to navigation](#) [Jump to search](#)

- [File](#)
- [File history](#)
- [File usage](#)

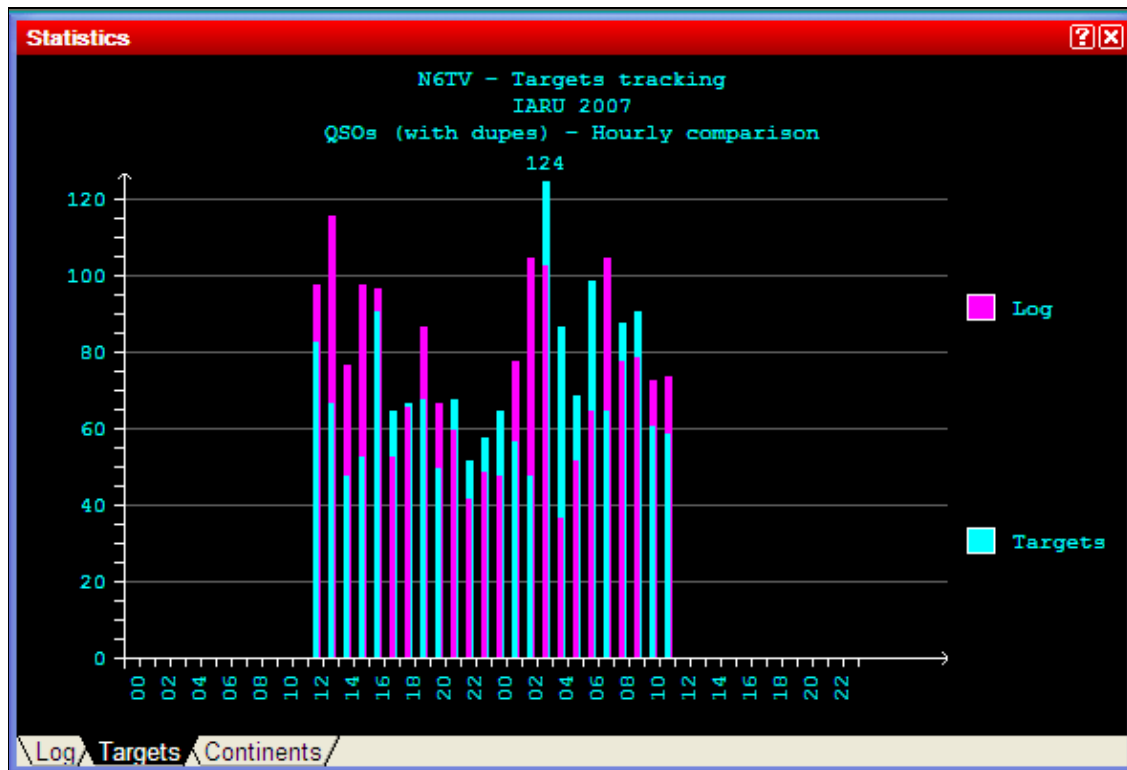

No higher resolution available.

StatisticsHourlyQSOTargets.PNG (589 × 400 pixels, file size: 13 KB, MIME type: image.gif)

Statistics Window showing hour by hour QSOs vs. targets

## File history

Click on a date/time to view the file as it appeared at that time.

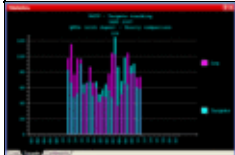
	Date/Time	Thumbnail	Dimensions	User	Comment
current	<u>21:19, 19 July 2008</u>		589 × 400 (13 KB)	<u>N6TV (talk   contribs)</u>	Statistics Window showing hour by hour QSOs vs. targets

You cannot overwrite this file.

## File usage

The following page uses this file:

- Menu:Windows

## Namespaces

- File
- Discussion

## Variants

## Views

- Read
- View source
- View history

## More

- This page was last edited on 19 July 2008, at 21:19.
- Privacy policy
- About Win-Test Wiki
- Disclaimers



# File:StatisticsPopUpMenu.PNG

From Win-Test Wiki

[Jump to navigation](#) [Jump to search](#)

- [File](#)
- [File history](#)
- [File usage](#)



No higher resolution available.

[StatisticsPopUpMenu.PNG](#) (356 × 262 pixels, file size: 10 KB, MIME type: image/gif)

Pop-up menu for the Statistics Page [Ctrl-F9]

## File history

Click on a date/time to view the file as it appeared at that time.

	Date/Time	Thumbnail	Dimensions	User	Comment
current	<a href="#">21:55, 19 July 2008</a>		356 × 262 (10 KB)	<a href="#">N6TV (talk   contribs)</a>	Pop-up context menu for Statistics [Ctrl-F9] menu
	<a href="#">21:46, 19 July 2008</a>		309 × 295 (10 KB)	<a href="#">N6TV (talk   contribs)</a>	Pop-up menu for the Statistics Page [Ctrl-F9]

Date/Time	Thumbnail	Dimensions	User	Comment
You cannot overwrite this file.				

## File usage

The following page uses this file:

- [Menu:Windows](#)

## Namespaces

- [File](#)
- [Discussion](#)

## Variants

## Views

- [Read](#)
- [View source](#)
- [View history](#)

## More

- This page was last edited on 19 July 2008, at 21:46.

- [Privacy policy](#)
- [About Win-Test Wiki](#)
- [Disclaimers](#)

- The logo consists of a small sun icon to the left of the text "Powered By MediaWiki".

# File:StatisticsPopUpMenuDisplayedData.PNG

From Win-Test Wiki

[Jump to navigation](#) [Jump to search](#)

- [File](#)
- [File history](#)
- [File usage](#)

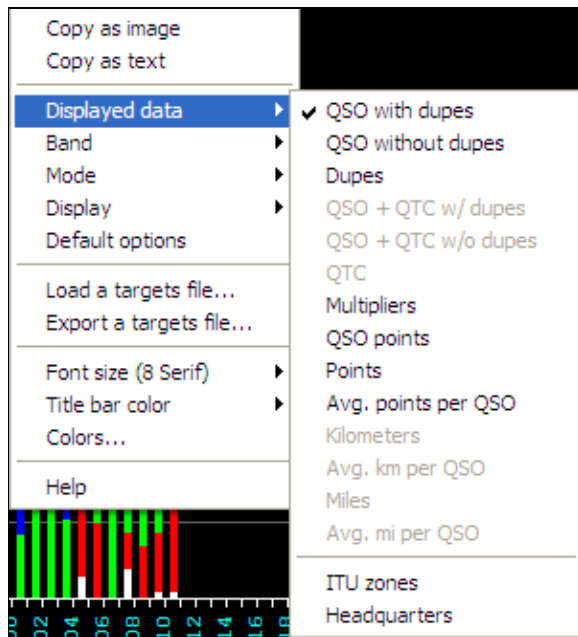

No higher resolution available.

[StatisticsPopUpMenuDisplayedData.PNG](#) (300 × 329 pixels, file size: 11 KB, MIME type: image/gif)

Statistics Pop-up menu showing Displayed Data options

## File history

Click on a date/time to view the file as it appeared at that time.

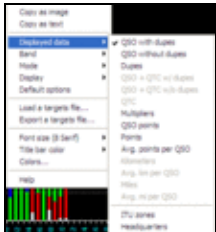
	Date/Time	Thumbnail	Dimensions	User	Comment
current	<a href="#">21:58, 19 July 2008</a>		300 × 329 (11 KB)	<a href="#">N6TV</a> ( <a href="#">talk</a>   <a href="#">contribs</a> )	Statistics Pop-up menu showing Displayed Data options

Date/Time	Thumbnail	Dimensions	User	Comment
You cannot overwrite this file.				

## File usage

The following page uses this file:

- [Menu:Windows](#)

## Namespaces

- [File](#)
- [Discussion](#)

## Variants

## Views

- [Read](#)
- [View source](#)
- [View history](#)

## More

- This page was last edited on 19 July 2008, at 21:58.

- [Privacy policy](#)
- [About Win-Test Wiki](#)
- [Disclaimers](#)

- The logo consists of a small yellow sun icon to the left of the text "Powered By MediaWiki". The text is in a blue, sans-serif font, with "Powered By" on one line and "MediaWiki" on the line below it. The entire logo is enclosed in a thin black rectangular border.

# File:StatisticsPopUpMenuDisplayedData.PNG

From Win-Test Wiki

[Jump to navigation](#) [Jump to search](#)

- [File](#)
- [File history](#)
- [File usage](#)

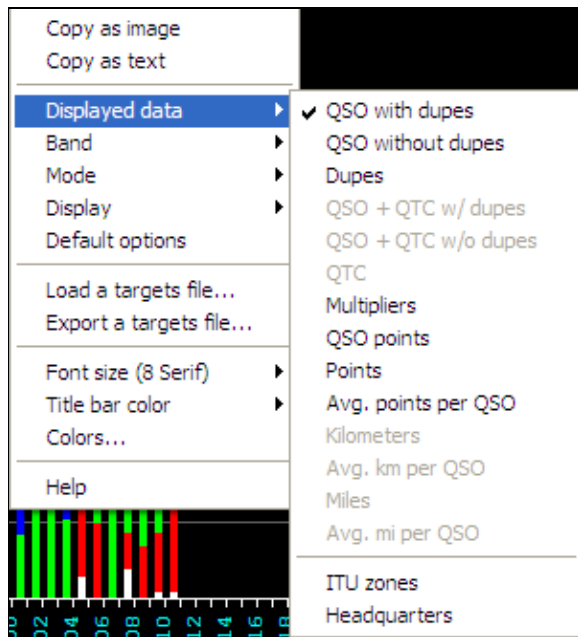

No higher resolution available.

[StatisticsPopUpMenuDisplayedData.PNG](#) (300 × 329 pixels, file size: 11 KB, MIME type: image/gif)

Statistics Pop-up menu showing Displayed Data options

## File history

Click on a date/time to view the file as it appeared at that time.

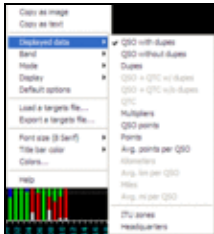
	Date/Time	Thumbnail	Dimensions	User	Comment
current	<a href="#">21:58, 19 July 2008</a>		300 × 329 (11 KB)	<a href="#">N6TV</a> ( <a href="#">talk</a>   <a href="#">contribs</a> )	Statistics Pop-up menu showing Displayed Data options

Date/Time	Thumbnail	Dimensions	User	Comment
You cannot overwrite this file.				

## File usage

The following page uses this file:

- [Menu:Windows](#)

## Namespaces

- [File](#)
- [Discussion](#)

## Variants

## Views

- [Read](#)
- [View source](#)
- [View history](#)

## More

- This page was last edited on 19 July 2008, at 21:58.

- [Privacy policy](#)
- [About Win-Test Wiki](#)
- [Disclaimers](#)

- 



# File:StatisticsPopUpMenu.PNG

From Win-Test Wiki

[Jump to navigation](#) [Jump to search](#)

- [File](#)
- [File history](#)
- [File usage](#)

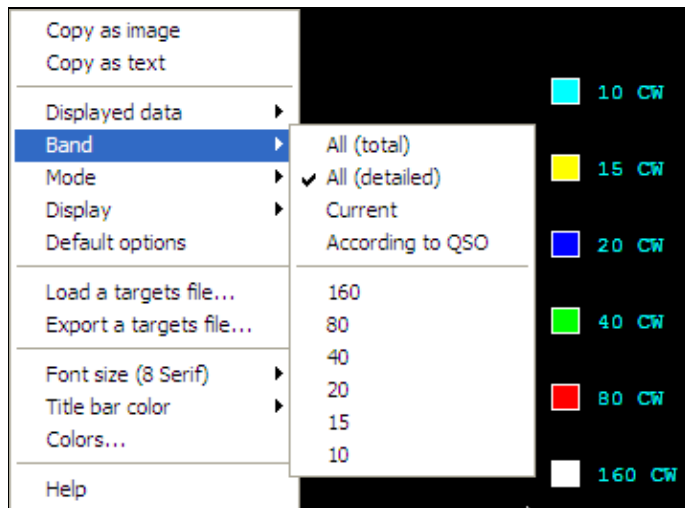

No higher resolution available.

[StatisticsPopUpMenu.PNG](#) (356 × 262 pixels, file size: 10 KB, MIME type: image/gif)

Pop-up menu for the Statistics Page [Ctrl-F9]

## File history

Click on a date/time to view the file as it appeared at that time.

	Date/Time	Thumbnail	Dimensions	User	Comment
current	<a href="#">21:55, 19 July 2008</a>		356 × 262 (10 KB)	<a href="#">N6TV</a> ( <a href="#">talk</a>   <a href="#">contribs</a> )	Pop-up context menu for Statistics [Ctrl-F9] menu
	<a href="#">21:46, 19 July 2008</a>		309 × 295 (10 KB)	<a href="#">N6TV</a> ( <a href="#">talk</a>   <a href="#">contribs</a> )	Pop-up menu for the Statistics Page [Ctrl-F9]

Date/Time	Thumbnail	Dimensions	User	Comment
You cannot overwrite this file.				

## File usage

The following page uses this file:

- [Menu:Windows](#)

## Namespaces

- [File](#)
- [Discussion](#)

## Variants

## Views

- [Read](#)
- [View source](#)
- [View history](#)

## More

- This page was last edited on 19 July 2008, at 21:46.

- [Privacy policy](#)
- [About Win-Test Wiki](#)
- [Disclaimers](#)

- The logo consists of a small sun icon to the left of the text "Powered By MediaWiki".

# File:StatusWindow.gif

From Win-Test Wiki

[Jump to navigation](#) [Jump to search](#)

- [File](#)
- [File history](#)
- [File usage](#)

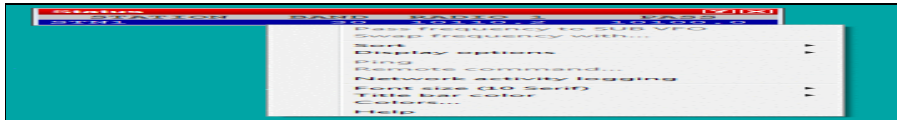

No higher resolution available.

[StatusWindow.gif](#) (470 × 60 pixels, file size: 3 KB, MIME type: image/gif)

Status window screenshot

## File history

Click on a date/time to view the file as it appeared at that time.

	Date/Time	Thumbnail	Dimensions	User	Comment
current	<a href="#">14:25, 5 January 2006</a>		470 × 60 (3 KB)	<a href="#">M0CLW</a> ( <a href="#">talk</a>   <a href="#">contribs</a> )	Status window screenshot

You cannot overwrite this file.

## File usage

The following file is a duplicate of this file ([more details](#)):

- [File:WindowsStatus.gif](#)

The following page uses this file:

- [Multi-op/Status window](#)

## Namespaces

- [File](#)
- [Discussion](#)

## Variants

## Views

- [Read](#)
- [View source](#)
- [View history](#)

## More

- This page was last edited on 5 January 2006, at 14:25.

- [Privacy policy](#)
- [About Win-Test Wiki](#)
- [Disclaimers](#)



# File:StatusWindow.gif

From Win-Test Wiki

[Jump to navigation](#) [Jump to search](#)

- [File](#)
- [File history](#)
- [File usage](#)

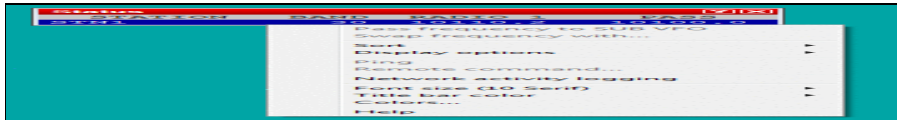

No higher resolution available.

[StatusWindow.gif](#) (470 × 60 pixels, file size: 3 KB, MIME type: image/gif)

Status window screenshot

## File history

Click on a date/time to view the file as it appeared at that time.

	Date/Time	Thumbnail	Dimensions	User	Comment
current	<a href="#">14:25, 5 January 2006</a>		470 × 60 (3 KB)	<a href="#">M0CLW</a> ( <a href="#">talk</a>   <a href="#">contribs</a> )	Status window screenshot

You cannot overwrite this file.

## File usage

The following file is a duplicate of this file ([more details](#)):

- [File:WindowsStatus.gif](#)

The following page uses this file:

- [Multi-op/Status window](#)

## Namespaces

- [File](#)
- [Discussion](#)

## Variants

## Views

- [Read](#)
- [View source](#)
- [View history](#)

## More

- This page was last edited on 5 January 2006, at 14:25.

- [Privacy policy](#)
- [About Win-Test Wiki](#)
- [Disclaimers](#)



# File:StatusWindow.PNG

From Win-Test Wiki

[Jump to navigation](#) [Jump to search](#)

- [File](#)
- [File history](#)
- [File usage](#)
- [Metadata](#)

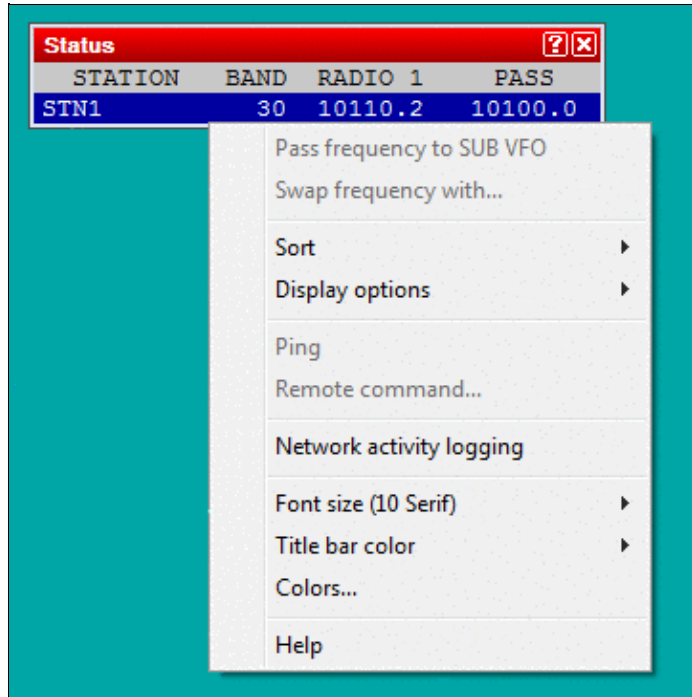

No higher resolution available.

[StatusWindow.PNG](#) (360 × 363 pixels, file size: 9 KB, MIME type: image/gif)

## File history

Click on a date/time to view the file as it appeared at that time.

	Date/Time	Thumbnail	Dimensions	User	Comment
current	<a href="#">16:51, 17 December 2016</a>		360 × 363 (9 KB)	<a href="#">Dl6rai</a> ( <a href="#">talk</a>   <a href="#">contribs</a> )	

Date/Time	Thumbnail	Dimensions	User	Comment
You cannot overwrite this file.				

## File usage

The following page uses this file:

- [Menu:Windows](#)

## Metadata

This file contains additional information, probably added from the digital camera or scanner used to create or digitize it.

If the file has been modified from its original state, some details may not fully reflect the modified file.

**Horizontal resolution** 37.79 dpc

**Vertical resolution** 37.79 dpc

## Namespaces

- [File](#)
- [Discussion](#)

## Variants

## Views

- [Read](#)
- [View source](#)
- [View history](#)

## More

- This page was last edited on 17 December 2016, at 16:51.

- [Privacy policy](#)
- [About Win-Test Wiki](#)
- [Disclaimers](#)





# File:StatusWindow.PNG

From Win-Test Wiki

[Jump to navigation](#) [Jump to search](#)

- [File](#)
- [File history](#)
- [File usage](#)
- [Metadata](#)

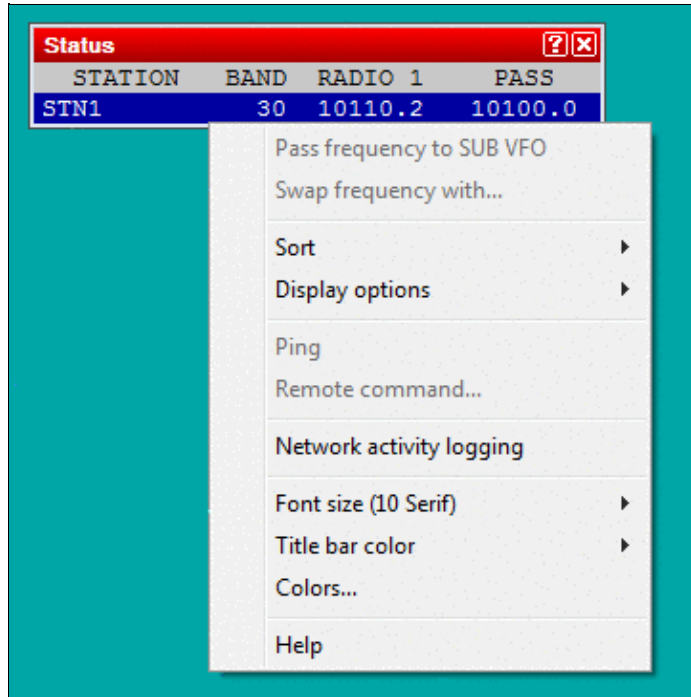

No higher resolution available.

[StatusWindow.PNG](#) (360 × 363 pixels, file size: 9 KB, MIME type: image/gif)

## File history

Click on a date/time to view the file as it appeared at that time.

	Date/Time	Thumbnail	Dimensions	User	Comment
current	<a href="#">16:51, 17 December 2016</a>		360 × 363 (9 KB)	<a href="#">Dl6rai</a> ( <a href="#">talk</a>   <a href="#">contribs</a> )	

Date/Time	Thumbnail	Dimensions	User	Comment
You cannot overwrite this file.				

## File usage

The following page uses this file:

- [Menu:Windows](#)

## Metadata

This file contains additional information, probably added from the digital camera or scanner used to create or digitize it.

If the file has been modified from its original state, some details may not fully reflect the modified file.

**Horizontal resolution** 37.79 dpc

**Vertical resolution** 37.79 dpc

## Namespaces

- [File](#)
- [Discussion](#)

## Variants

## Views

- [Read](#)
- [View source](#)
- [View history](#)

## More

- This page was last edited on 17 December 2016, at 16:51.

- [Privacy policy](#)
- [About Win-Test Wiki](#)
- [Disclaimers](#)



# File:StatuWndMenu.gif

From Win-Test Wiki

[Jump to navigation](#) [Jump to search](#)

- [File](#)
- [File history](#)
- [File usage](#)

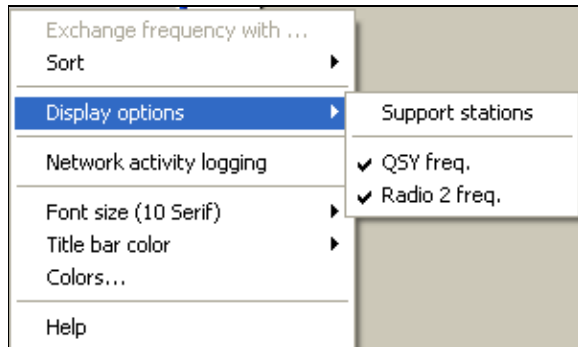

No higher resolution available.

[StatuWndMenu.gif](#) (300 × 179 pixels, file size: 5 KB, MIME type: image.gif)

## File history

Click on a date/time to view the file as it appeared at that time.

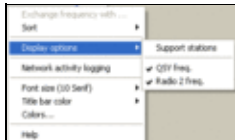
Date/Time	Thumbnail	Dimensions	User	Comment
current <a href="#">08:04, 25 January 2007</a>		300 × 179 (5 KB)	<a href="#">I2WII</a> ( <a href="#">talk</a>   <a href="#">contribs</a> )	

You cannot overwrite this file.

## File usage

The following page uses this file:

- [Multi-op/Status window](#)

## Namespaces

- [File](#)
- [Discussion](#)

## Variants

## Views

- [Read](#)
- [View source](#)
- [View history](#)

## More

- This page was last edited on 25 January 2007, at 08:04.

- [Privacy policy](#)
- [About Win-Test Wiki](#)
- [Disclaimers](#)



# File:StatuWndMenu.gif

From Win-Test Wiki

[Jump to navigation](#) [Jump to search](#)

- [File](#)
- [File history](#)
- [File usage](#)

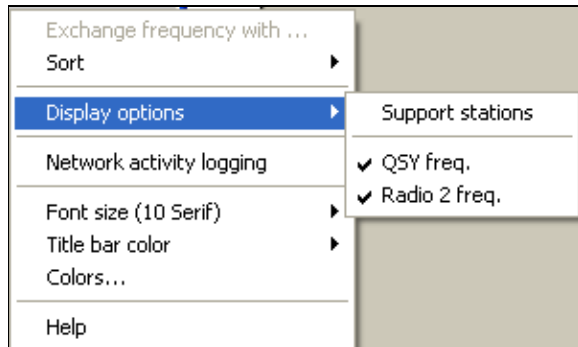

No higher resolution available.

[StatuWndMenu.gif](#) (300 × 179 pixels, file size: 5 KB, MIME type: image.gif)

## File history

Click on a date/time to view the file as it appeared at that time.

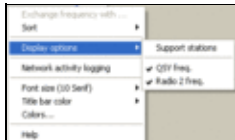
Date/Time	Thumbnail	Dimensions	User	Comment
current <a href="#">08:04, 25 January 2007</a>		300 × 179 (5 KB)	<a href="#">I2WII</a> ( <a href="#">talk</a>   <a href="#">contribs</a> )	

You cannot overwrite this file.

## File usage

The following page uses this file:

- [Multi-op/Status window](#)

## Namespaces

- [File](#)
- [Discussion](#)

## Variants

## Views

- [Read](#)
- [View source](#)
- [View history](#)

## More

- This page was last edited on 25 January 2007, at 08:04.

- [Privacy policy](#)
- [About Win-Test Wiki](#)
- [Disclaimers](#)



# File:takesked.gif

From Win-Test Wiki

[Jump to navigation](#) [Jump to search](#)

- [File](#)
- [File history](#)
- [File usage](#)

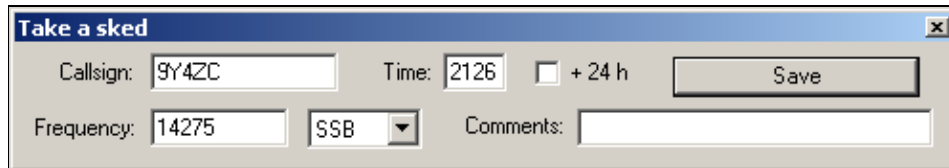

No higher resolution available.

[takesked.gif](#) (497 × 86 pixels, file size: 3 KB, MIME type: image.gif)

## File history

Click on a date/time to view the file as it appeared at that time.

	Date/Time	Thumbnail	Dimensions	User	Comment
current	<a href="#">21:28, 29 July 2006</a>		497 × 86 (3 KB)	<a href="#">DL4NER</a> ( <a href="#">talk</a>   <a href="#">contribs</a> )	

You cannot overwrite this file.

## File usage

The following page uses this file:

- [Menu:Commands](#)

## Namespaces

- [File](#)
- [Discussion](#)

## Variants

## Views

- [Read](#)
- [View source](#)
- [View history](#)

## More

- This page was last edited on 29 July 2006, at 21:28.

- [Privacy policy](#)
- [About Win-Test Wiki](#)
- [Disclaimers](#)





# File:takesked.gif

From Win-Test Wiki

[Jump to navigation](#) [Jump to search](#)

- [File](#)
- [File history](#)
- [File usage](#)

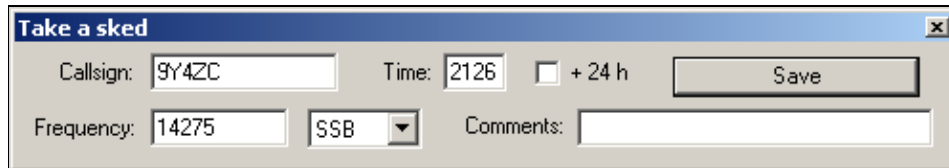

No higher resolution available.

[takesked.gif](#) (497 × 86 pixels, file size: 3 KB, MIME type: image.gif)

## File history

Click on a date/time to view the file as it appeared at that time.

	Date/Time	Thumbnail	Dimensions	User	Comment
current	<a href="#">21:28, 29 July 2006</a>		497 × 86 (3 KB)	<a href="#">DL4NER</a> ( <a href="#">talk</a>   <a href="#">contribs</a> )	

You cannot overwrite this file.

## File usage

The following page uses this file:

- [Menu:Commands](#)

## Namespaces

- [File](#)
- [Discussion](#)

## Variants

## Views

- [Read](#)
- [View source](#)
- [View history](#)

## More

- This page was last edited on 29 July 2006, at 21:28.

- [Privacy policy](#)
- [About Win-Test Wiki](#)
- [Disclaimers](#)



# File:Targets.PNG

From Win-Test Wiki

[Jump to navigation](#) [Jump to search](#)

- [File](#)
- [File history](#)
- [File usage](#)

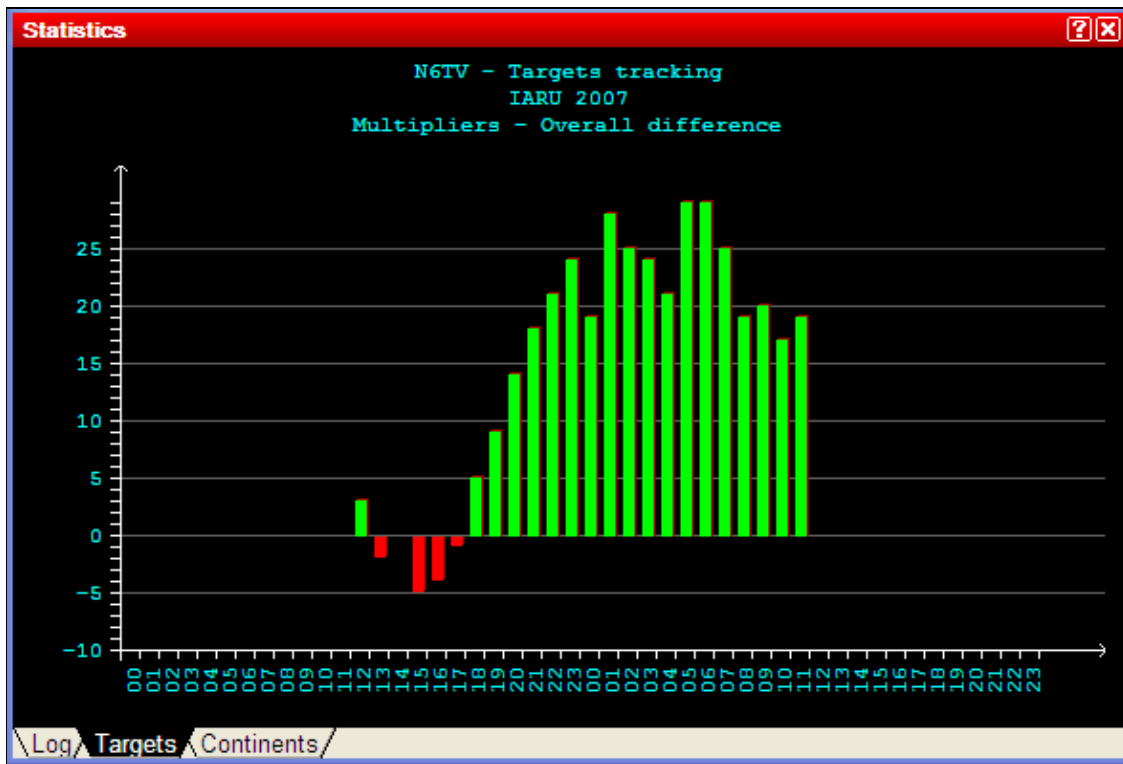

No higher resolution available.

Targets.PNG (588 × 396 pixels, file size: 12 KB, MIME type: image.gif)

Targets tab in Statistics Window, showing multiplier targets, cumulative

## File history

Click on a date/time to view the file as it appeared at that time.

	Date/Time	Thumbnail	Dimensions	User	Comment
current	<a href="#">21:18, 19 July 2008</a>		588 × 396 (12 KB)	<a href="#">N6TV (talk   contribs)</a>	Targets tab in Statistics Window, showing multiplier targets, cumulative

You cannot overwrite this file.

## File usage

The following page uses this file:

- [Menu:Windows](#)

## Namespaces

- [File](#)
- [Discussion](#)

## Variants

## Views

- [Read](#)
- [View source](#)
- [View history](#)

## More

- This page was last edited on 19 July 2008, at 21:18.
- [Privacy policy](#)
- [About Win-Test Wiki](#)
- [Disclaimers](#)



# File:Targets.PNG

From Win-Test Wiki

[Jump to navigation](#) [Jump to search](#)

- [File](#)
- [File history](#)
- [File usage](#)

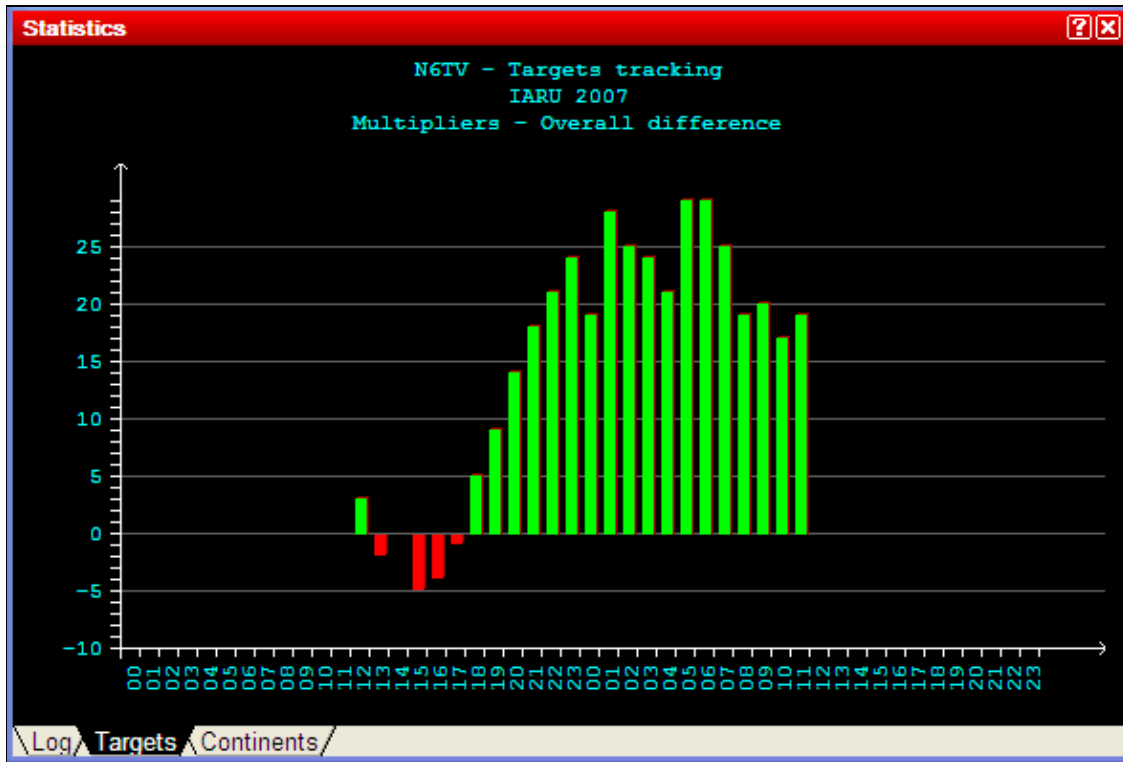

No higher resolution available.

Targets.PNG (588 × 396 pixels, file size: 12 KB, MIME type: image.gif)

Targets tab in Statistics Window, showing multiplier targets, cumulative

## File history

Click on a date/time to view the file as it appeared at that time.

	Date/Time	Thumbnail	Dimensions	User	Comment
current	<a href="#">21:18, 19 July 2008</a>		588 × 396 (12 KB)	<a href="#">N6TV (talk   contribs)</a>	Targets tab in Statistics Window, showing multiplier targets, cumulative

You cannot overwrite this file.

## File usage

The following page uses this file:

- [Menu:Windows](#)

## Namespaces

- [File](#)
- [Discussion](#)

## Variants

## Views

- [Read](#)
- [View source](#)
- [View history](#)

## More

- This page was last edited on 19 July 2008, at 21:18.
- [Privacy policy](#)
- [About Win-Test Wiki](#)
- [Disclaimers](#)



# File:TimeShifting.gif

From Win-Test Wiki

[Jump to navigation](#) [Jump to search](#)

- [File](#)
- [File history](#)
- [File usage](#)

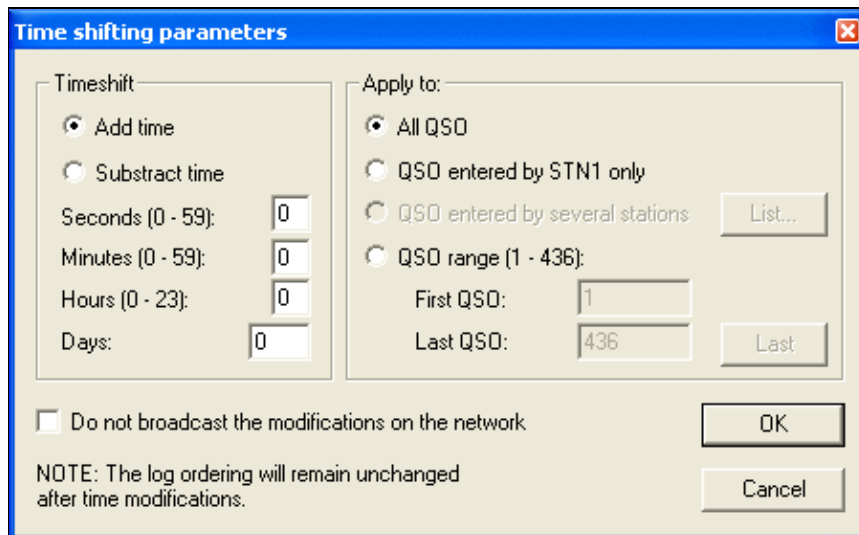

No higher resolution available.

[TimeShifting.gif](#) (450 × 277 pixels, file size: 14 KB, MIME type: image.gif)

## File history

Click on a date/time to view the file as it appeared at that time.

Date/Time	Thumbnail	Dimensions	User	Comment
current <a href="#">14:50, 23 March 2007</a>		450 × 277 (14 KB)	<a href="#">I2WJ</a> ( <a href="#">talk</a>   <a href="#">contribs</a> )	

You cannot overwrite this file.

## File usage

The following page uses this file:

- [Menu:Tools](#)

## Namespaces

- [File](#)
- [Discussion](#)

## Variants

## Views

- [Read](#)
- [View source](#)
- [View history](#)

## More

- This page was last edited on 23 March 2007, at 14:50.
- [Privacy policy](#)
- [About Win-Test Wiki](#)
- [Disclaimers](#)





# File:TimeShifting.gif

From Win-Test Wiki

[Jump to navigation](#) [Jump to search](#)

- [File](#)
- [File history](#)
- [File usage](#)

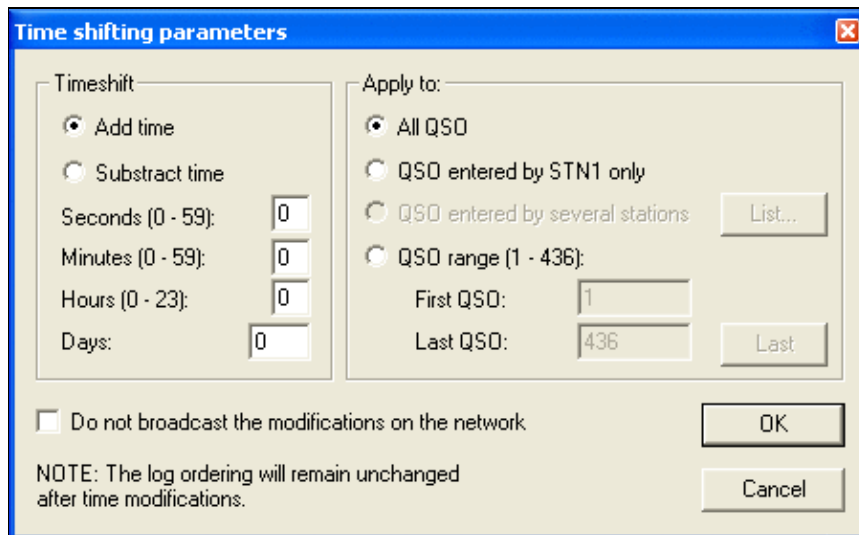

No higher resolution available.

[TimeShifting.gif](#) (450 × 277 pixels, file size: 14 KB, MIME type: image.gif)

## File history

Click on a date/time to view the file as it appeared at that time.

Date/Time	Thumbnail	Dimensions	User	Comment
current <a href="#">14:50, 23 March 2007</a>		450 × 277 (14 KB)	<a href="#">I2WJ</a> ( <a href="#">talk</a>   <a href="#">contribs</a> )	

You cannot overwrite this file.

## File usage

The following page uses this file:

- [Menu:Tools](#)

## Namespaces

- [File](#)
- [Discussion](#)

## Variants

## Views

- [Read](#)
- [View source](#)
- [View history](#)

## More

- This page was last edited on 23 March 2007, at 14:50.
- [Privacy policy](#)
- [About Win-Test Wiki](#)
- [Disclaimers](#)



# File:ToolsAutoCQ.gif

From Win-Test Wiki

[Jump to navigation](#) [Jump to search](#)

- [File](#)
- [File history](#)
- [File usage](#)

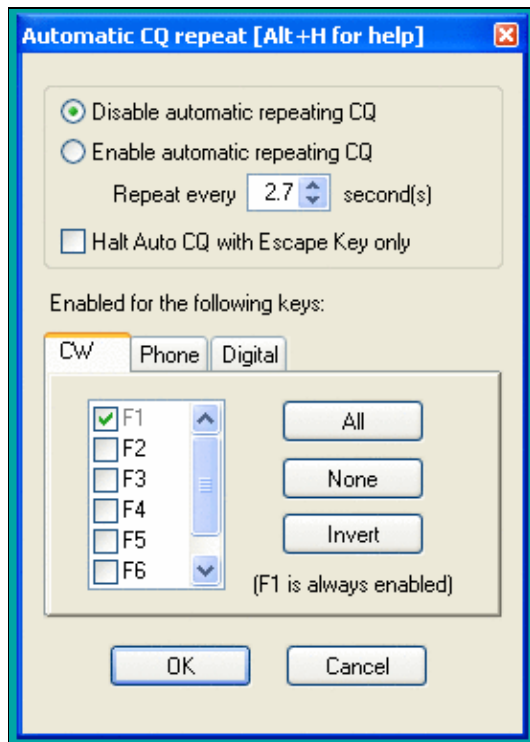



No higher resolution available.

[ToolsAutoCQ.gif](#) (275 × 386 pixels, file size: 14 KB, MIME type: image.gif)

## File history

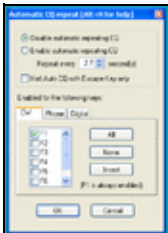
Click on a date/time to view the file as it appeared at that time.

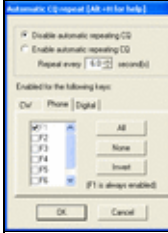
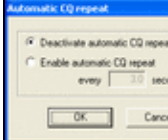
	Date/Time	Thumbnail	Dimensions	User	Comment
current	<a href="#">15:39, 15 August 2013</a>		275 × 386 (14 KB)	<a href="#">Dl6rai</a> ( <a href="#">talk</a>   <a href="#">contribs</a> )	
	<a href="#">15:36, 15 August 2013</a>		265 × 379 (14 KB)	<a href="#">Dl6rai</a> ( <a href="#">talk</a>   <a href="#">contribs</a> )	
	<a href="#">05:55, 21 January 2009</a>		267 × 346 (11 KB)	<a href="#">Dl6rai</a> ( <a href="#">talk</a>   <a href="#">contribs</a> )	
	<a href="#">15:18, 5 August 2006</a>		267 × 169 (4 KB)	<a href="#">Dl6rai</a> ( <a href="#">talk</a>   <a href="#">contribs</a> )	

You cannot overwrite this file.

## File usage

The following page uses this file:

- [Menu:Tools](#)

## Namespaces

- [File](#)
- [Discussion](#)

## Variants

## Views

- [Read](#)
- [View source](#)
- [View history](#)

## More

- This page was last edited on 15 August 2013, at 15:39.

- [Privacy policy](#)
- [About Win-Test Wiki](#)
- [Disclaimers](#)



# File:ToolsAutoCQ.gif

From Win-Test Wiki

[Jump to navigation](#) [Jump to search](#)

- [File](#)
- [File history](#)
- [File usage](#)

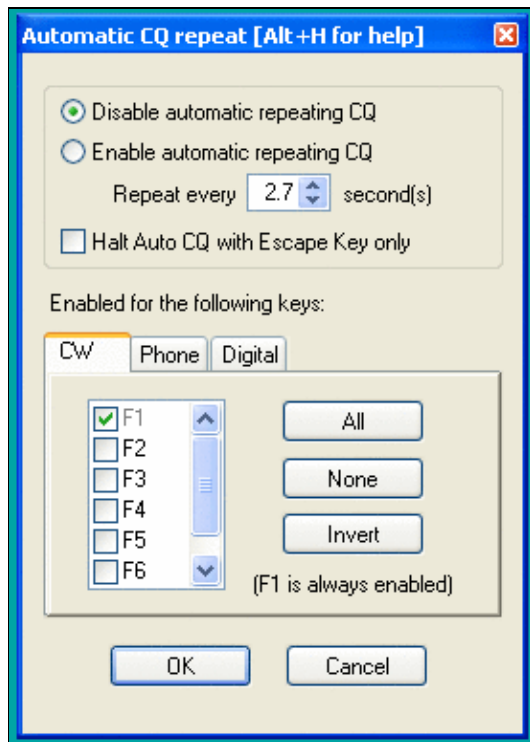



No higher resolution available.

[ToolsAutoCQ.gif](#) (275 × 386 pixels, file size: 14 KB, MIME type: image.gif)

## File history

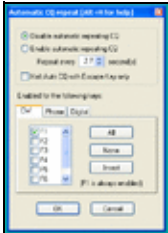
Click on a date/time to view the file as it appeared at that time.

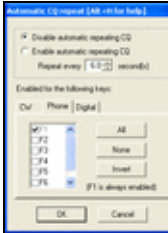
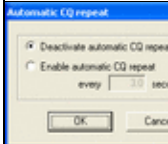
	Date/Time	Thumbnail	Dimensions	User	Comment
current	<a href="#">15:39, 15 August 2013</a>		275 × 386 (14 KB)	<a href="#">Dl6rai</a> ( <a href="#">talk</a>   <a href="#">contribs</a> )	
	<a href="#">15:36, 15 August 2013</a>		265 × 379 (14 KB)	<a href="#">Dl6rai</a> ( <a href="#">talk</a>   <a href="#">contribs</a> )	
	<a href="#">05:55, 21 January 2009</a>		267 × 346 (11 KB)	<a href="#">Dl6rai</a> ( <a href="#">talk</a>   <a href="#">contribs</a> )	
	<a href="#">15:18, 5 August 2006</a>		267 × 169 (4 KB)	<a href="#">Dl6rai</a> ( <a href="#">talk</a>   <a href="#">contribs</a> )	

You cannot overwrite this file.

## File usage

The following page uses this file:

- [Menu:Tools](#)

## Namespaces

- [File](#)
- [Discussion](#)

## Variants

## Views

- [Read](#)
- [View source](#)
- [View history](#)

## More

- This page was last edited on 15 August 2013, at 15:39.

- [Privacy policy](#)
- [About Win-Test Wiki](#)
- [Disclaimers](#)





# File:ToolsCheckLog.PNG

From Win-Test Wiki

[Jump to navigation](#) [Jump to search](#)

- [File](#)
- [File history](#)
- [File usage](#)

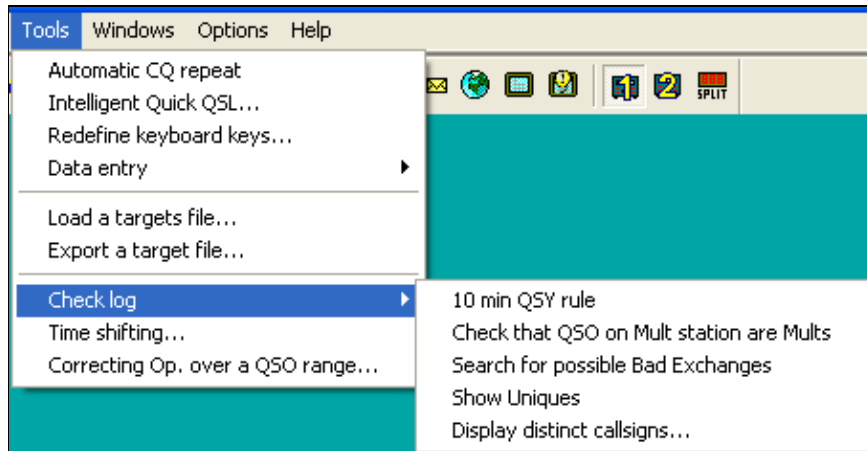

No higher resolution available.

[ToolsCheckLog.PNG](#) (454 × 234 pixels, file size: 8 KB, MIME type: image.gif)

## File history

Click on a date/time to view the file as it appeared at that time.

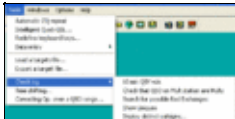
Date/Time	Thumbnail	Dimensions	User	Comment
current <a href="#">05:20, 5 June 2008</a>		454 × 234 (8 KB)	<a href="#">Dl6rai</a> ( <a href="#">talk</a>   <a href="#">contribs</a> )	

You cannot overwrite this file.

## File usage

The following page uses this file:

- [Menu:Tools](#)

## Namespaces

- [File](#)
- [Discussion](#)

## Variants

## Views

- [Read](#)
- [View source](#)
- [View history](#)

## More

- This page was last edited on 5 June 2008, at 05:20.

- [Privacy policy](#)
- [About Win-Test Wiki](#)
- [Disclaimers](#)



# File:ToolsCheckLog.PNG

From Win-Test Wiki

[Jump to navigation](#) [Jump to search](#)

- [File](#)
- [File history](#)
- [File usage](#)

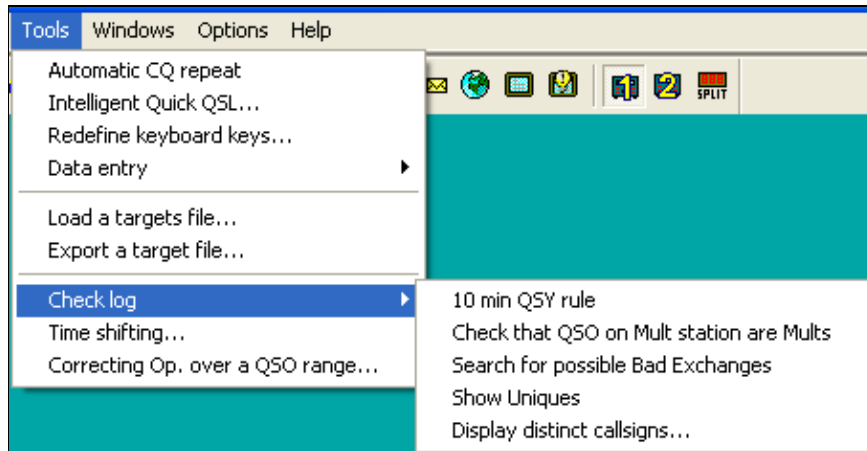

No higher resolution available.

[ToolsCheckLog.PNG](#) (454 × 234 pixels, file size: 8 KB, MIME type: image.gif)

## File history

Click on a date/time to view the file as it appeared at that time.

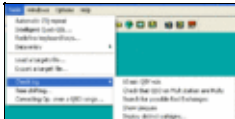
Date/Time	Thumbnail	Dimensions	User	Comment
current <a href="#">05:20, 5 June 2008</a>		454 × 234 (8 KB)	<a href="#">Dl6rai</a> ( <a href="#">talk</a>   <a href="#">contribs</a> )	

You cannot overwrite this file.

## File usage

The following page uses this file:

- [Menu:Tools](#)

## Namespaces

- [File](#)
- [Discussion](#)

## Variants

## Views

- [Read](#)
- [View source](#)
- [View history](#)

## More

- This page was last edited on 5 June 2008, at 05:20.

- [Privacy policy](#)
- [About Win-Test Wiki](#)
- [Disclaimers](#)



# File:ToolsCheckLog-M2.PNG

From Win-Test Wiki

[Jump to navigation](#) [Jump to search](#)

- [File](#)
- [File history](#)
- [File usage](#)

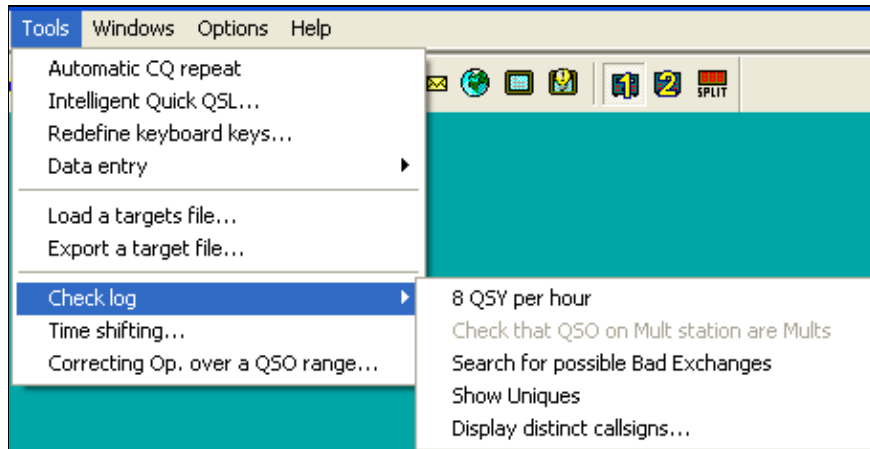

No higher resolution available.

[ToolsCheckLog-M2.PNG](#) (455 × 233 pixels, file size: 8 KB, MIME type: image/gif)

## File history

Click on a date/time to view the file as it appeared at that time.

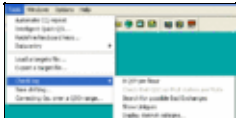
Date/Time	Thumbnail	Dimensions	User	Comment
current <a href="#">05:20, 5 June 2008</a>		455 × 233 (8 KB)	<a href="#">Dl6rai</a> ( <a href="#">talk</a>   <a href="#">contribs</a> )	

You cannot overwrite this file.

## File usage

The following page uses this file:

- [Menu:Tools](#)

## Namespaces

- [File](#)
- [Discussion](#)

## Variants

## Views

- [Read](#)
- [View source](#)
- [View history](#)

## More

- This page was last edited on 5 June 2008, at 05:20.

- [Privacy policy](#)
- [About Win-Test Wiki](#)
- [Disclaimers](#)



# File:ToolsCheckLog-M2.PNG

From Win-Test Wiki

[Jump to navigation](#) [Jump to search](#)

- [File](#)
- [File history](#)
- [File usage](#)

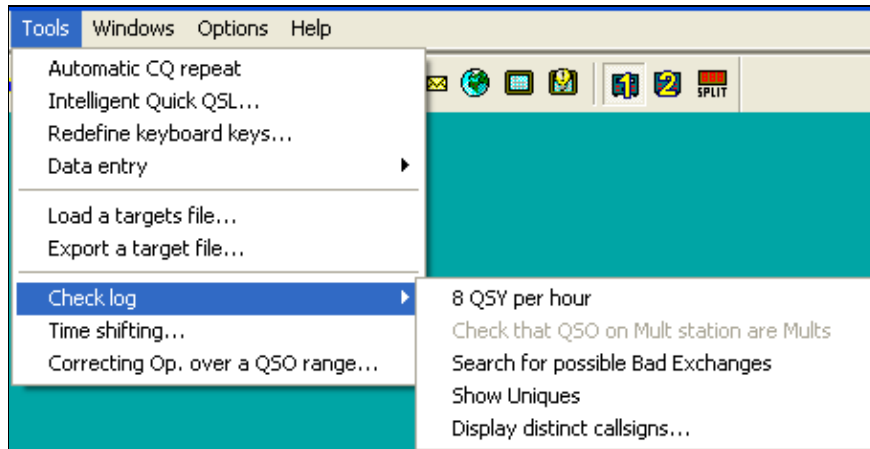

No higher resolution available.

[ToolsCheckLog-M2.PNG](#) (455 × 233 pixels, file size: 8 KB, MIME type: image/gif)

## File history

Click on a date/time to view the file as it appeared at that time.

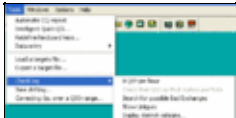
Date/Time	Thumbnail	Dimensions	User	Comment
current <a href="#">05:20, 5 June 2008</a>		455 × 233 (8 KB)	<a href="#">Dl6rai</a> ( <a href="#">talk</a>   <a href="#">contribs</a> )	

You cannot overwrite this file.

## File usage

The following page uses this file:

- [Menu:Tools](#)

## Namespaces

- [File](#)
- [Discussion](#)

## Variants

## Views

- [Read](#)
- [View source](#)
- [View history](#)

## More

- This page was last edited on 5 June 2008, at 05:20.

- [Privacy policy](#)
- [About Win-Test Wiki](#)
- [Disclaimers](#)





# File:ToolsCheckLog-SO.PNG

From Win-Test Wiki

[Jump to navigation](#) [Jump to search](#)

- [File](#)
- [File history](#)
- [File usage](#)

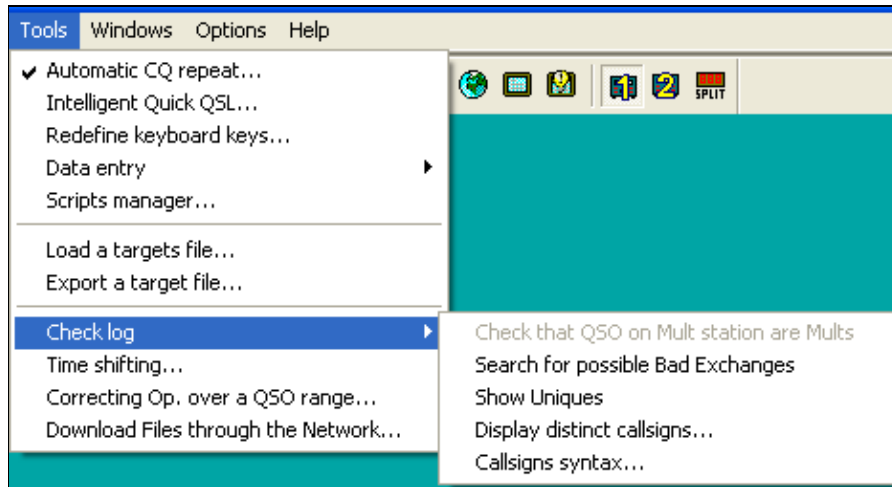

No higher resolution available.

[ToolsCheckLog-SO.PNG](#) (467 × 252 pixels, file size: 9 KB, MIME type: image/gif)

## File history

Click on a date/time to view the file as it appeared at that time.

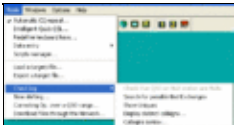
	Date/Time	Thumbnail	Dimensions	User	Comment
current	<a href="#">09:46, 18 April 2010</a>		467 × 252 (9 KB)	<a href="#">Dl6rai</a> ( <a href="#">talk</a>   <a href="#">contribs</a> )	

You cannot overwrite this file.

## File usage

The following page uses this file:

- [Menu:Tools](#)

## Namespaces

- [File](#)
- [Discussion](#)

## Variants

## Views

- [Read](#)
- [View source](#)
- [View history](#)

## More

- This page was last edited on 18 April 2010, at 09:46.

- [Privacy policy](#)
- [About Win-Test Wiki](#)
- [Disclaimers](#)



# File:ToolsCheckLog-SO.PNG

From Win-Test Wiki

[Jump to navigation](#) [Jump to search](#)

- [File](#)
- [File history](#)
- [File usage](#)

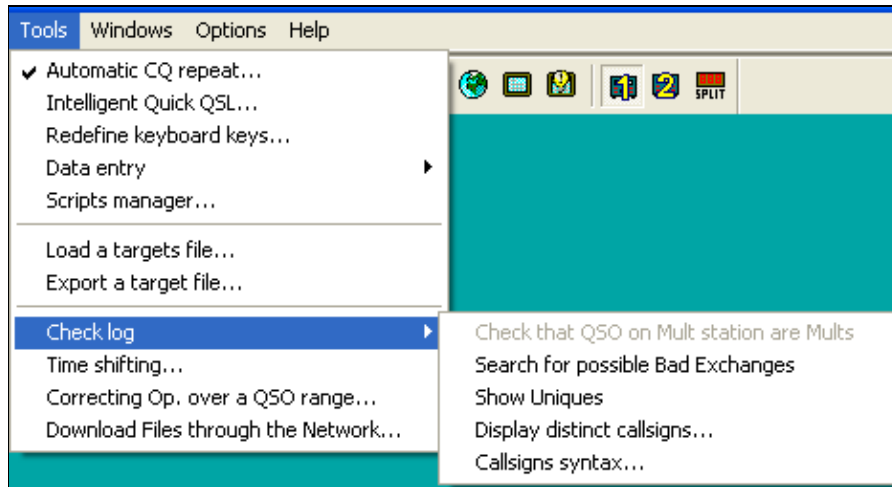

No higher resolution available.

[ToolsCheckLog-SO.PNG](#) (467 × 252 pixels, file size: 9 KB, MIME type: image/gif)

## File history

Click on a date/time to view the file as it appeared at that time.

Date/Time	Thumbnail	Dimensions	User	Comment
current <a href="#">09:46, 18 April 2010</a>		467 × 252 (9 KB)	<a href="#">Dl6rai</a> ( <a href="#">talk</a>   <a href="#">contribs</a> )	

You cannot overwrite this file.

## File usage

The following page uses this file:

- [Menu:Tools](#)

## Namespaces

- [File](#)
- [Discussion](#)

## Variants

## Views

- [Read](#)
- [View source](#)
- [View history](#)

## More

- This page was last edited on 18 April 2010, at 09:46.

- [Privacy policy](#)
- [About Win-Test Wiki](#)
- [Disclaimers](#)



# File:ToolsCorrectingOp.PNG

From Win-Test Wiki

[Jump to navigation](#) [Jump to search](#)

- [File](#)
- [File history](#)
- [File usage](#)

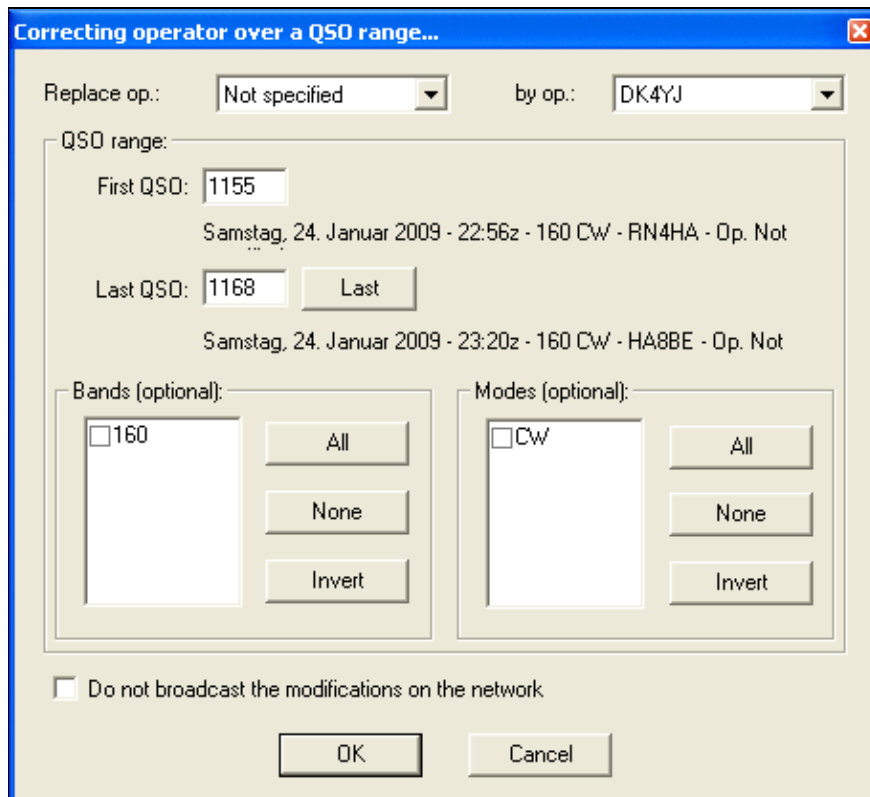

No higher resolution available.

ToolsCorrectingOp.PNG (456 × 416 pixels, file size: 14 KB, MIME type: image.gif)

## File history

Click on a date/time to view the file as it appeared at that time.

	Date/Time	Thumbnail	Dimensions	User	Comment
current	<u>13:23, 31 January 2009</u>		456 × 416 (14 KB)	<u>Dl6rai</u> ( <a href="#">talk</a>   <a href="#">contribs</a> )	

You cannot overwrite this file.

## File usage

The following page uses this file:

- [Menu:Tools](#)

## Namespaces

- [File](#)
- [Discussion](#)

## Variants

## Views

- [Read](#)
- [View source](#)
- [View history](#)

## More

- This page was last edited on 31 January 2009, at 13:23.
- [Privacy policy](#)
- [About Win-Test Wiki](#)
- [Disclaimers](#)



# File:ToolsCorrectingOp.PNG

From Win-Test Wiki

[Jump to navigation](#) [Jump to search](#)

- [File](#)
- [File history](#)
- [File usage](#)

The screenshot shows a dialog box titled "Correcting operator over a QSO range...". It features the following elements:

- Replace op.:** A dropdown menu set to "Not specified".
- by op.:** A dropdown menu set to "DK4YJ".
- QSO range:** A section containing:
  - First QSO:** A text box with "1155" and a preview line: "Samstag, 24. Januar 2009 - 22:56z - 160 CW - RN4HA - Op. Not".
  - Last QSO:** A text box with "1168" and a "Last" button. A preview line below it reads: "Samstag, 24. Januar 2009 - 23:20z - 160 CW - HA8BE - Op. Not".
- Bands (optional):** A list box containing "160" and three buttons: "All", "None", and "Invert".
- Modes (optional):** A list box containing "CW" and three buttons: "All", "None", and "Invert".
- Do not broadcast the modifications on the network
- OK** and **Cancel** buttons at the bottom.

No higher resolution available.

ToolsCorrectingOp.PNG (456 × 416 pixels, file size: 14 KB, MIME type: image.gif)

## File history

Click on a date/time to view the file as it appeared at that time.

	Date/Time	Thumbnail	Dimensions	User	Comment
current	<u>13:23, 31 January 2009</u>		456 × 416 (14 KB)	<u>Dl6rai</u> ( <a href="#">talk</a>   <a href="#">contribs</a> )	

You cannot overwrite this file.

## File usage

The following page uses this file:

- [Menu:Tools](#)

## Namespaces

- [File](#)
- [Discussion](#)

## Variants

## Views

- [Read](#)
- [View source](#)
- [View history](#)

## More

- This page was last edited on 31 January 2009, at 13:23.
- [Privacy policy](#)
- [About Win-Test Wiki](#)
- [Disclaimers](#)





# File:ToolsCountdownTimer1.PNG

From Win-Test Wiki

[Jump to navigation](#) [Jump to search](#)

- [File](#)
- [File history](#)
- [File usage](#)
- [Metadata](#)

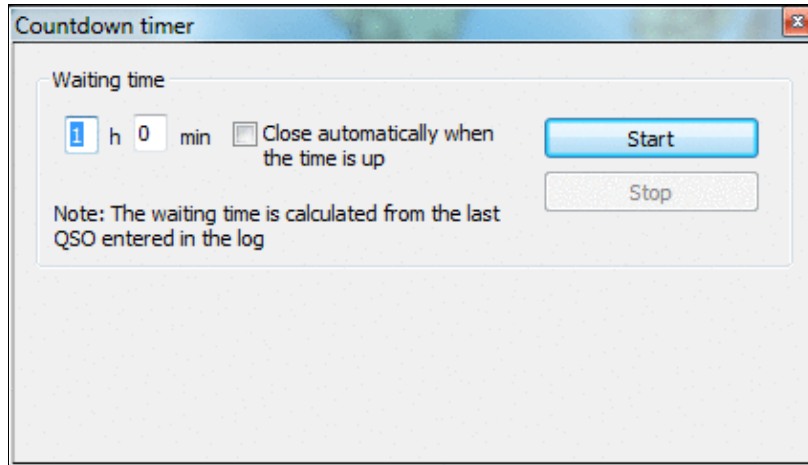

No higher resolution available.

[ToolsCountdownTimer1.PNG](#) (423 × 242 pixels, file size: 18 KB, MIME type: image.gif)

## File history

Click on a date/time to view the file as it appeared at that time.

Date/Time	Thumbnail	Dimensions	User	Comment
current <a href="#">14:52, 9 April 2023</a>		423 × 242 (18 KB)	<a href="#">Dl6rai</a> ( <a href="#">talk</a>   <a href="#">contribs</a> )	

You cannot overwrite this file.

## File usage

The following page uses this file:

- [Menu:Tools](#)

## Metadata

This file contains additional information, probably added from the digital camera or scanner used to create or digitize it.

If the file has been modified from its original state, some details may not fully reflect the modified file.

**Horizontal resolution** 37.79 dpc

**Vertical resolution** 37.79 dpc

## Namespaces

- [File](#)
- [Discussion](#)

## Variants

## Views

- [Read](#)
- [View source](#)
- [View history](#)

## More

- This page was last edited on 9 April 2023, at 14:52.

- [Privacy policy](#)
- [About Win-Test Wiki](#)
- [Disclaimers](#)

- The logo for MediaWiki, featuring a sun icon and the text "Powered By MediaWiki".

# File:ToolsCountdownTimer1.PNG

From Win-Test Wiki

[Jump to navigation](#) [Jump to search](#)

- [File](#)
- [File history](#)
- [File usage](#)
- [Metadata](#)

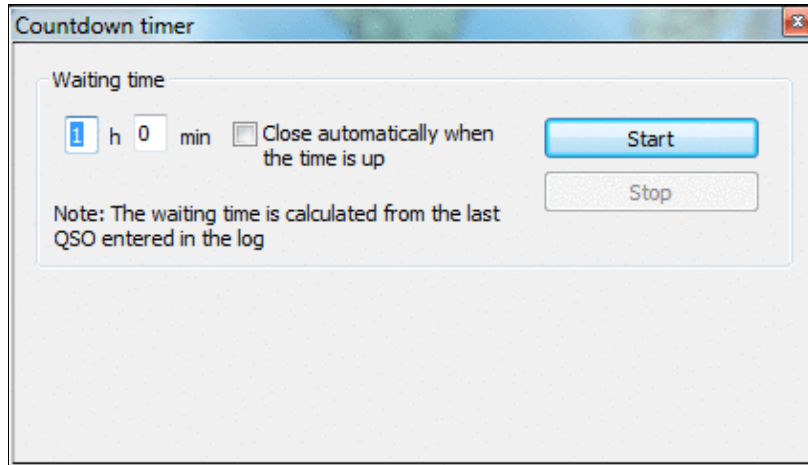

No higher resolution available.

[ToolsCountdownTimer1.PNG](#) (423 × 242 pixels, file size: 18 KB, MIME type: image.gif)

## File history

Click on a date/time to view the file as it appeared at that time.

Date/Time	Thumbnail	Dimensions	User	Comment
current <a href="#">14:52, 9 April 2023</a>		423 × 242 (18 KB)	<a href="#">Dl6rai</a> ( <a href="#">talk</a>   <a href="#">contribs</a> )	

You cannot overwrite this file.

## File usage

The following page uses this file:

- [Menu:Tools](#)

## Metadata

This file contains additional information, probably added from the digital camera or scanner used to create or digitize it.

If the file has been modified from its original state, some details may not fully reflect the modified file.

**Horizontal resolution** 37.79 dpc

**Vertical resolution** 37.79 dpc

## Namespaces

- [File](#)
- [Discussion](#)

## Variants

## Views

- [Read](#)
- [View source](#)
- [View history](#)

## More

- This page was last edited on 9 April 2023, at 14:52.

- [Privacy policy](#)
- [About Win-Test Wiki](#)
- [Disclaimers](#)

- The logo for MediaWiki, featuring a sun icon and the text "Powered By MediaWiki".

# File:ToolsCountdownTimer2.PNG

From Win-Test Wiki

[Jump to navigation](#) [Jump to search](#)

- [File](#)
- [File history](#)
- [File usage](#)
- [Metadata](#)

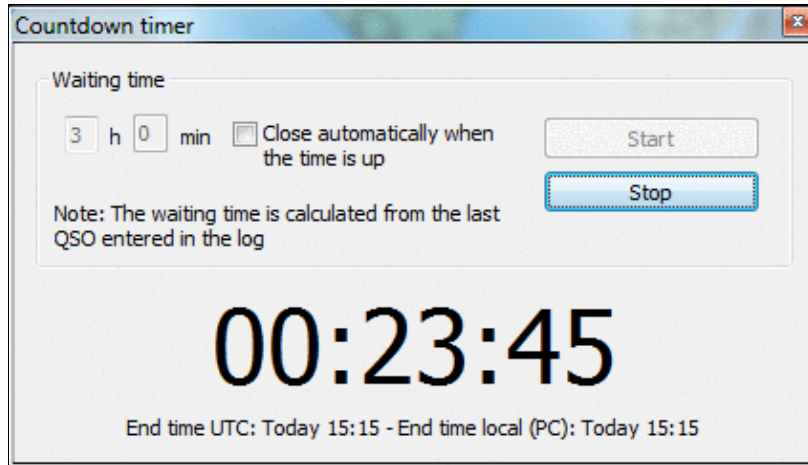

No higher resolution available.

[ToolsCountdownTimer2.PNG](#) (423 × 242 pixels, file size: 21 KB, MIME type: image/gif)

## File history

Click on a date/time to view the file as it appeared at that time.

Date/Time	Thumbnail	Dimensions	User	Comment
current <a href="#">14:52, 9 April 2023</a>		423 × 242 (21 KB)	<a href="#">Dl6rai</a> ( <a href="#">talk</a>   <a href="#">contribs</a> )	

You cannot overwrite this file.

## File usage

The following page uses this file:

- [Menu:Tools](#)

## Metadata

This file contains additional information, probably added from the digital camera or scanner used to create or digitize it.

If the file has been modified from its original state, some details may not fully reflect the modified file.

**Horizontal resolution** 37.79 dpc

**Vertical resolution** 37.79 dpc

## Namespaces

- [File](#)
- [Discussion](#)

## Variants

## Views

- [Read](#)
- [View source](#)
- [View history](#)

## More

- This page was last edited on 9 April 2023, at 14:52.

- [Privacy policy](#)
- [About Win-Test Wiki](#)
- [Disclaimers](#)

-  The logo consists of a small sun icon to the left of the text "Powered By MediaWiki".

# File:ToolsCountdownTimer2.PNG

From Win-Test Wiki

[Jump to navigation](#) [Jump to search](#)

- [File](#)
- [File history](#)
- [File usage](#)
- [Metadata](#)

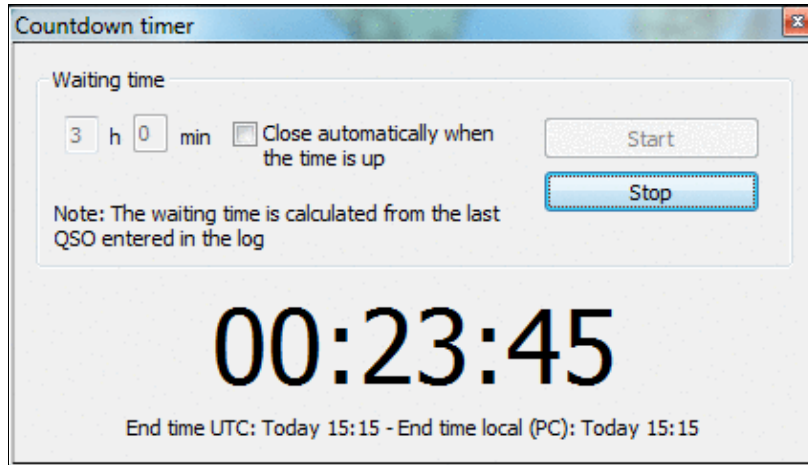

No higher resolution available.

[ToolsCountdownTimer2.PNG](#) (423 × 242 pixels, file size: 21 KB, MIME type: image/gif)

## File history

Click on a date/time to view the file as it appeared at that time.

Date/Time	Thumbnail	Dimensions	User	Comment
current <a href="#">14:52, 9 April 2023</a>		423 × 242 (21 KB)	<a href="#">Dl6rai</a> ( <a href="#">talk</a>   <a href="#">contribs</a> )	

You cannot overwrite this file.

## File usage

The following page uses this file:

- [Menu:Tools](#)

## Metadata

This file contains additional information, probably added from the digital camera or scanner used to create or digitize it.

If the file has been modified from its original state, some details may not fully reflect the modified file.

**Horizontal resolution** 37.79 dpc

**Vertical resolution** 37.79 dpc

## Namespaces

- [File](#)
- [Discussion](#)

## Variants

## Views

- [Read](#)
- [View source](#)
- [View history](#)

## More

- This page was last edited on 9 April 2023, at 14:52.

- [Privacy policy](#)
- [About Win-Test Wiki](#)
- [Disclaimers](#)

- The logo consists of a small sun icon to the left of the text "Powered By MediaWiki".



# File:ToolsDataEntrySwitchKeyboard.PNG

From Win-Test Wiki

[Jump to navigation](#) [Jump to search](#)

- [File](#)
- [File history](#)
- [File usage](#)



No higher resolution available.

[ToolsDataEntrySwitchKeyboard.PNG](#) (285 Å 117 pixels, file size: 4 KB, MIME type: image.gif)

## File history

Click on a date/time to view the file as it appeared at that time.

	Date/Time	Thumbnail	Dimensions	User	Comment
current	<a href="#">08:17, 31 January 2009</a>		285 Å 117 (4 KB)	<a href="#">Dl6rai</a> ( <a href="#">talk</a>   <a href="#">contribs</a> )	

You cannot overwrite this file.

## File usage

The following page uses this file:

- [Menu:Tools](#)

## Namespaces

- [File](#)
- [Discussion](#)

## Variants

## Views

- [Read](#)
- [View source](#)
- [View history](#)

## More

- This page was last edited on 31 January 2009, at 08:17.

- [Privacy policy](#)
- [About Win-Test Wiki](#)
- [Disclaimers](#)



# File:ToolsDataEntrySwitchKeyboard.PNG

From Win-Test Wiki

[Jump to navigation](#) [Jump to search](#)

- [File](#)
- [File history](#)
- [File usage](#)



No higher resolution available.

[ToolsDataEntrySwitchKeyboard.PNG](#) (285 Å 117 pixels, file size: 4 KB, MIME type: image.gif)

## File history

Click on a date/time to view the file as it appeared at that time.

	Date/Time	Thumbnail	Dimensions	User	Comment
current	<a href="#">08:17, 31 January 2009</a>		285 Å 117 (4 KB)	<a href="#">Dl6rai</a> ( <a href="#">talk</a>   <a href="#">contribs</a> )	

You cannot overwrite this file.

## File usage

The following page uses this file:

- [Menu:Tools](#)

## Namespaces

- [File](#)
- [Discussion](#)

## Variants

## Views

- [Read](#)
- [View source](#)
- [View history](#)

## More

- This page was last edited on 31 January 2009, at 08:17.

- [Privacy policy](#)
- [About Win-Test Wiki](#)
- [Disclaimers](#)



# File:ToolsDownloadFiles.PNG

From Win-Test Wiki

[Jump to navigation](#) [Jump to search](#)

- [File](#)
- [File history](#)
- [File usage](#)

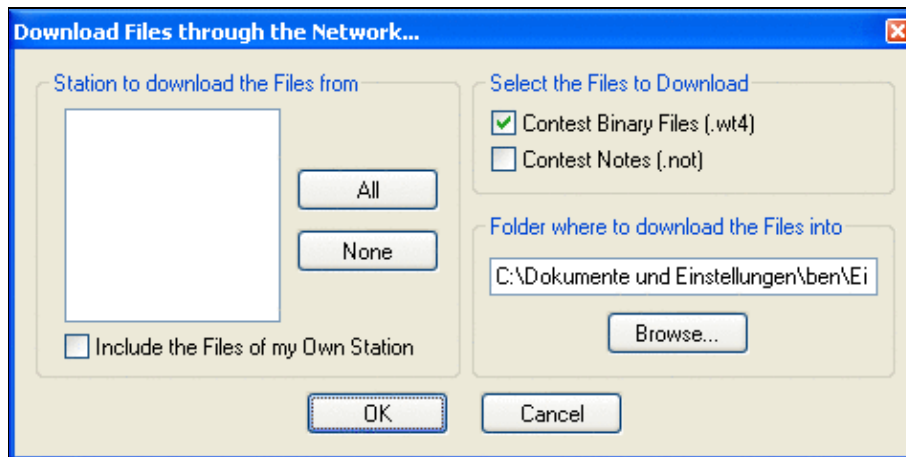

No higher resolution available.

[ToolsDownloadFiles.PNG](#) (476 × 237 pixels, file size: 13 KB, MIME type: image/gif)

## File history

Click on a date/time to view the file as it appeared at that time.

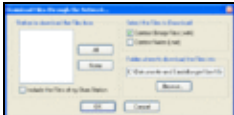
	Date/Time	Thumbnail	Dimensions	User	Comment
current	<a href="#">17:32, 4 October 2009</a>		476 × 237 (13 KB)	<a href="#">Dl6rai</a> ( <a href="#">talk</a>   <a href="#">contribs</a> )	

You cannot overwrite this file.

## File usage

The following page uses this file:

- [Menu:Tools](#)

## Namespaces

- [File](#)
- [Discussion](#)

## Variants

## Views

- [Read](#)
- [View source](#)
- [View history](#)

## More

- This page was last edited on 4 October 2009, at 17:32.

- [Privacy policy](#)
- [About Win-Test Wiki](#)
- [Disclaimers](#)



# File:ToolsDownloadFiles.PNG

From Win-Test Wiki

[Jump to navigation](#) [Jump to search](#)

- [File](#)
- [File history](#)
- [File usage](#)

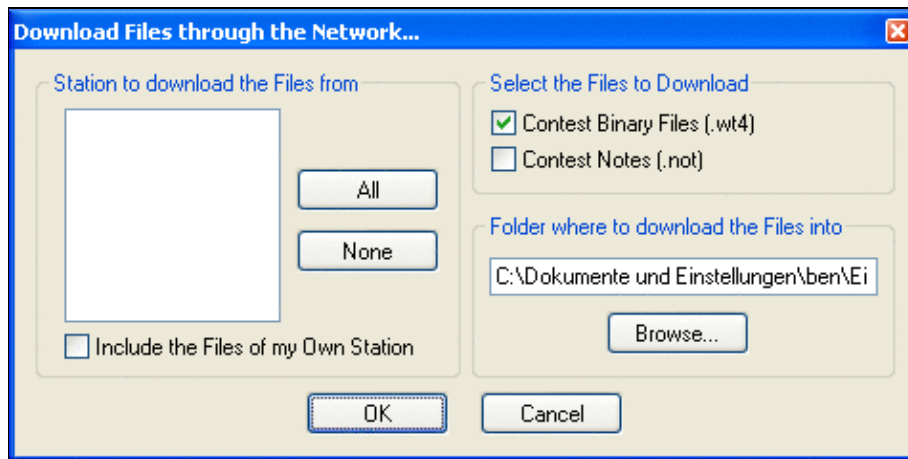

No higher resolution available.

[ToolsDownloadFiles.PNG](#) (476 × 237 pixels, file size: 13 KB, MIME type: image/gif)

## File history

Click on a date/time to view the file as it appeared at that time.

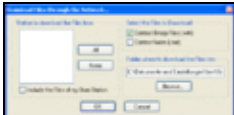
	Date/Time	Thumbnail	Dimensions	User	Comment
current	<a href="#">17:32, 4 October 2009</a>		476 × 237 (13 KB)	<a href="#">Dl6rai</a> ( <a href="#">talk</a>   <a href="#">contribs</a> )	

You cannot overwrite this file.

## File usage

The following page uses this file:

- [Menu:Tools](#)

## Namespaces

- [File](#)
- [Discussion](#)

## Variants

## Views

- [Read](#)
- [View source](#)
- [View history](#)

## More

- This page was last edited on 4 October 2009, at 17:32.

- [Privacy policy](#)
- [About Win-Test Wiki](#)
- [Disclaimers](#)





# File:ToolsEnableSPSwitching.gif

From Win-Test Wiki

[Jump to navigation](#) [Jump to search](#)

- [File](#)
- [File history](#)
- [File usage](#)

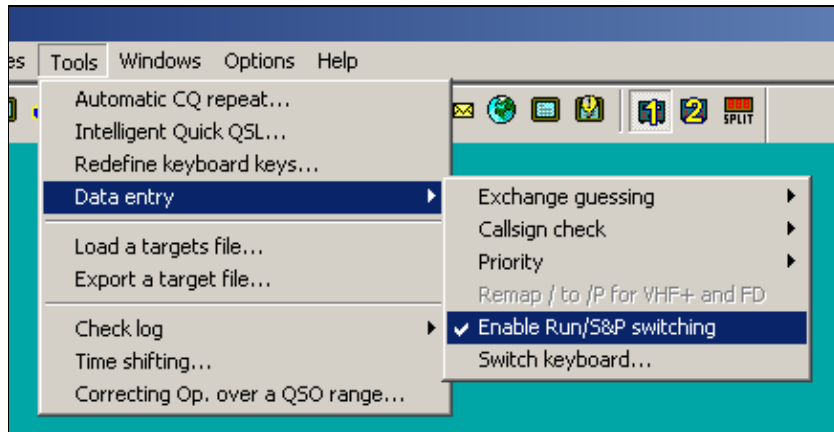

No higher resolution available.

[ToolsEnableSPSwitching.gif](#) (436 × 224 pixels, file size: 6 KB, MIME type: image.gif)

Enable Run/S&P Switching

## File history

Click on a date/time to view the file as it appeared at that time.

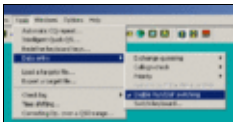
	Date/Time	Thumbnail	Dimensions	User	Comment
current	<a href="#">21:46, 11 November 2008</a>		436 × 224 (6 KB)	<a href="#">DL4NER</a> ( <a href="#">talk</a>   <a href="#">contribs</a> )	Enable Run/S&P Switching

You cannot overwrite this file.

## File usage

The following page uses this file:

- [Menu:Tools](#)

## Namespaces

- [File](#)
- [Discussion](#)

## Variants

## Views

- [Read](#)
- [View source](#)
- [View history](#)

## More

- This page was last edited on 11 November 2008, at 21:46.

- [Privacy policy](#)
- [About Win-Test Wiki](#)
- [Disclaimers](#)



# File:ToolsEnableSPSwitching.gif

From Win-Test Wiki

[Jump to navigation](#) [Jump to search](#)

- [File](#)
- [File history](#)
- [File usage](#)

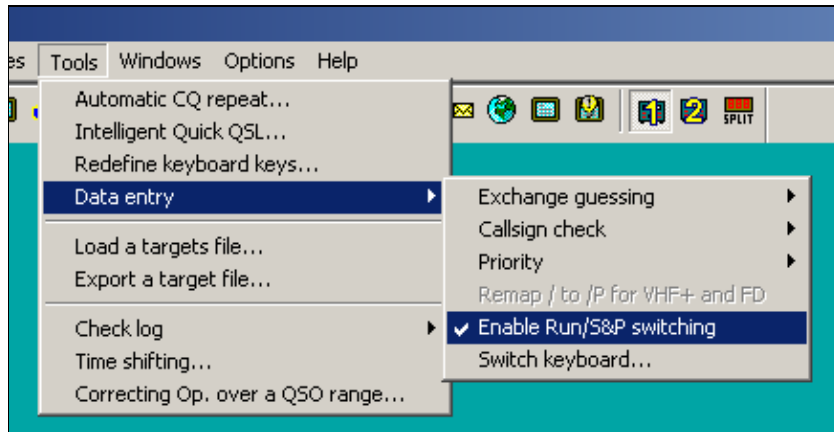

No higher resolution available.

[ToolsEnableSPSwitching.gif](#) (436 × 224 pixels, file size: 6 KB, MIME type: image.gif)

Enable Run/S&P Switching

## File history

Click on a date/time to view the file as it appeared at that time.

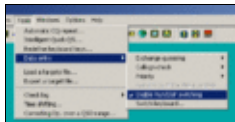
	Date/Time	Thumbnail	Dimensions	User	Comment
current	<a href="#">21:46, 11 November 2008</a>		436 × 224 (6 KB)	<a href="#">DL4NER</a> ( <a href="#">talk</a>   <a href="#">contribs</a> )	Enable Run/S&P Switching

You cannot overwrite this file.

## File usage

The following page uses this file:

- [Menu:Tools](#)

## Namespaces

- [File](#)
- [Discussion](#)

## Variants

## Views

- [Read](#)
- [View source](#)
- [View history](#)

## More

- This page was last edited on 11 November 2008, at 21:46.

- [Privacy policy](#)
- [About Win-Test Wiki](#)
- [Disclaimers](#)



# File:ToolsExportObjectiveFile.gif

From Win-Test Wiki

[Jump to navigation](#) [Jump to search](#)

- [File](#)
- [File history](#)
- [File usage](#)

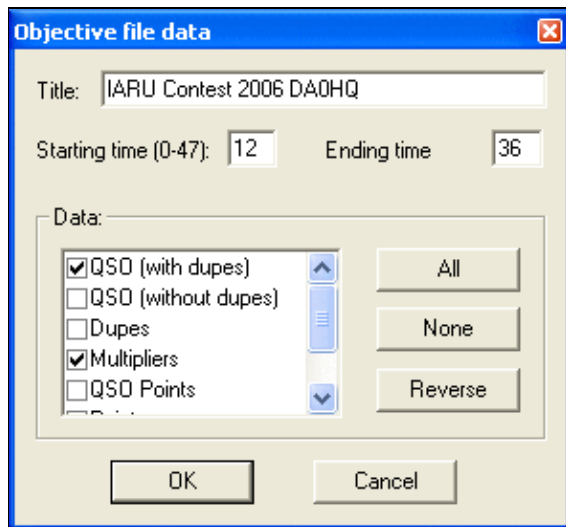

No higher resolution available.

[ToolsExportObjectiveFile.gif](#) (294 × 273 pixels, file size: 9 KB, MIME type: image.gif)

## File history

Click on a date/time to view the file as it appeared at that time.

Date/Time	Thumbnail	Dimensions	User	Comment
current <a href="#">17:43, 5 August 2006</a>		294 × 273 (9 KB)	<a href="#">Dl6rai</a> ( <a href="#">talk</a>   <a href="#">contribs</a> )	

You cannot overwrite this file.

## File usage

The following page uses this file:

- [Menu:Tools](#)

## Namespaces

- [File](#)
- [Discussion](#)

## Variants

## Views

- [Read](#)
- [View source](#)
- [View history](#)

## More

- This page was last edited on 5 August 2006, at 17:43.

- [Privacy policy](#)
- [About Win-Test Wiki](#)
- [Disclaimers](#)

- The logo for MediaWiki, featuring a sun icon and the text "Powered By MediaWiki".

# File:ToolsExportObjectiveFile.gif

From Win-Test Wiki

[Jump to navigation](#) [Jump to search](#)

- [File](#)
- [File history](#)
- [File usage](#)

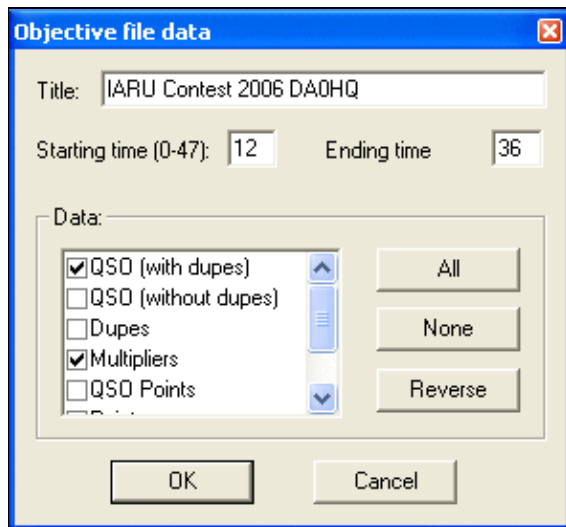

No higher resolution available.

[ToolsExportObjectiveFile.gif](#) (294 × 273 pixels, file size: 9 KB, MIME type: image.gif)

## File history

Click on a date/time to view the file as it appeared at that time.

Date/Time	Thumbnail	Dimensions	User	Comment
current <a href="#">17:43, 5 August 2006</a>		294 × 273 (9 KB)	<a href="#">Dl6rai</a> ( <a href="#">talk</a>   <a href="#">contribs</a> )	

You cannot overwrite this file.

## File usage

The following page uses this file:

- [Menu:Tools](#)

## Namespaces

- [File](#)
- [Discussion](#)

## Variants

## Views

- [Read](#)
- [View source](#)
- [View history](#)

## More

- This page was last edited on 5 August 2006, at 17:43.

- [Privacy policy](#)
- [About Win-Test Wiki](#)
- [Disclaimers](#)

- The logo for MediaWiki, featuring a sun icon and the text "Powered By MediaWiki".



# File:ToolsIntelligentQuickQSL.gif

From Win-Test Wiki

[Jump to navigation](#) [Jump to search](#)

- [File](#)
- [File history](#)
- [File usage](#)

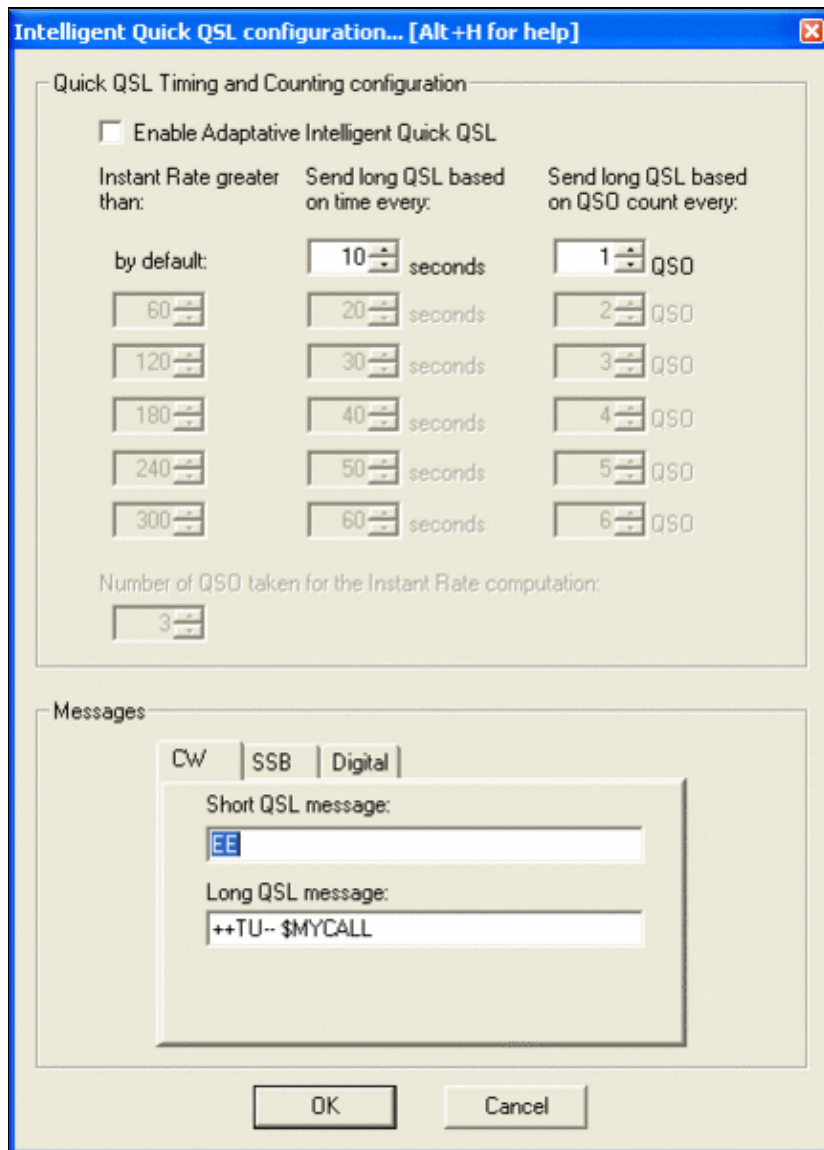

Size of this preview: [431 Å 600 pixels](#). Other resolutions: [172 Å 240 pixels](#) | [432 Å 601 pixels](#). [Original file](#) (432 Å 601 pixels, file size: 19 KB, MIME type: image.gif)

## File history

Click on a date/time to view the file as it appeared at that time.

Date/Time	Thumbnail	Dimensions	User	Comment
current <a href="#">06:49, 15 September 2007</a>		432 Å 601 (19 KB)	<a href="#">Dl6rai</a> ( <a href="#">talk</a>   <a href="#">contribs</a> )	

You cannot overwrite this file.

## File usage

The following page uses this file:

- [Menu:Tools](#)

## Namespaces

- [File](#)
- [Discussion](#)

## Variants

## Views

- [Read](#)
- [View source](#)
- [View history](#)

## More

- This page was last edited on 15 September 2007, at 06:49.
- [Privacy policy](#)
- [About Win-Test Wiki](#)
- [Disclaimers](#)



# File:ToolsIntelligentQuickQSL.gif

From Win-Test Wiki

[Jump to navigation](#) [Jump to search](#)

- [File](#)
- [File history](#)
- [File usage](#)

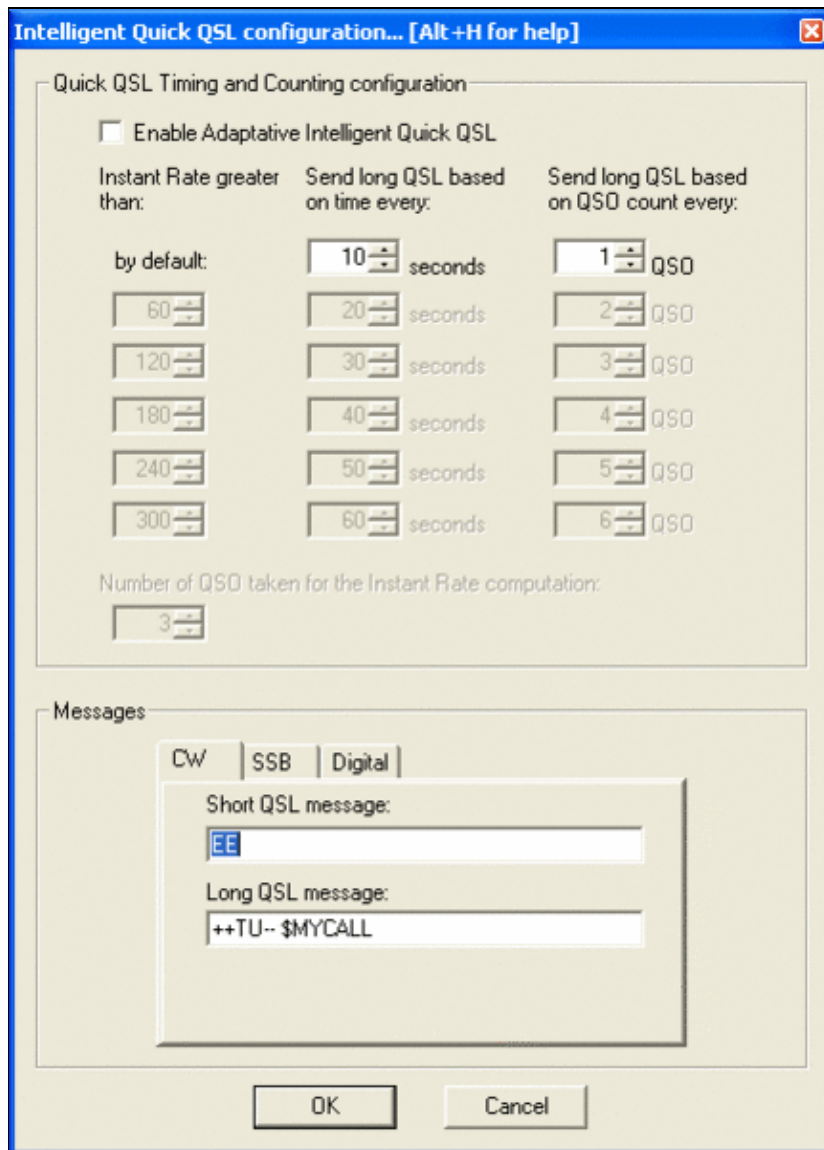

Size of this preview: [431 Å 600 pixels](#). Other resolutions: [172 Å 240 pixels](#) | [432 Å 601 pixels](#).  
[Original file](#) (432 Å 601 pixels, file size: 19 KB, MIME type: image.gif)

## File history

Click on a date/time to view the file as it appeared at that time.

Date/Time	Thumbnail	Dimensions	User	Comment
current <a href="#">06:49, 15 September 2007</a>		<a href="#">432 Å 601 (19 KB)</a>	<a href="#">Dl6rai</a> ( <a href="#">talk</a>   <a href="#">contribs</a> )	

You cannot overwrite this file.

## File usage

The following page uses this file:

- [Menu:Tools](#)

## Namespaces

- [File](#)
- [Discussion](#)

## Variants

## Views

- [Read](#)
- [View source](#)
- [View history](#)

## More

- This page was last edited on 15 September 2007, at 06:49.
- [Privacy policy](#)
- [About Win-Test Wiki](#)
- [Disclaimers](#)



# File:ToolsRedefineKeyboard.gif

From Win-Test Wiki

[Jump to navigation](#) [Jump to search](#)

- [File](#)
- [File history](#)
- [File usage](#)

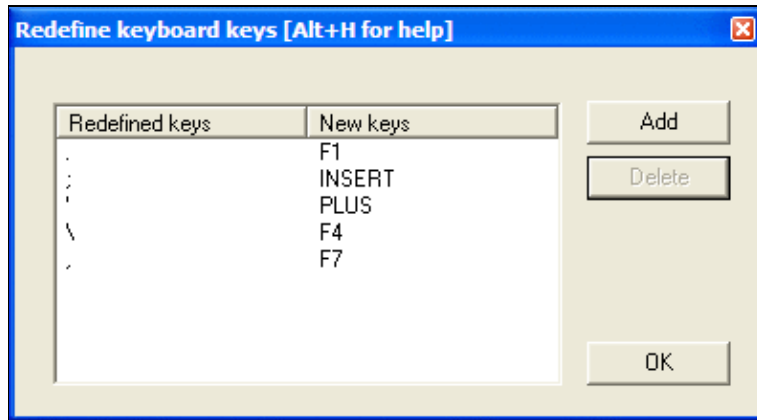

No higher resolution available.

[ToolsRedefineKeyboard.gif](#) (395 × 217 pixels, file size: 8 KB, MIME type: image/gif)

## File history

Click on a date/time to view the file as it appeared at that time.

	Date/Time	Thumbnail	Dimensions	User	Comment
current	<a href="#">08:42, 28 July 2007</a>		395 × 217 (8 KB)	<a href="#">N6TV</a> ( <a href="#">talk</a>   <a href="#">contribs</a> )	A more useful example, developed for Team Vertical by N6TV.
	<a href="#">16:04, 5 August 2006</a>		395 × 217 (6 KB)	<a href="#">Dl6rai</a> ( <a href="#">talk</a>   <a href="#">contribs</a> )	
	<a href="#">15:19, 5 August 2006</a>		393 × 215 (4 KB)	<a href="#">Dl6rai</a> ( <a href="#">talk</a>   <a href="#">contribs</a> )	

You cannot overwrite this file.

## File usage

The following page uses this file:

- [Menu:Tools](#)

## Namespaces

- [File](#)
- [Discussion](#)

## Variants

## Views

- [Read](#)
- [View source](#)
- [View history](#)

## More

- This page was last edited on 5 August 2006, at 15:19.

- [Privacy policy](#)
- [About Win-Test Wiki](#)
- [Disclaimers](#)

- The logo consists of a small sun icon to the left of the text "Powered By MediaWiki". The text is in a blue, sans-serif font, and the entire logo is enclosed in a thin black rectangular border.

# File:ToolsRedefineKeyboard2.gif

From Win-Test Wiki

[Jump to navigation](#) [Jump to search](#)

- [File](#)
- [File history](#)
- [File usage](#)

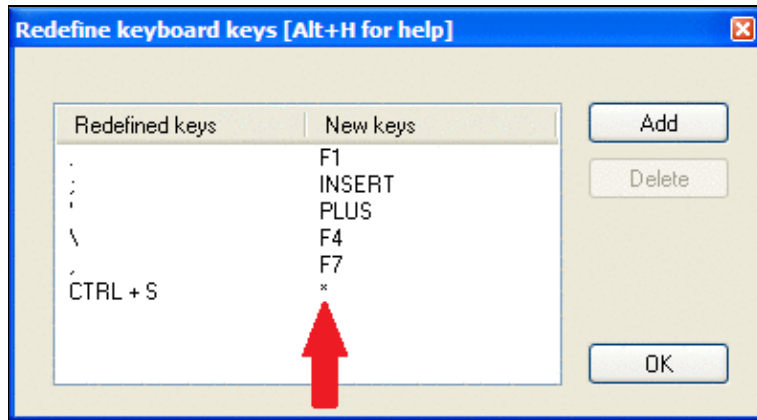

No higher resolution available.

[ToolsRedefineKeyboard2.gif](#) (395 × 217 pixels, file size: 11 KB, MIME type: image.gif)

Same as Tools RedefineKeyboard.gif but with arrow indicating a single asterisk in the right hand column.

## File history

Click on a date/time to view the file as it appeared at that time.

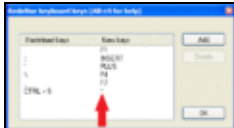
	Date/Time	Thumbnail	Dimensions	User	Comment
current	<a href="#">21:15, 9 May 2010</a>		395 × 217 (11 KB)	<a href="#">N6TV</a> ( <a href="#">talk</a>   <a href="#">contribs</a> )	Same as Tools RedefineKeyboard.gif but with arrow indicating a single asterisk in the right hand column.

You cannot overwrite this file.

## File usage

The following page uses this file:

- [Menu:Tools](#)

## Namespaces

- [File](#)
- [Discussion](#)

## Variants

## Views

- [Read](#)
- [View source](#)
- [View history](#)

## More

- This page was last edited on 9 May 2010, at 21:15.

- [Privacy policy](#)
- [About Win-Test Wiki](#)
- [Disclaimers](#)





# File:ToolsRedefineKeyboard2.gif

From Win-Test Wiki

[Jump to navigation](#) [Jump to search](#)

- [File](#)
- [File history](#)
- [File usage](#)

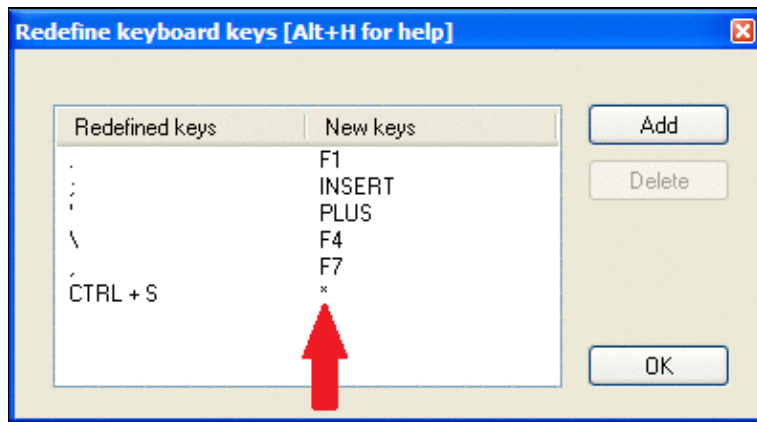

No higher resolution available.

[ToolsRedefineKeyboard2.gif](#) (395 × 217 pixels, file size: 11 KB, MIME type: image.gif)

Same as Tools RedefineKeyboard.gif but with arrow indicating a single asterisk in the right hand column.

## File history

Click on a date/time to view the file as it appeared at that time.

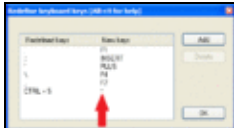
	Date/Time	Thumbnail	Dimensions	User	Comment
current	<a href="#">21:15, 9 May 2010</a>		395 × 217 (11 KB)	<a href="#">N6TV</a> ( <a href="#">talk</a>   <a href="#">contribs</a> )	Same as Tools RedefineKeyboard.gif but with arrow indicating a single asterisk in the right hand column.

You cannot overwrite this file.

## File usage

The following page uses this file:

- [Menu:Tools](#)

## Namespaces

- [File](#)
- [Discussion](#)

## Variants

## Views

- [Read](#)
- [View source](#)
- [View history](#)

## More

- This page was last edited on 9 May 2010, at 21:15.

- [Privacy policy](#)
- [About Win-Test Wiki](#)
- [Disclaimers](#)



# File:ToolsRedefineKeyboard.gif

From Win-Test Wiki

[Jump to navigation](#) [Jump to search](#)

- [File](#)
- [File history](#)
- [File usage](#)

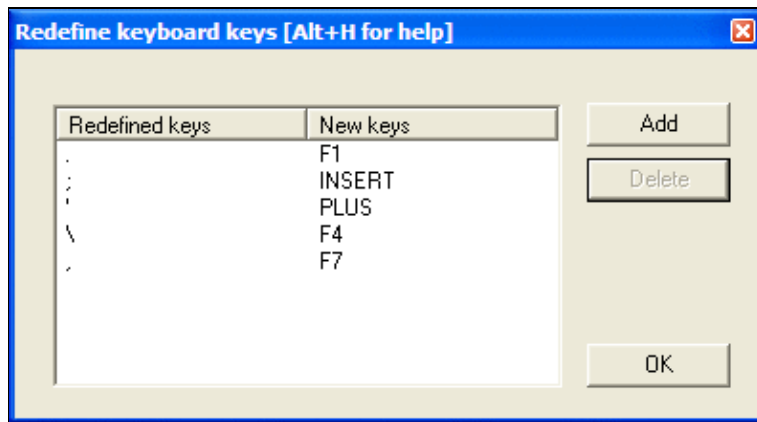

No higher resolution available.

[ToolsRedefineKeyboard.gif](#) (395 × 217 pixels, file size: 8 KB, MIME type: image/gif)

## File history

Click on a date/time to view the file as it appeared at that time.

	Date/Time	Thumbnail	Dimensions	User	Comment
current	<a href="#">08:42, 28 July 2007</a>		395 × 217 (8 KB)	<a href="#">N6TV</a> ( <a href="#">talk</a>   <a href="#">contribs</a> )	A more useful example, developed for Team Vertical by N6TV.
	<a href="#">16:04, 5 August 2006</a>		395 × 217 (6 KB)	<a href="#">Dl6rai</a> ( <a href="#">talk</a>   <a href="#">contribs</a> )	
	<a href="#">15:19, 5 August 2006</a>		393 × 215 (4 KB)	<a href="#">Dl6rai</a> ( <a href="#">talk</a>   <a href="#">contribs</a> )	

You cannot overwrite this file.

## File usage

The following page uses this file:

- [Menu:Tools](#)

## Namespaces

- [File](#)
- [Discussion](#)

## Variants

## Views

- [Read](#)
- [View source](#)
- [View history](#)

## More

- This page was last edited on 5 August 2006, at 15:19.
- [Privacy policy](#)
- [About Win-Test Wiki](#)
- [Disclaimers](#)



# File:ToolsScriptManager.PNG

From Win-Test Wiki

[Jump to navigation](#) [Jump to search](#)

- [File](#)
- [File history](#)
- [File usage](#)
- [Metadata](#)

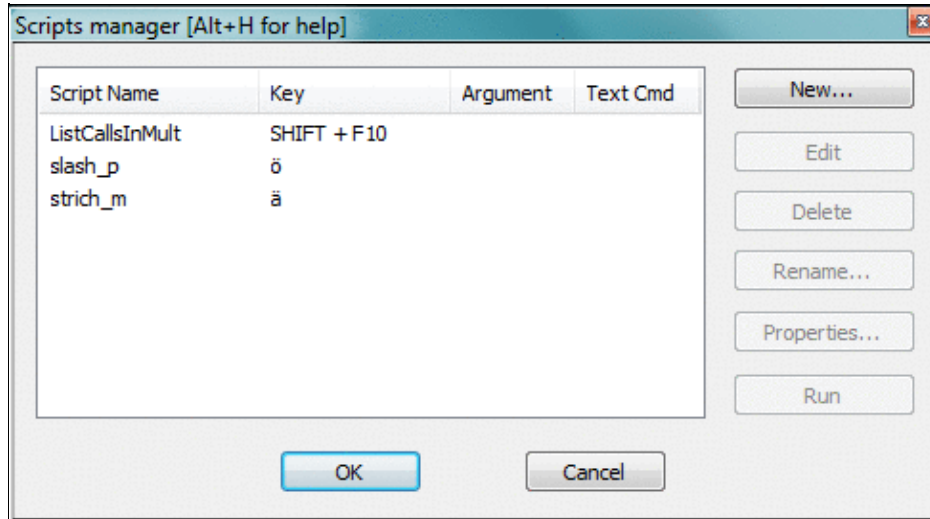



No higher resolution available.

[ToolsScriptManager.PNG](#) (488 × 271 pixels, file size: 17 KB, MIME type: image.gif)

## File history

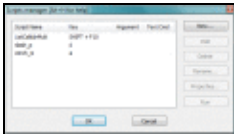
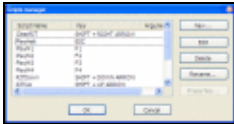
Click on a date/time to view the file as it appeared at that time.

	Date/Time	Thumbnail	Dimensions	User	Comment
current	<a href="#">15:44, 17 December 2016</a>		488 × 271 (17 KB)	<a href="#">Dl6rai (talk   contribs)</a>	
	<a href="#">10:15, 15 November 2009</a>		447 × 232 (16 KB)	<a href="#">N6TV (talk   contribs)</a>	New version has more examples matching sample K3 LUA scripts and more reasonable keystroke mappings.
	<a href="#">11:15, 4 October 2009</a>		447 × 234 (10 KB)	<a href="#">Dl6rai (talk   contribs)</a>	
	<a href="#">10:44, 4 October 2009</a>		447 × 234 (9 KB)	<a href="#">Dl6rai (talk   contribs)</a>	

Date/Time	Thumbnail	Dimensions	User	Comment
You cannot overwrite this file.				

## File usage

The following page uses this file:

- [Menu:Tools](#)

## Metadata

This file contains additional information, probably added from the digital camera or scanner used to create or digitize it.

If the file has been modified from its original state, some details may not fully reflect the modified file.

**Horizontal resolution** 37.79 dpc

**Vertical resolution** 37.79 dpc

## Namespaces

- [File](#)
- [Discussion](#)

## Variants

## Views

- [Read](#)
- [View source](#)
- [View history](#)

## More

- This page was last edited on 17 December 2016, at 15:44.

- [Privacy policy](#)
- [About Win-Test Wiki](#)
- [Disclaimers](#)



# File:ToolsScriptManager.PNG

From Win-Test Wiki

[Jump to navigation](#) [Jump to search](#)

- [File](#)
- [File history](#)
- [File usage](#)
- [Metadata](#)

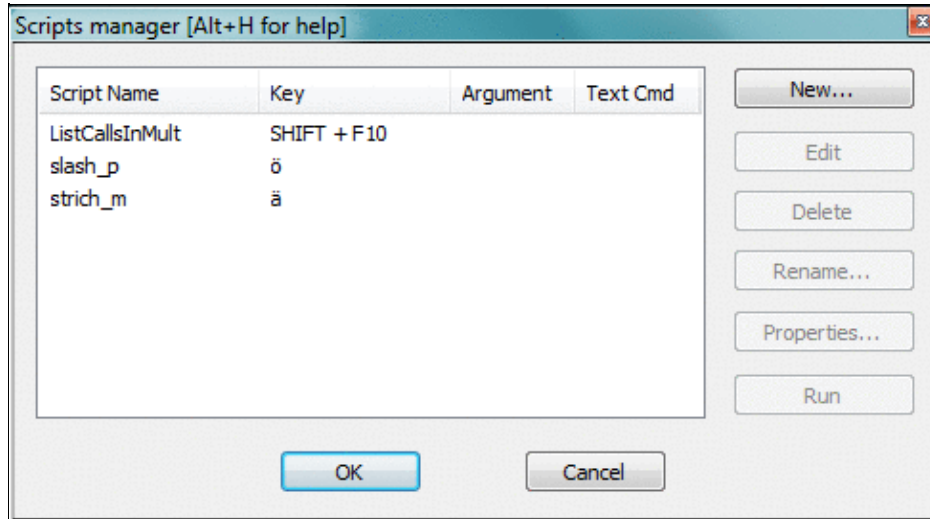



No higher resolution available.

[ToolsScriptManager.PNG](#) (488 × 271 pixels, file size: 17 KB, MIME type: image.gif)

## File history

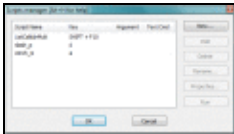
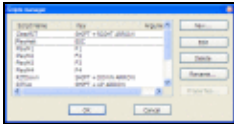
Click on a date/time to view the file as it appeared at that time.

	Date/Time	Thumbnail	Dimensions	User	Comment
current	<a href="#">15:44, 17 December 2016</a>		488 × 271 (17 KB)	<a href="#">Dl6rai (talk   contribs)</a>	
	<a href="#">10:15, 15 November 2009</a>		447 × 232 (16 KB)	<a href="#">N6TV (talk   contribs)</a>	New version has more examples matching sample K3 LUA scripts and more reasonable keystroke mappings.
	<a href="#">11:15, 4 October 2009</a>		447 × 234 (10 KB)	<a href="#">Dl6rai (talk   contribs)</a>	
	<a href="#">10:44, 4 October 2009</a>		447 × 234 (9 KB)	<a href="#">Dl6rai (talk   contribs)</a>	

Date/Time	Thumbnail	Dimensions	User	Comment
You cannot overwrite this file.				

## File usage

The following page uses this file:

- [Menu:Tools](#)

## Metadata

This file contains additional information, probably added from the digital camera or scanner used to create or digitize it.

If the file has been modified from its original state, some details may not fully reflect the modified file.

**Horizontal resolution** 37.79 dpc

**Vertical resolution** 37.79 dpc

## Namespaces

- [File](#)
- [Discussion](#)

## Variants

## Views

- [Read](#)
- [View source](#)
- [View history](#)

## More

- This page was last edited on 17 December 2016, at 15:44.

- [Privacy policy](#)
- [About Win-Test Wiki](#)
- [Disclaimers](#)





# File:Total.PNG

From Win-Test Wiki

[Jump to navigation](#) [Jump to search](#)

- [File](#)
- [File history](#)
- [File usage](#)

```
Untitled - Notepad
File Edit Format View Help
All bands - All modes
QSOs (with dupes) - By time
! Hr !
!-----!
! 00 !      209 !
! 01 !      201 !
! 02 !      173 !
! 03 !      155 !
! 04 !      138 !
! 05 !      178 !
! 06 !      156 !
! 07 !      147 !
! 08 !      206 !
! 09 !      146 !
! 10 !      185 !
! 11 !      183 !
! 12 !      183 !
! 13 !      187 !
! 14 !      194 !
! 15 !      185 !
! 16 !      143 !
! 17 !      212 !
! 18 !      170 !
! 19 !      143 !
! 20 !      148 !
! 21 !      141 !
! 22 !      122 !
! 23 !      132 !
! 00 !       95 !
! 01 !       19 !
! 02 !
! 03 !       92 !
! 04 !       98 !
! 05 !      138 !
```

No higher resolution available.

Total.PNG (763 × 536 pixels, file size: 24 KB, MIME type: image.gif)

## File history

Click on a date/time to view the file as it appeared at that time.

	Date/Time	Thumbnail	Dimensions	User	Comment
current	<u>15:24, 13 October 2006</u>		763 × 536 (24 KB)	<u>Ct1boh</u> ( <a href="#">talk</a>   <a href="#">contribs</a> )	

You cannot overwrite this file.

## File usage

The following page uses this file:

- [Extracting log Information](#)

## Namespaces

- [File](#)
- [Discussion](#)

## Variants

## Views

- [Read](#)
- [View source](#)
- [View history](#)

## More

- This page was last edited on 13 October 2006, at 15:24.
- [Privacy policy](#)
- [About Win-Test Wiki](#)
- [Disclaimers](#)



# File:Total.PNG

From Win-Test Wiki

[Jump to navigation](#) [Jump to search](#)

- [File](#)
- [File history](#)
- [File usage](#)

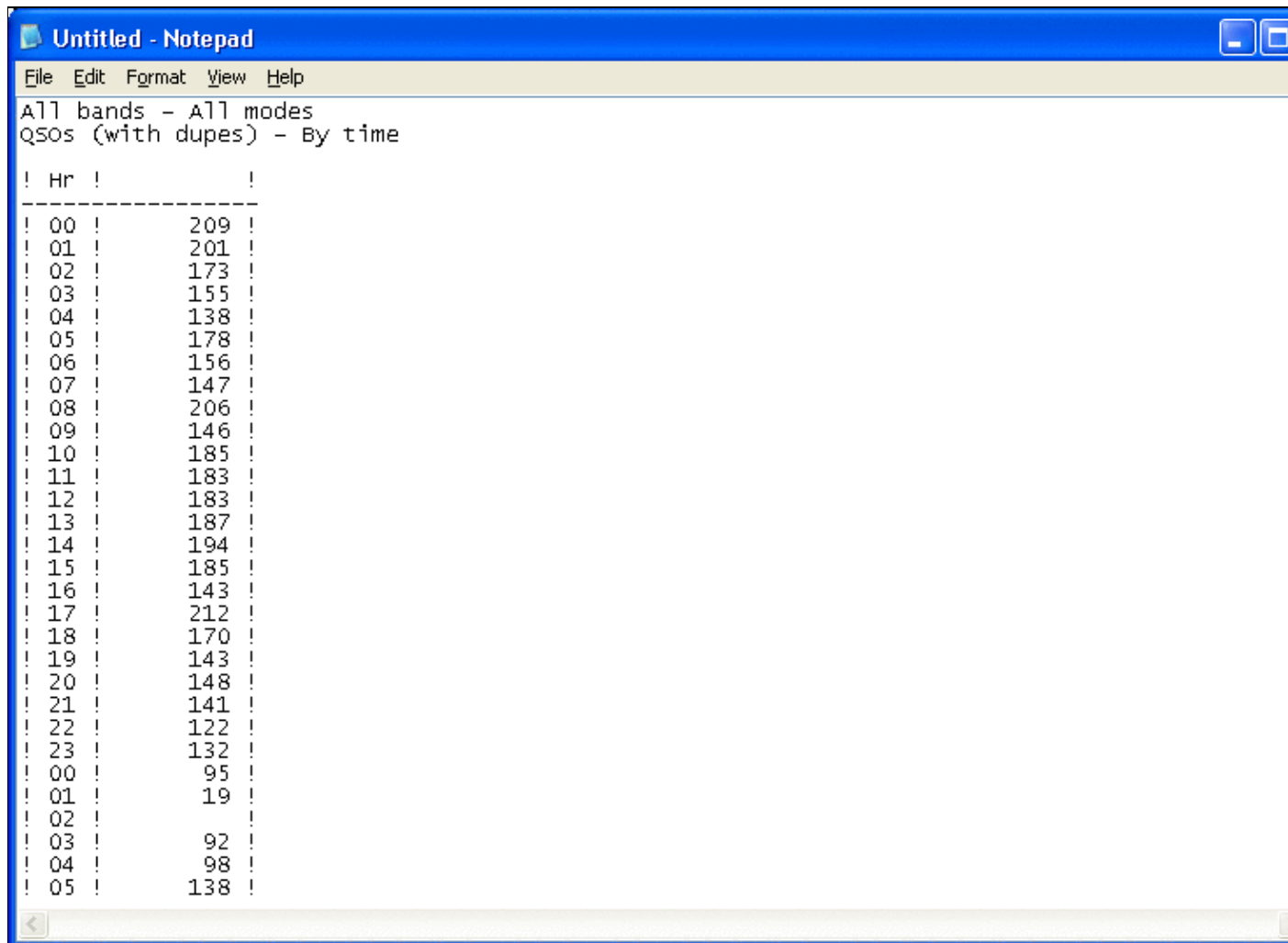

```
File Edit Format View Help
All bands - All modes
QSOs (with dupes) - By time
! Hr !
-----
! 00 !      209 !
! 01 !      201 !
! 02 !      173 !
! 03 !      155 !
! 04 !      138 !
! 05 !      178 !
! 06 !      156 !
! 07 !      147 !
! 08 !      206 !
! 09 !      146 !
! 10 !      185 !
! 11 !      183 !
! 12 !      183 !
! 13 !      187 !
! 14 !      194 !
! 15 !      185 !
! 16 !      143 !
! 17 !      212 !
! 18 !      170 !
! 19 !      143 !
! 20 !      148 !
! 21 !      141 !
! 22 !      122 !
! 23 !      132 !
! 00 !       95 !
! 01 !       19 !
! 02 !
! 03 !       92 !
! 04 !       98 !
! 05 !      138 !
```

No higher resolution available.

Total.PNG (763 × 536 pixels, file size: 24 KB, MIME type: image.gif)

## File history

Click on a date/time to view the file as it appeared at that time.

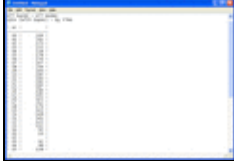
	Date/Time	Thumbnail	Dimensions	User	Comment
current	<u>15:24, 13 October 2006</u>		763 × 536 (24 KB)	<u>Ct1boh</u> ( <a href="#">talk</a>   <a href="#">contribs</a> )	

You cannot overwrite this file.

## File usage

The following page uses this file:

- [Extracting log Information](#)

## Namespaces

- [File](#)
- [Discussion](#)

## Variants

## Views

- [Read](#)
- [View source](#)
- [View history](#)

## More

- This page was last edited on 13 October 2006, at 15:24.
- [Privacy policy](#)
- [About Win-Test Wiki](#)
- [Disclaimers](#)



# File:TryFixFile.gif

From Win-Test Wiki

[Jump to navigation](#) [Jump to search](#)

- [File](#)
- [File history](#)
- [File usage](#)

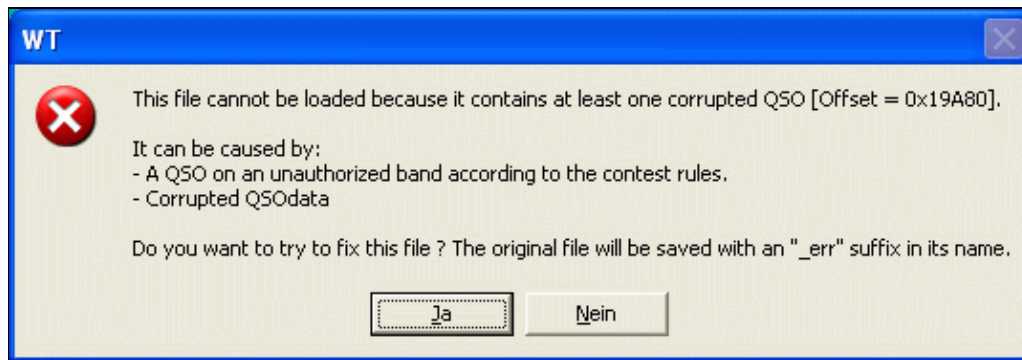

No higher resolution available.

[TryFixFile.gif](#) (536 × 185 pixels, file size: 16 KB, MIME type: image/gif)

## File history

Click on a date/time to view the file as it appeared at that time.

	Date/Time	Thumbnail	Dimensions	User	Comment
current	<a href="#">18:52, 2 December 2006</a>		536 × 185 (16 KB)	<a href="#">Dl6rai</a> ( <a href="#">talk</a>   <a href="#">contribs</a> )	

You cannot overwrite this file.

## File usage

The following page uses this file:

- [Menu:File new](#)

## Namespaces

- [File](#)
- [Discussion](#)

## Variants

## Views

- [Read](#)
- [View source](#)
- [View history](#)

## More

- This page was last edited on 2 December 2006, at 18:52.

- [Privacy policy](#)
- [About Win-Test Wiki](#)
- [Disclaimers](#)



# File:TryFixFile.gif

From Win-Test Wiki

[Jump to navigation](#) [Jump to search](#)

- [File](#)
- [File history](#)
- [File usage](#)

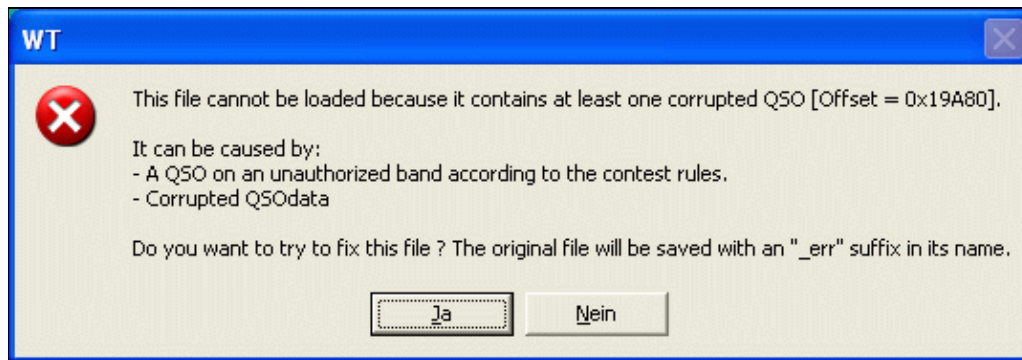

No higher resolution available.

[TryFixFile.gif](#) (536 × 185 pixels, file size: 16 KB, MIME type: image/gif)

## File history

Click on a date/time to view the file as it appeared at that time.

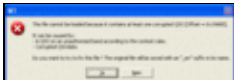
	Date/Time	Thumbnail	Dimensions	User	Comment
current	<a href="#">18:52, 2 December 2006</a>		536 × 185 (16 KB)	<a href="#">Dl6rai</a> ( <a href="#">talk</a>   <a href="#">contribs</a> )	

You cannot overwrite this file.

## File usage

The following page uses this file:

- [Menu:File new](#)

## Namespaces

- [File](#)
- [Discussion](#)

## Variants

## Views

- [Read](#)
- [View source](#)
- [View history](#)

## More

- This page was last edited on 2 December 2006, at 18:52.

- [Privacy policy](#)
- [About Win-Test Wiki](#)
- [Disclaimers](#)





# File:Uniques report.gif

From Win-Test Wiki

[Jump to navigation](#) [Jump to search](#)

- [File](#)
- [File history](#)
- [File usage](#)
- [Metadata](#)

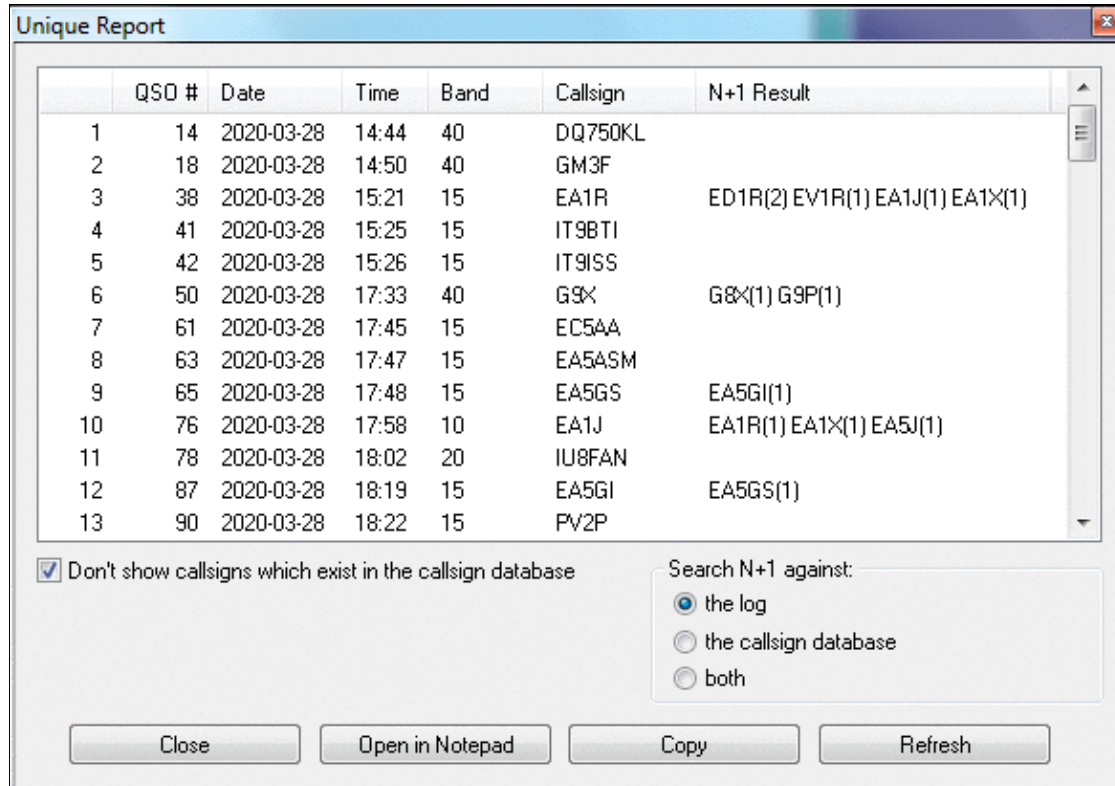

The screenshot shows a window titled "Unique Report" with a table of QSO data and search options. The table has columns for QSO #, Date, Time, Band, Callsign, and N+1 Result. Below the table are checkboxes and radio buttons for search options, and buttons for Close, Open in Notepad, Copy, and Refresh.

	QSO #	Date	Time	Band	Callsign	N+1 Result
1	14	2020-03-28	14:44	40	DQ750KL	
2	18	2020-03-28	14:50	40	GM3F	
3	38	2020-03-28	15:21	15	EA1R	ED1R(2) EV1R(1) EA1J(1) EA1X(1)
4	41	2020-03-28	15:25	15	IT9BTI	
5	42	2020-03-28	15:26	15	IT9ISS	
6	50	2020-03-28	17:33	40	G9X	G8X(1) G9P(1)
7	61	2020-03-28	17:45	15	EC5AA	
8	63	2020-03-28	17:47	15	EA5ASM	
9	65	2020-03-28	17:48	15	EA5GS	EA5GI(1)
10	76	2020-03-28	17:58	10	EA1J	EA1R(1) EA1X(1) EA5J(1)
11	78	2020-03-28	18:02	20	IU8FAN	
12	87	2020-03-28	18:19	15	EA5GI	EA5GS(1)
13	90	2020-03-28	18:22	15	PV2P	

Don't show callsigns which exist in the callsign database

Search N+1 against:

- the log
- the callsign database
- both

Close    Open in Notepad    Copy    Refresh

No higher resolution available.

Uniques\_report.gif (584 × 412 pixels, file size: 27 KB, MIME type: image/gif)

## File history

Click on a date/time to view the file as it appeared at that time.

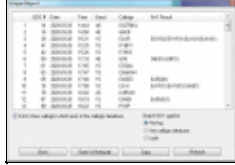
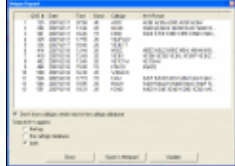
	Date/Time	Thumbnail	Dimensions	User	Comment
current	<u>11:29, 4 April 2020</u>		584 × 412 (27 KB)	<u>D16rai</u> ( <span><u>talk</u></span>   <span><u>contribs</u></span> )	
	<u>10:31, 14 March 2007</u>		586 × 424 (24 KB)	<u>I2WIJ</u> ( <span><u>talk</u></span>   <span><u>contribs</u></span> )	

You cannot overwrite this file.

## File usage

The following page uses this file:

- Menu:Tools

## Metadata

This file contains additional information, probably added from the digital camera or scanner used to create or digitize it.

If the file has been modified from its original state, some details may not fully reflect the modified file.

**Horizontal resolution** 37.79 dpc

**Vertical resolution** 37.79 dpc

## Namespaces

- File
- Discussion

## Variants

## Views

- Read
- View source
- View history

## More

- This page was last edited on 4 April 2020, at 11:29.

- [Privacy policy](#)
- [About Win-Test Wiki](#)
- [Disclaimers](#)



# File:Uniques report.gif

From Win-Test Wiki

[Jump to navigation](#) [Jump to search](#)

- [File](#)
- [File history](#)
- [File usage](#)
- [Metadata](#)

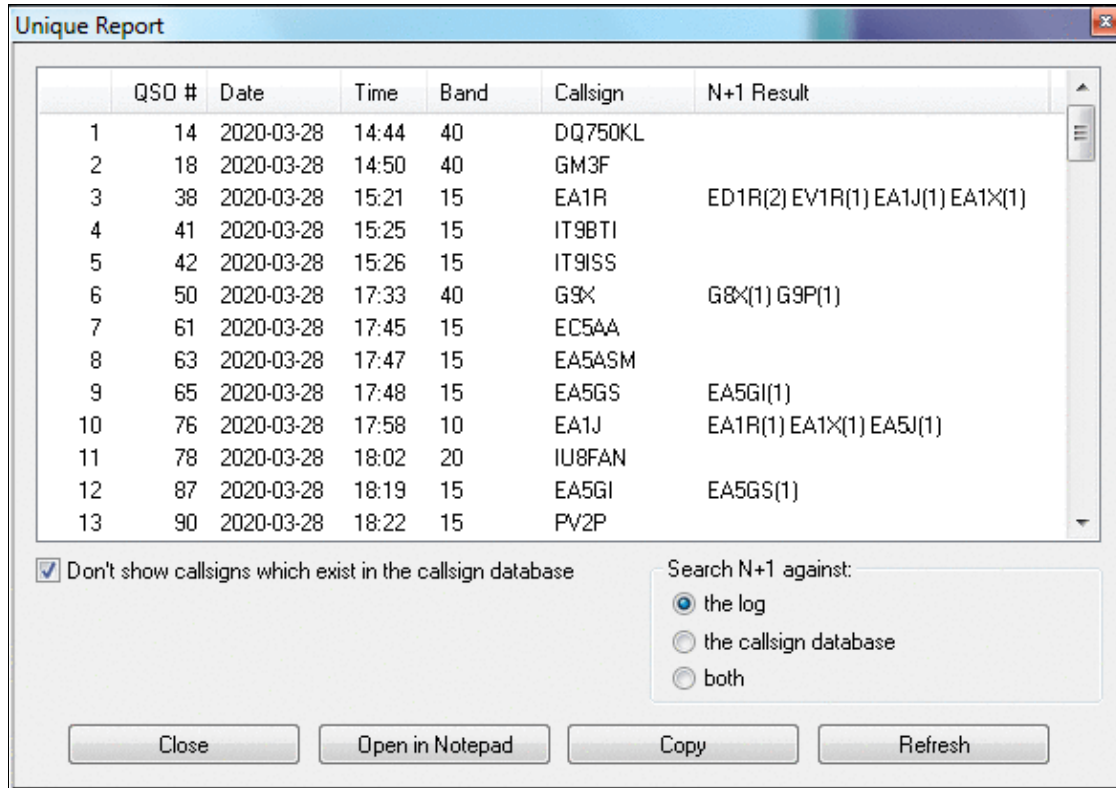

The screenshot shows a window titled "Unique Report" with a table of 13 rows of QSO data. The columns are QSO #, Date, Time, Band, Callsign, and N+1 Result. Below the table are checkboxes and radio buttons for search options, and four buttons: Close, Open in Notepad, Copy, and Refresh.

QSO #	Date	Time	Band	Callsign	N+1 Result
1	14	2020-03-28	14:44	40	DQ750KL
2	18	2020-03-28	14:50	40	GM3F
3	38	2020-03-28	15:21	15	EA1R ED1R(2) EV1R(1) EA1J(1) EA1X(1)
4	41	2020-03-28	15:25	15	IT9BTI
5	42	2020-03-28	15:26	15	IT9ISS
6	50	2020-03-28	17:33	40	G9X G8X(1) G9P(1)
7	61	2020-03-28	17:45	15	EC5AA
8	63	2020-03-28	17:47	15	EA5ASM
9	65	2020-03-28	17:48	15	EA5GS EA5GI(1)
10	76	2020-03-28	17:58	10	EA1J EA1R(1) EA1X(1) EA5J(1)
11	78	2020-03-28	18:02	20	IU8FAN
12	87	2020-03-28	18:19	15	EA5GI EA5GS(1)
13	90	2020-03-28	18:22	15	PV2P

Don't show callsigns which exist in the callsign database

Search N+1 against:

- the log
- the callsign database
- both

Close    Open in Notepad    Copy    Refresh

No higher resolution available.

Uniques\_report.gif (584 × 412 pixels, file size: 27 KB, MIME type: image/gif)

## File history

Click on a date/time to view the file as it appeared at that time.

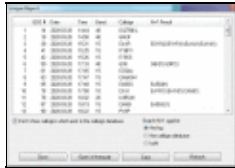
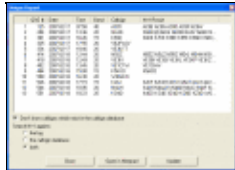
	Date/Time	Thumbnail	Dimensions	User	Comment
current	<u>11:29, 4 April 2020</u>		584 × 412 (27 KB)	<u>D16rai</u> ( <u>talk</u>   <u>contribs</u> )	
	<u>10:31, 14 March 2007</u>		586 × 424 (24 KB)	<u>I2WIJ</u> ( <u>talk</u>   <u>contribs</u> )	

You cannot overwrite this file.

## File usage

The following page uses this file:

- Menu:Tools

## Metadata

This file contains additional information, probably added from the digital camera or scanner used to create or digitize it.

If the file has been modified from its original state, some details may not fully reflect the modified file.

**Horizontal resolution** 37.79 dpc

**Vertical resolution** 37.79 dpc

## Namespaces

- File
- Discussion

## Variants

## Views

- Read
- View source
- View history

## More

- This page was last edited on 4 April 2020, at 11:29.

- [Privacy policy](#)
- [About Win-Test Wiki](#)
- [Disclaimers](#)



# File:urouterSetupMKControl.gif

From Win-Test Wiki

[Jump to navigation](#) [Jump to search](#)

- [File](#)
- [File history](#)
- [File usage](#)
- [Metadata](#)

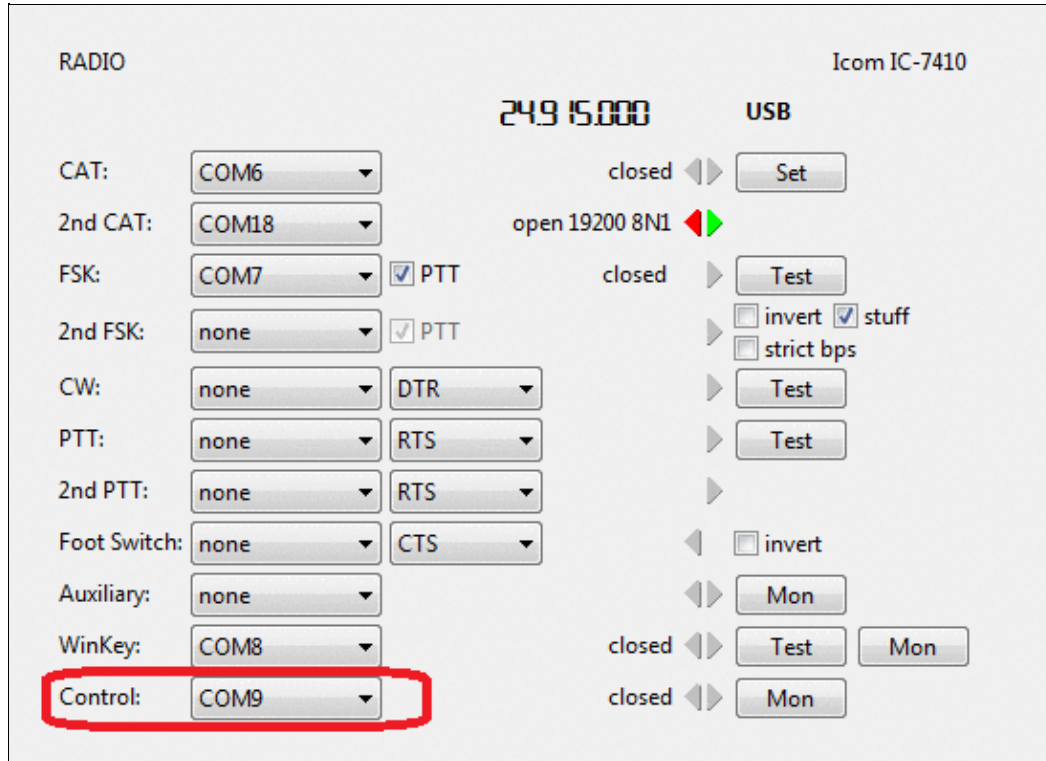

No higher resolution available.

[urouterSetupMKControl.gif](#) (549 × 398 pixels, file size: 28 KB, MIME type: image/gif)

## File history

Click on a date/time to view the file as it appeared at that time.

Date/Time	Thumbnail	Dimensions	User	Comment
current <a href="#">07:58, 2 March 2021</a>		549 × 398 (28 KB)	<a href="#">Dl6rai</a> ( <a href="#">talk</a>   <a href="#">contribs</a> )	

You cannot overwrite this file.

## File usage

The following page uses this file:

- [DVK CW RTTY Messaging](#)

## Metadata

This file contains additional information, probably added from the digital camera or scanner used to create or digitize it.

If the file has been modified from its original state, some details may not fully reflect the modified file.

**Horizontal resolution** 37.8 dpc

**Vertical resolution** 37.8 dpc

## Namespaces

- [File](#)
- [Discussion](#)

## Variants

## Views

- [Read](#)
- [View source](#)
- [View history](#)

## More

- This page was last edited on 2 March 2021, at 07:58.



## Win-Test Wiki

- [Privacy policy](#)
- [About Win-Test Wiki](#)
- [Disclaimers](#)



# File:urouterSetupMKControl.gif

From Win-Test Wiki

[Jump to navigation](#) [Jump to search](#)

- [File](#)
- [File history](#)
- [File usage](#)
- [Metadata](#)

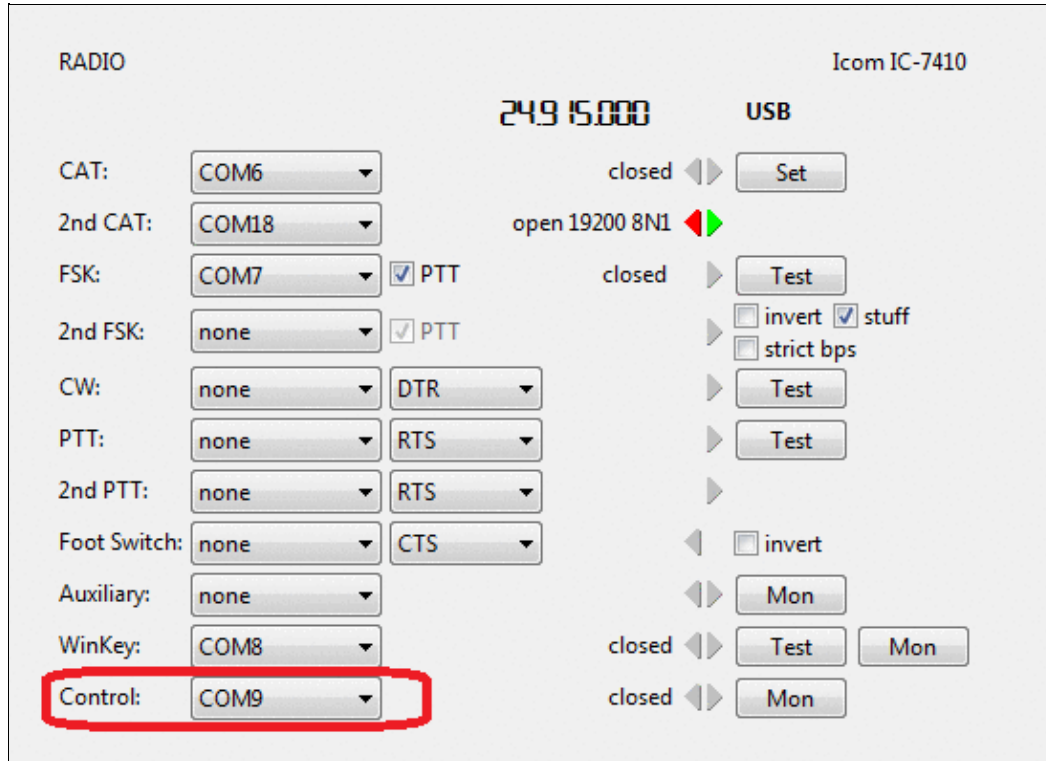

No higher resolution available.

[urouterSetupMKControl.gif](#) (549 × 398 pixels, file size: 28 KB, MIME type: image/gif)

## File history

Click on a date/time to view the file as it appeared at that time.

Date/Time	Thumbnail	Dimensions	User	Comment
current <a href="#">07:58, 2 March 2021</a>		549 × 398 (28 KB)	<a href="#">Dl6rai</a> ( <a href="#">talk</a>   <a href="#">contribs</a> )	

You cannot overwrite this file.

## File usage

The following page uses this file:

- [DVK CW RTTY Messaging](#)

## Metadata

This file contains additional information, probably added from the digital camera or scanner used to create or digitize it.

If the file has been modified from its original state, some details may not fully reflect the modified file.

**Horizontal resolution** 37.8 dpc

**Vertical resolution** 37.8 dpc

## Namespaces

- [File](#)
- [Discussion](#)

## Variants

## Views

- [Read](#)
- [View source](#)
- [View history](#)

## More

- This page was last edited on 2 March 2021, at 07:58.

## Win-Test Wiki

- [Privacy policy](#)
- [About Win-Test Wiki](#)
- [Disclaimers](#)



# File:Usbic.gif

From Win-Test Wiki

[Jump to navigation](#) [Jump to search](#)

- [File](#)
- [File history](#)
- [File usage](#)



No higher resolution available.

[Usbic.gif](#) (413 × 313 pixels, file size: 54 KB, MIME type: image/gif)

## File history

Click on a date/time to view the file as it appeared at that time.

	Date/Time	Thumbnail	Dimensions	User	Comment
current	<a href="#">10:21, 17 May 2007</a>		413 × 313 (54 KB)	<a href="#">Dl6rai (talk   contribs)</a>	

You cannot overwrite this file.

## File usage

The following page uses this file:

- [BestPractice3](#)

## Namespaces

- [File](#)
- [Discussion](#)

## Variants

## Views

- [Read](#)
- [View source](#)
- [View history](#)

## More

- This page was last edited on 17 May 2007, at 10:21.

- [Privacy policy](#)
- [About Win-Test Wiki](#)
- [Disclaimers](#)



# File:Usbic.gif

From Win-Test Wiki

[Jump to navigation](#) [Jump to search](#)

- [File](#)
- [File history](#)
- [File usage](#)



No higher resolution available.

[Usbic.gif](#) (413 × 313 pixels, file size: 54 KB, MIME type: image/gif)

## File history

Click on a date/time to view the file as it appeared at that time.

	Date/Time	Thumbnail	Dimensions	User	Comment
current	<a href="#">10:21, 17 May 2007</a>		413 × 313 (54 KB)	<a href="#">Dl6rai (talk   contribs)</a>	

You cannot overwrite this file.

## File usage

The following page uses this file:

- [BestPractice3](#)

## Namespaces

- [File](#)
- [Discussion](#)

## Variants

## Views

- [Read](#)
- [View source](#)
- [View history](#)

## More

- This page was last edited on 17 May 2007, at 10:21.

- [Privacy policy](#)
- [About Win-Test Wiki](#)
- [Disclaimers](#)





# File:UsedFilesList.PNG

From Win-Test Wiki

[Jump to navigation](#) [Jump to search](#)

- [File](#)
- [File history](#)
- [File usage](#)

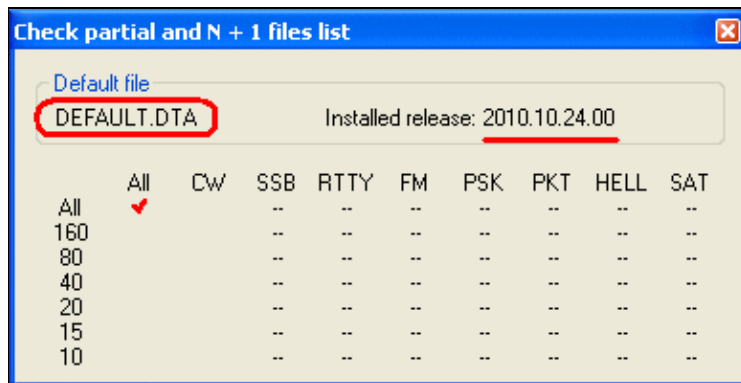

No higher resolution available.

[UsedFilesList.PNG](#) (387 × 198 pixels, file size: 7 KB, MIME type: image.gif)

Default check partial file set to DEFAULT.DTA.

## File history

Click on a date/time to view the file as it appeared at that time.

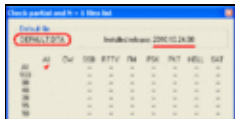
	Date/Time	Thumbnail	Dimensions	User	Comment
current	<a href="#">21:02, 9 November 2010</a>		387 × 198 (7 KB)	<a href="#">N6TV (talk   contribs)</a>	Default check partial file set to DEFAULT.DTA.

You cannot overwrite this file.

## File usage

The following page uses this file:

- [Sweepstakes](#)

## Namespaces

- [File](#)
- [Discussion](#)

## Variants

## Views

- [Read](#)
- [View source](#)
- [View history](#)

## More

- This page was last edited on 9 November 2010, at 21:02.

- [Privacy policy](#)
- [About Win-Test Wiki](#)
- [Disclaimers](#)



# File:UsedFilesList.PNG

From Win-Test Wiki

[Jump to navigation](#) [Jump to search](#)

- [File](#)
- [File history](#)
- [File usage](#)

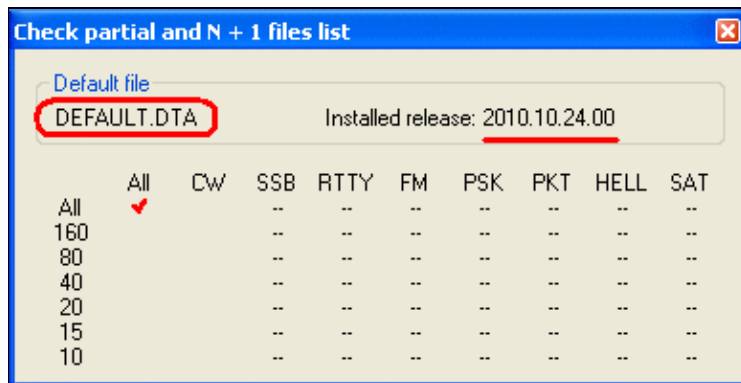

No higher resolution available.

[UsedFilesList.PNG](#) (387 × 198 pixels, file size: 7 KB, MIME type: image.gif)

Default check partial file set to DEFAULT.DTA.

## File history

Click on a date/time to view the file as it appeared at that time.

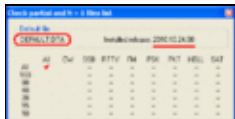
	Date/Time	Thumbnail	Dimensions	User	Comment
current	<a href="#">21:02, 9 November 2010</a>		387 × 198 (7 KB)	<a href="#">N6TV (talk   contribs)</a>	Default check partial file set to DEFAULT.DTA.

You cannot overwrite this file.

## File usage

The following page uses this file:

- [Sweepstakes](#)

## Namespaces

- [File](#)
- [Discussion](#)

## Variants

## Views

- [Read](#)
- [View source](#)
- [View history](#)

## More

- This page was last edited on 9 November 2010, at 21:02.

- [Privacy policy](#)
- [About Win-Test Wiki](#)
- [Disclaimers](#)



# File:VOICESettingsmicroHAM.gif

From Win-Test Wiki

[Jump to navigation](#) [Jump to search](#)

- [File](#)
- [File history](#)
- [File usage](#)
- [Metadata](#)

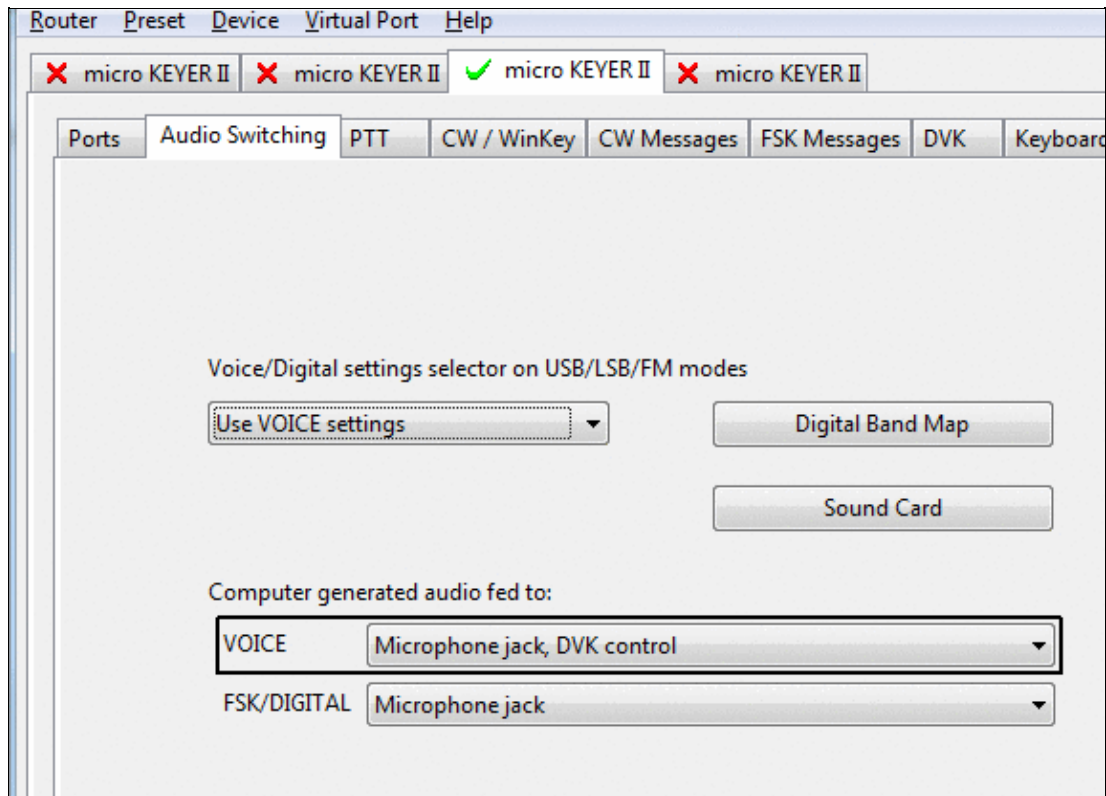

No higher resolution available.

[VOICESettingsmicroHAM.gif](#) (573 × 413 pixels, file size: 15 KB, MIME type: image/gif)

## File history

Click on a date/time to view the file as it appeared at that time.

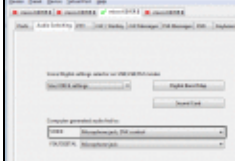
Date/Time	Thumbnail	Dimensions	User	Comment
current <a href="#">14:59, 30 October 2022</a>		573 × 413 (15 KB)	<a href="#">Dl6rai</a> ( <a href="#">talk</a>   <a href="#">contribs</a> )	

You cannot overwrite this file.

## File usage

The following page uses this file:

- [DVK CW RTTY Messaging](#)

## Metadata

This file contains additional information, probably added from the digital camera or scanner used to create or digitize it.

If the file has been modified from its original state, some details may not fully reflect the modified file.

**Horizontal resolution** 37.79 dpc

**Vertical resolution** 37.79 dpc

## Namespaces

- [File](#)
- [Discussion](#)

## Variants

## Views

- [Read](#)
- [View source](#)
- [View history](#)

## More

- This page was last edited on 30 October 2022, at 14:59.

- [Privacy policy](#)
- [About Win-Test Wiki](#)
- [Disclaimers](#)



# File:VOICESettingsmicroHAM.gif

From Win-Test Wiki

[Jump to navigation](#) [Jump to search](#)

- [File](#)
- [File history](#)
- [File usage](#)
- [Metadata](#)

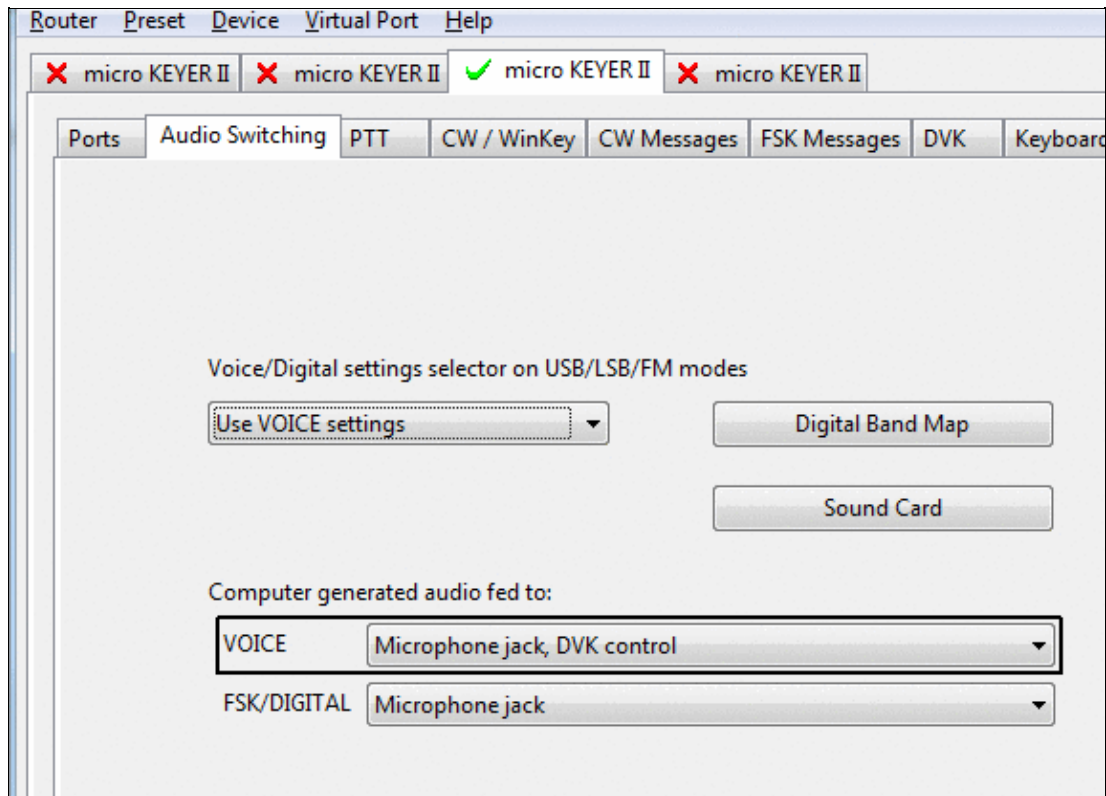



No higher resolution available.

[VOICESettingsmicroHAM.gif](#) (573 × 413 pixels, file size: 15 KB, MIME type: image/gif)

## File history

Click on a date/time to view the file as it appeared at that time.

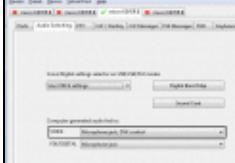
Date/Time	Thumbnail	Dimensions	User	Comment
current <u><a href="#">14:59, 30 October 2022</a></u>		573 × 413 (15 KB)	<u><a href="#">Dl6rai</a></u> ( <a href="#">talk</a>   <a href="#">contribs</a> )	

You cannot overwrite this file.

## File usage

The following page uses this file:

- [DVK CW RTTY Messaging](#)

## Metadata

This file contains additional information, probably added from the digital camera or scanner used to create or digitize it.

If the file has been modified from its original state, some details may not fully reflect the modified file.

**Horizontal resolution** 37.79 dpc

**Vertical resolution** 37.79 dpc

## Namespaces

- [File](#)
- [Discussion](#)

## Variants

## Views

- [Read](#)
- [View source](#)
- [View history](#)

## More

- This page was last edited on 30 October 2022, at 14:59.

## Win-Test Wiki

- [Privacy policy](#)
- [About Win-Test Wiki](#)
- [Disclaimers](#)



# File:WAEDCadditional-qtcinfo.gif

From Win-Test Wiki

[Jump to navigation](#) [Jump to search](#)

- [File](#)
- [File history](#)
- [File usage](#)

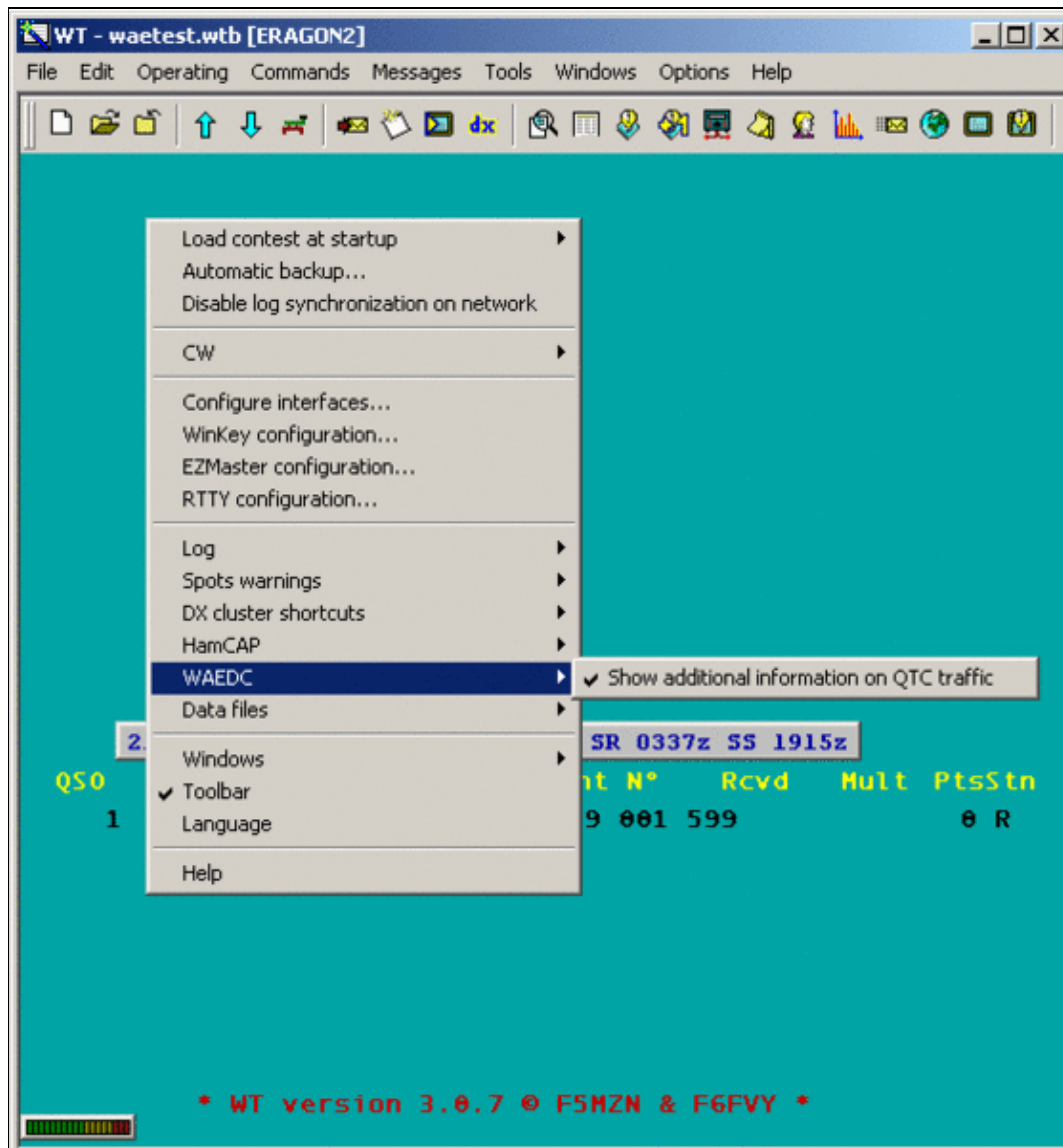

Size of this preview: [558 Å 600 pixels](#). Other resolutions: [223 Å 240 pixels](#) | [562 Å 604 pixels](#). [Original file](#) (562 Å 604 pixels, file size: 16 KB, MIME type: image/gif)

Check Iadditional QTC Info

## File history

Click on a date/time to view the file as it appeared at that time.

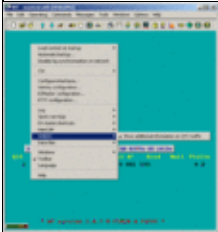
	Date/Time	Thumbnail	Dimensions	User	Comment
current	<a href="#">21:51, 23 July 2006</a>		562 Å 604 (16 KB)	<a href="#">Dl4ner</a> ( <a href="#">talk</a>   <a href="#">contribs</a> )	Check Iadditional QTC Info

You cannot overwrite this file.

## File usage

The following page uses this file:

- [WAEDC](#)

## Namespaces

- [File](#)
- [Discussion](#)

## Variants

## Views

- [Read](#)
- [View source](#)
- [View history](#)

## More

- This page was last edited on 23 July 2006, at 21:51.

- [Privacy policy](#)
- [About Win-Test Wiki](#)
- [Disclaimers](#)



# File:WAEDCadditional-qtcinfo.gif

From Win-Test Wiki

[Jump to navigation](#) [Jump to search](#)

- [File](#)
- [File history](#)
- [File usage](#)

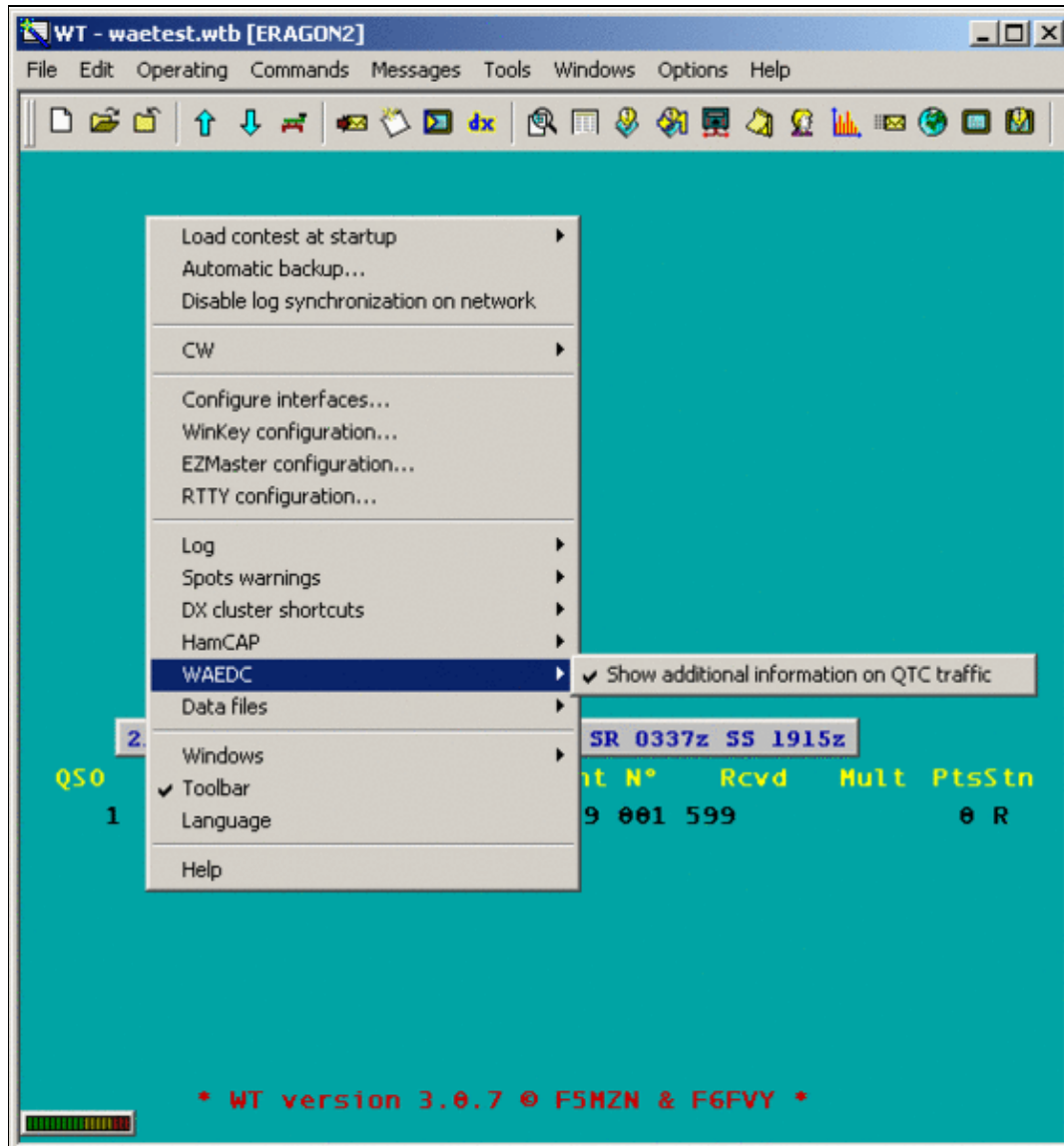

Size of this preview: [558 Å 600 pixels](#). Other resolutions: [223 Å 240 pixels](#) | [562 Å 604 pixels](#).  
[Original file](#) (562 Å 604 pixels, file size: 16 KB, MIME type: image/gif)

Check Iadditional QTC Info

## File history

Click on a date/time to view the file as it appeared at that time.

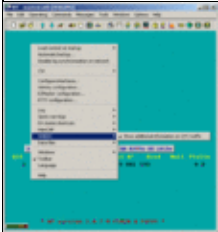
	Date/Time	Thumbnail	Dimensions	User	Comment
current	<a href="#">21:51, 23 July 2006</a>		562 Å 604 (16 KB)	<a href="#">Dl4ner</a> ( <a href="#">talk</a>   <a href="#">contribs</a> )	Check Iadditional QTC Info

You cannot overwrite this file.

## File usage

The following page uses this file:

- [WAEDC](#)

## Namespaces

- [File](#)
- [Discussion](#)

## Variants

## Views

- [Read](#)
- [View source](#)
- [View history](#)

## More

- This page was last edited on 23 July 2006, at 21:51.

- [Privacy policy](#)
- [About Win-Test Wiki](#)
- [Disclaimers](#)



# File:WAEDC-radiopotentialqtc.gif

From Win-Test Wiki

[Jump to navigation](#) [Jump to search](#)

- [File](#)
- [File history](#)
- [File usage](#)

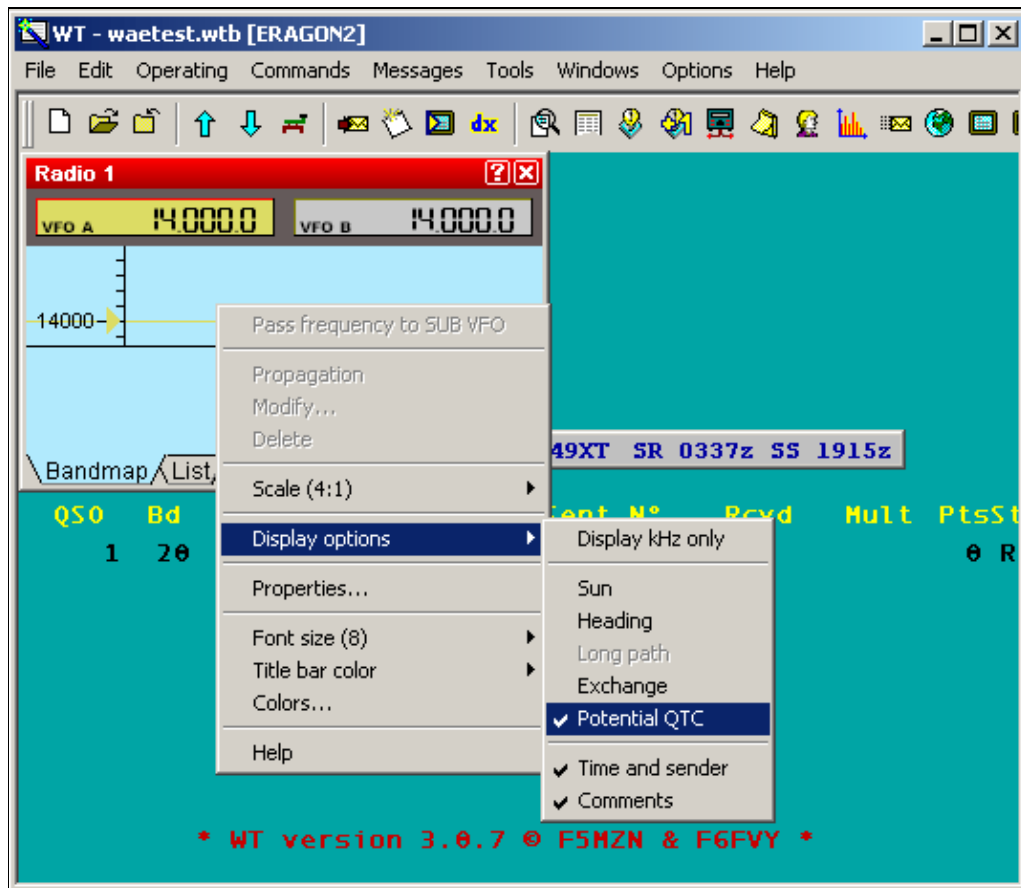

No higher resolution available.

[WAEDC-radiopotentialqtc.gif](#) (534 × 463 pixels, file size: 18 KB, MIME type: image/gif)

Info in Radio window potential QTCs

## File history

Click on a date/time to view the file as it appeared at that time.

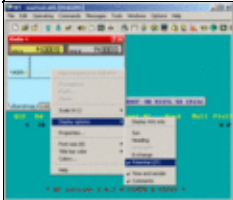
	Date/Time	Thumbnail	Dimensions	User	Comment
current	<a href="#">21:52, 23 July 2006</a>		534 × 463 (18 KB)	<a href="#">Dl4ner (talk   contribs)</a>	Info in Radio window potential QTCs

You cannot overwrite this file.

## File usage

The following page uses this file:

- [WAEDC](#)

## Namespaces

- [File](#)
- [Discussion](#)

## Variants

## Views

- [Read](#)
- [View source](#)
- [View history](#)

## More

- This page was last edited on 23 July 2006, at 21:52.

- [Privacy policy](#)
- [About Win-Test Wiki](#)
- [Disclaimers](#)





# File:WAEDC-radiopotentialqtc.gif

From Win-Test Wiki

[Jump to navigation](#) [Jump to search](#)

- [File](#)
- [File history](#)
- [File usage](#)

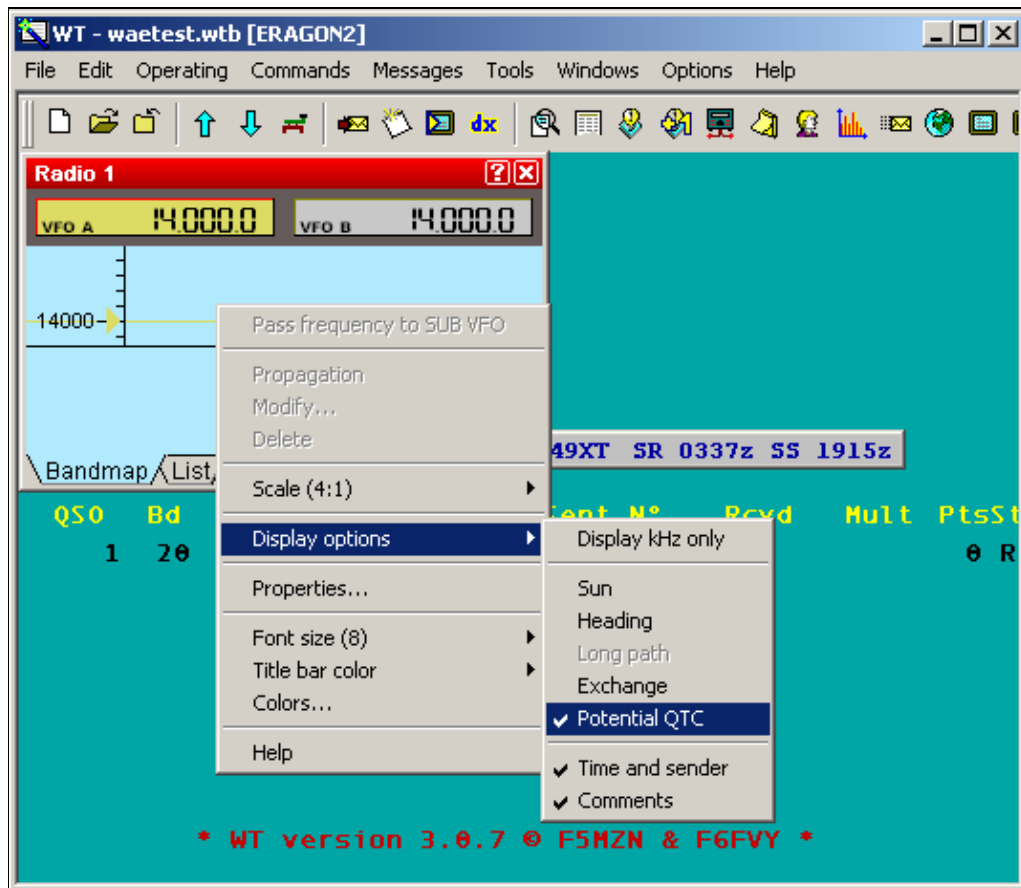

No higher resolution available.

[WAEDC-radiopotentialqtc.gif](#) (534 × 463 pixels, file size: 18 KB, MIME type: image/gif)

Info in Radio window potential QTCs

## File history

Click on a date/time to view the file as it appeared at that time.

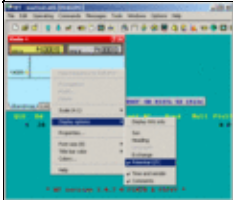
	Date/Time	Thumbnail	Dimensions	User	Comment
current	<a href="#">21:52, 23 July 2006</a>		534 × 463 (18 KB)	<a href="#">Dl4ner (talk   contribs)</a>	Info in Radio window potential QTCs

You cannot overwrite this file.

## File usage

The following page uses this file:

- [WAEDC](#)

## Namespaces

- [File](#)
- [Discussion](#)

## Variants

## Views

- [Read](#)
- [View source](#)
- [View history](#)

## More

- This page was last edited on 23 July 2006, at 21:52.

- [Privacy policy](#)
- [About Win-Test Wiki](#)
- [Disclaimers](#)

- 

# File:WaeMessagesRx.gif

From Win-Test Wiki

[Jump to navigation](#) [Jump to search](#)

- [File](#)
- [File history](#)
- [File usage](#)

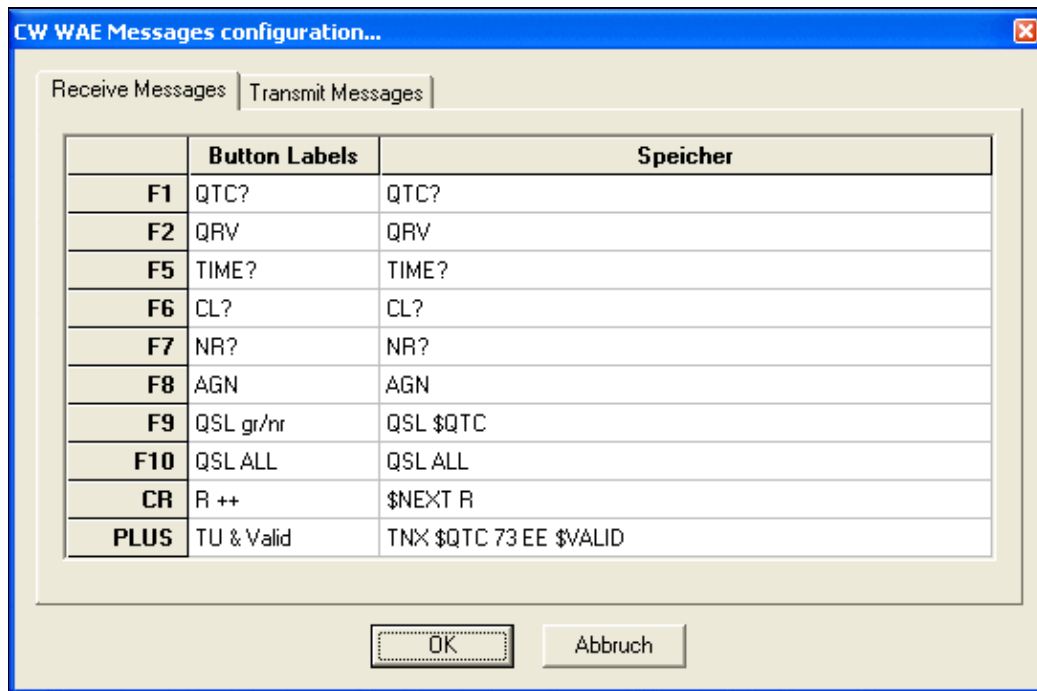

No higher resolution available.

[WaeMessagesRx.gif](#) (543 × 359 pixels, file size: 12 KB, MIME type: image/gif)

## File history

Click on a date/time to view the file as it appeared at that time.

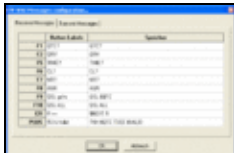
Date/Time	Thumbnail	Dimensions	User	Comment
current <a href="#">08:04, 14 August 2007</a>		543 × 359 (12 KB)	<a href="#">Dl6rai</a> ( <a href="#">talk</a>   <a href="#">contribs</a> )	

You cannot overwrite this file.

## File usage

The following page uses this file:

- [Menu:Options](#)

## Namespaces

- [File](#)
- [Discussion](#)

## Variants

## Views

- [Read](#)
- [View source](#)
- [View history](#)

## More

- This page was last edited on 14 August 2007, at 08:04.

- [Privacy policy](#)
- [About Win-Test Wiki](#)
- [Disclaimers](#)



# File:WaeMessagesRx.gif

From Win-Test Wiki

[Jump to navigation](#) [Jump to search](#)

- [File](#)
- [File history](#)
- [File usage](#)

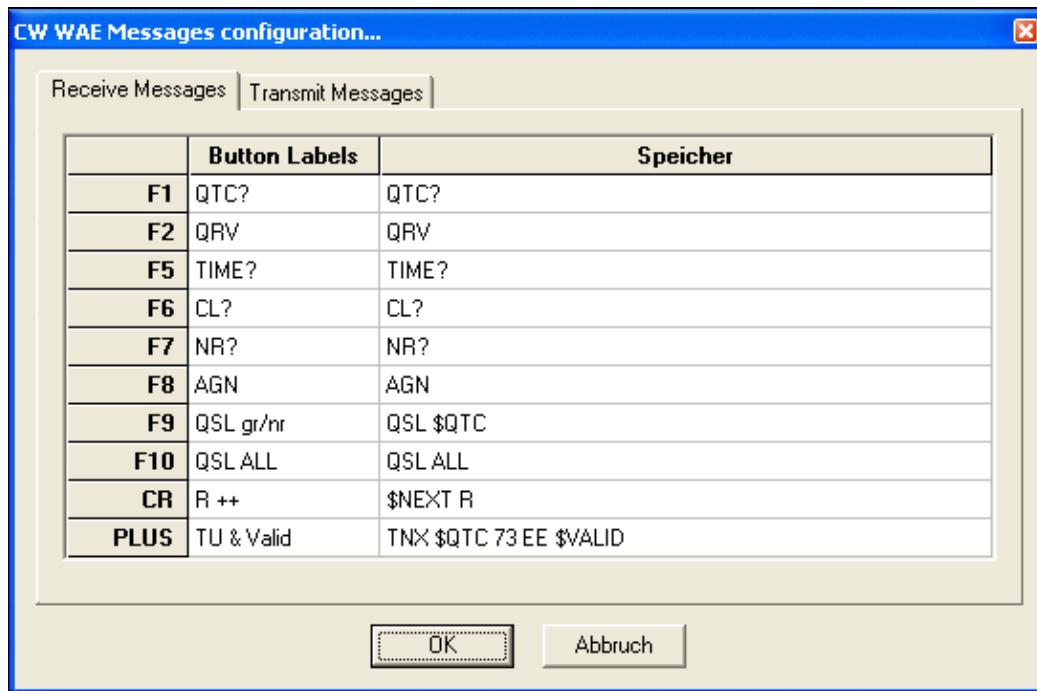

No higher resolution available.

[WaeMessagesRx.gif](#) (543 × 359 pixels, file size: 12 KB, MIME type: image/gif)

## File history

Click on a date/time to view the file as it appeared at that time.

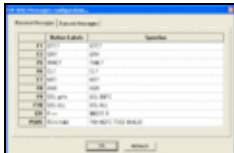
Date/Time	Thumbnail	Dimensions	User	Comment
current <a href="#">08:04, 14 August 2007</a>		543 × 359 (12 KB)	<a href="#">Dl6rai</a> ( <a href="#">talk</a>   <a href="#">contribs</a> )	

You cannot overwrite this file.

## File usage

The following page uses this file:

- [Menu:Options](#)

## Namespaces

- [File](#)
- [Discussion](#)

## Variants

## Views

- [Read](#)
- [View source](#)
- [View history](#)

## More

- This page was last edited on 14 August 2007, at 08:04.

- [Privacy policy](#)
- [About Win-Test Wiki](#)
- [Disclaimers](#)



# File:WaeMessagesTx.gif

From Win-Test Wiki

[Jump to navigation](#) [Jump to search](#)

- [File](#)
- [File history](#)
- [File usage](#)

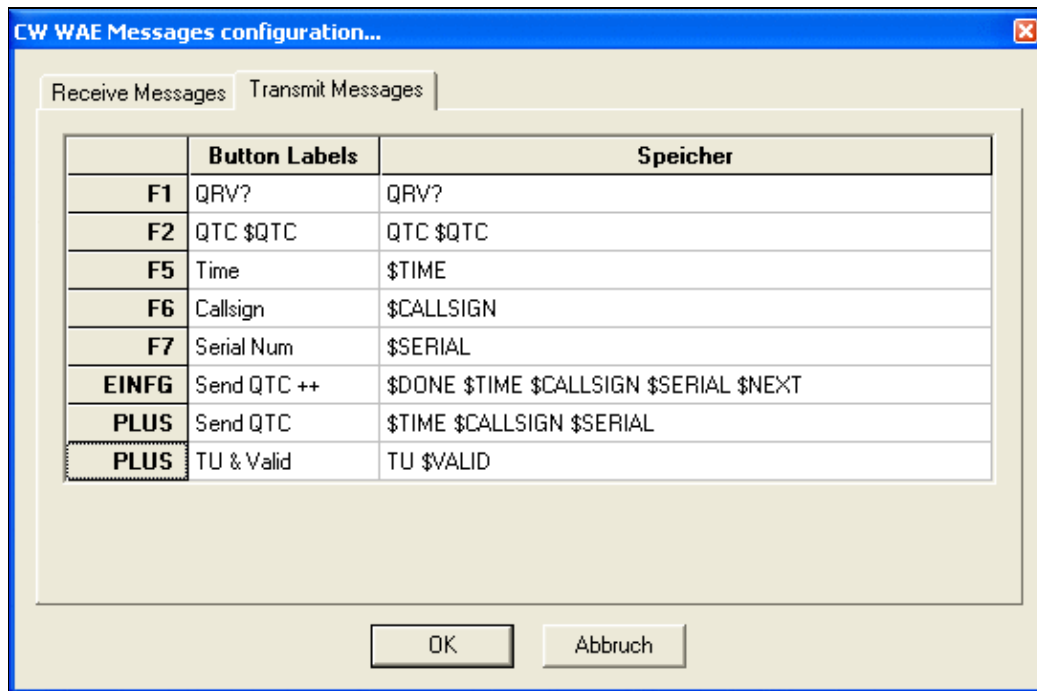

No higher resolution available.

[WaeMessagesTx.gif](#) (543 × 359 pixels, file size: 13 KB, MIME type: image/gif)

## File history

Click on a date/time to view the file as it appeared at that time.

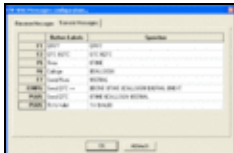
Date/Time	Thumbnail	Dimensions	User	Comment
current <a href="#">08:05, 14 August 2007</a>		543 × 359 (13 KB)	<a href="#">Dl6rai</a> ( <a href="#">talk</a>   <a href="#">contribs</a> )	

You cannot overwrite this file.

## File usage

The following page uses this file:

- [Menu:Options](#)

## Namespaces

- [File](#)
- [Discussion](#)

## Variants

## Views

- [Read](#)
- [View source](#)
- [View history](#)

## More

- This page was last edited on 14 August 2007, at 08:05.

- [Privacy policy](#)
- [About Win-Test Wiki](#)
- [Disclaimers](#)





# File:WaeMessagesTx.gif

From Win-Test Wiki

[Jump to navigation](#) [Jump to search](#)

- [File](#)
- [File history](#)
- [File usage](#)

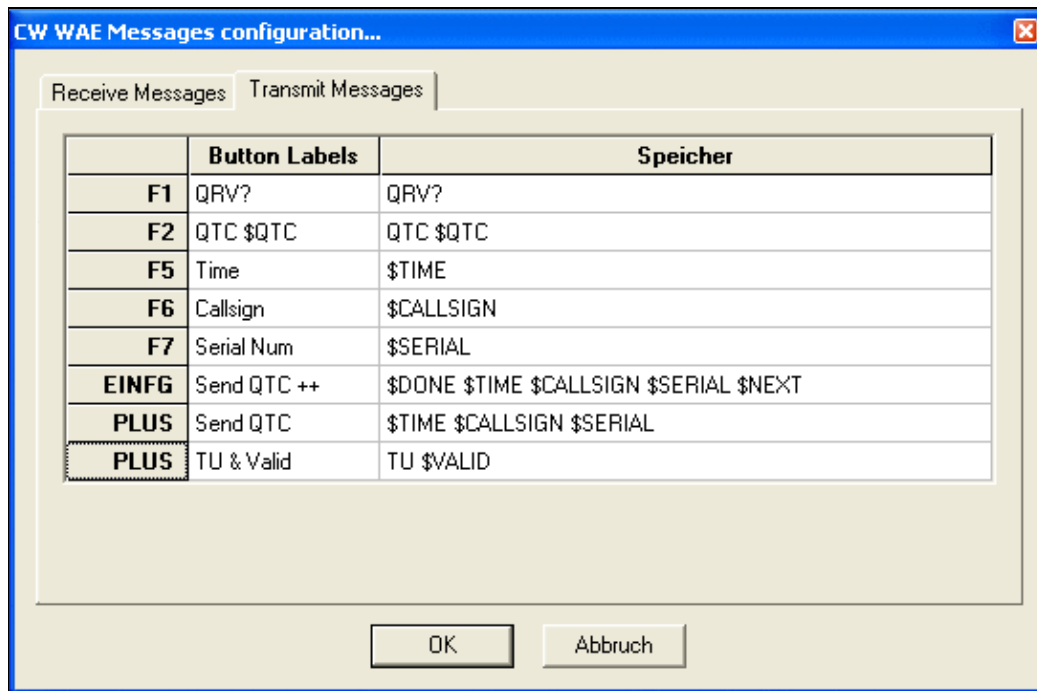

No higher resolution available.

[WaeMessagesTx.gif](#) (543 × 359 pixels, file size: 13 KB, MIME type: image/gif)

## File history

Click on a date/time to view the file as it appeared at that time.

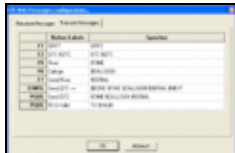
Date/Time	Thumbnail	Dimensions	User	Comment
current <a href="#">08:05, 14 August 2007</a>		543 × 359 (13 KB)	<a href="#">Dl6rai</a> ( <a href="#">talk</a>   <a href="#">contribs</a> )	

You cannot overwrite this file.

## File usage

The following page uses this file:

- [Menu:Options](#)

## Namespaces

- [File](#)
- [Discussion](#)

## Variants

## Views

- [Read](#)
- [View source](#)
- [View history](#)

## More

- This page was last edited on 14 August 2007, at 08:05.

- [Privacy policy](#)
- [About Win-Test Wiki](#)
- [Disclaimers](#)



# File:WindowsBandMapContextMenu.PNG

From Win-Test Wiki

[Jump to navigation](#) [Jump to search](#)

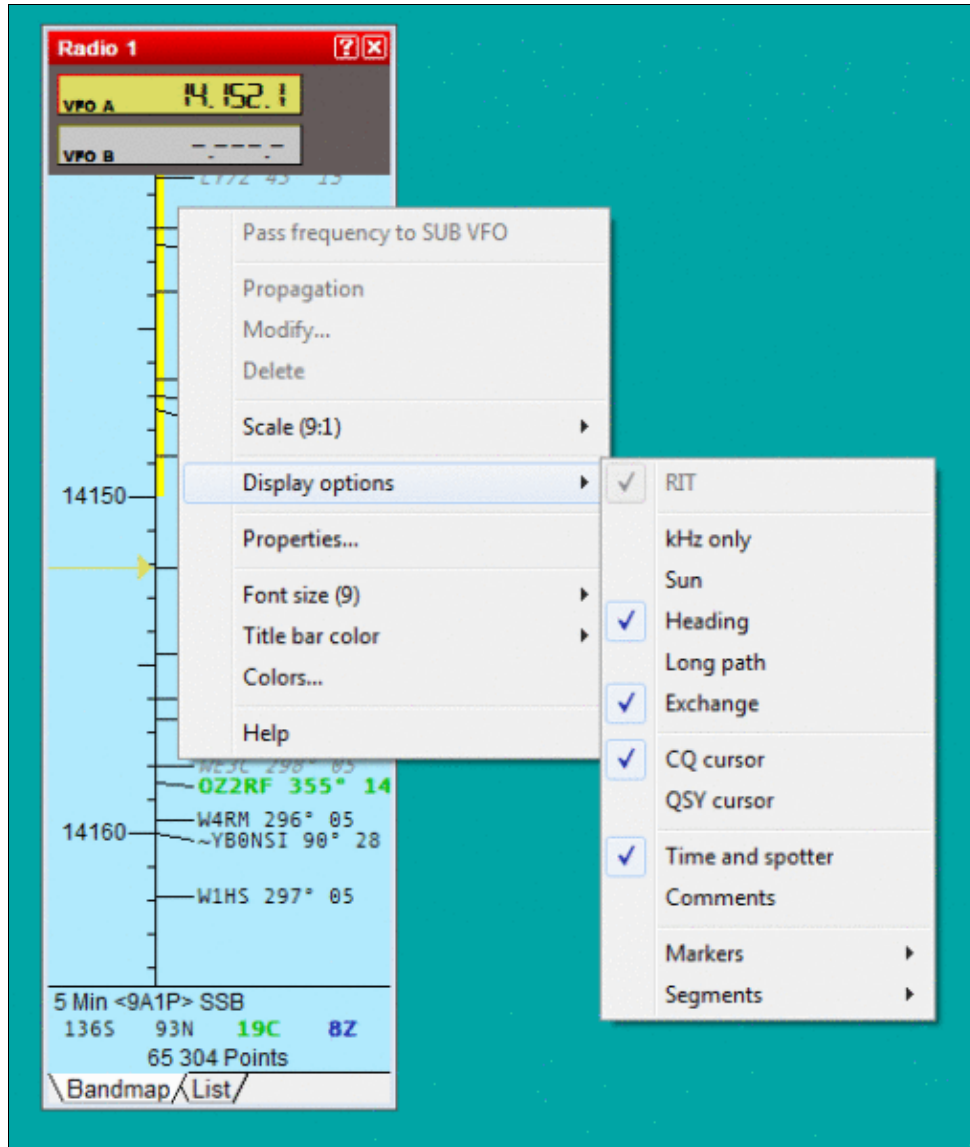

- [File](#)
- [File history](#)
- [File usage](#)
- [Metadata](#)



Size of this preview: 507 × 599 pixels. Other resolutions: 203 × 240 pixels | 519 × 613 pixels.  
Original file (519 × 613 pixels, file size: 22 KB, MIME type: image.gif)

## File history

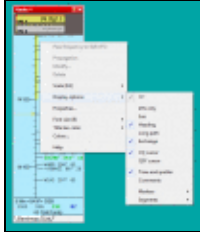
Click on a date/time to view the file as it appeared at that time.

	Date/Time	Thumbnail	Dimensions	User	Comment
current	<u>16:01, 30 October 2016</u>		519 × 613 (22 KB)	<a href="#">D16rai</a> ( <a href="#">talk</a>   <a href="#">contribs</a> )	
	<u>08:31, 21 January 2007</u>		490 × 577 (18 KB)	<a href="#">D16rai</a> ( <a href="#">talk</a>   <a href="#">contribs</a> )	

You cannot overwrite this file.

## File usage

The following page uses this file:

- [Menu:Windows](#)

## Metadata

This file contains additional information, probably added from the digital camera or scanner used to create or digitize it.

If the file has been modified from its original state, some details may not fully reflect the modified file.

**Horizontal resolution** 37.79 dpc

**Vertical resolution** 37.79 dpc

## Namespaces

- [File](#)
- [Discussion](#)

## Variants

## Views

- [Read](#)
- [View source](#)
- [View history](#)

## More

- This page was last edited on 30 October 2016, at 16:01.

- [Privacy policy](#)
- [About Win-Test Wiki](#)
- [Disclaimers](#)



# File:WindowsBandMapContextMenu.PNG

From Win-Test Wiki

[Jump to navigation](#) [Jump to search](#)

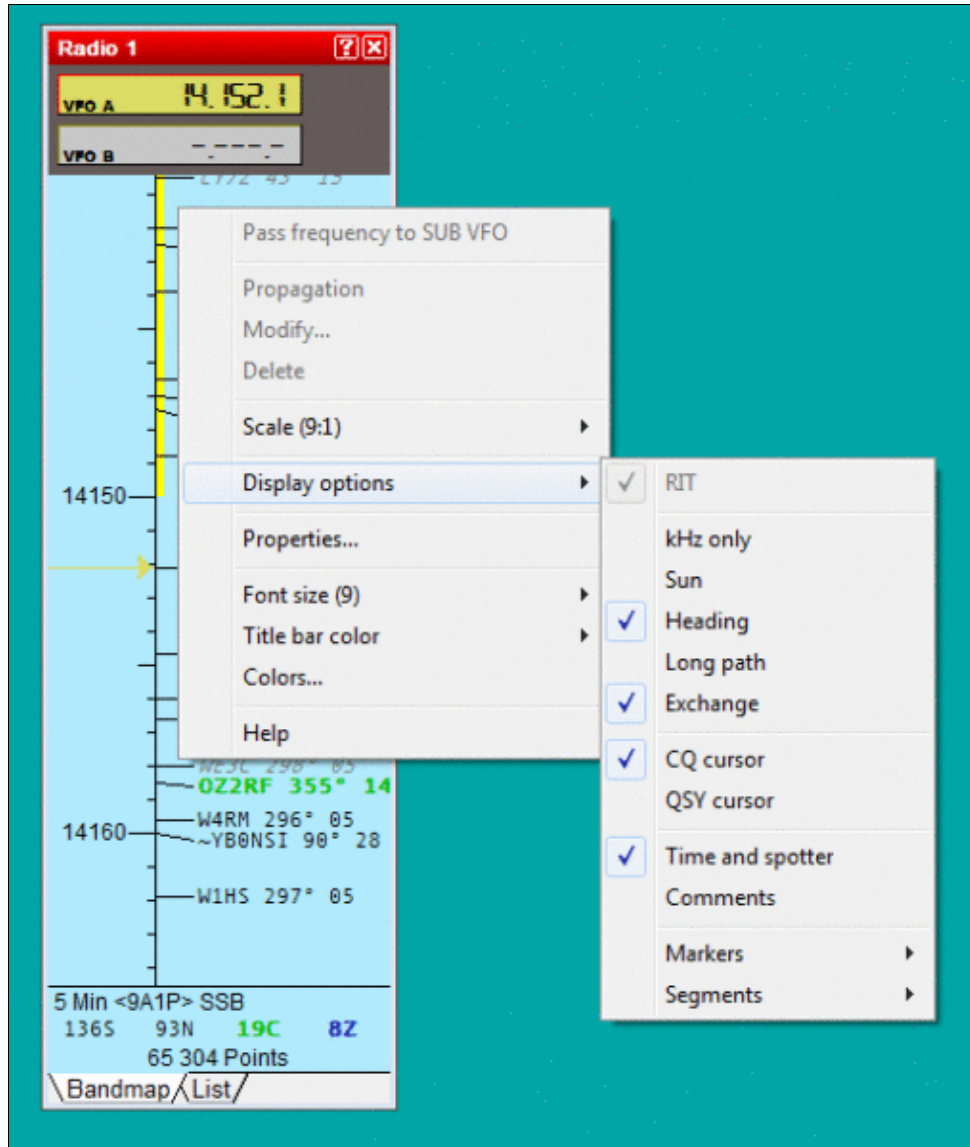

- [File](#)
- [File history](#)
- [File usage](#)
- [Metadata](#)



Size of this preview: 507 × 599 pixels. Other resolutions: 203 × 240 pixels | 519 × 613 pixels.  
Original file (519 × 613 pixels, file size: 22 KB, MIME type: image.gif)

## File history

Click on a date/time to view the file as it appeared at that time.

	Date/Time	Thumbnail	Dimensions	User	Comment
current	<u>16:01, 30 October 2016</u>		519 × 613 (22 KB)	<a href="#">Dl6rai</a> ( <a href="#">talk</a>   <a href="#">contribs</a> )	
	<u>08:31, 21 January 2007</u>		490 × 577 (18 KB)	<a href="#">Dl6rai</a> ( <a href="#">talk</a>   <a href="#">contribs</a> )	

You cannot overwrite this file.

## File usage

The following page uses this file:

- [Menu:Windows](#)

## Metadata

This file contains additional information, probably added from the digital camera or scanner used to create or digitize it.

If the file has been modified from its original state, some details may not fully reflect the modified file.

**Horizontal resolution** 37.79 dpc

**Vertical resolution** 37.79 dpc

## Namespaces

- [File](#)
- [Discussion](#)

## Variants

## Views

- [Read](#)
- [View source](#)
- [View history](#)

## More

- This page was last edited on 30 October 2016, at 16:01.

- [Privacy policy](#)
- [About Win-Test Wiki](#)
- [Disclaimers](#)





# File:WindowsBandMapCqCursor.gif

From Win-Test Wiki

[Jump to navigation](#) [Jump to search](#)

- [File](#)
- [File history](#)
- [File usage](#)

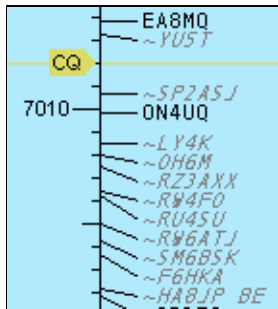

No higher resolution available.

[WindowsBandMapCqCursor.gif](#) (143 × 158 pixels, file size: 3 KB, MIME type: image/gif)

## File history

Click on a date/time to view the file as it appeared at that time.

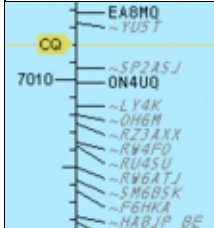
Date/Time	Thumbnail	Dimensions	User	Comment
current <a href="#">08:23, 21 January 2007</a>		143 × 158 (3 KB)	<a href="#">Dl6rai</a> ( <a href="#">talk</a>   <a href="#">contribs</a> )	

You cannot overwrite this file.

## File usage

The following page uses this file:

- [Menu:Windows](#)

## Namespaces

- [File](#)
- [Discussion](#)

## Variants

## Views

- [Read](#)
- [View source](#)
- [View history](#)

## More

- This page was last edited on 21 January 2007, at 08:23.

- [Privacy policy](#)
- [About Win-Test Wiki](#)
- [Disclaimers](#)



# File:WindowsBandMapCqCursor.gif

From Win-Test Wiki

[Jump to navigation](#) [Jump to search](#)

- [File](#)
- [File history](#)
- [File usage](#)

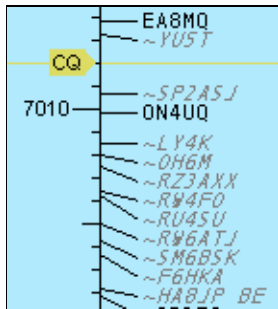

No higher resolution available.

[WindowsBandMapCqCursor.gif](#) (143 × 158 pixels, file size: 3 KB, MIME type: image/gif)

## File history

Click on a date/time to view the file as it appeared at that time.

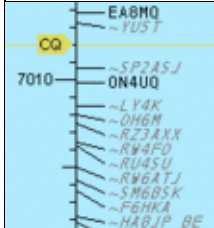
Date/Time	Thumbnail	Dimensions	User	Comment
current <a href="#">08:23, 21 January 2007</a>		143 × 158 (3 KB)	<a href="#">Dl6rai</a> ( <a href="#">talk</a>   <a href="#">contribs</a> )	

You cannot overwrite this file.

## File usage

The following page uses this file:

- [Menu:Windows](#)

## Namespaces

- [File](#)
- [Discussion](#)

## Variants

## Views

- [Read](#)
- [View source](#)
- [View history](#)

## More

- This page was last edited on 21 January 2007, at 08:23.

- [Privacy policy](#)
- [About Win-Test Wiki](#)
- [Disclaimers](#)



# File:WindowsBandMapListViewContextMenuDisplay.gif

From Win-Test Wiki

[Jump to navigation](#) [Jump to search](#)

- [File](#)
- [File history](#)
- [File usage](#)
- [Metadata](#)

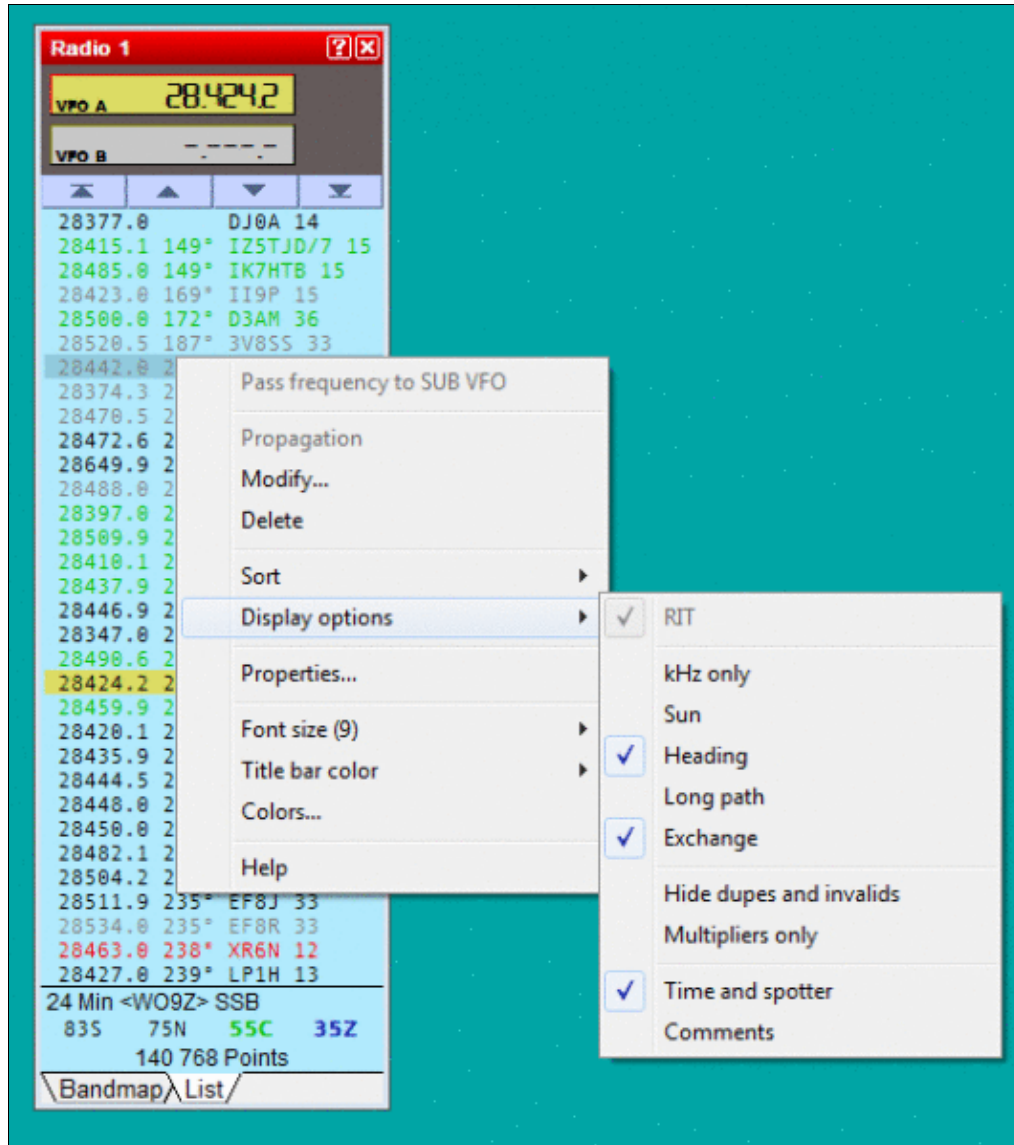



Size of this preview: 531 Å 599 pixels. Other resolutions: 213 Å 240 pixels | 543 Å 613 pixels. Original file (543 Å 613 pixels, file size: 29 KB, MIME type: image.gif)

Band Map List View Context Menu Display Options

## File history

Click on a date/time to view the file as it appeared at that time.

	Date/Time	Thumbnail	Dimensions	User	Comment
current	<u>16:02, 30 October 2016</u>		543 Å 613 (29 KB)	<u>DI6rai</u> ( <a href="#">talk</a>   <a href="#">contribs</a> )	
	<u>21:32, 18 November 2007</u>		461 Å 474 (25 KB)	<u>N6TV</u> ( <a href="#">talk</a>   <a href="#">contribs</a> )	Band Map List View Context Menu Display Options

You cannot overwrite this file.

## File usage

The following page uses this file:

- [Menu:Windows](#)

## Metadata

This file contains additional information, probably added from the digital camera or scanner used to create or digitize it.

If the file has been modified from its original state, some details may not fully reflect the modified file.

**Horizontal resolution** 37.79 dpc

**Vertical resolution** 37.79 dpc

## Namespaces

- [File](#)
- [Discussion](#)

## Variants

## Views

- [Read](#)
- [View source](#)
- [View history](#)

## More

- This page was last edited on 30 October 2016, at 16:02.

- [Privacy policy](#)
- [About Win-Test Wiki](#)
- [Disclaimers](#)



# File:WindowsBandMapListViewContextMenuDisplay.gif

From Win-Test Wiki

[Jump to navigation](#) [Jump to search](#)

- [File](#)
- [File history](#)
- [File usage](#)
- [Metadata](#)

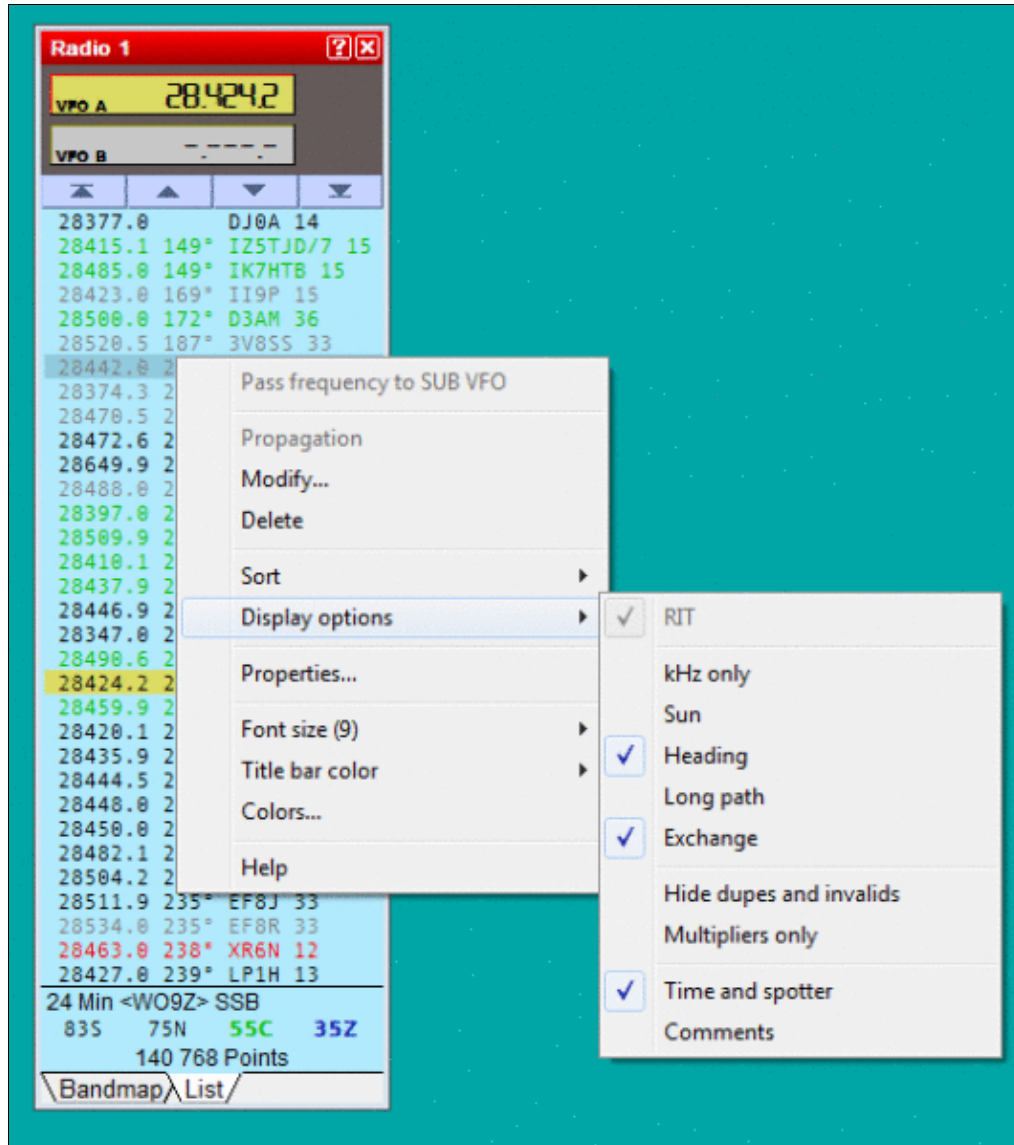





Size of this preview: 531 Å 599 pixels. Other resolutions: 213 Å 240 pixels | 543 Å 613 pixels.  
Original file (543 Å 613 pixels, file size: 29 KB, MIME type: image.gif)

Band Map List View Context Menu Display Options

## File history

Click on a date/time to view the file as it appeared at that time.

	Date/Time	Thumbnail	Dimensions	User	Comment
current	<u>16:02, 30 October 2016</u>		543 Å 613 (29 KB)	<u>DI6rai</u> ( <a href="#">talk</a>   <a href="#">contribs</a> )	
	<u>21:32, 18 November 2007</u>		461 Å 474 (25 KB)	<u>N6TV</u> ( <a href="#">talk</a>   <a href="#">contribs</a> )	Band Map List View Context Menu Display Options

You cannot overwrite this file.

## File usage

The following page uses this file:

- [Menu:Windows](#)

## Metadata

This file contains additional information, probably added from the digital camera or scanner used to create or digitize it.

If the file has been modified from its original state, some details may not fully reflect the modified file.

**Horizontal resolution** 37.79 dpc

**Vertical resolution** 37.79 dpc

## Namespaces

- [File](#)
- [Discussion](#)

## Variants

## Views

- [Read](#)
- [View source](#)
- [View history](#)

## More

- This page was last edited on 30 October 2016, at 16:02.

- [Privacy policy](#)
- [About Win-Test Wiki](#)
- [Disclaimers](#)



# File:WindowsBandMapListViewContextMenuSort.gif

From Win-Test Wiki

[Jump to navigation](#) [Jump to search](#)

- [File](#)
- [File history](#)
- [File usage](#)
- [Metadata](#)

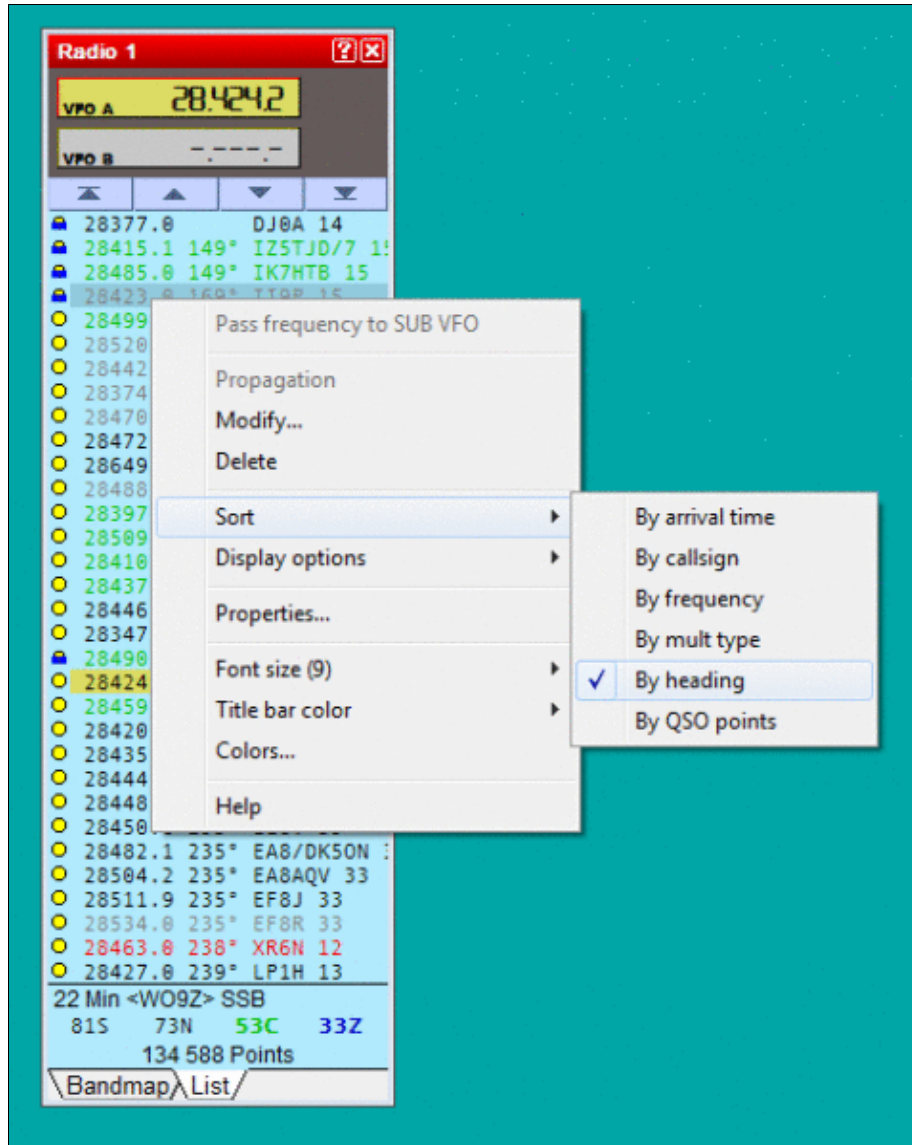

Size of this preview: 479 Å 599 pixels. Other resolutions: 192 Å 240 pixels | 493 Å 617 pixels. Original file (493 Å 617 pixels, file size: 26 KB, MIME type: image.gif)

Band Map List View Context Menu, Sort options.

## File history

Click on a date/time to view the file as it appeared at that time.

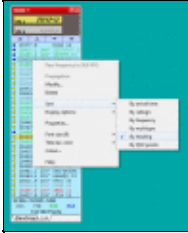
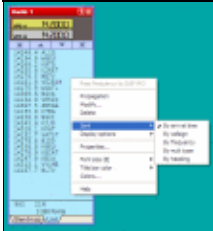
	Date/Time	Thumbnail	Dimensions	User	Comment
current	<u>16:01, 30 October 2016</u>		493 Å 617 (26 KB)	<u>Dl6rai</u> ( <a href="#">talk</a>   <a href="#">contribs</a> )	
	<u>21:31, 18 November 2007</u>		426 Å 469 (24 KB)	<u>N6TV</u> ( <a href="#">talk</a>   <a href="#">contribs</a> )	Band Map List View Context Menu, Sort options.

You cannot overwrite this file.

## File usage

The following page uses this file:

- [Menu:Windows](#)

## Metadata

This file contains additional information, probably added from the digital camera or scanner used to create or digitize it.

If the file has been modified from its original state, some details may not fully reflect the modified file.

**Horizontal resolution** 37.79 dpc

**Vertical resolution** 37.79 dpc

## Namespaces

- [File](#)
- [Discussion](#)

## Variants

## Views

- [Read](#)
- [View source](#)
- [View history](#)

## More

- This page was last edited on 30 October 2016, at 16:01.

- [Privacy policy](#)
- [About Win-Test Wiki](#)
- [Disclaimers](#)



# File:WindowsBandMapListViewContextMenuSort.gif

From Win-Test Wiki

[Jump to navigation](#) [Jump to search](#)

- [File](#)
- [File history](#)
- [File usage](#)
- [Metadata](#)

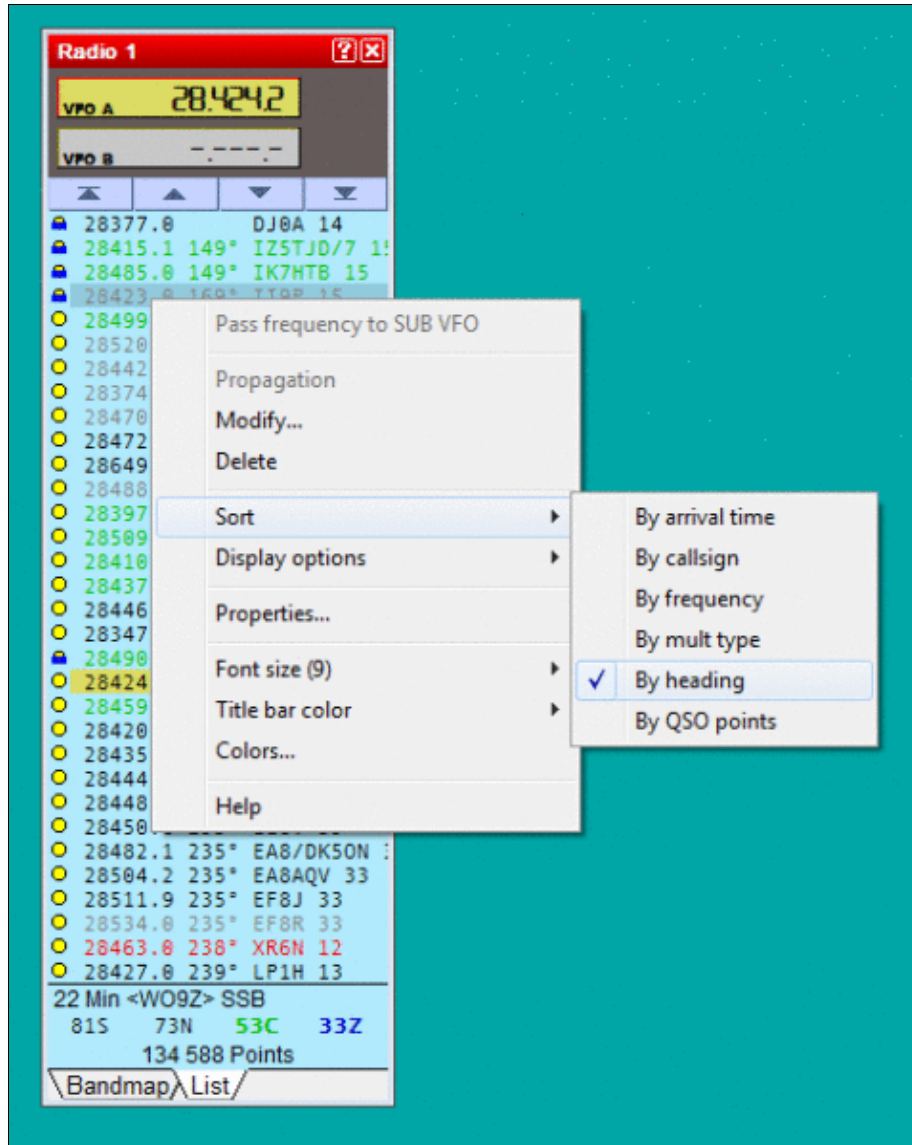

Size of this preview: 479 Å 599 pixels. Other resolutions: 192 Å 240 pixels | 493 Å 617 pixels. Original file (493 Å 617 pixels, file size: 26 KB, MIME type: image.gif)

Band Map List View Context Menu, Sort options.

## File history

Click on a date/time to view the file as it appeared at that time.

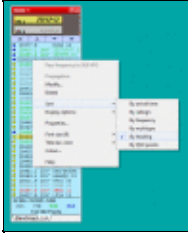
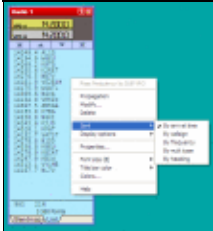
	Date/Time	Thumbnail	Dimensions	User	Comment
current	<u>16:01, 30 October 2016</u>		493 Å 617 (26 KB)	<u>Dl6rai (talk   contribs)</u>	
	<u>21:31, 18 November 2007</u>		426 Å 469 (24 KB)	<u>N6TV (talk   contribs)</u>	Band Map List View Context Menu, Sort options.

You cannot overwrite this file.

## File usage

The following page uses this file:

- Menu:Windows

## Metadata

This file contains additional information, probably added from the digital camera or scanner used to create or digitize it.

If the file has been modified from its original state, some details may not fully reflect the modified file.

**Horizontal resolution** 37.79 dpc

**Vertical resolution** 37.79 dpc

## Namespaces

- File
- Discussion

## Variants

## Views

- [Read](#)
- [View source](#)
- [View history](#)

## More

- This page was last edited on 30 October 2016, at 16:01.

- [Privacy policy](#)
- [About Win-Test Wiki](#)
- [Disclaimers](#)





# File:WindowsBandmapMarker.gif

From Win-Test Wiki

[Jump to navigation](#) [Jump to search](#)

- [File](#)
- [File history](#)
- [File usage](#)

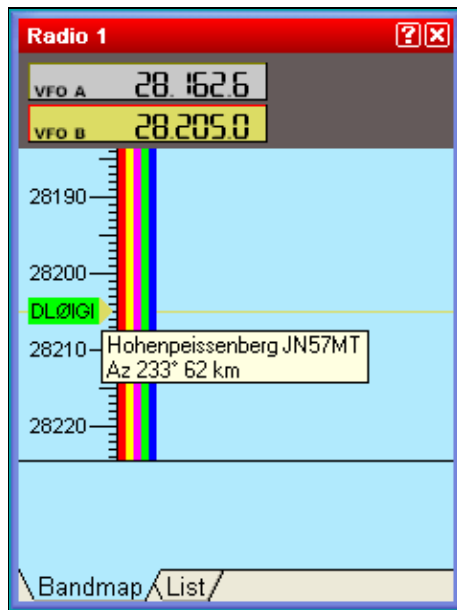

No higher resolution available.

[WindowsBandmapMarker.gif](#) (237 Å 315 pixels, file size: 6 KB, MIME type: image.gif)

## File history

Click on a date/time to view the file as it appeared at that time.

	Date/Time	Thumbnail	Dimensions	User	Comment
current	<a href="#">05:21, 20 May 2007</a>		237 Å 315 (6 KB)	<a href="#">Dl6rai</a> ( <a href="#">talk</a>   <a href="#">contribs</a> )	
	<a href="#">10:42, 25 March 2007</a>		236 Å 321 (5 KB)	<a href="#">Dl6rai</a> ( <a href="#">talk</a>   <a href="#">contribs</a> )	

Date/Time	Thumbnail	Dimensions	User	Comment
You cannot overwrite this file.				

## File usage

The following page uses this file:

- [Menu:Windows](#)

## Namespaces

- [File](#)
- [Discussion](#)

## Variants

## Views

- [Read](#)
- [View source](#)
- [View history](#)

## More

- This page was last edited on 25 March 2007, at 10:42.

- [Privacy policy](#)
- [About Win-Test Wiki](#)
- [Disclaimers](#)



# File:WindowsBandmapMarker.gif

From Win-Test Wiki

[Jump to navigation](#) [Jump to search](#)

- [File](#)
- [File history](#)
- [File usage](#)

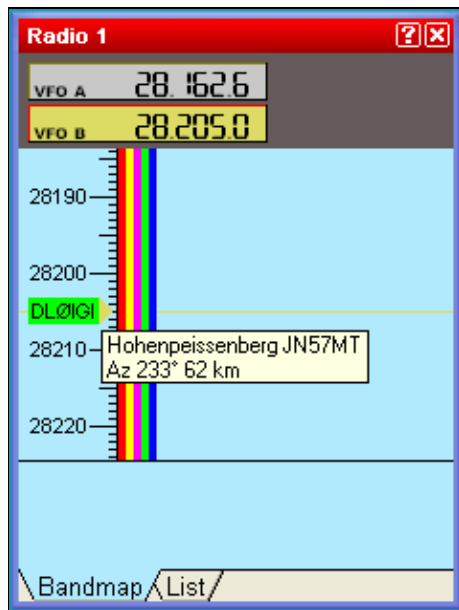

No higher resolution available.

[WindowsBandmapMarker.gif](#) (237 Å 315 pixels, file size: 6 KB, MIME type: image.gif)

## File history

Click on a date/time to view the file as it appeared at that time.

	Date/Time	Thumbnail	Dimensions	User	Comment
current	<a href="#">05:21, 20 May 2007</a>		237 Å 315 (6 KB)	<a href="#">Dl6rai</a> ( <a href="#">talk</a>   <a href="#">contribs</a> )	
	<a href="#">10:42, 25 March 2007</a>		236 Å 321 (5 KB)	<a href="#">Dl6rai</a> ( <a href="#">talk</a>   <a href="#">contribs</a> )	

Date/Time	Thumbnail	Dimensions	User	Comment
You cannot overwrite this file.				

## File usage

The following page uses this file:

- [Menu:Windows](#)

## Namespaces

- [File](#)
- [Discussion](#)

## Variants

## Views

- [Read](#)
- [View source](#)
- [View history](#)

## More

- This page was last edited on 25 March 2007, at 10:42.

- [Privacy policy](#)
- [About Win-Test Wiki](#)
- [Disclaimers](#)

- 

# File:WindowsBandmapSegments.gif

From Win-Test Wiki

[Jump to navigation](#) [Jump to search](#)

- [File](#)
- [File history](#)
- [File usage](#)

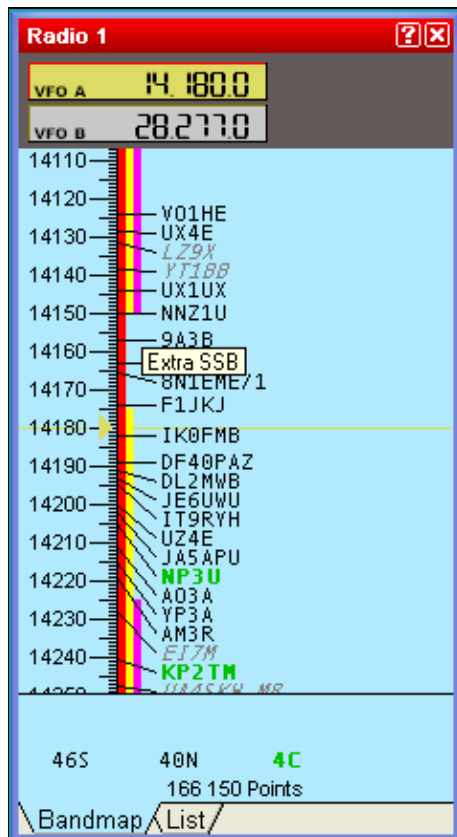

No higher resolution available.

[WindowsBandmapSegments.gif](#) (237 × 436 pixels, file size: 11 KB, MIME type: image.gif)

## File history

Click on a date/time to view the file as it appeared at that time.

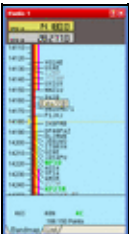
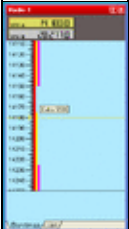
Date/Time	Thumbnail	Dimensions	User	Comment
current <a href="#">11:13, 25 March 2007</a>		237 × 436 (11 KB)	<a href="#">Dl6rai</a> ( <a href="#">talk</a>   <a href="#">contribs</a> )	
<a href="#">11:08, 25 March 2007</a>		238 × 438 (7 KB)	<a href="#">Dl6rai</a> ( <a href="#">talk</a>   <a href="#">contribs</a> )	

You cannot overwrite this file.

## File usage

The following page uses this file:

- [Menu:Windows](#)

## Namespaces

- [File](#)
- [Discussion](#)

## Variants

## Views

- [Read](#)
- [View source](#)
- [View history](#)

## More

- This page was last edited on 25 March 2007, at 11:08.
- [Privacy policy](#)
- [About Win-Test Wiki](#)

- Disclaimers



# File:WindowsBandmapSegments.gif

From Win-Test Wiki

[Jump to navigation](#) [Jump to search](#)

- [File](#)
- [File history](#)
- [File usage](#)

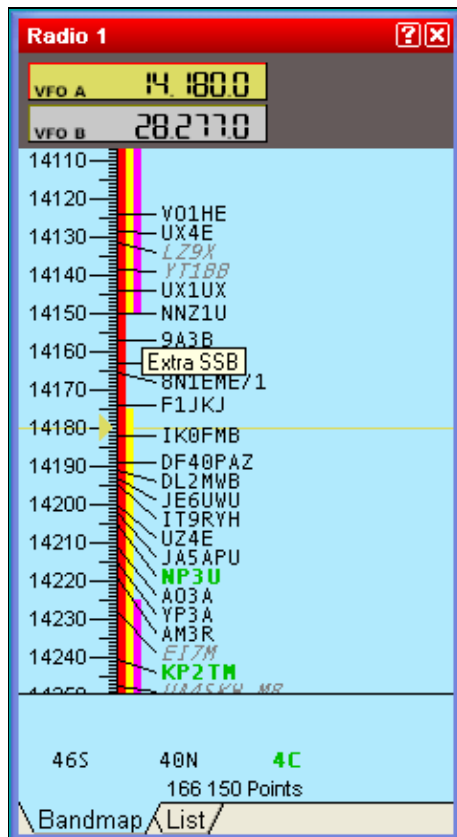



No higher resolution available.

[WindowsBandmapSegments.gif](#) (237 × 436 pixels, file size: 11 KB, MIME type: image.gif)

## File history

Click on a date/time to view the file as it appeared at that time.

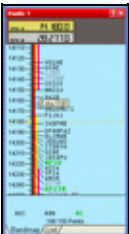
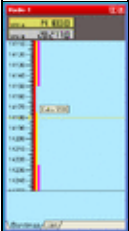
	Date/Time	Thumbnail	Dimensions	User	Comment
current	<a href="#">11:13, 25 March 2007</a>		237 × 436 (11 KB)	<a href="#">Dl6rai</a> ( <a href="#">talk</a>   <a href="#">contribs</a> )	
	<a href="#">11:08, 25 March 2007</a>		238 × 438 (7 KB)	<a href="#">Dl6rai</a> ( <a href="#">talk</a>   <a href="#">contribs</a> )	

You cannot overwrite this file.

## File usage

The following page uses this file:

- [Menu:Windows](#)

## Namespaces

- [File](#)
- [Discussion](#)

## Variants

## Views

- [Read](#)
- [View source](#)
- [View history](#)

## More

- This page was last edited on 25 March 2007, at 11:08.
- [Privacy policy](#)
- [About Win-Test Wiki](#)

- Disclaimers



# File:WindowsCheckCallsign.gif

From Win-Test Wiki

[Jump to navigation](#) [Jump to search](#)

- [File](#)
- [File history](#)
- [File usage](#)

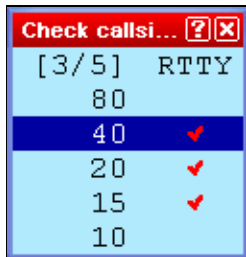

No higher resolution available.

[WindowsCheckCallsign.gif](#) (126 × 132 pixels, file size: 2 KB, MIME type: image/gif)

## File history

Click on a date/time to view the file as it appeared at that time.

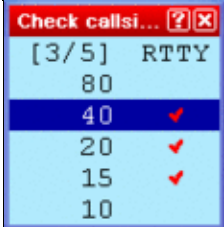
	Date/Time	Thumbnail	Dimensions	User	Comment
current	<a href="#">09:18, 7 October 2006</a>		126 × 132 (2 KB)	<a href="#">Dl6rai</a> ( <a href="#">talk</a>   <a href="#">contribs</a> )	

You cannot overwrite this file.

## File usage

The following page uses this file:

- [Menu:Windows](#)

## Namespaces

- [File](#)
- [Discussion](#)

## Variants

## Views

- [Read](#)
- [View source](#)
- [View history](#)

## More

- This page was last edited on 7 October 2006, at 09:18.

- [Privacy policy](#)
- [About Win-Test Wiki](#)
- [Disclaimers](#)



# File:WindowsCheckCallsign.gif

From Win-Test Wiki

[Jump to navigation](#) [Jump to search](#)

- [File](#)
- [File history](#)
- [File usage](#)

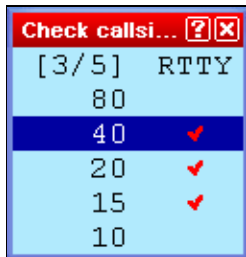

No higher resolution available.

[WindowsCheckCallsign.gif](#) (126 × 132 pixels, file size: 2 KB, MIME type: image/gif)

## File history

Click on a date/time to view the file as it appeared at that time.

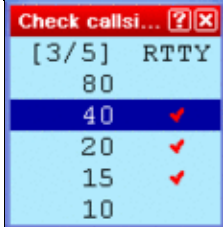
	Date/Time	Thumbnail	Dimensions	User	Comment
current	<a href="#">09:18, 7 October 2006</a>		126 × 132 (2 KB)	<a href="#">Dl6rai (talk   contribs)</a>	

You cannot overwrite this file.

## File usage

The following page uses this file:

- [Menu:Windows](#)

## Namespaces

- [File](#)
- [Discussion](#)

## Variants

## Views

- [Read](#)
- [View source](#)
- [View history](#)

## More

- This page was last edited on 7 October 2006, at 09:18.

- [Privacy policy](#)
- [About Win-Test Wiki](#)
- [Disclaimers](#)



# File:WindowsCheckCountry.PNG

From Win-Test Wiki

[Jump to navigation](#) [Jump to search](#)

- [File](#)
- [File history](#)
- [File usage](#)

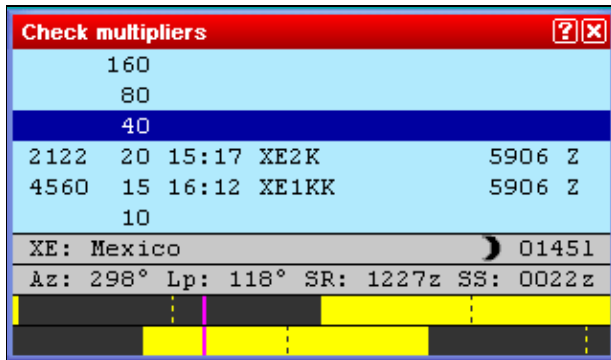

No higher resolution available.

[WindowsCheckCountry.PNG](#) (319 Å 186 pixels, file size: 5 KB, MIME type: image.gif)

Check Country Window

## File history

Click on a date/time to view the file as it appeared at that time.

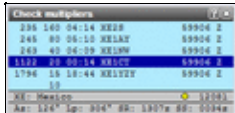
	Date/Time	Thumbnail	Dimensions	User	Comment
current	<a href="#">07:51, 4 October 2009</a>		319 Å 186 (5 KB)	<a href="#">D16rai</a> ( <a href="#">talk</a>   <a href="#">contribs</a> )	
	<a href="#">18:13, 11 February 2009</a>		279 Å 136 (6 KB)	<a href="#">N6TV</a> ( <a href="#">talk</a>   <a href="#">contribs</a> )	Check Country Window

You cannot overwrite this file.

## File usage

The following page uses this file:

- [Menu:Windows](#)

## Namespaces

- [File](#)
- [Discussion](#)

## Variants

## Views

- [Read](#)
- [View source](#)
- [View history](#)

## More

- This page was last edited on 11 February 2009, at 18:13.
- [Privacy policy](#)
- [About Win-Test Wiki](#)
- [Disclaimers](#)





# File:WindowsCheckCountry.PNG

From Win-Test Wiki

[Jump to navigation](#) [Jump to search](#)

- [File](#)
- [File history](#)
- [File usage](#)

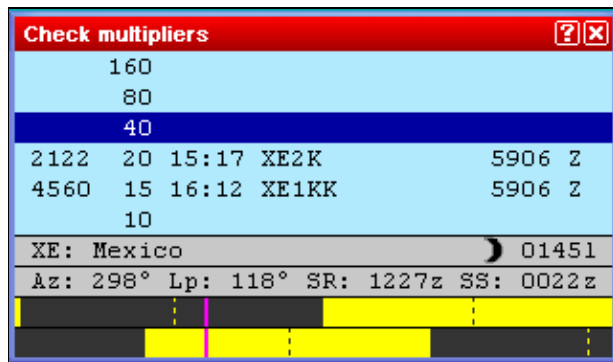

No higher resolution available.

[WindowsCheckCountry.PNG](#) (319 Å 186 pixels, file size: 5 KB, MIME type: image.gif)

Check Country Window

## File history

Click on a date/time to view the file as it appeared at that time.

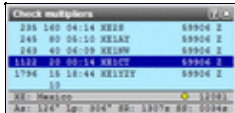
	Date/Time	Thumbnail	Dimensions	User	Comment
current	<a href="#">07:51, 4 October 2009</a>		319 Å 186 (5 KB)	<a href="#">D16rai</a> ( <a href="#">talk</a>   <a href="#">contribs</a> )	
	<a href="#">18:13, 11 February 2009</a>		279 Å 136 (6 KB)	<a href="#">N6TV</a> ( <a href="#">talk</a>   <a href="#">contribs</a> )	Check Country Window

You cannot overwrite this file.

## File usage

The following page uses this file:

- [Menu:Windows](#)

## Namespaces

- [File](#)
- [Discussion](#)

## Variants

## Views

- [Read](#)
- [View source](#)
- [View history](#)

## More

- This page was last edited on 11 February 2009, at 18:13.
- [Privacy policy](#)
- [About Win-Test Wiki](#)
- [Disclaimers](#)



# File:WindowsCheckMult1.gif

From Win-Test Wiki

[Jump to navigation](#) [Jump to search](#)

- [File](#)
- [File history](#)
- [File usage](#)



No higher resolution available.

[WindowsCheckMult1.gif](#) (425 × 104 pixels, file size: 3 KB, MIME type: image/gif)

Looking for a departement during the REF HF Contest

## File history

Click on a date/time to view the file as it appeared at that time.

	Date/Time	Thumbnail	Dimensions	User	Comment
current	<a href="#">21:05, 27 July 2006</a>		425 × 104 (3 KB)	<a href="#">Dl6rai</a> ( <a href="#">talk</a>   <a href="#">contribs</a> )	Looking for a departement during the REF HF Contest

You cannot overwrite this file.

## File usage

The following page uses this file:

- [Menu:Windows](#)

## Namespaces

- [File](#)
- [Discussion](#)

## Variants

## Views

- [Read](#)
- [View source](#)
- [View history](#)

## More

- This page was last edited on 27 July 2006, at 21:05.

- [Privacy policy](#)
- [About Win-Test Wiki](#)
- [Disclaimers](#)



# File:WindowsCheckMult1.gif

From Win-Test Wiki

[Jump to navigation](#) [Jump to search](#)

- [File](#)
- [File history](#)
- [File usage](#)



No higher resolution available.

[WindowsCheckMult1.gif](#) (425 × 104 pixels, file size: 3 KB, MIME type: image/gif)

Looking for a departement during the REF HF Contest

## File history

Click on a date/time to view the file as it appeared at that time.

	Date/Time	Thumbnail	Dimensions	User	Comment
current	<a href="#">21:05, 27 July 2006</a>		425 × 104 (3 KB)	<a href="#">Dl6rai</a> ( <a href="#">talk</a>   <a href="#">contribs</a> )	Looking for a departement during the REF HF Contest

You cannot overwrite this file.

## File usage

The following page uses this file:

- [Menu:Windows](#)

## Namespaces

- [File](#)
- [Discussion](#)

## Variants

## Views

- [Read](#)
- [View source](#)
- [View history](#)

## More

- This page was last edited on 27 July 2006, at 21:05.

- [Privacy policy](#)
- [About Win-Test Wiki](#)
- [Disclaimers](#)



# File:WindowsCheckMult2.gif

From Win-Test Wiki

[Jump to navigation](#) [Jump to search](#)

- [File](#)
- [File history](#)
- [File usage](#)



No higher resolution available.

[WindowsCheckMult2.gif](#) (445 × 146 pixels, file size: 4 KB, MIME type: image/gif)

Looking for a WAZ zone during the CQWW DX (Zone 40)

## File history

Click on a date/time to view the file as it appeared at that time.

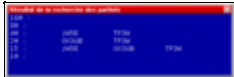
	Date/Time	Thumbnail	Dimensions	User	Comment
current	<a href="#">21:05, 27 July 2006</a>		445 × 146 (4 KB)	<a href="#">Dl6rai (talk   contribs)</a>	Looking for a WAZ zone during the CQWW DX (Zone 40)

You cannot overwrite this file.

## File usage

The following page uses this file:

- [Menu:Windows](#)

## Namespaces

- [File](#)
- [Discussion](#)

## Variants

## Views

- [Read](#)
- [View source](#)
- [View history](#)

## More

- This page was last edited on 27 July 2006, at 21:05.

- [Privacy policy](#)
- [About Win-Test Wiki](#)
- [Disclaimers](#)





# File:WindowsCheckMult2.gif

From Win-Test Wiki

[Jump to navigation](#) [Jump to search](#)

- [File](#)
- [File history](#)
- [File usage](#)



No higher resolution available.

[WindowsCheckMult2.gif](#) (445 × 146 pixels, file size: 4 KB, MIME type: image/gif)

Looking for a WAZ zone during the CQWW DX (Zone 40)

## File history

Click on a date/time to view the file as it appeared at that time.

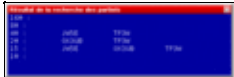
	Date/Time	Thumbnail	Dimensions	User	Comment
current	<a href="#">21:05, 27 July 2006</a>		445 × 146 (4 KB)	<a href="#">Dl6rai</a> ( <a href="#">talk</a>   <a href="#">contribs</a> )	Looking for a WAZ zone during the CQWW DX (Zone 40)

You cannot overwrite this file.

## File usage

The following page uses this file:

- [Menu:Windows](#)

## Namespaces

- [File](#)
- [Discussion](#)

## Variants

## Views

- [Read](#)
- [View source](#)
- [View history](#)

## More

- This page was last edited on 27 July 2006, at 21:05.

- [Privacy policy](#)
- [About Win-Test Wiki](#)
- [Disclaimers](#)



# File:WindowsCheckMult3.gif

From Win-Test Wiki

[Jump to navigation](#) [Jump to search](#)

- [File](#)
- [File history](#)
- [File usage](#)

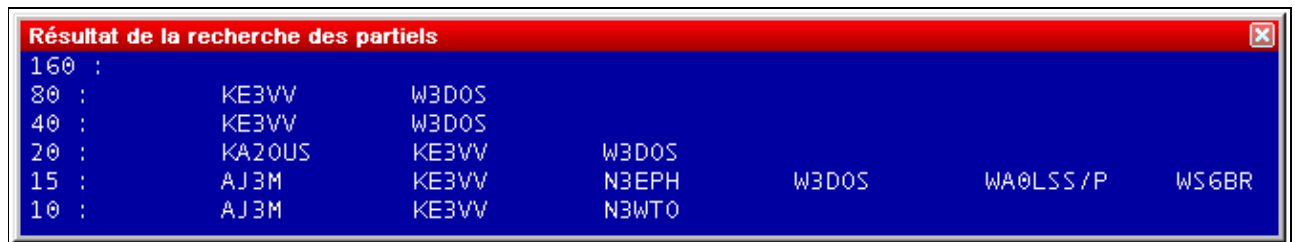

No higher resolution available.

[WindowsCheckMult3.gif](#) (670 × 123 pixels, file size: 4 KB, MIME type: image/gif)

Looking for an US state during the ARRL DX Contest (DC state)

## File history

Click on a date/time to view the file as it appeared at that time.

	Date/Time	Thumbnail	Dimensions	User	Comment
current	<a href="#">21:06, 27 July 2006</a>		670 × 123 (4 KB)	<a href="#">Dl6rai</a> ( <a href="#">talk</a>   <a href="#">contribs</a> )	Looking for an US state during the ARRL DX Contest (DC state)

You cannot overwrite this file.

## File usage

The following page uses this file:

- [Menu:Windows](#)

## Namespaces

- [File](#)
- [Discussion](#)

## Variants

## Views

- [Read](#)
- [View source](#)
- [View history](#)

## More

- This page was last edited on 27 July 2006, at 21:06.

- [Privacy policy](#)
- [About Win-Test Wiki](#)
- [Disclaimers](#)



# File:WindowsCheckMult3.gif

From Win-Test Wiki

[Jump to navigation](#) [Jump to search](#)

- [File](#)
- [File history](#)
- [File usage](#)

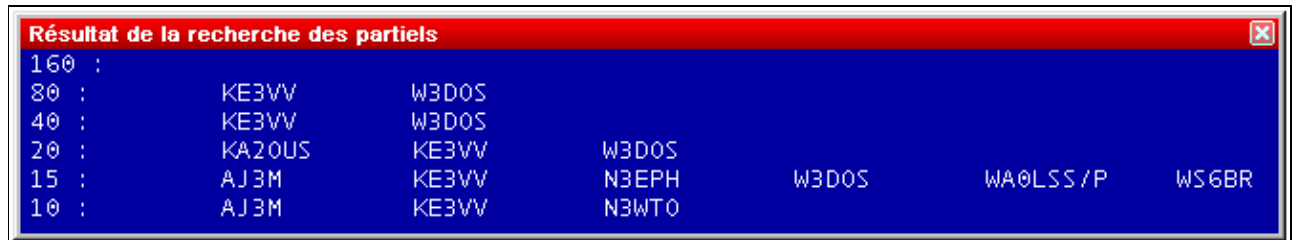

No higher resolution available.

[WindowsCheckMult3.gif](#) (670 × 123 pixels, file size: 4 KB, MIME type: image/gif)

Looking for an US state during the ARRL DX Contest (DC state)

## File history

Click on a date/time to view the file as it appeared at that time.

	Date/Time	Thumbnail	Dimensions	User	Comment
current	<a href="#">21:06, 27 July 2006</a>		670 × 123 (4 KB)	<a href="#">Dl6rai</a> ( <a href="#">talk</a>   <a href="#">contribs</a> )	Looking for an US state during the ARRL DX Contest (DC state)

You cannot overwrite this file.

## File usage

The following page uses this file:

- [Menu:Windows](#)

## Namespaces

- [File](#)
- [Discussion](#)

## Variants

## Views

- [Read](#)
- [View source](#)
- [View history](#)

## More

- This page was last edited on 27 July 2006, at 21:06.

- [Privacy policy](#)
- [About Win-Test Wiki](#)
- [Disclaimers](#)



# File:WindowsCheckPartial.gif

From Win-Test Wiki

[Jump to navigation](#) [Jump to search](#)

- [File](#)
- [File history](#)
- [File usage](#)



No higher resolution available.

[WindowsCheckPartial.gif](#) (405 × 79 pixels, file size: 3 KB, MIME type: image/gif)

Checking partials (A2Q captured)

## File history

Click on a date/time to view the file as it appeared at that time.

	Date/Time	Thumbnail	Dimensions	User	Comment
current	<a href="#">21:09, 27 July 2006</a>		405 × 79 (3 KB)	<a href="#">Dl6rai</a> ( <a href="#">talk</a>   <a href="#">contribs</a> )	Checking partials (A2Q captured)

You cannot overwrite this file.

## File usage

The following page uses this file:

- [Menu:Windows](#)

## Namespaces

- [File](#)
- [Discussion](#)

## Variants

## Views

- [Read](#)
- [View source](#)
- [View history](#)

## More

- This page was last edited on 27 July 2006, at 21:09.

- [Privacy policy](#)
- [About Win-Test Wiki](#)
- [Disclaimers](#)





# File:WindowsCheckPartial.gif

From Win-Test Wiki

[Jump to navigation](#) [Jump to search](#)

- [File](#)
- [File history](#)
- [File usage](#)



No higher resolution available.

[WindowsCheckPartial.gif](#) (405 × 79 pixels, file size: 3 KB, MIME type: image/gif)

Checking partials (A2Q captured)

## File history

Click on a date/time to view the file as it appeared at that time.

	Date/Time	Thumbnail	Dimensions	User	Comment
current	<a href="#">21:09, 27 July 2006</a>		405 × 79 (3 KB)	<a href="#">Dl6rai</a> ( <a href="#">talk</a>   <a href="#">contribs</a> )	Checking partials (A2Q captured)

You cannot overwrite this file.

## File usage

The following page uses this file:

- [Menu:Windows](#)

## Namespaces

- [File](#)
- [Discussion](#)

## Variants

## Views

- [Read](#)
- [View source](#)
- [View history](#)

## More

- This page was last edited on 27 July 2006, at 21:09.

- [Privacy policy](#)
- [About Win-Test Wiki](#)
- [Disclaimers](#)



# File:WindowsCheckPartialOptions.gif

From Win-Test Wiki

[Jump to navigation](#) [Jump to search](#)

- [File](#)
- [File history](#)
- [File usage](#)

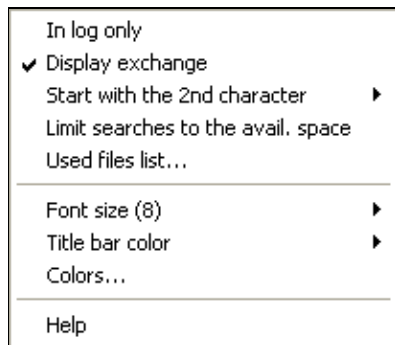



No higher resolution available.

[WindowsCheckPartialOptions.gif](#) (204 × 177 pixels, file size: 2 KB, MIME type: image/gif)

## File history

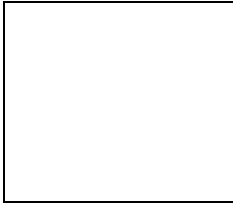
Click on a date/time to view the file as it appeared at that time.

Date/Time	Thumbnail	Dimensions	User	Comment
current <a href="#">08:38, 7 October 2006</a>		204 × 177 (2 KB)	<a href="#">Dl6rai</a> ( <a href="#">talk</a>   <a href="#">contribs</a> )	
<a href="#">08:35, 7 October 2006</a>		201 × 175 (1 KB)	<a href="#">Dl6rai</a> ( <a href="#">talk</a>   <a href="#">contribs</a> )	
<a href="#">22:24, 15 September 2006</a>		204 × 160 (2 KB)	<a href="#">Dl6rai</a> ( <a href="#">talk</a>   <a href="#">contribs</a> )	

Date/Time	Thumbnail	Dimensions	User	Comment
You cannot overwrite this file.				

## File usage

The following page uses this file:

- [Menu:Windows](#)

## Namespaces

- [File](#)
- [Discussion](#)

## Variants

## Views

- [Read](#)
- [View source](#)
- [View history](#)

## More

- This page was last edited on 15 September 2006, at 22:24.

- [Privacy policy](#)
- [About Win-Test Wiki](#)
- [Disclaimers](#)



# File:WindowsCheckPartialOptions.gif

From Win-Test Wiki

[Jump to navigation](#) [Jump to search](#)

- [File](#)
- [File history](#)
- [File usage](#)

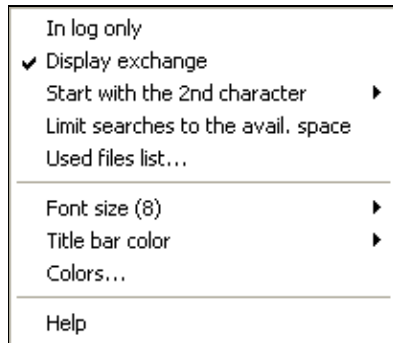



No higher resolution available.

[WindowsCheckPartialOptions.gif](#) (204 × 177 pixels, file size: 2 KB, MIME type: image/gif)

## File history

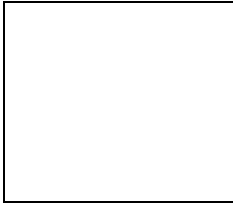
Click on a date/time to view the file as it appeared at that time.

Date/Time	Thumbnail	Dimensions	User	Comment
current <a href="#">08:38, 7 October 2006</a>		204 × 177 (2 KB)	<a href="#">Dl6rai</a> ( <a href="#">talk</a>   <a href="#">contribs</a> )	
<a href="#">08:35, 7 October 2006</a>		201 × 175 (1 KB)	<a href="#">Dl6rai</a> ( <a href="#">talk</a>   <a href="#">contribs</a> )	
<a href="#">22:24, 15 September 2006</a>		204 × 160 (2 KB)	<a href="#">Dl6rai</a> ( <a href="#">talk</a>   <a href="#">contribs</a> )	

Date/Time	Thumbnail	Dimensions	User	Comment
You cannot overwrite this file.				

## File usage

The following page uses this file:

- [Menu:Windows](#)

## Namespaces

- [File](#)
- [Discussion](#)

## Variants

## Views

- [Read](#)
- [View source](#)
- [View history](#)

## More

- This page was last edited on 15 September 2006, at 22:24.

- [Privacy policy](#)
- [About Win-Test Wiki](#)
- [Disclaimers](#)



# File:WindowsCheckPartialQTHLocator.PNG

From Win-Test Wiki

[Jump to navigation](#) [Jump to search](#)

- [File](#)
- [File history](#)
- [File usage](#)

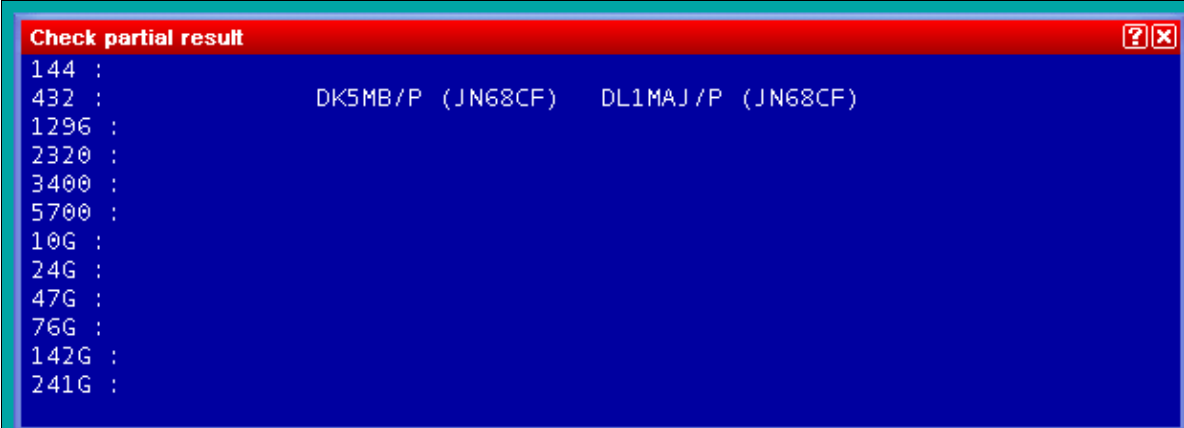

The screenshot shows a Windows application window titled "Check partial result" with a red title bar. The window content is a blue background with white text. It displays a list of call signs and a table of QTH locator data.

144 :  
432 :                   DK5MB/P (JN68CF)   DL1MAJ/P (JN68CF)  
1296 :  
2320 :  
3400 :  
5700 :  
10G :  
24G :  
47G :  
76G :  
142G :  
241G :

12:38:56      DL6RAI      JN58SG RUN

Bd	Time	Callsign	Sent	N°	Rcvd	Loc	Az.	Dist	Mult
432	14:44	DL5MAE/P	59	001	59 277	JN57WS	156	61	LOC
432	14:45	DD5M	59	002	59 051	JN58KD	255	52	LOC
432	14:47	DL1MHJ	59	003	59 034	JN58TE	146	12	
432	14:47	DK5MB/P	59	004	59 235	JN68CF	95	50	LOC
432	14:49	DK1KC/P	59	005	59 149	JN58QH	291	14	
432	14:50	DL1MAJ/P	59	006	59 177	JN68CF	95	50	
432			59	007	59	JN68	0	0	

No higher resolution available.

WindowsCheckPartialOTHLocator.PNG (734 × 436 pixels, file size: 18 KB, MIME type: image.gif)

## File history

Click on a date/time to view the file as it appeared at that time.

	Date/Time	Thumbnail	Dimensions	User	Comment
current	<u>12:42, 31 January 2009</u>		734 × 436 (18 KB)	<u>Dl6rai</u> ( <a href="#">talk</a>   <a href="#">contribs</a> )	

You cannot overwrite this file.

## File usage

The following page uses this file:

- [Menu:Windows](#)

## Namespaces

- [File](#)
- [Discussion](#)

## Variants

## Views

- [Read](#)
- [View source](#)
- [View history](#)

## More

- This page was last edited on 31 January 2009, at 12:42.

- [Privacy policy](#)
- [About Win-Test Wiki](#)
- [Disclaimers](#)





# File:WindowsCheckPartialQTHLocator.PNG

From Win-Test Wiki

[Jump to navigation](#) [Jump to search](#)

- [File](#)
- [File history](#)
- [File usage](#)

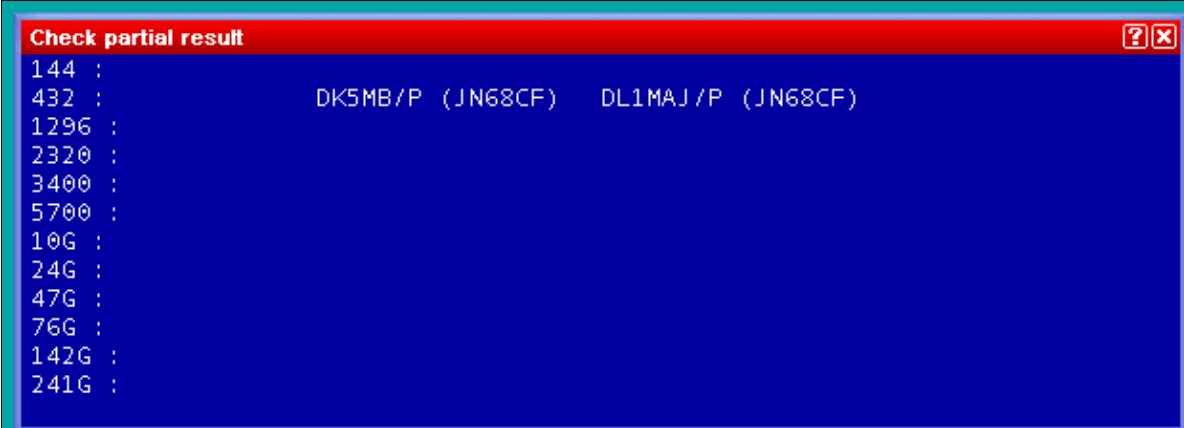

The screenshot shows a window titled "Check partial result" with a blue background. It displays a list of call signs and a table of reception data. The table has columns for Bd, Time, Callsign, Sent N°, Rcvd, Loc, Az., Dist, and Mult.

Bd	Time	Callsign	Sent N°	Rcvd	Loc	Az.	Dist	Mult
432	14:44	DL5MAE/P	59 001	59 277	JN57WS	156	61	LOC
432	14:45	DD5M	59 002	59 051	JN58KD	255	52	LOC
432	14:47	DL1MHJ	59 003	59 034	JN58TE	146	12	
432	14:47	DK5MB/P	59 004	59 235	JN68CF	95	50	LOC
432	14:49	DK1KC/P	59 005	59 149	JN58QH	291	14	
432	14:50	DL1MAJ/P	59 006	59 177	JN68CF	95	50	
432			59 007	59	JN68	0	0	

No higher resolution available.

WindowsCheckPartialOTHLocator.PNG (734 × 436 pixels, file size: 18 KB, MIME type: image.gif)

## File history

Click on a date/time to view the file as it appeared at that time.

	Date/Time	Thumbnail	Dimensions	User	Comment
current	<u>12:42, 31 January 2009</u>		734 × 436 (18 KB)	<u>Dl6rai</u> ( <a href="#">talk</a>   <a href="#">contribs</a> )	

You cannot overwrite this file.

## File usage

The following page uses this file:

- [Menu:Windows](#)

## Namespaces

- [File](#)
- [Discussion](#)

## Variants

## Views

- [Read](#)
- [View source](#)
- [View history](#)

## More

- This page was last edited on 31 January 2009, at 12:42.

- [Privacy policy](#)
- [About Win-Test Wiki](#)
- [Disclaimers](#)



# File:WindowsCheckPartialResult.gif

From Win-Test Wiki

[Jump to navigation](#) [Jump to search](#)

- [File](#)
- [File history](#)
- [File usage](#)

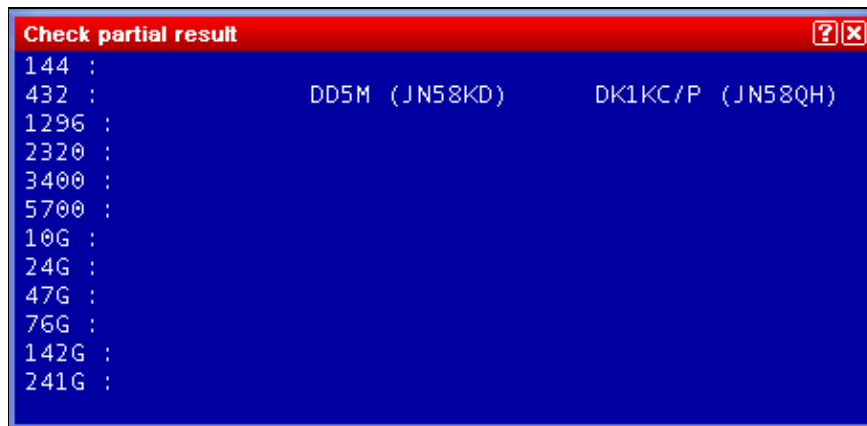

No higher resolution available.

[WindowsCheckPartialResult.gif](#) (454 × 220 pixels, file size: 5 KB, MIME type: image.gif)

## File history

Click on a date/time to view the file as it appeared at that time.

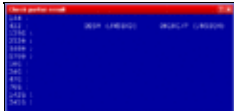
Date/Time	Thumbnail	Dimensions	User	Comment
current <a href="#">06:51, 19 January 2009</a>		454 × 220 (5 KB)	<a href="#">Dl6rai</a> ( <a href="#">talk</a>   <a href="#">contribs</a> )	

You cannot overwrite this file.

## File usage

The following page uses this file:

- [Menu:Windows](#)

## Namespaces

- [File](#)
- [Discussion](#)

## Variants

## Views

- [Read](#)
- [View source](#)
- [View history](#)

## More

- This page was last edited on 19 January 2009, at 06:51.

- [Privacy policy](#)
- [About Win-Test Wiki](#)
- [Disclaimers](#)



# File:WindowsCheckPartialResult.gif

From Win-Test Wiki

[Jump to navigation](#) [Jump to search](#)

- [File](#)
- [File history](#)
- [File usage](#)

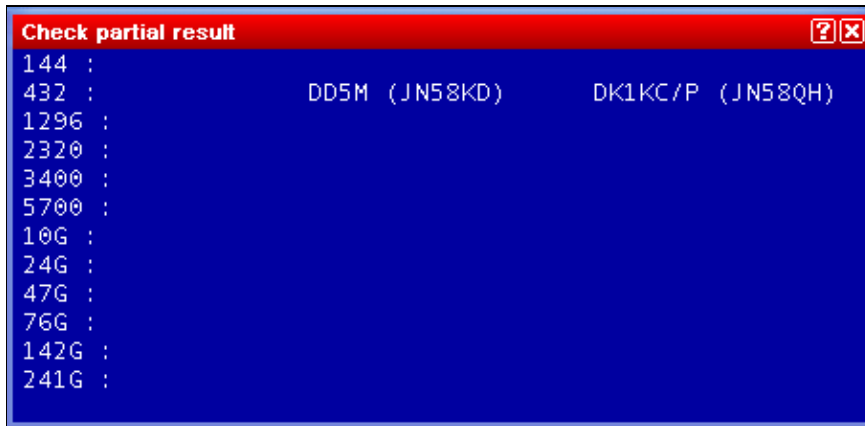

No higher resolution available.

[WindowsCheckPartialResult.gif](#) (454 × 220 pixels, file size: 5 KB, MIME type: image.gif)

## File history

Click on a date/time to view the file as it appeared at that time.

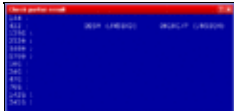
Date/Time	Thumbnail	Dimensions	User	Comment
current <a href="#">06:51, 19 January 2009</a>		454 × 220 (5 KB)	<a href="#">Dl6rai</a> ( <a href="#">talk</a>   <a href="#">contribs</a> )	

You cannot overwrite this file.

## File usage

The following page uses this file:

- [Menu:Windows](#)

## Namespaces

- [File](#)
- [Discussion](#)

## Variants

## Views

- [Read](#)
- [View source](#)
- [View history](#)

## More

- This page was last edited on 19 January 2009, at 06:51.

- [Privacy policy](#)
- [About Win-Test Wiki](#)
- [Disclaimers](#)



# File:WindowsCheckPartialShiftF10.gif

From Win-Test Wiki

[Jump to navigation](#) [Jump to search](#)

- [File](#)
- [File history](#)
- [File usage](#)

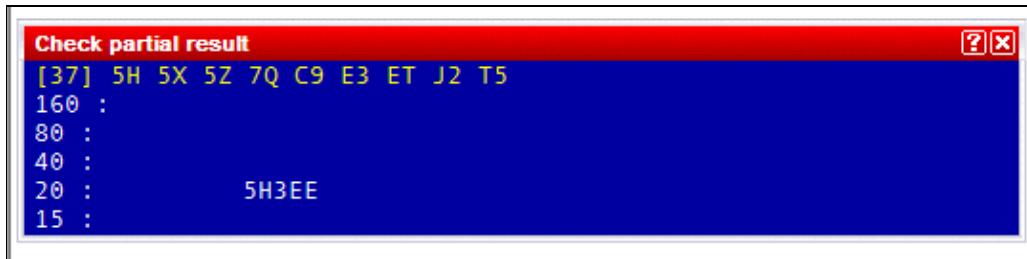

No higher resolution available.

[WindowsCheckPartialShiftF10.gif](#) (539 × 133 pixels, file size: 5 KB, MIME type: image.gif)

## File history

Click on a date/time to view the file as it appeared at that time.

Date/Time	Thumbnail	Dimensions	User	Comment
current <a href="#">01:36, 5 December 2009</a>		539 × 133 (5 KB)	<a href="#">N6TV</a> ( <a href="#">talk</a>   <a href="#">contribs</a> )	

You cannot overwrite this file.

## File usage

The following page uses this file:

- [Menu:Windows](#)

## Namespaces

- [File](#)
- [Discussion](#)

## Variants

## Views

- [Read](#)
- [View source](#)
- [View history](#)

## More

- This page was last edited on 5 December 2009, at 01:36.

- [Privacy policy](#)
- [About Win-Test Wiki](#)
- [Disclaimers](#)





# File:WindowsCheckPartialShiftF10.gif

From Win-Test Wiki

[Jump to navigation](#) [Jump to search](#)

- [File](#)
- [File history](#)
- [File usage](#)

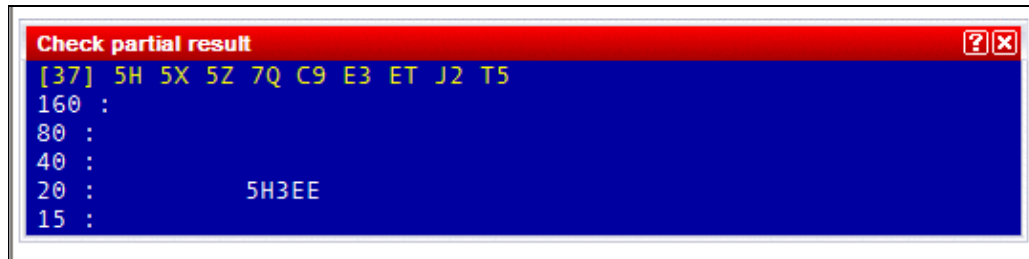

No higher resolution available.

[WindowsCheckPartialShiftF10.gif](#) (539 × 133 pixels, file size: 5 KB, MIME type: image.gif)

## File history

Click on a date/time to view the file as it appeared at that time.

Date/Time	Thumbnail	Dimensions	User	Comment
current <a href="#">01:36, 5 December 2009</a>		539 × 133 (5 KB)	<a href="#">N6TV</a> ( <a href="#">talk</a>   <a href="#">contribs</a> )	

You cannot overwrite this file.

## File usage

The following page uses this file:

- [Menu:Windows](#)

## Namespaces

- [File](#)
- [Discussion](#)

## Variants

## Views

- [Read](#)
- [View source](#)
- [View history](#)

## More

- This page was last edited on 5 December 2009, at 01:36.

- [Privacy policy](#)
- [About Win-Test Wiki](#)
- [Disclaimers](#)



# File:WindowsDxClusterAnn.gif

From Win-Test Wiki

[Jump to navigation](#) [Jump to search](#)

- [File](#)
- [File history](#)
- [File usage](#)
- [Metadata](#)



No higher resolution available.

[WindowsDxClusterAnn.gif](#) (368 × 209 pixels, file size: 12 KB, MIME type: image.gif)

## File history

Click on a date/time to view the file as it appeared at that time.

	Date/Time	Thumbnail	Dimensions	User	Comment
current	<a href="#">10:33, 30 December 2021</a>		368 × 209 (12 KB)	<a href="#">Dl6rai</a> ( <a href="#">talk</a>   <a href="#">contribs</a> )	

You cannot overwrite this file.

## File usage

The following page uses this file:

- [Menu:Windows](#)

## Metadata

This file contains additional information, probably added from the digital camera or scanner used to create or digitize it.

If the file has been modified from its original state, some details may not fully reflect the modified file.

**Horizontal resolution** 37.79 dpc

**Vertical resolution** 37.79 dpc

## Namespaces

- [File](#)
- [Discussion](#)

## Variants

## Views

- [Read](#)
- [View source](#)
- [View history](#)

## More

- This page was last edited on 30 December 2021, at 10:33.
- [Privacy policy](#)
- [About Win-Test Wiki](#)
- [Disclaimers](#)



# File:WindowsDxClusterAnn.gif

From Win-Test Wiki

[Jump to navigation](#) [Jump to search](#)

- [File](#)
- [File history](#)
- [File usage](#)
- [Metadata](#)



No higher resolution available.

[WindowsDxClusterAnn.gif](#) (368 × 209 pixels, file size: 12 KB, MIME type: image.gif)

## File history

Click on a date/time to view the file as it appeared at that time.

	Date/Time	Thumbnail	Dimensions	User	Comment
current	<a href="#">10:33, 30 December 2021</a>		368 × 209 (12 KB)	<a href="#">Dl6rai</a> ( <a href="#">talk</a>   <a href="#">contribs</a> )	

You cannot overwrite this file.

## File usage

The following page uses this file:

- [Menu:Windows](#)

## Metadata

This file contains additional information, probably added from the digital camera or scanner used to create or digitize it.

If the file has been modified from its original state, some details may not fully reflect the modified file.

**Horizontal resolution** 37.79 dpc

**Vertical resolution** 37.79 dpc

## Namespaces

- [File](#)
- [Discussion](#)

## Variants

## Views

- [Read](#)
- [View source](#)
- [View history](#)

## More

- This page was last edited on 30 December 2021, at 10:33.
- [Privacy policy](#)
- [About Win-Test Wiki](#)
- [Disclaimers](#)



# File:WindowsExtraDataFiles.gif

From Win-Test Wiki

[Jump to navigation](#) [Jump to search](#)

- [File](#)
- [File history](#)
- [File usage](#)

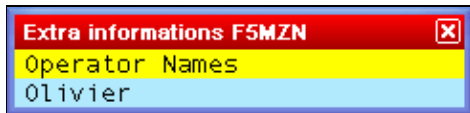

No higher resolution available.

[WindowsExtraDataFiles.gif](#) (244 × 56 pixels, file size: 2 KB, MIME type: image.gif)

## File history

Click on a date/time to view the file as it appeared at that time.

	Date/Time	Thumbnail	Dimensions	User	Comment
current	<a href="#">19:23, 1 January 2007</a>		244 × 56 (2 KB)	<a href="#">Dl6rai</a> ( <a href="#">talk</a>   <a href="#">contribs</a> )	

You cannot overwrite this file.

## File usage

The following page uses this file:

- [Menu:Windows](#)

## Namespaces

- [File](#)
- [Discussion](#)

## Variants

## Views

- [Read](#)
- [View source](#)
- [View history](#)

## More

- This page was last edited on 1 January 2007, at 19:23.

- [Privacy policy](#)
- [About Win-Test Wiki](#)
- [Disclaimers](#)





# File:WindowsExtraDataFiles.gif

From Win-Test Wiki

[Jump to navigation](#) [Jump to search](#)

- [File](#)
- [File history](#)
- [File usage](#)

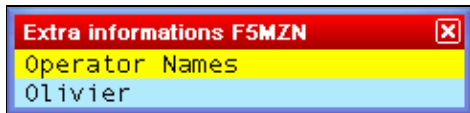

No higher resolution available.

[WindowsExtraDataFiles.gif](#) (244 × 56 pixels, file size: 2 KB, MIME type: image.gif)

## File history

Click on a date/time to view the file as it appeared at that time.

	Date/Time	Thumbnail	Dimensions	User	Comment
current	<a href="#">19:23, 1 January 2007</a>		244 × 56 (2 KB)	<a href="#">Dl6rai</a> ( <a href="#">talk</a>   <a href="#">contribs</a> )	

You cannot overwrite this file.

## File usage

The following page uses this file:

- [Menu:Windows](#)

## Namespaces

- [File](#)
- [Discussion](#)

## Variants

## Views

- [Read](#)
- [View source](#)
- [View history](#)

## More

- This page was last edited on 1 January 2007, at 19:23.

- [Privacy policy](#)
- [About Win-Test Wiki](#)
- [Disclaimers](#)



# File:WindowsGab.gif

From Win-Test Wiki

[Jump to navigation](#) [Jump to search](#)

- [File](#)
- [File history](#)
- [File usage](#)

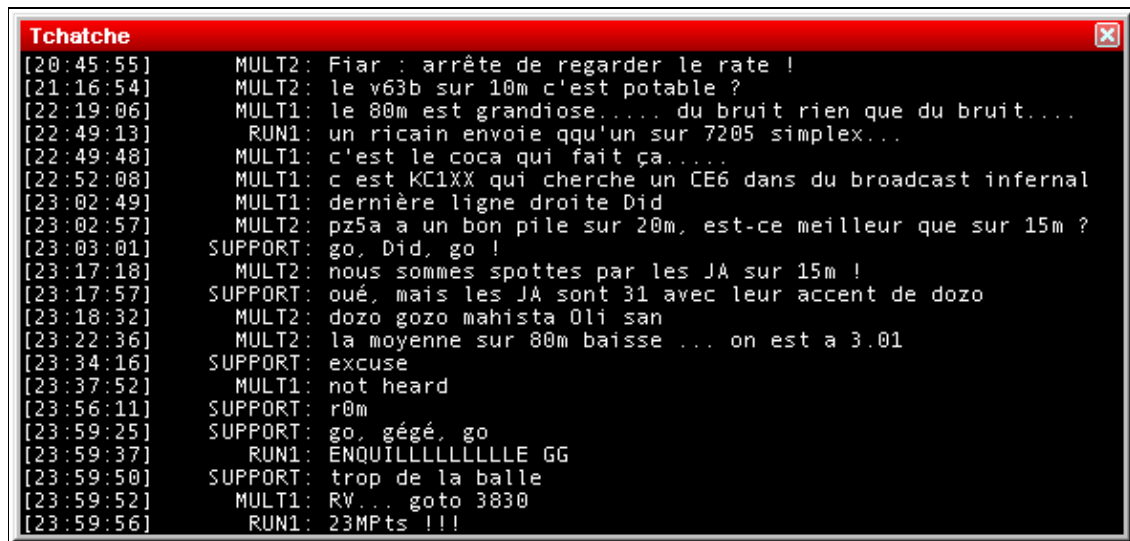

No higher resolution available.

[WindowsGab.gif](#) (590 × 281 pixels, file size: 10 KB, MIME type: image/gif)

Gab window

## File history

Click on a date/time to view the file as it appeared at that time.

Date/Time	Thumbnail	Dimensions	User	Comment
current <a href="#">21:43, 27 July 2006</a>		590 × 281 (10 KB)	<a href="#">Dl6rai</a> ( <a href="#">talk</a>   <a href="#">contribs</a> )	Gab window

You cannot overwrite this file.

## File usage

The following page uses this file:

- [Menu:Windows](#)

## Namespaces

- [File](#)
- [Discussion](#)

## Variants

## Views

- [Read](#)
- [View source](#)
- [View history](#)

## More

- This page was last edited on 27 July 2006, at 21:43.
- [Privacy policy](#)
- [About Win-Test Wiki](#)
- [Disclaimers](#)



# File:WindowsGab.gif

From Win-Test Wiki

[Jump to navigation](#) [Jump to search](#)

- [File](#)
- [File history](#)
- [File usage](#)

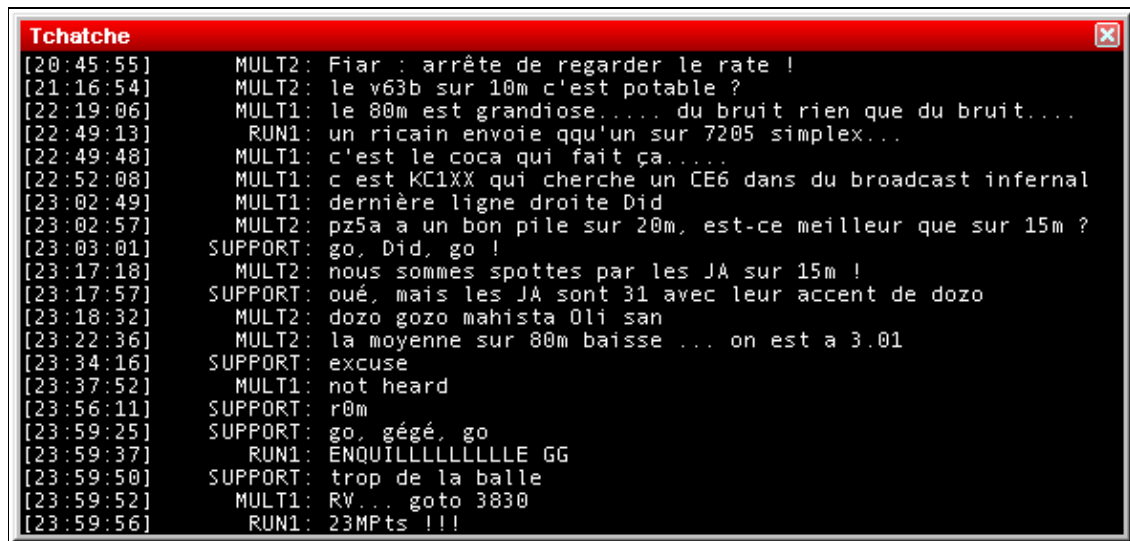

No higher resolution available.

[WindowsGab.gif](#) (590 × 281 pixels, file size: 10 KB, MIME type: image/gif)

Gab window

## File history

Click on a date/time to view the file as it appeared at that time.

Date/Time	Thumbnail	Dimensions	User	Comment
current <a href="#">21:43, 27 July 2006</a>		590 × 281 (10 KB)	<a href="#">Dl6rai</a> ( <a href="#">talk</a>   <a href="#">contribs</a> )	Gab window

You cannot overwrite this file.

## File usage

The following page uses this file:

- [Menu:Windows](#)

## Namespaces

- [File](#)
- [Discussion](#)

## Variants

## Views

- [Read](#)
- [View source](#)
- [View history](#)

## More

- This page was last edited on 27 July 2006, at 21:43.

- [Privacy policy](#)
- [About Win-Test Wiki](#)
- [Disclaimers](#)

- The logo for MediaWiki, featuring a sun icon and the text "Powered By MediaWiki".

# File:WindowsGridSquareMap1.gif

From Win-Test Wiki

[Jump to navigation](#) [Jump to search](#)

- [File](#)
- [File history](#)
- [File usage](#)

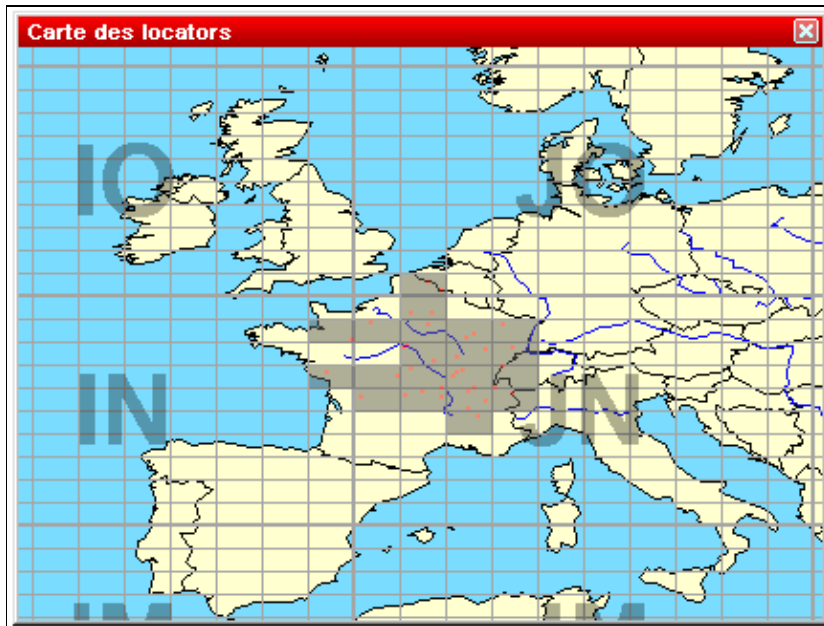

No higher resolution available.

[WindowsGridSquareMap1.gif](#) (431 × 325 pixels, file size: 15 KB, MIME type: image/gif)

Gridsquares Map

## File history

Click on a date/time to view the file as it appeared at that time.

Date/Time	Thumbnail	Dimensions	User	Comment
current <a href="#">19:55, 27 July 2006</a>		431 × 325 (15 KB)	<a href="#">Dl6rai</a> ( <a href="#">talk</a>   <a href="#">contribs</a> )	Gridsquares Map

You cannot overwrite this file.

## File usage

The following page uses this file:

- [Menu:Windows](#)

## Namespaces

- [File](#)
- [Discussion](#)

## Variants

## Views

- [Read](#)
- [View source](#)
- [View history](#)

## More

- This page was last edited on 27 July 2006, at 19:55.

- [Privacy policy](#)
- [About Win-Test Wiki](#)
- [Disclaimers](#)





# File:WindowsGridSquareMap1.gif

From Win-Test Wiki

[Jump to navigation](#) [Jump to search](#)

- [File](#)
- [File history](#)
- [File usage](#)

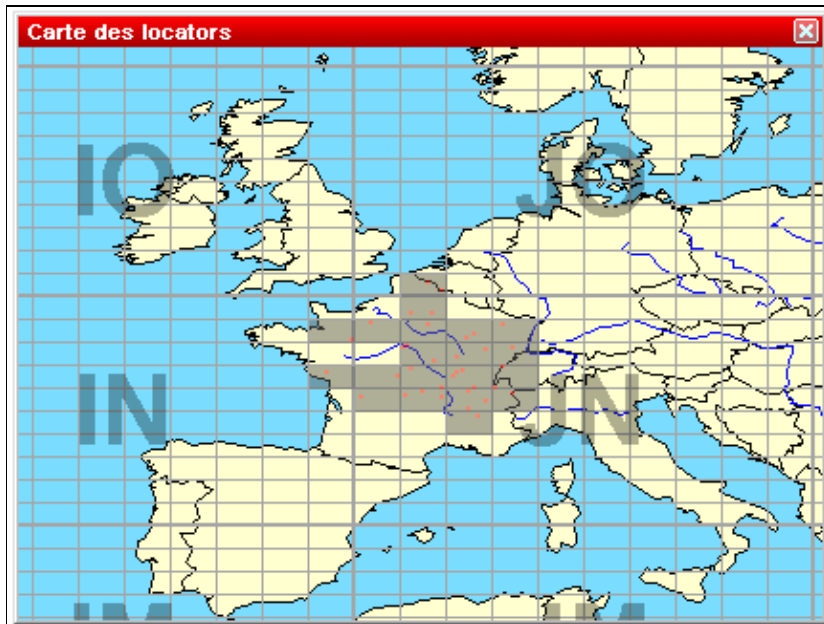

No higher resolution available.

[WindowsGridSquareMap1.gif](#) (431 × 325 pixels, file size: 15 KB, MIME type: image/gif)

Gridsquares Map

## File history

Click on a date/time to view the file as it appeared at that time.

Date/Time	Thumbnail	Dimensions	User	Comment
current <a href="#">19:55, 27 July 2006</a>		431 × 325 (15 KB)	<a href="#">Dl6rai</a> ( <a href="#">talk</a>   <a href="#">contribs</a> )	Gridsquares Map

You cannot overwrite this file.

## File usage

The following page uses this file:

- [Menu:Windows](#)

## Namespaces

- [File](#)
- [Discussion](#)

## Variants

## Views

- [Read](#)
- [View source](#)
- [View history](#)

## More

- This page was last edited on 27 July 2006, at 19:55.
- [Privacy policy](#)
- [About Win-Test Wiki](#)
- [Disclaimers](#)



# File:Windows IP settings.gif

From Win-Test Wiki

[Jump to navigation](#) [Jump to search](#)

- [File](#)
- [File history](#)
- [File usage](#)

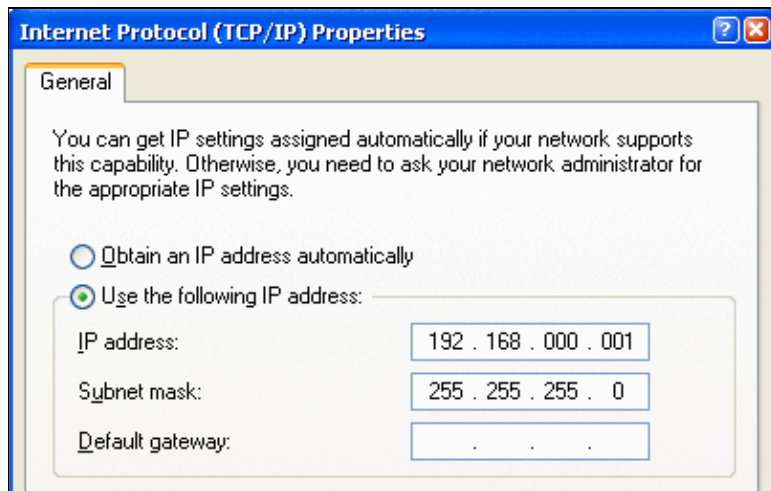

No higher resolution available.

[Windows IP settings.gif](#) (403 × 253 pixels, file size: 18 KB, MIME type: image.gif)

Windows TCP/IP settings screenshot

## File history

Click on a date/time to view the file as it appeared at that time.

	Date/Time	Thumbnail	Dimensions	User	Comment
current	<a href="#">14:13, 5 January 2006</a>		403 × 253 (18 KB)	<a href="#">M0CLW</a> ( <a href="#">talk</a>   <a href="#">contribs</a> )	Windows TCP/IP settings screenshot

You cannot overwrite this file.

## File usage

The following page uses this file:

- [Networking](#)

## Namespaces

- [File](#)
- [Discussion](#)

## Variants

## Views

- [Read](#)
- [View source](#)
- [View history](#)

## More

- This page was last edited on 5 January 2006, at 14:13.
- [Privacy policy](#)
- [About Win-Test Wiki](#)
- [Disclaimers](#)



# File:Windows IP settings.gif

From Win-Test Wiki

[Jump to navigation](#) [Jump to search](#)

- [File](#)
- [File history](#)
- [File usage](#)

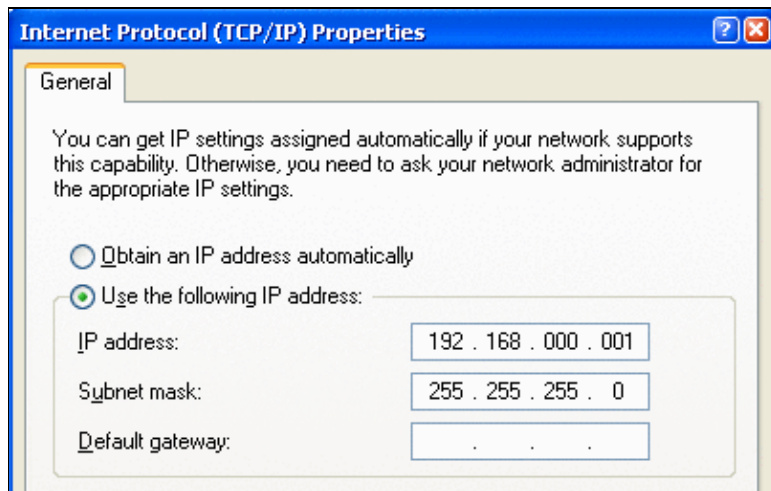

No higher resolution available.

[Windows IP settings.gif](#) (403 × 253 pixels, file size: 18 KB, MIME type: image.gif)

Windows TCP/IP settings screenshot

## File history

Click on a date/time to view the file as it appeared at that time.

	Date/Time	Thumbnail	Dimensions	User	Comment
current	<a href="#">14:13, 5 January 2006</a>		403 × 253 (18 KB)	<a href="#">M0CLW</a> ( <a href="#">talk</a>   <a href="#">contribs</a> )	Windows TCP/IP settings screenshot

You cannot overwrite this file.

## File usage

The following page uses this file:

- [Networking](#)

## Namespaces

- [File](#)
- [Discussion](#)

## Variants

## Views

- [Read](#)
- [View source](#)
- [View history](#)

## More

- This page was last edited on 5 January 2006, at 14:13.

- [Privacy policy](#)
- [About Win-Test Wiki](#)
- [Disclaimers](#)



# File:WindowsMap.gif

From Win-Test Wiki

[Jump to navigation](#) [Jump to search](#)

- [File](#)
- [File history](#)
- [File usage](#)

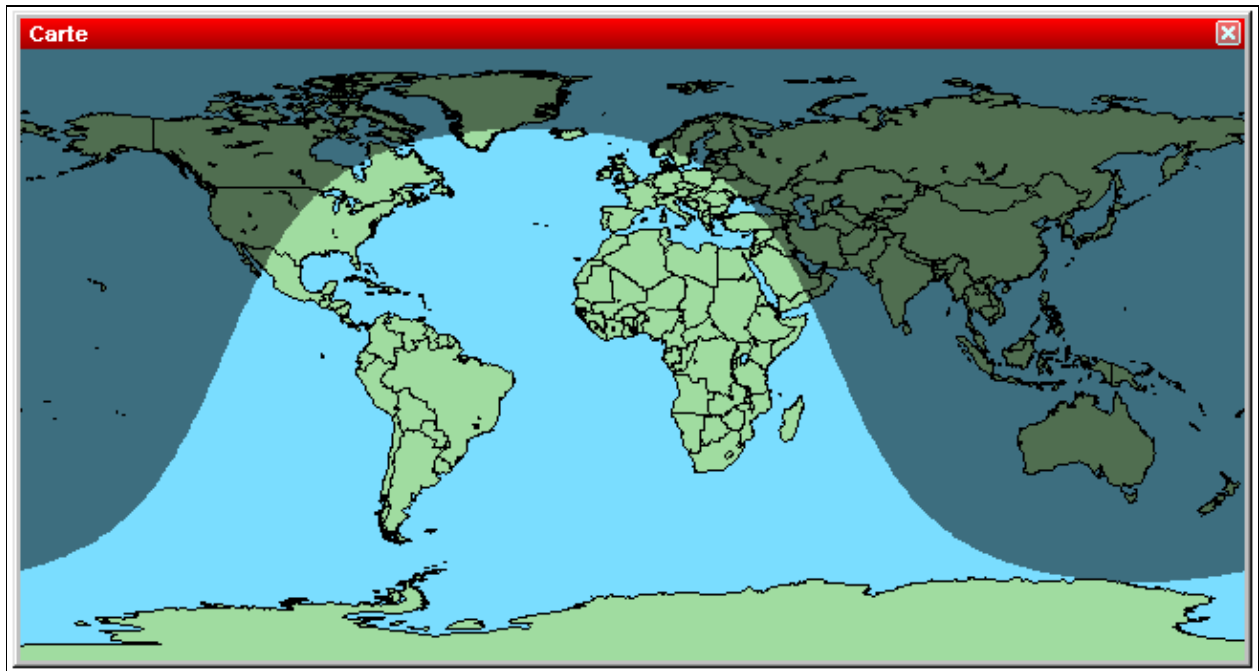

No higher resolution available.

[WindowsMap.gif](#) (654 × 348 pixels, file size: 14 KB, MIME type: image/gif)

World Map

## File history

Click on a date/time to view the file as it appeared at that time.

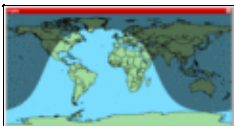
Date/Time	Thumbnail	Dimensions	User	Comment
current <a href="#">21:45, 27 July 2006</a>		654 × 348 (14 KB)	<a href="#">Dl6rai</a> ( <a href="#">talk</a>   <a href="#">contribs</a> )	World Map

You cannot overwrite this file.

## File usage

The following page uses this file:

File:WindowsMap.gif

1947

- [Menu:Windows](#)

## Namespaces

- [File](#)
- [Discussion](#)

## Variants

## Views

- [Read](#)
- [View source](#)
- [View history](#)

## More

- This page was last edited on 27 July 2006, at 21:45.

- [Privacy policy](#)
- [About Win-Test Wiki](#)
- [Disclaimers](#)





# File:WindowsMap.gif

From Win-Test Wiki

[Jump to navigation](#) [Jump to search](#)

- [File](#)
- [File history](#)
- [File usage](#)

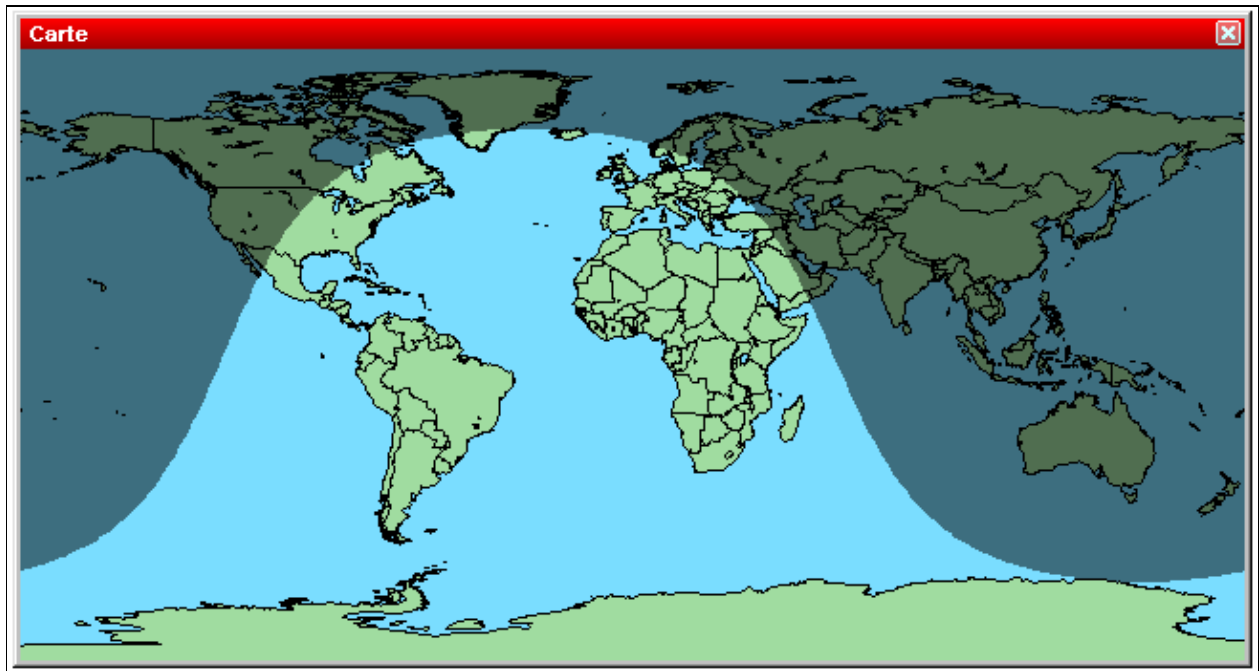

No higher resolution available.

[WindowsMap.gif](#) (654 × 348 pixels, file size: 14 KB, MIME type: image/gif)

World Map

## File history

Click on a date/time to view the file as it appeared at that time.

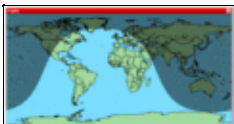
Date/Time	Thumbnail	Dimensions	User	Comment
current <a href="#">21:45, 27 July 2006</a>		654 × 348 (14 KB)	<a href="#">Dl6rai</a> ( <a href="#">talk</a>   <a href="#">contribs</a> )	World Map

You cannot overwrite this file.

## File usage

The following page uses this file:

- [Menu:Windows](#)

## Namespaces

- [File](#)
- [Discussion](#)

## Variants

## Views

- [Read](#)
- [View source](#)
- [View history](#)

## More

- This page was last edited on 27 July 2006, at 21:45.

- [Privacy policy](#)
- [About Win-Test Wiki](#)
- [Disclaimers](#)



# File:WindowsMult.gif

From Win-Test Wiki

[Jump to navigation](#) [Jump to search](#)

- [File](#)
- [File history](#)
- [File usage](#)

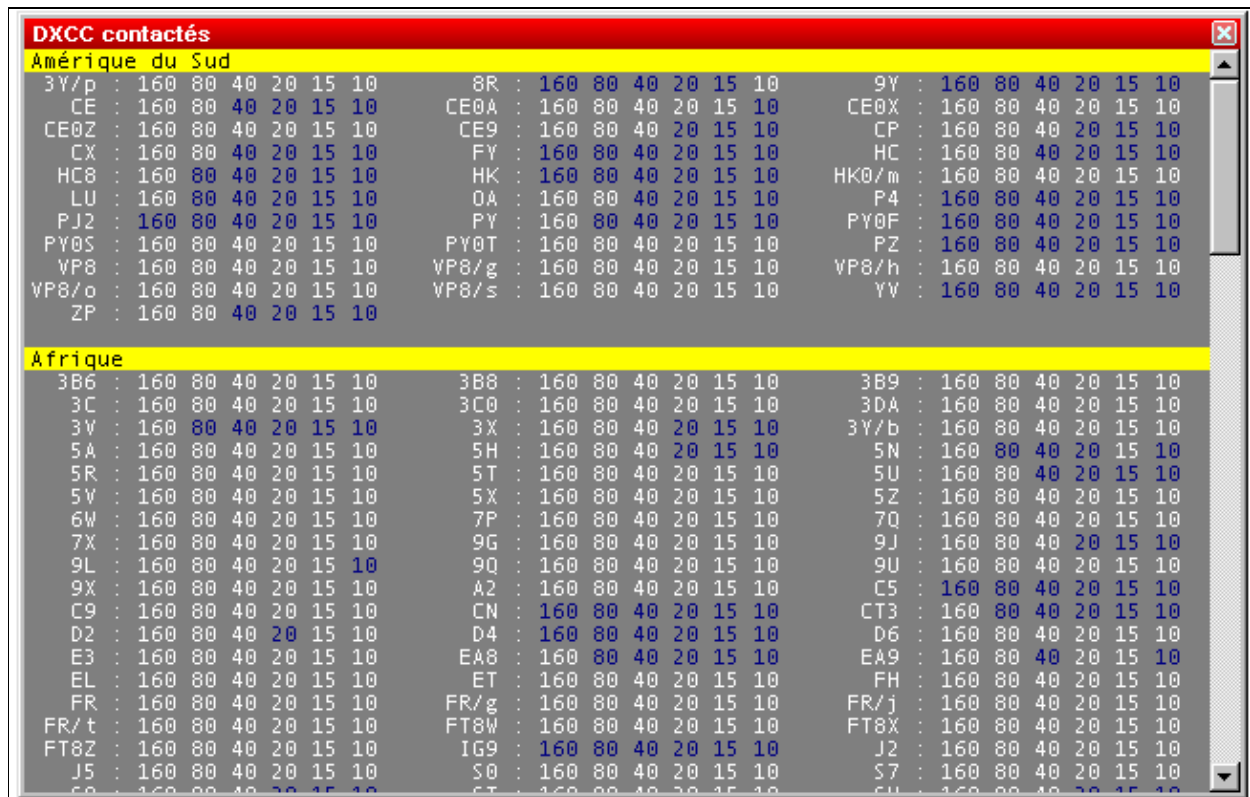

**DXCC contactés**

**Amérique du Sud**

3Y/p	: 160 80 40 20 15 10	8R	: 160 80 40 20 15 10	9Y	: 160 80 40 20 15 10
CE	: 160 80 40 20 15 10	CE0A	: 160 80 40 20 15 10	CE0X	: 160 80 40 20 15 10
CE0Z	: 160 80 40 20 15 10	CE9	: 160 80 40 20 15 10	CP	: 160 80 40 20 15 10
CX	: 160 80 40 20 15 10	FY	: 160 80 40 20 15 10	HC	: 160 80 40 20 15 10
HC8	: 160 80 40 20 15 10	HK	: 160 80 40 20 15 10	HK0/m	: 160 80 40 20 15 10
LU	: 160 80 40 20 15 10	OA	: 160 80 40 20 15 10	P4	: 160 80 40 20 15 10
PJ2	: 160 80 40 20 15 10	PY	: 160 80 40 20 15 10	PY0F	: 160 80 40 20 15 10
PY0S	: 160 80 40 20 15 10	PY0T	: 160 80 40 20 15 10	PZ	: 160 80 40 20 15 10
VP8	: 160 80 40 20 15 10	VP8/g	: 160 80 40 20 15 10	VP8/h	: 160 80 40 20 15 10
VP8/o	: 160 80 40 20 15 10	VP8/s	: 160 80 40 20 15 10	YV	: 160 80 40 20 15 10
ZP	: 160 80 40 20 15 10				

**Afrique**

3B6	: 160 80 40 20 15 10	3B8	: 160 80 40 20 15 10	3B9	: 160 80 40 20 15 10
3C	: 160 80 40 20 15 10	3C0	: 160 80 40 20 15 10	3DA	: 160 80 40 20 15 10
3V	: 160 80 40 20 15 10	3X	: 160 80 40 20 15 10	3Y/b	: 160 80 40 20 15 10
5A	: 160 80 40 20 15 10	5H	: 160 80 40 20 15 10	5N	: 160 80 40 20 15 10
5R	: 160 80 40 20 15 10	5T	: 160 80 40 20 15 10	5U	: 160 80 40 20 15 10
5V	: 160 80 40 20 15 10	5X	: 160 80 40 20 15 10	5Z	: 160 80 40 20 15 10
6W	: 160 80 40 20 15 10	7P	: 160 80 40 20 15 10	7Q	: 160 80 40 20 15 10
7X	: 160 80 40 20 15 10	9G	: 160 80 40 20 15 10	9J	: 160 80 40 20 15 10
9L	: 160 80 40 20 15 10	9Q	: 160 80 40 20 15 10	9U	: 160 80 40 20 15 10
9X	: 160 80 40 20 15 10	A2	: 160 80 40 20 15 10	C5	: 160 80 40 20 15 10
C9	: 160 80 40 20 15 10	CN	: 160 80 40 20 15 10	CT3	: 160 80 40 20 15 10
D2	: 160 80 40 20 15 10	D4	: 160 80 40 20 15 10	D6	: 160 80 40 20 15 10
E3	: 160 80 40 20 15 10	EA8	: 160 80 40 20 15 10	EA9	: 160 80 40 20 15 10
EL	: 160 80 40 20 15 10	ET	: 160 80 40 20 15 10	FH	: 160 80 40 20 15 10
FR	: 160 80 40 20 15 10	FR/g	: 160 80 40 20 15 10	FR/j	: 160 80 40 20 15 10
FR/t	: 160 80 40 20 15 10	FT8W	: 160 80 40 20 15 10	FT8X	: 160 80 40 20 15 10
FT8Z	: 160 80 40 20 15 10	IG9	: 160 80 40 20 15 10	J2	: 160 80 40 20 15 10
J5	: 160 80 40 20 15 10	S0	: 160 80 40 20 15 10	S7	: 160 80 40 20 15 10
CO	: 160 80 40 20 15 10	CT	: 160 80 40 20 15 10	CU	: 160 80 40 20 15 10

No higher resolution available.

[WindowsMult.gif](#) (650 × 415 pixels, file size: 20 KB, MIME type: image/gif)

Worked DXCC countries window

## File history

Click on a date/time to view the file as it appeared at that time.

	Date/Time	Thumbnail	Dimensions	User	Comment
current	<a href="#">20:58, 27 July 2006</a>		650 × 415 (20 KB)	<a href="#">Dl6rai (talk   contribs)</a>	Worked DXCC countries window

You cannot overwrite this file.

## File usage

The following 2 pages use this file:

- [Menu:Windows](#)
- [Win-Test Wiki:Sandbox](#)

## Namespaces

- [File](#)
- [Discussion](#)

## Variants

## Views

- [Read](#)
- [View source](#)
- [View history](#)

## More

- This page was last edited on 27 July 2006, at 20:58.

- [Privacy policy](#)
- [About Win-Test Wiki](#)
- [Disclaimers](#)



# File:WindowsMult.gif

From Win-Test Wiki

[Jump to navigation](#) [Jump to search](#)

- [File](#)
- [File history](#)
- [File usage](#)

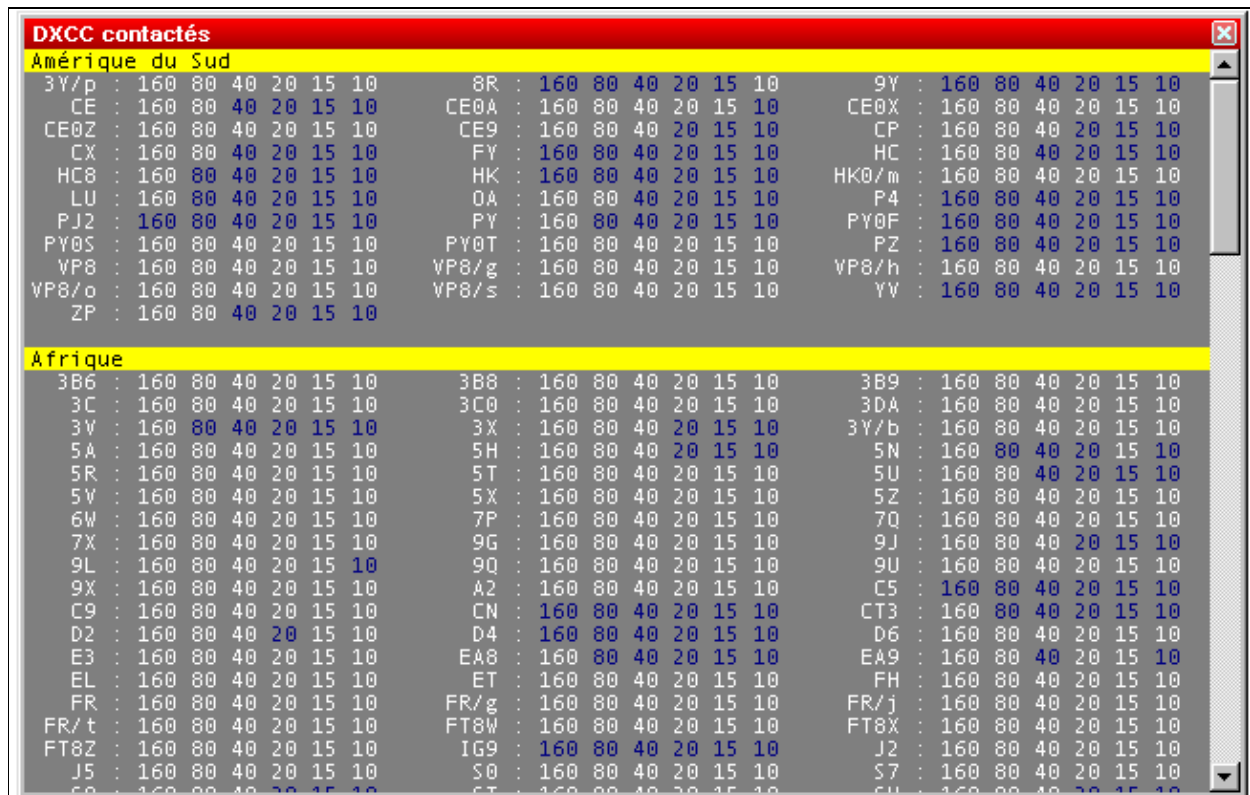

**DXCC contactés**

**Amérique du Sud**

3Y/p	: 160	80	40	20	15	10	8R	: 160	80	40	20	15	10	9Y	: 160	80	40	20	15	10
CE	: 160	80	40	20	15	10	CE0A	: 160	80	40	20	15	10	CE0X	: 160	80	40	20	15	10
CE0Z	: 160	80	40	20	15	10	CE9	: 160	80	40	20	15	10	CP	: 160	80	40	20	15	10
CX	: 160	80	40	20	15	10	FY	: 160	80	40	20	15	10	HC	: 160	80	40	20	15	10
HC8	: 160	80	40	20	15	10	HK	: 160	80	40	20	15	10	HK0/m	: 160	80	40	20	15	10
LU	: 160	80	40	20	15	10	OA	: 160	80	40	20	15	10	P4	: 160	80	40	20	15	10
PJ2	: 160	80	40	20	15	10	PY	: 160	80	40	20	15	10	PY0F	: 160	80	40	20	15	10
PY0S	: 160	80	40	20	15	10	PY0T	: 160	80	40	20	15	10	PZ	: 160	80	40	20	15	10
VP8	: 160	80	40	20	15	10	VP8/g	: 160	80	40	20	15	10	VP8/h	: 160	80	40	20	15	10
VP8/o	: 160	80	40	20	15	10	VP8/s	: 160	80	40	20	15	10	YV	: 160	80	40	20	15	10
ZP	: 160	80	40	20	15	10														

**Afrique**

3B6	: 160	80	40	20	15	10	3B8	: 160	80	40	20	15	10	3B9	: 160	80	40	20	15	10
3C	: 160	80	40	20	15	10	3C0	: 160	80	40	20	15	10	3DA	: 160	80	40	20	15	10
3V	: 160	80	40	20	15	10	3X	: 160	80	40	20	15	10	3Y/b	: 160	80	40	20	15	10
5A	: 160	80	40	20	15	10	5H	: 160	80	40	20	15	10	5N	: 160	80	40	20	15	10
5R	: 160	80	40	20	15	10	5T	: 160	80	40	20	15	10	5U	: 160	80	40	20	15	10
5V	: 160	80	40	20	15	10	5X	: 160	80	40	20	15	10	5Z	: 160	80	40	20	15	10
6W	: 160	80	40	20	15	10	7P	: 160	80	40	20	15	10	7Q	: 160	80	40	20	15	10
7X	: 160	80	40	20	15	10	9G	: 160	80	40	20	15	10	9J	: 160	80	40	20	15	10
9L	: 160	80	40	20	15	10	9Q	: 160	80	40	20	15	10	9U	: 160	80	40	20	15	10
9X	: 160	80	40	20	15	10	A2	: 160	80	40	20	15	10	C5	: 160	80	40	20	15	10
C9	: 160	80	40	20	15	10	CN	: 160	80	40	20	15	10	CT3	: 160	80	40	20	15	10
D2	: 160	80	40	20	15	10	D4	: 160	80	40	20	15	10	D6	: 160	80	40	20	15	10
E3	: 160	80	40	20	15	10	EA8	: 160	80	40	20	15	10	EA9	: 160	80	40	20	15	10
EL	: 160	80	40	20	15	10	ET	: 160	80	40	20	15	10	FH	: 160	80	40	20	15	10
FR	: 160	80	40	20	15	10	FR/g	: 160	80	40	20	15	10	FR/j	: 160	80	40	20	15	10
FR/t	: 160	80	40	20	15	10	FT8W	: 160	80	40	20	15	10	FT8X	: 160	80	40	20	15	10
FT8Z	: 160	80	40	20	15	10	IG9	: 160	80	40	20	15	10	J2	: 160	80	40	20	15	10
J5	: 160	80	40	20	15	10	S0	: 160	80	40	20	15	10	S7	: 160	80	40	20	15	10
60	: 160	80	40	20	15	10	6T	: 160	80	40	20	15	10	6U	: 160	80	40	20	15	10

No higher resolution available.

[WindowsMult.gif](#) (650 × 415 pixels, file size: 20 KB, MIME type: image/gif)

Worked DXCC countries window

## File history

Click on a date/time to view the file as it appeared at that time.

	Date/Time	Thumbnail	Dimensions	User	Comment
current	<a href="#">20:58, 27 July 2006</a>		650 × 415 (20 KB)	<a href="#">D16rai (talk   contribs)</a>	Worked DXCC countries window

You cannot overwrite this file.

## File usage

The following 2 pages use this file:

- [Menu:Windows](#)
- [Win-Test Wiki:Sandbox](#)

## Namespaces

- [File](#)
- [Discussion](#)

## Variants

## Views

- [Read](#)
- [View source](#)
- [View history](#)

## More

- This page was last edited on 27 July 2006, at 20:58.

- [Privacy policy](#)
- [About Win-Test Wiki](#)
- [Disclaimers](#)



# File:WindowsNcdxflbpBeacons.gif

From Win-Test Wiki

[Jump to navigation](#) [Jump to search](#)

- [File](#)
- [File history](#)
- [File usage](#)
- [Metadata](#)

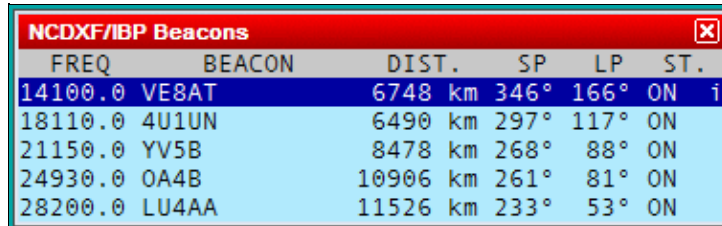

FREQ	BEACON	DIST.	SP	LP	ST.
14100.0	VE8AT	6748 km	346°	166°	ON i
18110.0	4U1UN	6490 km	297°	117°	ON
21150.0	YV5B	8478 km	268°	88°	ON
24930.0	OA4B	10906 km	261°	81°	ON
28200.0	LU4AA	11526 km	233°	53°	ON

No higher resolution available.

[WindowsNcdxflbpBeacons.gif](#) (377 Å 118 pixels, file size: 6 KB, MIME type: image.gif)

## File history

Click on a date/time to view the file as it appeared at that time.

	Date/Time	Thumbnail	Dimensions	User	Comment
current	<a href="#">14:53, 30 December 2021</a>		377 Å 118 (6 KB)	<a href="#">Dl6rai</a> ( <a href="#">talk</a>   <a href="#">contribs</a> )	

You cannot overwrite this file.

## File usage

The following page uses this file:

- [Menu:Windows](#)

## Metadata

This file contains additional information, probably added from the digital camera or scanner used to create or digitize it.

If the file has been modified from its original state, some details may not fully reflect the modified file.

**Horizontal resolution** 37.79 dpc

**Vertical resolution** 37.79 dpc

## Namespaces

- [File](#)
- [Discussion](#)

## Variants

## Views

- [Read](#)
- [View source](#)
- [View history](#)

## More

- This page was last edited on 30 December 2021, at 14:53.

- [Privacy policy](#)
- [About Win-Test Wiki](#)
- [Disclaimers](#)

- The logo for MediaWiki, featuring a sun icon and the text "Powered By MediaWiki".



# File:WindowsNcdxflbpBeacons.gif

From Win-Test Wiki

[Jump to navigation](#) [Jump to search](#)

- [File](#)
- [File history](#)
- [File usage](#)
- [Metadata](#)

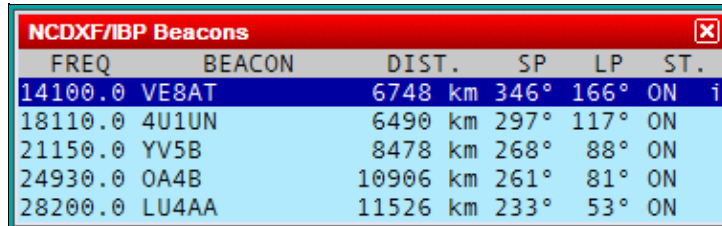

FREQ	BEACON	DIST.	SP	LP	ST.
14100.0	VE8AT	6748 km	346°	166°	ON i
18110.0	4U1UN	6490 km	297°	117°	ON
21150.0	YV5B	8478 km	268°	88°	ON
24930.0	OA4B	10906 km	261°	81°	ON
28200.0	LU4AA	11526 km	233°	53°	ON

No higher resolution available.

[WindowsNcdxflbpBeacons.gif](#) (377 Å 118 pixels, file size: 6 KB, MIME type: image.gif)

## File history

Click on a date/time to view the file as it appeared at that time.

	Date/Time	Thumbnail	Dimensions	User	Comment
current	<a href="#">14:53, 30 December 2021</a>		377 Å 118 (6 KB)	<a href="#">Dl6rai</a> ( <a href="#">talk</a>   <a href="#">contribs</a> )	

You cannot overwrite this file.

## File usage

The following page uses this file:

- [Menu:Windows](#)

## Metadata

This file contains additional information, probably added from the digital camera or scanner used to create or digitize it.

If the file has been modified from its original state, some details may not fully reflect the modified file.

**Horizontal resolution** 37.79 dpc

**Vertical resolution** 37.79 dpc

## Namespaces

- [File](#)
- [Discussion](#)

## Variants

## Views

- [Read](#)
- [View source](#)
- [View history](#)

## More

- This page was last edited on 30 December 2021, at 14:53.
- [Privacy policy](#)
- [About Win-Test Wiki](#)
- [Disclaimers](#)



# File:WindowsNp1 1.gif

From Win-Test Wiki

[Jump to navigation](#) [Jump to search](#)

- [File](#)
- [File history](#)
- [File usage](#)



No higher resolution available.

[WindowsNp1 1.gif](#) (465 × 102 pixels, file size: 3 KB, MIME type: image/gif)

N + 1 window (Captured called : W5TQ)

## File history

Click on a date/time to view the file as it appeared at that time.

	Date/Time	Thumbnail	Dimensions	User	Comment
current	<a href="#">21:14, 27 July 2006</a>		465 × 102 (3 KB)	<a href="#">Dl6rai (talk   contribs)</a>	N + 1 window (Captured called : W5TQ)

You cannot overwrite this file.

## File usage

The following 2 pages use this file:

- [Menu:Windows](#)
- [StyleSheet](#)

## Namespaces

- [File](#)
- [Discussion](#)

## Variants

## Views

- [Read](#)
- [View source](#)

- [View history](#)

## More

- This page was last edited on 27 July 2006, at 21:14.

- [Privacy policy](#)
- [About Win-Test Wiki](#)
- [Disclaimers](#)



# File:WindowsNp1 1.gif

From Win-Test Wiki

[Jump to navigation](#) [Jump to search](#)

- [File](#)
- [File history](#)
- [File usage](#)



No higher resolution available.

[WindowsNp1 1.gif](#) (465 × 102 pixels, file size: 3 KB, MIME type: image/gif)

N + 1 window (Captured called : W5TQ)

## File history

Click on a date/time to view the file as it appeared at that time.

	Date/Time	Thumbnail	Dimensions	User	Comment
current	<a href="#">21:14, 27 July 2006</a>		465 × 102 (3 KB)	<a href="#">Dl6rai (talk   contribs)</a>	N + 1 window (Captured called : W5TQ)

You cannot overwrite this file.

## File usage

The following 2 pages use this file:

- [Menu:Windows](#)
- [StyleSheet](#)

## Namespaces

- [File](#)
- [Discussion](#)

## Variants

## Views

- [Read](#)
- [View source](#)

- [View history](#)

## More

- This page was last edited on 27 July 2006, at 21:14.

- [Privacy policy](#)
- [About Win-Test Wiki](#)
- [Disclaimers](#)



# File:WindowsNp1 2.gif

From Win-Test Wiki

[Jump to navigation](#) [Jump to search](#)

- [File](#)
- [File history](#)
- [File usage](#)



No higher resolution available.

[WindowsNp1 2.gif](#) (465 × 102 pixels, file size: 3 KB, MIME type: image/gif)

N + 1 window (Captured call : K3OK)

## File history

Click on a date/time to view the file as it appeared at that time.

	Date/Time	Thumbnail	Dimensions	User	Comment
current	<a href="#">21:14, 27 July 2006</a>		465 × 102 (3 KB)	<a href="#">D16rai (talk   contribs)</a>	N + 1 window (Captured call : K3OK)

You cannot overwrite this file.

## File usage

The following page uses this file:

- [Menu:Windows](#)

## Namespaces

- [File](#)
- [Discussion](#)

## Variants

## Views

- [Read](#)
- [View source](#)
- [View history](#)

## More

- This page was last edited on 27 July 2006, at 21:14.

- [Privacy policy](#)
- [About Win-Test Wiki](#)
- [Disclaimers](#)





# File:WindowsNp1 2.gif

From Win-Test Wiki

[Jump to navigation](#) [Jump to search](#)

- [File](#)
- [File history](#)
- [File usage](#)



No higher resolution available.

[WindowsNp1 2.gif](#) (465 × 102 pixels, file size: 3 KB, MIME type: image/gif)

N + 1 window (Captured call : K3OK)

## File history

Click on a date/time to view the file as it appeared at that time.

	Date/Time	Thumbnail	Dimensions	User	Comment
current	<a href="#">21:14, 27 July 2006</a>		465 × 102 (3 KB)	<a href="#">D16rai (talk   contribs)</a>	N + 1 window (Captured call : K3OK)

You cannot overwrite this file.

## File usage

The following page uses this file:

- [Menu:Windows](#)

## Namespaces

- [File](#)
- [Discussion](#)

## Variants

## Views

- [Read](#)
- [View source](#)
- [View history](#)

## More

- This page was last edited on 27 July 2006, at 21:14.

- [Privacy policy](#)
- [About Win-Test Wiki](#)
- [Disclaimers](#)



# File:WindowsNp1 3.gif

From Win-Test Wiki

[Jump to navigation](#) [Jump to search](#)

- [File](#)
- [File history](#)
- [File usage](#)

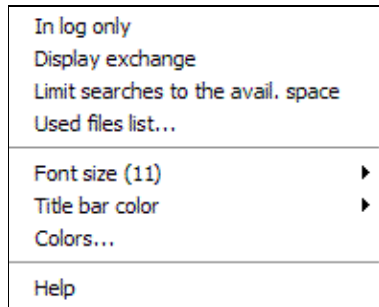



No higher resolution available.

[WindowsNp1 3.gif](#) (196 × 158 pixels, file size: 3 KB, MIME type: image/gif)

## File history

Click on a date/time to view the file as it appeared at that time.

	Date/Time	Thumbnail	Dimensions	User	Comment
current	<a href="#">00:01, 19 July 2008</a>		196 × 158 (3 KB)	<a href="#">N6TV (talk   contribs)</a>	New context menu for Check Partial N+1 including "Used files list" option
	<a href="#">22:30, 15 September 2006</a>		203 × 143 (1 KB)	<a href="#">Dl6rai (talk   contribs)</a>	

You cannot overwrite this file.

## File usage

The following page uses this file:

- [Menu:Windows](#)

## Namespaces

- [File](#)
- [Discussion](#)

## Variants

## Views

- [Read](#)
- [View source](#)
- [View history](#)

## More

- This page was last edited on 15 September 2006, at 22:30.
- [Privacy policy](#)
- [About Win-Test Wiki](#)
- [Disclaimers](#)



# File:WindowsNp1 3.gif

From Win-Test Wiki

[Jump to navigation](#) [Jump to search](#)

- [File](#)
- [File history](#)
- [File usage](#)

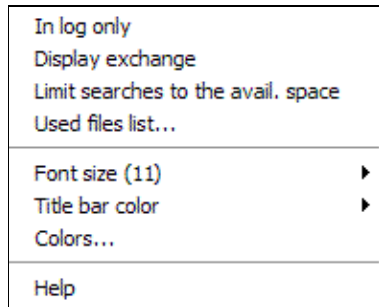



No higher resolution available.

[WindowsNp1 3.gif](#) (196 × 158 pixels, file size: 3 KB, MIME type: image/gif)

## File history

Click on a date/time to view the file as it appeared at that time.

	Date/Time	Thumbnail	Dimensions	User	Comment
current	<a href="#">00:01, 19 July 2008</a>		196 × 158 (3 KB)	<a href="#">N6TV (talk   contribs)</a>	New context menu for Check Partial N+1 including "Used files list" option
	<a href="#">22:30, 15 September 2006</a>		203 × 143 (1 KB)	<a href="#">Dl6rai (talk   contribs)</a>	

You cannot overwrite this file.

## File usage

The following page uses this file:

- [Menu:Windows](#)

## Namespaces

- [File](#)
- [Discussion](#)

## Variants

## Views

- [Read](#)
- [View source](#)
- [View history](#)

## More

- This page was last edited on 15 September 2006, at 22:30.

- [Privacy policy](#)
- [About Win-Test Wiki](#)
- [Disclaimers](#)



# File:WindowsPacket.gif

From Win-Test Wiki

[Jump to navigation](#) [Jump to search](#)

- [File](#)
- [File history](#)
- [File usage](#)

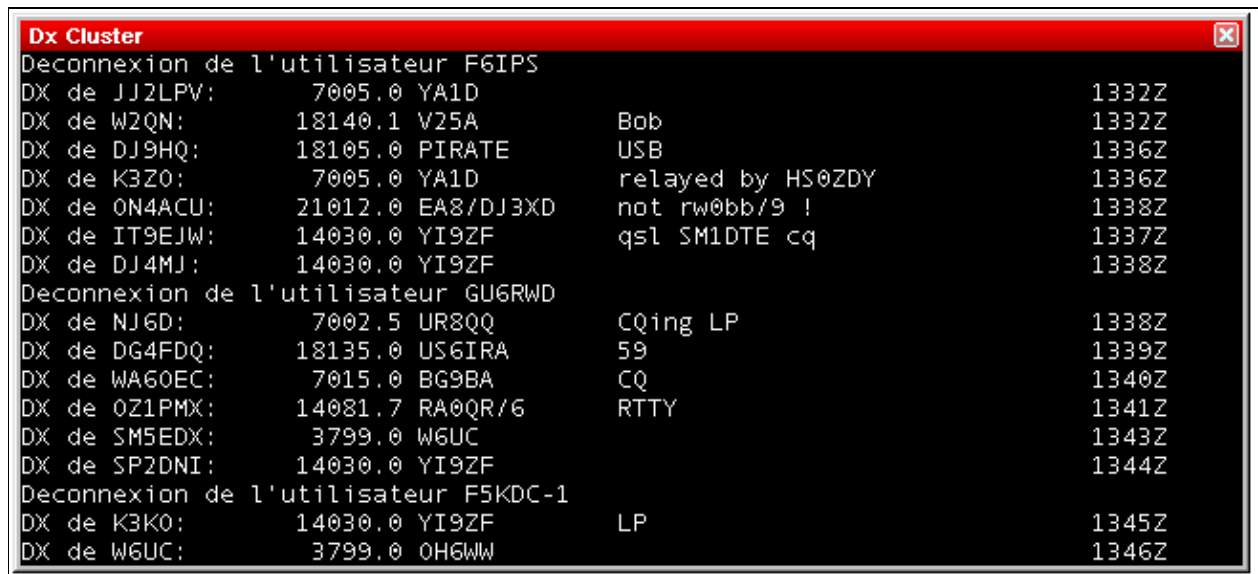

No higher resolution available.

[WindowsPacket.gif](#) (653 × 298 pixels, file size: 10 KB, MIME type: image/gif)

DX Cluster monitoring window

## File history

Click on a date/time to view the file as it appeared at that time.

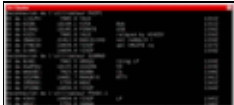
	Date/Time	Thumbnail	Dimensions	User	Comment
current	<a href="#">21:50, 27 July 2006</a>		653 × 298 (10 KB)	<a href="#">Dl6rai</a> ( <a href="#">talk</a>   <a href="#">contribs</a> )	DX Cluster monitoring window

You cannot overwrite this file.

## File usage

The following page uses this file:

- [Menu:Windows](#)

## Namespaces

- [File](#)
- [Discussion](#)

## Variants

## Views

- [Read](#)
- [View source](#)
- [View history](#)

## More

- This page was last edited on 27 July 2006, at 21:50.
- [Privacy policy](#)
- [About Win-Test Wiki](#)
- [Disclaimers](#)





# File:WindowsPacket.gif

From Win-Test Wiki

[Jump to navigation](#) [Jump to search](#)

- [File](#)
- [File history](#)
- [File usage](#)

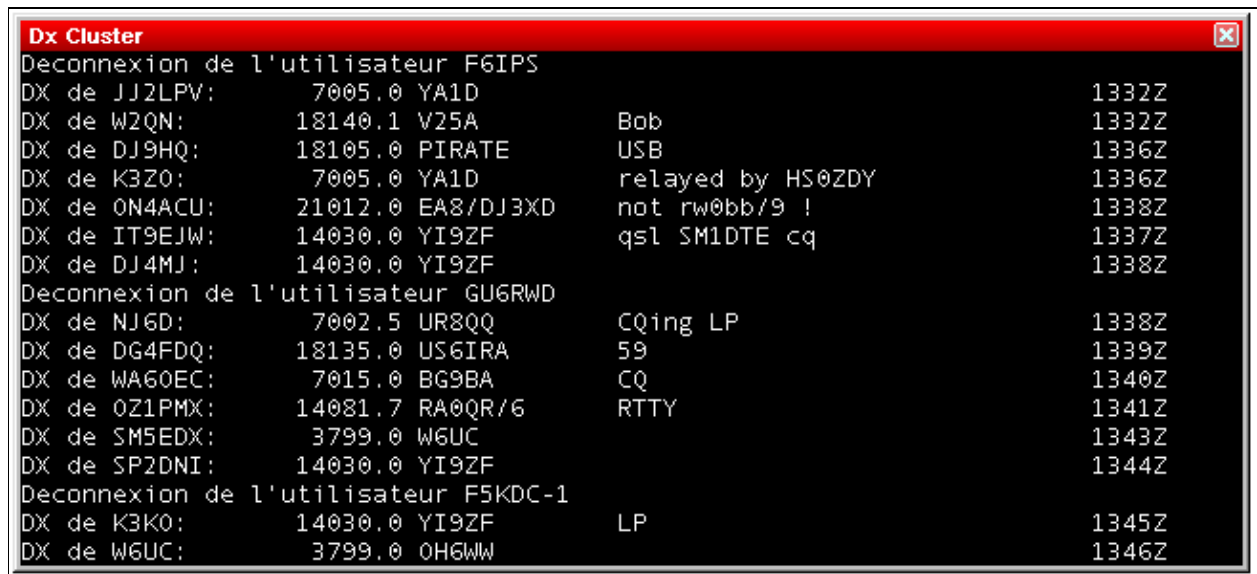

No higher resolution available.

[WindowsPacket.gif](#) (653 × 298 pixels, file size: 10 KB, MIME type: image/gif)

DX Cluster monitoring window

## File history

Click on a date/time to view the file as it appeared at that time.

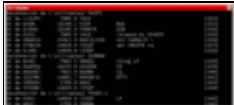
	Date/Time	Thumbnail	Dimensions	User	Comment
current	<a href="#">21:50, 27 July 2006</a>		653 × 298 (10 KB)	<a href="#">Dl6rai (talk   contribs)</a>	DX Cluster monitoring window

You cannot overwrite this file.

## File usage

The following page uses this file:

- [Menu:Windows](#)

## Namespaces

- [File](#)
- [Discussion](#)

## Variants

## Views

- [Read](#)
- [View source](#)
- [View history](#)

## More

- This page was last edited on 27 July 2006, at 21:50.
- [Privacy policy](#)
- [About Win-Test Wiki](#)
- [Disclaimers](#)



# File:WindowsPartnerWindowProperties.PNG

From Win-Test Wiki

[Jump to navigation](#) [Jump to search](#)

- [File](#)
- [File history](#)
- [File usage](#)
- [Metadata](#)

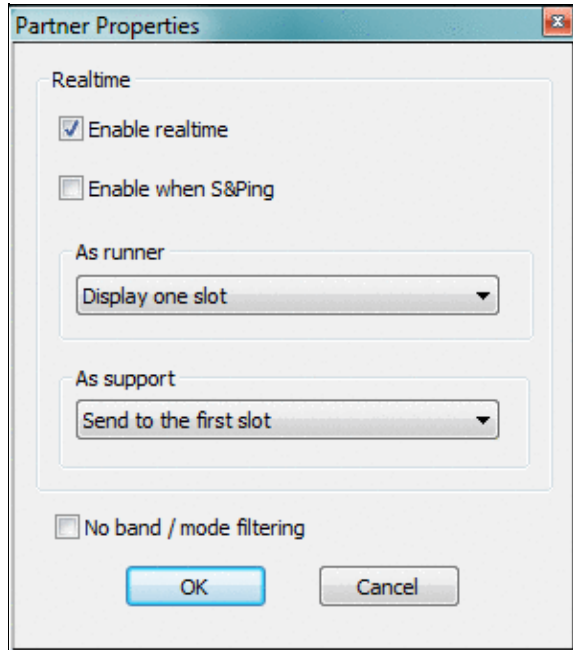

No higher resolution available.

[WindowsPartnerWindowProperties.PNG](#) (297 × 339 pixels, file size: 13 KB, MIME type: image.gif)

## File history

Click on a date/time to view the file as it appeared at that time.

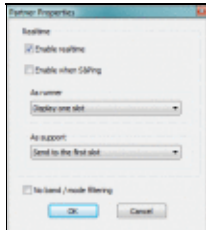
	Date/Time	Thumbnail	Dimensions	User	Comment
current	<a href="#">13:34, 17 December 2016</a>		297 × 339 (13 KB)	<a href="#">Dl6rai</a> ( <a href="#">talk</a>   <a href="#">contribs</a> )	

Date/Time	Thumbnail	Dimensions	User	Comment
You cannot overwrite this file.				

## File usage

The following page uses this file:

- [Menu:Windows](#)

## Metadata

This file contains additional information, probably added from the digital camera or scanner used to create or digitize it.

If the file has been modified from its original state, some details may not fully reflect the modified file.

**Horizontal resolution** 37.79 dpc

**Vertical resolution** 37.79 dpc

## Namespaces

- [File](#)
- [Discussion](#)

## Variants

## Views

- [Read](#)
- [View source](#)
- [View history](#)

## More

- This page was last edited on 17 December 2016, at 13:34.

- [Privacy policy](#)
- [About Win-Test Wiki](#)
- [Disclaimers](#)



# File:WindowsPartnerWindowProperties.PNG

From Win-Test Wiki

[Jump to navigation](#) [Jump to search](#)

- [File](#)
- [File history](#)
- [File usage](#)
- [Metadata](#)

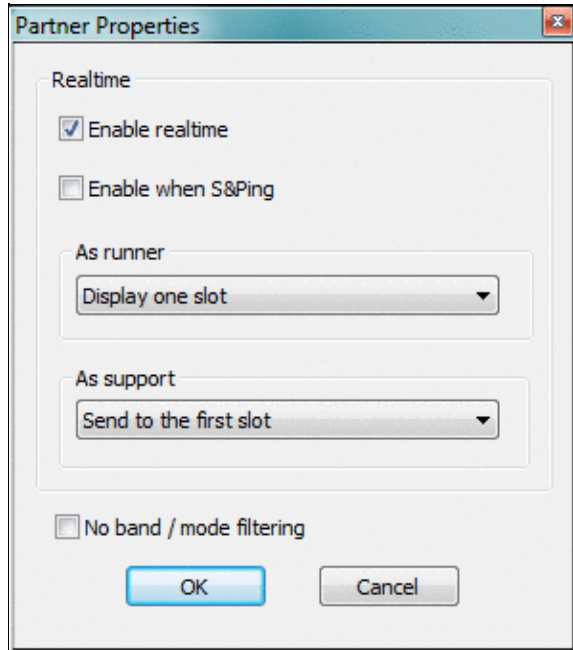

No higher resolution available.

[WindowsPartnerWindowProperties.PNG](#) (297 × 339 pixels, file size: 13 KB, MIME type: image.gif)

## File history

Click on a date/time to view the file as it appeared at that time.

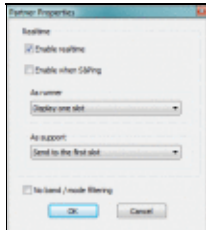
	Date/Time	Thumbnail	Dimensions	User	Comment
current	<a href="#">13:34, 17 December 2016</a>		297 × 339 (13 KB)	<a href="#">Dl6rai</a> ( <a href="#">talk</a>   <a href="#">contribs</a> )	

Date/Time	Thumbnail	Dimensions	User	Comment
You cannot overwrite this file.				

## File usage

The following page uses this file:

- [Menu:Windows](#)

## Metadata

This file contains additional information, probably added from the digital camera or scanner used to create or digitize it.

If the file has been modified from its original state, some details may not fully reflect the modified file.

**Horizontal resolution** 37.79 dpc

**Vertical resolution** 37.79 dpc

## Namespaces

- [File](#)
- [Discussion](#)

## Variants

## Views

- [Read](#)
- [View source](#)
- [View history](#)

## More

- This page was last edited on 17 December 2016, at 13:34.

- [Privacy policy](#)
- [About Win-Test Wiki](#)
- [Disclaimers](#)



# File:WindowsPartnerWindowRealtimefeature.PNG

From Win-Test Wiki

[Jump to navigation](#) [Jump to search](#)

- [File](#)
- [File history](#)
- [File usage](#)
- [Metadata](#)

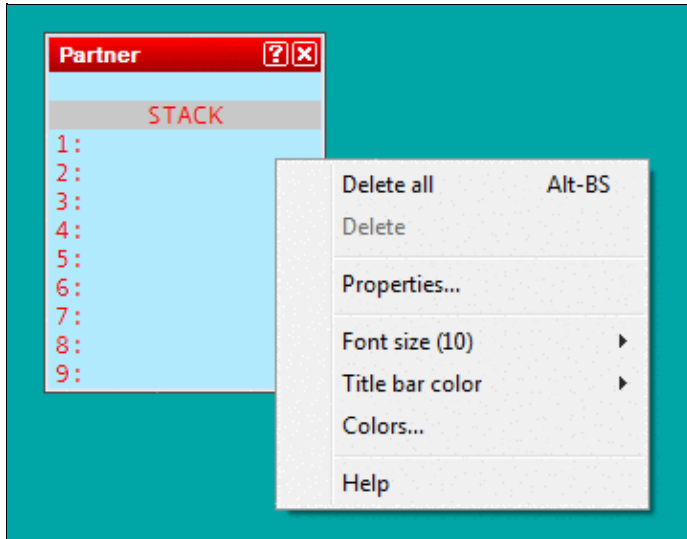

No higher resolution available.

[WindowsPartnerWindowRealtimefeature.PNG](#) (358 × 280 pixels, file size: 6 KB, MIME type: image/gif)

## File history

Click on a date/time to view the file as it appeared at that time.

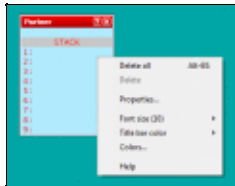
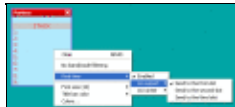
	Date/Time	Thumbnail	Dimensions	User	Comment
current	<a href="#">13:30, 17 December 2016</a>		358 × 280 (6 KB)	<a href="#">Dl6rai</a> ( <a href="#">talk</a>   <a href="#">contribs</a> )	
	<a href="#">12:01, 21 January 2007</a>		552 × 259 (8 KB)	<a href="#">Dl6rai</a> ( <a href="#">talk</a>   <a href="#">contribs</a> )	

You cannot overwrite this file.

## File usage

The following page uses this file:

- [Menu:Windows](#)

## Metadata

This file contains additional information, probably added from the digital camera or scanner used to create or digitize it.

If the file has been modified from its original state, some details may not fully reflect the modified file.

**Horizontal resolution** 37.79 dpc

**Vertical resolution** 37.79 dpc

## Namespaces

- [File](#)
- [Discussion](#)

## Variants

## Views

- [Read](#)
- [View source](#)
- [View history](#)

## More

- This page was last edited on 17 December 2016, at 13:30.

- [Privacy policy](#)
- [About Win-Test Wiki](#)
- [Disclaimers](#)





# File:WindowsPartnerWindowRealtimefeature.PNG

From Win-Test Wiki

[Jump to navigation](#) [Jump to search](#)

- [File](#)
- [File history](#)
- [File usage](#)
- [Metadata](#)

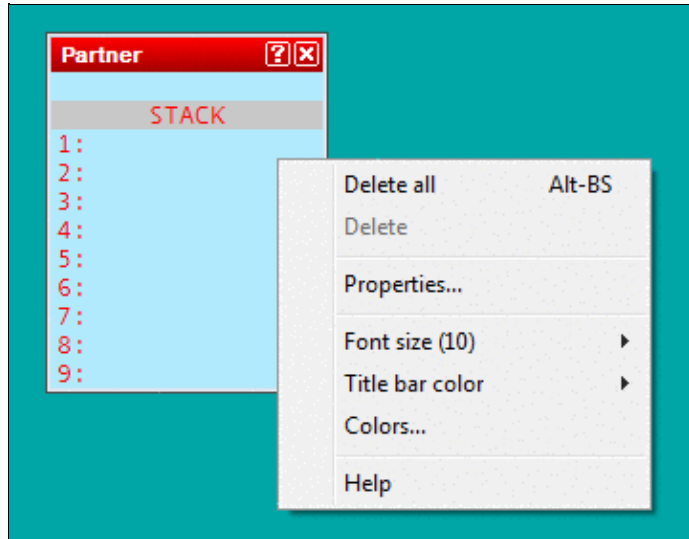

No higher resolution available.

[WindowsPartnerWindowRealtimefeature.PNG](#) (358 × 280 pixels, file size: 6 KB, MIME type: image/gif)

## File history

Click on a date/time to view the file as it appeared at that time.

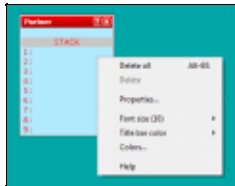
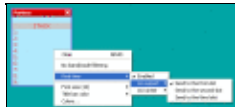
	Date/Time	Thumbnail	Dimensions	User	Comment
current	<a href="#">13:30, 17 December 2016</a>		358 × 280 (6 KB)	<a href="#">Dl6rai</a> ( <a href="#">talk</a>   <a href="#">contribs</a> )	
	<a href="#">12:01, 21 January 2007</a>		552 × 259 (8 KB)	<a href="#">Dl6rai</a> ( <a href="#">talk</a>   <a href="#">contribs</a> )	

You cannot overwrite this file.

## File usage

The following page uses this file:

File:WindowsPartnerWindowRealtimefeature.PNG

1981

- [Menu:Windows](#)

## Metadata

This file contains additional information, probably added from the digital camera or scanner used to create or digitize it.

If the file has been modified from its original state, some details may not fully reflect the modified file.

**Horizontal resolution** 37.79 dpc

**Vertical resolution** 37.79 dpc

## Namespaces

- [File](#)
- [Discussion](#)

## Variants

## Views

- [Read](#)
- [View source](#)
- [View history](#)

## More

- This page was last edited on 17 December 2016, at 13:30.

- [Privacy policy](#)
- [About Win-Test Wiki](#)
- [Disclaimers](#)



# File:WindowsQsyWizard.gif

From Win-Test Wiki

[Jump to navigation](#) [Jump to search](#)

- [File](#)
- [File history](#)
- [File usage](#)



No higher resolution available.

[WindowsQsyWizard.gif](#) (105 × 117 pixels, file size: 1 KB, MIME type: image.gif)

## File history

Click on a date/time to view the file as it appeared at that time.

Date/Time	Thumbnail	Dimensions	User	Comment
current <a href="#">21:47, 30 August 2006</a>		105 × 117 (1 KB)	<a href="#">DL4NER</a> ( <a href="#">talk</a>   <a href="#">contribs</a> )	

You cannot overwrite this file.

## File usage

The following page uses this file:

- [Menu:Windows](#)

## Namespaces

- [File](#)
- [Discussion](#)

## Variants

## Views

- [Read](#)
- [View source](#)
- [View history](#)

## More

- This page was last edited on 30 August 2006, at 21:47.

- [Privacy policy](#)
- [About Win-Test Wiki](#)
- [Disclaimers](#)



# File:WindowsQsyWizard.gif

From Win-Test Wiki

[Jump to navigation](#) [Jump to search](#)

- [File](#)
- [File history](#)
- [File usage](#)



No higher resolution available.

[WindowsQsyWizard.gif](#) (105 × 117 pixels, file size: 1 KB, MIME type: image.gif)

## File history

Click on a date/time to view the file as it appeared at that time.

Date/Time	Thumbnail	Dimensions	User	Comment
current <a href="#">21:47, 30 August 2006</a>		105 × 117 (1 KB)	<a href="#">DL4NER</a> ( <a href="#">talk</a>   <a href="#">contribs</a> )	

You cannot overwrite this file.

## File usage

The following page uses this file:

- [Menu:Windows](#)

## Namespaces

- [File](#)
- [Discussion](#)

## Variants

## Views

- [Read](#)
- [View source](#)
- [View history](#)

## More

- This page was last edited on 30 August 2006, at 21:47.

- [Privacy policy](#)
- [About Win-Test Wiki](#)
- [Disclaimers](#)



# File:WindowsRadio.gif

From Win-Test Wiki

[Jump to navigation](#) [Jump to search](#)

- [File](#)
- [File history](#)
- [File usage](#)

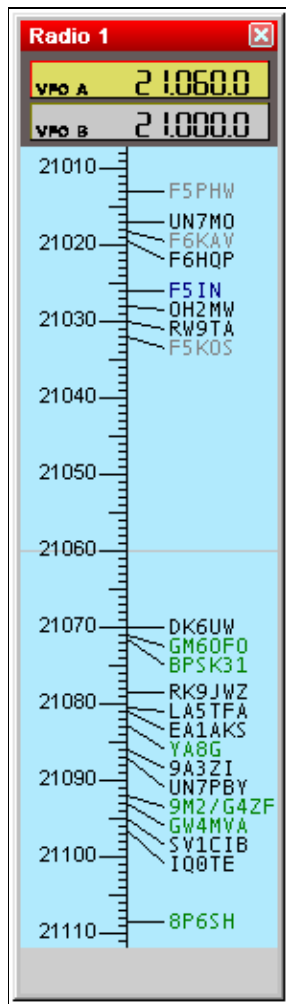

No higher resolution available.

WindowsRadio.gif (147 × 523 pixels, file size: 7 KB, MIME type: image/gif)

Radio window (band map)

## File history

Click on a date/time to view the file as it appeared at that time.

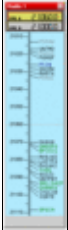
	Date/Time	Thumbnail	Dimensions	User	Comment
current	<a href="#">21:46, 27 July 2006</a>		147 × 523 (7 KB)	<a href="#">Dl6rai</a> ( <a href="#">talk</a>   <a href="#">contribs</a> )	Radio window (band map)

You cannot overwrite this file.

## File usage

The following page uses this file:

- [Menu:Windows](#)

## Namespaces

- [File](#)
- [Discussion](#)

## Variants

## Views

- [Read](#)
- [View source](#)
- [View history](#)

## More

- This page was last edited on 27 July 2006, at 21:46.

- [Privacy policy](#)
- [About Win-Test Wiki](#)
- [Disclaimers](#)





# File:WindowsRadio.gif

From Win-Test Wiki

[Jump to navigation](#) [Jump to search](#)

- [File](#)
- [File history](#)
- [File usage](#)

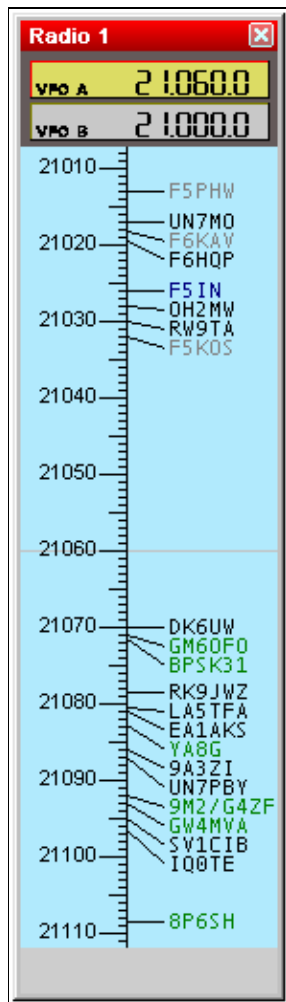

No higher resolution available.

[WindowsRadio.gif](#) (147 × 523 pixels, file size: 7 KB, MIME type: image/gif)

Radio window (band map)

## File history

Click on a date/time to view the file as it appeared at that time.

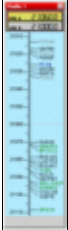
	Date/Time	Thumbnail	Dimensions	User	Comment
current	<a href="#">21:46, 27 July 2006</a>		147 × 523 (7 KB)	<a href="#">Dl6rai</a> ( <a href="#">talk</a>   <a href="#">contribs</a> )	Radio window (band map)

You cannot overwrite this file.

## File usage

The following page uses this file:

- [Menu:Windows](#)

## Namespaces

- [File](#)
- [Discussion](#)

## Variants

## Views

- [Read](#)
- [View source](#)
- [View history](#)

## More

- This page was last edited on 27 July 2006, at 21:46.

- [Privacy policy](#)
- [About Win-Test Wiki](#)
- [Disclaimers](#)



# File:WindowsRate.PNG

From Win-Test Wiki

[Jump to navigation](#) [Jump to search](#)

- [File](#)
- [File history](#)
- [File usage](#)

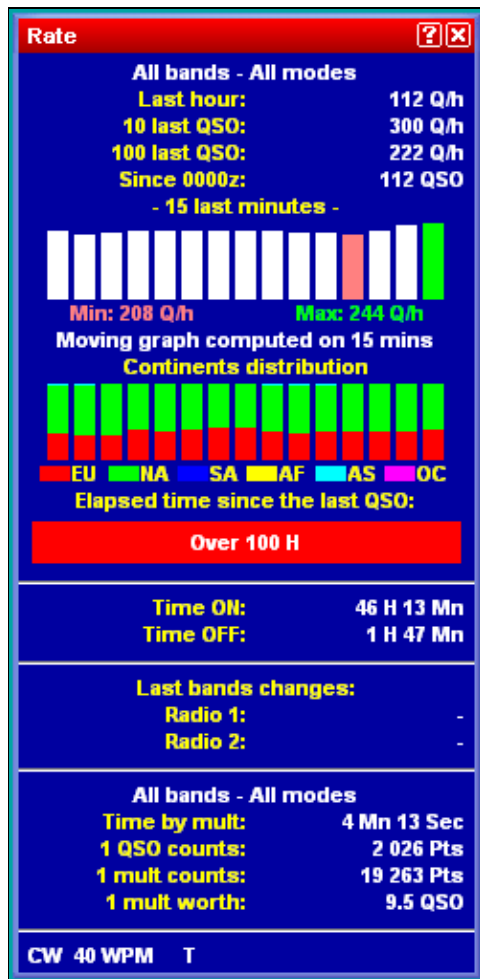

No higher resolution available.

WindowsRate.PNG (249 × 510 pixels, file size: 14 KB, MIME type: image.gif)

## File history

Click on a date/time to view the file as it appeared at that time.

	Date/Time	Thumbnail	Dimensions	User	Comment
current	<u>11:45, 20 November 2006</u>		249 × 510 (14 KB)	<u>Ct1boh</u> ( <a href="#">talk</a>   <a href="#">contribs</a> )	

You cannot overwrite this file.

## File usage

The following page uses this file:

- [Menu:Windows](#)

## Namespaces

- [File](#)
- [Discussion](#)

## Variants

## Views

- [Read](#)
- [View source](#)
- [View history](#)

## More

- This page was last edited on 20 November 2006, at 11:45.
- [Privacy policy](#)
- [About Win-Test Wiki](#)
- [Disclaimers](#)



# File:WindowsRate.PNG

From Win-Test Wiki

[Jump to navigation](#) [Jump to search](#)

- [File](#)
- [File history](#)
- [File usage](#)

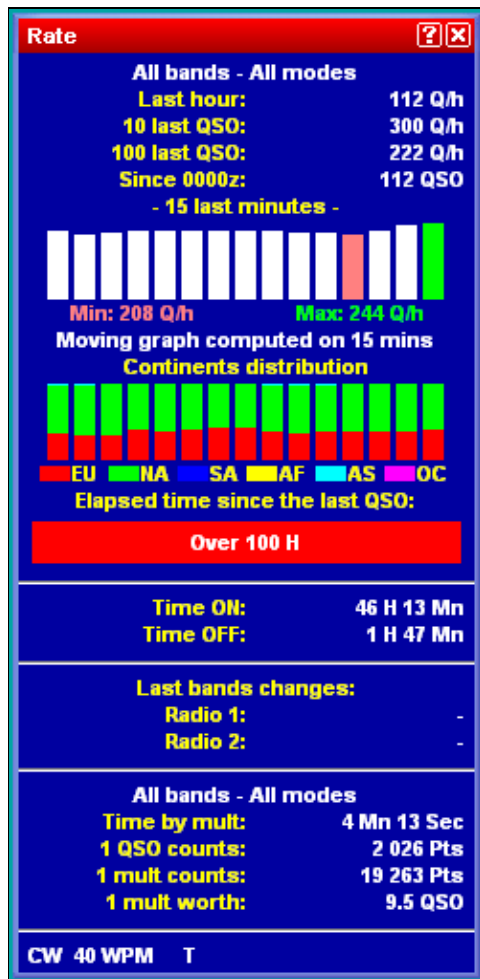

No higher resolution available.

WindowsRate.PNG (249 × 510 pixels, file size: 14 KB, MIME type: image.gif)

## File history

Click on a date/time to view the file as it appeared at that time.

	Date/Time	Thumbnail	Dimensions	User	Comment
current	<u>11:45, 20 November 2006</u>		249 × 510 (14 KB)	<u>Ct1boh</u> ( <a href="#">talk</a>   <a href="#">contribs</a> )	

You cannot overwrite this file.

## File usage

The following page uses this file:

- [Menu:Windows](#)

## Namespaces

- [File](#)
- [Discussion](#)

## Variants

## Views

- [Read](#)
- [View source](#)
- [View history](#)

## More

- This page was last edited on 20 November 2006, at 11:45.
- [Privacy policy](#)
- [About Win-Test Wiki](#)
- [Disclaimers](#)



# File:WindowsRateSheet.gif

From Win-Test Wiki

[Jump to navigation](#) [Jump to search](#)

- [File](#)
- [File history](#)
- [File usage](#)

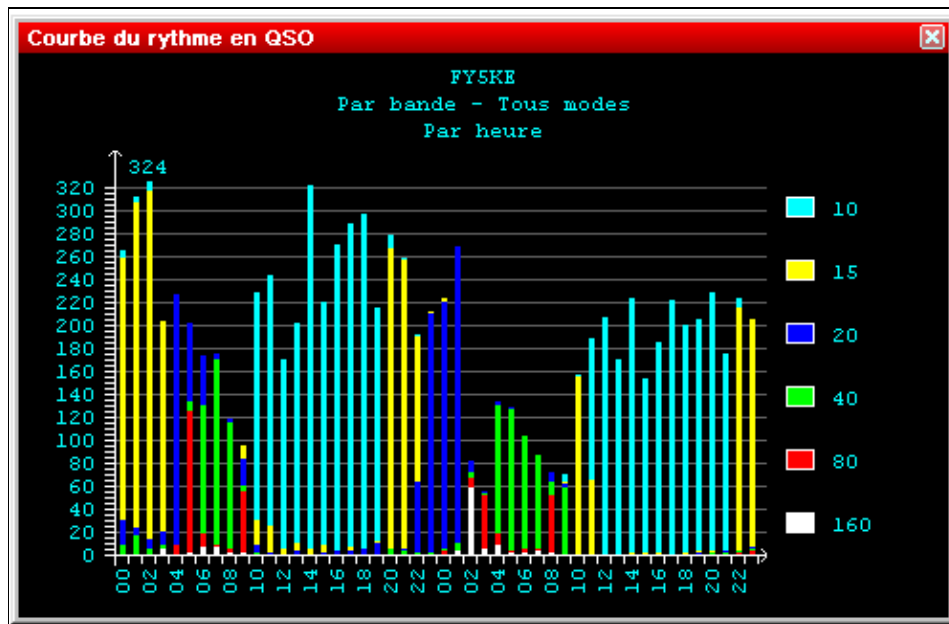

No higher resolution available.

[WindowsRateSheet.gif](#) (498 × 324 pixels, file size: 11 KB, MIME type: image/gif)

Rate Sheet

## File history

Click on a date/time to view the file as it appeared at that time.

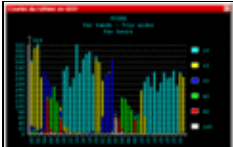
Date/Time	Thumbnail	Dimensions	User	Comment
current <a href="#">21:36, 27 July 2006</a>		498 × 324 (11 KB)	<a href="#">Dl6rai</a> ( <a href="#">talk</a>   <a href="#">contribs</a> )	Rate Sheet

You cannot overwrite this file.

## File usage

The following page uses this file:

- [Menu:Windows](#)

## Namespaces

- [File](#)
- [Discussion](#)

## Variants

## Views

- [Read](#)
- [View source](#)
- [View history](#)

## More

- This page was last edited on 27 July 2006, at 21:36.

- [Privacy policy](#)
- [About Win-Test Wiki](#)
- [Disclaimers](#)





# File:WindowsRateSheet.gif

From Win-Test Wiki

[Jump to navigation](#) [Jump to search](#)

- [File](#)
- [File history](#)
- [File usage](#)

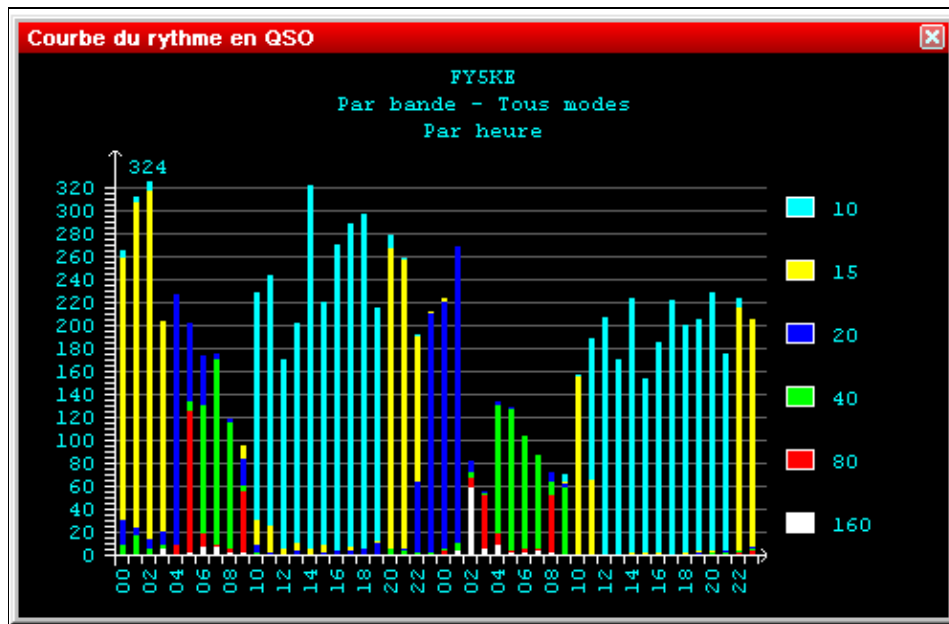

No higher resolution available.

[WindowsRateSheet.gif](#) (498 Å 324 pixels, file size: 11 KB, MIME type: image/gif)

Rate Sheet

## File history

Click on a date/time to view the file as it appeared at that time.

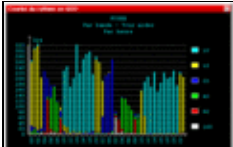
Date/Time	Thumbnail	Dimensions	User	Comment
current <a href="#">21:36, 27 July 2006</a>		498 Å 324 (11 KB)	<a href="#">Dl6rai</a> ( <a href="#">talk</a>   <a href="#">contribs</a> )	Rate Sheet

You cannot overwrite this file.

## File usage

The following page uses this file:

- [Menu:Windows](#)

## Namespaces

- [File](#)
- [Discussion](#)

## Variants

## Views

- [Read](#)
- [View source](#)
- [View history](#)

## More

- This page was last edited on 27 July 2006, at 21:36.

- [Privacy policy](#)
- [About Win-Test Wiki](#)
- [Disclaimers](#)



# File:WindowsRotators.PNG

From Win-Test Wiki

[Jump to navigation](#) [Jump to search](#)

- [File](#)
- [File history](#)
- [File usage](#)

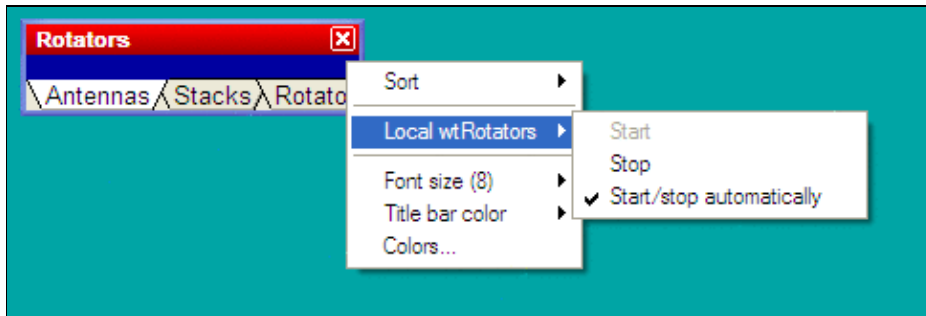

No higher resolution available.

[WindowsRotators.PNG](#) (486 × 162 pixels, file size: 7 KB, MIME type: image.gif)

Rotators window with pop-up menu, new in V4

## File history

Click on a date/time to view the file as it appeared at that time.

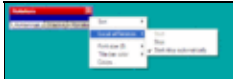
	Date/Time	Thumbnail	Dimensions	User	Comment
current	<a href="#">04:42, 26 July 2009</a>		486 × 162 (7 KB)	<a href="#">N6TV</a> ( <a href="#">talk</a>   <a href="#">contribs</a> )	Rotators window with pop-up menu, new in V4

You cannot overwrite this file.

## File usage

The following page uses this file:

- [Menu:Windows](#)

## Namespaces

- [File](#)
- [Discussion](#)

## Variants

## Views

- [Read](#)
- [View source](#)
- [View history](#)

## More

- This page was last edited on 26 July 2009, at 04:42.

- [Privacy policy](#)
- [About Win-Test Wiki](#)
- [Disclaimers](#)



# File:WindowsRotatorsConnected.PNG

From Win-Test Wiki

[Jump to navigation](#) [Jump to search](#)

- [File](#)
- [File history](#)
- [File usage](#)
- [Metadata](#)

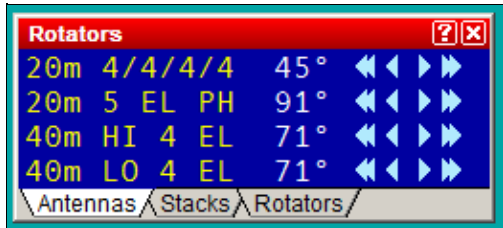

No higher resolution available.

[WindowsRotatorsConnected.PNG](#) (261 × 118 pixels, file size: 5 KB, MIME type: image.gif)

The Rotators window with 4 rotators visible on the two current operating bands

## File history

Click on a date/time to view the file as it appeared at that time.

	Date/Time	Thumbnail	Dimensions	User	Comment
current	<a href="#">06:32, 19 February 2016</a>		261 × 118 (5 KB)	<a href="#">N6TV (talk   contribs)</a>	The Rotators window with 4 rotators visible on the two current operating bands

You cannot overwrite this file.

## File usage

The following page uses this file:

- [Menu:Windows](#)

## Metadata

This file contains additional information, probably added from the digital camera or scanner used to create or digitize it.

If the file has been modified from its original state, some details may not fully reflect the modified file.

**Horizontal resolution** 37.79 dpc

**Vertical resolution** 37.79 dpc

Horizontal resolution 37.79 dpc

## Namespaces

- [File](#)
- [Discussion](#)

## Variants

## Views

- [Read](#)
- [View source](#)
- [View history](#)

## More

- This page was last edited on 19 February 2016, at 06:32.
- [Privacy policy](#)
- [About Win-Test Wiki](#)
- [Disclaimers](#)



# File:WindowsRotatorsConnected.PNG

From Win-Test Wiki

[Jump to navigation](#) [Jump to search](#)

- [File](#)
- [File history](#)
- [File usage](#)
- [Metadata](#)

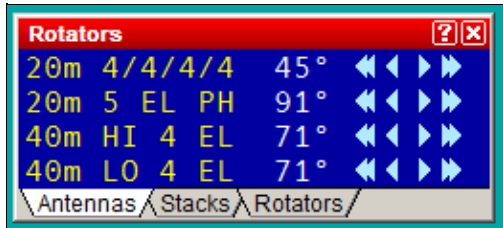

No higher resolution available.

[WindowsRotatorsConnected.PNG](#) (261 × 118 pixels, file size: 5 KB, MIME type: image.gif)

The Rotators window with 4 rotators visible on the two current operating bands

## File history

Click on a date/time to view the file as it appeared at that time.

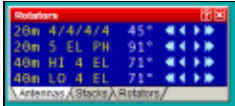
	Date/Time	Thumbnail	Dimensions	User	Comment
current	<a href="#">06:32, 19 February 2016</a>		261 × 118 (5 KB)	<a href="#">N6TV (talk   contribs)</a>	The Rotators window with 4 rotators visible on the two current operating bands

You cannot overwrite this file.

## File usage

The following page uses this file:

- [Menu:Windows](#)

## Metadata

This file contains additional information, probably added from the digital camera or scanner used to create or digitize it.

If the file has been modified from its original state, some details may not fully reflect the modified file.

**Horizontal resolution** 37.79 dpc

**Vertical resolution** 37.79 dpc

Horizontal resolution 37.79 dpc

## Namespaces

- [File](#)
- [Discussion](#)

## Variants

## Views

- [Read](#)
- [View source](#)
- [View history](#)

## More

- This page was last edited on 19 February 2016, at 06:32.
- [Privacy policy](#)
- [About Win-Test Wiki](#)
- [Disclaimers](#)





# File:WindowsRotators.PNG

From Win-Test Wiki

[Jump to navigation](#) [Jump to search](#)

- [File](#)
- [File history](#)
- [File usage](#)

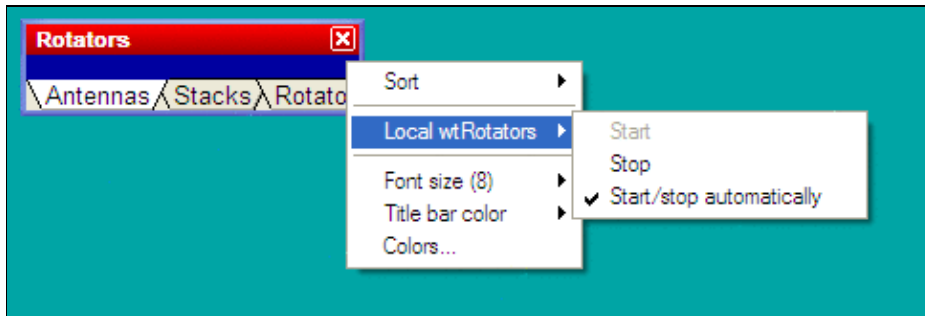

No higher resolution available.

[WindowsRotators.PNG](#) (486 × 162 pixels, file size: 7 KB, MIME type: image.gif)

Rotators window with pop-up menu, new in V4

## File history

Click on a date/time to view the file as it appeared at that time.

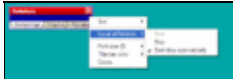
	Date/Time	Thumbnail	Dimensions	User	Comment
current	<a href="#">04:42, 26 July 2009</a>		486 × 162 (7 KB)	<a href="#">N6TV</a> ( <a href="#">talk</a>   <a href="#">contribs</a> )	Rotators window with pop-up menu, new in V4

You cannot overwrite this file.

## File usage

The following page uses this file:

- [Menu:Windows](#)

## Namespaces

- [File](#)
- [Discussion](#)

## Variants

## Views

- [Read](#)
- [View source](#)
- [View history](#)

## More

- This page was last edited on 26 July 2009, at 04:42.

- [Privacy policy](#)
- [About Win-Test Wiki](#)
- [Disclaimers](#)



# File:WindowsSecondaryRadio.gif

From Win-Test Wiki

[Jump to navigation](#) [Jump to search](#)

- [File](#)
- [File history](#)
- [File usage](#)



No higher resolution available.

[WindowsSecondaryRadio.gif](#) (407 × 199 pixels, file size: 6 KB, MIME type: image/gif)

## File history

Click on a date/time to view the file as it appeared at that time.

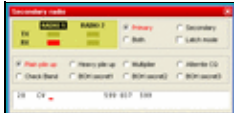
Date/Time	Thumbnail	Dimensions	User	Comment
current <a href="#">08:27, 5 October 2006</a>		407 × 199 (6 KB)	<a href="#">Ct1boh</a> ( <a href="#">talk</a>   <a href="#">contribs</a> )	

You cannot overwrite this file.

## File usage

The following file is a duplicate of this file ([more details](#)):

- [File:secondary window.PNG](#)

There are no pages that use this file.

## Namespaces

- [File](#)
- [Discussion](#)

## Variants

## Views

- [Read](#)
- [View source](#)
- [View history](#)

## More

- This page was last edited on 5 October 2006, at 08:27.

- [Privacy policy](#)
- [About Win-Test Wiki](#)
- [Disclaimers](#)



# File:WindowsSecondaryRadio.gif

From Win-Test Wiki

[Jump to navigation](#) [Jump to search](#)

- [File](#)
- [File history](#)
- [File usage](#)

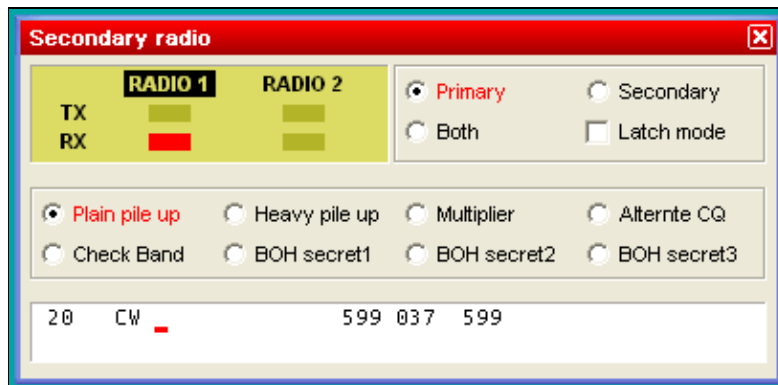

No higher resolution available.

[WindowsSecondaryRadio.gif](#) (407 × 199 pixels, file size: 6 KB, MIME type: image/gif)

## File history

Click on a date/time to view the file as it appeared at that time.

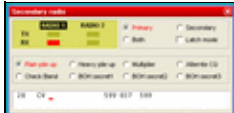
Date/Time	Thumbnail	Dimensions	User	Comment
current <a href="#">08:27, 5 October 2006</a>		407 × 199 (6 KB)	<a href="#">Ct1boh</a> ( <a href="#">talk</a>   <a href="#">contribs</a> )	

You cannot overwrite this file.

## File usage

The following file is a duplicate of this file ([more details](#)):

- [File:secondary window.PNG](#)

There are no pages that use this file.

## Namespaces

- [File](#)
- [Discussion](#)

## Variants

## Views

- [Read](#)
- [View source](#)
- [View history](#)

## More

- This page was last edited on 5 October 2006, at 08:27.

- [Privacy policy](#)
- [About Win-Test Wiki](#)
- [Disclaimers](#)



# File:WindowsSelectCty.gif

From Win-Test Wiki

[Jump to navigation](#) [Jump to search](#)

- [File](#)
- [File history](#)
- [File usage](#)



No higher resolution available.

[WindowsSelectCty.gif](#) (324 × 320 pixels, file size: 11 KB, MIME type: image.gif)

## File history

Click on a date/time to view the file as it appeared at that time.

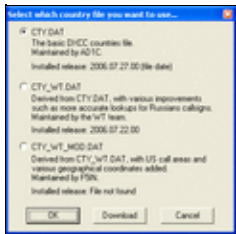
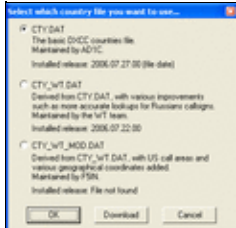
Date/Time	Thumbnail	Dimensions	User	Comment
current <a href="#">15:59, 5 August 2006</a>		324 × 320 (11 KB)	<a href="#">Dl6rai</a> ( <a href="#">talk</a>   <a href="#">contribs</a> )	
<a href="#">15:23, 5 August 2006</a>		320 × 319 (8 KB)	<a href="#">Dl6rai</a> ( <a href="#">talk</a>   <a href="#">contribs</a> )	

Date/Time	Thumbnail	Dimensions	User	Comment
You cannot overwrite this file.				

## File usage

The following page uses this file:

- [Menu:Options](#)

## Namespaces

- [File](#)
- [Discussion](#)

## Variants

## Views

- [Read](#)
- [View source](#)
- [View history](#)

## More

- This page was last edited on 5 August 2006, at 15:23.
- [Privacy policy](#)
- [About Win-Test Wiki](#)
- [Disclaimers](#)





# File:WindowsSelectCty.gif

From Win-Test Wiki

[Jump to navigation](#) [Jump to search](#)

- [File](#)
- [File history](#)
- [File usage](#)

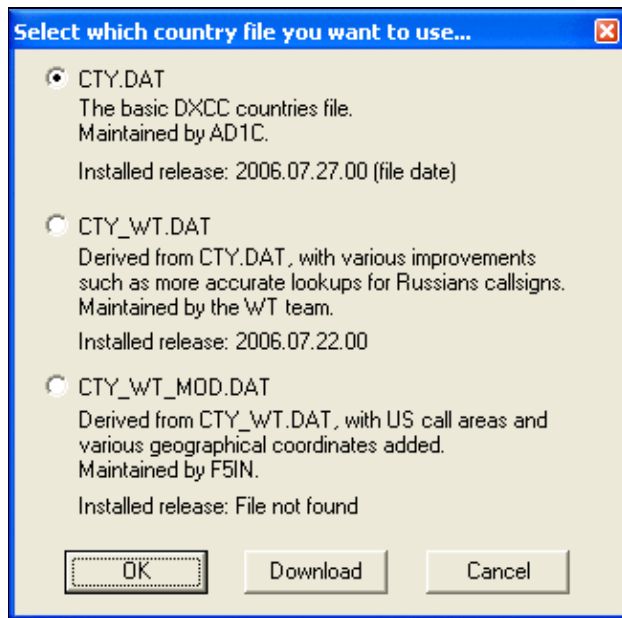

No higher resolution available.

[WindowsSelectCty.gif](#) (324 × 320 pixels, file size: 11 KB, MIME type: image.gif)

## File history

Click on a date/time to view the file as it appeared at that time.

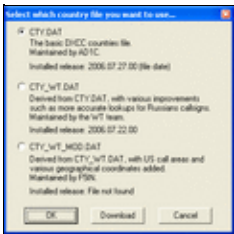
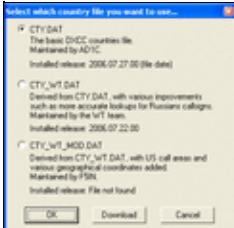
Date/Time	Thumbnail	Dimensions	User	Comment
current <a href="#">15:59, 5 August 2006</a>		324 × 320 (11 KB)	<a href="#">Dl6rai</a> ( <a href="#">talk</a>   <a href="#">contribs</a> )	
<a href="#">15:23, 5 August 2006</a>		320 × 319 (8 KB)	<a href="#">Dl6rai</a> ( <a href="#">talk</a>   <a href="#">contribs</a> )	

Date/Time	Thumbnail	Dimensions	User	Comment
You cannot overwrite this file.				

## File usage

The following page uses this file:

- [Menu:Options](#)

## Namespaces

- [File](#)
- [Discussion](#)

## Variants

## Views

- [Read](#)
- [View source](#)
- [View history](#)

## More

- This page was last edited on 5 August 2006, at 15:23.

- [Privacy policy](#)
- [About Win-Test Wiki](#)
- [Disclaimers](#)



# File:WindowsSked.gif

From Win-Test Wiki

[Jump to navigation](#) [Jump to search](#)

- [File](#)
- [File history](#)
- [File usage](#)

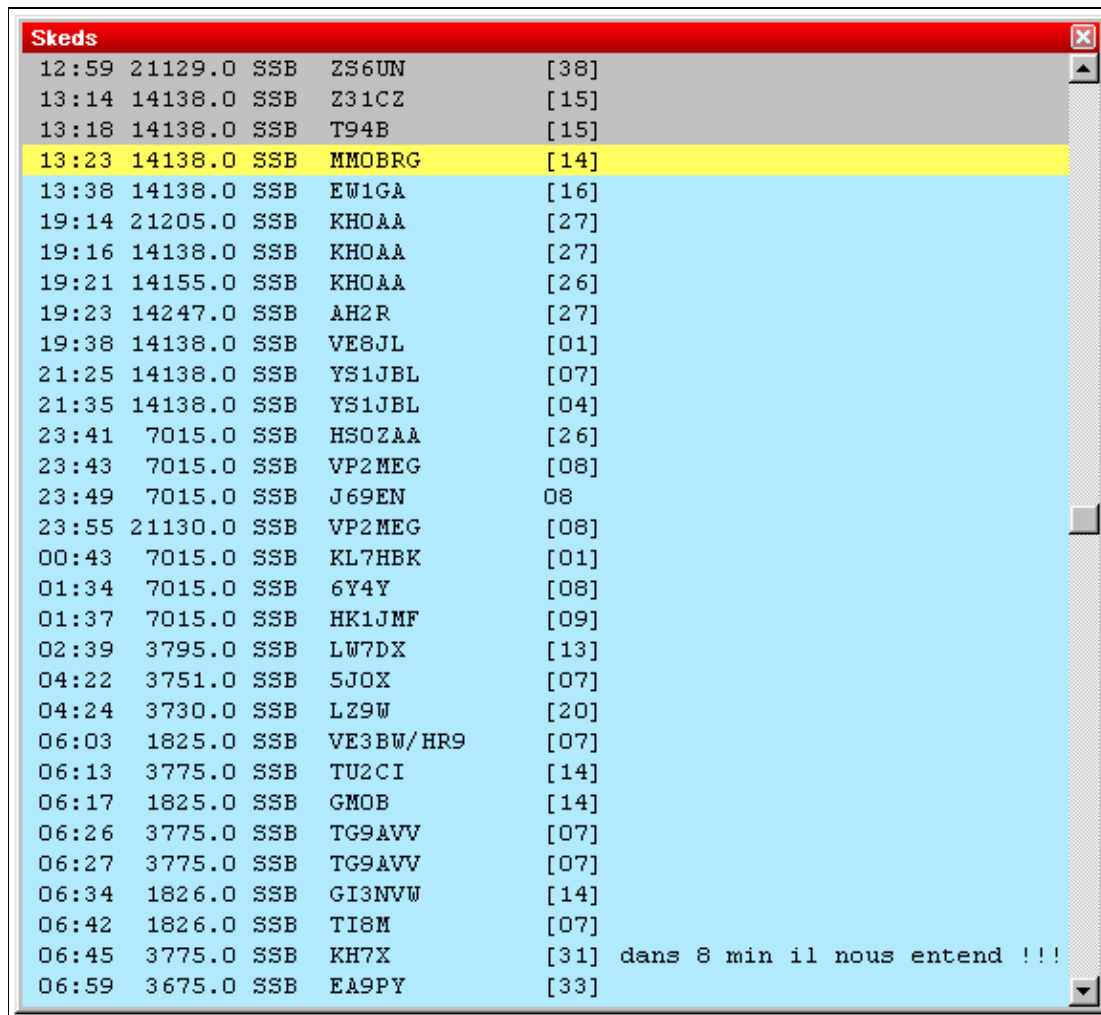

Skeds				
12:59	21129.0	SSB	ZS6UN	[38]
13:14	14138.0	SSB	Z31CZ	[15]
13:18	14138.0	SSB	T94B	[15]
13:23	14138.0	SSB	MMOBRG	[14]
13:38	14138.0	SSB	EW1GA	[16]
19:14	21205.0	SSB	KHOAA	[27]
19:16	14138.0	SSB	KHOAA	[27]
19:21	14155.0	SSB	KHOAA	[26]
19:23	14247.0	SSB	AH2R	[27]
19:38	14138.0	SSB	VE8JL	[01]
21:25	14138.0	SSB	YS1JBL	[07]
21:35	14138.0	SSB	YS1JBL	[04]
23:41	7015.0	SSB	HSOZAA	[26]
23:43	7015.0	SSB	VP2MEG	[08]
23:49	7015.0	SSB	J69EN	08
23:55	21130.0	SSB	VP2MEG	[08]
00:43	7015.0	SSB	KL7HBK	[01]
01:34	7015.0	SSB	6Y4Y	[08]
01:37	7015.0	SSB	HK1JMF	[09]
02:39	3795.0	SSB	LW7DX	[13]
04:22	3751.0	SSB	5JOX	[07]
04:24	3730.0	SSB	LZ9W	[20]
06:03	1825.0	SSB	VE3BW/HR9	[07]
06:13	3775.0	SSB	TU2CI	[14]
06:17	1825.0	SSB	GMOB	[14]
06:26	3775.0	SSB	TG9AVV	[07]
06:27	3775.0	SSB	TG9AVV	[07]
06:34	1826.0	SSB	GI3NVW	[14]
06:42	1826.0	SSB	TI8M	[07]
06:45	3775.0	SSB	KH7X	[31] dans 8 min il nous entend !!!
06:59	3675.0	SSB	EA9PY	[33]

No higher resolution available.

[WindowsSked.gif](#) (577 × 530 pixels, file size: 13 KB, MIME type: image/gif)

Skeds window

## File history

Click on a date/time to view the file as it appeared at that time.

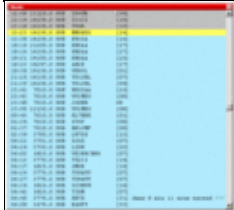
Date/Time	Thumbnail	Dimensions	User	Comment
current <a href="#">21:20, 27 July 2006</a>		577 × 530 (13 KB)	<a href="#">Dl6rai</a> ( <a href="#">talk</a>   <a href="#">contribs</a> )	Skeds window

You cannot overwrite this file.

## File usage

The following file is a duplicate of this file ([more details](#)):

- [File:SkedsWindow.gif](#)

The following page uses this file:

- [Menu:Windows](#)

## Namespaces

- [File](#)
- [Discussion](#)

## Variants

## Views

- [Read](#)
- [View source](#)
- [View history](#)

## More

- This page was last edited on 27 July 2006, at 21:20.
- [Privacy policy](#)
- [About Win-Test Wiki](#)
- [Disclaimers](#)



# File:WindowsSked.gif

From Win-Test Wiki

[Jump to navigation](#) [Jump to search](#)

- [File](#)
- [File history](#)
- [File usage](#)

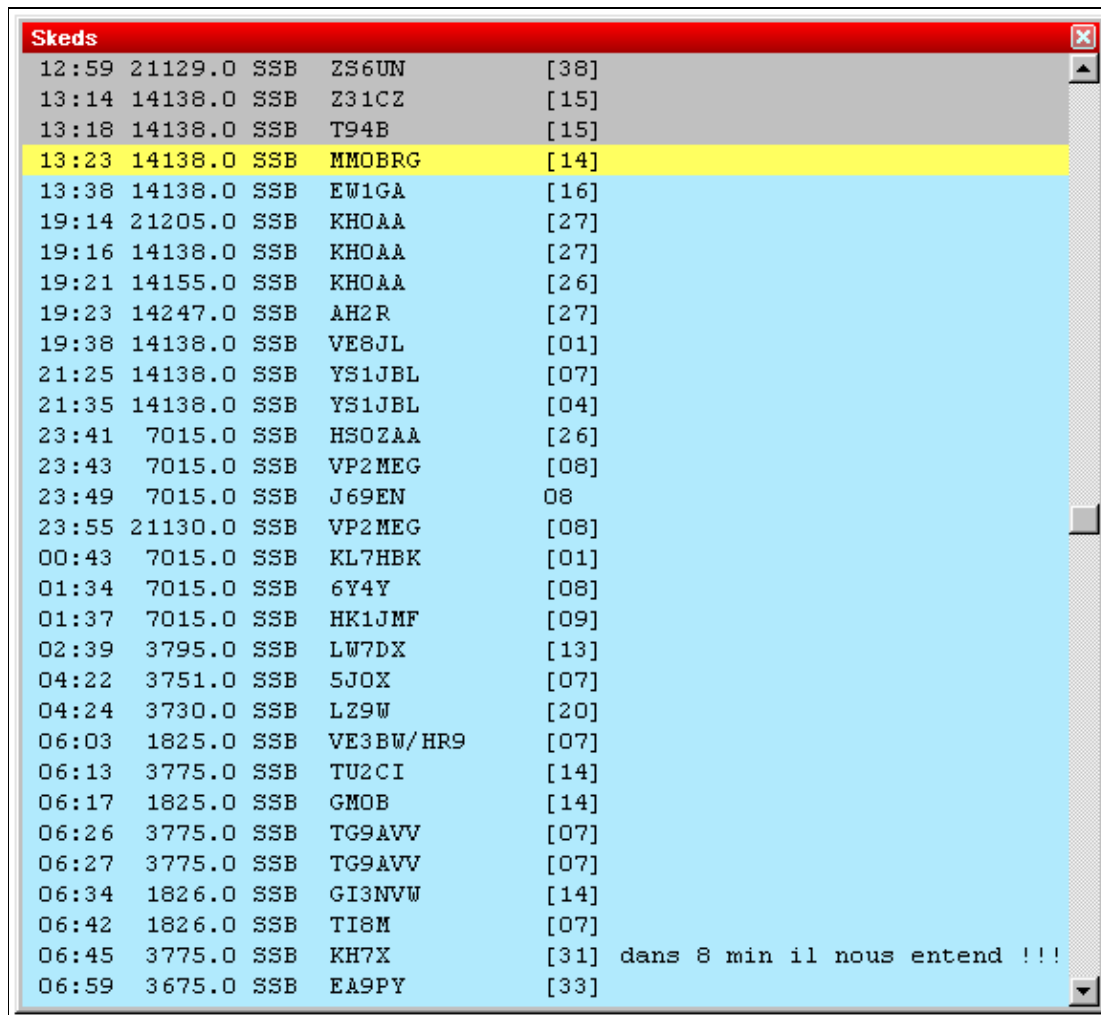

Time	Freq	Mode	Call Sign	Duration
12:59	21129.0	SSB	ZS6UN	[38]
13:14	14138.0	SSB	Z31CZ	[15]
13:18	14138.0	SSB	T94B	[15]
13:23	14138.0	SSB	MMOBRG	[14]
13:38	14138.0	SSB	EW1GA	[16]
19:14	21205.0	SSB	KHOAA	[27]
19:16	14138.0	SSB	KHOAA	[27]
19:21	14155.0	SSB	KHOAA	[26]
19:23	14247.0	SSB	AH2R	[27]
19:38	14138.0	SSB	VE8JL	[01]
21:25	14138.0	SSB	YS1JBL	[07]
21:35	14138.0	SSB	YS1JBL	[04]
23:41	7015.0	SSB	HSOZAA	[26]
23:43	7015.0	SSB	VP2MEG	[08]
23:49	7015.0	SSB	J69EN	08
23:55	21130.0	SSB	VP2MEG	[08]
00:43	7015.0	SSB	KL7HBK	[01]
01:34	7015.0	SSB	6Y4Y	[08]
01:37	7015.0	SSB	HK1JMF	[09]
02:39	3795.0	SSB	LW7DX	[13]
04:22	3751.0	SSB	5JOX	[07]
04:24	3730.0	SSB	LZ9W	[20]
06:03	1825.0	SSB	VE3BW/HR9	[07]
06:13	3775.0	SSB	TU2CI	[14]
06:17	1825.0	SSB	GMOB	[14]
06:26	3775.0	SSB	TG9AVV	[07]
06:27	3775.0	SSB	TG9AVV	[07]
06:34	1826.0	SSB	GI3NVW	[14]
06:42	1826.0	SSB	TI8M	[07]
06:45	3775.0	SSB	KH7X	[31] dans 8 min il nous entend !!!
06:59	3675.0	SSB	EA9PY	[33]

No higher resolution available.

[WindowsSked.gif](#) (577 × 530 pixels, file size: 13 KB, MIME type: image/gif)

Skeds window

## File history

Click on a date/time to view the file as it appeared at that time.

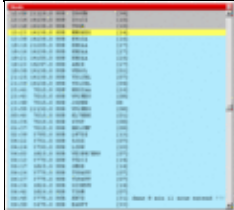
	Date/Time	Thumbnail	Dimensions	User	Comment
current	<a href="#">21:20, 27 July 2006</a>		577 × 530 (13 KB)	<a href="#">Dl6rai</a> ( <a href="#">talk</a>   <a href="#">contribs</a> )	Skeds window

You cannot overwrite this file.

## File usage

The following file is a duplicate of this file ([more details](#)):

- [File:SkedsWindow.gif](#)

The following page uses this file:

- [Menu:Windows](#)

## Namespaces

- [File](#)
- [Discussion](#)

## Variants

## Views

- [Read](#)
- [View source](#)
- [View history](#)

## More

- This page was last edited on 27 July 2006, at 21:20.
- [Privacy policy](#)
- [About Win-Test Wiki](#)
- [Disclaimers](#)





# File:WindowsSolarActivityWCY.gif

From Win-Test Wiki

[Jump to navigation](#) [Jump to search](#)

- [File](#)
- [File history](#)
- [File usage](#)

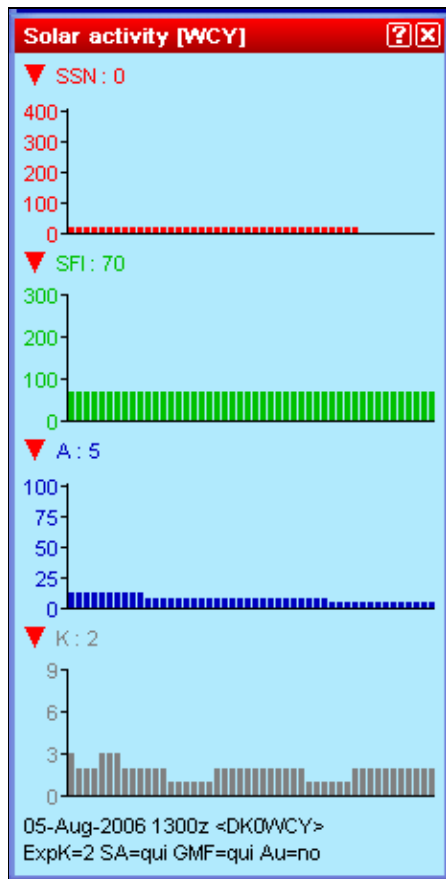



No higher resolution available.

[WindowsSolarActivityWCY.gif](#) (230 × 458 pixels, file size: 4 KB, MIME type: image/gif)

## File history

Click on a date/time to view the file as it appeared at that time.

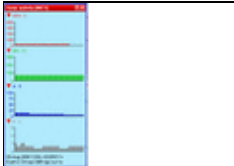
	Date/Time	Thumbnail	Dimensions	User	Comment
current	<a href="#">15:02, 5 August 2006</a>		230 × 458 (4 KB)	<a href="#">Dl6rai</a> ( <a href="#">talk</a>   <a href="#">contribs</a> )	
	<a href="#">14:58, 5 August 2006</a>		230 × 456 (4 KB)	<a href="#">Dl6rai</a> ( <a href="#">talk</a>   <a href="#">contribs</a> )	
	<a href="#">14:53, 5 August 2006</a>		640 × 458 (11 KB)	<a href="#">Dl6rai</a> ( <a href="#">talk</a>   <a href="#">contribs</a> )	

You cannot overwrite this file.

## File usage

The following page uses this file:

- [Menu:Windows](#)

## Namespaces

- [File](#)
- [Discussion](#)

## Variants

## Views

- [Read](#)
- [View source](#)
- [View history](#)

## More

- This page was last edited on 5 August 2006, at 14:53.

- [Privacy policy](#)
- [About Win-Test Wiki](#)
- [Disclaimers](#)



# File:WindowsSolarActivityWCY.gif

From Win-Test Wiki

[Jump to navigation](#) [Jump to search](#)

- [File](#)
- [File history](#)
- [File usage](#)

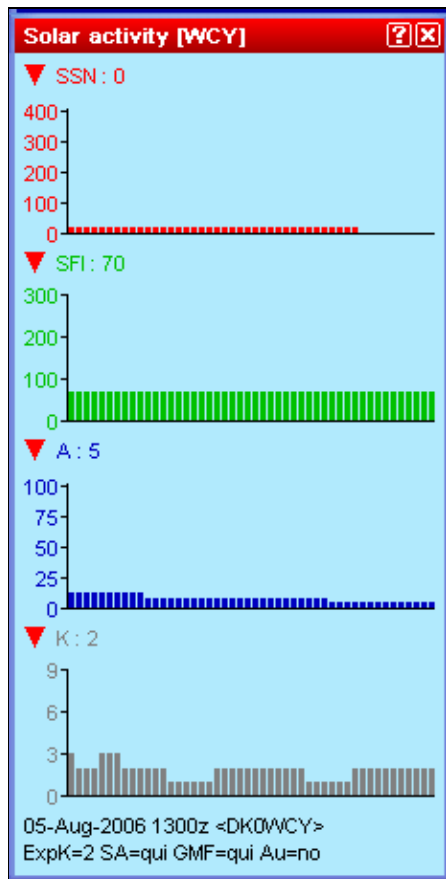



No higher resolution available.

[WindowsSolarActivityWCY.gif](#) (230 × 458 pixels, file size: 4 KB, MIME type: image/gif)

## File history

Click on a date/time to view the file as it appeared at that time.

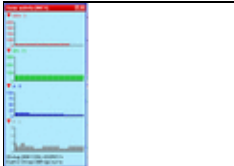
Date/Time	Thumbnail	Dimensions	User	Comment
current <a href="#">15:02, 5 August 2006</a>		230 × 458 (4 KB)	<a href="#">Dl6rai</a> ( <a href="#">talk</a>   <a href="#">contribs</a> )	
<a href="#">14:58, 5 August 2006</a>		230 × 456 (4 KB)	<a href="#">Dl6rai</a> ( <a href="#">talk</a>   <a href="#">contribs</a> )	
<a href="#">14:53, 5 August 2006</a>		640 × 458 (11 KB)	<a href="#">Dl6rai</a> ( <a href="#">talk</a>   <a href="#">contribs</a> )	

You cannot overwrite this file.

## File usage

The following page uses this file:

- [Menu:Windows](#)

## Namespaces

- [File](#)
- [Discussion](#)

## Variants

## Views

- [Read](#)
- [View source](#)
- [View history](#)

## More

- This page was last edited on 5 August 2006, at 14:53.

- [Privacy policy](#)
- [About Win-Test Wiki](#)
- [Disclaimers](#)



# File:WindowsSolarActivityWWV.gif

From Win-Test Wiki

[Jump to navigation](#) [Jump to search](#)

- [File](#)
- [File history](#)
- [File usage](#)

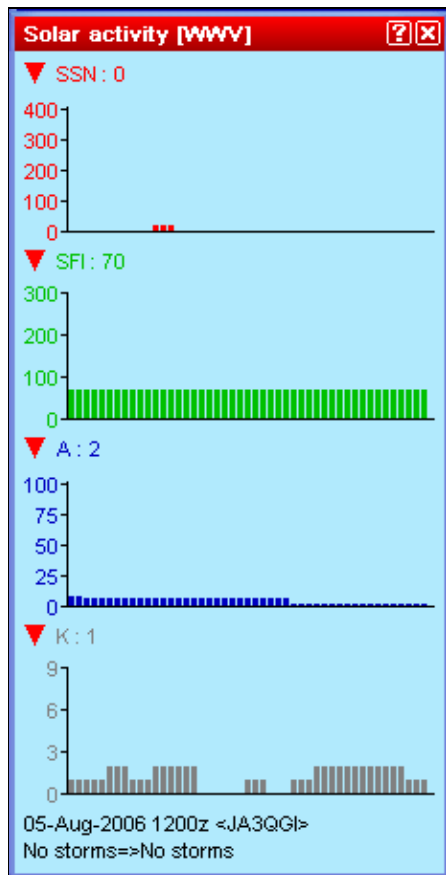

No higher resolution available.

[WindowsSolarActivityWWV.gif](#) (230 × 456 pixels, file size: 4 KB, MIME type: image.gif)

## File history

Click on a date/time to view the file as it appeared at that time.

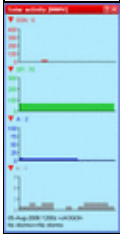
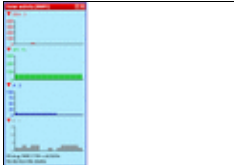
	Date/Time	Thumbnail	Dimensions	User	Comment
current	<a href="#">15:00, 5 August 2006</a>		230 × 456 (4 KB)	<a href="#">Dl6rai</a> ( <a href="#">talk</a>   <a href="#">contribs</a> )	
	<a href="#">14:54, 5 August 2006</a>		640 × 456 (11 KB)	<a href="#">Dl6rai</a> ( <a href="#">talk</a>   <a href="#">contribs</a> )	

You cannot overwrite this file.

## File usage

The following page uses this file:

- [Menu:Windows](#)

## Namespaces

- [File](#)
- [Discussion](#)

## Variants

## Views

- [Read](#)
- [View source](#)
- [View history](#)

## More

- This page was last edited on 5 August 2006, at 14:54.
- [Privacy policy](#)
- [About Win-Test Wiki](#)
- [Disclaimers](#)





# File:WindowsSolarActivityWWV.gif

From Win-Test Wiki

[Jump to navigation](#) [Jump to search](#)

- [File](#)
- [File history](#)
- [File usage](#)

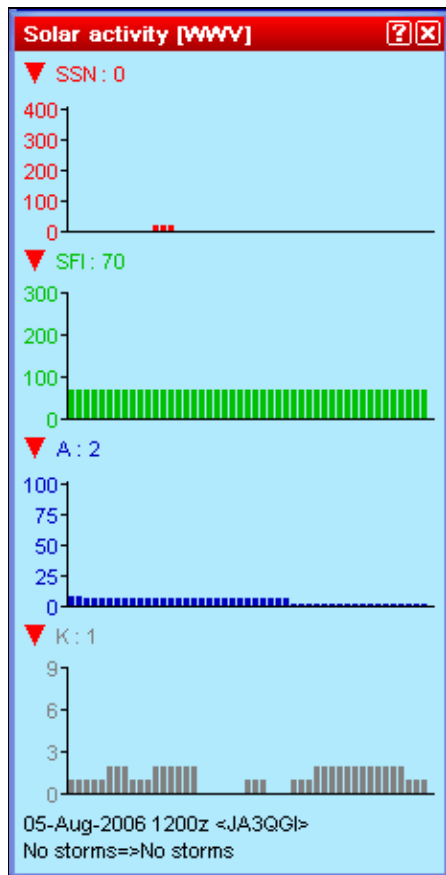

No higher resolution available.

[WindowsSolarActivityWWV.gif](#) (230 × 456 pixels, file size: 4 KB, MIME type: image.gif)

## File history

Click on a date/time to view the file as it appeared at that time.

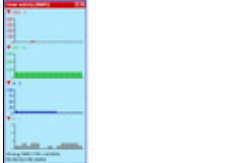
	Date/Time	Thumbnail	Dimensions	User	Comment
current	<a href="#">15:00, 5 August 2006</a>		230 × 456 (4 KB)	<a href="#">Dl6rai</a> ( <a href="#">talk</a>   <a href="#">contribs</a> )	
	<a href="#">14:54, 5 August 2006</a>		640 × 456 (11 KB)	<a href="#">Dl6rai</a> ( <a href="#">talk</a>   <a href="#">contribs</a> )	

You cannot overwrite this file.

## File usage

The following page uses this file:

- [Menu:Windows](#)

## Namespaces

- [File](#)
- [Discussion](#)

## Variants

## Views

- [Read](#)
- [View source](#)
- [View history](#)

## More

- This page was last edited on 5 August 2006, at 14:54.
- [Privacy policy](#)
- [About Win-Test Wiki](#)
- [Disclaimers](#)



# File:WindowsStatus.gif

From Win-Test Wiki

[Jump to navigation](#) [Jump to search](#)

- [File](#)
- [File history](#)
- [File usage](#)



STATION	BANDE	TYPE	FREQ	QSY	RADIO 1	RADIO 2	QSY
RUN1	80 SSB	M	3795.0	3775.0	21234.0		

No higher resolution available.

[WindowsStatus.gif](#) (470 Å 60 pixels, file size: 3 KB, MIME type: image/gif)

Status window

## File history

Click on a date/time to view the file as it appeared at that time.

	Date/Time	Thumbnail	Dimensions	User	Comment
current	<a href="#">21:18, 27 July 2006</a>		470 Å 60 (3 KB)	<a href="#">Dl6rai</a> ( <a href="#">talk</a>   <a href="#">contribs</a> )	Status window

You cannot overwrite this file.

## File usage

The following file is a duplicate of this file ([more details](#)):

- [File:StatusWindow.gif](#)

There are no pages that use this file.

## Namespaces

- [File](#)
- [Discussion](#)

## Variants

## Views

- [Read](#)
- [View source](#)
- [View history](#)

## More

- This page was last edited on 27 July 2006, at 21:18.

- [Privacy policy](#)
- [About Win-Test Wiki](#)
- [Disclaimers](#)



# File:WindowsStatus.gif

From Win-Test Wiki

[Jump to navigation](#) [Jump to search](#)

- [File](#)
- [File history](#)
- [File usage](#)



No higher resolution available.

[WindowsStatus.gif](#) (470 Å 60 pixels, file size: 3 KB, MIME type: image/gif)

Status window

## File history

Click on a date/time to view the file as it appeared at that time.

	Date/Time	Thumbnail	Dimensions	User	Comment
current	<a href="#">21:18, 27 July 2006</a>		470 Å 60 (3 KB)	<a href="#">Dl6rai</a> ( <a href="#">talk</a>   <a href="#">contribs</a> )	Status window

You cannot overwrite this file.

## File usage

The following file is a duplicate of this file ([more details](#)):

- [File:StatusWindow.gif](#)

There are no pages that use this file.

## Namespaces

- [File](#)
- [Discussion](#)

## Variants

## Views

- [Read](#)
- [View source](#)
- [View history](#)

## More

- This page was last edited on 27 July 2006, at 21:18.

- [Privacy policy](#)
- [About Win-Test Wiki](#)
- [Disclaimers](#)





# File:WindowsSummary.gif

From Win-Test Wiki

[Jump to navigation](#) [Jump to search](#)

- [File](#)
- [File history](#)
- [File usage](#)

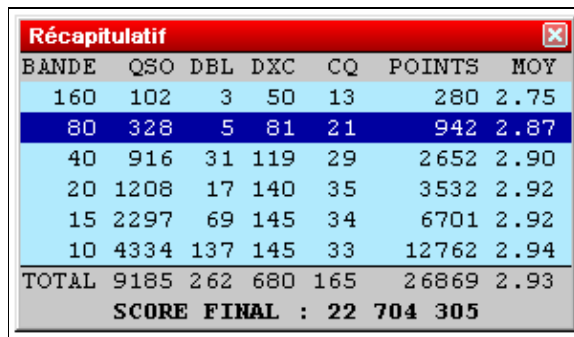

BANDE	QSO	DBL	DXC	CQ	POINTS	MOY
160	102	3	50	13	280	2.75
80	328	5	81	21	942	2.87
40	916	31	119	29	2652	2.90
20	1208	17	140	35	3532	2.92
15	2297	69	145	34	6701	2.92
10	4334	137	145	33	12762	2.94
TOTAL	9185	262	680	165	26869	2.93
<b>SCORE FINAL : 22 704 305</b>						

No higher resolution available.

[WindowsSummary.gif](#) (299 × 172 pixels, file size: 5 KB, MIME type: image/gif)

Summary

## File history

Click on a date/time to view the file as it appeared at that time.

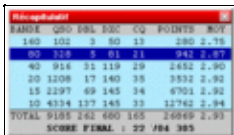
	Date/Time	Thumbnail	Dimensions	User	Comment
current	<a href="#">21:22, 27 July 2006</a>		299 × 172 (5 KB)	<a href="#">Dl6rai</a> ( <a href="#">talk</a>   <a href="#">contribs</a> )	Summary

You cannot overwrite this file.

## File usage

The following page uses this file:

- [Menu:Windows](#)

## Namespaces

- [File](#)
- [Discussion](#)

## Variants

## Views

- [Read](#)
- [View source](#)
- [View history](#)

## More

- This page was last edited on 27 July 2006, at 21:22.

- [Privacy policy](#)
- [About Win-Test Wiki](#)
- [Disclaimers](#)



# File:WindowsSummary.gif

From Win-Test Wiki

[Jump to navigation](#) [Jump to search](#)

- [File](#)
- [File history](#)
- [File usage](#)

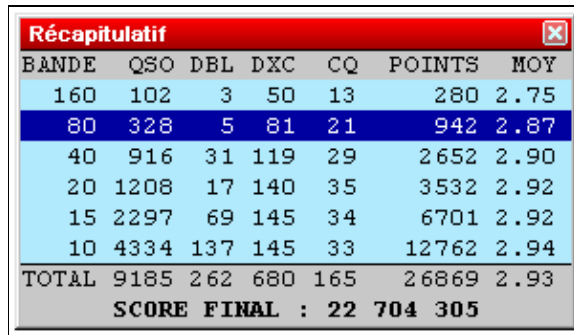

BANDE	QSO	DBL	DXC	CQ	POINTS	MOY
160	102	3	50	13	280	2.75
80	328	5	81	21	942	2.87
40	916	31	119	29	2652	2.90
20	1208	17	140	35	3532	2.92
15	2297	69	145	34	6701	2.92
10	4334	137	145	33	12762	2.94
TOTAL	9185	262	680	165	26869	2.93
<b>SCORE FINAL : 22 704 305</b>						

No higher resolution available.

[WindowsSummary.gif](#) (299 × 172 pixels, file size: 5 KB, MIME type: image/gif)

Summary

## File history

Click on a date/time to view the file as it appeared at that time.

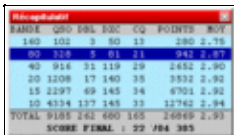
	Date/Time	Thumbnail	Dimensions	User	Comment
current	<a href="#">21:22, 27 July 2006</a>		299 × 172 (5 KB)	<a href="#">Dl6rai</a> ( <a href="#">talk</a>   <a href="#">contribs</a> )	Summary

You cannot overwrite this file.

## File usage

The following page uses this file:

- [Menu:Windows](#)

## Namespaces

- [File](#)
- [Discussion](#)

## Variants

## Views

- [Read](#)
- [View source](#)
- [View history](#)

## More

- This page was last edited on 27 July 2006, at 21:22.

- [Privacy policy](#)
- [About Win-Test Wiki](#)
- [Disclaimers](#)



# File:WindowsVuMeter.gif

From Win-Test Wiki

[Jump to navigation](#) [Jump to search](#)

- [File](#)
- [File history](#)
- [File usage](#)



No higher resolution available.

[WindowsVuMeter.gif](#) (65 × 17 pixels, file size: 260 bytes, MIME type: image/gif)

SSB bargraph window

## File history

Click on a date/time to view the file as it appeared at that time.

	Date/Time	Thumbnail	Dimensions	User	Comment
current	<a href="#">21:54, 27 July 2006</a>		65 × 17 (260 bytes)	<a href="#">Dl6rai</a> ( <a href="#">talk</a>   <a href="#">contribs</a> )	SSB bargraph window

You cannot overwrite this file.

## File usage

The following 2 pages use this file:

- [DVK CW RTTY Messaging](#)
- [Menu:Windows](#)

## Namespaces

- [File](#)
- [Discussion](#)

## Variants

## Views

- [Read](#)
- [View source](#)
- [View history](#)

## More

- This page was last edited on 27 July 2006, at 21:54.

- [Privacy policy](#)
- [About Win-Test Wiki](#)
- [Disclaimers](#)



# File:WindowsVuMeter.gif

From Win-Test Wiki

[Jump to navigation](#) [Jump to search](#)

- [File](#)
- [File history](#)
- [File usage](#)



No higher resolution available.

[WindowsVuMeter.gif](#) (65 × 17 pixels, file size: 260 bytes, MIME type: image/gif)

SSB bargraph window

## File history

Click on a date/time to view the file as it appeared at that time.

	Date/Time	Thumbnail	Dimensions	User	Comment
current	<a href="#">21:54, 27 July 2006</a>		65 × 17 (260 bytes)	<a href="#">Dl6rai</a> ( <a href="#">talk</a>   <a href="#">contribs</a> )	SSB bargraph window

You cannot overwrite this file.

## File usage

The following 2 pages use this file:

- [DVK CW RTTY Messaging](#)
- [Menu:Windows](#)

## Namespaces

- [File](#)
- [Discussion](#)

## Variants

## Views

- [Read](#)
- [View source](#)
- [View history](#)

## More

- This page was last edited on 27 July 2006, at 21:54.

- [Privacy policy](#)
- [About Win-Test Wiki](#)
- [Disclaimers](#)





# File:WindowsWriteNote.gif

From Win-Test Wiki

[Jump to navigation](#) [Jump to search](#)

- [File](#)
- [File history](#)
- [File usage](#)



No higher resolution available.

[WindowsWriteNote.gif](#) (526 × 44 pixels, file size: 3 KB, MIME type: image.gif)

## File history

Click on a date/time to view the file as it appeared at that time.

	Date/Time	Thumbnail	Dimensions	User	Comment
current	<a href="#">18:11, 5 August 2006</a>		526 × 44 (3 KB)	<a href="#">Dl6rai</a> ( <a href="#">talk</a>   <a href="#">contribs</a> )	

You cannot overwrite this file.

## File usage

The following page uses this file:

- [Menu:Messages](#)

## Namespaces

- [File](#)
- [Discussion](#)

## Variants

## Views

- [Read](#)
- [View source](#)
- [View history](#)

## More

- This page was last edited on 5 August 2006, at 18:11.
- [Privacy policy](#)

## Win-Test Wiki

- [About Win-Test Wiki](#)
- [Disclaimers](#)



# File:WindowsWriteNote.gif

From Win-Test Wiki

[Jump to navigation](#) [Jump to search](#)

- [File](#)
- [File history](#)
- [File usage](#)



No higher resolution available.

[WindowsWriteNote.gif](#) (526 × 44 pixels, file size: 3 KB, MIME type: image.gif)

## File history

Click on a date/time to view the file as it appeared at that time.

	Date/Time	Thumbnail	Dimensions	User	Comment
current	<a href="#">18:11, 5 August 2006</a>		526 × 44 (3 KB)	<a href="#">Dl6rai</a> ( <a href="#">talk</a>   <a href="#">contribs</a> )	

You cannot overwrite this file.

## File usage

The following page uses this file:

- [Menu:Messages](#)

## Namespaces

- [File](#)
- [Discussion](#)

## Variants

## Views

- [Read](#)
- [View source](#)
- [View history](#)

## More

- This page was last edited on 5 August 2006, at 18:11.
- [Privacy policy](#)

## Win-Test Wiki

- [About Win-Test Wiki](#)
- [Disclaimers](#)



# File:WindowsZone1.gif

From Win-Test Wiki

[Jump to navigation](#) [Jump to search](#)

- [File](#)
- [File history](#)
- [File usage](#)

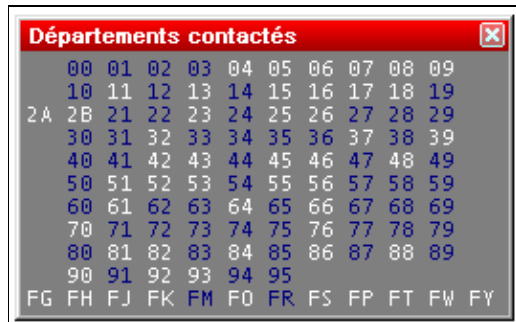

No higher resolution available.

[WindowsZone1.gif](#) (268 Å 166 pixels, file size: 5 KB, MIME type: image/gif)

Worked departements window (French REF HF contest)

## File history

Click on a date/time to view the file as it appeared at that time.

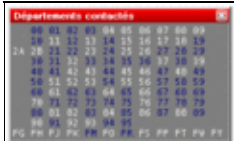
	Date/Time	Thumbnail	Dimensions	User	Comment
current	<a href="#">20:43, 27 July 2006</a>		268 Å 166 (5 KB)	<a href="#">Dl6rai (talk   contribs)</a>	Worked departements window (French REF HF contest)

You cannot overwrite this file.

## File usage

The following page uses this file:

- [Menu:Windows](#)

## Namespaces

- [File](#)
- [Discussion](#)

## Variants

## Views

- [Read](#)
- [View source](#)
- [View history](#)

## More

- This page was last edited on 27 July 2006, at 20:43.

- [Privacy policy](#)
- [About Win-Test Wiki](#)
- [Disclaimers](#)



# File:WindowsZone1.gif

From Win-Test Wiki

[Jump to navigation](#) [Jump to search](#)

- [File](#)
- [File history](#)
- [File usage](#)

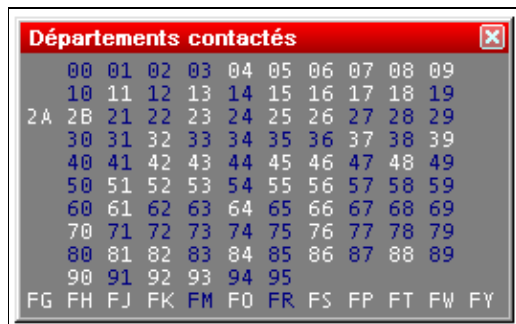

No higher resolution available.

[WindowsZone1.gif](#) (268 Å 166 pixels, file size: 5 KB, MIME type: image/gif)

Worked departements window (French REF HF contest)

## File history

Click on a date/time to view the file as it appeared at that time.

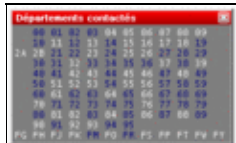
	Date/Time	Thumbnail	Dimensions	User	Comment
current	<a href="#">20:43, 27 July 2006</a>		268 Å 166 (5 KB)	<a href="#">Dl6rai (talk   contribs)</a>	Worked departements window (French REF HF contest)

You cannot overwrite this file.

## File usage

The following page uses this file:

- [Menu:Windows](#)

## Namespaces

- [File](#)
- [Discussion](#)

## Variants

## Views

- [Read](#)
- [View source](#)
- [View history](#)

## More

- This page was last edited on 27 July 2006, at 20:43.

- [Privacy policy](#)
- [About Win-Test Wiki](#)
- [Disclaimers](#)





# File:WindowsZone2.gif

From Win-Test Wiki

[Jump to navigation](#) [Jump to search](#)

- [File](#)
- [File history](#)
- [File usage](#)

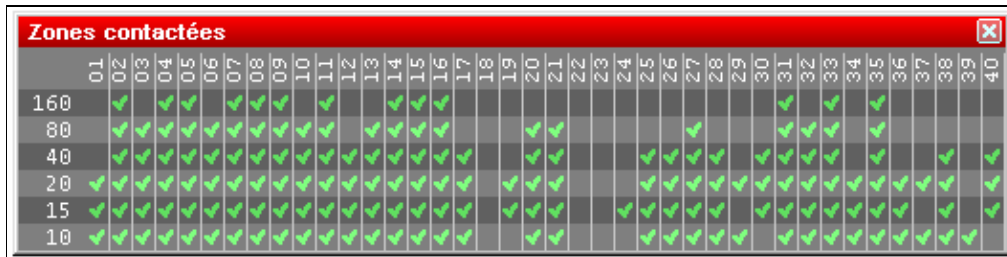

	01	02	03	04	05	06	07	08	09	10	11	12	13	14	15	16	17	18	19	20	21	22	23	24	25	26	27	28	29	30	31	32	33	34	35	36	37	38	39	40	
160	✓																																								
80	✓	✓	✓	✓	✓	✓	✓	✓	✓	✓	✓	✓	✓	✓	✓	✓	✓	✓	✓	✓	✓	✓	✓	✓	✓	✓	✓	✓	✓	✓	✓	✓	✓	✓	✓	✓	✓	✓	✓	✓	✓
40	✓	✓	✓	✓	✓	✓	✓	✓	✓	✓	✓	✓	✓	✓	✓	✓	✓	✓	✓	✓	✓	✓	✓	✓	✓	✓	✓	✓	✓	✓	✓	✓	✓	✓	✓	✓	✓	✓	✓	✓	✓
20	✓	✓	✓	✓	✓	✓	✓	✓	✓	✓	✓	✓	✓	✓	✓	✓	✓	✓	✓	✓	✓	✓	✓	✓	✓	✓	✓	✓	✓	✓	✓	✓	✓	✓	✓	✓	✓	✓	✓	✓	✓
15	✓	✓	✓	✓	✓	✓	✓	✓	✓	✓	✓	✓	✓	✓	✓	✓	✓	✓	✓	✓	✓	✓	✓	✓	✓	✓	✓	✓	✓	✓	✓	✓	✓	✓	✓	✓	✓	✓	✓	✓	✓
10	✓	✓	✓	✓	✓	✓	✓	✓	✓	✓	✓	✓	✓	✓	✓	✓	✓	✓	✓	✓	✓	✓	✓	✓	✓	✓	✓	✓	✓	✓	✓	✓	✓	✓	✓	✓	✓	✓	✓	✓	✓

No higher resolution available.

[WindowsZone2.gif](#) (529 × 133 pixels, file size: 8 KB, MIME type: image/gif)

WAZ zones worked window by band (CQWW DX contest)

## File history

Click on a date/time to view the file as it appeared at that time.

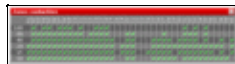
	Date/Time	Thumbnail	Dimensions	User	Comment
current	<a href="#">20:44, 27 July 2006</a>		529 × 133 (8 KB)	<a href="#">Dl6rai</a> ( <a href="#">talk</a>   <a href="#">contribs</a> )	WAZ zones worked window by band (CQWW DX contest)

You cannot overwrite this file.

## File usage

The following page uses this file:

- [Menu:Windows](#)

## Namespaces

- [File](#)
- [Discussion](#)

## Variants

## Views

- [Read](#)
- [View source](#)
- [View history](#)

## More

- This page was last edited on 27 July 2006, at 20:44.

- [Privacy policy](#)
- [About Win-Test Wiki](#)
- [Disclaimers](#)



# File:WindowsZone2.gif

From Win-Test Wiki

[Jump to navigation](#) [Jump to search](#)

- [File](#)
- [File history](#)
- [File usage](#)

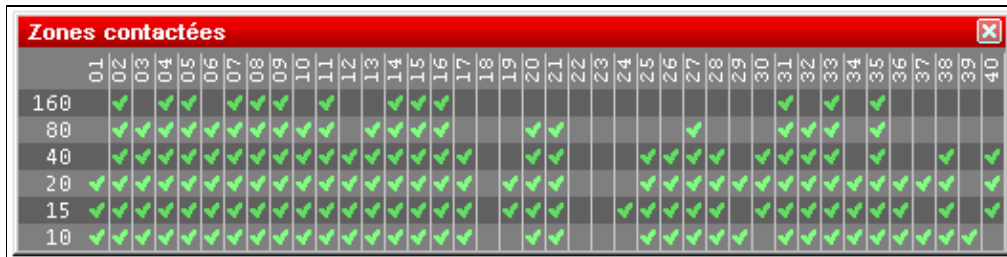

	01	02	03	04	05	06	07	08	09	10	11	12	13	14	15	16	17	18	19	20	21	22	23	24	25	26	27	28	29	30	31	32	33	34	35	36	37	38	39	40	
160	✓																																								
80	✓	✓	✓	✓	✓	✓	✓	✓	✓	✓	✓	✓	✓	✓	✓	✓	✓	✓	✓	✓	✓	✓	✓	✓	✓	✓	✓	✓	✓	✓	✓	✓	✓	✓	✓	✓	✓	✓	✓	✓	✓
40	✓	✓	✓	✓	✓	✓	✓	✓	✓	✓	✓	✓	✓	✓	✓	✓	✓	✓	✓	✓	✓	✓	✓	✓	✓	✓	✓	✓	✓	✓	✓	✓	✓	✓	✓	✓	✓	✓	✓	✓	✓
20	✓	✓	✓	✓	✓	✓	✓	✓	✓	✓	✓	✓	✓	✓	✓	✓	✓	✓	✓	✓	✓	✓	✓	✓	✓	✓	✓	✓	✓	✓	✓	✓	✓	✓	✓	✓	✓	✓	✓	✓	✓
15	✓	✓	✓	✓	✓	✓	✓	✓	✓	✓	✓	✓	✓	✓	✓	✓	✓	✓	✓	✓	✓	✓	✓	✓	✓	✓	✓	✓	✓	✓	✓	✓	✓	✓	✓	✓	✓	✓	✓	✓	✓
10	✓	✓	✓	✓	✓	✓	✓	✓	✓	✓	✓	✓	✓	✓	✓	✓	✓	✓	✓	✓	✓	✓	✓	✓	✓	✓	✓	✓	✓	✓	✓	✓	✓	✓	✓	✓	✓	✓	✓	✓	✓

No higher resolution available.

[WindowsZone2.gif](#) (529 × 133 pixels, file size: 8 KB, MIME type: image/gif)

WAZ zones worked window by band (CQWW DX contest)

## File history

Click on a date/time to view the file as it appeared at that time.

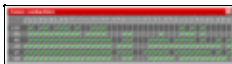
	Date/Time	Thumbnail	Dimensions	User	Comment
current	<a href="#">20:44, 27 July 2006</a>		529 × 133 (8 KB)	<a href="#">Dl6rai</a> ( <a href="#">talk</a>   <a href="#">contribs</a> )	WAZ zones worked window by band (CQWW DX contest)

You cannot overwrite this file.

## File usage

The following page uses this file:

- [Menu:Windows](#)

## Namespaces

- [File](#)
- [Discussion](#)

## Variants

## Views

- [Read](#)
- [View source](#)
- [View history](#)

## More

- This page was last edited on 27 July 2006, at 20:44.

- [Privacy policy](#)
- [About Win-Test Wiki](#)
- [Disclaimers](#)



# File:WindowsZone3.gif

From Win-Test Wiki

[Jump to navigation](#) [Jump to search](#)

- [File](#)
- [File history](#)
- [File usage](#)

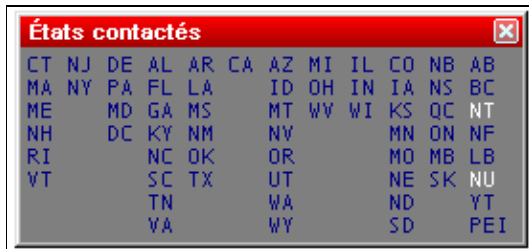

No higher resolution available.

[WindowsZone3.gif](#) (275 × 127 pixels, file size: 4 KB, MIME type: image/gif)

Worked states and provinces window (International ARRL DX contest)

## File history

Click on a date/time to view the file as it appeared at that time.

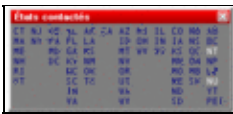
	Date/Time	Thumbnail	Dimensions	User	Comment
current	<a href="#">20:44, 27 July 2006</a>		275 × 127 (4 KB)	<a href="#">D16rai (talk   contribs)</a>	Worked states and provinces window (International ARRL DX contest)

You cannot overwrite this file.

## File usage

The following page uses this file:

- [Menu:Windows](#)

## Namespaces

- [File](#)
- [Discussion](#)

## Variants

## Views

- [Read](#)
- [View source](#)
- [View history](#)

## More

- This page was last edited on 27 July 2006, at 20:44.

- [Privacy policy](#)
- [About Win-Test Wiki](#)
- [Disclaimers](#)



# File:WindowsZone3.gif

From Win-Test Wiki

[Jump to navigation](#) [Jump to search](#)

- [File](#)
- [File history](#)
- [File usage](#)

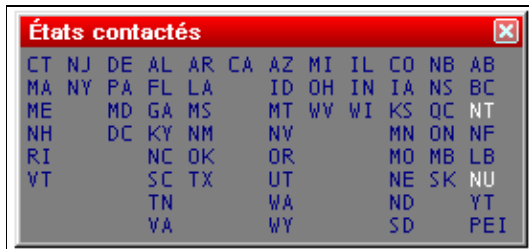

No higher resolution available.

[WindowsZone3.gif](#) (275 × 127 pixels, file size: 4 KB, MIME type: image/gif)

Worked states and provinces window (International ARRL DX contest)

## File history

Click on a date/time to view the file as it appeared at that time.

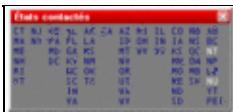
	Date/Time	Thumbnail	Dimensions	User	Comment
current	<a href="#">20:44, 27 July 2006</a>		275 × 127 (4 KB)	<a href="#">D16rai (talk   contribs)</a>	Worked states and provinces window (International ARRL DX contest)

You cannot overwrite this file.

## File usage

The following page uses this file:

- [Menu:Windows](#)

## Namespaces

- [File](#)
- [Discussion](#)

## Variants

## Views

- [Read](#)
- [View source](#)
- [View history](#)

## More

- This page was last edited on 27 July 2006, at 20:44.

- [Privacy policy](#)
- [About Win-Test Wiki](#)
- [Disclaimers](#)





# File:wine serialconf.gif

From Win-Test Wiki

[Jump to navigation](#) [Jump to search](#)

- [File](#)
- [File history](#)
- [File usage](#)

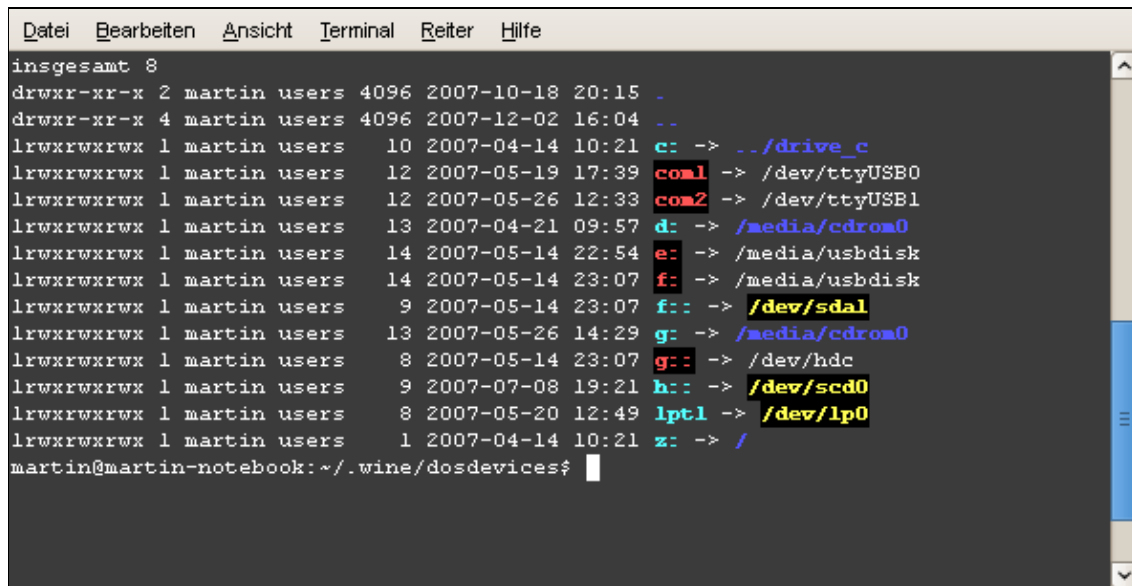

```
insgesamt 8
drwxr-xr-x 2 martin users 4096 2007-10-18 20:15 .
drwxr-xr-x 4 martin users 4096 2007-12-02 16:04 ..
lrwxrwxrwx 1 martin users 10 2007-04-14 10:21 c: -> ../drive_c
lrwxrwxrwx 1 martin users 12 2007-05-19 17:39 com1 -> /dev/ttyUSB0
lrwxrwxrwx 1 martin users 12 2007-05-26 12:33 com2 -> /dev/ttyUSB1
lrwxrwxrwx 1 martin users 13 2007-04-21 09:57 d: -> /media/cdrom0
lrwxrwxrwx 1 martin users 14 2007-05-14 22:54 e: -> /media/usbdisk
lrwxrwxrwx 1 martin users 14 2007-05-14 23:07 f: -> /media/usbdisk
lrwxrwxrwx 1 martin users 9 2007-05-14 23:07 f:: -> /dev/sda1
lrwxrwxrwx 1 martin users 13 2007-05-26 14:29 g: -> /media/cdrom0
lrwxrwxrwx 1 martin users 8 2007-05-14 23:07 g:: -> /dev/hdc
lrwxrwxrwx 1 martin users 9 2007-07-08 19:21 h:: -> /dev/scd0
lrwxrwxrwx 1 martin users 8 2007-05-20 12:49 lpt1 -> /dev/lp0
lrwxrwxrwx 1 martin users 1 2007-04-14 10:21 z: -> /
martin@martin-notebook: ~/.wine/dosdevices$
```

No higher resolution available.

[wine serialconf.gif](#) (591 × 304 pixels, file size: 13 KB, MIME type: image.gif)

Configuration of serial interfaces in wine

## File history

Click on a date/time to view the file as it appeared at that time.

	Date/Time	Thumbnail	Dimensions	User	Comment
current	<a href="#">15:18, 2 December 2007</a>		591 × 304 (13 KB)	<a href="#">Dl5rmh (talk   contribs)</a>	Configuration of serial interfaces in wine

You cannot overwrite this file.

## File usage

The following page uses this file:

- [running on Linux](#)

## Namespaces

- [File](#)
- [Discussion](#)

## Variants

## Views

- [Read](#)
- [View source](#)
- [View history](#)

## More

- This page was last edited on 2 December 2007, at 15:18.
- [Privacy policy](#)
- [About Win-Test Wiki](#)
- [Disclaimers](#)



# File:wine serialconf.gif

From Win-Test Wiki

[Jump to navigation](#) [Jump to search](#)

- [File](#)
- [File history](#)
- [File usage](#)

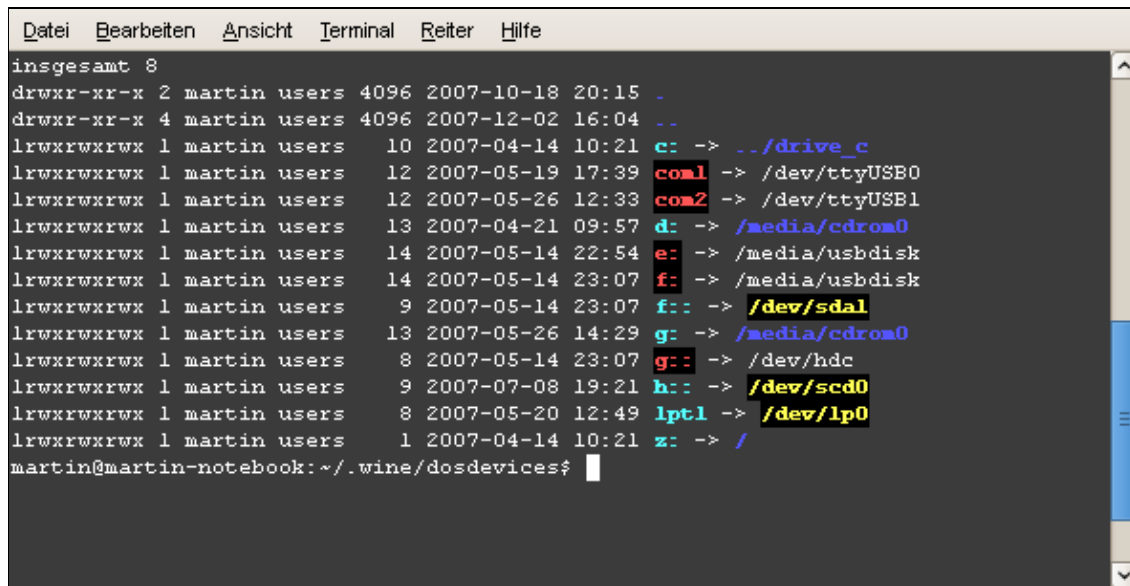

```
insgesamt 8
drwxr-xr-x 2 martin users 4096 2007-10-18 20:15 .
drwxr-xr-x 4 martin users 4096 2007-12-02 16:04 ..
lrwxrwxrwx 1 martin users 10 2007-04-14 10:21 c: -> ../drive_c
lrwxrwxrwx 1 martin users 12 2007-05-19 17:39 com1 -> /dev/ttyUSB0
lrwxrwxrwx 1 martin users 12 2007-05-26 12:33 com2 -> /dev/ttyUSB1
lrwxrwxrwx 1 martin users 13 2007-04-21 09:57 d: -> /media/cdrom0
lrwxrwxrwx 1 martin users 14 2007-05-14 22:54 e: -> /media/usbdisk
lrwxrwxrwx 1 martin users 14 2007-05-14 23:07 f: -> /media/usbdisk
lrwxrwxrwx 1 martin users 9 2007-05-14 23:07 f:: -> /dev/sda1
lrwxrwxrwx 1 martin users 13 2007-05-26 14:29 g: -> /media/cdrom0
lrwxrwxrwx 1 martin users 8 2007-05-14 23:07 g:: -> /dev/hdc
lrwxrwxrwx 1 martin users 9 2007-07-08 19:21 h:: -> /dev/scd0
lrwxrwxrwx 1 martin users 8 2007-05-20 12:49 lpt1 -> /dev/lp0
lrwxrwxrwx 1 martin users 1 2007-04-14 10:21 z: -> /
martin@martin-notebook: ~/.wine/dosdevices$
```

No higher resolution available.

[wine serialconf.gif](#) (591 × 304 pixels, file size: 13 KB, MIME type: image.gif)

Configuration of serial interfaces in wine

## File history

Click on a date/time to view the file as it appeared at that time.

	Date/Time	Thumbnail	Dimensions	User	Comment
current	<a href="#">15:18, 2 December 2007</a>		591 × 304 (13 KB)	<a href="#">Dl5rmh (talk   contribs)</a>	Configuration of serial interfaces in wine

You cannot overwrite this file.

## File usage

The following page uses this file:

- [running on Linux](#)

## Namespaces

- [File](#)
- [Discussion](#)

## Variants

## Views

- [Read](#)
- [View source](#)
- [View history](#)

## More

- This page was last edited on 2 December 2007, at 15:18.
- [Privacy policy](#)
- [About Win-Test Wiki](#)
- [Disclaimers](#)



# File:WinkeyProperties.gif

From Win-Test Wiki

[Jump to navigation](#) [Jump to search](#)

- [File](#)
- [File history](#)
- [File usage](#)

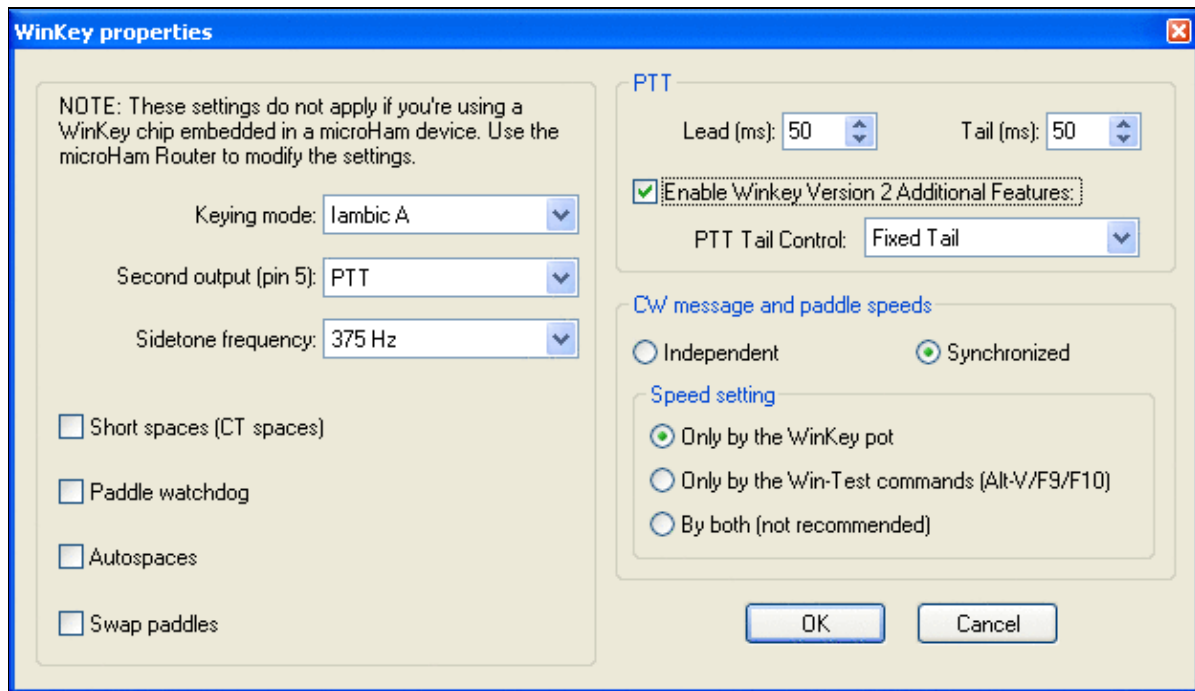

No higher resolution available.

[WinkeyProperties.gif](#) (623 × 359 pixels, file size: 22 KB, MIME type: image/gif)

WinKey Properties dialog

## File history

Click on a date/time to view the file as it appeared at that time.

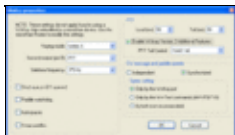
	Date/Time	Thumbnail	Dimensions	User	Comment
current	<a href="#">07:11, 18 April 2010</a>		623 × 359 (22 KB)	<a href="#">Dl6rai</a> ( <a href="#">talk</a>   <a href="#">contribs</a> )	

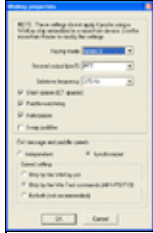
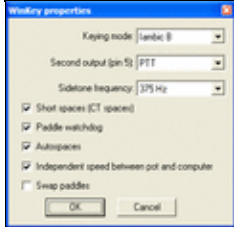
Date/Time	Thumbnail	Dimensions	User	Comment
<u>19:43, 6 September 2008</u>		320 Ã 495 (14 KB)	<a href="#">N6TV (talk   contribs)</a>	WT 3.22 version
<u>00:54, 2 June 2008</u>		290 Ã 284 (9 KB)	<a href="#">N6TV (talk   contribs)</a>	WinKey Properties dialog

You cannot overwrite this file.

## File usage

The following page uses this file:

- [Menu:Options](#)

## Namespaces

- [File](#)
- [Discussion](#)

## Variants

## Views

- [Read](#)
- [View source](#)
- [View history](#)

## More

- This page was last edited on 2 June 2008, at 00:54.

- [Privacy policy](#)
- [About Win-Test Wiki](#)
- [Disclaimers](#)



# File:WinkeyProperties.gif

From Win-Test Wiki

[Jump to navigation](#) [Jump to search](#)

- [File](#)
- [File history](#)
- [File usage](#)

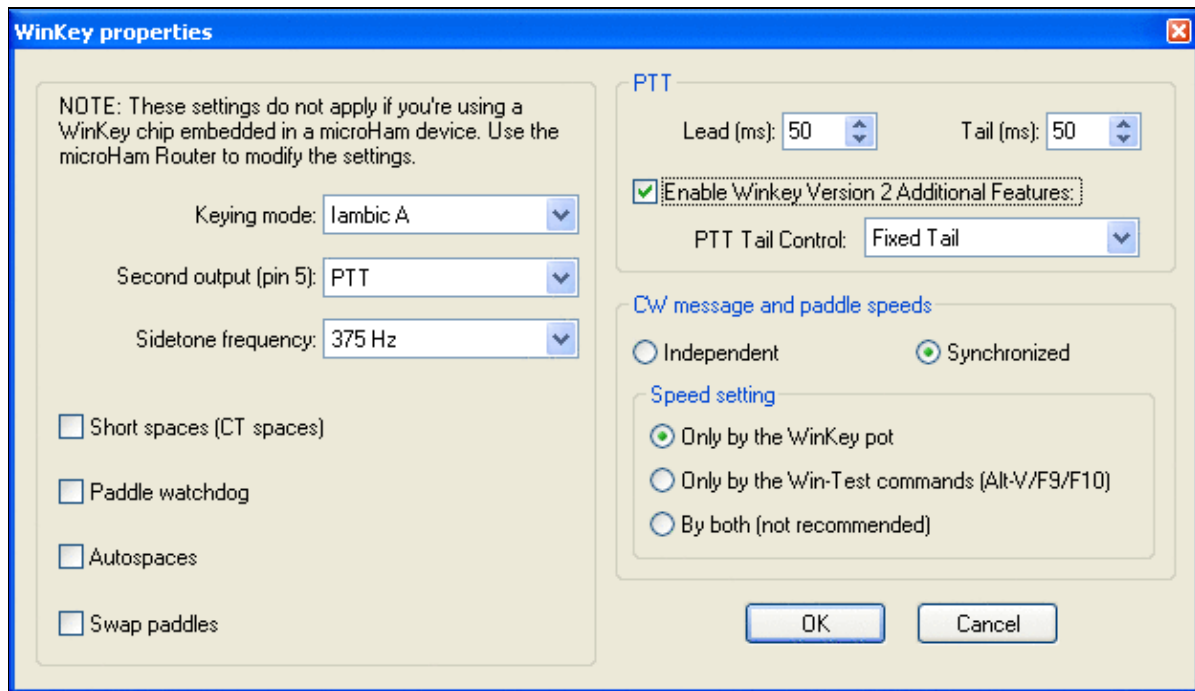

No higher resolution available.

[WinkeyProperties.gif](#) (623 × 359 pixels, file size: 22 KB, MIME type: image/gif)

WinKey Properties dialog

## File history

Click on a date/time to view the file as it appeared at that time.

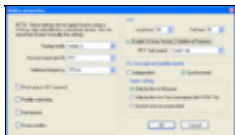
	Date/Time	Thumbnail	Dimensions	User	Comment
current	<a href="#">07:11, 18 April 2010</a>		623 × 359 (22 KB)	<a href="#">Dl6rai</a> ( <a href="#">talk</a>   <a href="#">contribs</a> )	

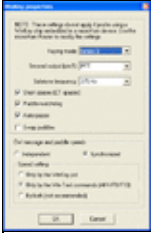
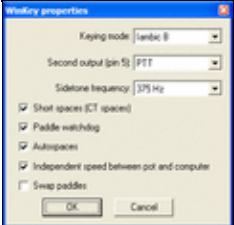
Date/Time	Thumbnail	Dimensions	User	Comment
<u>19:43, 6 September 2008</u>		320 Ã 495 (14 KB)	<a href="#">N6TV</a> ( <a href="#">talk</a>   <a href="#">contribs</a> )	WT 3.22 version
<u>00:54, 2 June 2008</u>		290 Ã 284 (9 KB)	<a href="#">N6TV</a> ( <a href="#">talk</a>   <a href="#">contribs</a> )	WinKey Properties dialog

You cannot overwrite this file.

## File usage

The following page uses this file:

- [Menu:Options](#)

## Namespaces

- [File](#)
- [Discussion](#)

## Variants

## Views

- [Read](#)
- [View source](#)
- [View history](#)

## More

- This page was last edited on 2 June 2008, at 00:54.
- [Privacy policy](#)
- [About Win-Test Wiki](#)
- [Disclaimers](#)





# File:wintest Config WinKey.gif

From Win-Test Wiki

[Jump to navigation](#) [Jump to search](#)

- [File](#)
- [File history](#)
- [File usage](#)

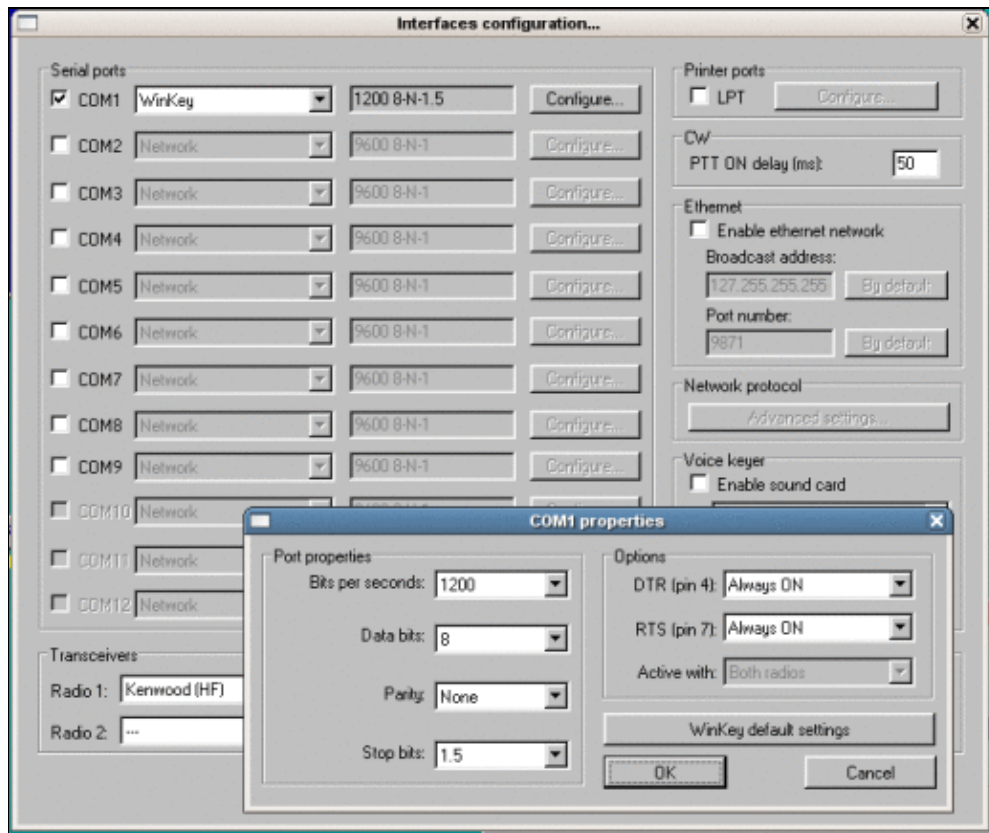

No higher resolution available.

[wintest\\_Config\\_WinKey.gif](#) (518 Å 434 pixels, file size: 63 KB, MIME type: image.gif)

WinKey working stable under Linux

## File history

Click on a date/time to view the file as it appeared at that time.

	Date/Time	Thumbnail	Dimensions	User	Comment
current	<a href="#">15:45, 2 December 2007</a>		518 Å 434 (63 KB)	<a href="#">Dl5rmh (talk   contribs)</a>	WinKey working stable under Linux

You cannot overwrite this file.

## File usage

The following page uses this file:

- [running on Linux](#)

## Namespaces

- [File](#)
- [Discussion](#)

## Variants

## Views

- [Read](#)
- [View source](#)
- [View history](#)

## More

- This page was last edited on 2 December 2007, at 15:45.

- [Privacy policy](#)
- [About Win-Test Wiki](#)
- [Disclaimers](#)



# File:wintest Config WinKey.gif

From Win-Test Wiki

[Jump to navigation](#) [Jump to search](#)

- [File](#)
- [File history](#)
- [File usage](#)

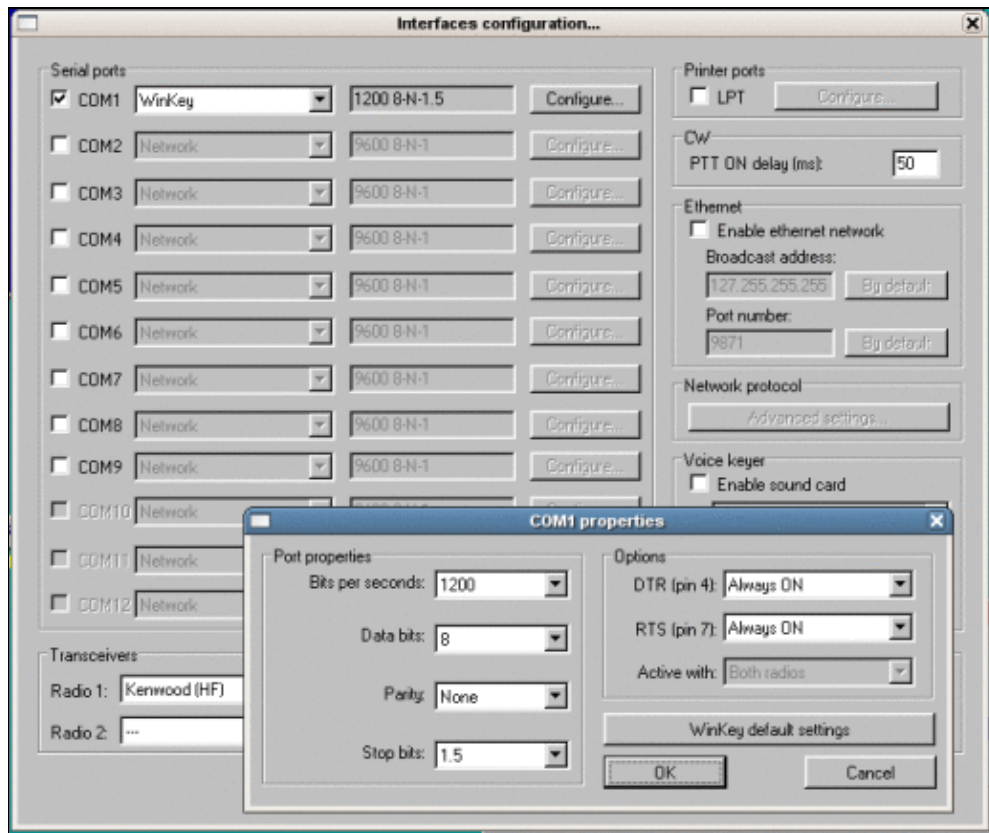

No higher resolution available.

[wintest\\_Config\\_WinKey.gif](#) (518 × 434 pixels, file size: 63 KB, MIME type: image/gif)

WinKey working stable under Linux

## File history

Click on a date/time to view the file as it appeared at that time.

	Date/Time	Thumbnail	Dimensions	User	Comment
current	<a href="#">15:45, 2 December 2007</a>		518 × 434 (63 KB)	<a href="#">Dl5rmh (talk   contribs)</a>	WinKey working stable under Linux

You cannot overwrite this file.

## File usage

The following page uses this file:

- [running on Linux](#)

## Namespaces

- [File](#)
- [Discussion](#)

## Variants

## Views

- [Read](#)
- [View source](#)
- [View history](#)

## More

- This page was last edited on 2 December 2007, at 15:45.

- [Privacy policy](#)
- [About Win-Test Wiki](#)
- [Disclaimers](#)



# File:wintest-linux wpxcw2007.gif

From Win-Test Wiki

[Jump to navigation](#) [Jump to search](#)

- [File](#)
- [File history](#)
- [File usage](#)

The screenshot displays the Win-Test Linux software interface. The main window is titled "WT - wpx\_cw\_2007.wtb [STRT]". It features a menu bar (File, Edit, Operating, Commands, Messages, Tools, Windows, Options, Help) and a toolbar. The interface is divided into several panels:

- Check partial result:** Shows "[UNIQUE]" for both "R+1" and "R-1".
- Check multipliers:** A table showing multiplier counts and call signs.
 

160	
80	
511	40 08:55 SN0FWQ 599226
20	
15	
10	
- Radio 1:** Shows VFO A at 7023.5 and VFO B at 7017.5. A list of frequencies and call signs is visible:
  - 7002.5 -DKOED
  - 7006.9 54\* -SPLAEN
  - 7009.2 -DR0BANA
  - 7018.2 141\* -9A7A
  - 7013.7 -003D
  - 7019.2 49\* -LY6M
  - 7022.5 54\* -ZNPVQ
- Rate:** A summary panel showing statistics for "All bands - All modes":
  - Last hour: 56 Q/h
  - 10 last QSO: 108 Q/h
  - 100 last QSO: 9 Q/h
  - Since 0800z: 56 QSO
  - 15 last minutes -
  - Moving graph computed on 15 mins
  - Continents distribution: EU, RA, SA, AF, AS, OC
  - Elapsed time since the last QSO: 39 Sec
  - Time ON: 11 H 01 Mn
  - Time OFF: 9 H 15 Mn
  - Last bands changes: Radio 1: 32 Mn, Radio 2: -
  - All bands - All modes: Time by mult: 4 Mn 03 Sec
  - 1 QSO counts: 501 Pts
  - 1 mult counts: 856 Pts
  - 1 mult worth: 1.7 QSO
- Summary:** A table summarizing performance by band:
 

BAND	QSO	DUP	PFX	POINTS	AVG
160	0	0	0	0	0.00
80	71	0	35	153	2.15
40	146	0	78	306	2.10
20	137	1	101	183	1.34
15	82	0	48	128	1.56
10	74	0	37	86	1.16
TOTAL	510	1	299	856	1.68
- Log:** A table showing QSO details:
 

QSO	Bd	Time	Callsign	Sent	N*	Rcvd	Mult	Pts	Stn
503	40	08:50	OE3JAG	599	503	599	OE3	2	R
504	40	08:51	OZ8KD	599	504	599		2	R
505	40	08:52	ES1CW	599	505	599		418	2
506	40	08:52	DL9NEI	599	506	599		187	1
507	40	08:53	OK2KR	599	507	599		453	2
508	40	08:53	DK7JZ	599	508	599	DK7		1
509	40	08:54	DJ4BA	599	509	599		014	1
510	40	08:55	SP9KRT	599	510	599		655	2
511	40	08:55	SN0FWQ	599	511	599	SN0		2
512	40			599	512	599			0

No higher resolution available.

[wintest-linux\\_wpxcw2007.gif](#) (640 × 480 pixels, file size: 91 KB, MIME type: image.gif)

Win-Test running stable on Linux with Radio and WinKey connected.

## File history

Click on a date/time to view the file as it appeared at that time.

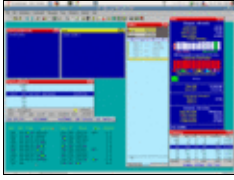
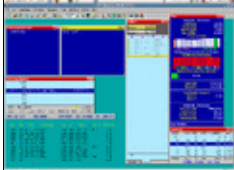
	Date/Time	Thumbnail	Dimensions	User	Comment
current	<a href="#">15:33, 2 December 2007</a>		640 × 480 (91 KB)	<a href="#">Dl5rmh</a> ( <a href="#">talk</a>   <a href="#">contribs</a> )	Win-Test running stable on Linux with Radio and WinKey connected.
	<a href="#">15:31, 2 December 2007</a>		1,024 × 768 (85 KB)	<a href="#">Dl5rmh</a> ( <a href="#">talk</a>   <a href="#">contribs</a> )	Win-Test running stable on Linux with Radio and WinKey connected.

You cannot overwrite this file.

## File usage

The following page uses this file:

- [running on Linux](#)

## Namespaces

- [File](#)
- [Discussion](#)

## Variants

## Views

- [Read](#)
- [View source](#)
- [View history](#)

## More

- This page was last edited on 2 December 2007, at 15:31.
- [Privacy policy](#)
- [About Win-Test Wiki](#)
- [Disclaimers](#)



# File:wintest-linux wpxcw2007.gif

From Win-Test Wiki

[Jump to navigation](#) [Jump to search](#)

- [File](#)
- [File history](#)
- [File usage](#)

The screenshot displays the Win-Test software interface for a CW contest. The main window is titled "WT - wpx\_cw\_2007.wtb [STRT]". The interface is divided into several panels:

- Check partial result:** Shows "[UNIQUE]" for both "R+1" and "R-1".
- Check multipliers:** A table showing multiplier counts for various bands and stations.
 

160	80
511	40 08:55 SN0FWQ 599226
20	15
10	
- Radio 1:** Shows VFO A at 7023.5 and VFO B at 7017.5. A list of active stations is visible:
  - 7002.5 -DKOED
  - 7006.9 54\* -SPLAEN
  - 7009.2 -DR0BANA
  - 7018.2 141\* -9A7A
  - 7013.7 -003D
  - 7019.2 49\* -LY6M
  - 7022.5 54\* -ZNPVQ
- Rate:** A summary panel showing performance metrics:
  - All bands - All modes: 56 Qth
  - Last hour: 108 Qth
  - 10 last QSO: 9 Qth
  - 100 last QSO: 56 QSO
  - Since 0800z: - 15 last minutes -
  - Moving graph computed on 15 mins
  - Continents distribution: EU, RA, SA, AF, AS, OC
  - Elapsed time since the last QSO: 39 Sec
  - Time ON: 11 H 01 Mn
  - Time OFF: 9 H 15 Mn
  - Last bands changes: Radio 1: 32 Mn, Radio 2: -
  - All bands - All modes: Time by mult: 4 Mn 03 Sec
  - 1 QSO counts: 501 Pts
  - 1 mult counts: 856 Pts
  - 1 mult worth: 1.7 QSO
- CW 32 WPM:** A summary table:
 

BAND	QSO	DUP	PFX	POINTS	AVG
160	0	0	0	0	0.00
80	71	0	35	153	2.15
40	146	0	78	306	2.10
20	137	1	101	183	1.34
15	82	0	48	128	1.56
10	74	0	37	86	1.16
TOTAL	510	1	299	856	1.68
- Log:** A table of QSOs with columns for QSO, Bd, Time, Callsign, Sent N\*, Rcvd, Mult, and PtsStn.
 

QSO	Bd	Time	Callsign	Sent N*	Rcvd	Mult	PtsStn
503	40	08:50	OE3JAG	599 503	599 135	OE3	2 R
504	40	08:51	OZ8KD	599 504	599 501		2 R
505	40	08:52	ES1CW	599 505	599 418		2 R
506	40	08:52	DL9NEI	599 506	599 187		1 R
507	40	08:53	OK2KR	599 507	599 453		2 R
508	40	08:53	DK7JZ	599 508	599 011	DK7	1 R
509	40	08:54	DJ4BA	599 509	599 014		1 R
510	40	08:55	SP9KRT	599 510	599 655		2 R
511	40	08:55	SN0FWQ	599 511	599 226	SN0	2 R
512	40			599 512	599		0 R



No higher resolution available.

[wintest-linux\\_wpxcw2007.gif](#) (640 × 480 pixels, file size: 91 KB, MIME type: image.gif)

Win-Test running stable on Linux with Radio and WinKey connected.

## File history

Click on a date/time to view the file as it appeared at that time.

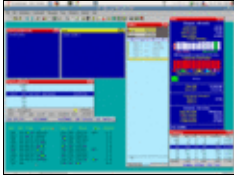
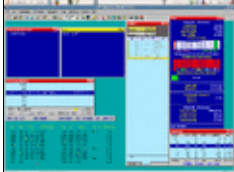
	Date/Time	Thumbnail	Dimensions	User	Comment
current	<a href="#">15:33, 2 December 2007</a>		640 × 480 (91 KB)	<a href="#">Dl5rmh (talk   contribs)</a>	Win-Test running stable on Linux with Radio and WinKey connected.
	<a href="#">15:31, 2 December 2007</a>		1,024 × 768 (85 KB)	<a href="#">Dl5rmh (talk   contribs)</a>	Win-Test running stable on Linux with Radio and WinKey connected.

You cannot overwrite this file.

## File usage

The following page uses this file:

- [running on Linux](#)

## Namespaces

- [File](#)
- [Discussion](#)

## Variants

## Views

- [Read](#)
- [View source](#)
- [View history](#)

## More

- This page was last edited on 2 December 2007, at 15:31.
- [Privacy policy](#)
- [About Win-Test Wiki](#)
- [Disclaimers](#)



# File:WorldMapWithLightTerminator.gif

From Win-Test Wiki

[Jump to navigation](#) [Jump to search](#)

- [File](#)
- [File history](#)
- [File usage](#)

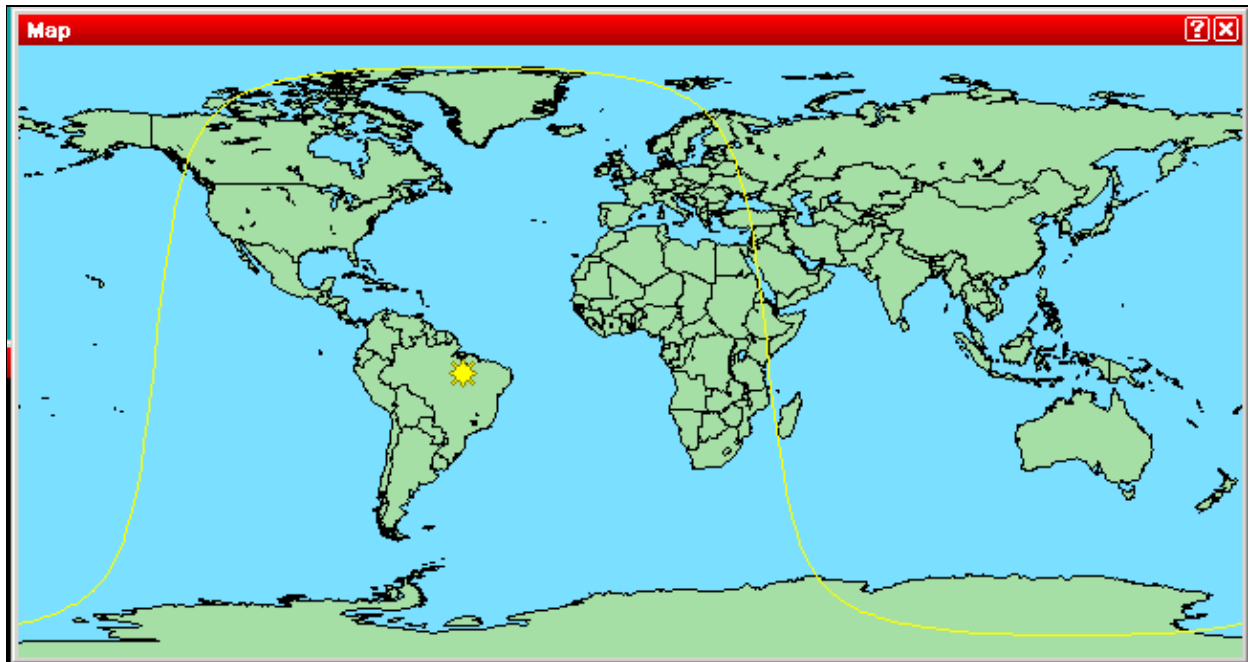

No higher resolution available.

[WorldMapWithLightTerminator.gif](#) (649 × 344 pixels, file size: 12 KB, MIME type: image/gif)

## File history

Click on a date/time to view the file as it appeared at that time.

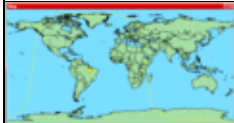
Date/Time	Thumbnail	Dimensions	User	Comment
current <a href="#">15:10, 9 October 2006</a>		649 × 344 (12 KB)	<a href="#">Dl6rai</a> ( <a href="#">talk</a>   <a href="#">contribs</a> )	

You cannot overwrite this file.

## File usage

The following page uses this file:

- [Menu:Windows](#)

## Namespaces

- [File](#)
- [Discussion](#)

## Variants

## Views

- [Read](#)
- [View source](#)
- [View history](#)

## More

- This page was last edited on 9 October 2006, at 15:10.

- [Privacy policy](#)
- [About Win-Test Wiki](#)
- [Disclaimers](#)

- The logo for MediaWiki, featuring a sun icon and the text "Powered By MediaWiki".

# File:WorldMapWithLightTerminator.gif

From Win-Test Wiki

[Jump to navigation](#) [Jump to search](#)

- [File](#)
- [File history](#)
- [File usage](#)

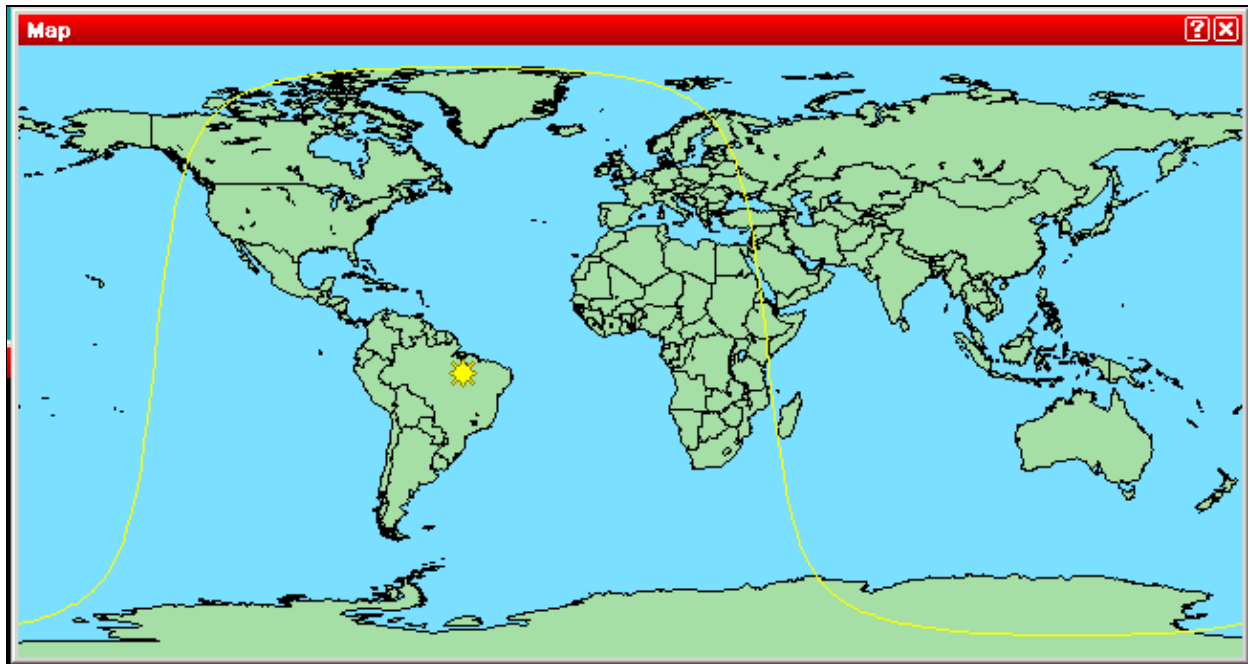

No higher resolution available.

[WorldMapWithLightTerminator.gif](#) (649 × 344 pixels, file size: 12 KB, MIME type: image/gif)

## File history

Click on a date/time to view the file as it appeared at that time.

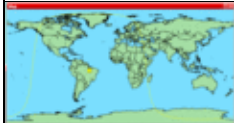
Date/Time	Thumbnail	Dimensions	User	Comment
current <a href="#">15:10, 9 October 2006</a>		649 × 344 (12 KB)	<a href="#">Dl6rai</a> ( <a href="#">talk</a>   <a href="#">contribs</a> )	

You cannot overwrite this file.

## File usage

The following page uses this file:

- [Menu:Windows](#)

## Namespaces

- [File](#)
- [Discussion](#)

## Variants

## Views

- [Read](#)
- [View source](#)
- [View history](#)

## More

- This page was last edited on 9 October 2006, at 15:10.

- [Privacy policy](#)
- [About Win-Test Wiki](#)
- [Disclaimers](#)



# File:WorldMapWithRBNSpots2.gif

From Win-Test Wiki

[Jump to navigation](#) [Jump to search](#)

- [File](#)
- [File history](#)
- [File usage](#)
- [Metadata](#)

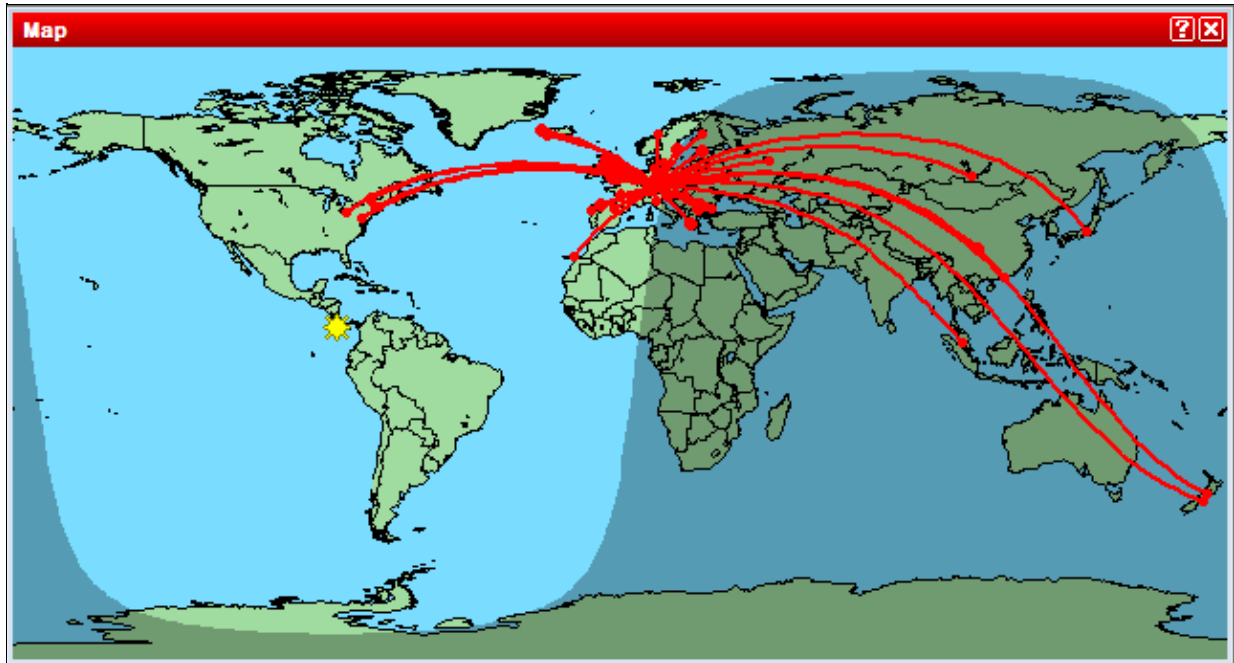

No higher resolution available.

[WorldMapWithRBNSpots2.gif](#) (642 × 346 pixels, file size: 23 KB, MIME type: image.gif)

## File history

Click on a date/time to view the file as it appeared at that time.

Date/Time	Thumbnail	Dimensions	User	Comment
current <a href="#">15:24, 9 April 2023</a>		642 × 346 (23 KB)	<a href="#">Dl6rai</a> ( <a href="#">talk</a>   <a href="#">contribs</a> )	

You cannot overwrite this file.

## File usage

The following page uses this file:

- [Menu:Windows](#)

## Metadata

This file contains additional information, probably added from the digital camera or scanner used to create or digitize it.

If the file has been modified from its original state, some details may not fully reflect the modified file.

**Horizontal resolution** 37.78 dpc

**Vertical resolution** 37.78 dpc

## Namespaces

- [File](#)
- [Discussion](#)

## Variants

## Views

- [Read](#)
- [View source](#)
- [View history](#)

## More

- This page was last edited on 9 April 2023, at 15:24.

- [Privacy policy](#)
- [About Win-Test Wiki](#)
- [Disclaimers](#)

- The logo consists of a blue square with a white sun icon on the left, followed by the text "Powered By" in a small font and "MediaWiki" in a larger font, all contained within a thin black border.



# File:WorldMapWithRBNSpots2.gif

From Win-Test Wiki

[Jump to navigation](#) [Jump to search](#)

- [File](#)
- [File history](#)
- [File usage](#)
- [Metadata](#)

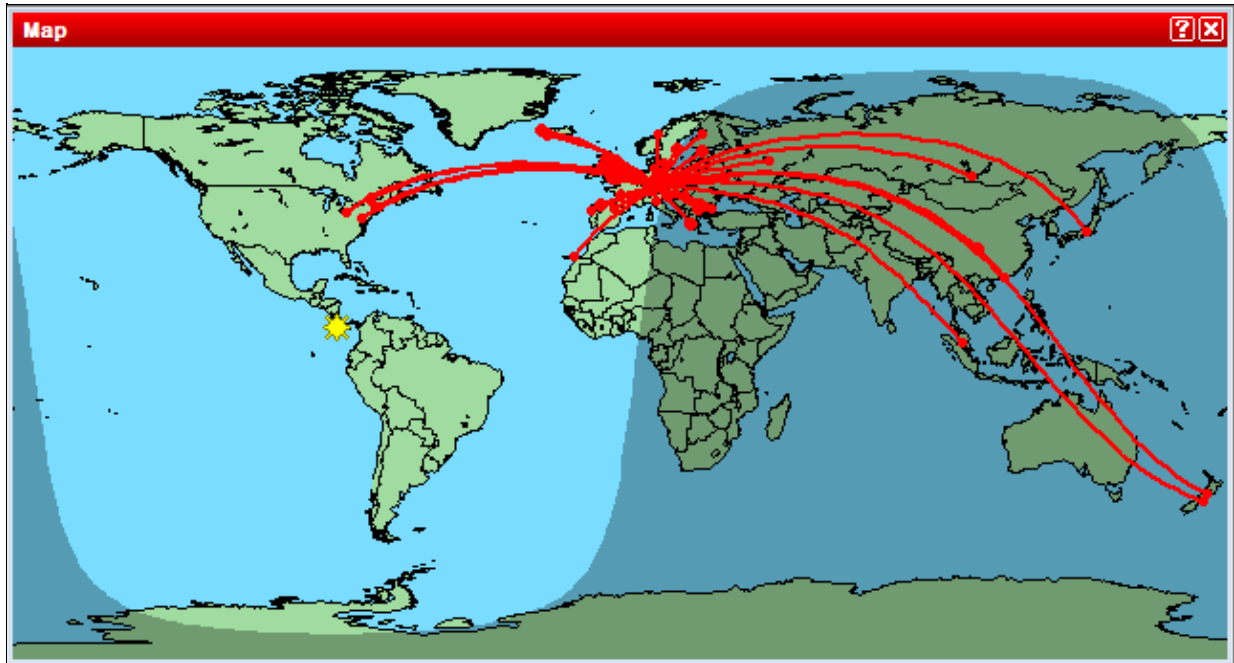

No higher resolution available.

[WorldMapWithRBNSpots2.gif](#) (642 × 346 pixels, file size: 23 KB, MIME type: image.gif)

## File history

Click on a date/time to view the file as it appeared at that time.

Date/Time	Thumbnail	Dimensions	User	Comment
current <a href="#">15:24, 9 April 2023</a>		642 × 346 (23 KB)	<a href="#">Dl6rai</a> ( <a href="#">talk</a>   <a href="#">contribs</a> )	

You cannot overwrite this file.

## File usage

The following page uses this file:

- [Menu:Windows](#)

## Metadata

This file contains additional information, probably added from the digital camera or scanner used to create or digitize it.

If the file has been modified from its original state, some details may not fully reflect the modified file.

**Horizontal resolution** 37.78 dpc

**Vertical resolution** 37.78 dpc

## Namespaces

- [File](#)
- [Discussion](#)

## Variants

## Views

- [Read](#)
- [View source](#)
- [View history](#)

## More

- This page was last edited on 9 April 2023, at 15:24.

- [Privacy policy](#)
- [About Win-Test Wiki](#)
- [Disclaimers](#)

- The logo consists of a blue square with a white sun icon on the left, followed by the text "Powered By" in a small font and "MediaWiki" in a larger font, all within a thin black border.

# File:WorldMapWithRBNSpotsContextMenu.gif

From Win-Test Wiki

[Jump to navigation](#) [Jump to search](#)

- [File](#)
- [File history](#)
- [File usage](#)
- [Metadata](#)

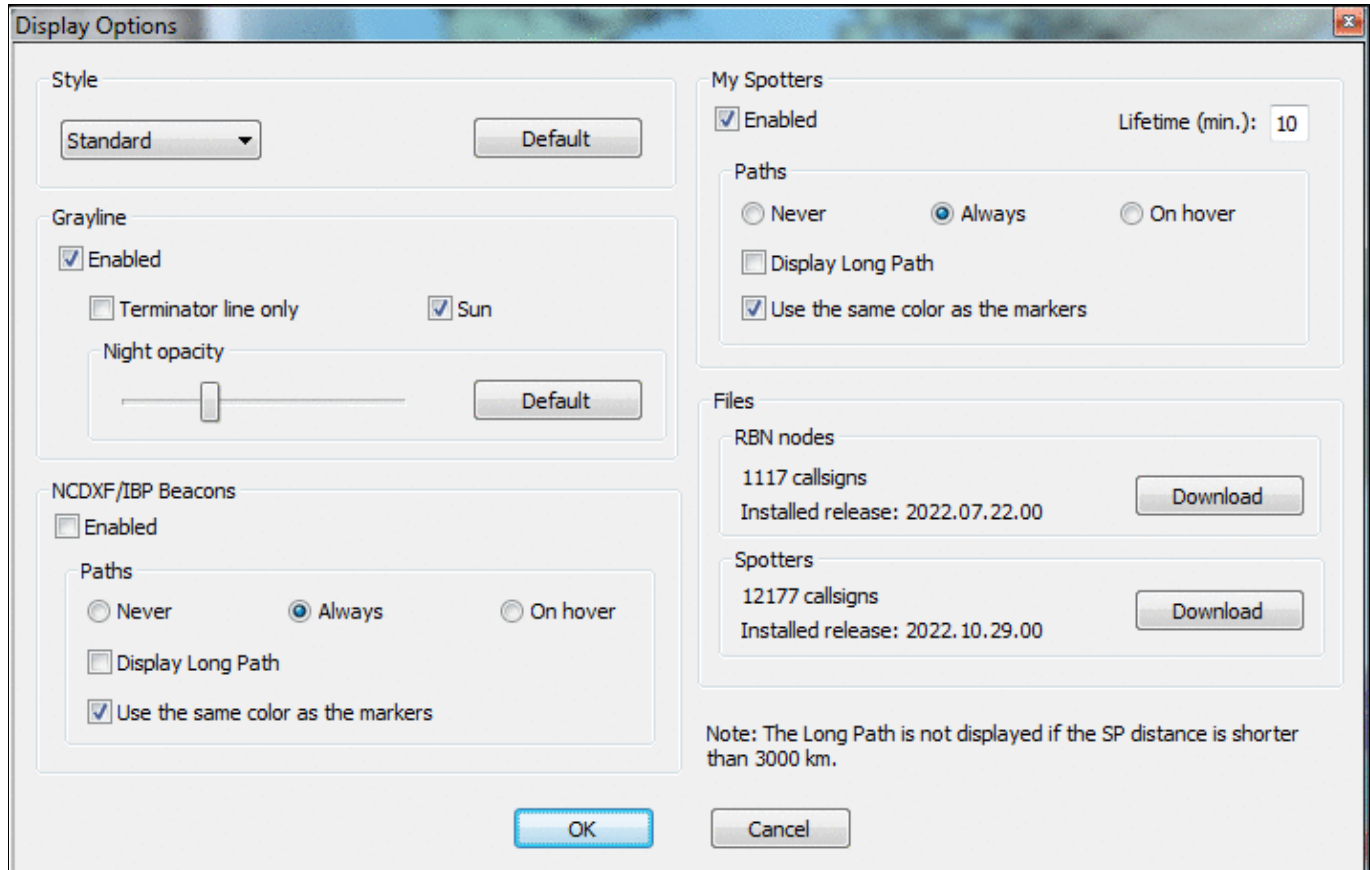

No higher resolution available.

WorldMapWithRBNSpotsContextMenu.gif (711 × 456 pixels, file size: 50 KB, MIME type: image.gif)

## File history

Click on a date/time to view the file as it appeared at that time.

	Date/Time	Thumbnail	Dimensions	User	Comment
current	<u>15:44, 9 April 2023</u>		711 × 456 (50 KB)	<u>Dl6rai</u> ( <a href="#">talk</a>   <a href="#">contribs</a> )	

You cannot overwrite this file.

## File usage

The following page uses this file:

- Menu:Windows

## Metadata

This file contains additional information, probably added from the digital camera or scanner used to create or digitize it.

If the file has been modified from its original state, some details may not fully reflect the modified file.

**Horizontal resolution** 37.79 dpc

**Vertical resolution** 37.79 dpc

## Namespaces

- File
- Discussion

## Variants

## Views

- Read
- View source
- View history

## More

- This page was last edited on 9 April 2023, at 15:44.
- Privacy policy

## Win-Test Wiki

- [About Win-Test Wiki](#)
- [Disclaimers](#)



# File:WorldMapWithRBNSpotsContextMenu.gif

From Win-Test Wiki

[Jump to navigation](#) [Jump to search](#)

- [File](#)
- [File history](#)
- [File usage](#)
- [Metadata](#)

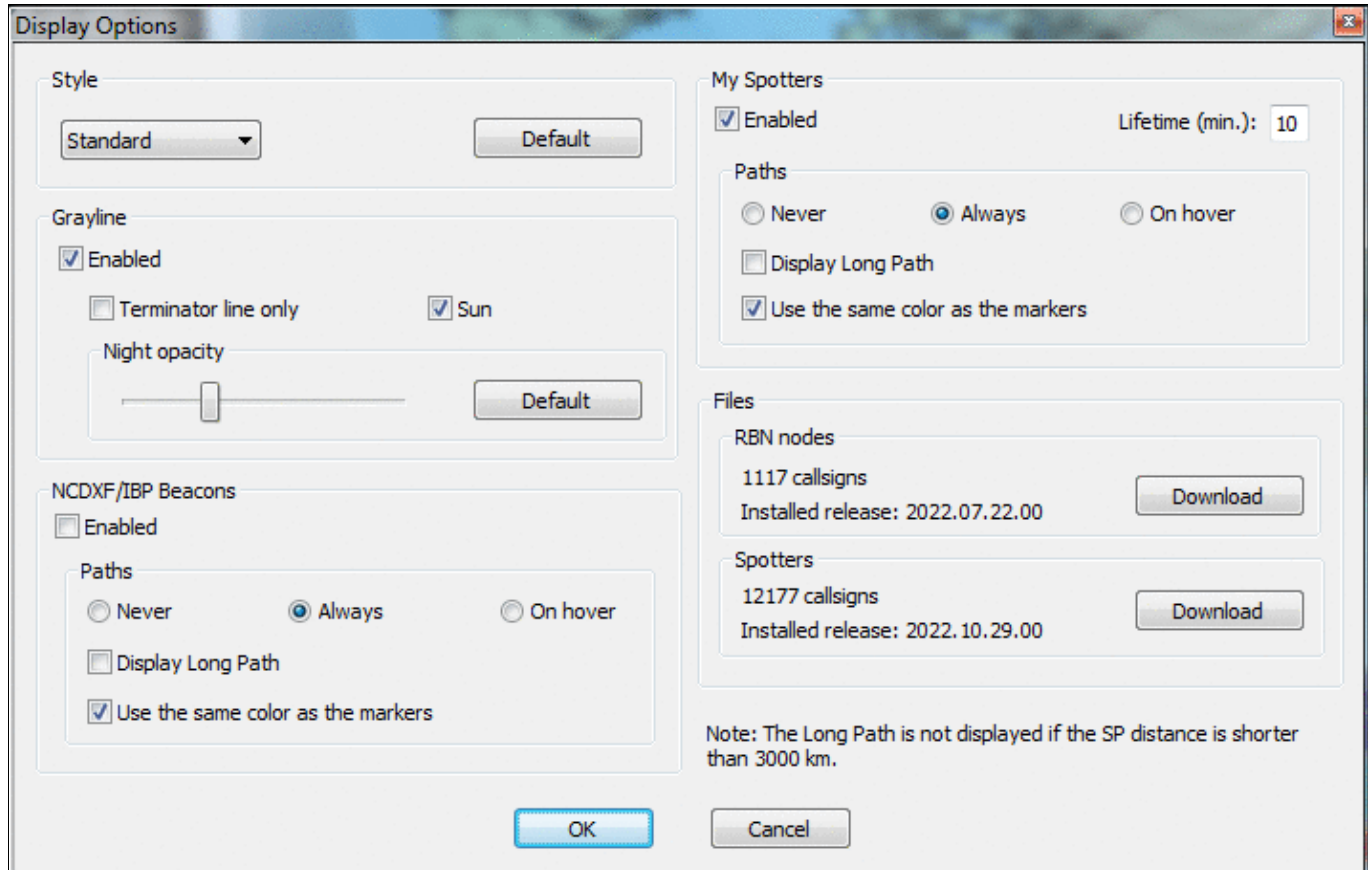

No higher resolution available.

WorldMapWithRBNSpotsContextMenu.gif (711 Å 456 pixels, file size: 50 KB, MIME type: image.gif)

## File history

Click on a date/time to view the file as it appeared at that time.

	Date/Time	Thumbnail	Dimensions	User	Comment
current	<u>15:44, 9 April 2023</u>		711 Å 456 (50 KB)	<u>Dl6rai</u> ( <a href="#">talk</a>   <a href="#">contribs</a> )	

You cannot overwrite this file.

## File usage

The following page uses this file:

- [Menu:Windows](#)

## Metadata

This file contains additional information, probably added from the digital camera or scanner used to create or digitize it.

If the file has been modified from its original state, some details may not fully reflect the modified file.

**Horizontal resolution** 37.79 dpc

**Vertical resolution** 37.79 dpc

## Namespaces

- [File](#)
- [Discussion](#)

## Variants

## Views

- [Read](#)
- [View source](#)
- [View history](#)

## More

- This page was last edited on 9 April 2023, at 15:44.
- [Privacy policy](#)

## Win-Test Wiki

- [About Win-Test Wiki](#)
- [Disclaimers](#)





# File:WtDxTelnetNetworkPropertiesMultiOp.gif

From Win-Test Wiki

[Jump to navigation](#) [Jump to search](#)

- [File](#)
- [File history](#)
- [File usage](#)

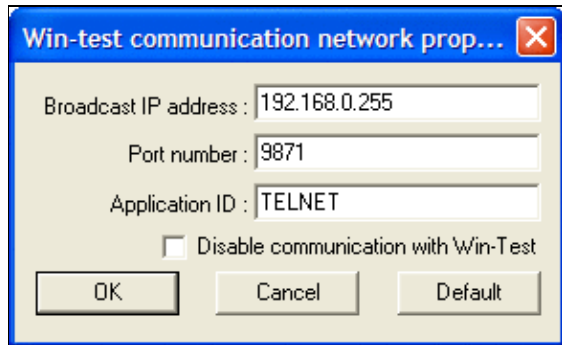

No higher resolution available.

[WtDxTelnetNetworkPropertiesMultiOp.gif](#) (291 × 178 pixels, file size: 9 KB, MIME type: image.gif)

## File history

Click on a date/time to view the file as it appeared at that time.

	Date/Time	Thumbnail	Dimensions	User	Comment
current	<a href="#">18:42, 26 July 2009</a>		291 × 178 (9 KB)	<a href="#">N6TV</a> ( <a href="#">talk</a>   <a href="#">contribs</a> )	

You cannot overwrite this file.

## File usage

The following page uses this file:

- [DX Cluster/Telnet](#)

## Namespaces

- [File](#)
- [Discussion](#)

## Variants

## Views

- [Read](#)
- [View source](#)
- [View history](#)

## More

- This page was last edited on 26 July 2009, at 18:42.

- [Privacy policy](#)
- [About Win-Test Wiki](#)
- [Disclaimers](#)



# File:WtDxTelnetNetworkPropertiesMultiOp.gif

From Win-Test Wiki

[Jump to navigation](#) [Jump to search](#)

- [File](#)
- [File history](#)
- [File usage](#)

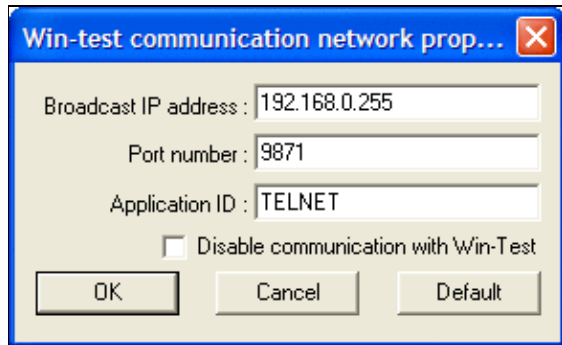

No higher resolution available.

[WtDxTelnetNetworkPropertiesMultiOp.gif](#) (291 × 178 pixels, file size: 9 KB, MIME type: image.gif)

## File history

Click on a date/time to view the file as it appeared at that time.

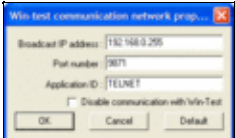
	Date/Time	Thumbnail	Dimensions	User	Comment
current	<a href="#">18:42, 26 July 2009</a>		291 × 178 (9 KB)	<a href="#">N6TV</a> ( <a href="#">talk</a>   <a href="#">contribs</a> )	

You cannot overwrite this file.

## File usage

The following page uses this file:

- [DX Cluster/Telnet](#)

## Namespaces

- [File](#)
- [Discussion](#)

## Variants

## Views

- [Read](#)
- [View source](#)
- [View history](#)

## More

- This page was last edited on 26 July 2009, at 18:42.

- [Privacy policy](#)
- [About Win-Test Wiki](#)
- [Disclaimers](#)



# File:Wtdxtelnet singleop.gif

From Win-Test Wiki

[Jump to navigation](#) [Jump to search](#)

- [File](#)
- [File history](#)
- [File usage](#)

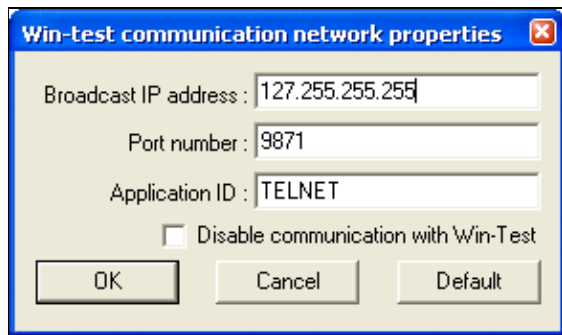

No higher resolution available.

[Wtdxtelnet\\_singleop.gif](#) (291 × 171 pixels, file size: 7 KB, MIME type: image.gif)

Win-Test network properties' dialog

## File history

Click on a date/time to view the file as it appeared at that time.

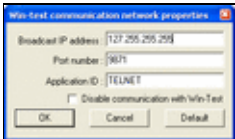
	Date/Time	Thumbnail	Dimensions	User	Comment
current	<a href="#">14:19, 5 January 2006</a>		291 × 171 (7 KB)	<a href="#">M0CLW (talk   contribs)</a>	Win-Test network properties' dialog

You cannot overwrite this file.

## File usage

The following page uses this file:

- [DX Cluster/Telnet](#)

## Namespaces

- [File](#)
- [Discussion](#)

## Variants

## Views

- [Read](#)
- [View source](#)
- [View history](#)

## More

- This page was last edited on 5 January 2006, at 14:19.

- [Privacy policy](#)
- [About Win-Test Wiki](#)
- [Disclaimers](#)



# File:Wtdxtnet singleop dxcp.gif

From Win-Test Wiki

[Jump to navigation](#) [Jump to search](#)

- [File](#)
- [File history](#)
- [File usage](#)





No higher resolution available.

[Wtdxtelnet\\_singleop\\_dxcp.gif](#) (338 Å 433 pixels, file size: 17 KB, MIME type: image.gif)

'wtdxtelnet dxcluster properties' dialog

## File history

Click on a date/time to view the file as it appeared at that time.

	Date/Time	Thumbnail	Dimensions	User	Comment
current	<a href="#">21:57, 26 November 2007</a>		338 Å 433 (17 KB)	<a href="#">N6TV (talk   contribs)</a>	Updated to show new options, improved spelling.
	<a href="#">14:19, 5 January 2006</a>		285 Å 314 (9 KB)	<a href="#">MOCLW (talk   contribs)</a>	'wtdxtelnet dxcluster properties' dialog

You cannot overwrite this file.

## File usage

The following page uses this file:

- [DX Cluster/Telnet](#)

## Namespaces

- [File](#)
- [Discussion](#)

## Variants

## Views

- [Read](#)
- [View source](#)
- [View history](#)

## More

- This page was last edited on 5 January 2006, at 14:19.



## Win-Test Wiki

- [Privacy policy](#)
- [About Win-Test Wiki](#)
- [Disclaimers](#)



# File:Wtdxtnet singleop dxcp.gif

From Win-Test Wiki

[Jump to navigation](#) [Jump to search](#)

- [File](#)
- [File history](#)
- [File usage](#)





No higher resolution available.

[Wtdxtelnet\\_singleop\\_dxcp.gif](#) (338 Å 433 pixels, file size: 17 KB, MIME type: image.gif)

'wtdxtelnet dxcluster properties' dialog

## File history

Click on a date/time to view the file as it appeared at that time.

	Date/Time	Thumbnail	Dimensions	User	Comment
current	<a href="#">21:57, 26 November 2007</a>		338 Å 433 (17 KB)	<a href="#">N6TV (talk   contribs)</a>	Updated to show new options, improved spelling.
	<a href="#">14:19, 5 January 2006</a>		285 Å 314 (9 KB)	<a href="#">MOCLW (talk   contribs)</a>	'wtdxtelnet dxcluster properties' dialog

You cannot overwrite this file.

## File usage

The following page uses this file:

- [DX Cluster/Telnet](#)

## Namespaces

- [File](#)
- [Discussion](#)

## Variants

## Views

- [Read](#)
- [View source](#)
- [View history](#)

## More

- This page was last edited on 5 January 2006, at 14:19.

## Win-Test Wiki

- [Privacy policy](#)
- [About Win-Test Wiki](#)
- [Disclaimers](#)



# File:Wtdxtelnet singleop.gif

From Win-Test Wiki

[Jump to navigation](#) [Jump to search](#)

- [File](#)
- [File history](#)
- [File usage](#)

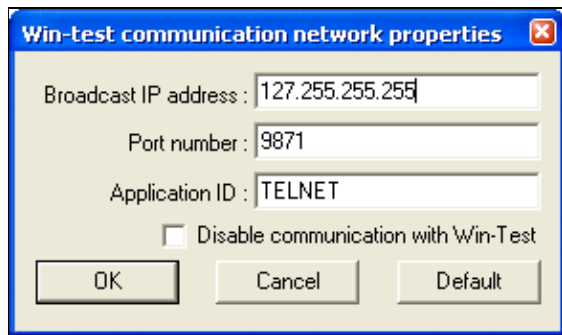

No higher resolution available.

[Wtdxtelnet\\_singleop.gif](#) (291 × 171 pixels, file size: 7 KB, MIME type: image.gif)

Win-Test network properties' dialog

## File history

Click on a date/time to view the file as it appeared at that time.

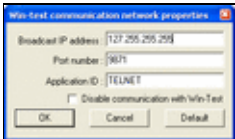
	Date/Time	Thumbnail	Dimensions	User	Comment
current	<a href="#">14:19, 5 January 2006</a>		291 × 171 (7 KB)	<a href="#">M0CLW</a> ( <a href="#">talk</a>   <a href="#">contribs</a> )	Win-Test network properties' dialog

You cannot overwrite this file.

## File usage

The following page uses this file:

- [DX Cluster/Telnet](#)

## Namespaces

- [File](#)
- [Discussion](#)

## Variants

## Views

- [Read](#)
- [View source](#)
- [View history](#)

## More

- This page was last edited on 5 January 2006, at 14:19.

- [Privacy policy](#)
- [About Win-Test Wiki](#)
- [Disclaimers](#)



# File:WTGoogleSearch.gif

From Win-Test Wiki

[Jump to navigation](#) [Jump to search](#)

- [File](#)
- [File history](#)
- [File usage](#)
- [Metadata](#)

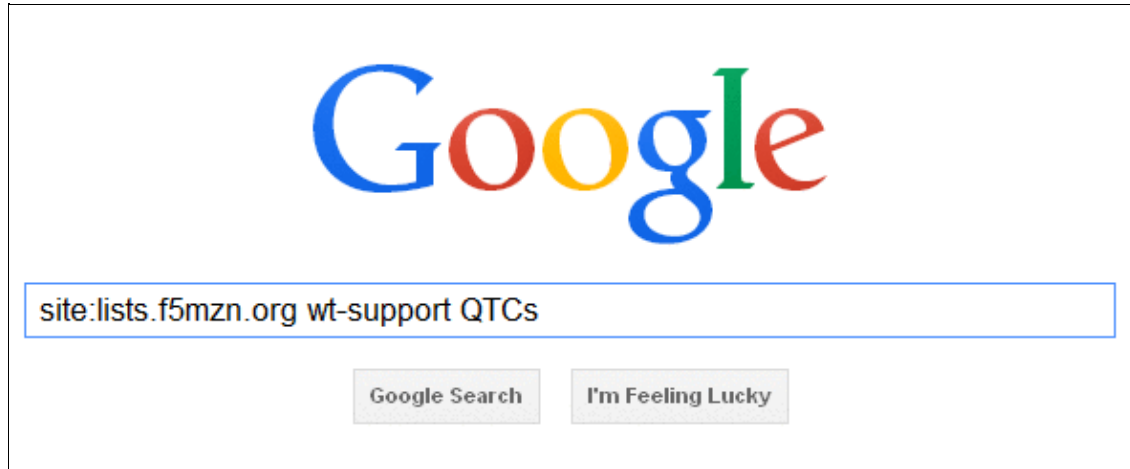

No higher resolution available.

[WTGoogleSearch.gif](#) (589 × 244 pixels, file size: 18 KB, MIME type: image/gif)

Illustrate how to search the Win-Test reflector archives using Google.

## File history

Click on a date/time to view the file as it appeared at that time.

	Date/Time	Thumbnail	Dimensions	User	Comment
current	<a href="#">00:39, 12 December 2013</a>		589 × 244 (18 KB)	<a href="#">N6TV (talk   contribs)</a>	Illustrate how to search the Win-Test reflector archives using Google.

You cannot overwrite this file.

## File usage

The following page uses this file:

- [Mailing List](#)

## Metadata

This file contains additional information, probably added from the digital camera or scanner used to create or digitize it.

If the file has been modified from its original state, some details may not fully reflect the modified file.

**Horizontal resolution** 37.78 dpc

**Vertical resolution** 37.78 dpc

## Namespaces

- [File](#)
- [Discussion](#)

## Variants

## Views

- [Read](#)
- [View source](#)
- [View history](#)

## More

- This page was last edited on 12 December 2013, at 00:39.

- [Privacy policy](#)
- [About Win-Test Wiki](#)
- [Disclaimers](#)

- The logo consists of a small sun icon to the left of the text "Powered By MediaWiki".



# File:WTGoogleSearch.gif

From Win-Test Wiki

[Jump to navigation](#) [Jump to search](#)

- [File](#)
- [File history](#)
- [File usage](#)
- [Metadata](#)

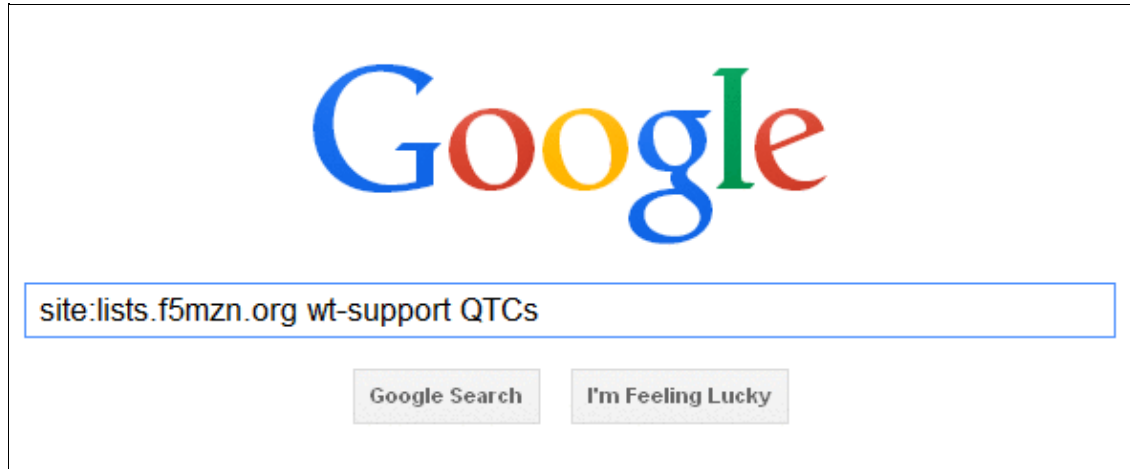

No higher resolution available.

[WTGoogleSearch.gif](#) (589 × 244 pixels, file size: 18 KB, MIME type: image.gif)

Illustrate how to search the Win-Test reflector archives using Google.

## File history

Click on a date/time to view the file as it appeared at that time.

	Date/Time	Thumbnail	Dimensions	User	Comment
current	<a href="#">00:39, 12 December 2013</a>		589 × 244 (18 KB)	<a href="#">N6TV (talk   contribs)</a>	Illustrate how to search the Win-Test reflector archives using Google.

You cannot overwrite this file.

## File usage

The following page uses this file:

- [Mailing List](#)

## Metadata

This file contains additional information, probably added from the digital camera or scanner used to create or digitize it.

If the file has been modified from its original state, some details may not fully reflect the modified file.

**Horizontal resolution** 37.78 dpc

**Vertical resolution** 37.78 dpc

## Namespaces

- [File](#)
- [Discussion](#)

## Variants

## Views

- [Read](#)
- [View source](#)
- [View history](#)

## More

- This page was last edited on 12 December 2013, at 00:39.

- [Privacy policy](#)
- [About Win-Test Wiki](#)
- [Disclaimers](#)

- The logo consists of a small square icon with a sun-like symbol on the left and the text "Powered By MediaWiki" on the right, all enclosed in a thin black border.

# File:WtRotatorsAddRotator.gif

From Win-Test Wiki

[Jump to navigation](#) [Jump to search](#)

- [File](#)
- [File history](#)
- [File usage](#)

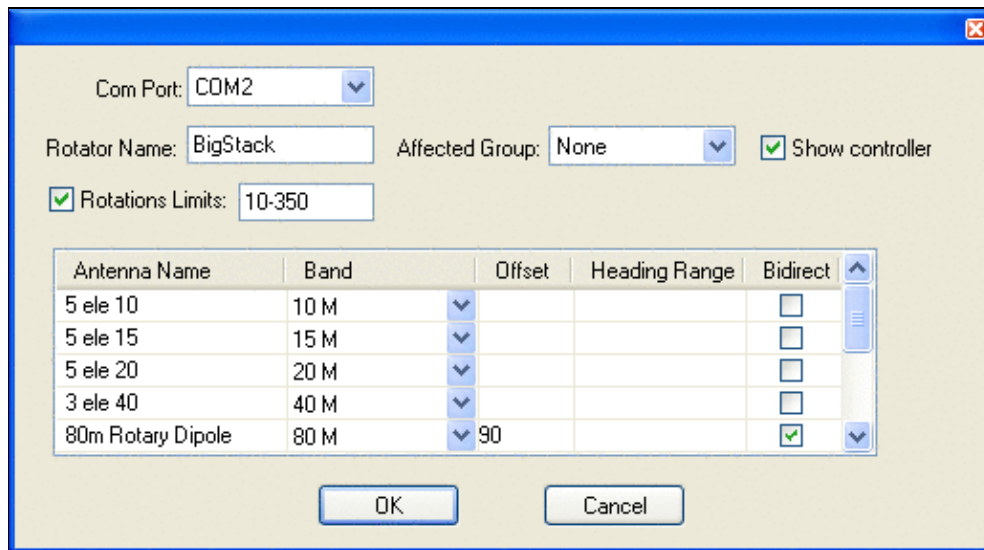

No higher resolution available.

[WtRotatorsAddRotator.gif](#) (516 × 285 pixels, file size: 14 KB, MIME type: image/gif)

Sample "Add / Edit" rotator dialog box.

## File history

Click on a date/time to view the file as it appeared at that time.

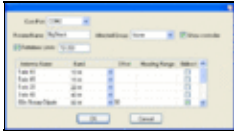
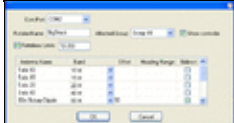
	Date/Time	Thumbnail	Dimensions	User	Comment
current	<a href="#">08:17, 26 July 2009</a>		516 × 285 (14 KB)	<a href="#">N6TV (talk   contribs)</a>	
	<a href="#">07:10, 26 July 2009</a>		516 × 285 (14 KB)	<a href="#">N6TV (talk   contribs)</a>	Sample "Add / Edit" rotator dialog box.

You cannot overwrite this file.

## File usage

The following page uses this file:

[File:WtRotatorsAddRotator.gif](#)

- [Rotators](#)

## Namespaces

- [File](#)
- [Discussion](#)

## Variants

## Views

- [Read](#)
- [View source](#)
- [View history](#)

## More

- This page was last edited on 26 July 2009, at 07:10.
- [Privacy policy](#)
- [About Win-Test Wiki](#)
- [Disclaimers](#)



# File:WtRotatorsAddRotator.gif

From Win-Test Wiki

[Jump to navigation](#) [Jump to search](#)

- [File](#)
- [File history](#)
- [File usage](#)

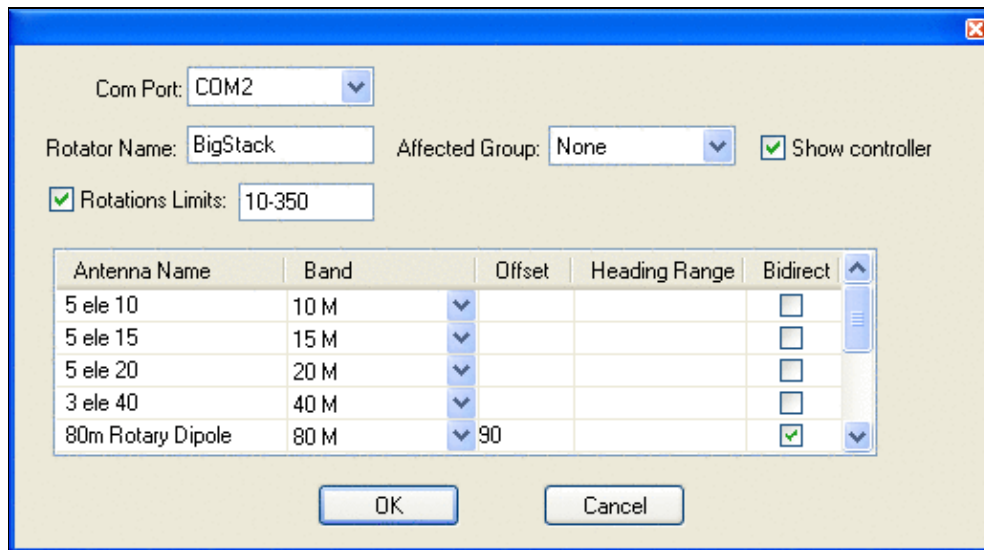

No higher resolution available.

[WtRotatorsAddRotator.gif](#) (516 × 285 pixels, file size: 14 KB, MIME type: image/gif)

Sample "Add / Edit" rotator dialog box.

## File history

Click on a date/time to view the file as it appeared at that time.

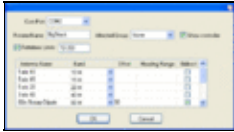
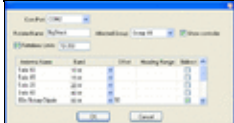
	Date/Time	Thumbnail	Dimensions	User	Comment
current	<a href="#">08:17, 26 July 2009</a>		516 × 285 (14 KB)	<a href="#">N6TV (talk   contribs)</a>	
	<a href="#">07:10, 26 July 2009</a>		516 × 285 (14 KB)	<a href="#">N6TV (talk   contribs)</a>	Sample "Add / Edit" rotator dialog box.

You cannot overwrite this file.

## File usage

The following page uses this file:

File:WtRotatorsAddRotator.gif

- [Rotators](#)

## Namespaces

- [File](#)
- [Discussion](#)

## Variants

## Views

- [Read](#)
- [View source](#)
- [View history](#)

## More

- This page was last edited on 26 July 2009, at 07:10.

- [Privacy policy](#)
- [About Win-Test Wiki](#)
- [Disclaimers](#)



# File:WtRotatorsControllersAdd.gif

From Win-Test Wiki

[Jump to navigation](#) [Jump to search](#)

- [File](#)
- [File history](#)
- [File usage](#)

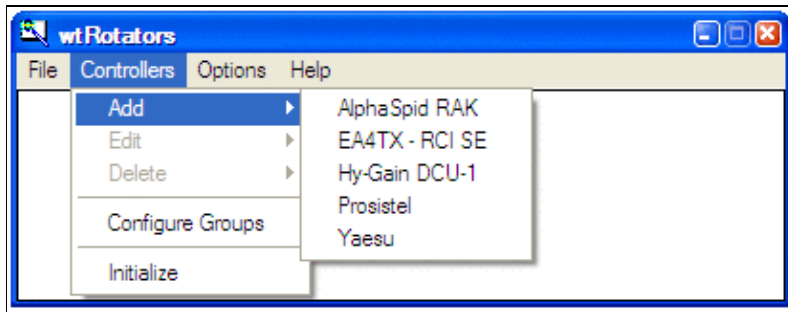

No higher resolution available.

[WtRotatorsControllersAdd.gif](#) (413 × 160 pixels, file size: 10 KB, MIME type: image.gif)

Shows Controllers | Add menu from wtRotators

## File history

Click on a date/time to view the file as it appeared at that time.

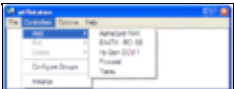
	Date/Time	Thumbnail	Dimensions	User	Comment
current	<a href="#">06:38, 26 July 2009</a>		413 × 160 (10 KB)	<a href="#">N6TV</a> ( <a href="#">talk</a>   <a href="#">contribs</a> )	Shows Controllers   Add menu from wtRotators

You cannot overwrite this file.

## File usage

The following page uses this file:

- [Rotators](#)

## Namespaces

- [File](#)
- [Discussion](#)

## Variants

## Views

- [Read](#)
- [View source](#)
- [View history](#)

## More

- This page was last edited on 26 July 2009, at 06:38.

- [Privacy policy](#)
- [About Win-Test Wiki](#)
- [Disclaimers](#)





# File:WtRotatorsControllersAdd.gif

From Win-Test Wiki

[Jump to navigation](#) [Jump to search](#)

- [File](#)
- [File history](#)
- [File usage](#)

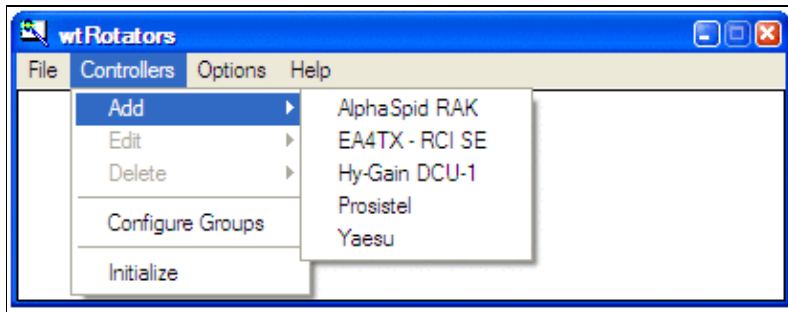

No higher resolution available.

[WtRotatorsControllersAdd.gif](#) (413 × 160 pixels, file size: 10 KB, MIME type: image.gif)

Shows Controllers | Add menu from wtRotators

## File history

Click on a date/time to view the file as it appeared at that time.

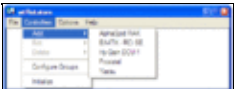
	Date/Time	Thumbnail	Dimensions	User	Comment
current	<a href="#">06:38, 26 July 2009</a>		413 × 160 (10 KB)	<a href="#">N6TV</a> ( <a href="#">talk</a>   <a href="#">contribs</a> )	Shows Controllers   Add menu from wtRotators

You cannot overwrite this file.

## File usage

The following page uses this file:

- [Rotators](#)

## Namespaces

- [File](#)
- [Discussion](#)

## Variants

## Views

- [Read](#)
- [View source](#)
- [View history](#)

## More

- This page was last edited on 26 July 2009, at 06:38.

- [Privacy policy](#)
- [About Win-Test Wiki](#)
- [Disclaimers](#)



# File:WtRotatorsControllerWindow.gif

From Win-Test Wiki

[Jump to navigation](#) [Jump to search](#)

- [File](#)
- [File history](#)
- [File usage](#)
- [Metadata](#)

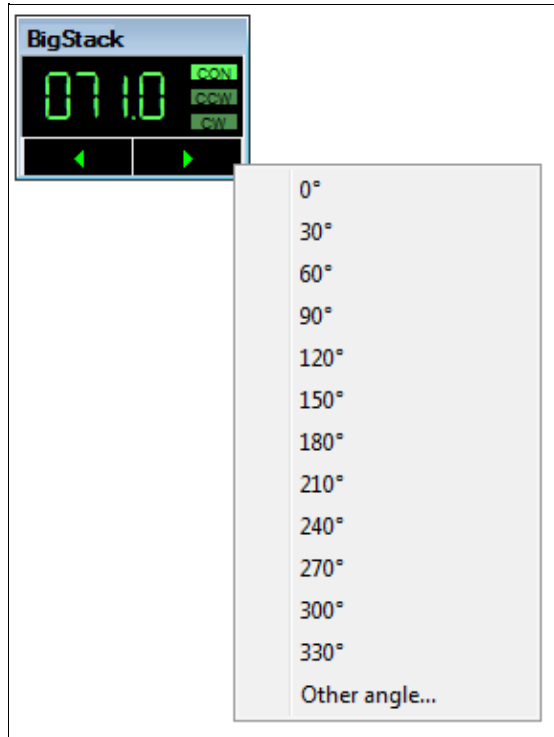



No higher resolution available.

[WtRotatorsControllerWindow.gif](#) (288 × 385 pixels, file size: 6 KB, MIME type: image/gif)

The wtRotators Controller window

## File history

Click on a date/time to view the file as it appeared at that time.

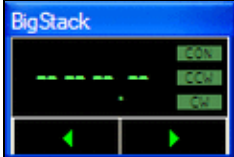
	Date/Time	Thumbnail	Dimensions	User	Comment
current	<a href="#">06:14, 19 February 2016</a>		288 × 385 (6 KB)	<a href="#">N6TV (talk   contribs)</a>	Show what it looks like when actually connected to a rotator.
	<a href="#">05:36, 28 July 2009</a>		244 × 313 (7 KB)	<a href="#">N6TV (talk   contribs)</a>	Updated version with standard Windows screen colors.
	<a href="#">18:21, 27 July 2009</a>		240 × 297 (6 KB)	<a href="#">N6TV (talk   contribs)</a>	Updated version shows pop-up menu
	<a href="#">07:03, 26 July 2009</a>		123 × 85 (3 KB)	<a href="#">N6TV (talk   contribs)</a>	The wtRotators Controller window

You cannot overwrite this file.

## File usage

The following page uses this file:

- [Rotators](#)

## Metadata

This file contains additional information, probably added from the digital camera or scanner used to create or digitize it.

If the file has been modified from its original state, some details may not fully reflect the modified file.

**Horizontal resolution** 37.78 dpc

**Vertical resolution** 37.78 dpc

## Namespaces

- [File](#)
- [Discussion](#)

## Variants

## Views

- [Read](#)
- [View source](#)
- [View history](#)

## More

- This page was last edited on 19 February 2016, at 06:14.
- [Privacy policy](#)
- [About Win-Test Wiki](#)
- [Disclaimers](#)



# File:WtRotatorsControllerWindow.gif

From Win-Test Wiki

[Jump to navigation](#) [Jump to search](#)

- [File](#)
- [File history](#)
- [File usage](#)
- [Metadata](#)

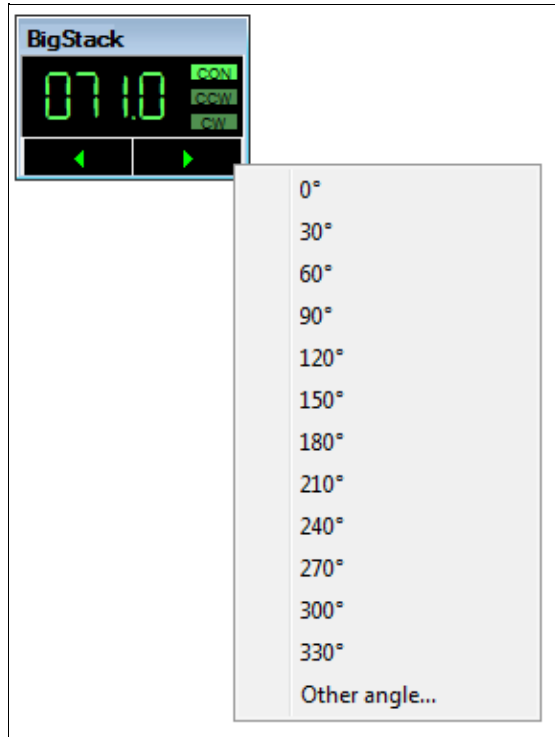



No higher resolution available.

[WtRotatorsControllerWindow.gif](#) (288 × 385 pixels, file size: 6 KB, MIME type: image/gif)

The wtRotators Controller window

## File history

Click on a date/time to view the file as it appeared at that time.

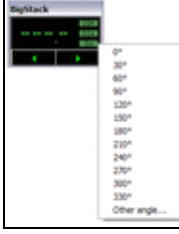
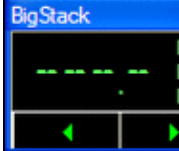
	Date/Time	Thumbnail	Dimensions	User	Comment
current	<a href="#">06:14, 19 February 2016</a>		288 × 385 (6 KB)	<a href="#">N6TV (talk   contribs)</a>	Show what it looks like when actually connected to a rotator.
	<a href="#">05:36, 28 July 2009</a>		244 × 313 (7 KB)	<a href="#">N6TV (talk   contribs)</a>	Updated version with standard Windows screen colors.
	<a href="#">18:21, 27 July 2009</a>		240 × 297 (6 KB)	<a href="#">N6TV (talk   contribs)</a>	Updated version shows pop-up menu
	<a href="#">07:03, 26 July 2009</a>		123 × 85 (3 KB)	<a href="#">N6TV (talk   contribs)</a>	The wtRotators Controller window

You cannot overwrite this file.

## File usage

The following page uses this file:

- [Rotators](#)

## Metadata

This file contains additional information, probably added from the digital camera or scanner used to create or digitize it.

If the file has been modified from its original state, some details may not fully reflect the modified file.

**Horizontal resolution** 37.78 dpc

**Vertical resolution** 37.78 dpc

## Namespaces

- [File](#)
- [Discussion](#)

## Variants

## Views

- [Read](#)
- [View source](#)
- [View history](#)

## More

- This page was last edited on 19 February 2016, at 06:14.
- [Privacy policy](#)
- [About Win-Test Wiki](#)
- [Disclaimers](#)





# File:WtRotatorsHeadingRange.gif

From Win-Test Wiki

[Jump to navigation](#) [Jump to search](#)

- [File](#)
- [File history](#)
- [File usage](#)

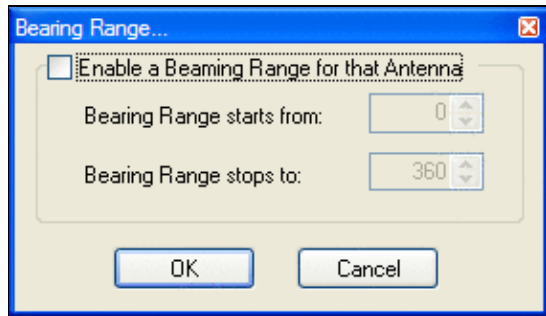

No higher resolution available.

[WtRotatorsHeadingRange.gif](#) (282 × 162 pixels, file size: 7 KB, MIME type: image.gif)

wtRotators Heading Range pop-up dialog

## File history

Click on a date/time to view the file as it appeared at that time.

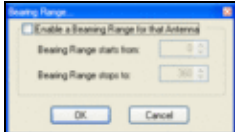
	Date/Time	Thumbnail	Dimensions	User	Comment
current	<a href="#">08:37, 26 July 2009</a>		282 × 162 (7 KB)	<a href="#">N6TV (talk   contribs)</a>	wtRotators Heading Range pop-up dialog

You cannot overwrite this file.

## File usage

The following page uses this file:

- [Rotators](#)

## Namespaces

- [File](#)
- [Discussion](#)

## Variants

## Views

- [Read](#)
- [View source](#)
- [View history](#)

## More

- This page was last edited on 26 July 2009, at 08:37.

- [Privacy policy](#)
- [About Win-Test Wiki](#)
- [Disclaimers](#)



# File:WtRotatorsHeadingRange.gif

From Win-Test Wiki

[Jump to navigation](#) [Jump to search](#)

- [File](#)
- [File history](#)
- [File usage](#)

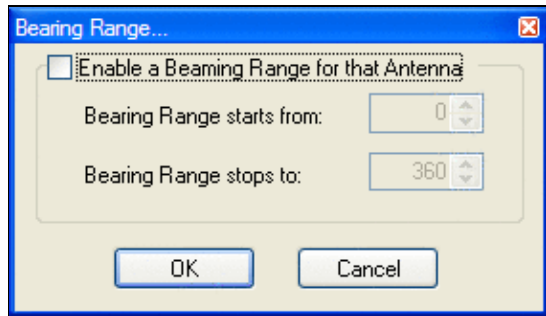

No higher resolution available.

[WtRotatorsHeadingRange.gif](#) (282 × 162 pixels, file size: 7 KB, MIME type: image/gif)

wtRotators Heading Range pop-up dialog

## File history

Click on a date/time to view the file as it appeared at that time.

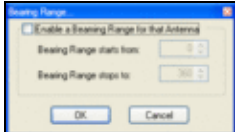
	Date/Time	Thumbnail	Dimensions	User	Comment
current	<a href="#">08:37, 26 July 2009</a>		282 × 162 (7 KB)	<a href="#">N6TV (talk   contribs)</a>	wtRotators Heading Range pop-up dialog

You cannot overwrite this file.

## File usage

The following page uses this file:

- [Rotators](#)

## Namespaces

- [File](#)
- [Discussion](#)

## Variants

## Views

- [Read](#)
- [View source](#)
- [View history](#)

## More

- This page was last edited on 26 July 2009, at 08:37.

- [Privacy policy](#)
- [About Win-Test Wiki](#)
- [Disclaimers](#)



# File:WtRotatorsNetworkPropertiesMultiOp.gif

From Win-Test Wiki

[Jump to navigation](#) [Jump to search](#)

- [File](#)
- [File history](#)
- [File usage](#)

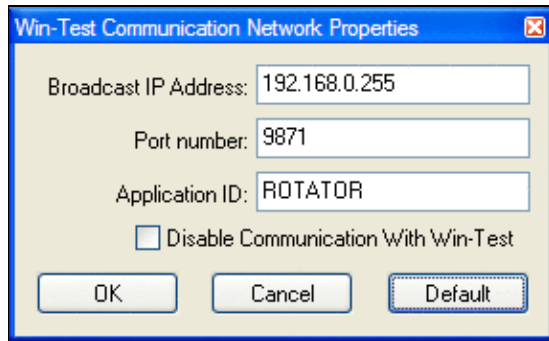

No higher resolution available.

[WtRotatorsNetworkPropertiesMultiOp.gif](#) (285 × 175 pixels, file size: 8 KB, MIME type: image.gif)

Network settings for a multi-op using the default broadcast IP address.

## File history

Click on a date/time to view the file as it appeared at that time.

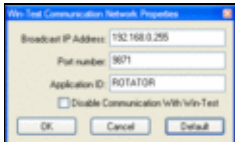
	Date/Time	Thumbnail	Dimensions	User	Comment
current	<a href="#">08:47, 26 July 2009</a>		285 × 175 (8 KB)	<a href="#">N6TV</a> ( <a href="#">talk</a>   <a href="#">contribs</a> )	Network settings for a multi-op using the default broadcast IP address.

You cannot overwrite this file.

## File usage

The following page uses this file:

- [Rotators](#)

## Namespaces

- [File](#)
- [Discussion](#)

## Variants

## Views

- [Read](#)
- [View source](#)
- [View history](#)

## More

- This page was last edited on 26 July 2009, at 08:47.

- [Privacy policy](#)
- [About Win-Test Wiki](#)
- [Disclaimers](#)



# File:WtRotatorsNetworkPropertiesMultiOp.gif

From Win-Test Wiki

[Jump to navigation](#) [Jump to search](#)

- [File](#)
- [File history](#)
- [File usage](#)

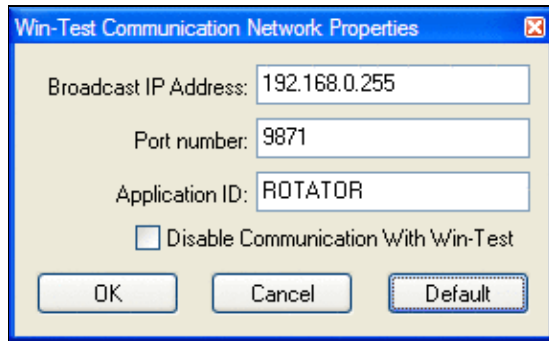

No higher resolution available.

[WtRotatorsNetworkPropertiesMultiOp.gif](#) (285 × 175 pixels, file size: 8 KB, MIME type: image.gif)

Network settings for a multi-op using the default broadcast IP address.

## File history

Click on a date/time to view the file as it appeared at that time.

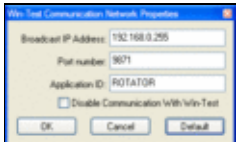
	Date/Time	Thumbnail	Dimensions	User	Comment
current	<a href="#">08:47, 26 July 2009</a>		285 × 175 (8 KB)	<a href="#">N6TV</a> ( <a href="#">talk</a>   <a href="#">contribs</a> )	Network settings for a multi-op using the default broadcast IP address.

You cannot overwrite this file.

## File usage

The following page uses this file:

- [Rotators](#)

## Namespaces

- [File](#)
- [Discussion](#)

## Variants

## Views

- [Read](#)
- [View source](#)
- [View history](#)

## More

- This page was last edited on 26 July 2009, at 08:47.

- [Privacy policy](#)
- [About Win-Test Wiki](#)
- [Disclaimers](#)





# File:WtRotatorsNetworkPropertiesSingleOp.PNG

From Win-Test Wiki

[Jump to navigation](#) [Jump to search](#)

- [File](#)
- [File history](#)
- [File usage](#)

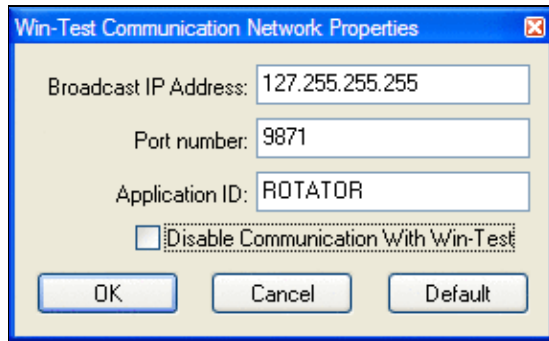

No higher resolution available.

[WtRotatorsNetworkPropertiesSingleOp.PNG](#) (285 × 175 pixels, file size: 8 KB, MIME type: image.gif)

Network properties window from wtRotators, with loopback address for single PC stations.

## File history

Click on a date/time to view the file as it appeared at that time.

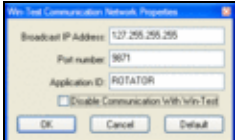
	Date/Time	Thumbnail	Dimensions	User	Comment
current	<a href="#">05:50, 26 July 2009</a>		285 × 175 (8 KB)	<a href="#">N6TV (talk   contribs)</a>	Network properties window from wtRotators, with loopback address for single PC stations.

You cannot overwrite this file.

## File usage

The following page uses this file:

- [Rotators](#)

## Namespaces

- [File](#)
- [Discussion](#)

## Variants

## Views

- [Read](#)
- [View source](#)
- [View history](#)

## More

- This page was last edited on 26 July 2009, at 05:50.

- [Privacy policy](#)
- [About Win-Test Wiki](#)
- [Disclaimers](#)



# File:WtRotatorsNetworkPropertiesSingleOp.PNG

From Win-Test Wiki

[Jump to navigation](#) [Jump to search](#)

- [File](#)
- [File history](#)
- [File usage](#)

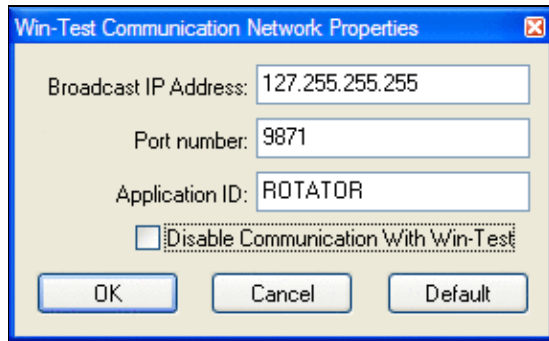

No higher resolution available.

[WtRotatorsNetworkPropertiesSingleOp.PNG](#) (285 × 175 pixels, file size: 8 KB, MIME type: image.gif)

Network properties window from wtRotators, with loopback address for single PC stations.

## File history

Click on a date/time to view the file as it appeared at that time.

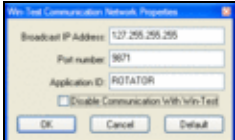
	Date/Time	Thumbnail	Dimensions	User	Comment
current	<a href="#">05:50, 26 July 2009</a>		285 × 175 (8 KB)	<a href="#">N6TV (talk   contribs)</a>	Network properties window from wtRotators, with loopback address for single PC stations.

You cannot overwrite this file.

## File usage

The following page uses this file:

- [Rotators](#)

## Namespaces

- [File](#)
- [Discussion](#)

## Variants

## Views

- [Read](#)
- [View source](#)
- [View history](#)

## More

- This page was last edited on 26 July 2009, at 05:50.

- [Privacy policy](#)
- [About Win-Test Wiki](#)
- [Disclaimers](#)



# File:WtRotatorsOffset.PNG

From Win-Test Wiki

[Jump to navigation](#) [Jump to search](#)

- [File](#)
- [File history](#)
- [File usage](#)



No higher resolution available.

[WtRotatorsOffset.PNG](#) (237 × 128 pixels, file size: 5 KB, MIME type: image.gif)

[Rotator offset pop-up menu](#)

## File history

Click on a date/time to view the file as it appeared at that time.

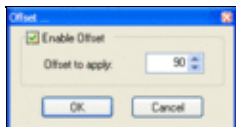
	Date/Time	Thumbnail	Dimensions	User	Comment
current	<a href="#">06:48, 26 July 2009</a>		237 × 128 (5 KB)	<a href="#">N6TV</a> ( <a href="#">talk</a>   <a href="#">contribs</a> )	Rotator offset pop-up menu

You cannot overwrite this file.

## File usage

The following page uses this file:

- [Rotators](#)

## Namespaces

- [File](#)
- [Discussion](#)

## Variants

## Views

- [Read](#)
- [View source](#)
- [View history](#)

## More

- This page was last edited on 26 July 2009, at 06:48.

- [Privacy policy](#)
- [About Win-Test Wiki](#)
- [Disclaimers](#)



# File:WtRotatorsOffset.PNG

From Win-Test Wiki

[Jump to navigation](#) [Jump to search](#)

- [File](#)
- [File history](#)
- [File usage](#)



No higher resolution available.

[WtRotatorsOffset.PNG](#) (237 × 128 pixels, file size: 5 KB, MIME type: image.gif)

[Rotator offset pop-up menu](#)

## File history

Click on a date/time to view the file as it appeared at that time.

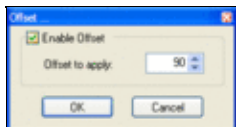
	Date/Time	Thumbnail	Dimensions	User	Comment
current	<a href="#">06:48, 26 July 2009</a>		237 × 128 (5 KB)	<a href="#">N6TV</a> ( <a href="#">talk</a>   <a href="#">contribs</a> )	Rotator offset pop-up menu

You cannot overwrite this file.

## File usage

The following page uses this file:

- [Rotators](#)

## Namespaces

- [File](#)
- [Discussion](#)

## Variants

## Views

- [Read](#)
- [View source](#)
- [View history](#)

## More

- This page was last edited on 26 July 2009, at 06:48.

- [Privacy policy](#)
- [About Win-Test Wiki](#)
- [Disclaimers](#)





# File:WtRotatorsOptions.gif

From Win-Test Wiki

[Jump to navigation](#) [Jump to search](#)

- [File](#)
- [File history](#)
- [File usage](#)

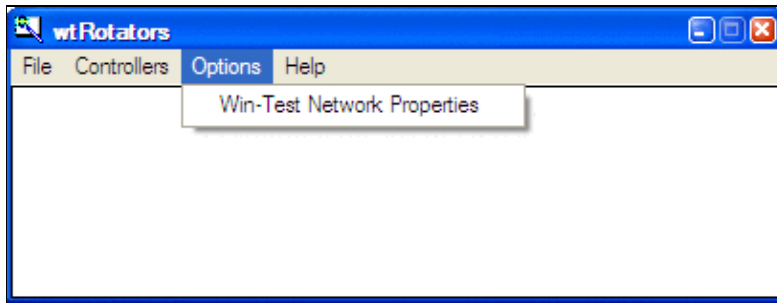

No higher resolution available.

[WtRotatorsOptions.gif](#) (408 × 156 pixels, file size: 7 KB, MIME type: image/gif)

## File history

Click on a date/time to view the file as it appeared at that time.

	Date/Time	Thumbnail	Dimensions	User	Comment
current	<a href="#">06:25, 26 July 2009</a>		408 × 156 (7 KB)	<a href="#">N6TV</a> ( <a href="#">talk</a>   <a href="#">contribs</a> )	

You cannot overwrite this file.

## File usage

The following page uses this file:

- [Rotators](#)

## Namespaces

- [File](#)
- [Discussion](#)

## Variants

## Views

- [Read](#)

- [View source](#)
- [View history](#)

## More

- This page was last edited on 26 July 2009, at 06:25.

- [Privacy policy](#)
- [About Win-Test Wiki](#)
- [Disclaimers](#)



# File:WtRotatorsOptions.gif

From Win-Test Wiki

[Jump to navigation](#) [Jump to search](#)

- [File](#)
- [File history](#)
- [File usage](#)

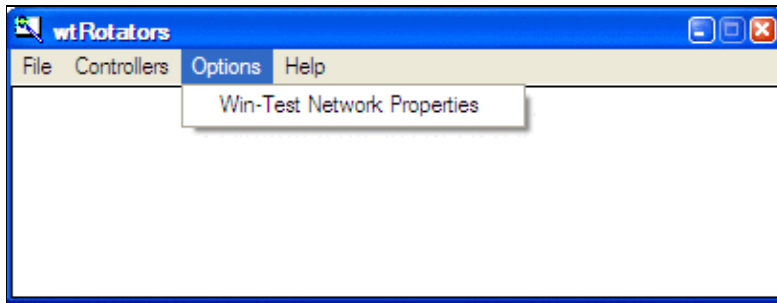

No higher resolution available.

[WtRotatorsOptions.gif](#) (408 × 156 pixels, file size: 7 KB, MIME type: image.gif)

## File history

Click on a date/time to view the file as it appeared at that time.

	Date/Time	Thumbnail	Dimensions	User	Comment
current	<a href="#">06:25, 26 July 2009</a>		408 × 156 (7 KB)	<a href="#">N6TV</a> ( <a href="#">talk</a>   <a href="#">contribs</a> )	

You cannot overwrite this file.

## File usage

The following page uses this file:

- [Rotators](#)

## Namespaces

- [File](#)
- [Discussion](#)

## Variants

## Views

- [Read](#)

- [View source](#)
- [View history](#)

## More

- This page was last edited on 26 July 2009, at 06:25.

- [Privacy policy](#)
- [About Win-Test Wiki](#)
- [Disclaimers](#)



# File:WtRotatorsRotationLimits.gif

From Win-Test Wiki

[Jump to navigation](#) [Jump to search](#)

- [File](#)
- [File history](#)
- [File usage](#)

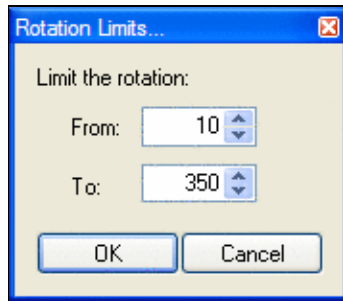

No higher resolution available.

[WtRotatorsRotationLimits.gif](#) (177 × 154 pixels, file size: 5 KB, MIME type: image.gif)

## File history

Click on a date/time to view the file as it appeared at that time.

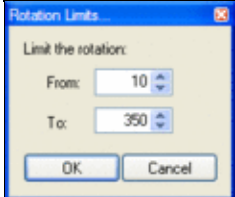
	Date/Time	Thumbnail	Dimensions	User	Comment
current	<a href="#">07:46, 26 July 2009</a>		177 × 154 (5 KB)	<a href="#">N6TV</a> ( <a href="#">talk</a>   <a href="#">contribs</a> )	

You cannot overwrite this file.

## File usage

The following page uses this file:

- [Rotators](#)

## Namespaces

- [File](#)
- [Discussion](#)

## Variants

## Views

- [Read](#)
- [View source](#)
- [View history](#)

## More

- This page was last edited on 26 July 2009, at 07:46.

- [Privacy policy](#)
- [About Win-Test Wiki](#)
- [Disclaimers](#)



# File:WtRotatorsRotationLimits.gif

From Win-Test Wiki

[Jump to navigation](#) [Jump to search](#)

- [File](#)
- [File history](#)
- [File usage](#)

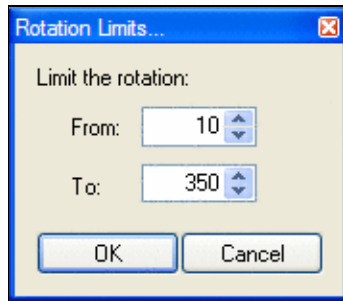

No higher resolution available.

[WtRotatorsRotationLimits.gif](#) (177 × 154 pixels, file size: 5 KB, MIME type: image.gif)

## File history

Click on a date/time to view the file as it appeared at that time.

	Date/Time	Thumbnail	Dimensions	User	Comment
current	<a href="#">07:46, 26 July 2009</a>		177 × 154 (5 KB)	<a href="#">N6TV</a> ( <a href="#">talk</a>   <a href="#">contribs</a> )	

You cannot overwrite this file.

## File usage

The following page uses this file:

- [Rotators](#)

## Namespaces

- [File](#)
- [Discussion](#)

## Variants

## Views

- [Read](#)
- [View source](#)
- [View history](#)

## More

- This page was last edited on 26 July 2009, at 07:46.

- [Privacy policy](#)
- [About Win-Test Wiki](#)
- [Disclaimers](#)





# File:WtRotatorsStatusMessages.gif

From Win-Test Wiki

[Jump to navigation](#) [Jump to search](#)

- [File](#)
- [File history](#)
- [File usage](#)

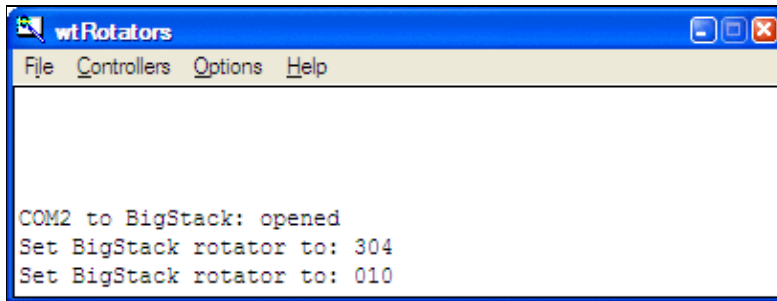

No higher resolution available.

[WtRotatorsStatusMessages.gif](#) (408 × 155 pixels, file size: 8 KB, MIME type: image.gif)

WtRotators window with status messages.

## File history

Click on a date/time to view the file as it appeared at that time.

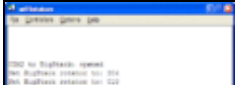
	Date/Time	Thumbnail	Dimensions	User	Comment
current	<a href="#">07:09, 26 July 2009</a>		408 × 155 (8 KB)	<a href="#">N6TV</a> ( <a href="#">talk</a>   <a href="#">contribs</a> )	WtRotators window with status messages.

You cannot overwrite this file.

## File usage

The following page uses this file:

- [Rotators](#)

## Namespaces

- [File](#)
- [Discussion](#)

## Variants

## Views

- [Read](#)
- [View source](#)
- [View history](#)

## More

- This page was last edited on 26 July 2009, at 07:09.

- [Privacy policy](#)
- [About Win-Test Wiki](#)
- [Disclaimers](#)



# File:WtRotatorsStatusMessages.gif

From Win-Test Wiki

[Jump to navigation](#) [Jump to search](#)

- [File](#)
- [File history](#)
- [File usage](#)

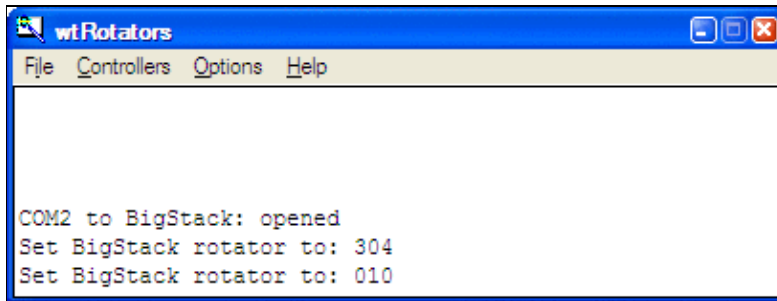

No higher resolution available.

[WtRotatorsStatusMessages.gif](#) (408 × 155 pixels, file size: 8 KB, MIME type: image.gif)

WtRotators window with status messages.

## File history

Click on a date/time to view the file as it appeared at that time.

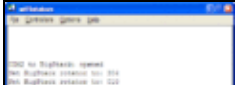
	Date/Time	Thumbnail	Dimensions	User	Comment
current	<a href="#">07:09, 26 July 2009</a>		408 × 155 (8 KB)	<a href="#">N6TV</a> ( <a href="#">talk</a>   <a href="#">contribs</a> )	WtRotators window with status messages.

You cannot overwrite this file.

## File usage

The following page uses this file:

- [Rotators](#)

## Namespaces

- [File](#)
- [Discussion](#)

## Variants

## Views

- [Read](#)
- [View source](#)
- [View history](#)

## More

- This page was last edited on 26 July 2009, at 07:09.

- [Privacy policy](#)
- [About Win-Test Wiki](#)
- [Disclaimers](#)



# File:WtRotatorsWindowsSecurityAlert.gif

From Win-Test Wiki

[Jump to navigation](#) [Jump to search](#)

- [File](#)
- [File history](#)
- [File usage](#)

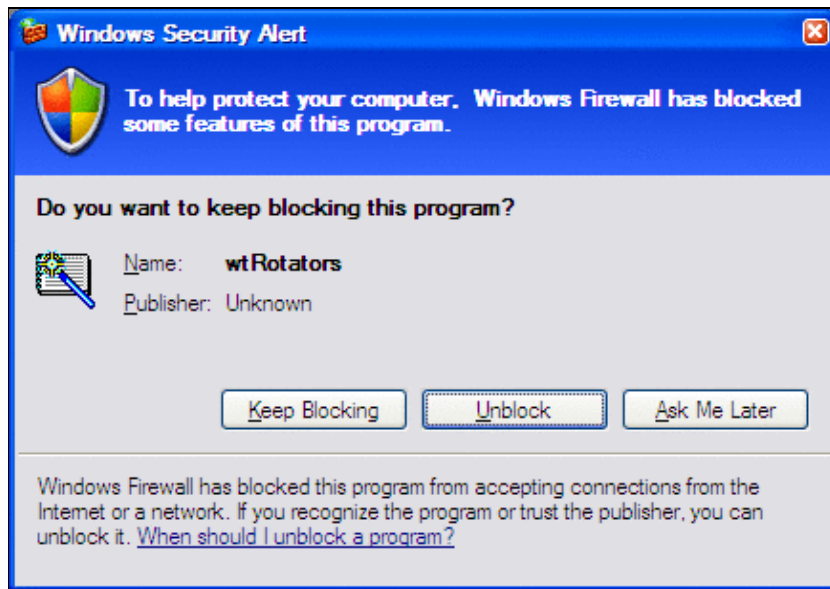

No higher resolution available.

[WtRotatorsWindowsSecurityAlert.gif](#) (434 × 305 pixels, file size: 21 KB, MIME type: image/gif)

Security alert that may appear the first time you try to configure wtRotators

## File history

Click on a date/time to view the file as it appeared at that time.

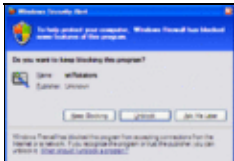
	Date/Time	Thumbnail	Dimensions	User	Comment
current	<a href="#">06:19, 26 July 2009</a>		434 × 305 (21 KB)	<a href="#">N6TV</a> ( <a href="#">talk</a>   <a href="#">contribs</a> )	Security alert that may appear the first time you try to configure wtRotators

You cannot overwrite this file.

## File usage

The following page uses this file:

- [Rotators](#)

## Namespaces

- [File](#)
- [Discussion](#)

## Variants

## Views

- [Read](#)
- [View source](#)
- [View history](#)

## More

- This page was last edited on 26 July 2009, at 06:19.

- [Privacy policy](#)
- [About Win-Test Wiki](#)
- [Disclaimers](#)

- The logo consists of a small sun icon to the left of the text "Powered By MediaWiki". The text is in a blue, sans-serif font, and the entire logo is enclosed in a thin black rectangular border.

# File:WtRotatorsWindowsSecurityAlert.gif

From Win-Test Wiki

[Jump to navigation](#) [Jump to search](#)

- [File](#)
- [File history](#)
- [File usage](#)

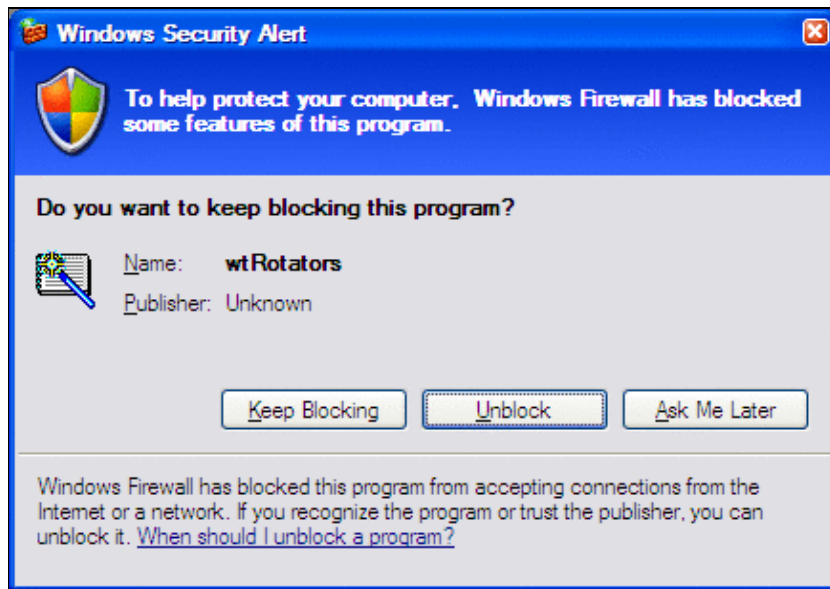

No higher resolution available.

[WtRotatorsWindowsSecurityAlert.gif](#) (434 × 305 pixels, file size: 21 KB, MIME type: image/gif)

Security alert that may appear the first time you try to configure wtRotators

## File history

Click on a date/time to view the file as it appeared at that time.

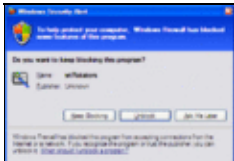
	Date/Time	Thumbnail	Dimensions	User	Comment
current	<a href="#">06:19, 26 July 2009</a>		434 × 305 (21 KB)	<a href="#">N6TV</a> ( <a href="#">talk</a>   <a href="#">contribs</a> )	Security alert that may appear the first time you try to configure wtRotators

You cannot overwrite this file.

## File usage

The following page uses this file:

- [Rotators](#)

## Namespaces

- [File](#)
- [Discussion](#)

## Variants

## Views

- [Read](#)
- [View source](#)
- [View history](#)

## More

- This page was last edited on 26 July 2009, at 06:19.

- [Privacy policy](#)
- [About Win-Test Wiki](#)
- [Disclaimers](#)





# Multi-op/Gabbing

From Win-Test Wiki

[Jump to navigation](#) [Jump to search](#)

Messaging gabbing in Win-Test allows stations in a multi-op situation to send messages to one another, for example to alert an operator of another station that a multiplier has been moved from one band to another, etc.

## Sending a message to another station

Sending a message to a specific station (or all stations) on the network is simply a case of using **Alt+G** and typing the text you wish to send. You will notice a drop-down list just to the left of the text entry field which is where you choose which station you wish to send the message to - by default, this is set to 'all' to send the message network-wide.

By default, the message gab (**Alt+G**) window will look like this:

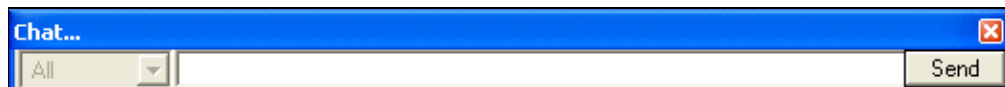

After you have typed your message, simply press **ENTER** (or click the 'send' button).

## Receiving gab messages

Using **Alt+I** or using the Windows | Gab menu option will open a separate window within Win-Test that shows all recent gab messages that have arrived at your operating position. Please note that you do **not** need this window open constantly to receive gab messages from other stations on the network - it shall open automatically when a message is received and close again automatically after a short period of time.

**Alt+I** can be useful to see a message that might have been sent earlier, or perhaps if you somehow missed the last message sent to your operating position you can use **Alt+I** to view the message.

## See also

- [Passing multipliers between stations](#)

## Namespaces

- [Page](#)
- [Discussion](#)

## Variants

## Views

- [Read](#)
- [View source](#)
- [View history](#)

## More

- This page was last edited on 26 March 2011, at 04:54.

- [Privacy policy](#)
- [About Win-Test Wiki](#)
- [Disclaimers](#)



# HamCAP

From Win-Test Wiki

[Jump to navigation](#) [Jump to search](#)

## Contents

- [1 Introduction](#)
- [2 Set preferences](#)
- [3 Set Parameters](#)
- [4 Set TX and RX antennas](#)
- [5 See Also](#)
  - ◆ [5.1 In the manual](#)
  - ◆ [5.2 External sources](#)

## Introduction

This chapter will give information and references to install and configure [Ham CAP](#) by VE3NEA to be used in conjunction with Win-Test.

If not done already, go to the [Ham CAP](#) web site, download and install this freeware package, along with its pre-requisite [VOACAP v.08.1124W](#) package. Ham CAP may *not* work with other versions of VOACAP due to formatting changes.

HamCAP is quite easy to configure to suite for your needs and, if you follow the User's guide and Tutorial you can find at the end of this chapter, it will be straightforward.

## Set preferences

Within the Settings tab you can set the latitude and longitude coordinates of your QTH (the approximation to 1 degree is enough for our needs).

**Home** coordinates are essentials to have the propagation forecast directly related to your QTH.

In this tab you can also check the options related to what information you want to see in the **Chart** and in the **Map** tabs, as well as the **Map Style** and **Map Resolution**, to best suite your look and feel preferences.

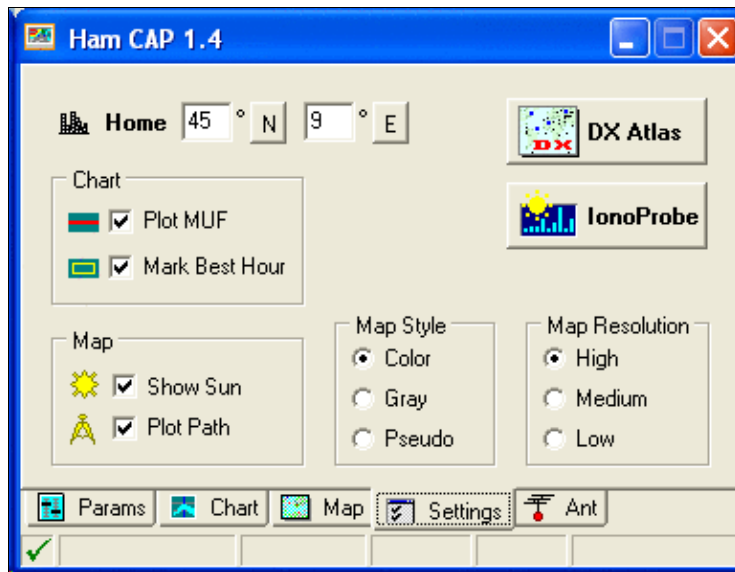

HamCAP Settings tab

A setup like the one shown in the picture above is generally easy to view.

If you are using also IonoProbe, and want it to update the Solar parameters, just press the **IonoProbe** button, and you are done; if this is the case, you should select Options | HamCAP | Solar Indexes passing to None.

## Set Parameters

Within the Params tab you can set your transmitting **Power** and to determine whether you want the **Short Path** or **Long Path** propagation forecast.

You should also set the **SSN** (Sun Spot Number) value, which is useful if HamCAP is working in stand-alone mode, otherwise this value will be set by IonoProbe or by Win-Test itself each time HamCAP will be invoked.

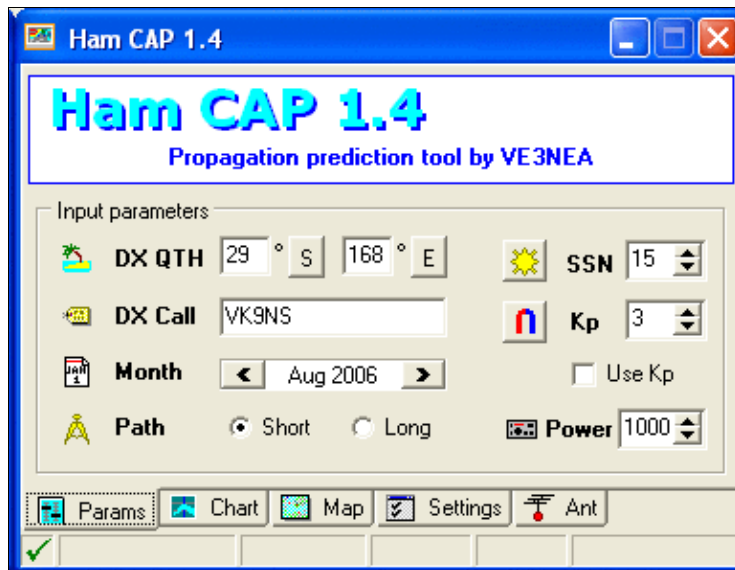

### HamCAP Params tab

Usually the **Month** is automatically set by HamCAP itself, and is related to the actual date; this should usually be a "don't care", unless you want to make a forecast for the next CQWW six months ahead from today!

Also the **DX QTH** and **DX Call** are set by the call from Win-Test, related to the callsign in the entry field for which the **Ctrl-P** has been invoked.

For the **Kp** value, as well the **Use Kp** checkbox, please refer to the HamCAP documentation referenced at the end of this chapter; as a starting point, these are almost a "don't care" as well.

## Set TX and RX antennas

Within the Ant tab you should describe your antenna farm, in the **TX Antennas** frame, and what you can presume, or you are interested in, for your correspondent in the **RX Antennas** frame.

These information are used by HamCAP to calculate the estimated S/N ratio.

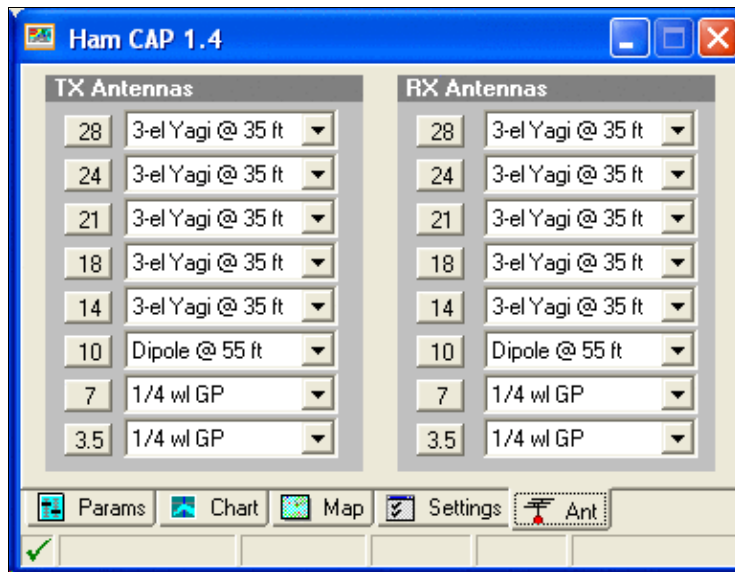

HamCAP Ant tab

Please refer to the HamCAP documentation, referenced below at the end of this chapter, for a better understanding of this setup.

## See Also

### In the manual

- [Menu:Options HamCAP](#)
- [Menu:Commands Propagation forecast](#)
- [Menu:Windows Solar Activity](#)

### External sources

Two very comprehensive guides:

- [HamCAP User's Guide by OH6BG](#)
- [HamCAP tutorial by VE3SUN](#)

## Namespaces

- [Page](#)
- [Discussion](#)

## Variants

## Views

- [Read](#)
- [View source](#)
- [View history](#)

## More

- This page was last edited on 24 November 2009, at 18:40.

- [Privacy policy](#)
- [About Win-Test Wiki](#)
- [Disclaimers](#)



# HamCAP

From Win-Test Wiki

[Jump to navigation](#) [Jump to search](#)

## Contents

- [1 Introduction](#)
- [2 Set preferences](#)
- [3 Set Parameters](#)
- [4 Set TX and RX antennas](#)
- [5 See Also](#)
  - ◆ [5.1 In the manual](#)
  - ◆ [5.2 External sources](#)

## Introduction

This chapter will give information and references to install and configure [Ham CAP](#) by VE3NEA to be used in conjunction with Win-Test.

If not done already, go to the [Ham CAP](#) web site, download and install this freeware package, along with its pre-requisite [VOACAP v.08.1124W](#) package. Ham CAP may *not* work with other versions of VOACAP due to formatting changes.

HamCAP is quite easy to configure to suite for your needs and, if you follow the User's guide and Tutorial you can find at the end of this chapter, it will be straightforward.

## Set preferences

Within the Settings tab you can set the latitude and longitude coordinates of your QTH (the approximation to 1 degree is enough for our needs).

**Home** coordinates are essentials to have the propagation forecast directly related to your QTH.

In this tab you can also check the options related to what information you want to see in the **Chart** and in the **Map** tabs, as well as the **Map Style** and **Map Resolution**, to best suite your look and feel preferences.



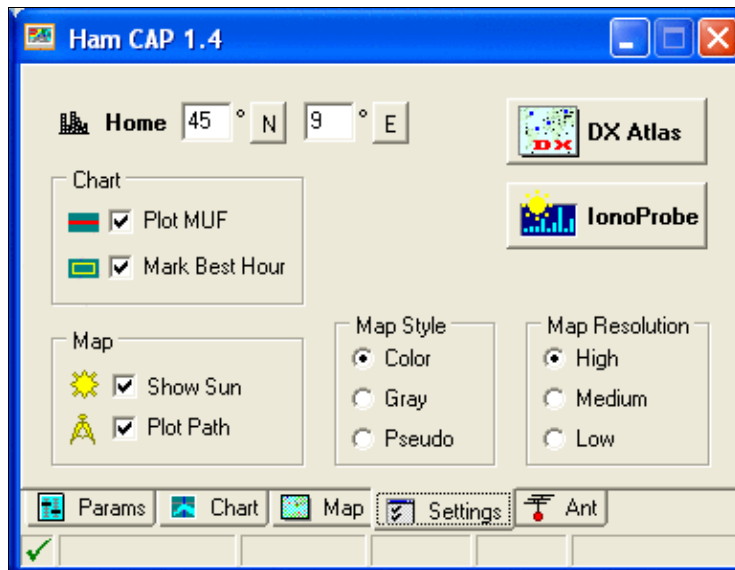

HamCAP Settings tab

A setup like the one shown in the picture above is generally easy to view.

If you are using also IonoProbe, and want it to update the Solar parameters, just press the **IonoProbe** button, and you are done; if this is the case, you should select Options | HamCAP | Solar Indexes passing to None.

## Set Parameters

Within the Params tab you can set your transmitting **Power** and to determine whether you want the **Short Path** or **Long Path** propagation forecast.

You should also set the **SSN** (Sun Spot Number) value, which is useful if HamCAP is working in stand-alone mode, otherwise this value will be set by IonoProbe or by Win-Test itself each time HamCAP will be invoked.

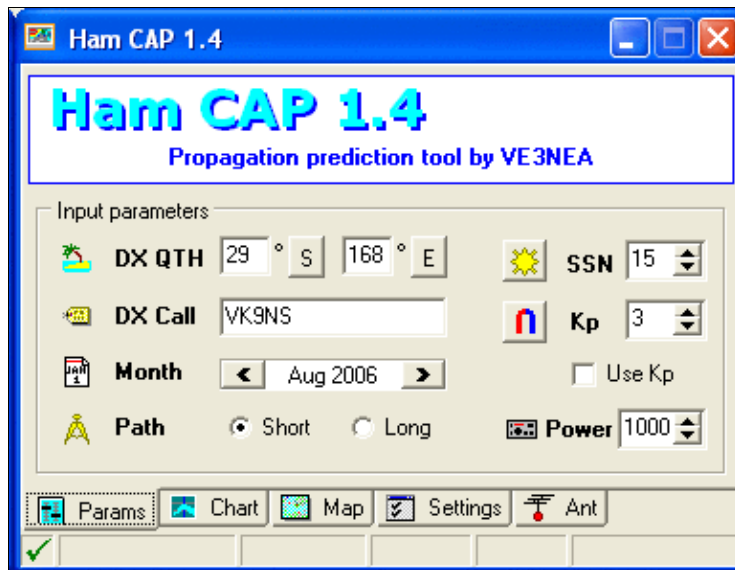

### HamCAP Params tab

Usually the **Month** is automatically set by HamCAP itself, and is related to the actual date; this should usually be a "don't care", unless you want to make a forecast for the next CQWW six months ahead from today!

Also the **DX QTH** and **DX Call** are set by the call from Win-Test, related to the callsign in the entry field for which the **Ctrl-P** has been invoked.

For the **Kp** value, as well the **Use Kp** checkbox, please refer to the HamCAP documentation referenced at the end of this chapter; as a starting point, these are almost a "don't care" as well.

## Set TX and RX antennas

Within the Ant tab you should describe your antenna farm, in the **TX Antennas** frame, and what you can presume, or you are interested in, for your correspondent in the **RX Antennas** frame.

These information are used by HamCAP to calculate the estimated S/N ratio.

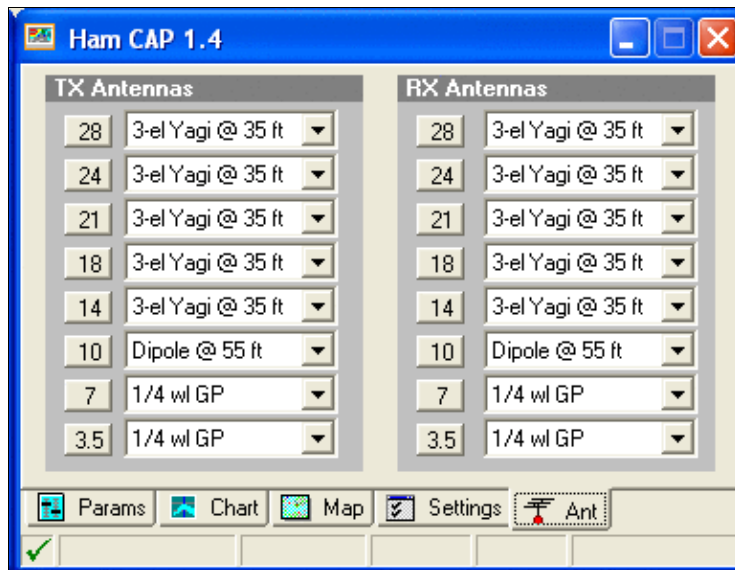

HamCAP Ant tab

Please refer to the HamCAP documentation, referenced below at the end of this chapter, for a better understanding of this setup.

## See Also

### In the manual

- [Menu:Options HamCAP](#)
- [Menu:Commands Propagation forecast](#)
- [Menu:Windows Solar Activity](#)

### External sources

Two very comprehensive guides:

- [HamCAP User's Guide by OH6BG](#)
- [HamCAP tutorial by VE3SUN](#)

## Namespaces

- [Page](#)
- [Discussion](#)

## Variants

## Views

- [Read](#)
- [View source](#)
- [View history](#)

## More

- This page was last edited on 24 November 2009, at 18:40.

- [Privacy policy](#)
- [About Win-Test Wiki](#)
- [Disclaimers](#)



# Icon bar

From Win-Test Wiki

[Jump to navigation](#) [Jump to search](#)

This dockable icons bar allows a quick access to some Win-Test menus.



Win-Test Icons bar

From left to right :

- File / New
- File / Open
- File / Close
  
- Commands / QSY / Up
- Commands / QSY / Down
- Commands / Keyboard mode
  
- Messages / Send a gab
- Messages / Write a note regarding to this QSO
- Commands / DX cluster
- Commands / Spot
  
- Windows / Check multipliers
- Windows / Summary
- Windows / Check partials
- Windows / N + 1
- Windows / Status
- Windows / Skeds
- Windows / Rate
- Windows / rate sheet
- Windows / Gab
- Windows / World map
- Windows / DX-Cluster monitor
- Windows / DX-Cluster announcements
  
- Windows / Radio 1
- Windows / Radio 2
- Commands / Split frequency

Note that you can save space on your screen by hiding this bar. See the [Option Toolbar](#) menu.

[Back to Main Page](#)

## Namespaces

- [Page](#)
- [Discussion](#)

## Variants

## Views

- [Read](#)
- [View source](#)
- [View history](#)

## More

- This page was last edited on 15 March 2007, at 09:14.
- [Privacy policy](#)
- [About Win-Test Wiki](#)
- [Disclaimers](#)



# Icon bar

From Win-Test Wiki

[Jump to navigation](#) [Jump to search](#)

This dockable icons bar allows a quick access to some Win-Test menus.



Win-Test Icons bar

From left to right :

- File / New
- File / Open
- File / Close
  
- Commands / QSY / Up
- Commands / QSY / Down
- Commands / Keyboard mode
  
- Messages / Send a gab
- Messages / Write a note regarding to this QSO
- Commands / DX cluster
- Commands / Spot
  
- Windows / Check multipliers
- Windows / Summary
- Windows / Check partials
- Windows / N + 1
- Windows / Status
- Windows / Skeds
- Windows / Rate
- Windows / rate sheet
- Windows / Gab
- Windows / World map
- Windows / DX-Cluster monitor
- Windows / DX-Cluster announcements
  
- Windows / Radio 1
- Windows / Radio 2
- Commands / Split frequency

Note that you can save space on your screen by hiding this bar. See the [Option Toolbar](#) menu.

[Back to Main Page](#)

## Namespaces

- [Page](#)
- [Discussion](#)

## Variants

## Views

- [Read](#)
- [View source](#)
- [View history](#)

## More

- This page was last edited on 15 March 2007, at 09:14.
- [Privacy policy](#)
- [About Win-Test Wiki](#)
- [Disclaimers](#)





# Installation

From Win-Test Wiki

[Jump to navigation](#) [Jump to search](#)

**Attention:** For detailed screen shots describing how to purchase, download, install, register, and configure Win-Test, please review the *Win-Test Installation, Registration, and Configuration Guide* by following one of the links on the [FAQ Page](#).

## Download the software

Win-Test is provided as a trial version, free to use for 15 days. You can download it from <http://www.win-test.com>.

The trial version randomly quits, between 30 minutes and 2 hours after startup, and exported files (Cabrillo, Reg1test, ADIF) are limited to 50 QSOs.

If you wish to use Win-Test without these limitations, or if the 15-day trial period has expired, you can [purchase a licence](#) and register the software for a fee of 50 EUR.

One licence entitles you to use Win-Test on an unlimited number of computers. However, registration keys must be provided on each computer which can be requested [here](#).

If you fail to receive an email with your registration details, please check your spam folder. Occasionally, Win-Test emails end up in spam due to the content of the email being written in three different languages.

Should you have any issues, please use the [mailing list](#) for further support.

## Install the software

Install the software in a directory on your harddisk you like, normally in

```
C:\Program Files (x86)\Win-Test.
```

You can install new versions over a previous version. If you upgrade to a new major version (like from V3 to V4) your old registration key will become invalid and you'll have to acquire a new one.

Although a Windows program, some have managed to get Win-Test [running on Linux](#) in a Windows Emulator called wine on Linux.

## Registering the software

You can register the software [here](#).

After you have entered your registration details, you will *not* see a "thanks for registering" dialog or such-like; however, you can confirm registration was successful by restarting Win-Test and if all went well, you will no longer have to press the [1], [2], or [3] buttons.

## Namespaces

- [Page](#)
- [Discussion](#)

## Variants

## Views

- [Read](#)
- [View source](#)
- [View history](#)

## More

- This page was last edited on 11 April 2023, at 15:15.

- [Privacy policy](#)
- [About Win-Test Wiki](#)
- [Disclaimers](#)



# Interfaces

From Win-Test Wiki

[Jump to navigation](#) [Jump to search](#)

Configuration of interfaces in Win-Test needs only be done once, rather than on a per-contest basis. This means you do not waste time remembering your interface configuration details prior to each contest!

## Contents

- [1 Interface configuration](#)
  - ◆ [1.1 Radio configuration](#)
- [2 Configuring other interfaces](#)
  - ◆ [2.1 COM-port CW keying](#)
  - ◆ [2.2 LPT-port CW keying](#)
  - ◆ [2.3 Digital Voice Keyer](#)
  - ◆ [2.4 Sound Card](#)
  - ◆ [2.5 Band Data](#)
  - ◆ [2.6 Radio 1/Radio 2](#)
  - ◆ [2.7 Headphones Control](#)
- [3 See Also](#)
  - ◆ [3.1 From the Win-Test manual](#)
  - ◆ [3.2 External sources](#)

## Interface configuration

The [interface configuration window](#) can be opened by clicking on Options->Configure Interfaces menu in the main Win-Test window, or via the text command **SETUP**.

## Radio configuration

At the bottom of the window there is a "Transceivers" section which includes two drop-down lists where you set your radio type (**Radio 1** and **Radio 2**). First, choose your rig make and model from the appropriate list. Please note that there is only one "Kenwood" entry in the list because all Kenwood rigs use a common protocol.

On the left hand side of the window, you will see a list of COM ports (only available COM ports on your system will be selectable, others will be greyed-out). Serial ports COM1...COM32 can be selected (higher ports available by scrolling down). After you have chosen the manufacturer and/or model of your rig, check the box corresponding to the COM port to which your radio is connected. For example:

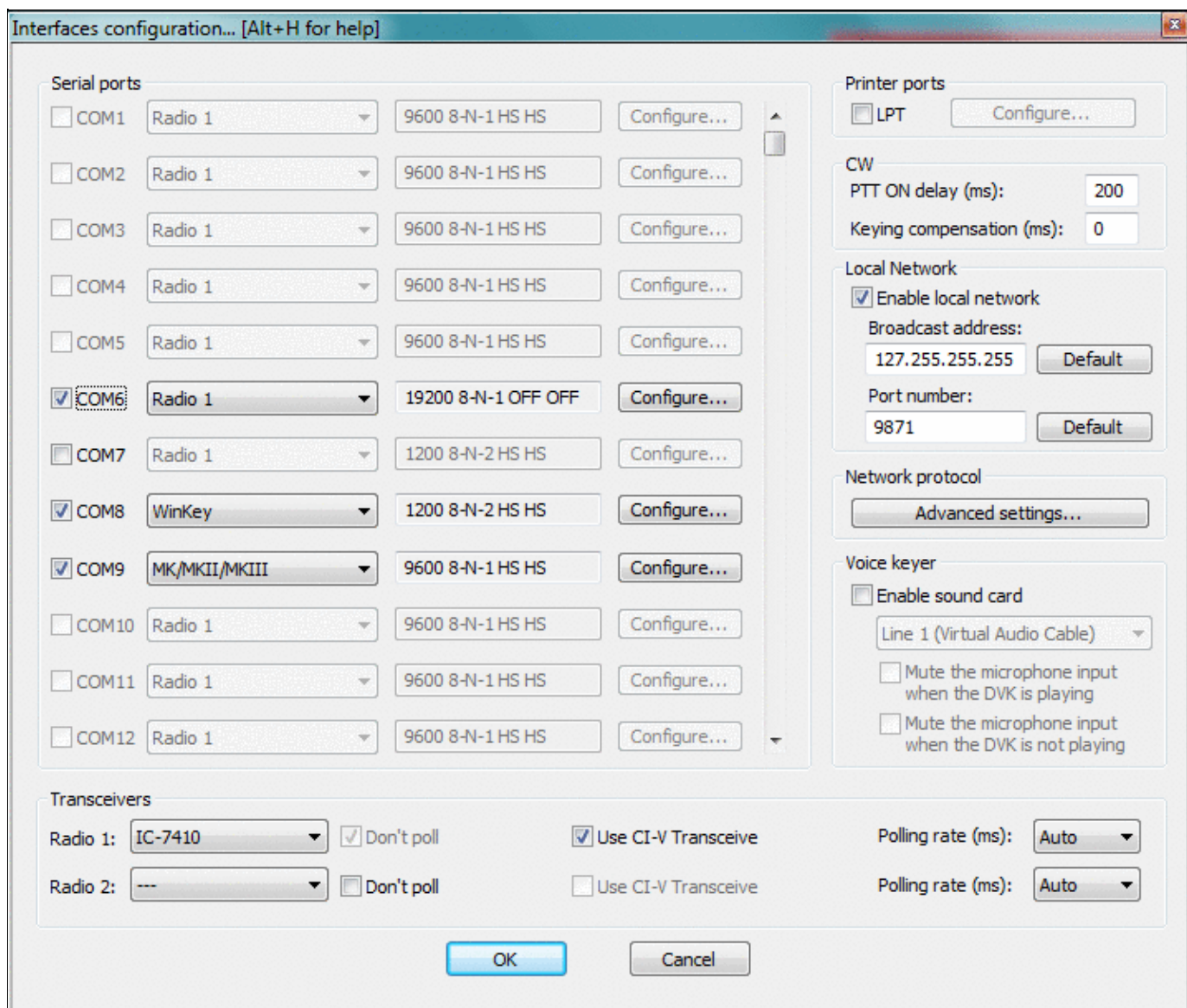

### COM port configuration

Upon checking the box, you will notice that the adjacent drop-down box will now be enabled. You *must* choose **Radio 1** or **Radio 2** from this drop-down list. You must also **ensure that the port (baud rate) settings are correct for your radio**.

By default, the settings of 19200 8-N-1 will be configured, which is probably incorrect for your radio. Click on the adjacent [**Configure . . .**] button to display the COM port properties dialog:

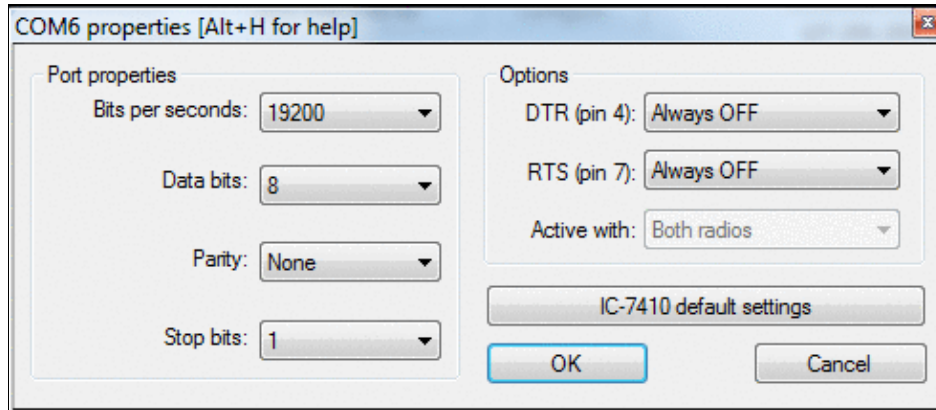

### COM port configuration for Radio1 / Radio2

If you are not sure about the baud rate settings for your transceiver, press the [**default settings**] button to change all values to the known hardware defaults for the selected radio.

There is also a list of known working settings for common contest radios located in the Supported rigs chapter.

## Configuring other interfaces

As you may well have noticed by this stage, a variety of other interfaces can also be enabled from the `Configure Interfaces` dialog box. It is just a simple case of ticking the relevant COM port and choosing said device from the drop-down list. Examples include TNCs, SO2R switching boxes (e.g. EZmaster, microHAM MK2R, WinKey, W5XD Keyer, etc.). For everything not on the list, you can choose `Other interface . . .` and configure the port settings yourself - for example, COM port CW interface (see below).

### COM-port CW keying

If you have a simple transistor-based COM port CW interface (see below), you can enable this by again choosing the corresponding COM port, and selecting `Other interface . . .` from the drop-down list. Clicking on the `Configure` button will display the COM Port Properties dialog including a drop-down list of options for DTR (pin 4) and RTS (pin 7) on a DE9 connector (pins 20 and 4 on a DB25). Connect the emitter of the NPN transistor to signal ground, pin 5 on DE9 (pin 7 on DB25).

*Be sure to select **DTR: CW** and **RTS: PTT** in the COM port Properties under Interface Configuration.*

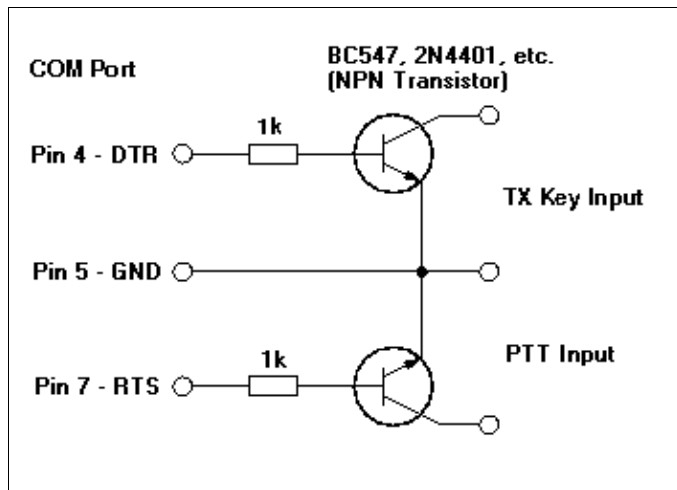

Simple COM port CW and PTT interface for DE-9 9-pin serial connector or USB-to-Serial adapter  
 This interface was originally designed for K1EA's CT and can still be used with Win-Test.

Note that you may need to delay PTT in order to avoid truncated characters. Also there is an option to apply time compensation to generate clean CW signals.

## LPT-port CW keying

Likewise, if you have an LPT (parallel) port CW interface (see schematics below), you can enable it by checking the box next to 'LPT' in the [Configure interfaces dialog](#). Clicking on the [Configure] button in the Printer Ports section will display the [Printer Ports dialog](#). At the very bottom, you can enable CW and PTT on pin 17 and 16 respectively. *Ensure this is checked.*

**WARNING:** In order for LPT keying to function correctly under Windows XP, Vista, or 32-bit Windows 7, you will need an additional utility, **DLPortIO.dll** installed by Port95NT.exe, obtainable from the Win-Test website. It is a simple process and only needs to be installed/run once. Please [click here](#) to download. For 64-bit Windows 7, use InpOut32.dll as described in [this post](#).

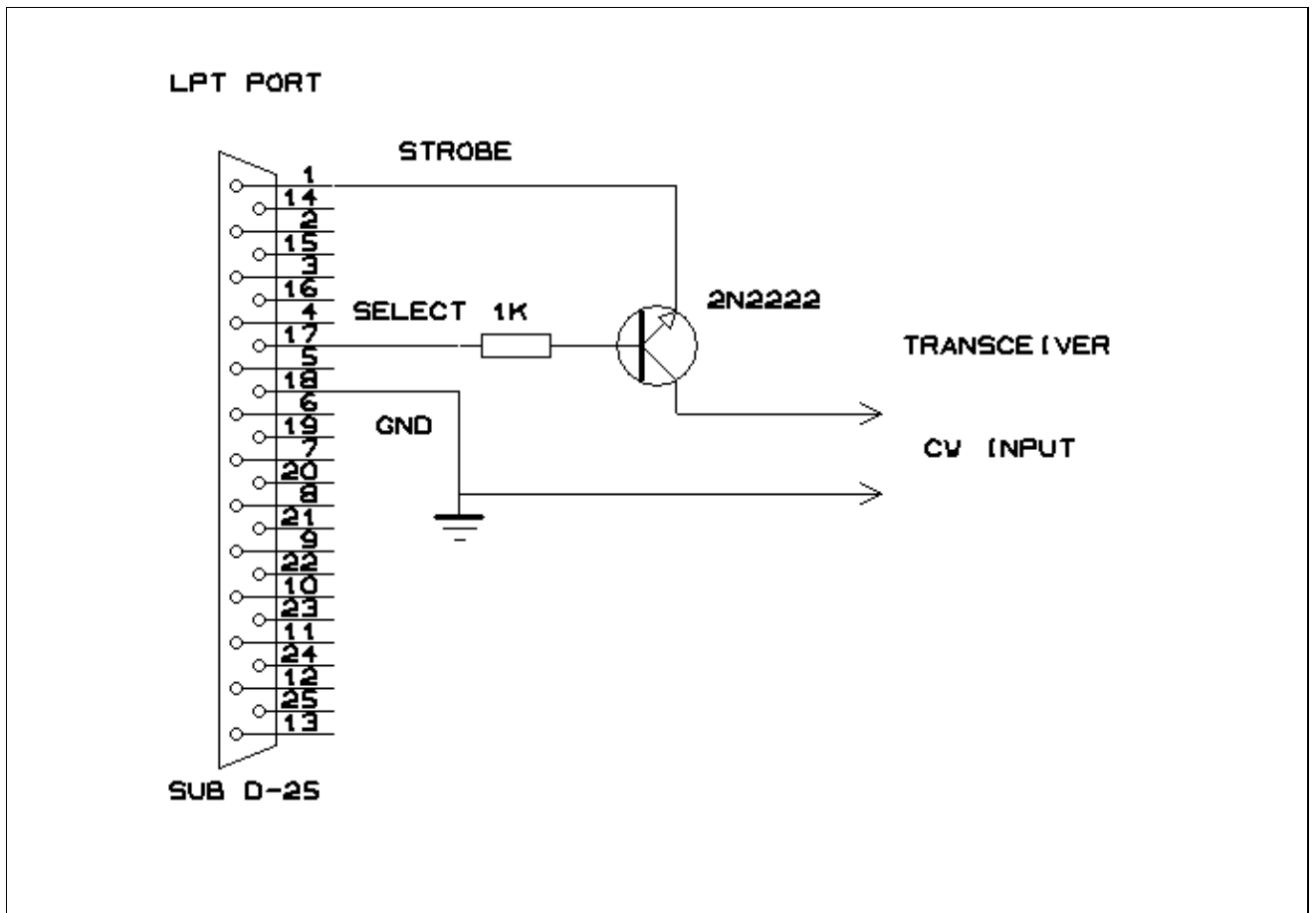

### Simple LPT port CW interface

Note that you may need to delay PTT in order to avoid truncated characters. Also there is an option to apply time compensation to generate clean CW signals.

## Digital Voice Keyer

The DVK-100 voice keyer was the first computer-controlled voice memory in the contesting world in the early 90s. Later, some equipment manufacturers built voice memories into their radios like Kenwood (TS-850, TS-950 with the DRU2 and DRU3 units respectively - probably others). These devices can be controlled by Win-Test using the following LPT interface.

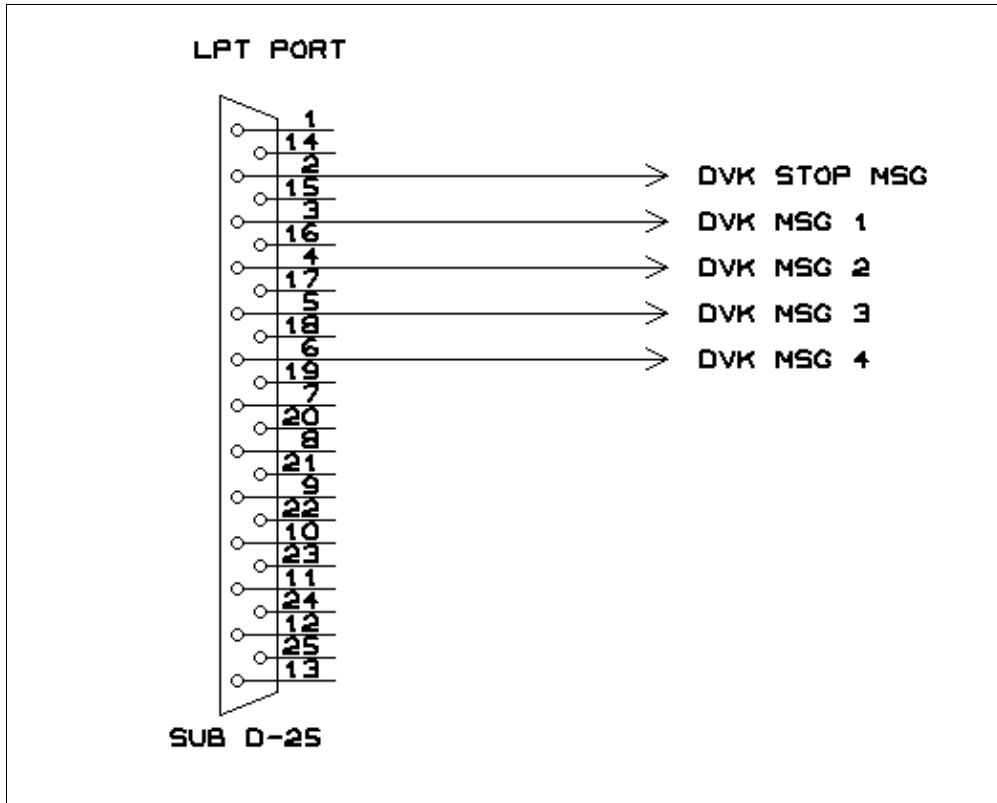



### Simple LPT port DVK interface

Usually the device has 3-4 different memories which can be triggered by [F1]...[F4] on the computer keyboard.

## Sound Card

Wav files can also be played from an internal sound card by utilizing a small interface like shown below. Messages are recorded using **Shift-F1...Shift-F7**.

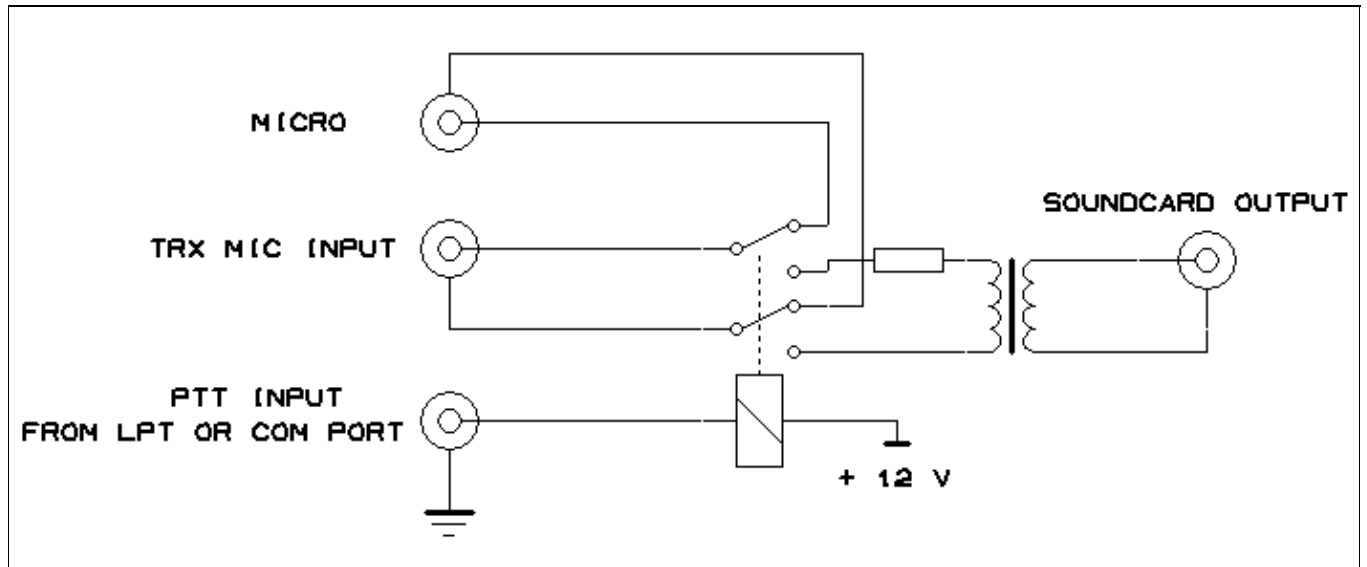

### Sound Card Interface

The use of an isolation transformer is recommended both on the output side of the sound card. Of course, you can go without one but first think about the trouble you will encounter when the Line Out port of your sound card gets killed by stray RF or when someone tells you you got hum on your audio in the middle of the contest.

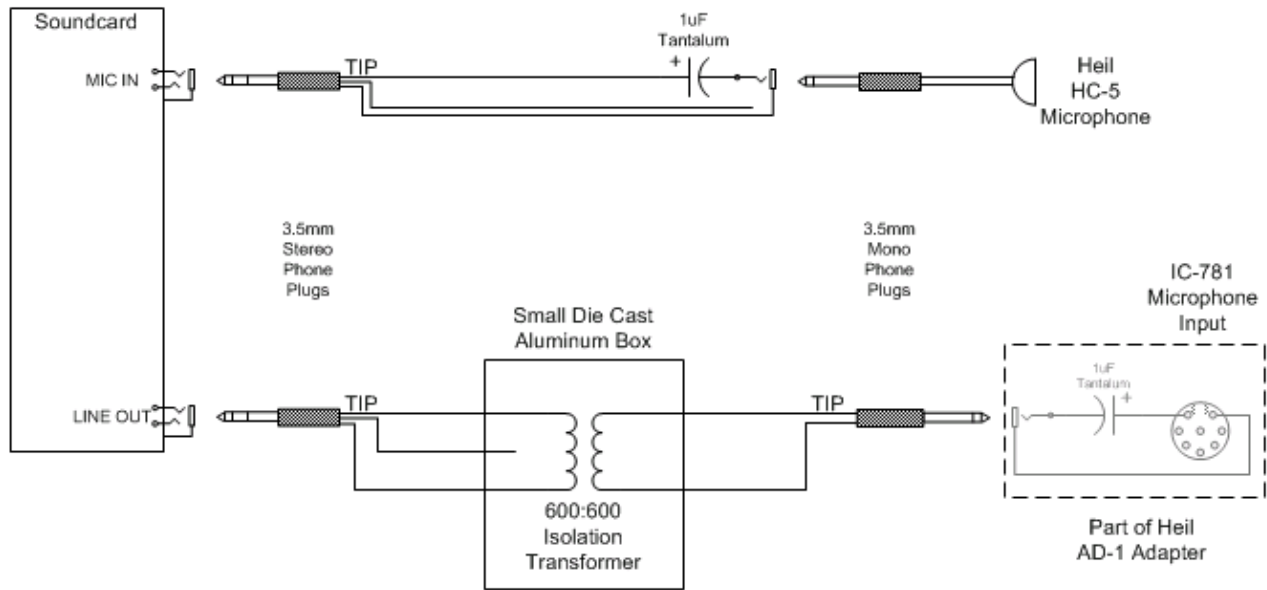

- 1) Use Self-Adhesive Ty-Wrap Base to Mount Transformer
- 2) Use Ty-Wrap to Hold Transformer to Self-Adhesive Base
- 3) Run Cables Through Grommets At Either End of Box
- 4) Use 2 Ty-Wrap Bases and Ty-Wraps to Strain Relief Cables

**PARTS LIST**

Aluminum Box	1	Circuit Specialists 03-125BR
Transformer	1	Triad TY-145P
1uF Capacitor	1	Kemet T322B105K035AT
3.5mm Stereo Molded Cables – 6 Ft	2	Kobiconn 172-2206
3.5mm Mono Molded Cable – 3Ft	1	Kobiconn 172-2136
3.5mm Stereo Socket, w/Strain Relief	1	Kobiconn 161-3200-EX

Sound Card interface kindly provided by W9ZRX. This interface is in use at the K3LR M/M station. W9ZRX has provided this design that comes without a relay to switch Mic input between radio and sound card. Most sound cards allow routing from Mic input to Line Out so that you can control muting Line Out from within Win-Test. Make sure that the Microphone has been enabled as an Input to the Sound Card Mixer. Different Sound Cards set up slightly differently, but most seem to either show the Microphone Input to the Mixer as **muted**, or the default Mixer Inputs do not include the Microphone until **enabled**.

There are sound cards that do not support this option. The Writelog download site has a [sound card checker](#) that will help you to determine if you have this problem if it absolutely doesn't work.

Another way would be to try using the Win-Test PTT output to drive a relay to allow a direct routing between your Mic and the Mic input of your TRX when the PTT output is off. This requires some additional components but better than an external mic to record the DVK messages.

## Band Data

Win-Test supports filter and antenna switching by supplying Yaesu-standard Band data on pins 2, 7, 8 and 9 of the parallel port. Go to Options | Configure interface | LPT configure | Pins mapping...

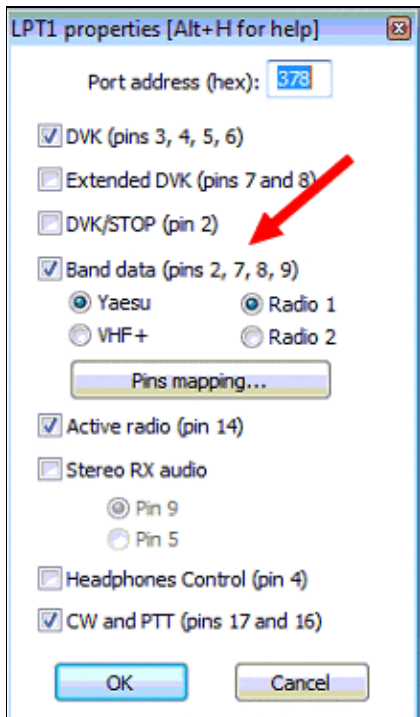

LPT1 Properties

This feature allows you to automatically control other devices in your station, probably by using a band decoder like the one from [Top Ten Devices](#). Band data code is also available designed for VHF+ bands, from 50 MHz to 122 GHz.

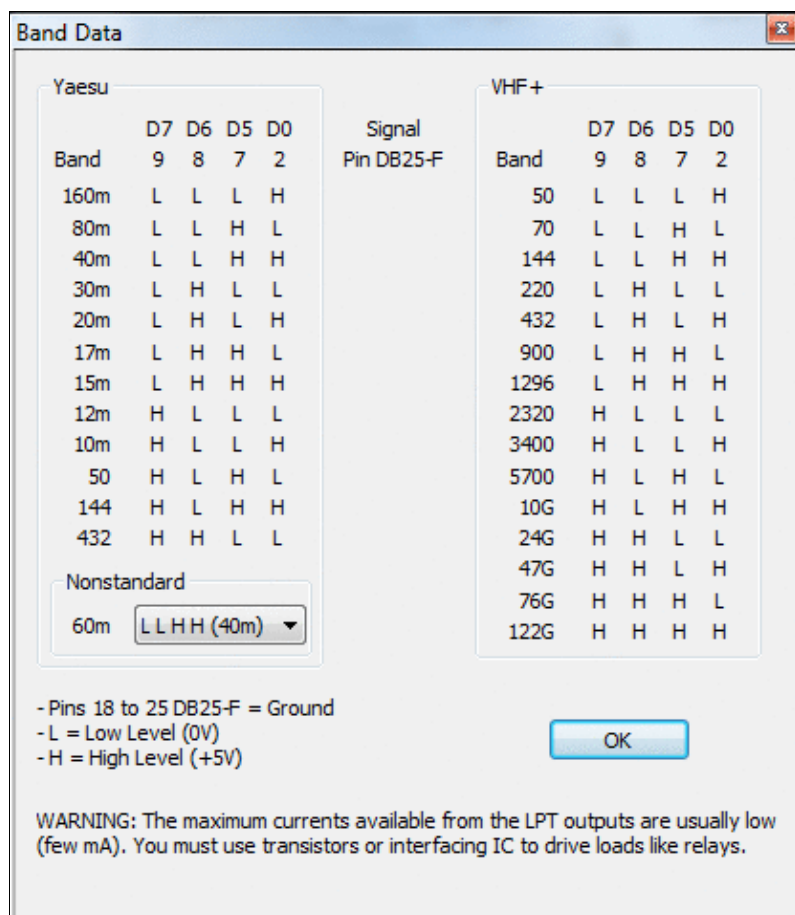

LPT Port Pin Mapping to control external devices

## Radio 1/Radio 2

LPT pin 14 is used to send Radio1/2 information to an external interface. High = Radio1, Low = Radio2.

## Headphones Control

The signals *Headphones Control* (called *RX Focus* in the MK2R microHAM SO2R interface) is available on LPT, pin 4. This signal allows to control which radio you want to listen to in the headphones. Must be enabled in the LPT Configuration Window. Low = Radio 1, High = Radio 2.

## See Also

### From the Win-Test manual

- [Configure interfaces dialog](#)
- [Networking configuration for multi-ops](#)
- [EZMaster setup](#)
- [microHAM MK2R setup](#)

### External sources

- [microHAM MicroKeyer Manual](#)
- [microHAM USB II Interface Manual](#)

## Namespaces

- [Page](#)
- [Discussion](#)

## Variants

## Views

- [Read](#)
- [View source](#)
- [View history](#)

## More

- This page was last edited on 10 April 2023, at 16:35.

- [Privacy policy](#)
- [About Win-Test Wiki](#)
- [Disclaimers](#)



# Interfaces

From Win-Test Wiki

[Jump to navigation](#) [Jump to search](#)

Configuration of interfaces in Win-Test needs only be done once, rather than on a per-contest basis. This means you do not waste time remembering your interface configuration details prior to each contest!

## Contents

- [1 Interface configuration](#)
  - ◆ [1.1 Radio configuration](#)
- [2 Configuring other interfaces](#)
  - ◆ [2.1 COM-port CW keying](#)
  - ◆ [2.2 LPT-port CW keying](#)
  - ◆ [2.3 Digital Voice Keyer](#)
  - ◆ [2.4 Sound Card](#)
  - ◆ [2.5 Band Data](#)
  - ◆ [2.6 Radio 1/Radio 2](#)
  - ◆ [2.7 Headphones Control](#)
- [3 See Also](#)
  - ◆ [3.1 From the Win-Test manual](#)
  - ◆ [3.2 External sources](#)

## Interface configuration

The [interface configuration window](#) can be opened by clicking on Options->Configure Interfaces menu in the main Win-Test window, or via the text command **SETUP**.

## Radio configuration

At the bottom of the window there is a "Transceivers" section which includes two drop-down lists where you set your radio type (**Radio 1** and **Radio 2**). First, choose your rig make and model from the appropriate list. Please note that there is only one "Kenwood" entry in the list because all Kenwood rigs use a common protocol.

On the left hand side of the window, you will see a list of COM ports (only available COM ports on your system will be selectable, others will be greyed-out). Serial ports COM1...COM32 can be selected (higher ports available by scrolling down). After you have chosen the manufacturer and/or model of your rig, check the box corresponding to the COM port to which your radio is connected. For example:

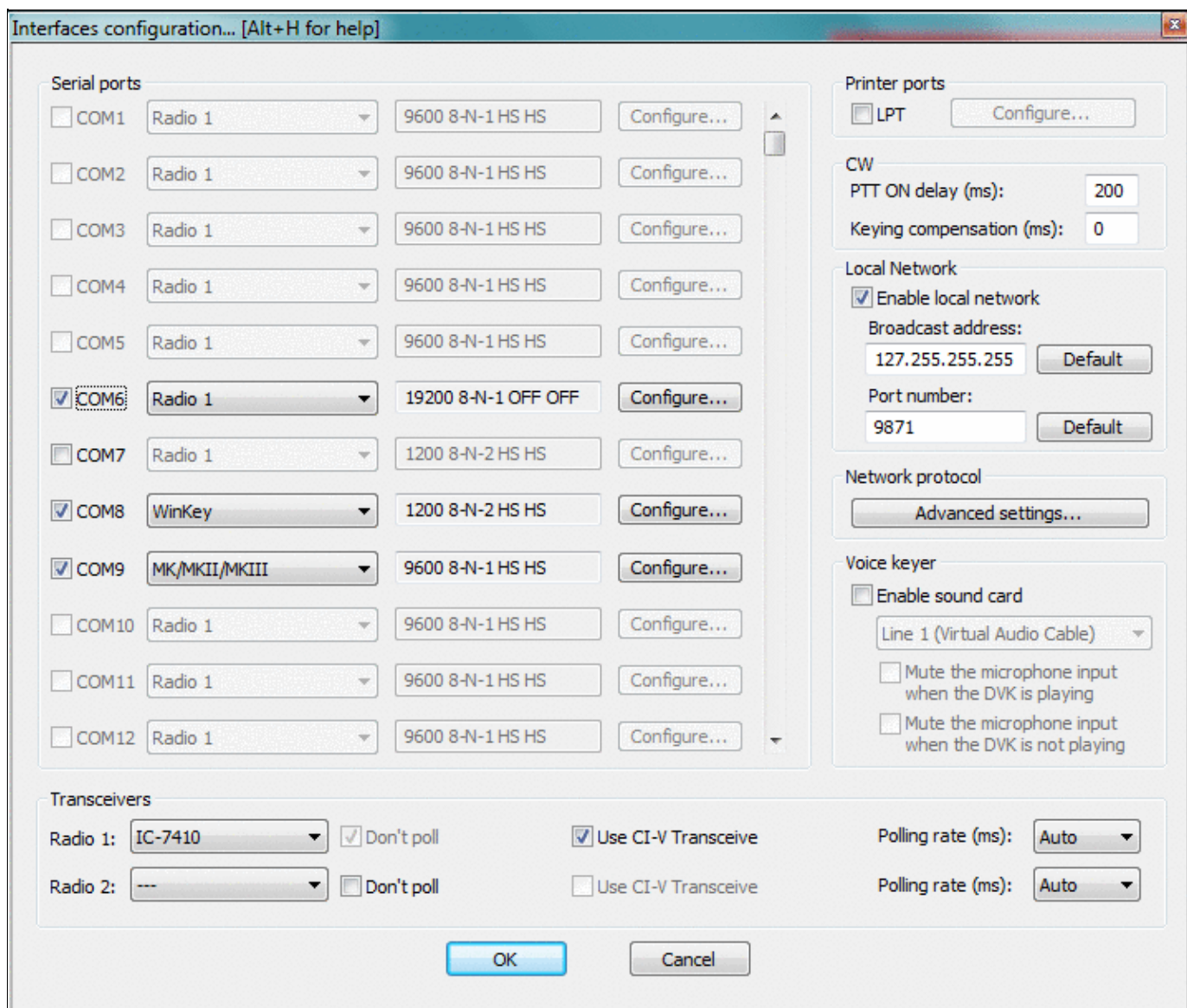

### COM port configuration

Upon checking the box, you will notice that the adjacent drop-down box will now be enabled. You *must* choose **Radio 1** or **Radio 2** from this drop-down list. You must also **ensure that the port (baud rate) settings are correct for your radio.**

By default, the settings of 19200 8-N-1 will be configured, which is probably incorrect for your radio. Click on the adjacent [**Configure . . .**] button to display the COM port properties dialog:

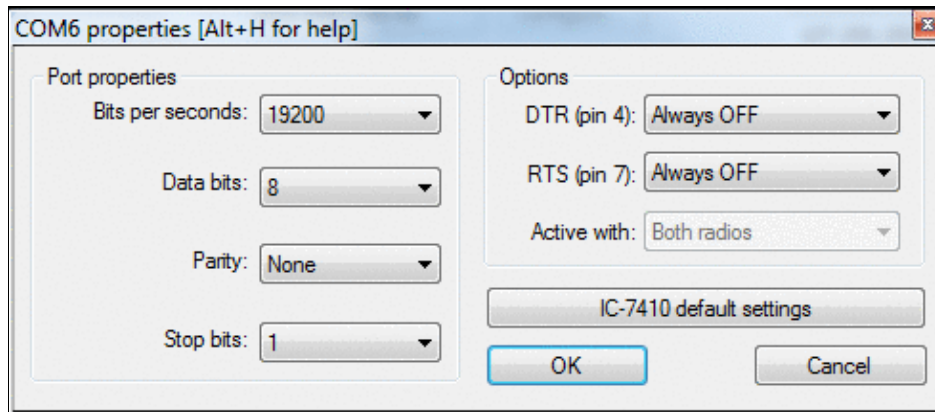

### COM port configuration for Radio1 / Radio2

If you are not sure about the baud rate settings for your transceiver, press the [**default settings**] button to change all values to the known hardware defaults for the selected radio.

There is also a list of known working settings for common contest radios located in the Supported rigs chapter.

## Configuring other interfaces

As you may well have noticed by this stage, a variety of other interfaces can also be enabled from the `Configure Interfaces` dialog box. It is just a simple case of ticking the relevant COM port and choosing said device from the drop-down list. Examples include TNCs, SO2R switching boxes (e.g. EZmaster, microHAM MK2R, WinKey, W5XD Keyer, etc.). For everything not on the list, you can choose `Other interface . . .` and configure the port settings yourself - for example, COM port CW interface (see below).

### COM-port CW keying

If you have a simple transistor-based COM port CW interface (see below), you can enable this by again choosing the corresponding COM port, and selecting `Other interface . . .` from the drop-down list. Clicking on the `Configure` button will display the COM Port Properties dialog including a drop-down list of options for DTR (pin 4) and RTS (pin 7) on a DE9 connector (pins 20 and 4 on a DB25). Connect the emitter of the NPN transistor to signal ground, pin 5 on DE9 (pin 7 on DB25).

*Be sure to select **DTR: CW** and **RTS: PTT** in the COM port Properties under Interface Configuration.*



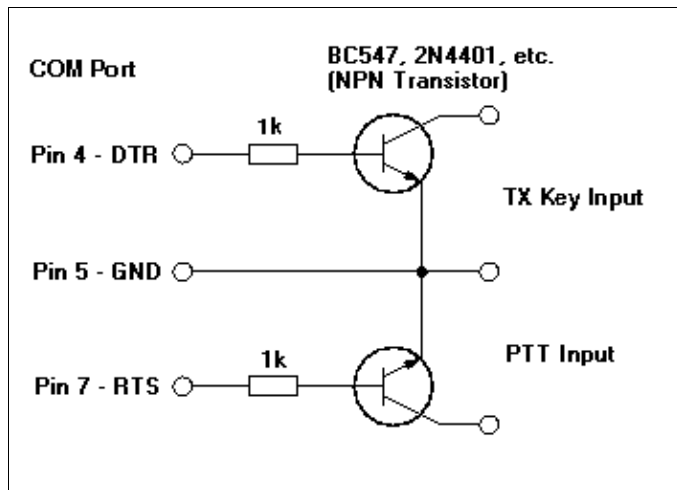

Simple COM port CW and PTT interface for DE-9 9-pin serial connector or USB-to-Serial adapter  
 This interface was originally designed for K1EA's CT and can still be used with Win-Test.

Note that you may need to delay PTT in order to avoid truncated characters. Also there is an option to apply time compensation to generate clean CW signals.

## LPT-port CW keying

Likewise, if you have an LPT (parallel) port CW interface (see schematics below), you can enable it by checking the box next to 'LPT' in the [Configure interfaces dialog](#). Clicking on the [Configure] button in the Printer Ports section will display the [Printer Ports dialog](#). At the very bottom, you can enable CW and PTT on pin 17 and 16 respectively. *Ensure this is checked.*

**WARNING:** In order for LPT keying to function correctly under Windows XP, Vista, or 32-bit Windows 7, you will need an additional utility, **DLPortIO.dll** installed by Port95NT.exe, obtainable from the Win-Test website. It is a simple process and only needs to be installed/run once. Please [click here](#) to download. For 64-bit Windows 7, use InpOut32.dll as described in [this post](#).

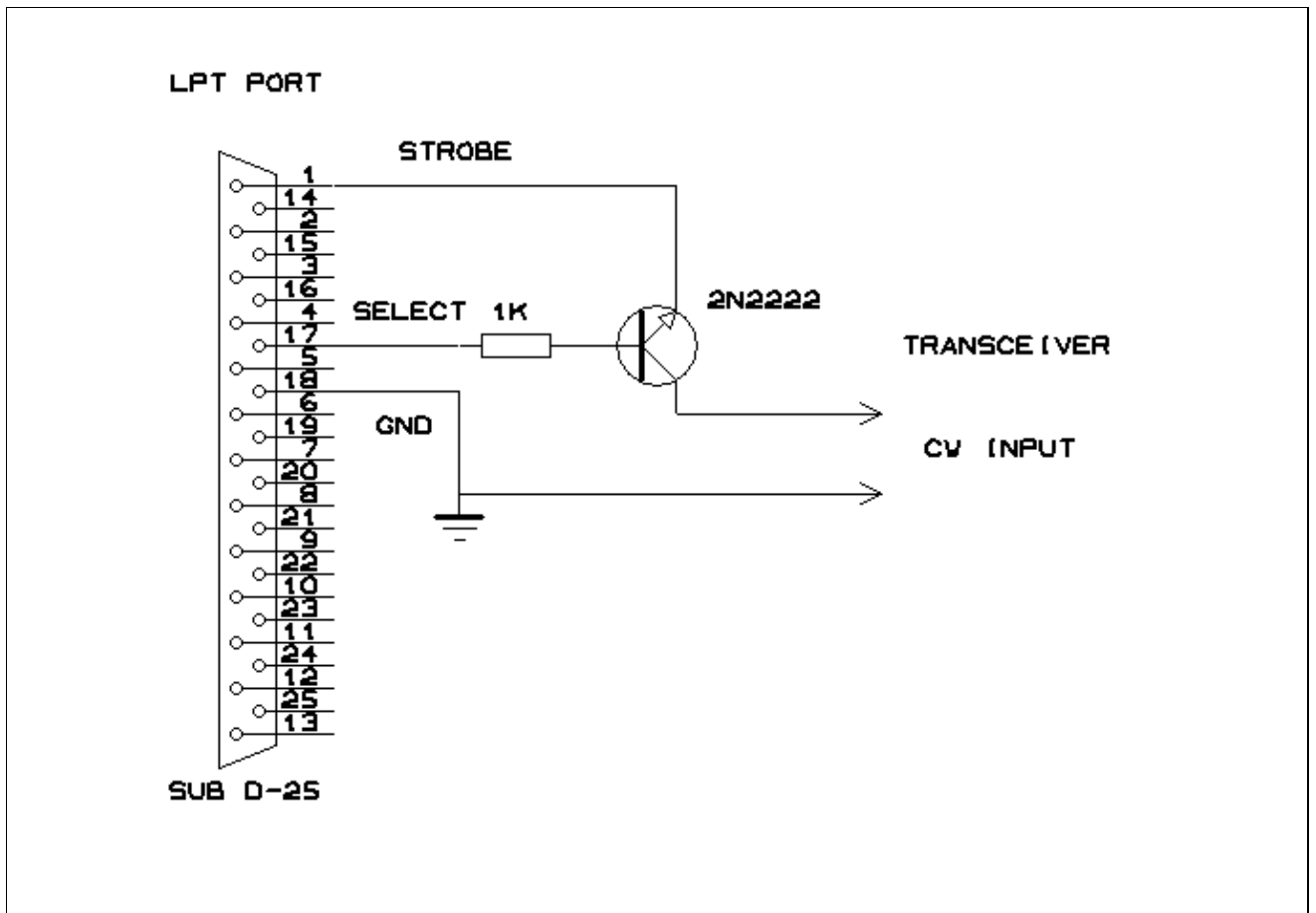

### Simple LPT port CW interface

Note that you may need to delay PTT in order to avoid truncated characters. Also there is an option to apply time compensation to generate clean CW signals.

## Digital Voice Keyer

The DVK-100 voice keyer was the first computer-controlled voice memory in the contesting world in the early 90s. Later, some equipment manufacturers built voice memories into their radios like Kenwood (TS-850, TS-950 with the DRU2 and DRU3 units respectively - probably others). These devices can be controlled by Win-Test using the following LPT interface.

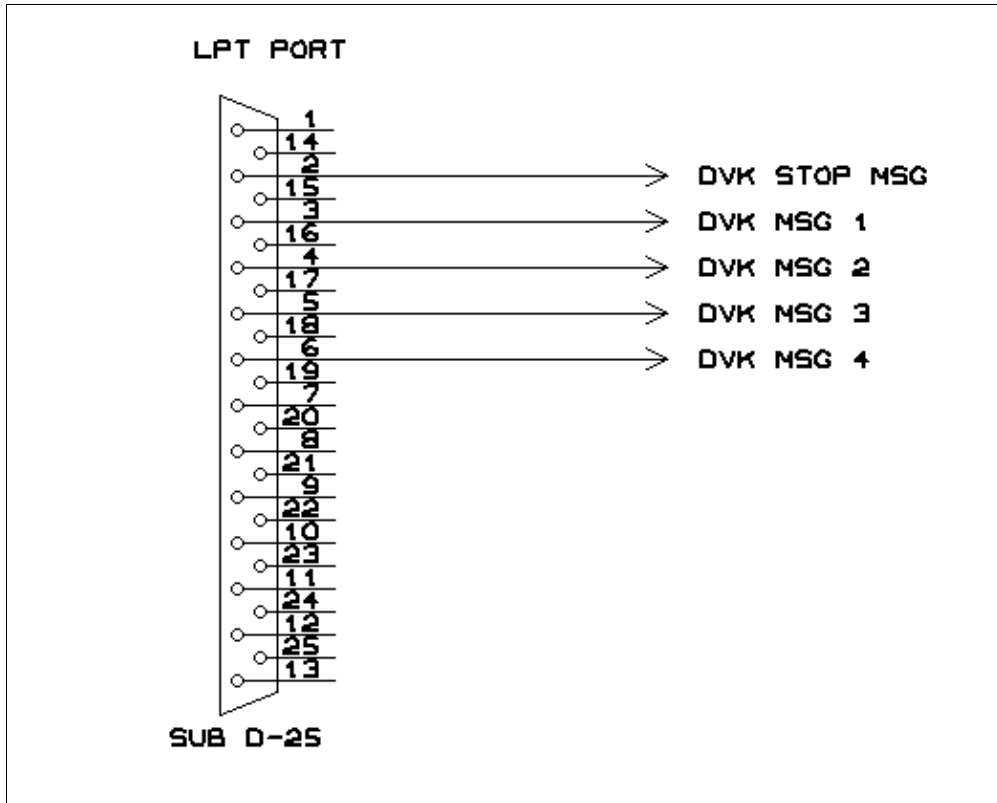

### Simple LPT port DVK interface

Usually the device has 3-4 different memories which can be triggered by [F1]...[F4] on the computer keyboard.

## Sound Card

Wav files can also be played from an internal sound card by utilizing a small interface like shown below. Messages are recorded using **Shift-F1...Shift-F7**.

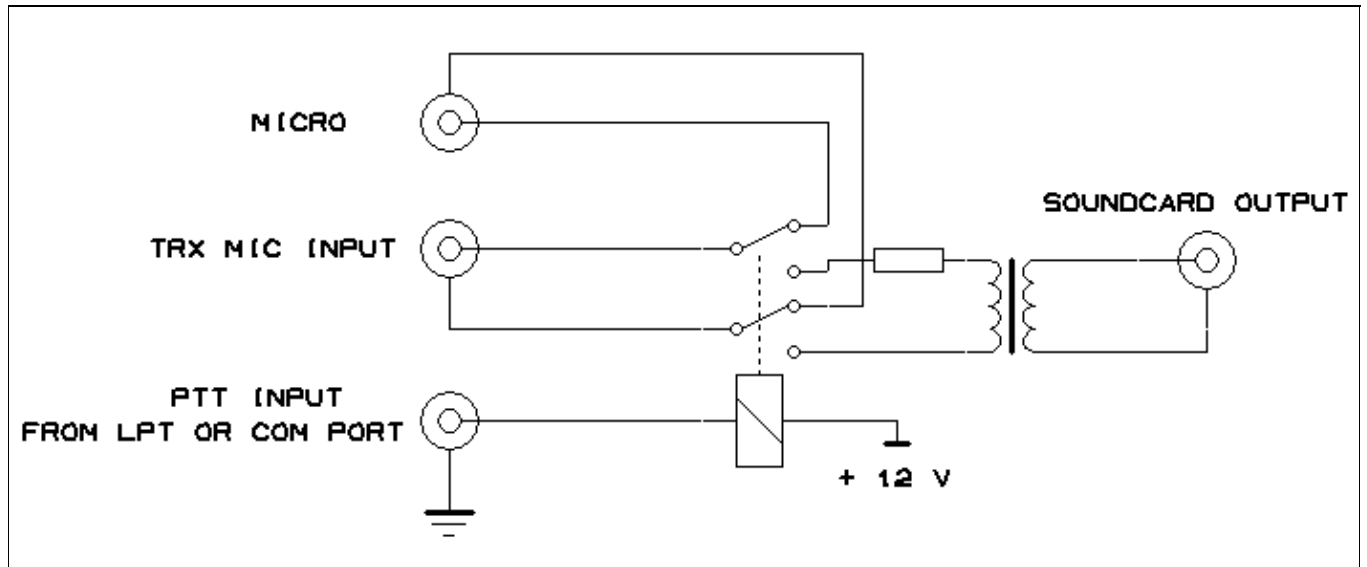

### Sound Card Interface

The use of an isolation transformer is recommended both on the output side of the sound card. Of course, you can go without one but first think about the trouble you will encounter when the Line Out port of your sound card gets killed by stray RF or when someone tells you you got hum on your audio in the middle of the contest.

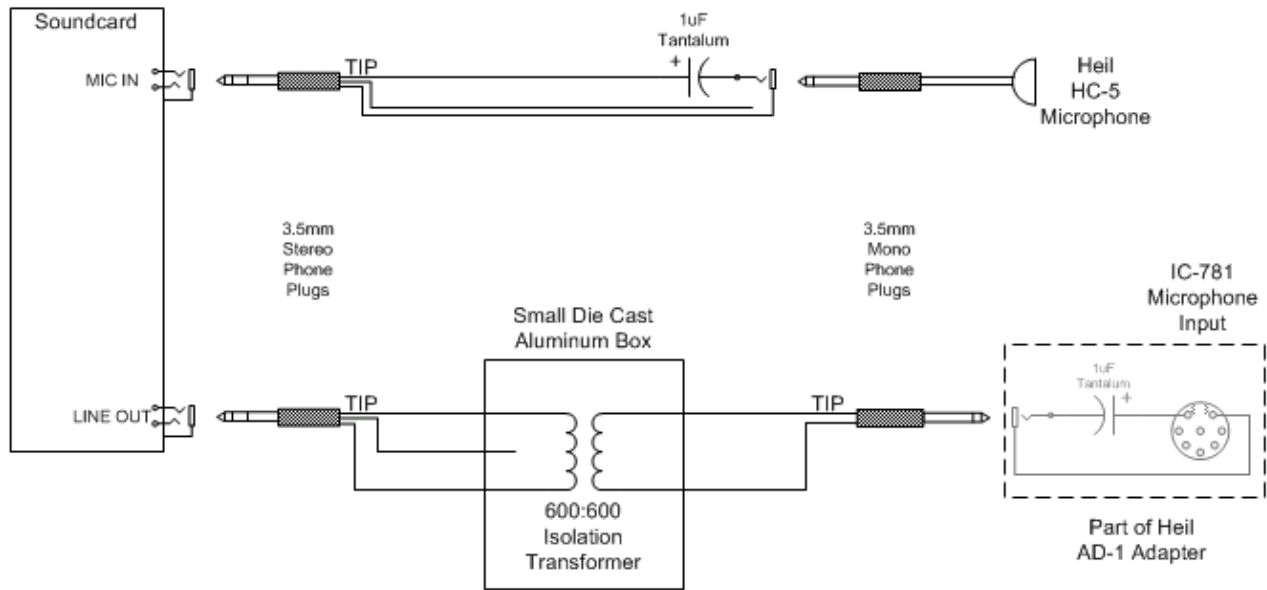

- 1) Use Self-Adhesive Ty-Wrap Base to Mount Transformer
- 2) Use Ty-Wrap to Hold Transformer to Self-Adhesive Base
- 3) Run Cables Through Grommets At Either End of Box
- 4) Use 2 Ty-Wrap Bases and Ty-Wraps to Strain Relief Cables

**PARTS LIST**

Aluminum Box	1	Circuit Specialists 03-125BR
Transformer	1	Triad TY-145P
1uF Capacitor	1	Kemet T322B105K035AT
3.5mm Stereo Molded Cables – 6 Ft	2	Kobiconn 172-2206
3.5mm Mono Molded Cable – 3Ft	1	Kobiconn 172-2136
3.5mm Stereo Socket, w/Strain Relief	1	Kobiconn 161-3200-EX

Sound Card interface kindly provided by W9ZRX. This interface is in use at the K3LR M/M station. W9ZRX has provided this design that comes without a relay to switch Mic input between radio and sound card. Most sound cards allow routing from Mic input to Line Out so that you can control muting Line Out from within Win-Test. Make sure that the Microphone has been enabled as an Input to the Sound Card Mixer. Different Sound Cards set up slightly differently, but most seem to either show the Microphone Input to the Mixer as **muted**, or the default Mixer Inputs do not include the Microphone until **enabled**.

There are sound cards that do not support this option. The Writelog download site has a [sound card checker](#) that will help you to determine if you have this problem if it absolutely doesn't work.

Another way would be to try using the Win-Test PTT output to drive a relay to allow a direct routing between your Mic and the Mic input of your TRX when the PTT output is off. This requires some additional components but better than an external mic to record the DVK messages.

## Band Data

Win-Test supports filter and antenna switching by supplying Yaesu-standard Band data on pins 2, 7, 8 and 9 of the parallel port. Go to [Options](#) | [Configure interface](#) | [LPT configure](#) | [Pins mapping...](#)

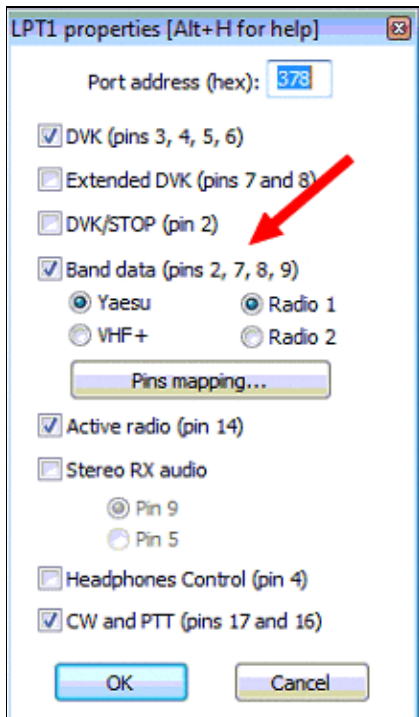

### LPT1 Properties

This feature allows you to automatically control other devices in your station, probably by using a band decoder like the one from [Top Ten Devices](#). Band data code is also available designed for VHF+ bands, from 50 MHz to 122 GHz.

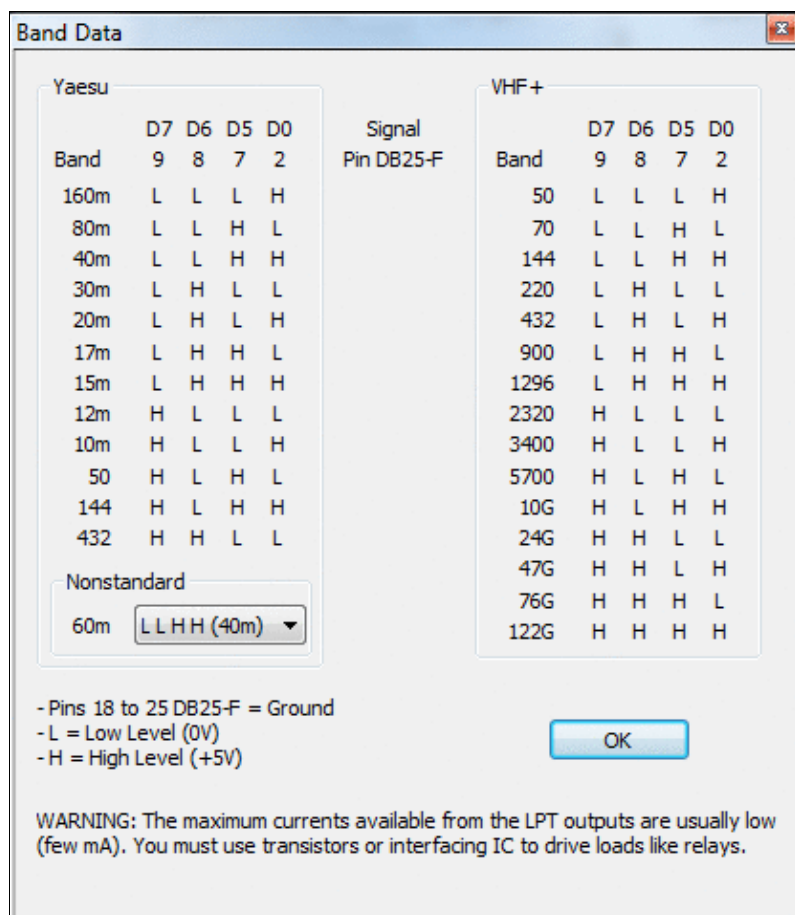

LPT Port Pin Mapping to control external devices

## Radio 1/Radio 2

LPT pin 14 is used to send Radio1/2 information to an external interface. High = Radio1, Low = Radio2.

## Headphones Control

The signals *Headphones Control* (called *RX Focus* in the MK2R microHAM SO2R interface) is available on LPT, pin 4. This signal allows to control which radio you want to listen to in the headphones. Must be enabled in the LPT Configuration Window. Low = Radio 1, High = Radio 2.

## See Also

### From the Win-Test manual

- [Configure interfaces dialog](#)
- [Networking configuration for multi-ops](#)
- [EZMaster setup](#)
- [microHAM MK2R setup](#)

### External sources

- [microHAM MicroKeyer Manual](#)
- [microHAM USB II Interface Manual](#)

## Namespaces

- [Page](#)
- [Discussion](#)

## Variants

## Views

- [Read](#)
- [View source](#)
- [View history](#)

## More

- This page was last edited on 10 April 2023, at 16:35.

- [Privacy policy](#)
- [About Win-Test Wiki](#)
- [Disclaimers](#)





# Keys

From Win-Test Wiki

[Jump to navigation](#) [Jump to search](#)

## Contents

- [1 Editing and moving around the QSO entry line](#)
- [2 Movement in the log](#)
- [3 Message keys](#)
- [4 Open and Close Windows](#)
- [5 Radio Control](#)
- [6 Packet](#)
- [7 Band Map](#)
- [8 DX-Cluster Announcements](#)
- [9 Networking](#)
- [10 Multi Operator](#)
- [11 SO2R](#)
- [12 Partner Mode](#)
- [13 Contest Recorder](#)
- [14 Special Keys](#)

## Editing and moving around the QSO entry line

- **[Enter]**: Log a contact
- **[Spacebar]**: Move cursor between callsign entry and report fields
- **[Left arrow]**: Move cursor one character to the left
- **[Right arrow]**: Move cursor one character to the right
- **[Home]**: Move cursor to the beginning of the field
- **[End]**: Moves the cursor to the end of the field
- **[Backspace]**: Delete the character located left of the cursor
- **[Tab]** : Move cursor between sent RST and received number fields
- **[>]**: Move cursor to next field in the main log.
- **[<]**: Move cursor to previous field in the main log.
- **[Del]**: Delete the character located under the cursor
- **[F11]**: Clear all the fields of the current QSO, and puts the cursor into the callsign logging field
- **Alt-W**: Clear QSO (like **F11**)
- **Alt-F8**: Clear QSO (like **F11**)
- **Alt-F**: Edit QSO date and time
- **Alt-N**: Write a note regarding this QSO
- **Alt-Up arrow**: Copy the previous QSO in the log
- **Ctrl-A**: Like **[Home]**
- **Ctrl-B**: Like **[Left arrow]**
- **Ctrl-D**: Like **[Del]**
- **Ctrl-E**: Like **[End]**
- **Ctrl-F**: Like **[Right arrow]**
- **Ctrl-W**: Clear the current field; if report field is cleared, initialise RST
- **Ctrl-K**: Like **[Shift-Del]**

- **Ctrl-X**: Execute a text command on the current QSO
- **Ctrl-Z**: Undo - restores edited QSO data to prior value (see [Menu:Edit#Restore\\_QSO](#))
- **Ctrl-Left arrow**: Like **[Home]**
- **Ctrl-Right arrow**: Like **[End]**
- **Ctrl-F10**: Change fixed report in other QSOs to this QSO's report (to correct zone/age whatever consistently)
- **Shift-Backspace**: Delete all the characters left of the cursor
- **Shift-Del**: Delete all characters under and right of the cursor

## Movement in the log

Warning: Any movement in the log validates the QSO where the cursor was located before the movement!

- **[Up arrow]**: Move one QSO up
- **[Down arrow]**: Move one QSO down
- **[PgUp]**: Move 10 QSOs up
- **[PgDn]**: Move 10 QSOs down
- **Ctrl-Shift-G**: Go to callsign (press again for next QSO with this callsign)
- **Ctrl-G**: Go to a specific QSO number
  - ◆ To skip the dialog box prompt, just enter the QSO number into the callsign field, then Press **Ctrl-G**. To return to the end of the log, press **Ctrl-G**, **[Spacebar]**
- **Ctrl-G**, **[Home]**: Go to first QSO in log
- **Ctrl-G**, **[End]**: Go to last QSO in log
- **Ctrl-Home**: Go to first QSO in log
- **Ctrl-End**: Go to last QSO in log
- **Ctrl-PgDn**: Go forward 12 hours in the log
- **Ctrl-PgUp**: Go back 12 hours in the log

## Message keys

- **[F1]**: Play message #1. Normally, this message is the CQ
- **[F2]**: Play message #2. Normally, this message is the report sent (full)
- **[F3]**: Play message #3. Normally, this message is the serial number sent
- **[F4]**: Play message #4. Normally, this message is your call
- **[F5]**: Play message #5. Normally, this message is the logged callsign
- **[F6]**: Play message #6. Normally, this message sends Call? or NR?
- **[F7]**: Play message #7. Normally, this message sends "?" or "Again?"
- **[Insert]**: Play the message defined for this key - normally, this message is the logged callsign the full sent report. On Phone this key is bound to the F2 message.
- **[+]**: Play the message defined for this key - normally, this message sends a TU, then your callsign and automatically logs the QSO. On Phone this key is bound to the F3 message. See also [Remapping \[+\]](#) when using a Notebook or Mini keyboard.
- **[Esc]**: Stop the output message being sent
- **Alt-K**: Toggle Keyboard mode
- **Alt-C**: Send or modify additional messages
- **Alt-V**: Change CW speed (opens "CW-Speed" dialog box)
- **Alt-F9**: Decrease CW speed by 2 WPM
- **Alt-F10**: Increase CW speed by 2 WPM
- **Shift-F1...Shift-F7**: Record messages #1 to #7 (unless [Operating | Shift binds to the second radio](#) is enabled)

- **Shift-Insert**: Record the message associated to the [**Insert**] key (unless Operating | Shift binds to the second radio is enabled). CW/RTTY only. For Phone, the F2 message is the Insert message.
- **Shift-+**: Records the message associated to the [**+**] key (unless Operating | Shift binds to the second radio is enabled). CW/RTTY only. For Phone, the F3 message is the Plus message.
- **AltGr-F1...AltGr-F7**: Record messages #1 to #7
- **AltGr-Insert**: Record the message associated to the [**Insert**] key
- **AltGr-+**: Records the message associated to the [**+**] key
- **Ctrl-Alt-F1...Ctrl-Alt-F7**: Record messages #1 to #7
- **Ctrl-Alt-Insert**: Record the message associated to the [**Insert**] key
- **Ctrl-Alt-+**: Records the message associated to the [**+**] key
- **Ctrl-Tab**: Toggle between Run and S&P mode and messages (CW/RTTY)
- **Ctrl-Shift-Tab**: Toggle between Run and S&P mode and messages on the secondary radio

## Open and Close Windows

- [**F8**]: Open/Close N + 1 Window
- [**F9**]: Open/Close Check call Window
- [**F10**]: Open/Close Check Multipliers Window
- [**F12**]: Open/Close Check Partials Window
- **Alt-A**: Open/Close DX-Cluster Announcements Window
- **Alt-B**: Open/Close Skeds Window
- **Alt-E**: Take a sked
- **Alt-I**: Open/Close Gab Window
- **Alt-M**: Open/Close Mult Window
- **Alt-O**: Open/Close DX-Cluster Monitor Window
- **Alt-R**: Open/Close Rate Window
- **Alt-S**: Open/Close Summary
- **Alt-X**: Open Extra Data Files Window
- **Alt-Z**: Open/Close Worked zones Window
- **Ctrl-F9**: Open/Close Statistics Window
- **Shift-F10**: Reverse Multiplier Check - Opens the Search for Worked Multipliers Window

## Radio Control

- **[-]**: Split frequency - enter QSX frequency here (e.g. 7239). "+1" will set the RX VFO +1 kHz from TX VFO. "0" turns split frequency mode off.
- **[\*]**: Switch active radio. **This only works with the [\*] key on the numeric keypad.** See also Remapping [\*] when using a Notebook or Mini keyboard.
- **Alt-:** : Switch active radio
- **Alt-F1**: QSY band down (20 => 40 => ...)
- **Alt-F2**: QSY band up (20 => 15 => ...)
- **Alt-F4**: QSY back to run frequency, resume original CW speed
- **Alt-F5**: Set run frequency
- **Ctrl-S**: Swap the frequency on both radios (SO2R)
- **Ctrl-T**: Tune the transmitter (on CW, max 30 seconds)
- **Ctrl-F1** and **Ctrl-F2**: Switch mode (when the contest permits and mode=MIXED or ALL)

## Packet

- **Alt-A**: Open/Close DX-Cluster Announcements Window
- **Alt-O**: Open/Close DX-Cluster Monitor Window
- **Alt-T**: Talk to DX-Cluster
- **Alt-F3**: Spot

## Band Map

- **Ctrl-Enter**: Insert spot into [Band Map](#)
- **Ctrl-Del**: Delete spot on current frequency in the active Band Map
- **Ctrl-J**: Insert spot into Band Map
- **Ctrl-R**: Toggle band map view/list view
- **Ctrl-Up arrow**: Grab the first upper spot in the active Band Map (in frequency regarding the active radio)
- **Ctrl-Shift-Up arrow**: Grab the first upper spot in the active bandmap (in frequency regarding the active radio), even if it is a 0-pointer
- **Ctrl-Down arrow**: Grab the first lower spot in the active bandmap (in frequency regarding the active radio)
- **Ctrl-Shift-Down arrow**: Grab the first lower spot in the active bandmap (in frequency regarding the active radio), even if it is a 0-point station
- **Ctrl-Space**: Grab the spot on or near the current frequency. Enter some characters and it grabs a call from the visible spots in the Radio or the DX-cluster window.
- **Ctrl-DoubleClick** on a spot: Delete the spot without the warning window
- **Alt-DoubleClick** on a spot: Load the sub VFO with a spot frequency (if applicable)

## DX-Cluster Announcements

- **Ctrl-DoubleClick** on a spot: Delete the spot without the warning window
- **Alt-DoubleClick** on a spot: Load the sub VFO with a spot frequency (if applicable)

## Networking

- **Alt-D**: Pass a station
- **Alt-G**: Send a gab
- **Alt-I**: Open/Close Gab Window
- **Alt-J**: Display status of all stations in the network

## Multi Operator

- **Alt-Y**: Toggle current QSO's station type from RUN (R1) to MULT (M) in the M/S category, or from RUN1 (R1) to RUN2 (R2) in M/2 category, and vice versa.

If the cursor is on the logging line rather than a previously logged QSO when you press this key, the station type is changed for all new QSOs logged on that computer, i.e. it is equivalent to entering the text commands RUN/MULT or RUN1/RUN2. See [Menu: Commands | Station Type](#).

- **Ctrl-F3**: Toggle current QSO (same as **Alt-Y**)

## SO2R

- **AltGr-A, Ctrl-Alt-A**: Listen to the primary radio with both ears
- **AltGr-T, Ctrl-Alt-T**: Listen to the secondary radio with both ears
- **AltGr-S, Ctrl-Alt-S**: Listen to both radios in stereo (toggle)
- **AltGr-L, Ctrl-Alt-L**: Listen to the "other" radio with both ears during transmit (headphone "latch")
- **AltGr-R, Ctrl-Alt-R**: Restore automatic control (advanced scenarios will control headphones, like \$RESET)
- **AltGr-1...AltGr-8, Ctrl-Alt-1...Ctrl-Alt-8**: Select one of the eight SO2R scenarios

## Partner Mode

- **Alt-Enter**: Add the call current call to the partner window
- **Alt-Space**: Grab the call in the topmost "real time" line of the partner window
- **Alt-Backspace**: Clear everything in the partner window
- **Alt-1...Alt-9**: Grab the *n*th call from the partner window
- **Ctrl-1...Ctrl-9**: Swap the *n*th call in partner window with callsign in the logging window
- **DoubleClick** on a callsign: Grab the call from the partner window
- **Ctrl-DoubleClick** on a callsign: Delete the call from the partner window

## Contest Recorder

- **AltGr-Enter**: Play QSO
- **AltGr-Up**: Previous QSO
- **AltGr-Down**: Next QSO
- **AltGr-Space**: Play/Pause
- **AltGr-PgUp**: Rewind 30s
- **AltGr-PgDn**: FastForward 30s
- **AltGr-Left**: Rewind 5s
- **AltGr-Right**: FastForward 5s
- **AltGr-E**: Extract QSO
- **AltGr-O**: Start contest recorder

Some keyboards do not have an AltGr key, so use Ctrl+Alt instead.

## Special Keys

- **Alt-L**: Open QTC RX window (to be used by EU stations)
- **Ctrl-L**: Open QTC TX window (to be used by DX stations)

## Namespaces

- Page
- Discussion

## Variants

## Views

- [Read](#)
- [View source](#)
- [View history](#)

## More

- This page was last edited on 10 April 2023, at 06:53.

- [Privacy policy](#)
- [About Win-Test Wiki](#)
- [Disclaimers](#)



# Keys

From Win-Test Wiki

[Jump to navigation](#) [Jump to search](#)

## Contents

- [1 Editing and moving around the QSO entry line](#)
- [2 Movement in the log](#)
- [3 Message keys](#)
- [4 Open and Close Windows](#)
- [5 Radio Control](#)
- [6 Packet](#)
- [7 Band Map](#)
- [8 DX-Cluster Announcements](#)
- [9 Networking](#)
- [10 Multi Operator](#)
- [11 SO2R](#)
- [12 Partner Mode](#)
- [13 Contest Recorder](#)
- [14 Special Keys](#)

## Editing and moving around the QSO entry line

- **[Enter]**: Log a contact
- **[Spacebar]**: Move cursor between callsign entry and report fields
- **[Left arrow]**: Move cursor one character to the left
- **[Right arrow]**: Move cursor one character to the right
- **[Home]**: Move cursor to the beginning of the field
- **[End]**: Moves the cursor to the end of the field
- **[Backspace]**: Delete the character located left of the cursor
- **[Tab]** : Move cursor between sent RST and received number fields
- **[>]**: Move cursor to next field in the main log.
- **[<]**: Move cursor to previous field in the main log.
- **[Del]**: Delete the character located under the cursor
- **[F11]**: Clear all the fields of the current QSO, and puts the cursor into the callsign logging field
- **Alt-W**: Clear QSO (like **F11**)
- **Alt-F8**: Clear QSO (like **F11**)
- **Alt-F**: Edit QSO date and time
- **Alt-N**: Write a note regarding this QSO
- **Alt-Up arrow**: Copy the previous QSO in the log
- **Ctrl-A**: Like **[Home]**
- **Ctrl-B**: Like **[Left arrow]**
- **Ctrl-D**: Like **[Del]**
- **Ctrl-E**: Like **[End]**
- **Ctrl-F**: Like **[Right arrow]**
- **Ctrl-W**: Clear the current field; if report field is cleared, initialise RST
- **Ctrl-K**: Like **[Shift-Del]**

- **Ctrl-X**: Execute a text command on the current QSO
- **Ctrl-Z**: Undo - restores edited QSO data to prior value (see [Menu:Edit#Restore\\_QSO](#))
- **Ctrl-Left arrow**: Like **[Home]**
- **Ctrl-Right arrow**: Like **[End]**
- **Ctrl-F10**: Change fixed report in other QSOs to this QSO's report (to correct zone/age whatever consistently)
- **Shift-Backspace**: Delete all the characters left of the cursor
- **Shift-Del**: Delete all characters under and right of the cursor

## Movement in the log

Warning: Any movement in the log validates the QSO where the cursor was located before the movement!

- **[Up arrow]**: Move one QSO up
- **[Down arrow]**: Move one QSO down
- **[PgUp]**: Move 10 QSOs up
- **[PgDn]**: Move 10 QSOs down
- **Ctrl-Shift-G**: Go to callsign (press again for next QSO with this callsign)
- **Ctrl-G**: Go to a specific QSO number
  - ◆ To skip the dialog box prompt, just enter the QSO number into the callsign field, then Press **Ctrl-G**. To return to the end of the log, press **Ctrl-G**, **[Spacebar]**
- **Ctrl-G**, **[Home]**: Go to first QSO in log
- **Ctrl-G**, **[End]**: Go to last QSO in log
- **Ctrl-Home**: Go to first QSO in log
- **Ctrl-End**: Go to last QSO in log
- **Ctrl-PgDn**: Go forward 12 hours in the log
- **Ctrl-PgUp**: Go back 12 hours in the log

## Message keys

- **[F1]**: Play message #1. Normally, this message is the CQ
- **[F2]**: Play message #2. Normally, this message is the report sent (full)
- **[F3]**: Play message #3. Normally, this message is the serial number sent
- **[F4]**: Play message #4. Normally, this message is your call
- **[F5]**: Play message #5. Normally, this message is the logged callsign
- **[F6]**: Play message #6. Normally, this message sends Call? or NR?
- **[F7]**: Play message #7. Normally, this message sends "?" or "Again?"
- **[Insert]**: Play the message defined for this key - normally, this message is the logged callsign the full sent report. On Phone this key is bound to the F2 message.
- **[+]**: Play the message defined for this key - normally, this message sends a TU, then your callsign and automatically logs the QSO. On Phone this key is bound to the F3 message. See also [Remapping \[+\]](#) when using a Notebook or Mini keyboard.
- **[Esc]**: Stop the output message being sent
- **Alt-K**: Toggle Keyboard mode
- **Alt-C**: Send or modify additional messages
- **Alt-V**: Change CW speed (opens "CW-Speed" dialog box)
- **Alt-F9**: Decrease CW speed by 2 WPM
- **Alt-F10**: Increase CW speed by 2 WPM
- **Shift-F1...Shift-F7**: Record messages #1 to #7 (unless [Operating | Shift binds to the second radio](#) is enabled)



- **Shift-Insert**: Record the message associated to the [**Insert**] key (unless Operating | Shift binds to the second radio is enabled). CW/RTTY only. For Phone, the F2 message is the Insert message.
- **Shift-+**: Records the message associated to the [**+**] key (unless Operating | Shift binds to the second radio is enabled). CW/RTTY only. For Phone, the F3 message is the Plus message.
- **AltGr-F1...AltGr-F7**: Record messages #1 to #7
- **AltGr-Insert**: Record the message associated to the [**Insert**] key
- **AltGr-+**: Records the message associated to the [**+**] key
- **Ctrl-Alt-F1...Ctrl-Alt-F7**: Record messages #1 to #7
- **Ctrl-Alt-Insert**: Record the message associated to the [**Insert**] key
- **Ctrl-Alt-+**: Records the message associated to the [**+**] key
- **Ctrl-Tab**: Toggle between Run and S&P mode and messages (CW/RTTY)
- **Ctrl-Shift-Tab**: Toggle between Run and S&P mode and messages on the secondary radio

## Open and Close Windows

- [**F8**]: Open/Close N + 1 Window
- [**F9**]: Open/Close Check call Window
- [**F10**]: Open/Close Check Multipliers Window
- [**F12**]: Open/Close Check Partials Window
- **Alt-A**: Open/Close DX-Cluster Announcements Window
- **Alt-B**: Open/Close Skeds Window
- **Alt-E**: Take a sked
- **Alt-I**: Open/Close Gab Window
- **Alt-M**: Open/Close Mult Window
- **Alt-O**: Open/Close DX-Cluster Monitor Window
- **Alt-R**: Open/Close Rate Window
- **Alt-S**: Open/Close Summary
- **Alt-X**: Open Extra Data Files Window
- **Alt-Z**: Open/Close Worked zones Window
- **Ctrl-F9**: Open/Close Statistics Window
- **Shift-F10**: Reverse Multiplier Check - Opens the Search for Worked Multipliers Window

## Radio Control

- [-]: Split frequency - enter QSX frequency here (e.g. 7239). "+1" will set the RX VFO +1 kHz from TX VFO. "0" turns split frequency mode off.
- [\*]: Switch active radio. **This only works with the [\*] key on the numeric keypad.** See also Remapping [\*] when using a Notebook or Mini keyboard.
- **Alt-:** : Switch active radio
- **Alt-F1**: QSY band down (20 => 40 => ...)
- **Alt-F2**: QSY band up (20 => 15 => ...)
- **Alt-F4**: QSY back to run frequency, resume original CW speed
- **Alt-F5**: Set run frequency
- **Ctrl-S**: Swap the frequency on both radios (SO2R)
- **Ctrl-T**: Tune the transmitter (on CW, max 30 seconds)
- **Ctrl-F1** and **Ctrl-F2**: Switch mode (when the contest permits and mode=MIXED or ALL)

## Packet

- **Alt-A**: Open/Close DX-Cluster Announcements Window
- **Alt-O**: Open/Close DX-Cluster Monitor Window
- **Alt-T**: Talk to DX-Cluster
- **Alt-F3**: Spot

## Band Map

- **Ctrl-Enter**: Insert spot into [Band Map](#)
- **Ctrl-Del**: Delete spot on current frequency in the active Band Map
- **Ctrl-J**: Insert spot into Band Map
- **Ctrl-R**: Toggle band map view/list view
- **Ctrl-Up arrow**: Grab the first upper spot in the active Band Map (in frequency regarding the active radio)
- **Ctrl-Shift-Up arrow**: Grab the first upper spot in the active bandmap (in frequency regarding the active radio), even if it is a 0-pointer
- **Ctrl-Down arrow**: Grab the first lower spot in the active bandmap (in frequency regarding the active radio)
- **Ctrl-Shift-Down arrow**: Grab the first lower spot in the active bandmap (in frequency regarding the active radio), even if it is a 0-point station
- **Ctrl-Space**: Grab the spot on or near the current frequency. Enter some characters and it grabs a call from the visible spots in the Radio or the DX-cluster window.
- **Ctrl-DoubleClick** on a spot: Delete the spot without the warning window
- **Alt-DoubleClick** on a spot: Load the sub VFO with a spot frequency (if applicable)

## DX-Cluster Announcements

- **Ctrl-DoubleClick** on a spot: Delete the spot without the warning window
- **Alt-DoubleClick** on a spot: Load the sub VFO with a spot frequency (if applicable)

## Networking

- **Alt-D**: Pass a station
- **Alt-G**: Send a gab
- **Alt-I**: Open/Close Gab Window
- **Alt-J**: Display status of all stations in the network

## Multi Operator

- **Alt-Y**: Toggle current QSO's station type from RUN (R1) to MULT (M) in the M/S category, or from RUN1 (R1) to RUN2 (R2) in M/2 category, and vice versa.

If the cursor is on the logging line rather than a previously logged QSO when you press this key, the station type is changed for all new QSOs logged on that computer, i.e. it is equivalent to entering the text commands RUN/MULT or RUN1/RUN2. See [Menu: Commands | Station Type](#).

- **Ctrl-F3**: Toggle current QSO (same as **Alt-Y**)

## SO2R

- **AltGr-A, Ctrl-Alt-A**: Listen to the primary radio with both ears
- **AltGr-T, Ctrl-Alt-T**: Listen to the secondary radio with both ears
- **AltGr-S, Ctrl-Alt-S**: Listen to both radios in stereo (toggle)
- **AltGr-L, Ctrl-Alt-L**: Listen to the "other" radio with both ears during transmit (headphone "latch")
- **AltGr-R, Ctrl-Alt-R**: Restore automatic control (advanced scenarios will control headphones, like \$RESET)
- **AltGr-1...AltGr-8, Ctrl-Alt-1...Ctrl-Alt-8**: Select one of the eight SO2R scenarios

## Partner Mode

- **Alt-Enter**: Add the call current call to the partner window
- **Alt-Space**: Grab the call in the topmost "real time" line of the partner window
- **Alt-Backspace**: Clear everything in the partner window
- **Alt-1...Alt-9**: Grab the *n*th call from the partner window
- **Ctrl-1...Ctrl-9**: Swap the *n*th call in partner window with callsign in the logging window
- **DoubleClick** on a callsign: Grab the call from the partner window
- **Ctrl-DoubleClick** on a callsign: Delete the call from the partner window

## Contest Recorder

- **AltGr-Enter**: Play QSO
- **AltGr-Up**: Previous QSO
- **AltGr-Down**: Next QSO
- **AltGr-Space**: Play/Pause
- **AltGr-PgUp**: Rewind 30s
- **AltGr-PgDn**: FastForward 30s
- **AltGr-Left**: Rewind 5s
- **AltGr-Right**: FastForward 5s
- **AltGr-E**: Extract QSO
- **AltGr-O**: Start contest recorder

Some keyboards do not have an AltGr key, so use Ctrl+Alt instead.

## Special Keys

- **Alt-L**: Open QTC RX window (to be used by EU stations)
- **Ctrl-L**: Open QTC TX window (to be used by DX stations)

## Namespaces

- Page
- Discussion

## Variants

## Views

- [Read](#)
- [View source](#)
- [View history](#)

## More

- This page was last edited on 10 April 2023, at 06:53.

- [Privacy policy](#)
- [About Win-Test Wiki](#)
- [Disclaimers](#)



# Menu:Tools

From Win-Test Wiki

(Redirected from [LUA](#))

[Jump to navigation](#) [Jump to search](#)

## Menu:Tools

### Contents

- [1 Automatic CQ repeat](#)
- [2 Intelligent Quick QSL...](#)
- [3 Redefine keyboard keys](#)
  - ◆ [3.1 Remapping \[\\*\] and \[+\] when using Notebook or Mini keyboard](#)
  - ◆ [3.2 QWERTY and AZERTY Keyboards](#)
- [4 Data entry](#)
  - ◆ [4.1 Exchange guessing](#)
  - ◆ [4.2 Callsign check](#)
  - ◆ [4.3 Priority](#)
  - ◆ [4.4 Enable ESM](#)
  - ◆ [4.5 Disable CW cut numbers translation](#)
  - ◆ [4.6 Remap Slash to /P](#)
  - ◆ [4.7 Enable Run/S&P switching](#)
  - ◆ [4.8 Switch keyboard...](#)
- [5 Countdown timer...](#)
- [6 Scripts Manager](#)
  - ◆ [6.1 Introduction](#)
  - ◆ [6.2 # Notation](#)
  - ◆ [6.3 Calling Scripts via Text Command](#)
  - ◆ [6.4 Automatically Executed Scripts](#)
  - ◆ [6.5 Synchronous vs. asynchronous - the #@ Notation](#)
  - ◆ [6.6 Tips for Programming](#)
  - ◆ [6.7 Basic Examples](#)
    - ◇ [6.7.1 Example 1](#)
    - ◇ [6.7.2 Example 2](#)
    - ◇ [6.7.3 Example 3](#)
- [7 Load a target file](#)
- [8 Export a target file](#)
- [9 Check log](#)
- [10 Time shifting](#)
- [11 Correcting OP over a QSO range](#)
- [12 Download Files through the Network](#)

### Automatic CQ repeat

Use the [text command](#) **RPTDELAY** to get to this menu quickly.

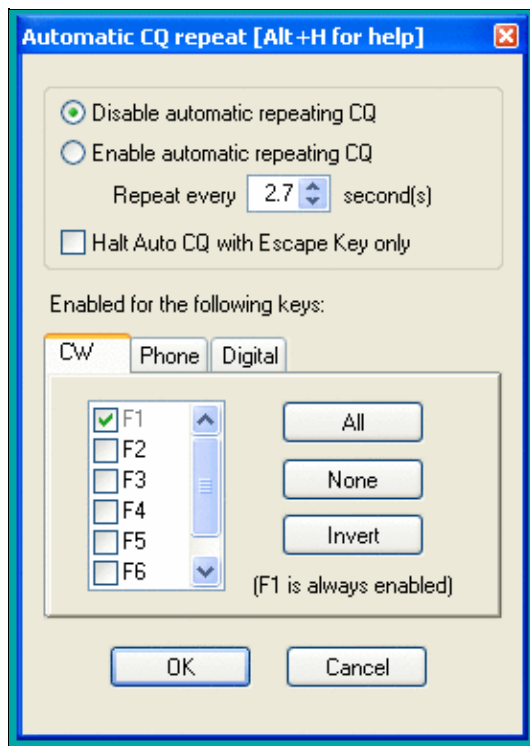

### Auto CQ Settings

This option allows you to automatically repeat messages after a certain amount of time if no key was pressed by the operator. This feature works on all modes and simulates the operator pressing one of the keys [F1] to [F7] key after so and so many seconds.

Traditionally, this is used for the [F1] key to auto-repeat CQ but it can also be used on other keys.

Contrary to CW operation, note that when using an external voice keyer on SSB (like the built-in DRU-2 in a Kenwood TS-850) Win-Test does not know when the message ends. For this reason, the time period to be set is the time that elapses between two CQ calls. This is also true for RTTY when using the MMTTY plug-in.

You may want to use the text commands **NORPT** or **RPT** to deactivate and later reactivate that function. Optionally, you may choose that only the Escape key deactivates the repeat function by clicking the appropriate option in the context menu or by **RPTESCONLY** and **NORPTESCONLY** text commands.

## Intelligent Quick QSL...

Use the text command **QUICKQSL** to get to this menu quickly. Use **QQSLON / QQSLOFF** or **QQSL / NOQQSL** text commands to enable (or disable) the Quick QSL feature.

This option controls the content of the two message variables **\$QQSLT** and **\$QQSLC**. When used, these variables change their content after so and so many seconds or when a number of QSOs have been logged. That way you can send a short QSL message to confirm the QSO in a pileup, but make sure your full callsign gets transmitted automatically every 2 minutes or every 5 QSOs only. So while most QSOs would be completed with **TU** or **EE** sometimes we would send a message like **TU F5MZN**.

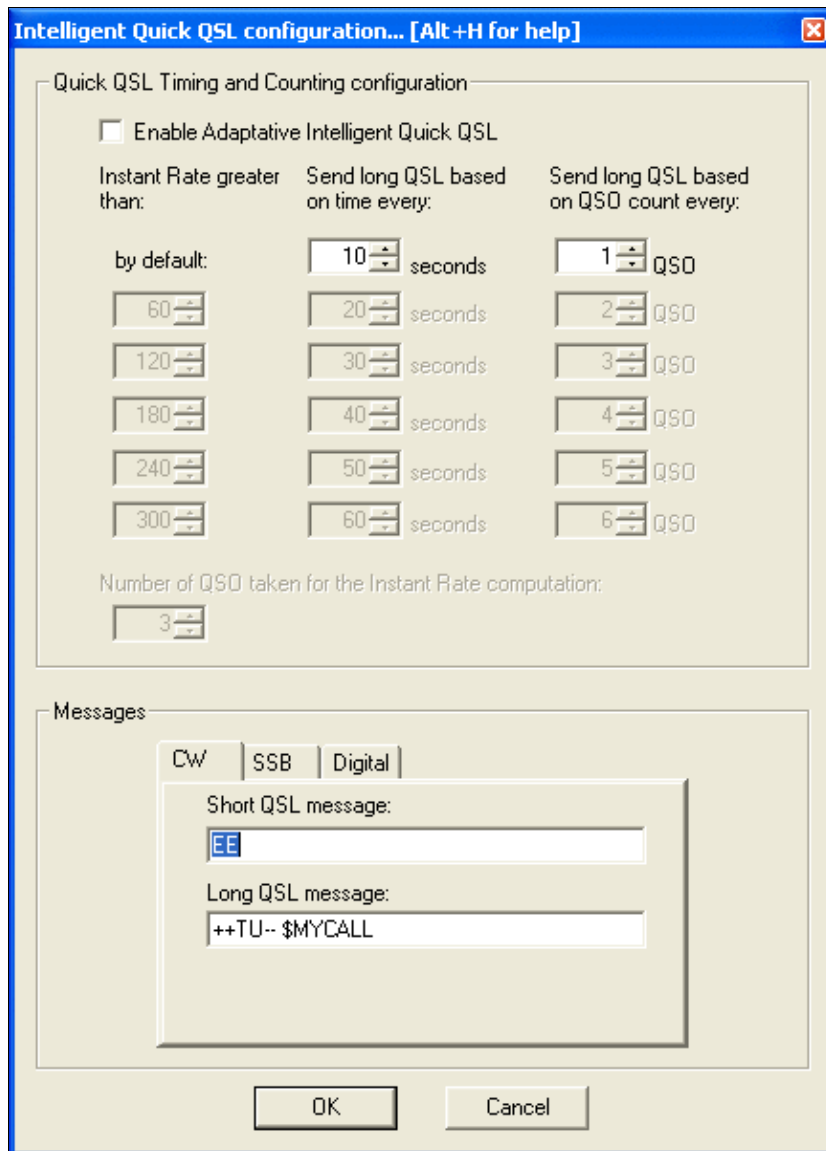

The intelligent quick QSL option allows you to automatically control sending of your own callsign every so often during a heavy pileup.

A timer (**\$QOQSLT** macro) or a counter (**\$QOQSLC** macro) are associated with these macros to determine if either a short or a long QSL message is to be transmitted. Additionally, this feature can be related to the current QSO rate (so-called adaptive intelligent quick QSL).

The **\$QOQSLC** and **\$QOQSLT** macros can either be used in the CW/RTTY Messages or in the advanced SO2R scenarios. It is also possible to use the feature in SSB (SO1R and SO2R not advanced) but this needs a specific configuration in the SSB tab of the configuration window.

In the **PLUS** message in the Standard CW messages configuration, replace **TU \$MYCALL** with **\$QOQSLC** or **\$QOQSLT**. Intelligent Quick QSL will then send a short QSL message or a long QSL message according to the set counter or the set timer in the respective variable.

The macro **\$QOQSLRESET** resets the timer or the counter like if the long QSL message were just sent. It makes sense to use this macro in each message you send your callsign in like CQ (**F1**) or MYCALL (**F4**). That way, you won't send a long QSL message after just having sent your call a few seconds before.

## Redefine keyboard keys

Use the text command **DEFINEKEYS** to get to this menu quickly.

On some keyboards, it is difficult to reach specific keys, so Win-Test allows you to re-define some of the keys on your keyboard.

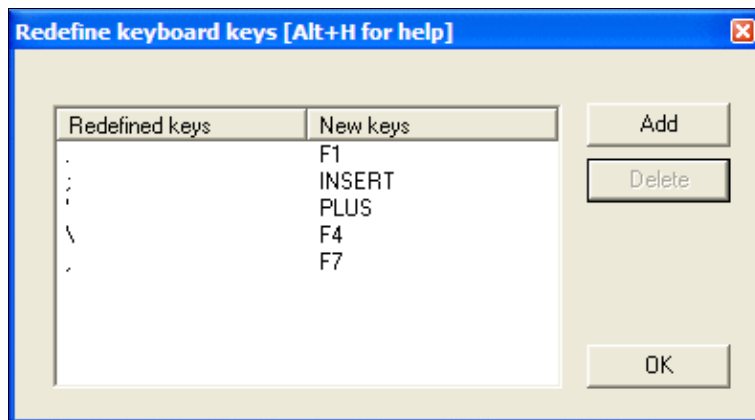

### Redefine Keyboard Keys

For example, to make the period key [ . ] call CQ, just like **[F1]**:

1. Press the **[Add]** button
2. Press the key you want to reprogram: the period key [ . ]
3. Press the key that does the function you want: the **[F1]** key
4. Press the **[OK]** button to save the changes, or press the **[Esc]** key to exit without saving any changes

To restore a remapped key to its default behavior, highlight a line by clicking on it with the mouse, then press the **[Delete]** button.



Remapping is done on a 1:1 basis. One keystroke becomes an alternate version of another. The original key still works as before. Keyboard remapping is saved in the wt.ini file, so the same map will automatically be used for all contests.

**WARNING:** Do not copy wt.ini from one machine to a new machine that already has a registered version of Win-Test, or else will have to re-enter the registration key on the new machine. See registration instructions.

In the example above, you can see how the commonly-used keys like **[F1]**, **[Ins]**, and **[+]** have all been remapped to keys that are much easier to reach on a U.S. keyboard, especially if you are a touch-typist. The keyboard map shown in the example was developed by N6TV for Team Vertical:

- **[.]** (the period key) calls CQ, just like **[F1]**
- **[;]** (the semicolon key) sends the message, just like the **[Ins]** key
- **[']** (the single-quote key) sends TU and logs the QSO, just like the **[+]** key
- **[\\]** (the backslash key, just above the **[Enter]** key on many U.S. keyboards) sends **\$MYCALL**, just like **[F4]**
- **[,]** (the comma key) sends a single question mark, just like **[F7]**

**NOTE:** Remapped keys are ignored in keyboard mode unless you enable the CW Option Remap keys in keyboard mode. It is generally a good idea to enable this option so that all message keys work the same, whether you are in keyboard mode or not.

### Remapping **[\*]** and **[+]** when using Notebook or Mini keyboard

By default, the asterisk key **[\*]** is used to switch active radios, and the plus key **[+]** is used to send "TU" and log a QSO. These keys are located on the numeric keypad of a full-sized keyboard. Win-Test does *not* treat these keys the same as **Shift-[\*]** and **Shift-[+]**, which is what you would normally press when typing text.

If you are using a Notebook, Laptop or "mini" keyboard without a separate numeric keypad on the right side, equivalent keys with special colored symbols become active only when you press the **[NumLock]** key. One of these keys should be labeled with an asterisk in a different color, and another should be the plus. For example, on a U.S. ThinkPad keyboard, the colored asterisk may be located on the **[P]** key, and the colored plus may be shared with the **[/]** key. Those are the keys to use when remapping, after activating Num Lock mode.

For example, to make Ctrl-S act as the "Switch Active Radio" key when using a keyboard without a numeric keypad:

1. Press the **[Add]** button
2. Press **[Ctrl-S]**
3. Press **Shift-[NumLock]** to enter Num Lock mode
4. Press the key that does the function of the asterisk when in Num Lock mode, perhaps the letter P?
5. Press **Shift-[NumLock]** again to exit Num Lock mode

If a single asterisk **\*** appears in the New Keys column as shown below, the key has been correctly defined. If it says **Shift \*** or something else, it has not.

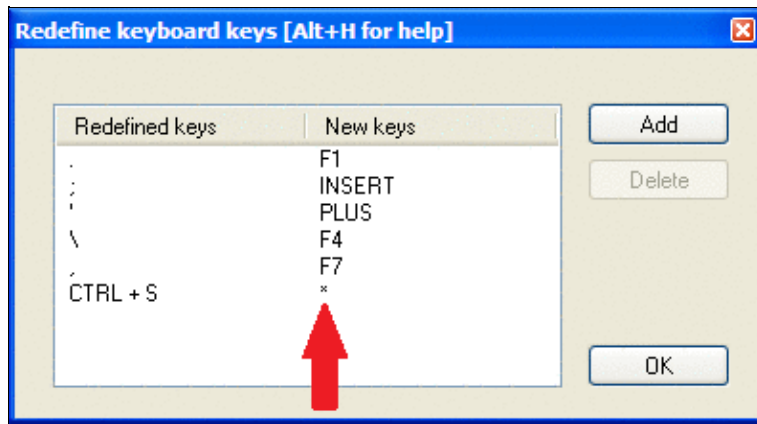

Redefine Keyboard Keys, with function of ASTERISK and PLUS keys properly re-assigned to other keys.  
**QWERTY and AZERTY Keyboards**

French (and some Belgian) users: Button added in the keys redefinitions dialog to load AZERTY redefinitions that allow the AZERTY keyboards users to access the numbers located on the top row without using the Shift or Shift Lock keys. They allow direct access to the ?, . and / keys of the bottom row as well. This button is displayed only when the language is set to French.

## Data entry

These functions describe settings that influence data entry to the log entry line.

## Exchange guessing

Exchange guessing is a feature of Win-Test that predicts the exchange that is going to be received before your QSO partner actually sends the report. In many contests a fixed piece of information is exchanged like the CQ zone in the CQWW contests, or ITU zone in IARU. This option allows you to select the way Win-Test fills in the exchange:

- pressing the space bar
- automatically
- after timeout

Note this option also acts on the various warnings (dupe, new mult, etc., if any) displayed under the log lines.

This feature saves you from continuously typing the same information over and over again but you better make yourself sure the guessed report is correct before you press the **[Enter]** key.

Please refer also to [Setting up Exchange Guessing in Win-Test](#) to know how to activate this feature for a specific contest.

**Note:** CQ zones in the USA and Russia will be guessed correctly (well, 99%) only when you have loaded F5IN's **CTY\_WT\_MOD.DAT** file. Otherwise Win-Test will always come up with the default zone of that country (5 for USA, 17 for UA9 and UA0). Please see [Data files](#) for more details on how to select the right **CTY** file.

## Callsign check

On the fly callsign pattern check based on the K1TTT callsign.pat file, described [here](#) (over 400 rules applied today). The latest version of callsign.pat may be downloaded [here](#).

Yellow text denotes a warning, red text denotes an invalid callsign.

5127 160 23:53 G3B	59 59 14	5127 160 23:53 G3B	59 59 14
5128 160 23:53 DR2W	59 59 14	5128 160 23:53 DR2W	59 59 14
5129 40 DP3Ø1DA	59 59 14	5129 40 DLOWB	59 59 14
* Call too long? *		* Starts with 3 characters! *	

Callsign possibly wrong

Callsign definitely wrong

Callsign pattern file location:

- Windows XP: **C:\Documents and Settings\All Users\Application Data\Win-Test\extras\callsign.pat**
- Windows Vista or Windows 7: **C:\ProgramData\Win-Test\extras\callsign.pat**

Updates may be downloaded from <http://download.win-test.com/files/extras/>.

You are encouraged to report to the author ([K1TTT](#)) any mistakes or updates needed in this file.

Callsigns which don't follow the usual rules, like RAEM, 5VDE, 7QAA, etc.) are grouped in the **exceptions.dat** file for easy updating.

## Priority

To change bands, you may wish to enter a frequency or band (m) into the callsign field. This option determines how these figures are to be understood by the program:

- Band - take 10,15,20,40,80,160 as a meter band
- Frequency - take the input as a frequency; shorted inputs as kHz

To make this a little more clear, if you enter 40:

- In the first case will switch the band to 40 meters (thus, enter 040 or 40.0 if you want to tune your radio to 040)
- In the second case it will tune your radio to decimal 040 on the current band (thus, enter 40M if you want to switch to 40 meters).

## Enable ESM

Win Test v4 comes with an Enter Sends Message (ESM) feature, well-known by users of TR LOG by N6TR. The functionality can be turned on or off via this menu item or using the [text commands](#) **ESM/NOESM**.

ESM relies on the following messages assignation:

F1: CQ

```
F2: Sent report
F4: Mycall
F5: Logged callsign ($LOGGED)
F7: ? (or "Again ?" in phone)
INSERT: Callsign + sent report
PLUS: TU + enter Q
```

The basic functionality of ESM can be described like this:

- Pressing **[Enter]** with an empty callsign field, will send the **[F1]** message.
- Pressing **[Enter]** with a callsign filled in but no report will send the **[INSERT]** message.
- Pressing **[Enter]** with callsign and report filled in will send the **[PLUS]** message.
- Pressing **[Enter]** with callsign and partial report filled in will send **[F7]** message.

It makes CW/RTTY easier, as you use one key for most of the operations instead of the various F keys.

There are additional minor details to ESM, which are not described here. On top, ESM behaviour is user-modifiable by using a script editor.

Once ESM is enabled, the **[Enter]** key **can no longer** be used to silently log a QSO. The key combination **[Ctrl+Plus]** has been introduced and added for this purpose.

When using the SO2R advanced technique, the scenarios messages are used instead of the standard.

## Disable CW cut numbers translation

Allows to completely disable Win-Test's intelligent translation of cut numbers like **TTA** to **001**. Note that this translation is performed on a contest and worked station contextual basis. The equivalent text commands are **CUTON** and **CUTOFF**. Do not mix up with **CUT/NOCUT** that are reserved for CW cut numbers generation !

## Remap Slash to /P

This option allows you to map "/" to "/P" for Field Day, VHF/UHF contests and DX pedition mode.

## Enable Run/S&P switching

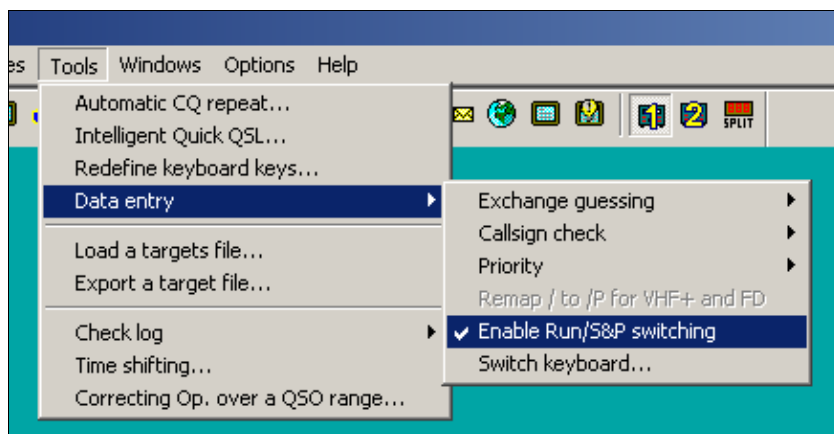

### Enable RUN/S&P switching

Allow switching between Run and Search & Pounce Operating Mode in order to have two different sets of CW/RTTY messages: one when running, and one when searching multipliers.

- The Run and S&P sets of messages are editable in the "Messages" Tab of the Standard CW/RTTY Messages Configuration window.
- Use **[Ctrl-tab]** to switch between RUN and S&P mode on the Primary Radio. The current mode is shown in the clock window. To change the mode of the Secondary Radio Window, use either **[Ctrl-Shift-tab]** or a mouse click on the appropriate control in the Secondary Radio Window.
- It is possible to configure WT to automatically populate the Band Map and wipe the data entry area whenever the operator changes the radio's frequency, if Search & Pounce mode is activated on that radio. This can be configured from the Band Map Properties dialog (right click in the Band Map window).

**Note:** Search & Pounce is not activated by default. To automatically populate the Band Map, you must switch to S&P mode.

**Note:** When switching from Run to S&P mode, Auto CQ and Auto CW Sending are automatically disabled.

### Switch keyboard...



Switch keyboard during the contest - useful for mult-national teams

Keyboard switching for international teams with different keyboards. It is enabled only if several keyboards are installed on your system. You can also access this dialog by entering the text commands **KEYBOARD** or **KEYB** for short.

### Countdown timer...

The countdown timer indicates exactly when the single operator can start operating again after a break. It's based on the time of the last QSO entered in the log, truncated to the minute.

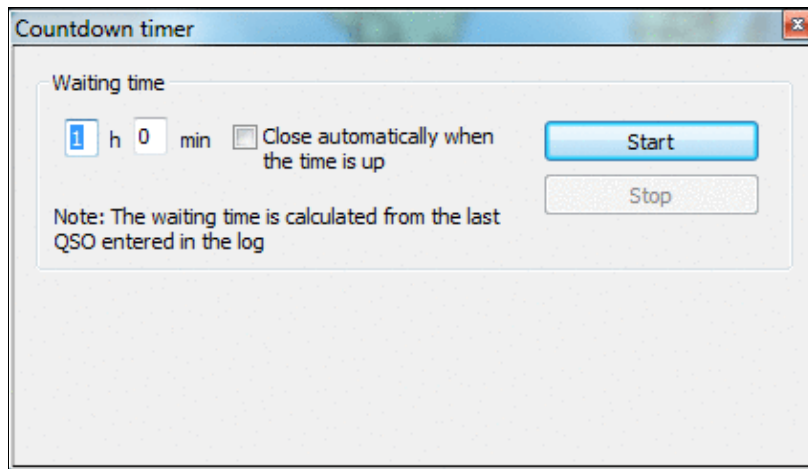

Countdown timer to plan breaks.

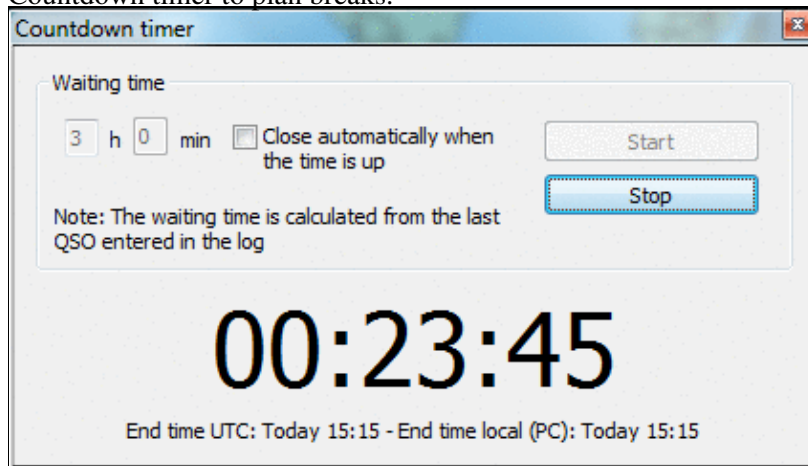

When running, it displays minutes when operation can commence.

You can also use the text command **TIMER/nnHmmM'** or **TIMER/nnHmm** (meaning nn hours and mm minutes), or **TIMER/xxH** (nn hours) or **TIMER/nnM** (nn minutes) to set and start the timer automatically.

## Scripts Manager

Allows to edit, create, delete or rename scripts. It's also used to assign a key and/or an argument to a script. Scripts are to be created and maintained by the user using the Lua programming language. See the [Win-test Lua API](#). For a reference of the Lua programming language, see <http://www.lua.org/manual/5.1/>. Sample Lua scripts demonstrating how to control the RIT and internal DVR (voice keyer) of the Elecraft K3 and other radios may be downloaded from <http://bit.ly/wtscripts>.

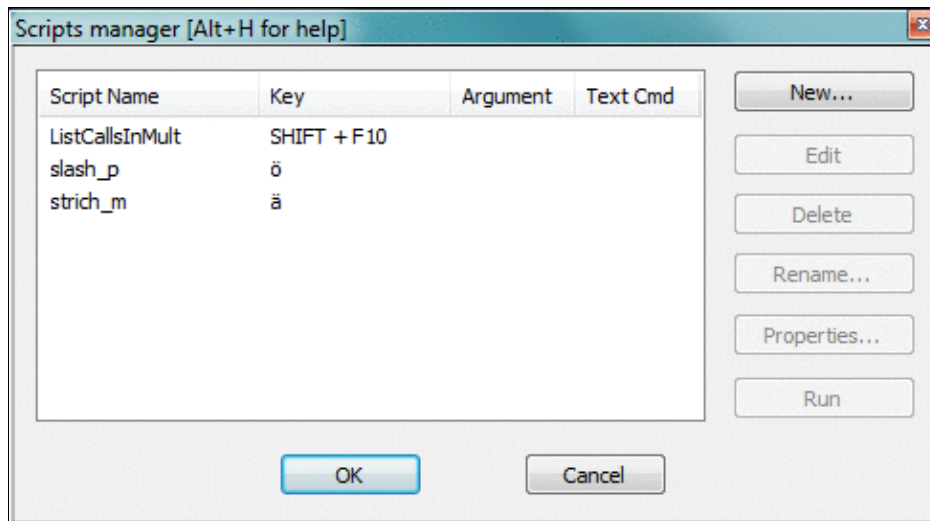

The Win-Test Scripts Manager to edit, create, delete or rename WTS scripts  
 You may also use the text command **SCRIPTS** to open the scripts manager.

By double-clicking an existing script, the default Editor is opened. Ctrl + Double click brings up the properties dialog.

Before you can modify scripts, you must configure an appropriate script editor. Per Default, Win-Test uses the SciTE Editor, which can be optionally installed. It does context sensitive highlighting, syntax checking etc. If you are only writing a simple script, Windows notepad.exe is probably sufficient.

## Introduction

The Win-Test scripting language gives the user the unique ability to achieve dynamic tasks in Win-Test. It also provides a way to share your work with other Win-Test users who don't have time or skill to write their own scripts.

ESM (Enter Sends Message) was the first Win-Test application where the scripting language **Lua** was used. The ESM function itself is a Lua script, embedded in Win-Test (not modifiable). But, it has been designed to be totally overridden by a user-written script if desired, i.e., you can write and use you own modified version of the ESM script to change the default ESM actions. See ESM Script (embedded into Win-Test) for the LUA source code.

To do this, the minimum requirement is to know some basics of a programming language. The Lua syntax is **very** simple for doing easy tasks. If you're comfortable with **any** programming language, you will learn Lua in minutes, at least for basic scripting involved in Win-Test. Many Win-Test API (Application Programming Interface) functions are provided to control various Win-Test features.

For a list of Win-Test API Functions and Constants, see API.

## # Notation

Scripts can either be called by pressing a key or from within a CW or RTTY message. For this, you must use the **#SCRIPTNAME (ARGUMENT)** notation. The argument (and parenthesis) are optional. The script will be called synchronously, but is executed in the main thread, meaning that it is not blocking the CW/RTTY

stream.

For example :

```
TU N6TV #CLEARIT
```

assuming your script is called **CLEARIT.wts** - or

```
TU #QSYUP(200)
```

assuming you created a script named **QSYUP.wts** to QSY up **wtArgument** Hz after a QSO.

## Calling Scripts via Text Command

Scripts may be triggered using a Text Command. **SCRIPT.wts** can be executed by entering **SCRIPT** in the callsign field.

An argument can be passed to the script by expanding it with a slash. **SCRIPT/5** will call **SCRIPT.wts** and pass the parameter "5" in the **wtArg** global variable. The argument is always passed as a string when the script is called from a text command. If no argument is specified, the default argument defined in the script manager will be used (if any).

## Automatically Executed Scripts

Some scripts are being executed automatically, whenever a specific event occurs.

<b>onFileOpen.wts</b>	Executed when .wt4 file is opened
<b>onFileClose.wts</b>	Executed when .wt4 file is closed
<b>onMicrohamFsOn.wts</b>	Executed, when microHAM footswitch is pressed
<b>onMicrohamFsOff.wts</b>	Executed, when microHAM footswitch is released
<b>onOtrspCrOn.wts</b>	Executed, when OTRSP control has value 1
<b>onOtrspCrOff.wts</b>	Executed, when OTRSP control has value 0
<b>onOtrspCrEvent.wts</b>	Executed, for all states of OTRSP events

## Synchronous vs. asynchronous - the #@ Notation

The scripts calls in the CW or RTTY messages are synchronous to the CW or the RTTY streams. To execute them asynchronously, they can be called with the #@ notation. Example:

```
-- script.wts
wtApp:AlertBox("Hello World!");
```

and the CW/RTTY message content is:

```
AAA #SCRIPT BBB
```



The keyer sends AAA, then "waits" until the user hits the OK button in the "Hello World!" alert box to send BBB. If the CW/RTTY message content is:

```
AAA #@SCRIPT BBB
```

The keyer sends AAA and starts the script (and the alert box is open), **but** it continues to key the rest of the message ("BBB") without waiting the user intervention. This is the asynchronous mode.

## Tips for Programming

1. Use the Scripts Manager to manage scripts, using a simple editor like Notepad. The scripts are stored in the {AppData}/All Users/Win-Test/scripts/ directory.
2. Before you can press the Edit button, make sure you have configured an ASCII editor in the Options Menu
3. If you wish to replace the built-in ESM script in Win-Test, save your script as "esm.wts". The value returned by your script will tell Win-Test what to do after it is executed:
  - ◆ If the return value is 0 (or if there is no return value), WT will run its own embedded script after yours.
  - ◆ If the return value is 1, WT will continue the Enter key process, without calling its embedded script.
  - ◆ And if the return value is -1, WT will stop the Enter key process, without calling its embedded script.
4. WT maintains two different QSO status: One for each radio. They are automatically cleared when the QSO is entered, if the operating mode (RUN/S&P) is switched or if the **wtQso:ClearStatus()** is executed.
5. Lua global variables are persistent between scripts calls. If you don't want this behavior, use local variables instead (keyword local).

## Basic Examples

### Example 1

```
-- esm.wts
wtApp:AlertBox("Enter key ! ESM rulez...");
return 0; -- This line can be omitted
-- end
```

No return value (or 0) => WT will execute this script (the alert box will be displayed), and the embedded script will be called after it.

### Example 2

```
-- esm.wts
wtApp:AlertBox("Enter key ! The key is processed by WT");
return 1;
-- end
```

The return value is 1 => After executing the script (the alert box will be displayed), WT will continue its own process and act exactly as if someone hit Enter. Read: It silently enters the QSO if it is OK. The embedded ESM script is ignored.

### Example 3

```
-- esm.wts
wtApp:AlertBox("Enter key ! The key processing is stopped");
return -1;
-- end
```

The return value is -1 => After executing the script (the alert box will be displayed), the embedded ESM script is ignored and WT will also ignore the Enter key process (no QSO is entered).

For a collection of more advanced programming examples please see [user contributed scripts](#) and [advanced programming examples](#).

## Load a target file

This option allows you to load a so-called target file - an ASCII file (maybe self-generated) that has QSO and multiplier targets for each hour of the contest. This is a nice way to integrate a plan into your contest environment to keep yourself motivated. In the old days we used to have a piece of paper on the wall - today Win-Test automatically tracks this information for your convenience.

Before you can load a target file you will have to create one or receive one from somebody else. Please see [Export a target file](#) on how to do that.

The content of the target file becomes visible in the statistics window (see [Statistics](#)) when you compare current standings with the values in the target file.

Loading a target file is usually a Pre-contest configuration task. Please refer to the usual [Pre-contest configuration](#) activities chapter in this manual.

A target file can also be loaded at any time during the contest. If you see your target score was too easy, you can load a new target to keep your motivation high. You set a target to break your national record, and now things go better and you see the possibility to break the continental record. How can you track this new situation? Preparing more than one file with different targets is a good practice: if conditions change then simply load the new target file and WT will show you how you are doing against that new target!

## Export a target file

This option allows you to create a target file from the log file currently loaded. It is useful to use last year's log as a start to create a target for this year's contest.

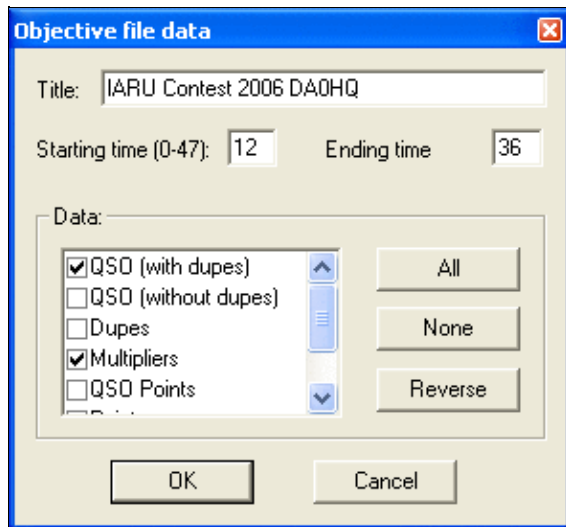

### Exporting a target (.obf) file

You should give a title to the target file to make clear what you're comparing to. Maybe you will want to change the target file to a more optimistic one when you'll realize band conditions are so great this time!

You may want to select which time frame to export (Starting time, ending time). Hours on Sunday have to be given in time + 24 hours so that 12:00 UTC on Sunday becomes 36.

Next you have to choose which columns to export to the target file. Normally you will want QSO count (with or without dupes), multipliers and points.

After pressing **OK** a file with the extension **.obf** will be created which will look similar to the file below:

```
#
# Target file generated by Win-Test
#
# VERSION 100
#
TITLE IARU Contest 2006 DA0HQ
START = 12
END = 36
12 QSO = 0 MULT = 0 POINTS = 0
13 QSO = 1 MULT = 1 POINTS = 1
14 QSO = 1 MULT = 1 POINTS = 1
15 QSO = 1 MULT = 1 POINTS = 1
16 QSO = 1 MULT = 1 POINTS = 1
17 QSO = 2 MULT = 2 POINTS = 4
18 QSO = 3 MULT = 2 POINTS = 4
19 QSO = 4 MULT = 2 POINTS = 6
20 QSO = 4 MULT = 2 POINTS = 6
21 QSO = 4 MULT = 2 POINTS = 6
22 QSO = 8 MULT = 3 POINTS = 18
23 QSO = 8 MULT = 3 POINTS = 18
24 QSO = 8 MULT = 3 POINTS = 18
25 QSO = 8 MULT = 3 POINTS = 18
26 QSO = 8 MULT = 3 POINTS = 18
27 QSO = 8 MULT = 3 POINTS = 18
28 QSO = 8 MULT = 3 POINTS = 18
29 QSO = 8 MULT = 3 POINTS = 18
30 QSO = 8 MULT = 3 POINTS = 18
31 QSO = 8 MULT = 3 POINTS = 18
```

32 QSO = 18 MULT = 3 POINTS = 21  
33 QSO = 30 MULT = 5 POINTS = 45  
34 QSO = 42 MULT = 5 POINTS = 50  
35 QSO = 81 MULT = 7 POINTS = 224

As you can see the structure of the file is so easy to understand that you might want to use an ASCII editor to go and make some changes - or create it completely from scratch yourself using this template!

## Check log

This tool allows you to verify if special restrictions of the contest rules have been adhered to in this log. You have different options, depending on the category you choose (see pictures below):

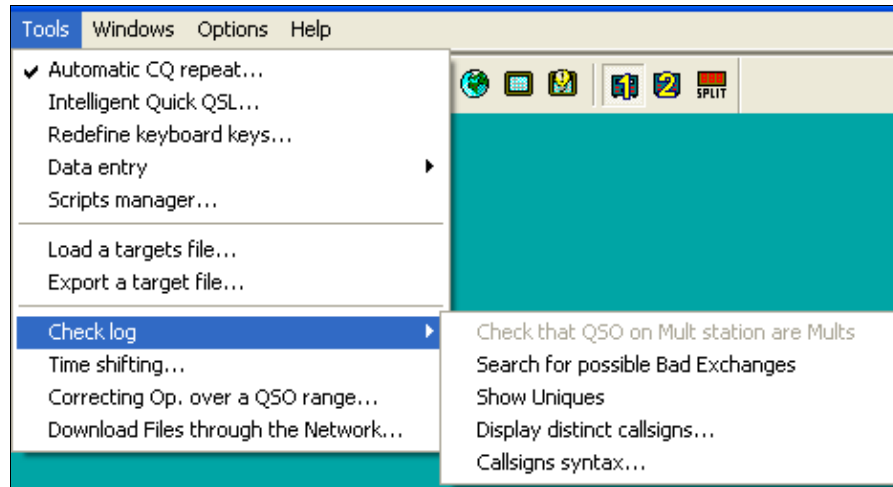

Check Log feature for the single operator category

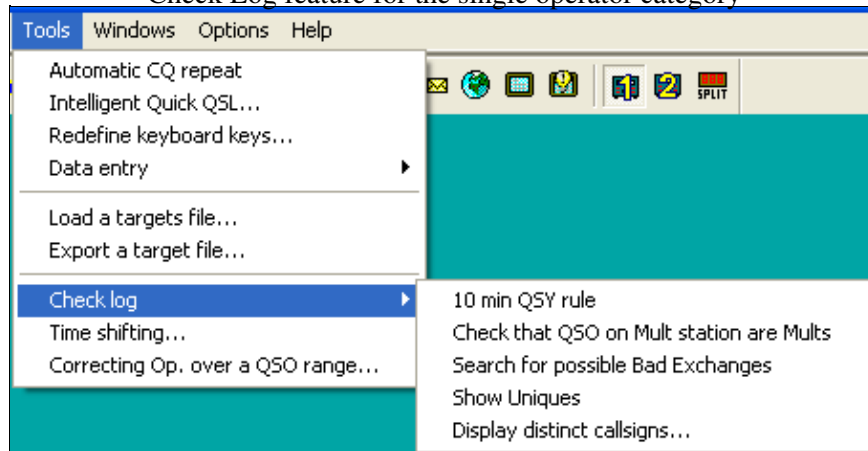

## Check Log feature for M/S category

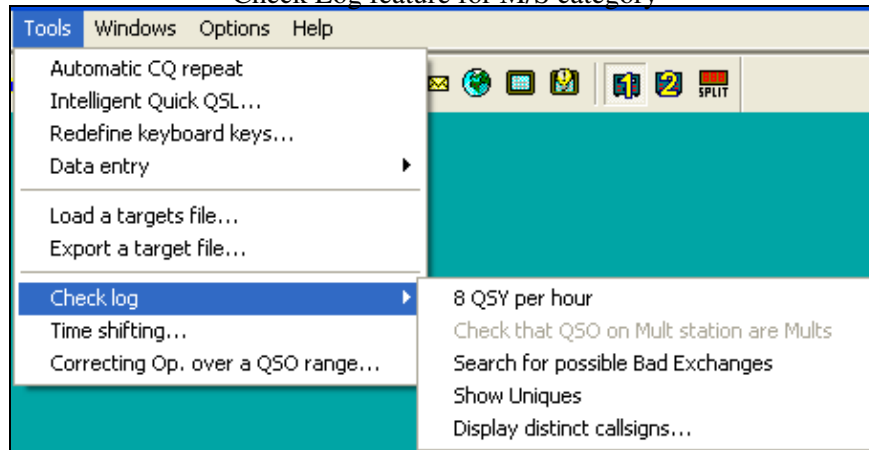

Check Log feature for the M2 category - note the differences in options offered. If you select a contest and/or category which does not have a QSY limit, this option will not show up.

Depending on the selected contest category, you may check for:

- **8 QSY per Hour:** Check the QSY count per hour (ARRL DX in M/2 category for example).
- **10 min QSY rule:** Check if the minimum time on a band has been respected (Multiplier station in a M/S effort during a CQWW DX for example).
- **Check that QSO on Mult station are Mults:** Check if all QSOs made on the multiplier station are actually multipliers. You may want to quote the exceptions (if any) when sending your log to the contest sponsor to avoid massive score reductions.
- **Search for possible Bad Exchanges:** Search the logged exchanges which are potentially bad, according to the database or to the other QSOs made with the same station during the contest. Works for CQWW, ARRL DX or any contest in which there is something which apparently is a zone. It also works for the VHF contest when a Gridsquare is logged.
- **Show Uniques:** Search N+1 for each unique logged callsign in the log. A unique callsign is a callsign that appears in the log only once (contact only on one band and mode, and no dupe). N+1 can be searched against the log, the callsign database (Master database) or both. It is possible to switch off N+1 searching for unique callsigns which are known to the callsign database.
- **Display distinct callsigns...:** Display all distinct callsigns of a log, and band(s)/mode(s) worked by each station. You can sort this report by callsign, by number of Q and by country.
- **Callsigns syntax...:** Match the callsigns to the callsign pattern file (see [Other Files](#)).
- **Open the notes linked to the current log:** Allows you to comfortably walk through your notes taken during the contest. Clicking on a line brings you to that specific QSO. Edit a note by selecting it and use **Alt-N** to modify the comment.
- **Open a different notes file:** Switch notes file, if more than one exists.
- **Download the LCR file:** Download your Log Check Report from the contest web site.

## Win-Test Wiki

- **Open a Different LCR file:** Switch to a different Log Check Report.

These are some of the typical reports you get:

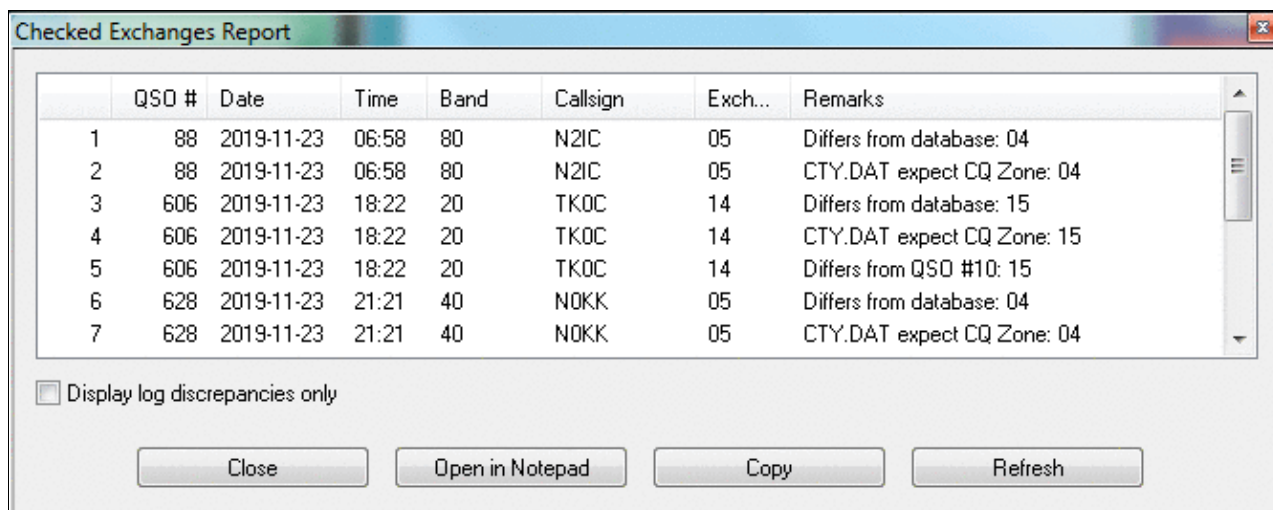

The screenshot shows a window titled "Checked Exchanges Report". It contains a table with 8 columns: QSO #, Date, Time, Band, Callsign, Exch..., and Remarks. The table lists 7 entries. Below the table is a checkbox labeled "Display log discrepancies only" which is unchecked. At the bottom are four buttons: "Close", "Open in Notepad", "Copy", and "Refresh".

QSO #	Date	Time	Band	Callsign	Exch...	Remarks	
1	88	2019-11-23	06:58	80	N2IC	05	Differs from database: 04
2	88	2019-11-23	06:58	80	N2IC	05	CTY.DAT expect CQ Zone: 04
3	606	2019-11-23	18:22	20	TK0C	14	Differs from database: 15
4	606	2019-11-23	18:22	20	TK0C	14	CTY.DAT expect CQ Zone: 15
5	606	2019-11-23	18:22	20	TK0C	14	Differs from QSO #10: 15
6	628	2019-11-23	21:21	40	N0KK	05	Differs from database: 04
7	628	2019-11-23	21:21	40	N0KK	05	CTY.DAT expect CQ Zone: 04

### Checked Exchanges Report

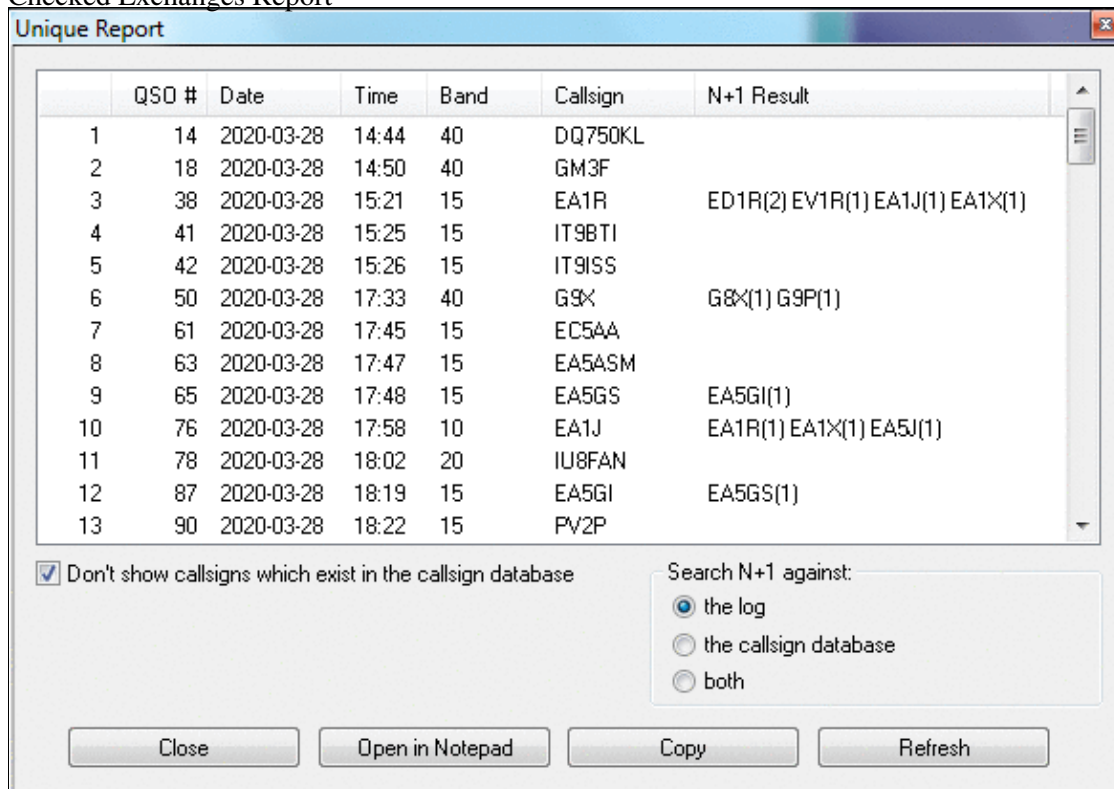

The screenshot shows a window titled "Unique Report". It contains a table with 7 columns: QSO #, Date, Time, Band, Callsign, and N+1 Result. The table lists 13 entries. Below the table is a checkbox labeled "Don't show callsigns which exist in the callsign database" which is checked. To the right of this checkbox is a section titled "Search N+1 against:" with three radio button options: "the log" (selected), "the callsign database", and "both". At the bottom are four buttons: "Close", "Open in Notepad", "Copy", and "Refresh".

QSO #	Date	Time	Band	Callsign	N+1 Result
1	14	2020-03-28	14:44	40	DQ750KL
2	18	2020-03-28	14:50	40	GM3F
3	38	2020-03-28	15:21	15	EA1R ED1R(2) EV1R(1) EA1J(1) EA1X(1)
4	41	2020-03-28	15:25	15	IT9BTI
5	42	2020-03-28	15:26	15	IT9ISS
6	50	2020-03-28	17:33	40	G9X G8X(1) G9P(1)
7	61	2020-03-28	17:45	15	EC5AA
8	63	2020-03-28	17:47	15	EA5ASM
9	65	2020-03-28	17:48	15	EA5GI(1)
10	76	2020-03-28	17:58	10	EA1J EA1R(1) EA1X(1) EA5J(1)
11	78	2020-03-28	18:02	20	IU8FAN
12	87	2020-03-28	18:19	15	EA5GI EA5GS(1)
13	90	2020-03-28	18:22	15	PV2P

Unique Report

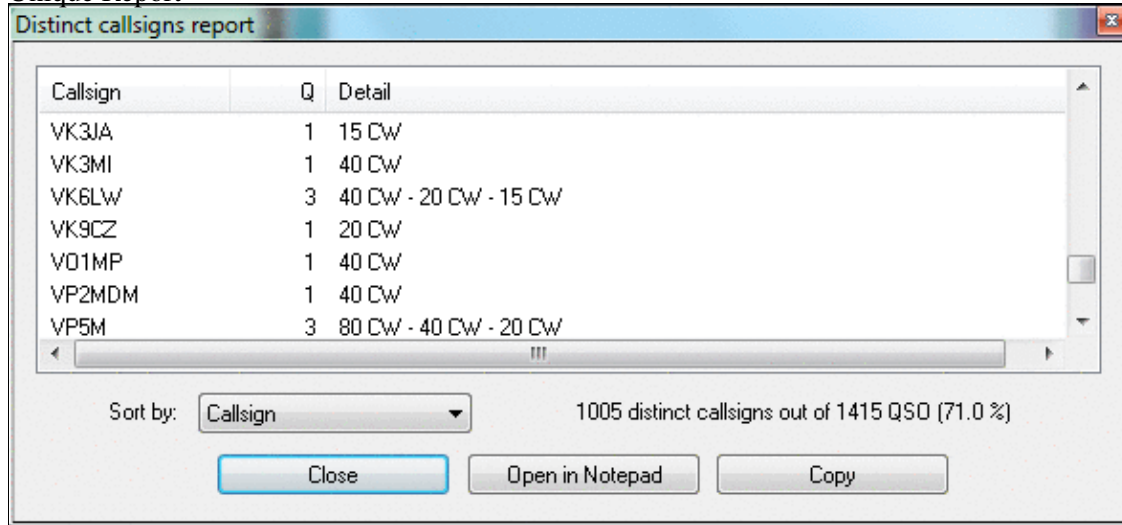

Distinct Callsigns Report - see who you worked on which bands/modes

You have the options of opening the report in a Notepad window for further processing. The Copy button allows you to Copy & Paste the data into a spreadsheet for comfortable filtering and processing. Additionally, you may press the Update button to create an updated report after you have done some changes to the log.

## Time shifting

This option allows you to **time shift** selected QSOs by any amount of time - either positive or negative. It lets you correct a constant time offset (like you had set the wrong date on the computer, or the clock was off by one hour). You may consider to use this option after the contest to avoid heavy manual editing of many QSO's time through the use of **Alt-F**.

The time shift can be applied to the entire log or to a range of QSOs, to the QSOs entered by your own station (this could make sense in a multi operator environment), to QSOs entered by several stations. Note that in a multi operator environment, one station should always be (or should have been) defined as the time master to establish a common time base in the network.

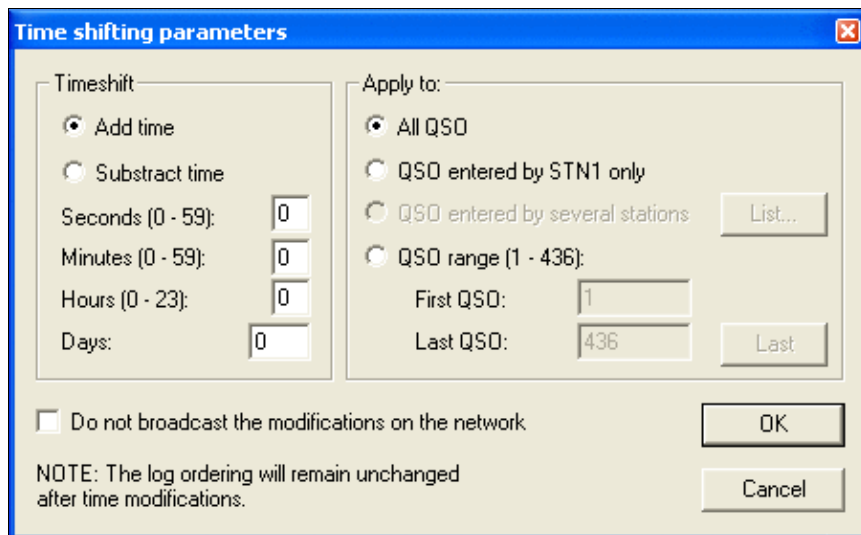

### Time Shifting Parameters

Even though this tool is supposed to be used after a contest to correct a wrong clock setting, each time change will be broadcasted to all other stations of the network by default. You can disable this broadcasting — if not needed.

Note that time shifting is pretty CPU consuming. It may take quite some time for large logs, because each QSO modification requires several internal structures (mainly statistics) to be updated accordingly. Time shifting **can not be cancelled** while it is in progress, to avoid any log inconsistency.

**Note:** Wise users will create a backup of their log before using this option.

## Correcting OP over a QSO range

This function lets you change (or add) the operator to a range of QSO. The QSOs are selectable by QSO number, by band, by mode or by callsign.

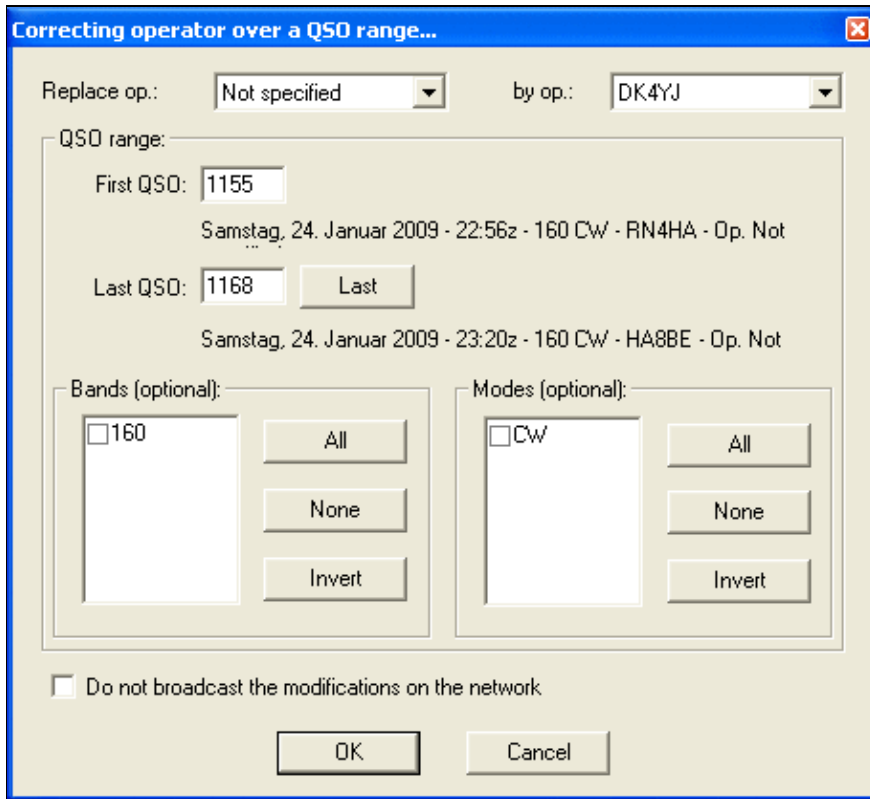



Tool to correct operator for a range of QSOs

## Download Files through the Network

To collect logs from different networked computers after a contest is over is the task of this function. Instead of having to visit each single computer, plug in the USB drive, copy the files over and move on to the next, this feature let's you collect the binary and notes files from all computers at once.

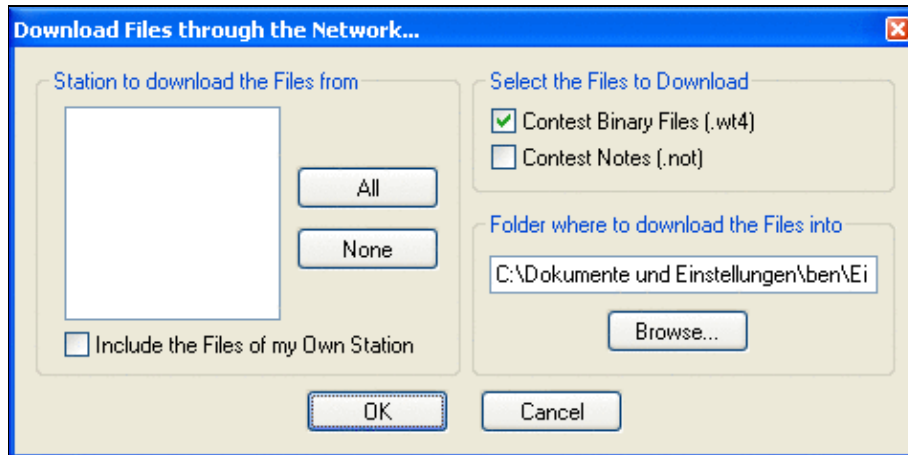

Collect files after the contest without leaving your chair

[Back to Menu](#)

## Namespaces

- [Page](#)
- [Discussion](#)

## Variants

## Views

- [Read](#)
- [View source](#)
- [View history](#)

## More

- This page was last edited on 9 April 2023, at 15:19.

- [Privacy policy](#)
- [About Win-Test Wiki](#)
- [Disclaimers](#)



# Menu:Tools

From Win-Test Wiki

(Redirected from [LUA](#))

[Jump to navigation](#) [Jump to search](#)

## Menu:Tools

### Contents

- [1 Automatic CQ repeat](#)
- [2 Intelligent Quick QSL...](#)
- [3 Redefine keyboard keys](#)
  - ◆ [3.1 Remapping \[\\*\] and \[+\] when using Notebook or Mini keyboard](#)
  - ◆ [3.2 QWERTY and AZERTY Keyboards](#)
- [4 Data entry](#)
  - ◆ [4.1 Exchange guessing](#)
  - ◆ [4.2 Callsign check](#)
  - ◆ [4.3 Priority](#)
  - ◆ [4.4 Enable ESM](#)
  - ◆ [4.5 Disable CW cut numbers translation](#)
  - ◆ [4.6 Remap Slash to /P](#)
  - ◆ [4.7 Enable Run/S&P switching](#)
  - ◆ [4.8 Switch keyboard...](#)
- [5 Countdown timer...](#)
- [6 Scripts Manager](#)
  - ◆ [6.1 Introduction](#)
  - ◆ [6.2 # Notation](#)
  - ◆ [6.3 Calling Scripts via Text Command](#)
  - ◆ [6.4 Automatically Executed Scripts](#)
  - ◆ [6.5 Synchronous vs. asynchronous - the #@ Notation](#)
  - ◆ [6.6 Tips for Programming](#)
  - ◆ [6.7 Basic Examples](#)
    - ◇ [6.7.1 Example 1](#)
    - ◇ [6.7.2 Example 2](#)
    - ◇ [6.7.3 Example 3](#)
- [7 Load a target file](#)
- [8 Export a target file](#)
- [9 Check log](#)
- [10 Time shifting](#)
- [11 Correcting OP over a QSO range](#)
- [12 Download Files through the Network](#)

### Automatic CQ repeat

Use the [text command](#) **RPTDELAY** to get to this menu quickly.

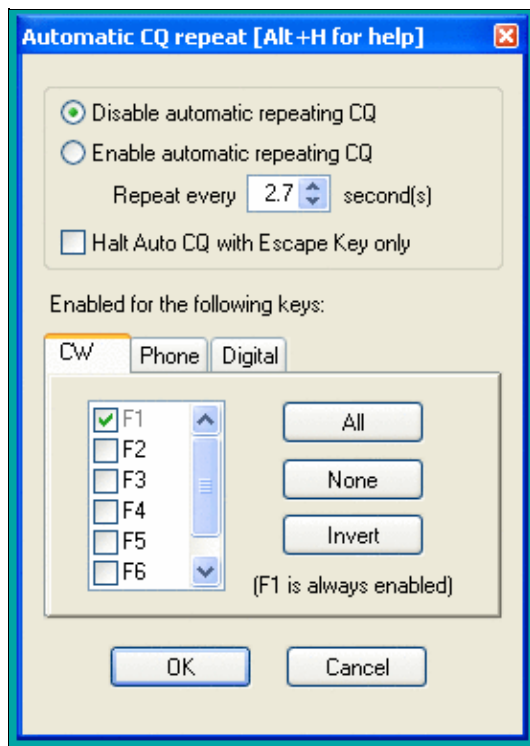

### Auto CQ Settings

This option allows you to automatically repeat messages after a certain amount of time if no key was pressed by the operator. This feature works on all modes and simulates the operator pressing one of the keys [F1] to [F7] key after so and so many seconds.

Traditionally, this is used for the [F1] key to auto-repeat CQ but it can also be used on other keys.

Contrary to CW operation, note that when using an external voice keyer on SSB (like the built-in DRU-2 in a Kenwood TS-850) Win-Test does not know when the message ends. For this reason, the time period to be set is the time that elapses between two CQ calls. This is also true for RTTY when using the MMTTY plug-in.

You may want to use the text commands **NORPT** or **RPT** to deactivate and later reactivate that function. Optionally, you may choose that only the Escape key deactivates the repeat function by clicking the appropriate option in the context menu or by **RPTESCONLY** and **NORPTESCONLY** text commands.

## Intelligent Quick QSL...

Use the text command **QUICKQSL** to get to this menu quickly. Use **QQSLON / QQSLOFF** or **QQSL / NOQQSL** text commands to enable (or disable) the Quick QSL feature.

This option controls the content of the two message variables **\$QQSLT** and **\$QQSLC**. When used, these variables change their content after so and so many seconds or when a number of QSOs have been logged. That way you can send a short QSL message to confirm the QSO in a pileup, but make sure your full callsign gets transmitted automatically every 2 minutes or every 5 QSOs only. So while most QSOs would be completed with **TU** or **EE** sometimes we would send a message like **TU F5MZN**.

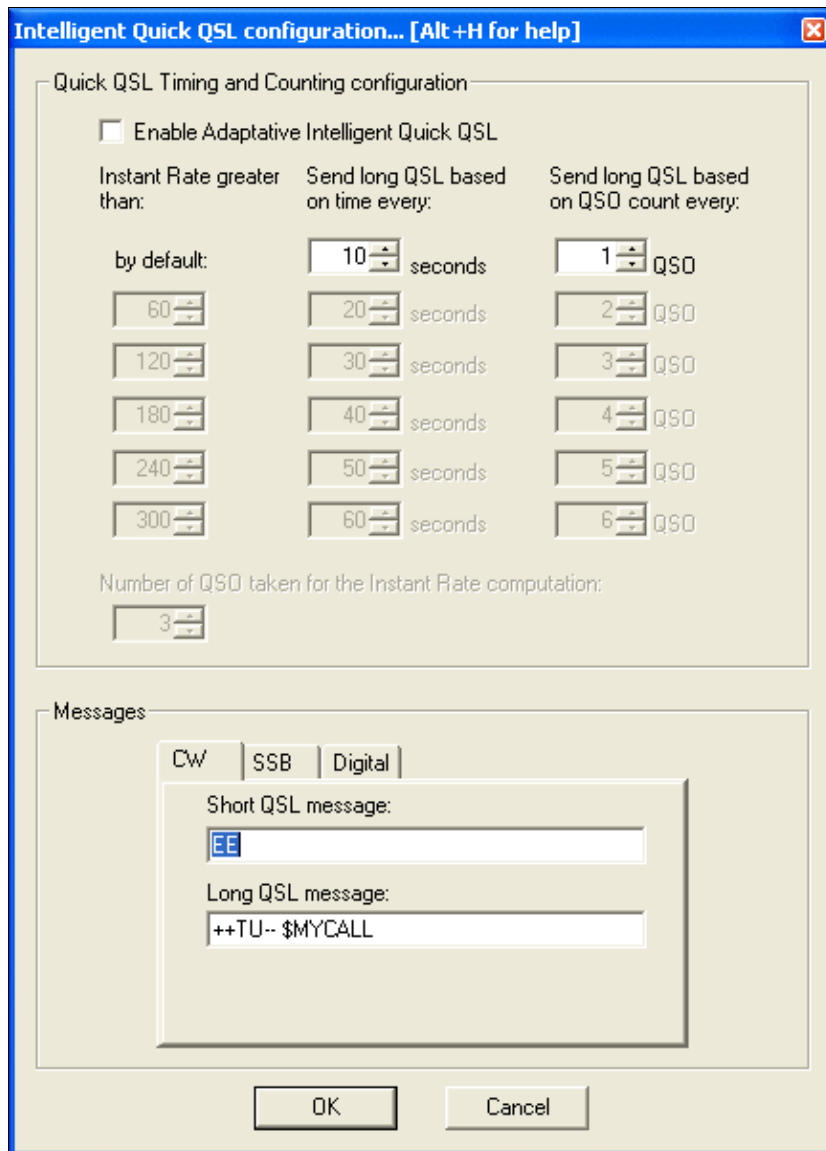

The intelligent quick QSL option allows you to automatically control sending of your own callsign every so often during a heavy pileup.

A timer (**\$QOQSLT** macro) or a counter (**\$QOQSLC** macro) are associated with these macros to determine if either a short or a long QSL message is to be transmitted. Additionally, this feature can be related to the current QSO rate (so-called adaptive intelligent quick QSL).

The **\$QOQSLC** and **\$QOQSLT** macros can either be used in the CW/RTTY Messages or in the advanced SO2R scenarios. It is also possible to use the feature in SSB (SO1R and SO2R not advanced) but this needs a specific configuration in the SSB tab of the configuration window.

In the **PLUS** message in the Standard CW messages configuration, replace **TU \$MYCALL** with **\$QOQSLC** or **\$QOQSLT**. Intelligent Quick QSL will then send a short QSL message or a long QSL message according to the set counter or the set timer in the respective variable.

The macro **\$QOQSLRESET** resets the timer or the counter like if the long QSL message were just sent. It makes sense to use this macro in each message you send your callsign in like CQ (**F1**) or MYCALL (**F4**). That way, you won't send a long QSL message after just having sent your call a few seconds before.

## Redefine keyboard keys

Use the text command **DEFINEKEYS** to get to this menu quickly.

On some keyboards, it is difficult to reach specific keys, so Win-Test allows you to re-define some of the keys on your keyboard.

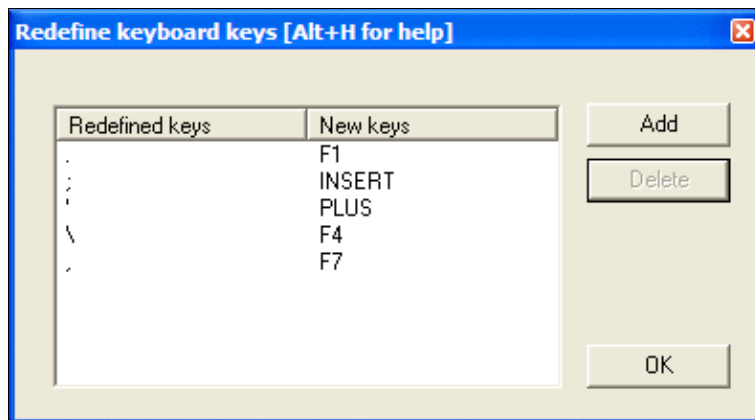

### Redefine Keyboard Keys

For example, to make the period key [ . ] call CQ, just like **[F1]**:

1. Press the **[Add]** button
2. Press the key you want to reprogram: the period key [ . ]
3. Press the key that does the function you want: the **[F1]** key
4. Press the **[OK]** button to save the changes, or press the **[Esc]** key to exit without saving any changes

To restore a remapped key to its default behavior, highlight a line by clicking on it with the mouse, then press the **[Delete]** button.

Remapping is done on a 1:1 basis. One keystroke becomes an alternate version of another. The original key still works as before. Keyboard remapping is saved in the wt.ini file, so the same map will automatically be used for all contests.

**WARNING:** Do not copy wt.ini from one machine to a new machine that already has a registered version of Win-Test, or else will have to re-enter the registration key on the new machine. See registration instructions.

In the example above, you can see how the commonly-used keys like **[F1]**, **[Ins]**, and **[+]** have all been remapped to keys that are much easier to reach on a U.S. keyboard, especially if you are a touch-typist. The keyboard map shown in the example was developed by N6TV for Team Vertical:

- **[.]** (the period key) calls CQ, just like **[F1]**
- **[;]** (the semicolon key) sends the message, just like the **[Ins]** key
- **[']** (the single-quote key) sends TU and logs the QSO, just like the **[+]** key
- **[\\]** (the backslash key, just above the **[Enter]** key on many U.S. keyboards) sends **\$MYCALL**, just like **[F4]**
- **[,]** (the comma key) sends a single question mark, just like **[F7]**

**NOTE:** Remapped keys are ignored in keyboard mode unless you enable the CW Option Remap keys in keyboard mode. It is generally a good idea to enable this option so that all message keys work the same, whether you are in keyboard mode or not.

### Remapping **[\*]** and **[+]** when using Notebook or Mini keyboard

By default, the asterisk key **[\*]** is used to switch active radios, and the plus key **[+]** is used to send "TU" and log a QSO. These keys are located on the numeric keypad of a full-sized keyboard. Win-Test does *not* treat these keys the same as **Shift-[\*]** and **Shift-[+]**, which is what you would normally press when typing text.

If you are using a Notebook, Laptop or "mini" keyboard without a separate numeric keypad on the right side, equivalent keys with special colored symbols become active only when you press the **[NumLock]** key. One of these keys should be labeled with an asterisk in a different color, and another should be the plus. For example, on a U.S. ThinkPad keyboard, the colored asterisk may be located on the **[P]** key, and the colored plus may be shared with the **[/]** key. Those are the keys to use when remapping, after activating Num Lock mode.

For example, to make Ctrl-S act as the "Switch Active Radio" key when using a keyboard without a numeric keypad:

1. Press the **[Add]** button
2. Press **[Ctrl-S]**
3. Press **Shift-[NumLock]** to enter Num Lock mode
4. Press the key that does the function of the asterisk when in Num Lock mode, perhaps the letter P?
5. Press **Shift-[NumLock]** again to exit Num Lock mode

If a single asterisk **\*** appears in the New Keys column as shown below, the key has been correctly defined. If it says **Shift \*** or something else, it has not.

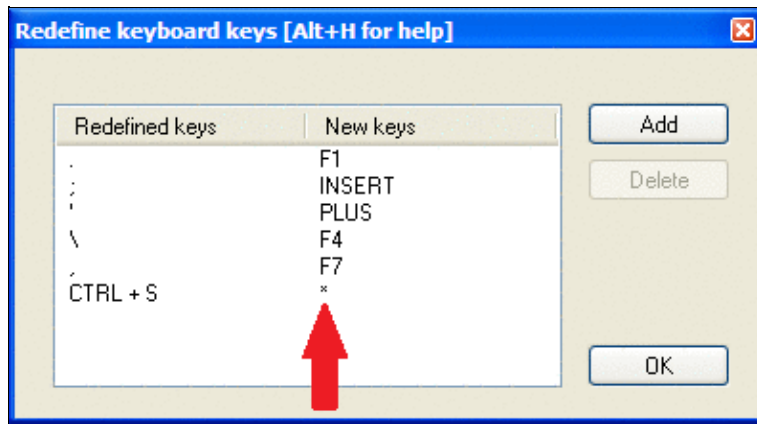

Redefine Keyboard Keys, with function of ASTERISK and PLUS keys properly re-assigned to other keys.  
**QWERTY and AZERTY Keyboards**

French (and some Belgian) users: Button added in the keys redefinitions dialog to load AZERTY redefinitions that allow the AZERTY keyboards users to access the numbers located on the top row without using the Shift or Shift Lock keys. They allow direct access to the ?, . and / keys of the bottom row as well. This button is displayed only when the language is set to French.

## Data entry

These functions describe settings that influence data entry to the log entry line.

## Exchange guessing

Exchange guessing is a feature of Win-Test that predicts the exchange that is going to be received before your QSO partner actually sends the report. In many contests a fixed piece of information is exchanged like the CQ zone in the CQWW contests, or ITU zone in IARU. This option allows you to select the way Win-Test fills in the exchange:

- pressing the space bar
- automatically
- after timeout

Note this option also acts on the various warnings (dupe, new mult, etc., if any) displayed under the log lines.

This feature saves you from continuously typing the same information over and over again but you better make yourself sure the guessed report is correct before you press the [**Enter**] key.

Please refer also to [Setting up Exchange Guessing in Win-Test](#) to know how to activate this feature for a specific contest.

**Note:** CQ zones in the USA and Russia will be guessed correctly (well, 99%) only when you have loaded F5IN's **CTY\_WT\_MOD.DAT** file. Otherwise Win-Test will always come up with the default zone of that country (5 for USA, 17 for UA9 and UA0). Please see [Data files](#) for more details on how to select the right **CTY** file.

## Callsign check

On the fly callsign pattern check based on the K1TTT callsign.pat file, described [here](#) (over 400 rules applied today). The latest version of callsign.pat may be downloaded [here](#).

Yellow text denotes a warning, red text denotes an invalid callsign.

5127 160 23:53 G3B	59 59 14	5127 160 23:53 G3B	59 59 14
5128 160 23:53 DR2W	59 59 14	5128 160 23:53 DR2W	59 59 14
5129 40 DP301DA	59 59 14	5129 40 DLOWB	59 59 14
* Call too long? *		* Starts with 3 characters! *	

Callsign possibly wrong

Callsign definitely wrong

Callsign pattern file location:

- Windows XP: C:\Documents and Settings\All Users\Application Data\Win-Test\extras\callsign.pat
- Windows Vista or Windows 7: C:\ProgramData\Win-Test\extras\callsign.pat

Updates may be downloaded from <http://download.win-test.com/files/extras/>.

You are encouraged to report to the author ([K1TTT](#)) any mistakes or updates needed in this file.

Callsigns which don't follow the usual rules, like RAEM, 5VDE, 7QAA, etc.) are grouped in the **exceptions.dat** file for easy updating.

## Priority

To change bands, you may wish to enter a frequency or band (m) into the callsign field. This option determines how these figures are to be understood by the program:

- Band - take 10,15,20,40,80,160 as a meter band
- Frequency - take the input as a frequency; shorted inputs as kHz

To make this a little more clear, if you enter 40:

- In the first case will switch the band to 40 meters (thus, enter 040 or 40.0 if you want to tune your radio to 040)
- In the second case it will tune your radio to decimal 040 on the current band (thus, enter 40M if you want to switch to 40 meters).

## Enable ESM

Win Test v4 comes with an Enter Sends Message (ESM) feature, well-known by users of TR LOG by N6TR. The functionality can be turned on or off via this menu item or using the [text commands](#) **ESM/NOESM**.

ESM relies on the following messages assignation:

F1: CQ



```
F2: Sent report
F4: Mycall
F5: Logged callsign ($LOGGED)
F7: ? (or "Again ?" in phone)
INSERT: Callsign + sent report
PLUS: TU + enter Q
```

The basic functionality of ESM can be described like this:

- Pressing **[Enter]** with an empty callsign field, will send the **[F1]** message.
- Pressing **[Enter]** with a callsign filled in but no report will send the **[INSERT]** message.
- Pressing **[Enter]** with callsign and report filled in will send the **[PLUS]** message.
- Pressing **[Enter]** with callsign and partial report filled in will send **[F7]** message.

It makes CW/RTTY easier, as you use one key for most of the operations instead of the various F keys.

There are additional minor details to ESM, which are not described here. On top, ESM behaviour is user-modifiable by using a script editor.

Once ESM is enabled, the **[Enter]** key **can no longer** be used to silently log a QSO. The key combination **[Ctrl+Plus]** has been introduced and added for this purpose.

When using the SO2R advanced technique, the scenarios messages are used instead of the standard.

## Disable CW cut numbers translation

Allows to completely disable Win-Test's intelligent translation of cut numbers like **TTA** to **001**. Note that this translation is performed on a contest and worked station contextual basis. The equivalent text commands are **CUTON** and **CUTOFF**. Do not mix up with **CUT/NOCUT** that are reserved for CW cut numbers generation !

## Remap Slash to /P

This option allows you to map "/" to "/P" for Field Day, VHF/UHF contests and DX pedition mode.

## Enable Run/S&P switching

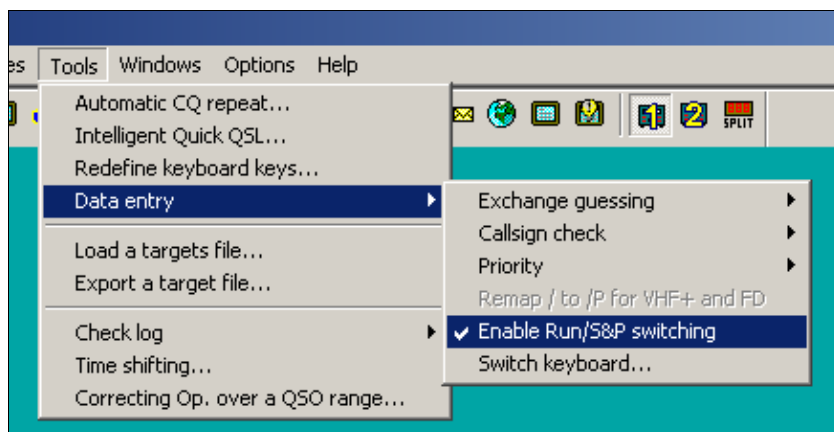

### Enable RUN/S&P switching

Allow switching between Run and Search & Pounce Operating Mode in order to have two different sets of CW/RTTY messages: one when running, and one when searching multipliers.

- The Run and S&P sets of messages are editable in the "Messages" Tab of the Standard CW/RTTY Messages Configuration window.
- Use **[Ctrl-tab]** to switch between RUN and S&P mode on the Primary Radio. The current mode is shown in the clock window. To change the mode of the Secondary Radio Window, use either **[Ctrl-Shift-tab]** or a mouse click on the appropriate control in the Secondary Radio Window.
- It is possible to configure WT to automatically populate the Band Map and wipe the data entry area whenever the operator changes the radio's frequency, if Search & Pounce mode is activated on that radio. This can be configured from the Band Map Properties dialog (right click in the Band Map window).

**Note:** Search & Pounce is not activated by default. To automatically populate the Band Map, you must switch to S&P mode.

**Note:** When switching from Run to S&P mode, Auto CQ and Auto CW Sending are automatically disabled.

### Switch keyboard...



Switch keyboard during the contest - useful for mult-national teams

Keyboard switching for international teams with different keyboards. It is enabled only if several keyboards are installed on your system. You can also access this dialog by entering the text commands **KEYBOARD** or **KEYB** for short.

### Countdown timer...

The countdown timer indicates exactly when the single operator can start operating again after a break. It's based on the time of the last QSO entered in the log, truncated to the minute.

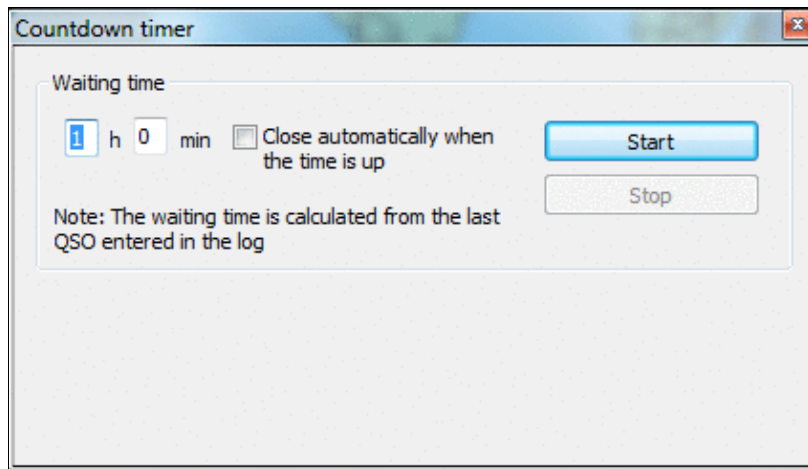

Countdown timer to plan breaks.

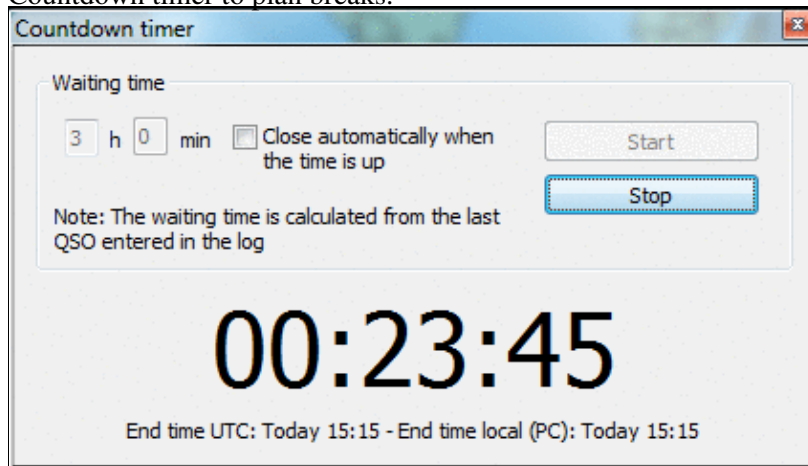

When running, it displays minutes when operation can commence.

You can also use the text command **TIMER/nnHmmM'** or **TIMER/nnHmm** (meaning nn hours and mm minutes), or **TIMER/xxH** (nn hours) or **TIMER/nnM** (nn minutes) to set and start the timer automatically.

## Scripts Manager

Allows to edit, create, delete or rename scripts. It's also used to assign a key and/or an argument to a script. Scripts are to be created and maintained by the user using the Lua programming language. See the [Win-test Lua API](#). For a reference of the Lua programming language, see <http://www.lua.org/manual/5.1/>. Sample Lua scripts demonstrating how to control the RIT and internal DVR (voice keyer) of the Elecraft K3 and other radios may be downloaded from <http://bit.ly/wtscripts>.

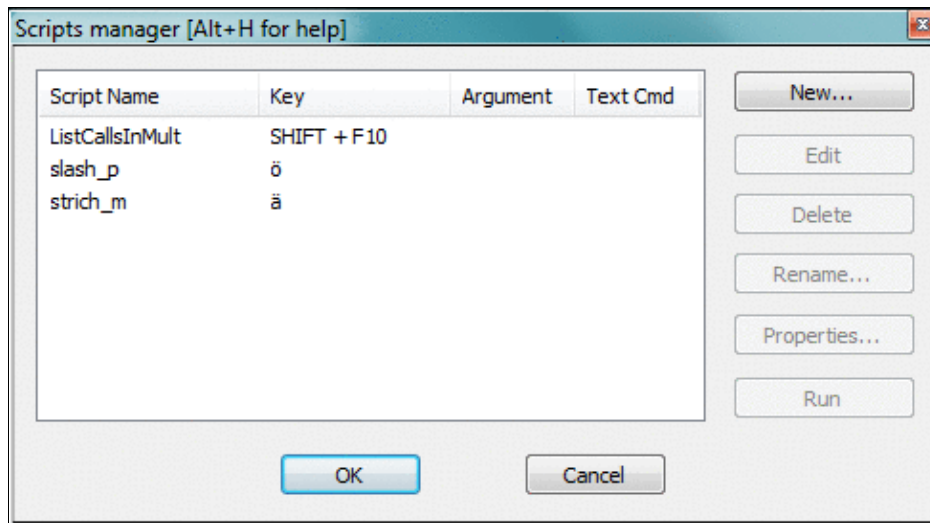

The Win-Test Scripts Manager to edit, create, delete or rename WTS scripts. You may also use the text command **SCRIPTS** to open the scripts manager.

By double-clicking an existing script, the default Editor is opened. Ctrl + Double click brings up the properties dialog.

Before you can modify scripts, you must configure an appropriate script editor. Per Default, Win-Test uses the SciTE Editor, which can be optionally installed. It does context sensitive highlighting, syntax checking etc. If you are only writing a simple script, Windows notepad.exe is probably sufficient.

## Introduction

The Win-Test scripting language gives the user the unique ability to achieve dynamic tasks in Win-Test. It also provides a way to share your work with other Win-Test users who don't have time or skill to write their own scripts.

ESM (Enter Sends Message) was the first Win-Test application where the scripting language **Lua** was used. The ESM function itself is a Lua script, embedded in Win-Test (not modifiable). But, it has been designed to be totally overridden by a user-written script if desired, i.e., you can write and use your own modified version of the ESM script to change the default ESM actions. See ESM Script (embedded into Win-Test) for the LUA source code.

To do this, the minimum requirement is to know some basics of a programming language. The Lua syntax is **very** simple for doing easy tasks. If you're comfortable with **any** programming language, you will learn Lua in minutes, at least for basic scripting involved in Win-Test. Many Win-Test API (Application Programming Interface) functions are provided to control various Win-Test features.

For a list of Win-Test API Functions and Constants, see API.

## # Notation

Scripts can either be called by pressing a key or from within a CW or RTTY message. For this, you must use the **#SCRIPTNAME (ARGUMENT)** notation. The argument (and parenthesis) are optional. The script will be called synchronously, but is executed in the main thread, meaning that it is not blocking the CW/RTTY

stream.

For example :

```
TU N6TV #CLEARIT
```

assuming your script is called **CLEARIT.wts** - or

```
TU #QSYUP(200)
```

assuming you created a script named **QSYUP.wts** to QSY up **wtArgument** Hz after a QSO.

## Calling Scripts via Text Command

Scripts may be triggered using a Text Command. **SCRIPT.wts** can be executed by entering **SCRIPT** in the callsign field.

An argument can be passed to the script by expanding it with a slash. **SCRIPT/5** will call **SCRIPT.wts** and pass the parameter "5" in the **wtArg** global variable. The argument is always passed as a string when the script is called from a text command. If no argument is specified, the default argument defined in the script manager will be used (if any).

## Automatically Executed Scripts

Some scripts are being executed automatically, whenever a specific event occurs.

<b>onFileOpen.wts</b>	Executed when .wt4 file is opened
<b>onFileClose.wts</b>	Executed when .wt4 file is closed
<b>onMicrohamFsOn.wts</b>	Executed, when microHAM footswitch is pressed
<b>onMicrohamFsOff.wts</b>	Executed, when microHAM footswitch is released
<b>onOtrspCrOn.wts</b>	Executed, when OTRSP control has value 1
<b>onOtrspCrOff.wts</b>	Executed, when OTRSP control has value 0
<b>onOtrspCrEvent.wts</b>	Executed, for all states of OTRSP events

## Synchronous vs. asynchronous - the #@ Notation

The scripts calls in the CW or RTTY messages are synchronous to the CW or the RTTY streams. To execute them asynchronously, they can be called with the #@ notation. Example:

```
-- script.wts
wtApp:AlertBox("Hello World!");
```

and the CW/RTTY message content is:

```
AAA #SCRIPT BBB
```

The keyer sends AAA, then "waits" until the user hits the OK button in the "Hello World!" alert box to send BBB. If the CW/RTTY message content is:

```
AAA #@SCRIPT BBB
```

The keyer sends AAA and starts the script (and the alert box is open), **but** it continues to key the rest of the message ("BBB") without waiting the user intervention. This is the asynchronous mode.

## Tips for Programming

1. Use the Scripts Manager to manage scripts, using a simple editor like Notepad. The scripts are stored in the {AppData}/All Users/Win-Test/scripts/ directory.
2. Before you can press the Edit button, make sure you have configured an ASCII editor in the Options Menu
3. If you wish to replace the built-in ESM script in Win-Test, save your script as "esm.wts". The value returned by your script will tell Win-Test what to do after it is executed:
  - ◆ If the return value is 0 (or if there is no return value), WT will run its own embedded script after yours.
  - ◆ If the return value is 1, WT will continue the Enter key process, without calling its embedded script.
  - ◆ And if the return value is -1, WT will stop the Enter key process, without calling its embedded script.
4. WT maintains two different QSO status: One for each radio. They are automatically cleared when the QSO is entered, if the operating mode (RUN/S&P) is switched or if the **wtQso:ClearStatus()** is executed.
5. Lua global variables are persistent between scripts calls. If you don't want this behavior, use local variables instead (keyword local).

## Basic Examples

### Example 1

```
-- esm.wts
wtApp:AlertBox("Enter key ! ESM rulez...");
return 0; -- This line can be omitted
-- end
```

No return value (or 0) => WT will execute this script (the alert box will be displayed), and the embedded script will be called after it.

### Example 2

```
-- esm.wts
wtApp:AlertBox("Enter key ! The key is processed by WT");
return 1;
-- end
```

The return value is 1 => After executing the script (the alert box will be displayed), WT will continue its own process and act exactly as if someone hit Enter. Read: It silently enters the QSO if it is OK. The embedded ESM script is ignored.

### Example 3

```
-- esm.wts
wtApp:AlertBox("Enter key ! The key processing is stopped");
return -1;
-- end
```

The return value is -1 => After executing the script (the alert box will be displayed), the embedded ESM script is ignored and WT will also ignore the Enter key process (no QSO is entered).

For a collection of more advanced programming examples please see [user contributed scripts](#) and [advanced programming examples](#).

## Load a target file

This option allows you to load a so-called target file - an ASCII file (maybe self-generated) that has QSO and multiplier targets for each hour of the contest. This is a nice way to integrate a plan into your contest environment to keep yourself motivated. In the old days we used to have a piece of paper on the wall - today Win-Test automatically tracks this information for your convenience.

Before you can load a target file you will have to create one or receive one from somebody else. Please see [Export a target file](#) on how to do that.

The content of the target file becomes visible in the statistics window (see [Statistics](#)) when you compare current standings with the values in the target file.

Loading a target file is usually a Pre-contest configuration task. Please refer to the usual [Pre-contest configuration](#) activities chapter in this manual.

A target file can also be loaded at any time during the contest. If you see your target score was too easy, you can load a new target to keep your motivation high. You set a target to break your national record, and now things go better and you see the possibility to break the continental record. How can you track this new situation? Preparing more than one file with different targets is a good practice: if conditions change then simply load the new target file and WT will show you how you are doing against that new target!

## Export a target file

This option allows you to create a target file from the log file currently loaded. It is useful to use last year's log as a start to create a target for this year's contest.

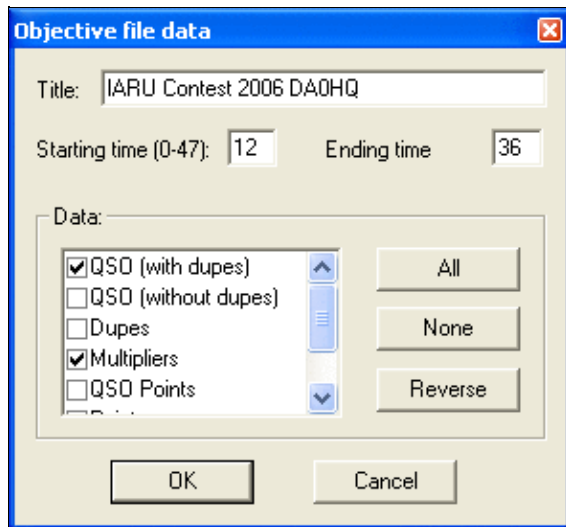

### Exporting a target (.obf) file

You should give a title to the target file to make clear what you're comparing to. Maybe you will want to change the target file to a more optimistic one when you'll realize band conditions are so great this time!

You may want to select which time frame to export (Starting time, ending time). Hours on Sunday have to be given in time + 24 hours so that 12:00 UTC on Sunday becomes 36.

Next you have to choose which columns to export to the target file. Normally you will want QSO count (with or without dupes), multipliers and points.

After pressing **OK** a file with the extension **.obf** will be created which will look similar to the file below:

```
#
# Target file generated by Win-Test
#
# VERSION 100
#
TITLE IARU Contest 2006 DA0HQ
START = 12
END = 36
12 QSO = 0 MULT = 0 POINTS = 0
13 QSO = 1 MULT = 1 POINTS = 1
14 QSO = 1 MULT = 1 POINTS = 1
15 QSO = 1 MULT = 1 POINTS = 1
16 QSO = 1 MULT = 1 POINTS = 1
17 QSO = 2 MULT = 2 POINTS = 4
18 QSO = 3 MULT = 2 POINTS = 4
19 QSO = 4 MULT = 2 POINTS = 6
20 QSO = 4 MULT = 2 POINTS = 6
21 QSO = 4 MULT = 2 POINTS = 6
22 QSO = 8 MULT = 3 POINTS = 18
23 QSO = 8 MULT = 3 POINTS = 18
24 QSO = 8 MULT = 3 POINTS = 18
25 QSO = 8 MULT = 3 POINTS = 18
26 QSO = 8 MULT = 3 POINTS = 18
27 QSO = 8 MULT = 3 POINTS = 18
28 QSO = 8 MULT = 3 POINTS = 18
29 QSO = 8 MULT = 3 POINTS = 18
30 QSO = 8 MULT = 3 POINTS = 18
31 QSO = 8 MULT = 3 POINTS = 18
```



32 QSO = 18 MULT = 3 POINTS = 21  
33 QSO = 30 MULT = 5 POINTS = 45  
34 QSO = 42 MULT = 5 POINTS = 50  
35 QSO = 81 MULT = 7 POINTS = 224

As you can see the structure of the file is so easy to understand that you might want to use an ASCII editor to go and make some changes - or create it completely from scratch yourself using this template!

## Check log

This tool allows you to verify if special restrictions of the contest rules have been adhered to in this log. You have different options, depending on the category you choose (see pictures below):

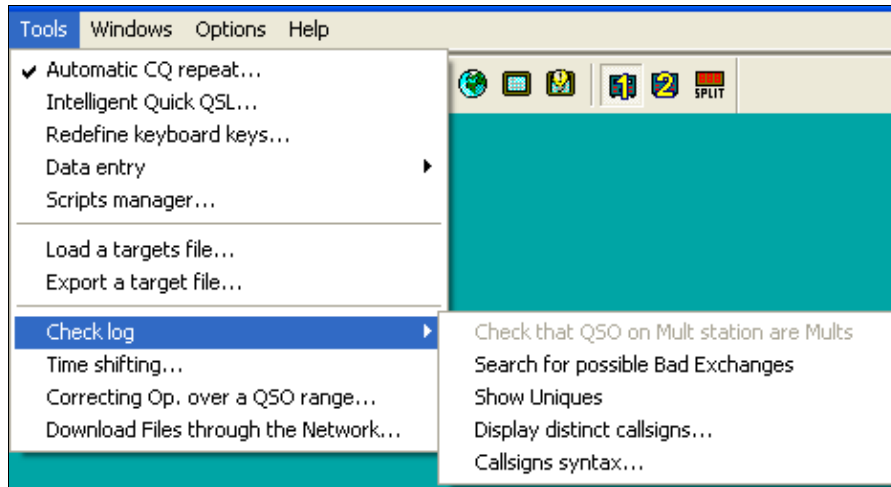

Check Log feature for the single operator category

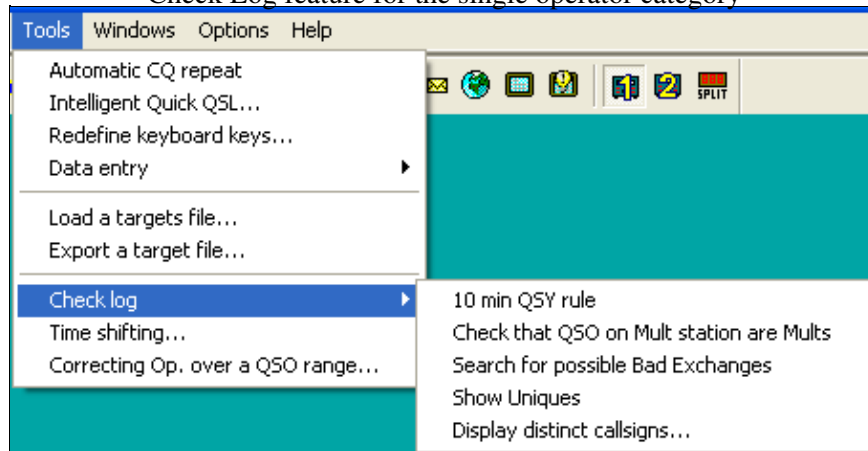

## Check Log feature for M/S category

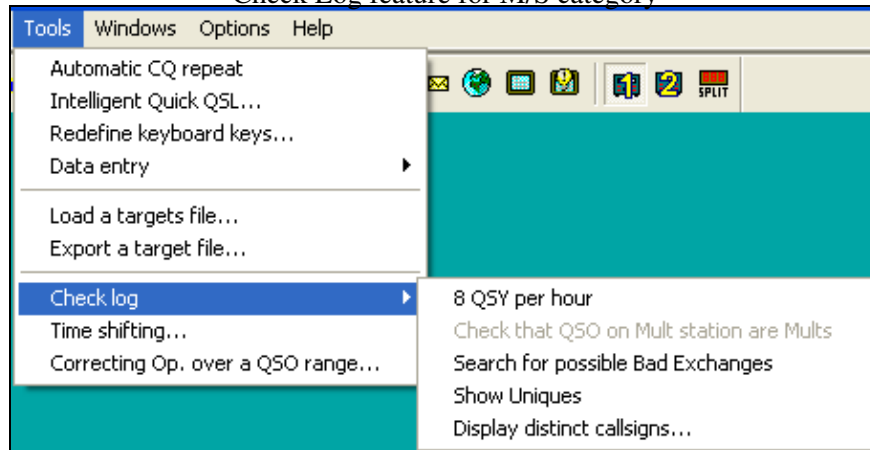

Check Log feature for the M2 category - note the differences in options offered. If you select a contest and/or category which does not have a QSY limit, this option will not show up.

Depending on the selected contest category, you may check for:

- **8 QSY per Hour:** Check the QSY count per hour (ARRL DX in M/2 category for example).
- **10 min QSY rule:** Check if the minimum time on a band has been respected (Multiplier station in a M/S effort during a CQWW DX for example).
- **Check that QSO on Mult station are Mults:** Check if all QSOs made on the multiplier station are actually multipliers. You may want to quote the exceptions (if any) when sending your log to the contest sponsor to avoid massive score reductions.
- **Search for possible Bad Exchanges:** Search the logged exchanges which are potentially bad, according to the database or to the other QSOs made with the same station during the contest. Works for CQWW, ARRL DX or any contest in which there is something which apparently is a zone. It also works for the VHF contest when a Gridsquare is logged.
- **Show Uniques:** Search N+1 for each unique logged callsign in the log. A unique callsign is a callsign that appears in the log only once (contact only on one band and mode, and no dupe). N+1 can be searched against the log, the callsign database (Master database) or both. It is possible to switch off N+1 searching for unique callsigns which are known to the callsign database.
- **Display distinct callsigns...:** Display all distinct callsigns of a log, and band(s)/mode(s) worked by each station. You can sort this report by callsign, by number of Q and by country.
- **Callsigns syntax...:** Match the callsigns to the callsign pattern file (see [Other Files](#)).
- **Open the notes linked to the current log:** Allows you to comfortably walk through your notes taken during the contest. Clicking on a line brings you to that specific QSO. Edit a note by selecting it and use **Alt-N** to modify the comment.
- **Open a different notes file:** Switch notes file, if more than one exists.
- **Download the LCR file:** Download your Log Check Report from the contest web site.

## Win-Test Wiki

- **Open a Different LCR file:** Switch to a different Log Check Report.

These are some of the typical reports you get:

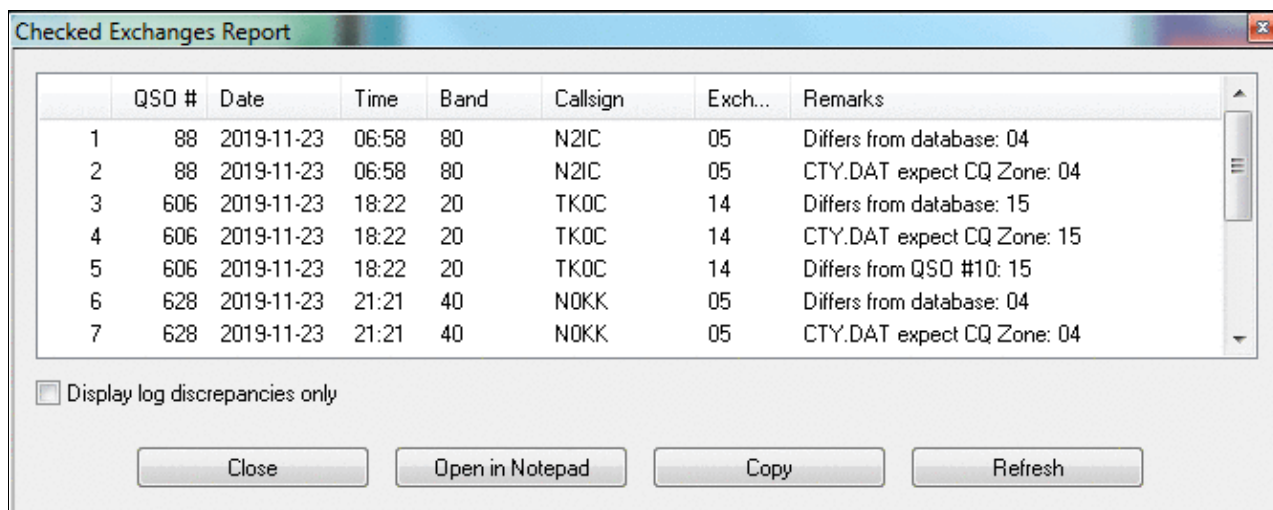

The screenshot shows a window titled "Checked Exchanges Report". It contains a table with 8 columns: QSO #, Date, Time, Band, Callsign, Exch..., and Remarks. There are 7 rows of data. Below the table is a checkbox labeled "Display log discrepancies only" which is unchecked. At the bottom are four buttons: "Close", "Open in Notepad", "Copy", and "Refresh".

QSO #	Date	Time	Band	Callsign	Exch...	Remarks	
1	88	2019-11-23	06:58	80	N2IC	05	Differs from database: 04
2	88	2019-11-23	06:58	80	N2IC	05	CTY.DAT expect CQ Zone: 04
3	606	2019-11-23	18:22	20	TK0C	14	Differs from database: 15
4	606	2019-11-23	18:22	20	TK0C	14	CTY.DAT expect CQ Zone: 15
5	606	2019-11-23	18:22	20	TK0C	14	Differs from QSO #10: 15
6	628	2019-11-23	21:21	40	N0KK	05	Differs from database: 04
7	628	2019-11-23	21:21	40	N0KK	05	CTY.DAT expect CQ Zone: 04

### Checked Exchanges Report

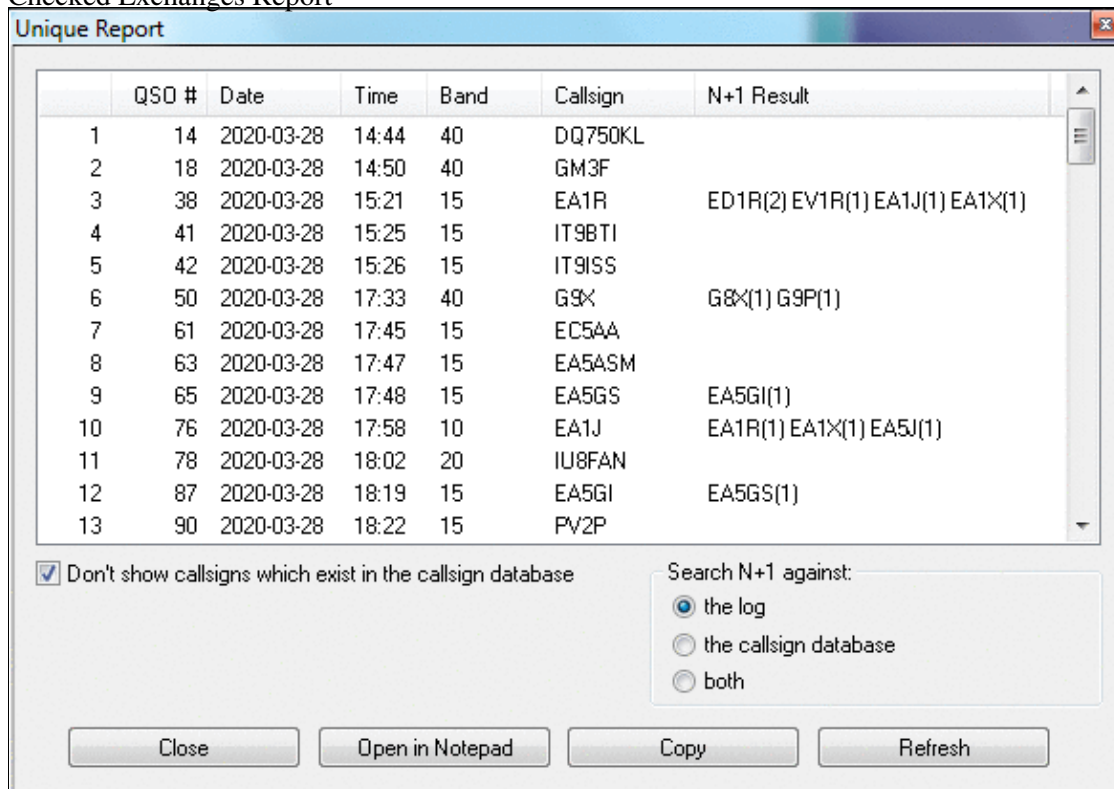

The screenshot shows a window titled "Unique Report". It contains a table with 7 columns: QSO #, Date, Time, Band, Callsign, and N+1 Result. There are 13 rows of data. Below the table is a checkbox labeled "Don't show callsigns which exist in the callsign database" which is checked. To the right of this checkbox is a section titled "Search N+1 against:" with three radio button options: "the log" (selected), "the callsign database", and "both". At the bottom are four buttons: "Close", "Open in Notepad", "Copy", and "Refresh".

QSO #	Date	Time	Band	Callsign	N+1 Result
1	14	2020-03-28	14:44	40	DQ750KL
2	18	2020-03-28	14:50	40	GM3F
3	38	2020-03-28	15:21	15	EA1R ED1R(2) EV1R(1) EA1J(1) EA1X(1)
4	41	2020-03-28	15:25	15	IT9BTI
5	42	2020-03-28	15:26	15	IT9ISS
6	50	2020-03-28	17:33	40	G9X G8X(1) G9P(1)
7	61	2020-03-28	17:45	15	EC5AA
8	63	2020-03-28	17:47	15	EA5ASM
9	65	2020-03-28	17:48	15	EA5GI(1)
10	76	2020-03-28	17:58	10	EA1J EA1R(1) EA1X(1) EA5J(1)
11	78	2020-03-28	18:02	20	IU8FAN
12	87	2020-03-28	18:19	15	EA5GI EA5GS(1)
13	90	2020-03-28	18:22	15	PV2P

## Unique Report

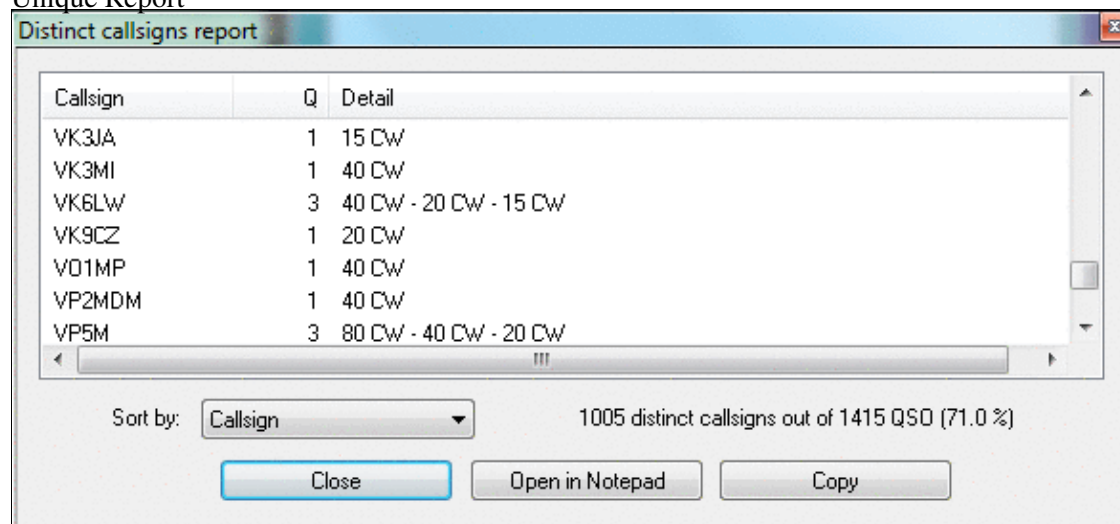

Distinct Callsigns Report - see who you worked on which bands/modes

You have the options of opening the report in a Notepad window for further processing. The Copy button allows you to Copy & Paste the data into a spreadsheet for comfortable filtering and processing. Additionally, you may press the Update button to create an updated report after you have done some changes to the log.

## Time shifting

This option allows you to **time shift** selected QSOs by any amount of time - either positive or negative. It lets you correct a constant time offset (like you had set the wrong date on the computer, or the clock was off by one hour). You may consider to use this option after the contest to avoid heavy manual editing of many QSO's time through the use of **Alt-F**.

The time shift can be applied to the entire log or to a range of QSOs, to the QSOs entered by your own station (this could make sense in a multi operator environment), to QSOs entered by several stations. Note that in a multi operator environment, one station should always be (or should have been) defined as the time master to establish a common time base in the network.

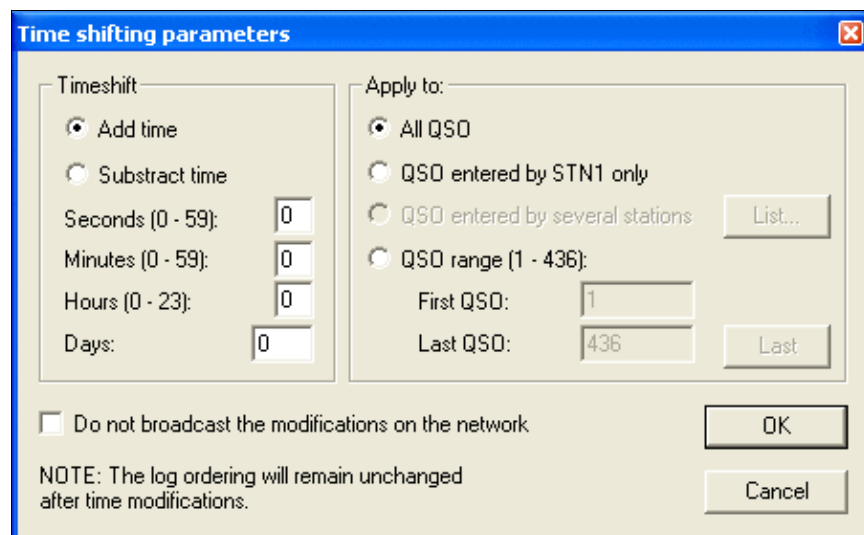

### Time Shifting Parameters

Even though this tool is supposed to be used after a contest to correct a wrong clock setting, each time change will be broadcasted to all other stations of the network by default. You can disable this broadcasting — if not needed.

Note that time shifting is pretty CPU consuming. It may take quite some time for large logs, because each QSO modification requires several internal structures (mainly statistics) to be updated accordingly. Time shifting **can not be cancelled** while it is in progress, to avoid any log inconsistency.

**Note:** Wise users will create a backup of their log before using this option.

## Correcting OP over a QSO range

This function lets you change (or add) the operator to a range of QSO. The QSOs are selectable by QSO number, by band, by mode or by callsign.

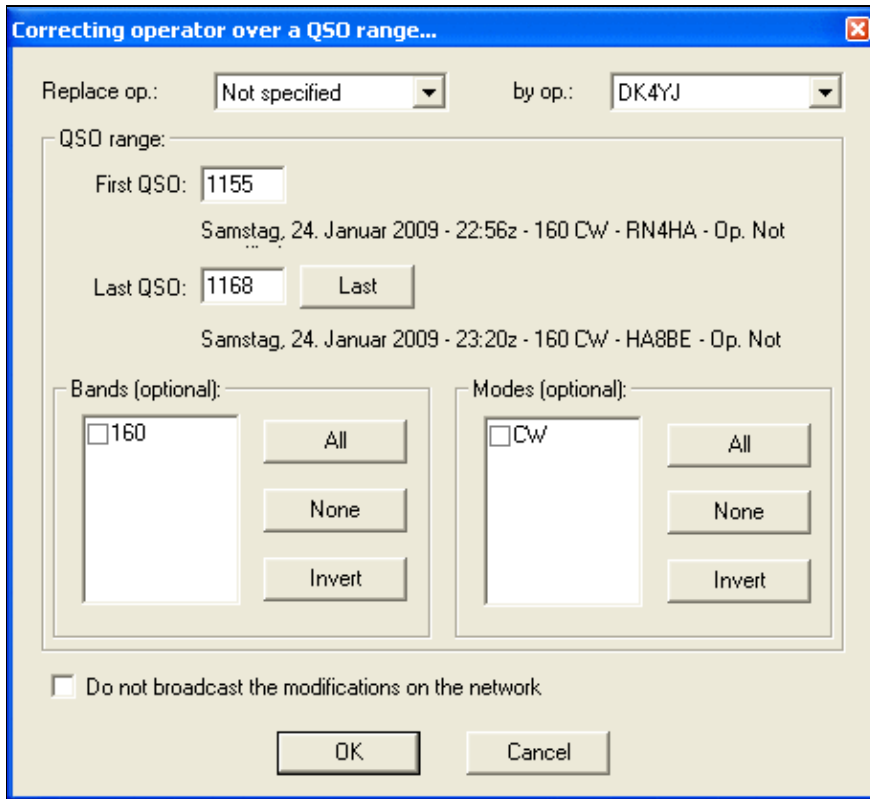

Tool to correct operator for a range of QSOs

## Download Files through the Network

To collect logs from different networked computers after a contest is over is the task of this function. Instead of having to visit each single computer, plug in the USB drive, copy the files over and move on to the next, this feature let's you collect the binary and notes files from all computers at once.

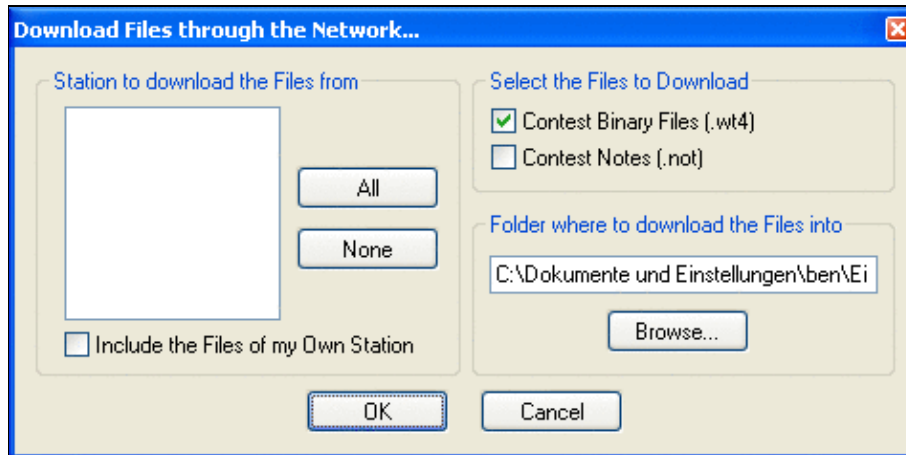

Collect files after the contest without leaving your chair

[Back to Menu](#)

## Namespaces

- [Page](#)
- [Discussion](#)

## Variants

## Views

- [Read](#)
- [View source](#)
- [View history](#)

## More

- This page was last edited on 9 April 2023, at 15:19.

- [Privacy policy](#)
- [About Win-Test Wiki](#)
- [Disclaimers](#)



# Mailing

From Win-Test Wiki

[Jump to navigation](#) [Jump to search](#)

Mailing the generated Cabrillo or Reg1Test file to the contest sponsor is easy, but a few details should be noted:

- The name of the log should be identical to your callsign, like DQ4W.LOG. If your call contains a slash, use "\_" for a replacement, like VR2\_AA1ON.LOG.
- The Subject line of your mail message should usually contain your callsign and the category, for example "DQ4W M/2", but this is not always true. Please check the Log submission specific rule, in the official rules of each contest (see ARRL, for instance: *E-mail log submissions should include ONLY the participant's call sign in the SUBJECT: line.*).
- Make sure you are sending to the correct address. Often, a robot will receive and confirm the log file you send. The correct address should be taken from the current contest rules. A good collection of contest rules with links to the original sites is available from [SM3CER](#).
- The log should be sent as an attachment to your message - and not included as text.
- Do not ZIP the file, send it along as it is.
- If your file is rejected by the robot, please carefully read the reply message. It often contains hints on what's missing. Try to add the requested information and then send the file again.
- If your file was received OK, a confirmation message should show up in your mailbox after a few minutes (sometimes this takes a few days, depending on how the contest sponsor processes the logs). Also, if the contest sponsor lists received logs on the Web, be sure to check if your log is listed there, in the correct category. If nothing is received and nothing shows up on the Web page, it is **your** responsibility to re-submit the log or contact the contest sponsor.

## Namespaces

- [Page](#)
- [Discussion](#)

## Variants

## Views

- [Read](#)
- [View source](#)
- [View history](#)

## More

- This page was last edited on 3 April 2007, at 09:44.

- [Privacy policy](#)
- [About Win-Test Wiki](#)
- [Disclaimers](#)



# Mailing

From Win-Test Wiki

[Jump to navigation](#) [Jump to search](#)

Mailing the generated Cabrillo or Reg1Test file to the contest sponsor is easy, but a few details should be noted:

- The name of the log should be identical to your callsign, like DQ4W.LOG. If your call contains a slash, use "\_" for a replacement, like VR2\_AA1ON.LOG.
- The Subject line of your mail message should usually contain your callsign and the category, for example "DQ4W M/2", but this is not always true. Please check the Log submission specific rule, in the official rules of each contest (see ARRL, for instance: *E-mail log submissions should include ONLY the participant's call sign in the SUBJECT: line.*).
- Make sure you are sending to the correct address. Often, a robot will receive and confirm the log file you send. The correct address should be taken from the current contest rules. A good collection of contest rules with links to the original sites is available from [SM3CER](#).
- The log should be sent as an attachment to your message - and not included as text.
- Do not ZIP the file, send it along as it is.
- If your file is rejected by the robot, please carefully read the reply message. It often contains hints on what's missing. Try to add the requested information and then send the file again.
- If your file was received OK, a confirmation message should show up in your mailbox after a few minutes (sometimes this takes a few days, depending on how the contest sponsor processes the logs). Also, if the contest sponsor lists received logs on the Web, be sure to check if your log is listed there, in the correct category. If nothing is received and nothing shows up on the Web page, it is **your** responsibility to re-submit the log or contact the contest sponsor.

## Namespaces

- [Page](#)
- [Discussion](#)

## Variants

## Views

- [Read](#)
- [View source](#)
- [View history](#)

## More

- This page was last edited on 3 April 2007, at 09:44.

- [Privacy policy](#)
- [About Win-Test Wiki](#)
- [Disclaimers](#)





# Mailing List

From Win-Test Wiki

[Jump to navigation](#) [Jump to search](#)

## Contents

- [1 Knowledge needs to be shared](#)
- [2 Subscribing to the mailing list](#)
- [3 Unsubscribing to the mailing list](#)
- [4 Searching and browsing the archive](#)

## Knowledge needs to be shared

A Win-Test mailing list does exist for mutual assistance between Win-Test users. It is a public list.

## Subscribing to the mailing list

You can easily subscribe to this list by sending a mail to [support-request@win-test.com](mailto:support-request@win-test.com) while indicating "subscribe" (without the quotation marks) in the subject.

You must be a subscriber to this list before sending a post. If not, your message will be rejected. Nevertheless, you can freely browse the archives (see below) without subscribing.

To post to the mailing list you must use [support@win-test.com](mailto:support@win-test.com)

## Unsubscribing to the mailing list

You can easily unsubscribe from this list by sending a mail to [support-request@win-test.com](mailto:support-request@win-test.com) while indicating "unsubscribe" (without the quotation marks) in the subject.

## Searching and browsing the archive

Before sending a post, we advise you to have a look in the [public archives of the list](#) in order to see whether your problem has already been mentioned, and possibly solved, by other users.

You can also [search this archive](#), as it is indexed by Google. For example, to search for **QTCs** you'd use the following keywords in Google's search box:

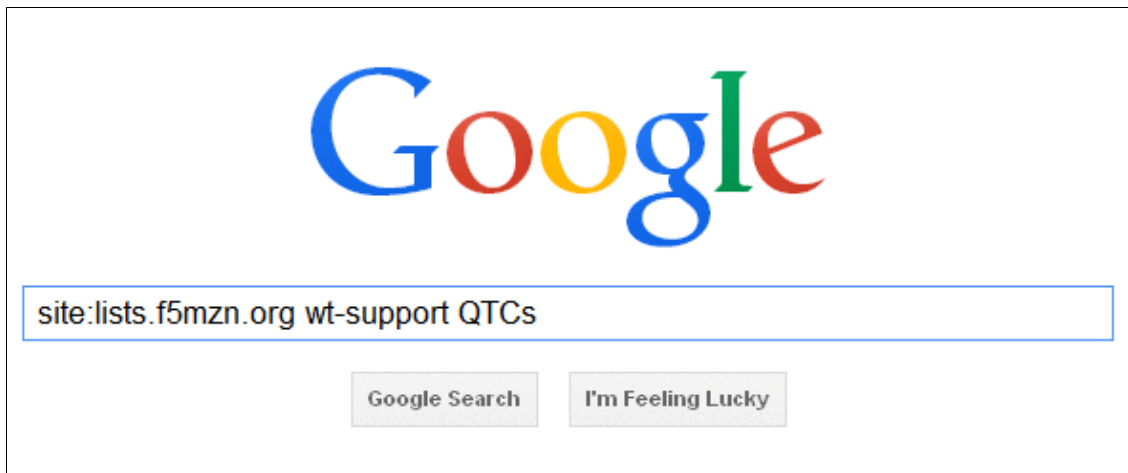

How to search the Win-Test Mailing List Archive

## Namespaces

- [Page](#)
- [Discussion](#)

## Variants

## Views

- [Read](#)
- [View source](#)
- [View history](#)

## More

- This page was last edited on 5 March 2023, at 17:28.

- [Privacy policy](#)
- [About Win-Test Wiki](#)
- [Disclaimers](#)



# Main Page

From Win-Test Wiki

[Jump to navigation](#) [Jump to search](#)

## Win-Test Documentation

- This documentation is current to version 4.47
- This documentation can be [downloaded in PDF format](#).

### I. **Preface**

1. [Authors and contributors](#)

### II. **Installation**

1. [Download the software](#)
2. [Install the software](#)
3. [Registering the software](#)

### III. **Configuration**

1. [One-time configuration](#)
  - ◇ [Interface configuration](#)
  - ◇ [DX Cluster configuration](#)
  - ◇ [Rotator configuration](#)
  - ◇ [RTTY configuration](#)
  - ◇ [Setting up networking](#)
  - ◇ [Category:BestPractice](#)
2. [Pre-contest configuration](#)

### IV. **Running a contest**

1. [Logging OSOs](#)
2. [SO1R](#)
3. [SO2R](#)
4. [Multi-op](#)
5. [Contest-specific behaviour](#)
6. [Posting live score on-line](#)
7. [Post-contest specifics](#)

### V. **Menus**

1. [File \(without a Win-Test file opened\)](#)
2. [File \(with a Win-Test file opened\)](#)
3. [Edit](#)
4. [Operating](#)
5. [Commands](#)
6. [Messages](#)
7. [Tools](#)
8. [Windows](#)
9. [Options](#)
10. [Help](#)

### VI. **More...**

1. [Icon bar](#)
2. [Text commands](#)
3. [Keys](#)
4. [Message variables \(aka macros\)](#)
5. [Supported contests](#)
6. [Supported rigs](#)

7. [Supported accessories](#)
8. [Check Partial and N+1 Files](#)
9. [Database files](#)
10. [Other files...](#)
11. [Release notes](#)
12. [Release notes \(old version 3 archive\)](#)

#### VII. Frequently Asked Questions (FAQ)

1. [Problems registering and running](#)
2. [DX Cluster and wtDxTelnet](#)
3. [Rotator control and wtRotators](#)
4. [User interface](#)
5. [Networking](#)
6. [Licensing issues](#)

#### VIII. See also

- ◆ [Win-Test installation, registration and configuration guide](#)
- ◆ [Win-Test quick start manual](#) — for Win-Test 3.11.0 (slightly outdated)
- ◆ [Win-Test mailing list](#)

## Namespaces

- [Main page](#)
- [Discussion](#)

## Variants

## Views

- [Read](#)
- [View source](#)
- [View history](#)

## More

- This page was last edited on 5 April 2020, at 16:54.

- [Privacy policy](#)
- [About Win-Test Wiki](#)
- [Disclaimers](#)



# Menu:Commands

From Win-Test Wiki

[Jump to navigation](#) [Jump to search](#)

## Menu:Commands

### Contents

- [1 QSY](#)
  - ◆ [1.1 One band down](#)
  - ◆ [1.2 One band up](#)
- [2 Keyboard mode](#)
- [3 CW Speed...](#)
- [4 CW Weight...](#)
- [5 Carrier](#)
- [6 Split frequency](#)
- [7 QSY frequency](#)
- [8 QSY back to run frequency](#)
- [9 Swap the frequency on both radios](#)
- [10 Take a sked](#)
- [11 Pass a station](#)
- [12 Operator Login...](#)
- [13 Copy-paste the previous QSO](#)
- [14 Receive QTC](#)
- [15 Transmit QTC](#)
- [16 Turn Antenna to Logged Call \(Short Path\)](#)
- [17 Turn Antenna to Logged Call \(Long Path\)](#)
- [18 DX-Cluster](#)
- [19 Spot...](#)
- [20 Propagation forecast](#)
- [21 Insert into BandMap](#)
- [22 Active Radio](#)
- [23 Station Type](#)
- [24 CW/RTTY Messages](#)
- [25 Remote commands...](#)

## QSY

### One band down

Modify the band of the current QSO (logging field), to the nearest lower band (vs frequency). While on 160m, the nearest "lower band" will be 10m. Shortcut: **Alt-F1**. You can also directly type the desired band (if the logging field is empty, of course), and even a frequency in kHz (such as 14265).

## One band up

Modify the band of the current QSO (logging field), to the nearest upper band (vs frequency). While on 10m, the nearest "upper band" will be 160m. Shortcut: **Alt-F2**. You can also directly type the desired band (if the callsign field is empty, of course), and even a frequency in kHz (such as 14265).

## Keyboard mode

Allows you to use the keyboard to generate CW or RTTY text. This is needed in unusual situations, for example to say a few words to your old contesting friend before you send him a report or to manage a DX station to QSY to another band. This feature has no meaning on SSB.

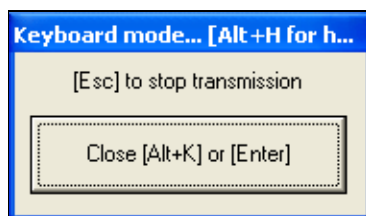

### Keyboard Mode

You have to type blind - you will only hear (or see in the RTTY monitor) what you have typed when it's being transmitted.

Note that in keyboard mode you have the usual function keys available, so instead of typing your callsign, you may simply press **F4**. If you have remapped other keys such as the backslash [**\**] to send your callsign, those keys will *not* work in keyboard mode *unless* you enable the CW Option Remap keys in keyboard mode.

Keyboard mode can also be started with the shortcut **Alt-K**. To exit keyboard mode, click on the Stop button, or press **Return** or press again **Alt-K**. Note that on CW **Escape** will also exit the Keyboard mode, but it also aborts the transmission if remaining data are still in the buffer. On RTTY, **Escape** empties the TX buffer, but leaves the PTT ON, so you can continue typing until you close the window (which resets the PTT).

By the way, you can exit the Keyboard mode with **Alt-K** when you are done typing - you do not need to wait until the transmission finishes.

## CW Speed...

Shortcut: **Alt-V**. Opens the CW speed dialog box:



Entering the CW speed

In this dialog you also can use :

- **Up arrow**: Increases the speed by 1 WPM

- **Page up**: Increases the speed by 2 WPM
- **Down arrow**: Decreases the speed by 1 WPM
- **Page down**: Decreases the speed by 2 WPM

The CW-Speed can also be changed via **Alt-F9** (decreases by 2 WPM) and **Alt-F10** (increases by 2 WPM) while operating.

Finally, you can also directly enter a speed (in WPM) in the callsign field and hit **Alt-V**.

**Note:** The settings used for WinKey are minimum 20/maximum 60 wpm. Setting any other speed min/max values with the WinKey software usually causes unpredictable, unwanted CW speed jumps when using Win-Test.

## CW Weight...

Open the CW weight dialog box:



CW weight dialog box

This is the weight (ratio) of dashes to dots - the default value (3.0) should be fine for most people.

## Carrier

Sends a carrier to the CW output. You can choose a plain carrier or pulses (in order to take care of the PA while tuning ...). Shortcut **Ctrl-T**, or enter **TUNE** in the main window. For safety reasons, a 30-second timeout automatically stops the transmission no matter what, in the meantime remaining seconds are displayed.

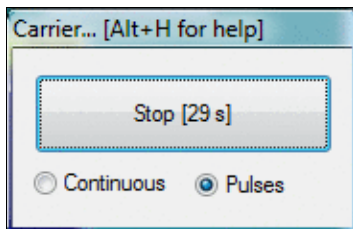

Tuning carrier

To exit this mode, click on the Stop button, press **Return** or **Escape**.

## Split frequency

Allows to directly adjust the split frequency of the current radio.



### Split frequency adjustments

A direct access to this dialog box is also possible by typing [**Minus**] from the numeric keypad, as well as the text command **SPLITFREQ** in the QSO logging field.

Enter "+1" or "-5" to set the receive frequency 1 kHz up respectively 5 kHz down.

Note that you can enter only the kHz part of the current band, and that entering an empty field or "0" cancels the split mode if it was engaged (as well as the **NOSPLIT** text command).

## QSY frequency

Allows you to adjust directly the QSY frequency on the current band.

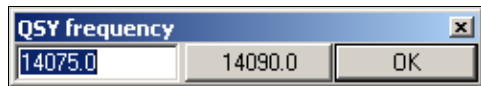

### QSY Frequency

In the dialog box, you can also use and save the current frequency as a the QSY frequency, by clicking the central button.

You can also have a direct access to this dialog box by using **QSYFREQ** or **PASSFREQ** text commands.

This frequency will then appear in the status window.

## QSY back to run frequency

This command will bring you back to the last frequency and mode on which you hit [**F1**] (=CQ, your last run frequency). It is accessible with the shortcut **Alt-F4**. The original CW speed will be restored which you had when you left the CQ frequency. Also RUN status will be restored, which is handy when you actively use the Run Mode/S&P mode.

## Swap the frequency on both radios

Shortcut: **Ctrl-S**

After typing **SWAP** or pressing **Ctrl-S**, the frequency of the primary radio is swapped with the secondary radio frequency, and this radio now becomes the primary radio. Imagine Radio2 is primary radio on 21025 and Radio1 is on 7001 After typing **SWAP** the primary radio is Radio1 on 21025. Secondary radio is now Radio2 on 7001.

This is slightly different to pressing the [**\***] key, where only primary and secondary radios are swapped.

One of the possibilities that is offered by this command, is to be able to work with a single automatic amplifier (for example ACOM 2000A) with two radios. With Win-Test and EZMaster this is possible.

The scenario is as follows:

- ◆ Radio1 running, calling CQ (high power)
- ◆ Radio2 looking for multipliers (low power)



If Radio2 locates a multiplier you try to work him, but if the pile-up is too bad this is the moment to type **SWAP** and Win-Test and EZMaster will do all the changes of frequencies and antennas. The amplifier automatically tunes to the antenna of Radio2, you work the multiplier (now with high power), while Radio1 continues calling CQ with low power maintaining the frequency (nobody will take it away). Once you have worked the multiplier on Radio2, type **SWAP** again and Radio1 will continue to CQ with high power and you continue looking for multipliers on Radio2.

Another application is looking for a clear frequency with the secondary radio on a new band, while keeping the CQ going on the primary radio. Once you find a clear spot, type **SWAP** and start CQ-ing on the new band without delay.

## Take a sked

Shortcut **Alt-E**. To take a sked with a station, the following dialog box appears :

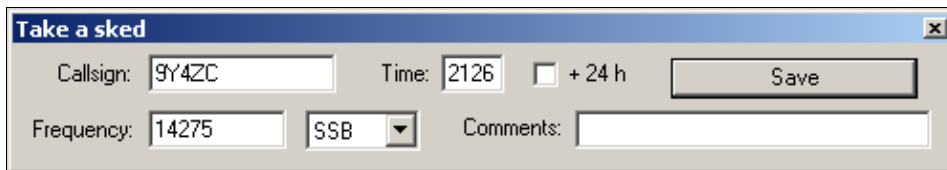

### Taking a sked

You must write down the callsign of the station you want to take a sked with (the current callsign in the logging field will be taken by default), the time of the sked (possibly specifying if this time must shifted + 24h, see comment below), the frequency, the mode (only in a multi mode contest), and an optional comment. Once recorded, the sked will appear in the skeds window.

Remark about the time of the sked : checking the "+ 24 h" box does not always mean that the sked will be taken for "tomorrow", but that the time must be shifted by + 24 hours.

Example 1 : It is Saturday 1000z. You take a sked for Sunday 0600z : do not check the "+ 24 h" box.

Example 2 : It is Saturday 0400z. You take a sked for Sunday 0600z : you must check the "+ 24 h" box, otherwise the sked will be taken for saturday 0600z !

## Pass a station

Shortcut **Alt-D**. To pass a callsign to another operating position (multi operators), the following window appears :

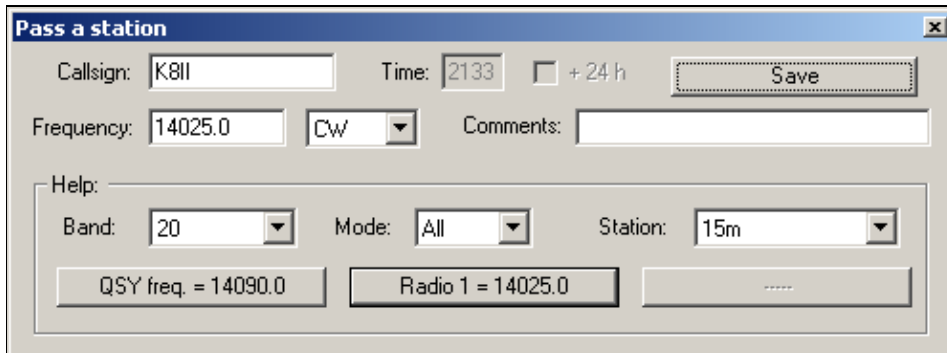

## Pass a station

You must write down the callsign of the station you want to pass (default: the callsign in the logging field), the frequency, the mode (only during a multi mode contest), and an optional comment. Once OK is pressed, the information will appear in the skeds window.

To make it easier passing a callsign in a multi operating environment, the lower part of window lets you know, by means of filters (combo box), what station is on the band where you wish the calling station to be, and the frequencies of the radios being on that band.

## Operator Login...

This feature was added to provide a basic operator management. The feature is only available to multi operator logs.

It was mainly added to help DXPeditioners to identify operators for the web log search scripts, and for various DX or testers challenges (RRDXA etc.). The new text commands **OPON** or **LOGIN** allow the operator to identify himself. The operator change is propagated across the network, meaning that if you login on a station, you will be automatically logged out of the previous one you were logged on (if any).

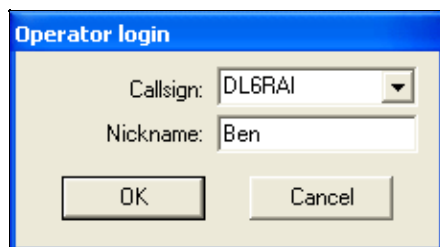

Log in a new Operator using the LOGIN command

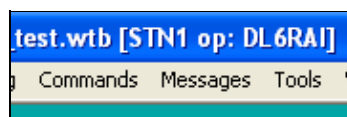

The current operator's callsign is displayed inside the title bar of Win-Test

When a list of operators was entered in the contest settings dialog when creating the log, it will be parsed to init the combo-box. You can also add ops "on the fly" to this combo box.

If you add nicknames to operators of this list (JOE, JACK, WILLIAM, AVERELL, JOSETTE or whatever - letters and numbers are accepted, allowing exotic nicknames like L33T etc.), you can enter them as text commands to quickly change operator, without using the **OPON** command. However, you cannot enter the operator's callsign; this will log a QSO with the operator.

To log off, simply change the operator or use the **OPOFF** or **LOGOOUT** text command.

Operators' callsigns are limited to 7 chars, while nicknames are limited to 13 characters in length. The ADIF file export includes the operator's callsign in the QSO record, if an operator was defined for that QSO. The text and CSV export files also allow the inclusion the operator's callsign.

When an operator logs on, Win-Test now automatically tries to run an executable (.exe, .bat or .com) named op\_"callsign" which must be located in the Win-Test installation directory. For example, if DL6RAI logs in, WT will try to run op\_dl6rai.exe (or .bat or .com), if this file exists. If the callsign includes a "/" character, it will be replaced by an underscore ("\_"). This feature may be useful to automate various actions.

## Copy-paste the previous QSO

Shortcut **Alt-[UP]**. This copies the calling from previous QSO to the QSO edit field. Useful for passed stations or after QSY.

## Receive QTC

Shortcut **Alt-L**.

Only for WAEDC contest and for European stations. Opens the QTC RX dialog box

Station: **VE3KR**

Gr/Num	Time	Callsign	Serial
1			
2			
3			
4			
5			
6			
7			
8			
9			
10			

Space: change field (Time, Callsign, Serial)  
 Tab: same as space + Gr/Num  
 Ctrl+Arrows: change line or column  
 Alt+K: enter keyboard mode (CW)  
 Alt+F9 & Alt+F10: change speed (CW)  
 Alt+L: exit without saving

F1 ... QTC?  
 F2 ... QRV  
 F5 ... TIME?  
 F6 ... CL?  
 F7 ... NR?  
 F8 ... AGN  
 F9 ... QSL + gr/nr  
 F10 ... QSL ALL  
 CR ... R & Next  
 + ... TU & Valid  
 Validate

QTC RX dialog  
 See [WAEDC](#) for more information.

## Transmit QTC

Shortcut **Ctrl-L**.

Only for WAEDC contest and for DX stations. Opens the QTC TX dialog box where you can select how many QTCs you want to send:

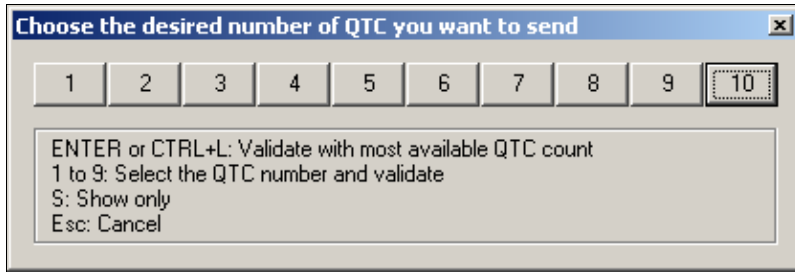

Selecting the number of QTCs to transmit  
 After pressing **ENTER** or selecting **10** You will get something like this:

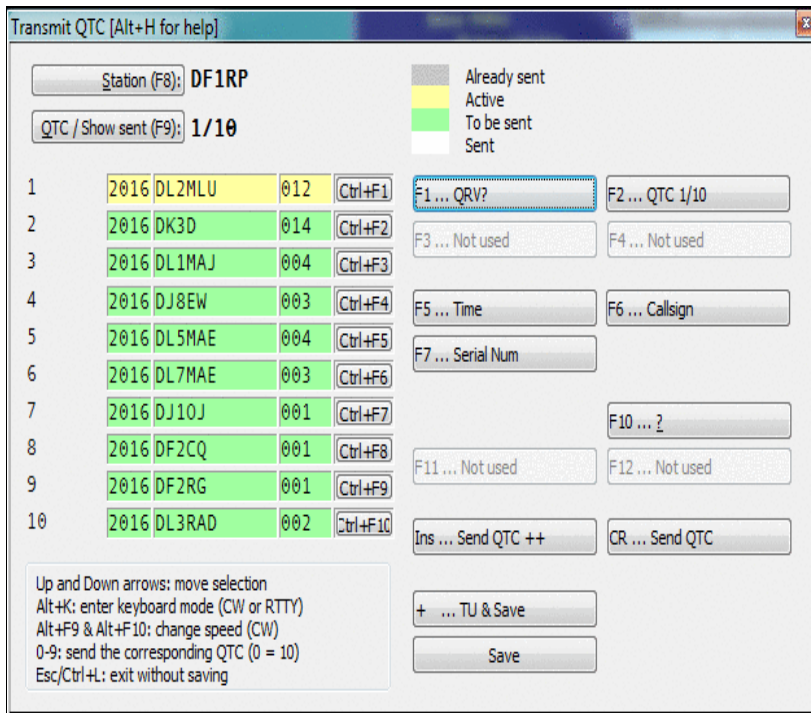

Transmitting QTCs  
 See [WAEDC](#) for more information.

## Turn Antenna to Logged Call (Short Path)

Shortcut **Ctrl-F12**. Turns the antenna to the logged call (short path) in case wtRotators.exe is active and properly configured.

## Turn Antenna to Logged Call (Long Path)

Shortcut **Alt-F12**. Turns the antenna to the logged call (long path) in case wtRotators.exe is active and properly configured.

## DX-Cluster

Shortcut **Alt-T**. This window allows you to send commands to the DX cluster you are connected to. These commands are then forwarded either to a TNC physically connected on a COM port, a DX Cluster connection established via the wtDxTelnet application or a remote TNC in a multi computer network.

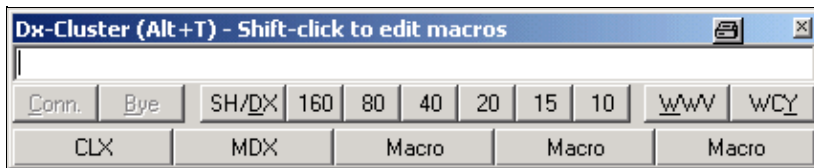

Sending commands to the DX cluster

The buttons below the entry line of that window are pre-defined commands that can be activated by clicking with your mouse.

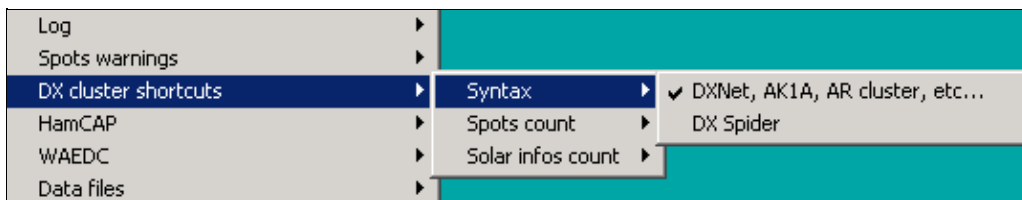

The DX Cluster Shortcuts dialog

The count of DX spots and solar data can be set in the [Options | DX cluster | DX cluster window shortcuts](#) menu. This menu also allows you to select which type of DX Cluster you are connecting to, either the DXNet/AK1A/ARcluster type or the DX Spider type, where the command syntax is slightly different.

Additionally, there are five macro buttons that allow you to store often used commands or sequences. They come in handy for setting up the connection over a flakey or unstable link. Use **[Shift]** - Click to edit these macros.

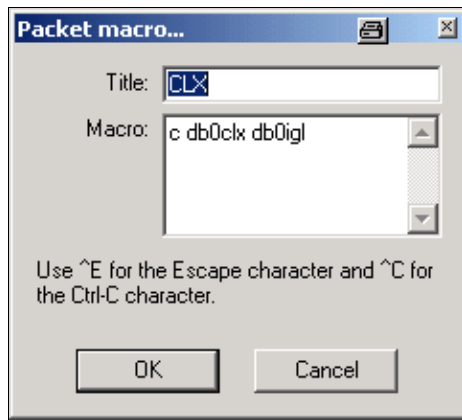

The DX Cluster Macros dialog

Since pressing **[Escape]** would close the current window, you can use **Ctrl-E** to send an Escape character to the TNC (if it is in WA8DED host mode) to generate commands like

```
* I DL6RAI
* S1
* CDB0IGL
```

All entered commands are stored in a 10-slot recall buffer, in which you can navigate with the **[Up]** and **[Down]** arrow keys.

## Spot...

Shortcut **Alt-F3**.

Sends a DX spot with the callsign of the current call in the callsign field or the previously logged QSO to the DX cluster you are connected to. The frequency is the active frequency of the current radio or the frequency on which the QSO was logged. This even works correctly when the cursor is positioned on a previous QSO.

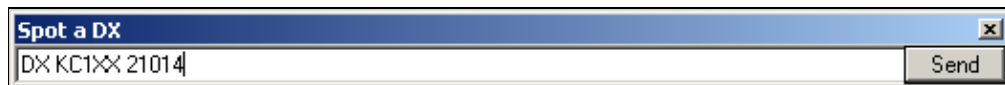

Spot a station on a DX cluster

You can also modify the command (by adding a comment for example), before sending the spot. To cancel sending a spot, close the dialog box or press **[Escape]**.

If you have no computer control for your transceiver, you will have to manually enter the frequency before the spot can be sent.

The context menu of the Band Map lets you select the policy after which time (if at all) spots entered by the operator are deleted from the band map.

## Propagation forecast

Shortcut **Ctrl-P**.

This function will be activated only if:

DX-Cluster

• Ham CAP (by VE3NEA), and its pre-requisite VOACAP v.08.1124W, are installed on your computer and

- a **CALLSIGN** is typed in the entry field

This is a sample of a Propagation Prediction Map you can get.

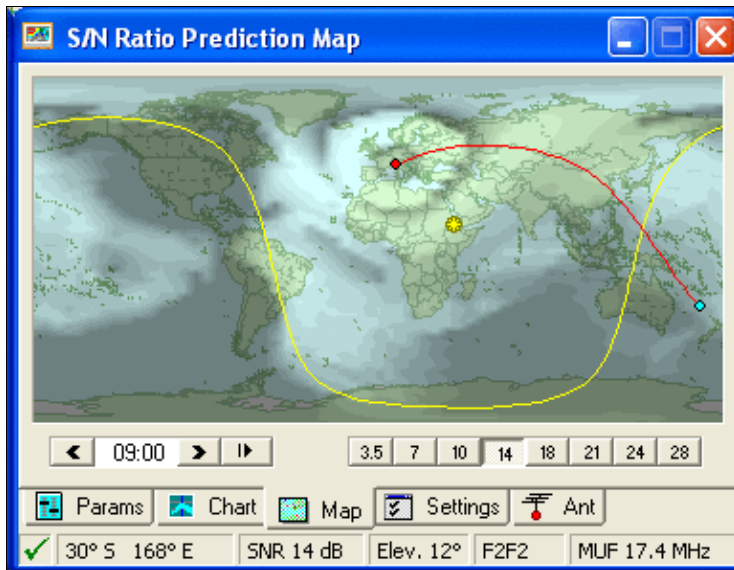

Propagation prediction map.

Clicking on the **Chart** Tab this is what will appear:

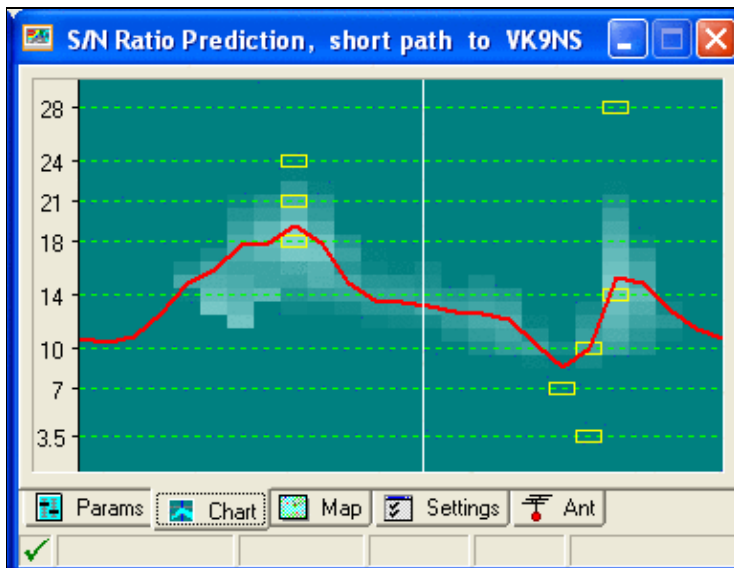

Point-to-Point Prediction Chart.

This is a very comprehensive and useful representation.

The red curve shows the statistical median MUF (50% Maximum Usable Frequency), while the yellow boxes mark the best hour for each ham frequency.

For more information refer to:

- [HamCap](#) Installation and Configuration
- [Options | HamCAP](#)

## Insert into BandMap

Shortcut **Ctrl-[Enter]**. Inserts - into the band map of the active radio - the callsign captured in the logging field. This is very useful, especially while hunting for multipliers, to quickly detect a station in the band when you turn the VFO knob.

## Active Radio

Switches the active radio. A double-click on one of the VFOs of the corresponding Bandmap will provide the same result. The "\*" key also swaps the 2 radios (useful for SO2R operation).

## Station Type

Indicates the station type for the current QSO. This command is useful for multi operators set-ups (M/S or M/2), if the contest rules make a difference between these status for the current category. If not, only the RUN (or RUN / SUPPORT) status can be used. At the end of each QSO line (or in the [Status Window](#)), you can see:

- R : RUN (running station in M/S)
- M : MULT (multiplier station in M/S, non-multipliers worked by multiplier station will be clearly indicated)
- R1 : RUN 1 (First M/2 station)
- R2 : RUN 2 (Second M/2 station)
- R+ : SUPPORT (see below)

The station type can be fixed for a computer so that when you reopen the log, or create a new log, the station type is the same as it was previously. Select the **Sticky Setting** checkbox to enable this feature.

The + indicates that the station is a SUPPORT station.

A SUPPORT station has the same settings as the MASTER station it refers to. It allows to have a RUN station, which runs the pile-up, and a RUN SUPPORT station (R+) which searches for multipliers on the same band as the RUN station (usually called INBAND station). As well, there can also be several MULTI, RUN1 stations ...

**Note:** The station type has no connection with the network station name in a Multi-OP environment setup which you set up when opening a [new log](#). For a correct generation of the



Cabrillo file of a M-2 entry, make sure your two active stations are type R1 and R2 - no matter what name they have in the network.

## CW/RTTY Messages

Sends the CW and RTTY messages [F1]...[F7], [Insert] and [+]. See [Keys](#) for more information.

You can also open and modify the **additional messages**-dialog (which may be opened any time with the shortcut **Alt-C**).

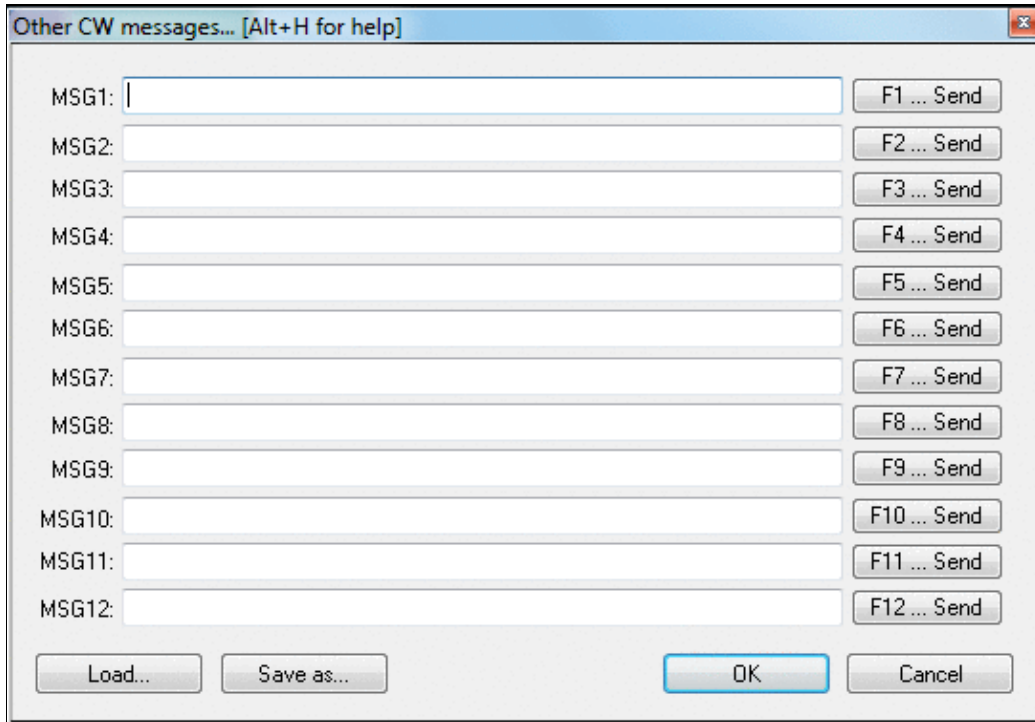

Additional CW/RTTY messages dialog

Please pay attention to the fact that the Message Variables (beginning with \$), like **\$MYCALL**, **\$SERIAL**, etc. DO NOT work within these additional messages.

## Remote commands...

Equivalent to the **REMOTE** text command.

Allows you to send a single text command to the local PC and to all other stations connected to the network at the same time.

In the example below, the **NOSYNC** text command is being used to temporarily disable log synchronization on the local PC and the remote PC named "20m" (see Clearing all logs before the start for why you might need to do this).

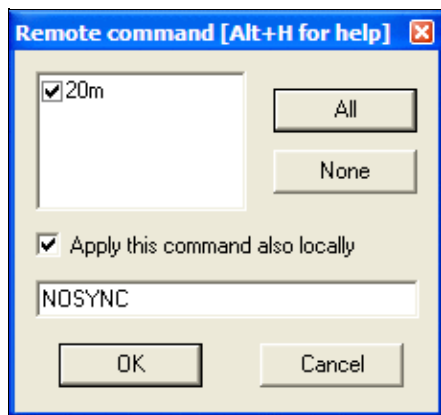

The **REMOTE** dialog lets one operator run a command on one or more networked computers

After entering the command, a gab message is generated automatically to confirm execution of the command on the local and remote computers, e.g.

```
20m: 40m: The command "NOSYNC" was carried out.
```

This menu item is only available if more than one station is available on the network.

**Use with great care!**

## Namespaces

- [Page](#)
- [Discussion](#)

## Variants

## Views

- [Read](#)
- [View source](#)
- [View history](#)

## More

- This page was last edited on 10 April 2023, at 07:06.

- [Privacy policy](#)
- [About Win-Test Wiki](#)
- [Disclaimers](#)



# Menu:Edit

From Win-Test Wiki

[Jump to navigation](#) [Jump to search](#)

## Menu:Edit

### Contents

- [1 Restore QSO](#)
- [2 Initialize QSO](#)
- [3 Edit Date, Time, Freq. and Op. of QSO...](#)
- [4 Edit serial number](#)
- [5 Delete QSO](#)
- [6 Delete all QSO...](#)
- [7 Goto QSO...](#)
- [8 Goto Callsign...](#)
- [9 Apply exchangece to every QSO with...](#)
- [10 Move in my log only](#)

### Restore QSO

Shortcut: **Ctrl-Z**. Allows you to restore all the original data of a QSO you are modifying. Of course, the QSO you are modifying must already be logged before you use this command. It is most useful if you accidentally change something on a prior QSO, and wish to restore it.

### Initialize QSO

Shortcut: **[F11]** or **Alt-W**. Erases all the fields of the current QSO if it has not been confirmed. However, this key will not delete a QSO that has already been logged with **[Enter]**!

However, the best way to "delete" a QSO is to do it after the end of the contest, in the final log files. Otherwise, you can enter your own callsign instead (and clear it afterwards with [File Clean log...](#)), but this may create errors in the multipliers list. A better way is to duplicate the previous QSO, on the same band. It will be one more dupe QSO, but the points and the mutipliers will be correct.

### Edit Date, Time, Freq. and Op. of QSO...

Shortcut: **Alt-F**. Allows you to modify the date, time, frequency and operator of an already logged QSO. Note that you can only change the frequency on the same band. If you need to change bands, use **Alt+F1** or **Alt+F2** (see [QSY](#)).

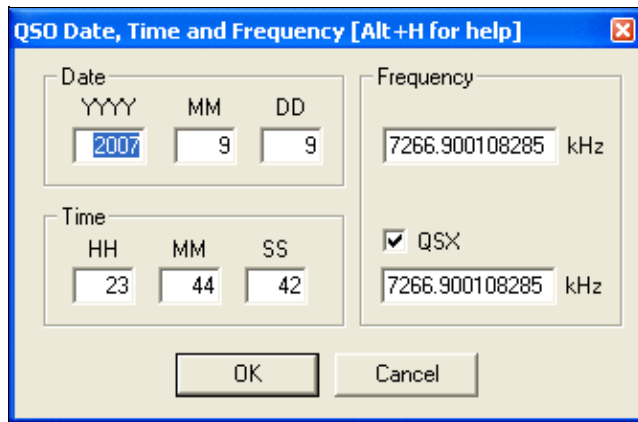

Editing QSO date and time and frequency

**Warning:** After a modification, Win-Test does not sort the logged QSO by time. The logging sequence by numbers is kept.

If you need to move your log, or a portion of it, ahead or back in time, please refer to the Tools [time shifting](#) feature in this manual.

## Edit serial number

This opens the edit serial dialog box. Here you can change your sent serial number.

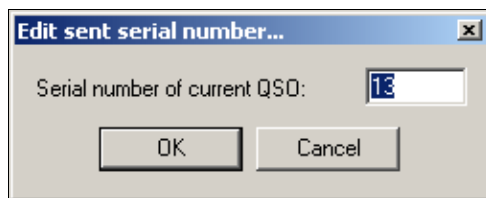

Editing the serial number

## Delete QSO

Permanently deletes a QSO in the log. As noted below, this command is irreversible. Note that you cannot delete QSOs unless log synchronization is disabled (see [Options | Disable log synchronization on network](#)).

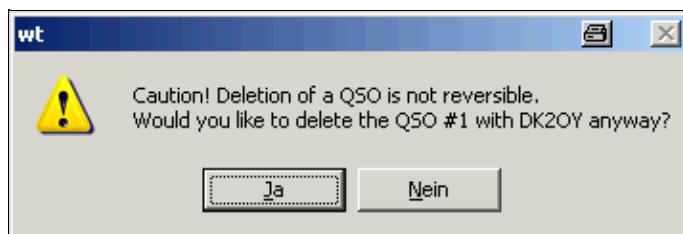

Deleting A QSO from the log. This feature is not supported when log synchronization is enabled, such as in a multi-computer network.

However, the best way is to make a note via **Alt-N**, then delete the QSO after the end of the contest, in the Win-Test file or the Cabrillo/ADIF files. Another option is to enter your own callsign in the logging window, then remove it after the contest with File | Clean log...

Yet another option is to duplicate the previous QSO. It will be one more dupe QSO, but the points and the multipliers will be correct.

## Delete all QSO...

Equivalent text command: **CLEARLOG**.

See also the **CLEARLOGNOW** and **COPYLOGCLEAR** text commands, which may be more convenient if you understand what they do.

This command deletes all the QSOs in the current opened file. Of course, as this should be rather unusual, you need to confirm the command.

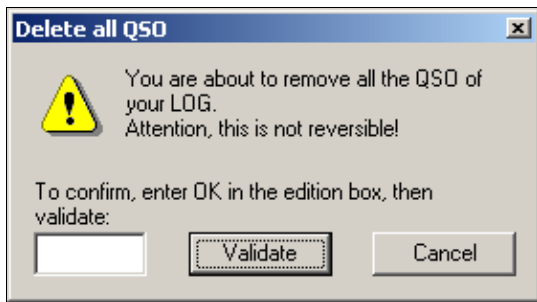

Deleting all QSOs

You need to literally type **OK** (uppercase) in the box, and then press [**Validate**] to delete all QSOs.

## Goto QSO...

Presents the dialog allowing to go directly to a QSO (if you know its number).

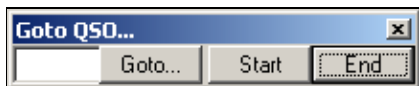

Goto QSO

With the two labelled buttons, you can locate the cursor at the beginning or at the end of the log. Same action will result by typing **START** (or **FIRST**) and **END** (or **LAST**) in the callsign logging field.

You can also locate the cursor on the desired QSO number just by typing this number in the callsign logging field and use this menu item, or by using its shortcut (**Ctrl-G**) for backward CT compatibility.

When you have jumped to a specific QSO, Win-Test will not let you move away unless there is a valid call in the callsign field and a valid exchange in the report field. If you inadvertently delete the callsign or report, press **Ctrl-Z** to undo the change.

## Goto Callsign...

Presents a dialog allowing you to go directly to a callsign. You can also use the shortcut **[Shift]–[Control]–G**.

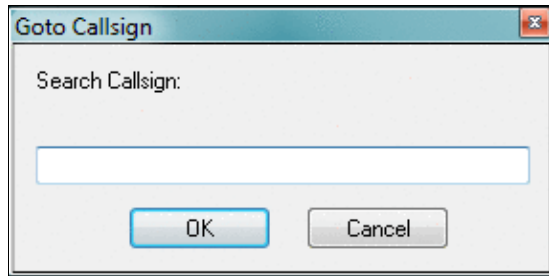

### Goto Callsign

By default, the callsign of the current QSO is searched. If the current line is empty (i.e. if the cursor is set to the last (empty) line of the log), a dialog is opened. The search is done backwards through the log.

## Apply exchange to every QSO with...

Allows you to correct a fixed exchange to every QSO in the log. This function is only available in contests, where fixed exchanges (like zones, states, districts) are exchanged. It allows you to make a consistent change without much typing.

You can also use the shortcut **[Control]–[F10]**.

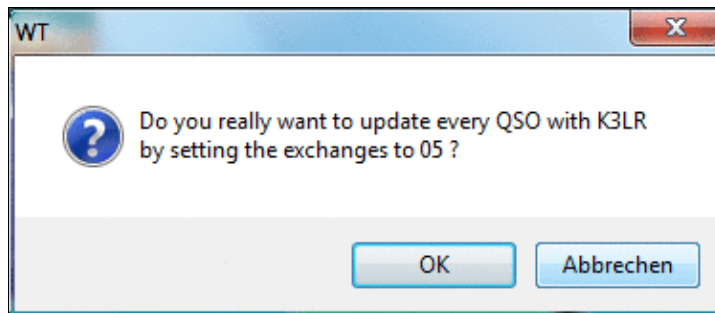

Apply Exchange to every QSO dialog.

## Move in my log only

Only useful in a multi-operating environment. Checking this option will allow the operator to step through QSOs in his own log, using the **[up arrow]** and **[down arrow]** keys. This makes it much easier to correct the last QSO logged, since the cursor skips over QSOs being logged by other computers in the network.

If this option is checked, you can still move to any QSO by pressing **[Shift]–[Up arrow]** and **[Shift]–[down arrow]**. On the other hand, if this option is unchecked, using these key combinations will navigate to QSOs made in your log only.

[Back to Menus](#)

## Namespaces

- [Page](#)
- [Discussion](#)

## Variants

## Views

- [Read](#)
- [View source](#)
- [View history](#)

## More

- This page was last edited on 17 December 2016, at 16:40.
- [Privacy policy](#)
- [About Win-Test Wiki](#)
- [Disclaimers](#)





# Menu:File new

From Win-Test Wiki

[Jump to navigation](#) [Jump to search](#)

## Menu:File (without a file opened)

### Contents

- [1 New](#)
- [2 Contest Configuration](#)
  - ◆ [2.1 Station Parameters](#)
  - ◆ [2.2 Contest Parameters](#)
  - ◆ [2.3 Network Parameters](#)
- [3 Open](#)
  - ◆ [3.1 Corrupted Files](#)
- [4 Import](#)
- [5 Export](#)
- [6 Merge Logs](#)
- [7 Clean log](#)
  - ◆ [7.1 Cleaning](#)
  - ◆ [7.2 Time Shift](#)
  - ◆ [7.3 Resolving 10-Minute-Rule Violations](#)
- [8 Quit](#)

### New

You may use `File | New . . .` to create a new log file.

**Note:** Since Win-Test stores most CW/RTTY messages and window positions in each log file, it is usually more convenient to copy an old Win-Test log file of the same contest type, rather to use the method described below. When you create a brand new log file with Win-Test, it resets all CW/RTTY messages and Window positions to Win-Test defaults, and these may not represent your personal preferences.

Win-Test first shows the contest configuration screen, which is described in detail in the [Contest Configuration](#) section below.

# Win-Test Wiki

**Contest configuration** ✖

**Station**

Callsign:  Locator:  Exchange (zone, ...):   ?

DXCC Prefix:  WAZ zone:  ITU zone:  State/Province/Other:

Name:

Address:

Address:

Address:

Club:

**Load**

**Save as**

**Contest**

Contest:    This month only

Category:  Mode:

Overlay:  Band plan:

Class:  Power:

Operators:

**Network**

Station:   Enable time distribution across the network

Contest Configuration screen

After selecting a contest type and clicking the **OK** button, Win-Test automatically generates a new file name based on the type, mode, year, callsign, etc. Win-Test then displays the following dialog box, which you may use to change the generated name and subdirectory. The default extension for Win-Test log files is .wt4, which should not be changed. (Win-Test 3 used .wtb as the file extension, which stood for "Win-Test binary".)

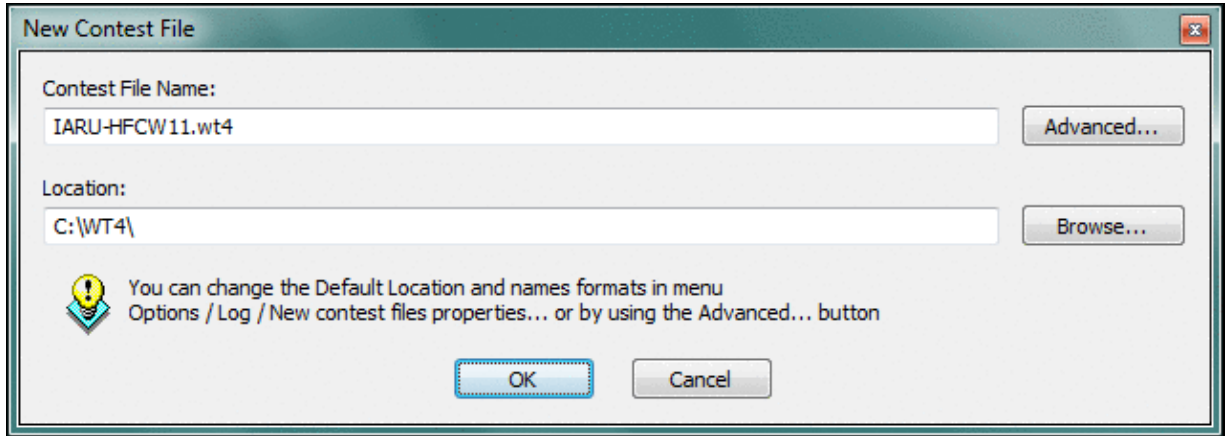

Dialog allowing you to customize the name and location of your log file

**Note:** For a multi-op setup, do *not* put log files on a shared network drive. Each computer must use its own local log file, stored on its own local hard disk drive. Log data will be automatically shared and synchronized between computers (when enabled) across the local network by Win-Test.

To change the default location and naming convention, click the **Advanced...** button and refer to the legend displayed at the bottom of the dialog, as shown below:

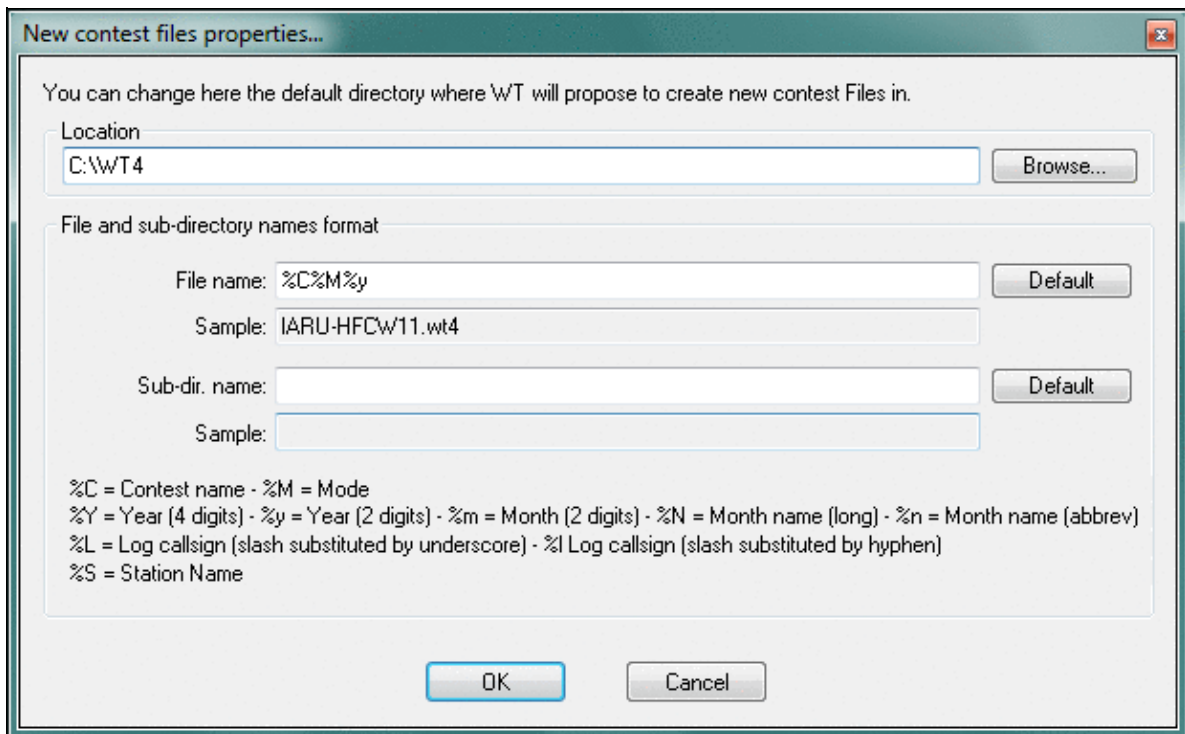

Use this dialog to change the default naming convention and location of your Win-Test log files. By default, Win-Test creates a new sub-directory for every contest type. If you wish to have all of your logs stored in the *same* directory, leave the **Sub-dir. name** field blank, as shown above.

## Contest Configuration

After selecting **New**, **Open**, or entering the **REOPEN** text command when a log is already open, the contest parameters are shown in the following dialog box:

The screenshot shows the 'Contest configuration' dialog box with the following fields and options:

- Station:**
  - Callsign: N6TV
  - Locator: CM97CF
  - Exchange (zone, ...): 6
  - DXCC Prefix: W
  - WAZ zone: 03
  - ITU zone: 06
  - State/Province/Other: CA
  - Name: Robert A. Wilson
  - Address: 51 Cheltenham Way
  - Address: San Jose, CA 95139-1257
  - Address: USA
  - Club: Northern California Contest Club
- Load:**
  - N6TV
  - Station 2
  - Station 3
  - Station 4
  - Station 5
- Save as:**
  - N6TV
  - Station 2
  - Station 3
  - Station 4
  - Station 5
- Contest:**
  - Contest: IARU HF World Championship
  - Days...  This month only
  - Category: Single operator
  - Mode: CW
  - Overlay: ---
  - Band plan: Default
  - Setup...
  - Class: High power
  - Power: 1500
  - Operators:
- Network:**
  - Station: STN1
  - Enable time distribution across the network

Buttons: OK, Cancel

## Contest configuration parameters

**Station Parameters**

- **Callsign:** The one used during the contest. Do not specify the departement (REF contest), or the zone number in this field ! On the other hand, the potential /P, /M or /MM must be specified.
- **Locator:** Mandatory for a VHF contest. Optional but useful for an HF contest (this will allow to get accurate beam headings or sunrises/sunsets). To determine your locator, go to <http://f6fvy.free.fr/qthLocator/fullScreen.php>, find your location on the interactive map, and click on it to display your grid square number.
- **Exchange:** Type your zone, your state, your department... according to the contest you will run. For example, for a CQWW DX contest, specify your WAZ zone. Let this box empty if the sent report is a serial number (for the WPX, for example). If there is a domestic and a DX side in the contest, specify DX if it is your case. Press the button with the "?" symbol to get more information.
- **DXCC prefix:** Standard prefix of your DXCC country. This information is used only for live score reporting, so you may leave that open.
- **WAZ zone:** Your WAZ zone. This information is used only for live score reporting, so you may leave that open.
- **ITU zone:** Your ITU zone. This information is used only for live score reporting, so you may leave that open.
- **State/Province/Other:** Your state, province or other regional designator. This information is used only for live score reporting, so you may leave that open.
- **Name:** Name of the callsign's owner.
- **Address:** You have 3 free lines to give the address of the station. Keep the last one to specify your zip code and town, as well as your country for an international contest.
- **Profiles:** You can save up to five different station profiles. Profiles are a set of station information (Callsign, Name, Address, etc.) that can be reused when necessary; they allow quick Win-Test setup for operators that frequently change their contest call, or go to DXpeditions, or operate on a multi-op team. Profiles are saved in specific sections in the `wt.ini` file.
  - ◆ **Load:** click the button to load the previously-saved station profile
  - ◆ **Save as:** click the button to create a Station profile. To *rename* or reuse a station profile, [**Shift**]+**click** on the button and follow the prompts.

**Contest Parameters**

- **Contest:** The contest to run. Multipliers, dupe checking, points scoring etc... will depend on this choice. Please be careful! Regarding VHF contests, Win-Test supports 2 "generic" contests: "European VHF" and "European VHF (gridsquare counting as multiplier)". These 2 contests will be compatible with the vast majority of the minor contests having the same scoring system.
- **Category:** Choose the category in which you will participate. Check in the rules that the corresponding category really exists in the specified contest! Win-Test does not check for the existence of a specific category against the current contest rules.
- **Overlay:** Some contests rules show overlays (like Rookie). Check in the rules that the corresponding overlay really exists in the specified contest!
- **Mode:** Choose the mode in which you will participate. Selecting **MIXED** will allow you to switch between SSB and CW. If you also wish to have digital modes, select **ALL**. Check the rules if the corresponding mode really exists in the specified contest!
- **Band plan:** Select a contest-specific band plan or leave the Default one. For more details, please see [Options | Bandplans...](#)
- **Power:** Your effective power, compulsory for the ARRL DX, on the DX side. Use only numbers, figures like **5** or **100**, but do not specify watts! If you are allowed to transmit more than 1 kW,

specify **KW**.

- **Class:** Choose the power class.
- **Operators:** Put the operators' callsigns here. For strict compatibility with the Cabrillo format, please leave a blank space between each listed callsign.

## Network Parameters

The following parameters make sense only in a networked Win-Test environment.

- **Station name:** All computers in the network must have different names. Use descriptive names to easily recognize a computer in the status window. To prevent any side effect (especially on the network), the syntax of the station name is checked, and 'exotic' characters are replaced by an underscore if needed.
- **Enable time distribution in network:** In order to synchronize the timestamps of all logged QSOs, *one and only one* computer should be defined as **time master** by checking this box.

## Open

Opens a log file in the Win-Test format (.wt4 for Win-Test version 4, .wtb for Win-Test 3).

There is no need to close the file already in use. The new file will take its place.

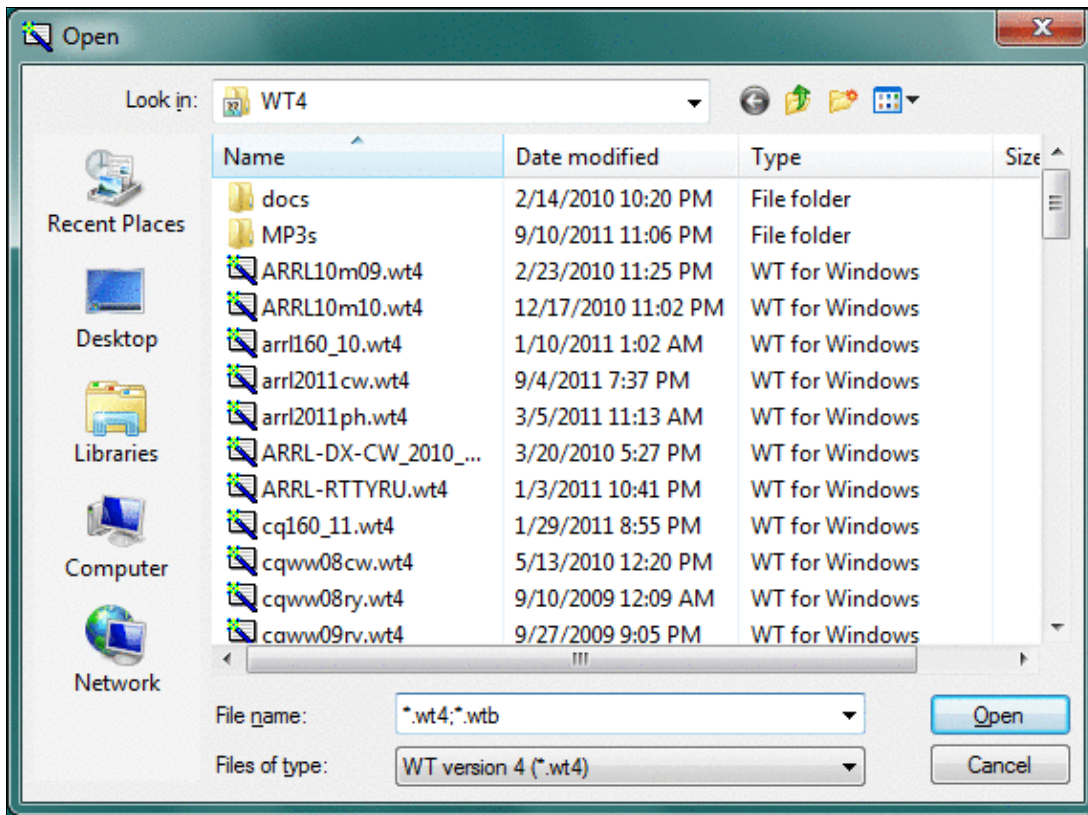

Opening a Win-Test binary log file

After choosing the file, the contest configuration dialog appears:

**Contest configuration**

Station

Callsign:  Locator:  Exchange (zone, ...):   ?

DXCC Prefix:  WAZ zone:  ITU zone:  State/Province/Other:

Name:

Address:

Address:

Address:

Club:

Load

Save as

Contest

Contest:    This month only

Category:  Mode:

Overlay:  Band plan:

Class:  Power:

Operators:

Network

Station:   Enable time distribution across the network

Contest configuration screen

You can then modify these parameters, if needed, before starting to log contacts. See the [Contest Configuration](#) section above for more information.

A progress bar is then displayed as the log file is loaded, as well as information about data base files associated with the contest.

## Corrupted Files

Should your file have been corrupted by any means, Win-Test will automatically open up a dialog to fix the error.

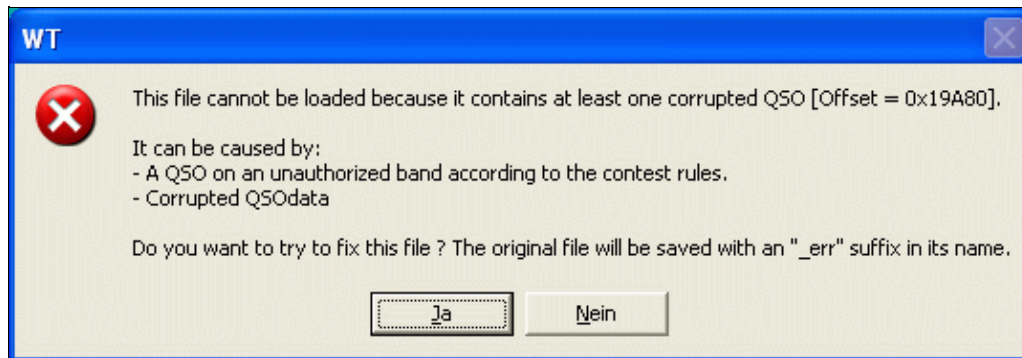

Fix Errors Dialog. Make sure you know what you're doing

The original log will be saved under the original name with an **\_err** suffix before the .wt4 extension.

The fix will most probably delete the QSO records in question to allow for a clean log. Make sure you know what you're doing and be sure to have a backup of the original! Fixing the file is only possible in some cases. For example, when you inadvertently opened a v3 Win-Test file with Win-Test version 2, you are at a loss (see <http://www.f5mzn.org/pipermail/support/2006-November/072424.html>).

## Import

Allows to import logs from Editest or Cabrillo format to Win-Test format.

Furthermore, after importing the log file, you can immediately load this file in Win-Test, by checking the appropriate box.

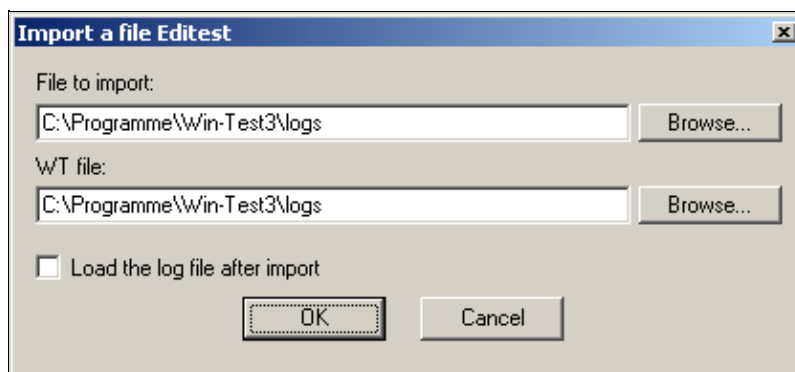



## Editest Import

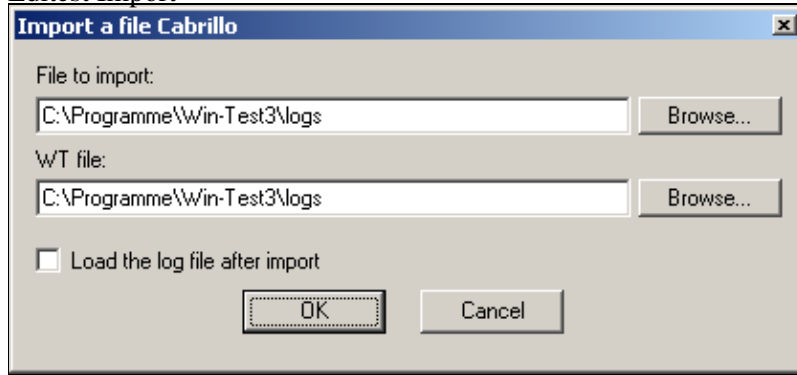

### Cabrillo Import

Of course, the original file is not modified.

## Export

Provides a way to export a Win-Test version 4 (.wt4) log into an Win-Test version 3 (.wtb) file format. The former Editest format is no longer supported for export.

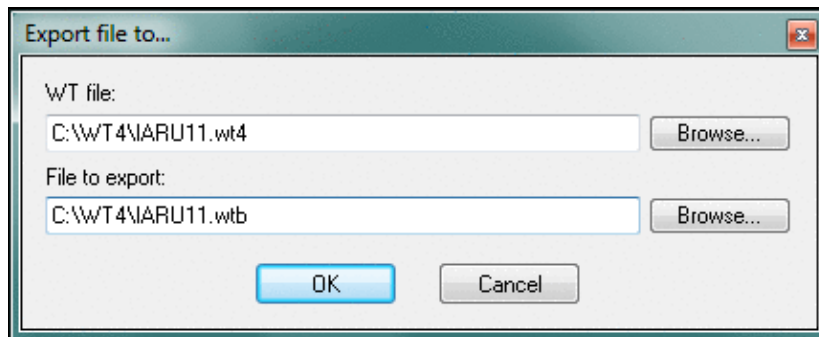

### Export to Win-Test version 3 format

The original .WT4 file is not modified.

## Merge Logs

Merging is the process of manually bringing two or more (partly) separate log files together.

Useful in a multi-operator Win-Test LAN, this menu allows to merge the logs issued from different computers. You can thus gather all the QSO in a unique file (named "master"), which has to be the first added to the list. The original file will be automatically saved before any modification (.bak).

Since Win-Test version 3, with networking and log synchronization, this should no longer be necessary. A valid scenario, however, could be a DXpedition, where several computers run independently, without a network backbone and a complete log has to be created on a day-by-day basis and distributed to all stations for completeness and redundancy or uploaded as an on-line-log.

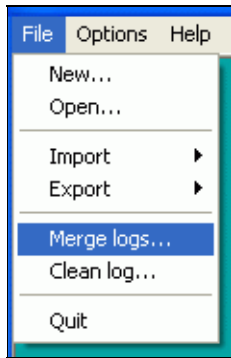

Start up the merge dialog; this menu item is visible only when no WT file is open

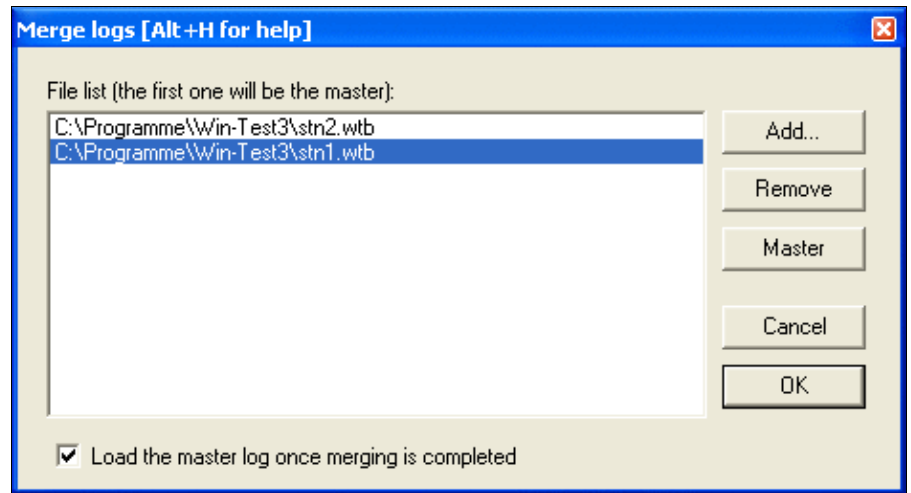

Now select the files to be merged

Merging Logs is done in six steps:

1. Close the current log
2. Collect all log fiels to be merged on your computer
3. Go to **File | Merge logs...**
4. Select all the log files you would like to merge
5. Select the file that should become the master file
6. Press OK to start merging

Win-Test will read QSO data from all the files and incorporate them into the designated master log file, removing any duplicate contacts. Optionally, you may chose to load the master log file after the merge process has finished.

This menu is only visible if no file is opened. If a log is opened, just close it by the `File | Close` menu or the **CLOSE** text command.

**Note:** If you have changed a QSO in a partial file and the unchanged QSO is still contained in another log that is being merged, you will end up with both the changed and the unchanged QSO in the final log.

**Note:** Win-Test will not allow merging logs from different contests.

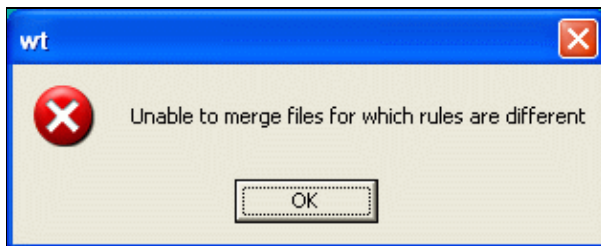

Files from different contests cannot be merged

## Clean log

### Cleaning

This function removes QSOs logged with your own callsign. It can also remove duplicate QSOs.

The recommended way to remove QSOs during a contest is to overwrite them with your own callsign. Later, after the contest, you can delete these QSOs from the log. Win-Test allows you to do that very easily via a menu item. QSOs with own callsign are ignored by WÅ–n-Test both for multiplier and QSO point credit during the contest.

**First, close the log** via **File | Close** or the **CLOSE** command. The Clean Log item is only visible, in the File menu, when the log is closed.

Then from the menu choose **File | Clean log**.

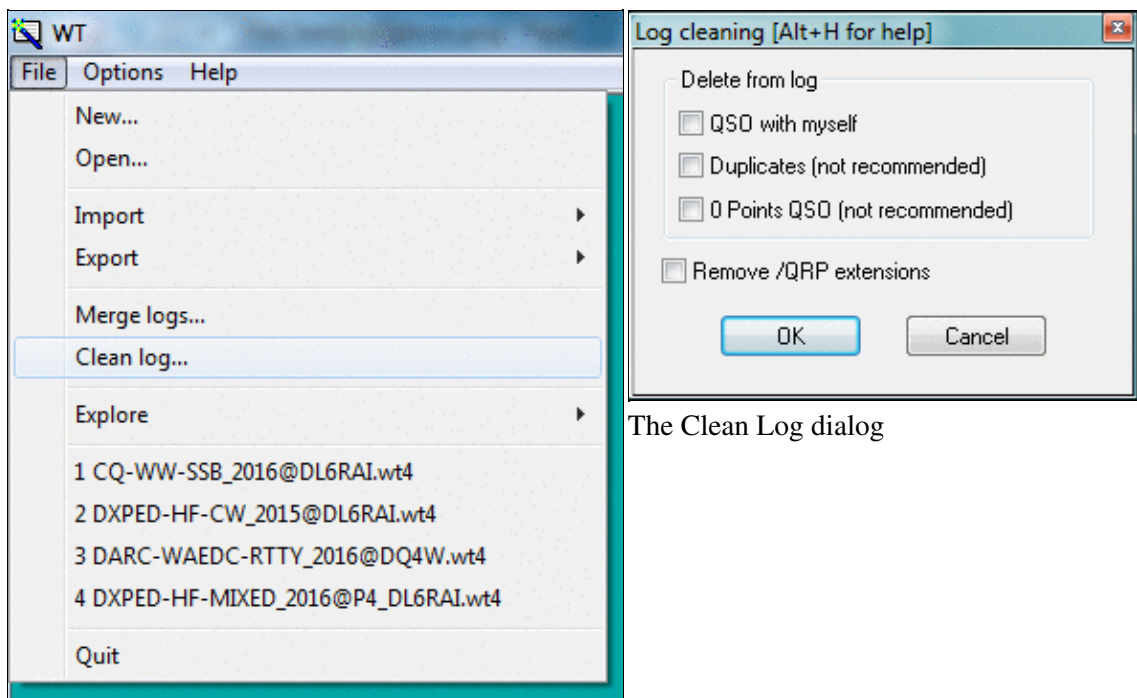

The Clean Log dialog

The Clean Log menu item

When you select Clean Log, Win-Test prompts you to select the log file you want to clean. Next the Clean Log dialog prompts you choose the actions you want to perform:

- to delete QSOs with yourself (good, these should be QSOs marked for deletion)
- to delete all duplicate QSOs (bad idea)
- to delete all zero point QSOs
- to remove any "/QRP" extensions (generally OK).

Please refer also to the [Multi-op/Deleting\\_QSO](#) chapter.

**Warning:** Contest sponsors advise to not delete duplicate QSOs from your log. In fact, if the other station did not correctly get your callsign during the first QSO, this QSO will be lost! The log checking software used by contest sponsors never penalizes a log for dupes, so it is OK to leave them in your log.

## Time Shift

This feature allow to move your log, or a portion of it, ahead or back in time. It is comparable to the CT\_TIME.EXE utility supplied with CT, back in the old days, and it has been extended in fuctionality.

For complete details please refer to [Menu:Tools Time shifting](#) in this manual.

## Resolving 10-Minute-Rule Violations

This is a typical Multi-OP item. Please see [Multi-op/Issues/Non Multipliers](#) for more information about this topic.

## Quit

Closes the current file and quits Win-Test back to the Windows environment.

[Back to Menus](#)

## Namespaces

- [Page](#)
- [Discussion](#)

## Variants

## Views

- [Read](#)
- [View source](#)
- [View history](#)

## More

- This page was last edited on 17 December 2016, at 17:53.

- [Privacy policy](#)
- [About Win-Test Wiki](#)
- [Disclaimers](#)



# Menu:File open

From Win-Test Wiki

[Jump to navigation](#) [Jump to search](#)

## Menu:File (with a file opened)

### Contents

- [1 New](#)
- [2 Open](#)
- [3 Close](#)
- [4 Create Log Files](#)
- [5 Backup contest](#)
- [6 Archive](#)
- [7 Update database](#)
- [8 Explore](#)
- [9 Most Recently Used](#)
- [10 Quit](#)

### New

This will create a new Win-Test file. Please see [elsewhere](#) for a detailed description.

### Open

This will open an existing Win-Test file. Please see [elsewhere](#) for a detailed description.

### Close

Closes the current file, but remains in the Win-Test environment. The way to switch logs without having to restart Win-Test.

### Create Log Files

Text command shortcut: **WRITELOG**

Creates log files to be sent to the contest organizer for checking (usually Cabrillo), or to import into your personal log book software. Note that not all formats are available for all contests.

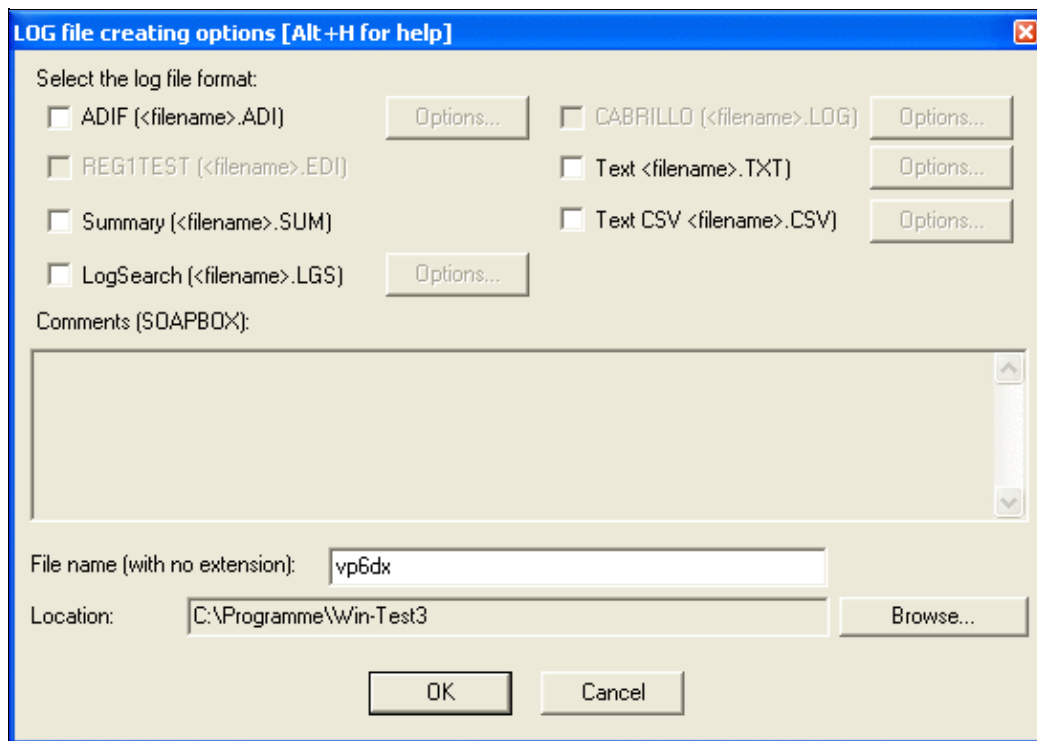

The "Create Log Files..." dialog box

Select the files to be created, optionally add comments (soapbox), and specify a name to be used for the files. You may also specify a target directory path that is different than the log file directory

For more details, please see [Creating](#).

## Backup contest

Saves a copy of the complete log file in a backup directory, which has to be specified in the **Options | Automatic backup** dialog. If this directory is embedded in a floppy disk, it has to be present in the drive A: while executing this command. The file will have an additional **.bak** extension (**test.wtb.bak** for example). To use this backup file, just rename the file without the **.bak** extension.

**Warning:** A 1.44" MB floppy disk will accept no more than approximately 7,000 QSOs!

## Archive

Creates a timestamped zipped file in the log directory of the files related to the current log that are selected. Warning: Archiving audio recordings file that are usually pretty large can take a while... be patient!

When archiving, the full path of the generated zip file is copied to the clipboard.

## Update database

Allows to enrich the database of the contest with the datas from your log. If a callsign already exists in the database, the attached datas in your log may replace those in the database. If the callsign does not exist, it will be added, with its attached datas.

## Explore

Comfortably open the Windows Explorer in one of Win-Test's directories.

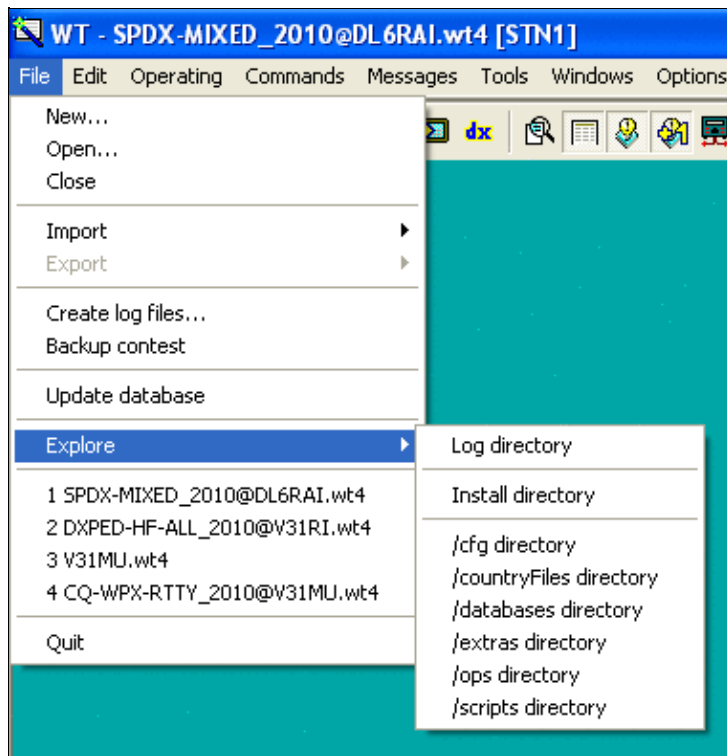

The "File | Explore" dialog box

### Most Recently Used

The next menu block lists the last four most recently opened files. This will let you switch between files quickly.



Most recently used Files List

### Quit

This selection will Quit Win-Test and will bring you back to the Windows environment. Before using this command, **don't forget** to complete your last QSO!

[Back to Menus](#)



## Namespaces

- [Page](#)
- [Discussion](#)

## Variants

## Views

- [Read](#)
- [View source](#)
- [View history](#)

## More

- This page was last edited on 10 April 2023, at 07:04.

- [Privacy policy](#)
- [About Win-Test Wiki](#)
- [Disclaimers](#)



# Menu:Help

From Win-Test Wiki

[Jump to navigation](#) [Jump to search](#)

## Contents

- [1 Register software](#)
- [2 Use online documentation](#)
- [3 Reference manual](#)
- [4 Display text command tips for menu items](#)
- [5 Win-Test Home Page](#)
- [6 Documentation Wiki Home Page](#)
- [7 About](#)

## Register software

Help | Register Software...

Please refer to the detailed Installation Guides in the [FAQ page](#) for step-by-step instructions on how to use this dialog.

Even with the trial or "demo" version, you can fully use Win-Test. There is only a time restriction that randomly shuts down Win-Test, and exported logs (Cabrillo, Reg I Test) are limited to 50 QSOs.

To register Win-Test, after having purchased a licence, you just need to visit the Win-Test web pages and request a key code, by entering your customer account number and your system's Computer Code which is displayed in this dialog box.

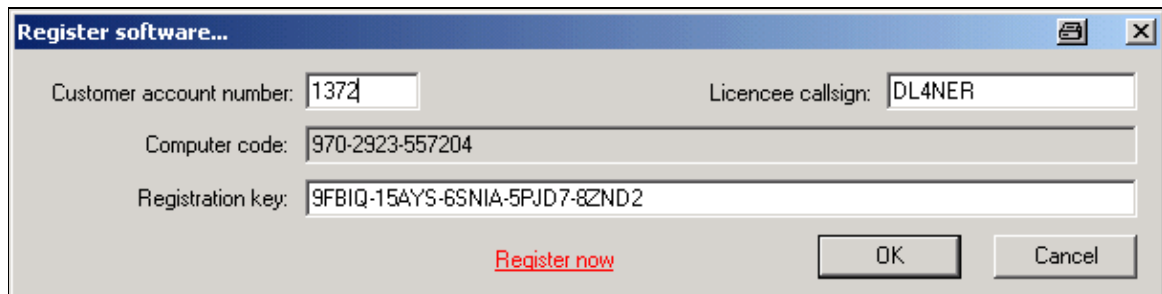

Register software...

Customer account number: 1372      Licencee callsign: DL4NER

Computer code: 970-2923-557204

Registration key: 9FB1Q-15AYS-6SNIA-5PJD7-8ZND2

[Register now](#)      OK      Cancel

Win-Test Registration Window

A license key will be sent to you via email from the license robot. Just copy this key into the correct field and press OK. The limitations will then be disabled and when Win-Test starts up, you will no longer have to press keys 1, 2 or 3.

## Use online documentation

Help | Use online manual

If this option is checked, Win-Test tries to access the reference manual on the web, instead of using the local copy that has been distributed with the installation file.

## Reference manual

Help | Reference Manual or **Alt-H**

Starts a browser and displays the reference manual.

Sometimes, the documentation provided with newer releases of Win-Test are slightly outdated. To use the most current version of the manual, either select the "online" version as shown above or retrieve a copy of the static manual from <http://docs.win-test.com/pdf/static/manual.zip> and unpack it in the Win-Test/docs/en directory (rename or remove the original en-directory first). This will provide you with the most up-to-date documentaion.

## Display text command tips for menu items

Help | Display text commands tips for menu items

This option lets you enable tool tips (small yellow pop-up help text) for menu items. This option is enabled by default. These tool tips display keyboard shortcuts or text commands for the functions selected. Text commands let you perform menu functions without having to use the mouse.

## Win-Test Home Page

Help | Win-Test Home Page

Starts up the system Web browser and directs it to go directly to the Win-Test Home Page <http://www.win-test.com>.

## Documentation Wiki Home Page

Help | Documentation Wiki Home Page

Starts up the system Web browser and directs it to go directly to the Win-Test Documentation Website (Wiki) <http://docs.win-test.com>.

## About

Help | About

Displays the Win-Test version used, and allows a direct access to the Win-Test web pages at [www.win-test.com](http://www.win-test.com).



About Win-Test

[Back to Menu](#)

## Namespaces

- [Page](#)
- [Discussion](#)

## Variants

## Views

- [Read](#)
- [View source](#)
- [View history](#)

## More

- This page was last edited on 11 March 2015, at 20:55.

- [Privacy policy](#)
- [About Win-Test Wiki](#)
- [Disclaimers](#)



# Menu:Messages

From Win-Test Wiki

[Jump to navigation](#) [Jump to search](#)

## Contents

- [1 Send a Gab...](#)
- [2 Reply to the last private gab...](#)
- [3 Write a note regarding this QSO](#)

# Menu:Messages

## Send a Gab...

Messages | Send a gab... or **Alt-G**

Sends a gab on the local network, which will appear in the gab window of every connected computer. You can choose to send the gab to all or only to **one** station (drop down box on the left).

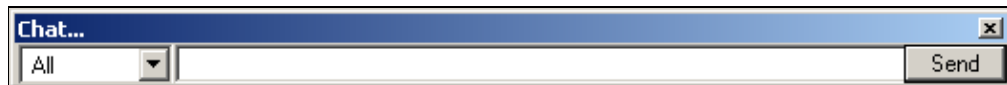

Sending a gab

The gab window opens up on all other computers and displays your message.



Gab window

The window will be visible for 15 seconds and then closes by itself. The operator can bring the window up again with **Alt-I**.

This way you can send messages to the other stations in a multi operator setup. Private gabs are displayed in different colors. Also multipliers passed from other bands will show up in this window in a different color, as you can see in the example.

If the text starts with "/me", it is replaced with the station name and the message is emphasized with a leading and a trailing star symbol.

If the text contains CAPITALS only, the recipients Gab window will shake, when receiving the text.

The gab messages are also written to disk and can be found as \*.gab (a text file that you can open with Notepad) after the contest.

## Reply to the last private gab...

Messages | Reply to the last private gab... or **Alt-P**

Like 'Send a gab' but directs the destination to the last private gab originator instead of all.

## Write a note regarding this QSO

Messages | Write a note regarding this QSO or **Alt-N**

Opens the note input dialog.



Making a note

The notes are written to disk and can be found as \*.not (a text file that you can open with Notepad) after the contest.

The notes are also forwarded to the network so that there is a complete notes file on every station.

[Back to Menus](#)

## Namespaces

- [Page](#)
- [Discussion](#)

## Variants

## Views

- [Read](#)
- [View source](#)
- [View history](#)

## More

- This page was last edited on 30 December 2021, at 13:20.

- [Privacy policy](#)
- [About Win-Test Wiki](#)
- [Disclaimers](#)



# Menu:Operating

From Win-Test Wiki

[Jump to navigation](#) [Jump to search](#)

## Menu:Operating

The following controls are only available if [Technique | SO2R](#) or [Technique | Advanced SO2R](#) are checked. They are specific to SO2R operation. For more information on SO2R, please see [Running a Contest](#).

### Contents

- [1 Listen to the primary radio](#)
- [2 Listen to the secondary radio/headphone toggle](#)
- [3 Listen to the secondary radio during transmit/headphone latch](#)
- [4 Listen both radio/headphone split](#)
- [5 Revert to automatic control](#)
- [6 Technique](#)
- [7 Modify the scenarios](#)
- [8 Shift binds to the secondary radio](#)
- [9 Caps Lock binds to the secondary radio](#)
- [10 The second footswitch binds to the secondary radio](#)

### Listen to the primary radio

Shortcut: **[AltGr-A]** or **[Ctrl-Alt-A]**. This switches the headphones to the primary radio.

### Listen to the secondary radio/headphone toggle

Shortcut: **[AltGr-T]** or **[Ctrl-Alt-T]**. This switches the headphones to the secondary radio.

### Listen to the secondary radio during transmit/headphone latch

Shortcut: **[AltGr-L]** or **[Ctrl-Alt-L]**. This option automatically switches the headphones to the secondary radio on transmit.

### Listen both radio/headphone split

Shortcut: **[AltGr-S]** or **[Ctrl-Alt-S]**. Switches to both radios (left radio on the left headphone, right radio on the right headphone).

## Revert to automatic control

Shortcut: [**AltGr-R**] or [**Ctrl-Alt-R**]. Restores automatic control.

## Technique

Here you can choose the operating technique:

- SO1R / MultiOp
- SO2R
- Advanced SO2R

This menu entry enables/disables the above mentioned listening functions.

## Modify the scenarios

Shortcut: in the Secondary Radio Window, just *double-click* on the scenario *name*.

Here you can configure the SO2R "scenarios," which define how pressing a function key will affect headphone audio for an SO2R operator, in both Run and S&P modes.



Modify the SO2R scenarios

See [SO2R/Advanced SO2R/Setting up scenarios](#) for more information.

## Shift binds to the secondary radio

When checked, the [**Shift**] key can be pressed to bind the keyboard input focus to the secondary radio window.

See [SO2R/Shift binds second radio](#) for important keyboard mapping considerations before selecting this option.

When a binding key is used, the color background of the QSO area is changed.

## Caps Lock binds to the secondary radio

When checked, the [**Caps Lock**] key can be pressed to bind the keyboard input focus to the secondary radio window.

See [SO2R/Caps Lock binds to the secondary radio](#) for more information.

When a binding key is used, the color background of the QSO area is changed.

## The second footswitch binds to the secondary radio

When checked, the second footswitch can be pushed to bind the keyboard focus to the secondary radio window. This option is only supported for the EZMaster SO2R controller.

[Back to Menu](#)

## Namespaces

- [Page](#)
- [Discussion](#)

## Variants

## Views

- [Read](#)
- [View source](#)
- [View history](#)

## More

- This page was last edited on 1 July 2018, at 22:37.
- [Privacy policy](#)
- [About Win-Test Wiki](#)

- Disclaimers



# Menu:Options

From Win-Test Wiki

[Jump to navigation](#) [Jump to search](#)

## Menu:Options

### Contents

- [1 Load contest at startup](#)
- [2 Automatic backup...](#)
- [3 Disable log synchronization on network](#)
- [4 CW](#)
  - ◆ [4.1 No sound](#)
    - ◇ [4.1.1 Note for some new Laptops](#)
  - ◆ [4.2 Initial Speed](#)
  - ◆ [4.3 Modify standard messages...](#)
    - ◇ [4.3.1 Sprint Exchange Logic](#)
  - ◆ [4.4 Modify additional messages...](#)
  - ◆ [4.5 Modify WAE messages...](#)
  - ◆ [4.6 Custom variables...](#)
  - ◆ [4.7 Serial number](#)
  - ◆ [4.8 Correction](#)
  - ◆ [4.9 Shortened spaces \(CT spaces\)](#)
  - ◆ [4.10 Auto sending...](#)
  - ◆ [4.11 Remap keys in keyboard mode](#)
  - ◆ [4.12 Work dupes](#)
  - ◆ [4.13 Speed bursts](#)
- [5 RTTY](#)
  - ◆ [5.1 Modify standard messages...](#)
  - ◆ [5.2 Modify additional messages...](#)
  - ◆ [5.3 Modify WAE messages...](#)
  - ◆ [5.4 Custom variables...](#)
- [6 Configure interfaces...](#)
  - ◆ [6.1 Serial Ports](#)
  - ◆ [6.2 Transceivers](#)
  - ◆ [6.3 Printer Ports](#)
  - ◆ [6.4 CW](#)
  - ◆ [6.5 Local Network](#)
  - ◆ [6.6 Network Protocol Advanced Settings](#)
  - ◆ [6.7 Voice Keyer](#)
- [7 WinKey configuration...](#)
- [8 EZMaster configuration...](#)
  - ◆ [8.1 CW Keyer](#)
  - ◆ [8.2 Radio set-up](#)
  - ◆ [8.3 Packet-Radio TNC](#)
  - ◆ [8.4 Antenna configuration according to RX/TX](#)
- [9 MK/MKII/MK2R/u2R configuration...](#)
- [10 OTRSP configuration...](#)

- [11 RTTY configuration...](#)
- [12 Frequency Offsets](#)
- [13 MP3 Configuration](#)
- [14 Script Editor Configuration](#)
- [15 Log](#)
  - ◆ [15.1 Fonts](#)
  - ◆ [15.2 Headers](#)
  - ◆ [15.3 Hide QSO numbers](#)
  - ◆ [15.4 Align Exchanges](#)
  - ◆ [15.5 Stay in field when moving up and down in the log](#)
  - ◆ [15.6 Block Cursor](#)
  - ◆ [15.7 Colors...](#)
  - ◆ [15.8 New Contest Files Properties](#)
- [16 DXpedition Info Field](#)
- [17 Spot Warnings](#)
- [18 DX Cluster](#)
  - ◆ [18.1 DX Cluster window shortcuts](#)
  - ◆ [18.2 Start/stop wtDxTelnet automatically](#)
- [19 HamCAP](#)
- [20 WAEDC](#)
- [21 Data files](#)
  - ◆ [21.1 Country files...](#)
  - ◆ [21.2 Master file...](#)
  - ◆ [21.3 Exchanges Database...](#)
  - ◆ [21.4 Default extra data files...](#)
  - ◆ [21.5 Markers files...](#)
  - ◆ [21.6 Segments files...](#)
- [22 Bandplans...](#)
- [23 Windows](#)
- [24 Toolbar](#)
- [25 Language](#)

## Load contest at startup

Options | `Load contest at startup`

Enables or disables the automatic loading of the last contest file in use. This command is useful to get on line again quickly if - for some reason - Win-Test crashed or you had to quit the Win-Test in the middle of the contest.

If you like to switch to another file, close this file using `File | Close` and then `File | Open` menu dialog.

If Win-Test is started with the `[Ctrl]` key down, it doesn't automatically load the previous log.

When starting Win-Test from the command line, use `-n` or `--noautoload` option to prevent automatically loading the last file in use.

## Automatic backup...

Options | Automatic backup...

This function enables or disables the automatic backup of the .wt4 file to another location, e.g. network drive or removable media like an USB stick.

You can choose an automatic backup interval between 1 and 120 minutes. If a backup fails, you are prompted if you wish to disable the backup.

The backedup files will be named identical to the original name with the extension .bak. Optionally a different (time-stamped) filename will be used for every new backup file (actually a good idea for backing up to a network drive!).

If the option "Always notify..." is ticked, an informal message will be displayed at the bottom of the screen after a backup run has finished.

For DXpeditions it may be useful to automatically create a Logsearch File with every backup. In this case, tick the corresponding option.

**Note:** Contrary to the .wt4 backup files, the LogSearch exports are not done in a separate background thread. Thus, it is not recommended to enable this option on a running station because WT will be unavailable for logging for a while every time an export is in progress.

Since Win-Test version 4.19, the backup also includes QTC files for WAEDC.

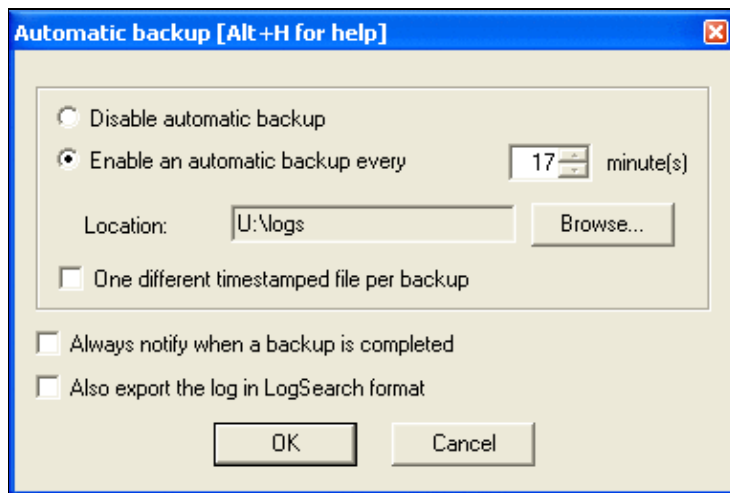

## Setting up Automatic Backup

Here is some additional advice:

- Backups are processed in a separate thread, meaning that you will not even notice that a backup is in progress! No slowdown, no keyboard blocking etc...
- Of course, it makes sense to backup to a different volume than your "working" drive. This avoids loss of everything if your hard disk fails. Do not smile... It happens, sometimes! (ARRL SSB 2002 FY5KE, IIRC!)
- Once you entered the last QSO, for safety, generate your Cabrillo log(s) before exiting. A simple "MAKELOG" command opens the appropriate dialog.
- In all cases, always make a copy of a file when you want to use/test/modify it. Always keep a backup, never use the original! If you have FTP access somewhere, copy the file there as soon as possible! If your computer crashes, you still will have a safe copy.

Call me paranoid, but believe me, you need to loose some day a **very** big chunk of data to understand the importance of backups!

## Disable log synchronization on network

Options | Disable log synchronization on network

Text command shortcuts: **NOSYNC** | **SYNC**

When selected, this option disables automatic background log synchronization over the network. It is only useful under certain circumstances, such as Clearing all logs before the start or deleting individual QSOs from a log when single-op, and using only one computer, because QSOs cannot be removed from a log when log synchronization is enabled.

**This option does not prevent QSOs logged on other computers from being added to the current log;** it only stops the background synchronization of any "missing" QSOs, which reduces network traffic when needed, such as when using very slow legacy serial port networking.

**Note:** Even when log sync is disabled via **NOSYNC**, whenever a *new* QSO is made on another computer in the network, **that QSO will still be broadcasted and added on all connected computers** as soon as it is logged. The best way to keep *all* QSOs from other computers from appearing in a log is to use the **Packet sharing only** button in the Network Protocol Advanced Settings dialog.

## CW

Options | CW

This menu item allows you to control different aspects of CW operation. It is enabled only when the selected operating mode is CW (otherwise it is greyed out).

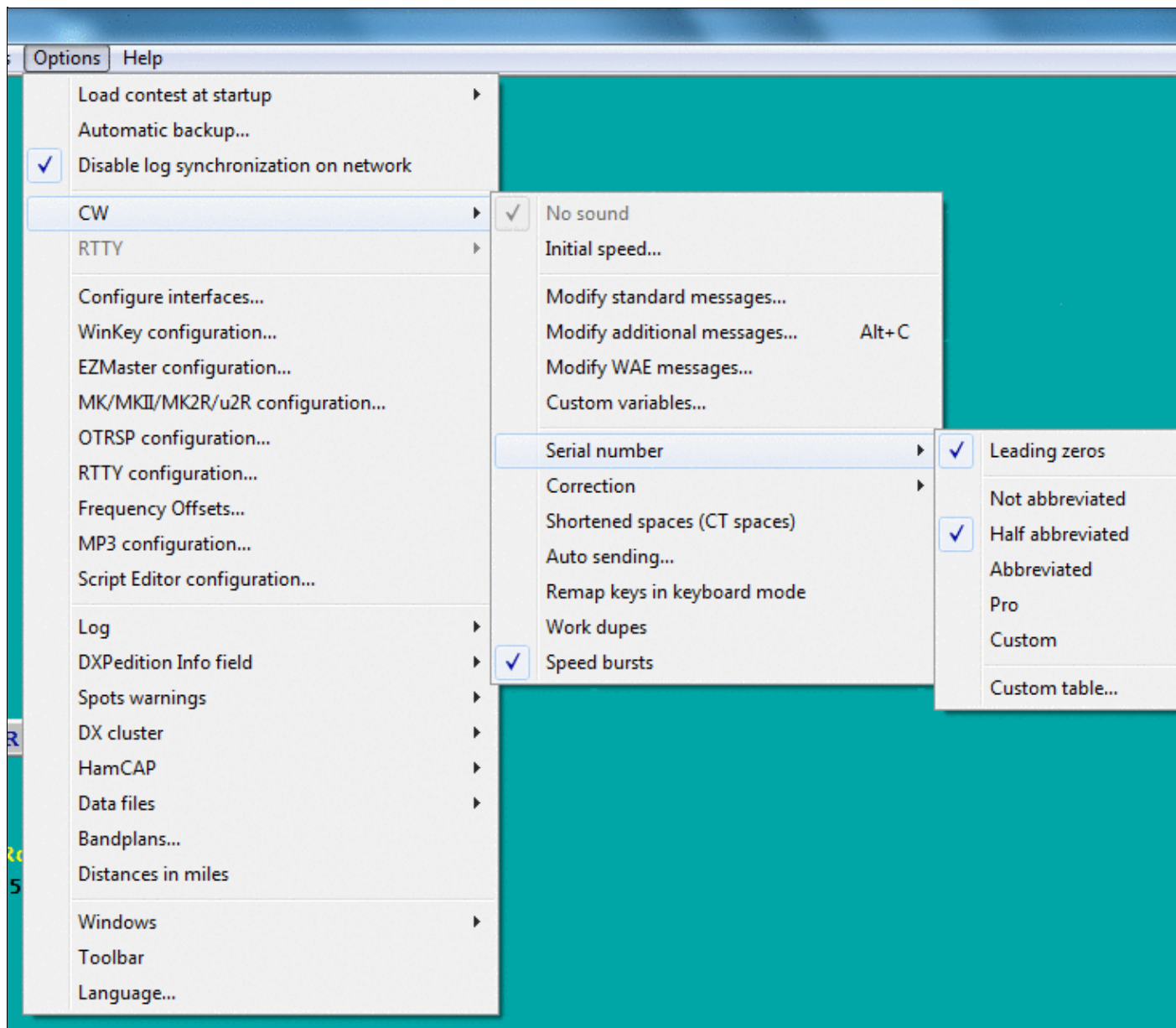

CW Options submenus

## No sound

Options | CW | No sound

If checked, no CW sound will be played through the internal speaker. This option is also available through the **SOUND/NOSOUND** text commands.

This option is disabled by default since Win-Test Version 4.18.0 when Win-Test runs under an operating system after Vista included. It means that it will not work for those newer OS, and *may* work on previous OS, depending on the hardware. In all cases, it is very much recommended to rely on the radio's internal sidetone generator instead.

### Note for some new Laptops

In some new generation Laptops, it is necessary to enable the PC Speaker in the BIOS to have it to work properly.

Moreover, with some Sound systems, you have also to enable the PC Speaker in the "Volume Control". Here is how to do it:

- Double click on the Speaker icon in the system tray
- In the menu, select `Options | Properties`, and search for the PC Speaker Volume Control and enable it
- Set the Volume slider to the appropriate sound level

Unfortunately, some newer Laptops do not support the PC Speaker "beep" at all anymore... :(

## Initial Speed

Options | CW | Initial Speed

Sets the initial CW speed for new files.

## Modify standard messages...

Options | CW | Modify standard messages...

For quick access to this dialog, use the text command **MESSAGES** or **MSGS**.

The place to change the CW messages, both for Run and S&P mode. See [Enable Run/S&P Switching](#).



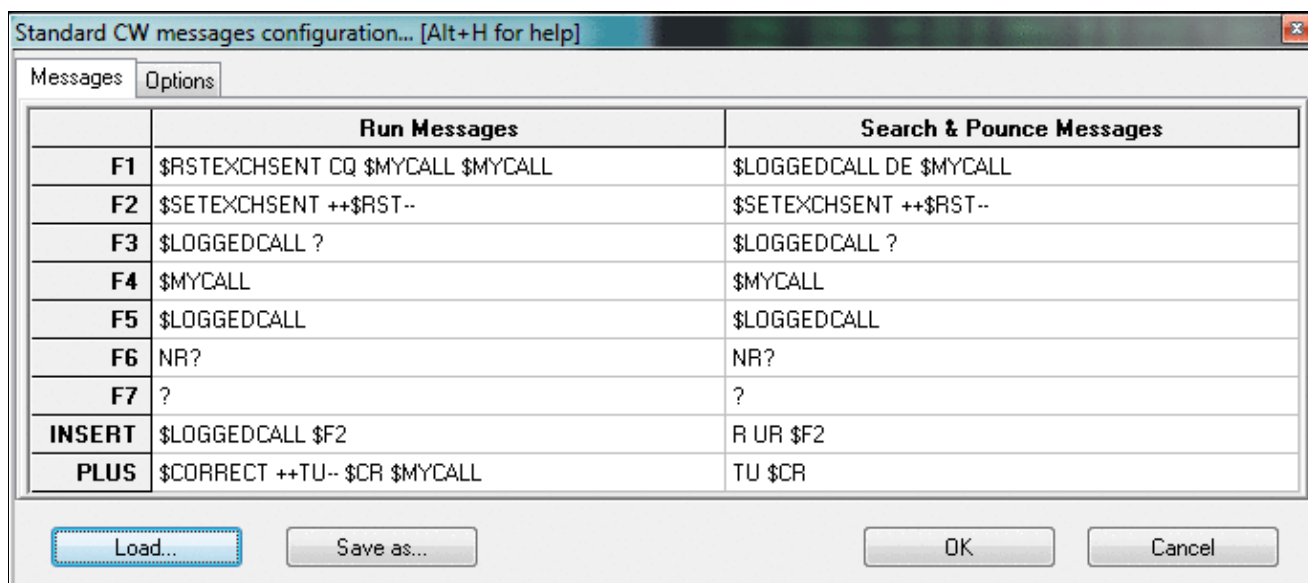

Modifying CW messages; you may also edit the memories one by one using **Shift+F1**, **Shift+F2** etc. Please have a look at the list of [message variables](#) you can use in the CW memories to control different aspects of the operation.

Since Win-Test version 4.20, messages can be saved and loaded from previous **\*.wt4** or special **\*.msg** files.

The Options tab of this window lets you redefine the \$QSOB4 macro. The only variable that can be used in this field is \$MYCALL, e.g. "QSO \$MYCALL TEST".

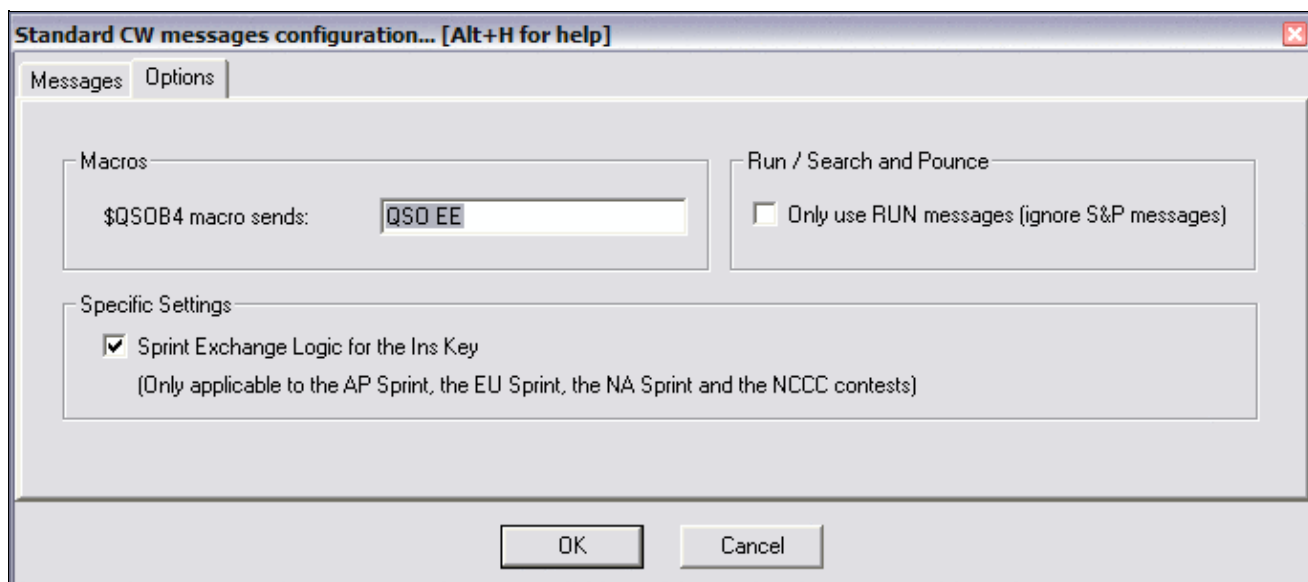

CW messages options.

Check **Only use RUN Messages (ignore S&P Messages)** to force Win-Test to use only one set of CW messages, regardless of operating mode.

### Sprint Exchange Logic

Use **Sprint Exchange Logic for the Insert key** to signal to a listening station that you will take over the frequency after a QSO, by signing your call at the end of the exchange. When checked, pressing **[Insert]** sends the "Run Message" if the logged serial number field is blank, otherwise it sends the "Search & Pounce Message". This option only applies to the Sprint contests. It is ignored for other contests, so it may be left checked all the time.

Here is example of how to set up the CW messages for the NA Sprint, with Sprint Exchange Logic enabled. Note the programming of the **[Insert]** message:

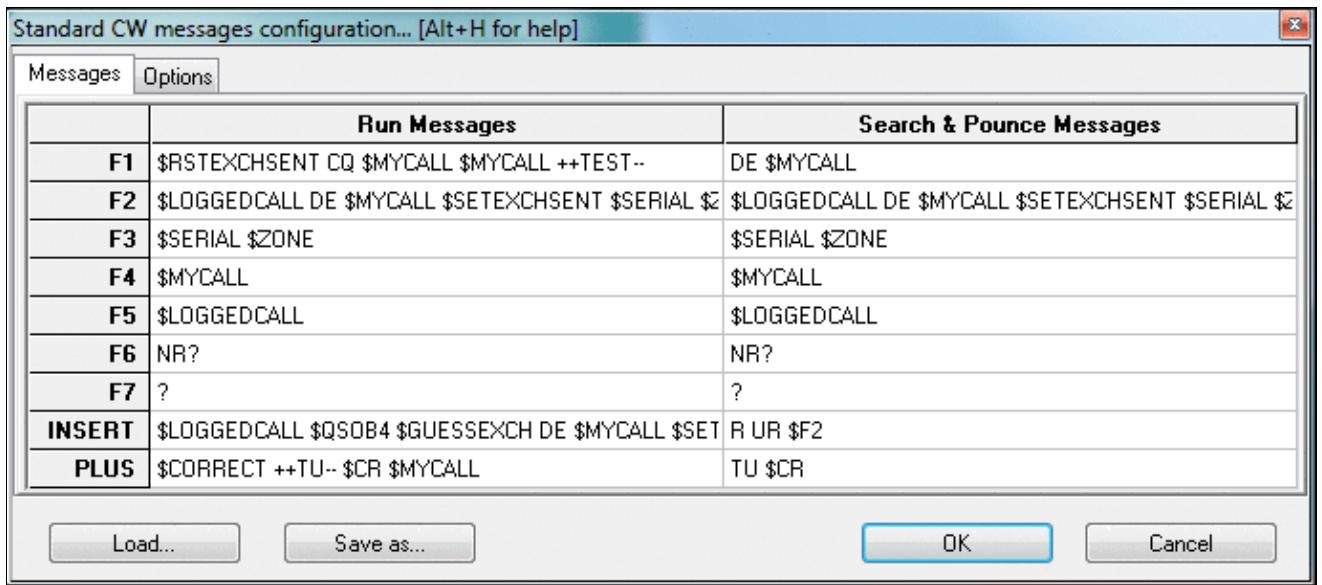

Sample CW messages to be used for the NA Sprint, with Sprint Exchange Logic

### Modify additional messages...

Options | CW | Modify additional messages...

The place to create or modify additional CW messages which can be accessed using **Alt-C**. These memories can be used for transmitting QSL information, special greetings, QSY/sked information. It also defines the macros \$MSG1 to \$MSG12 that may optionally be used as part of any standard CW message.

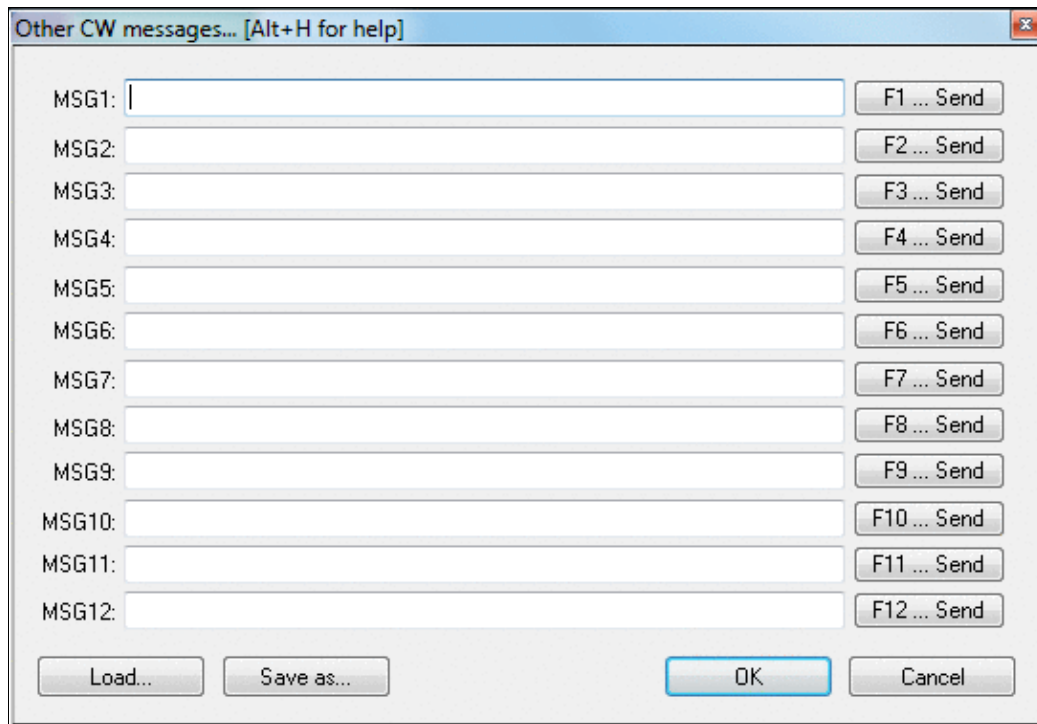

Additional CW messages that may be used occasionally like QSL info etc.

### Modify WAE messages...

Options | CW | Modify WAE messages...

This function allows you to define CW message text which is available during transmit/receive of QTC traffic. The QTC window is specific to the WAE DX Contest and can be opened using **ctrl-L** (transmit QTCs) or **Alt-L** (receive QTCs). For more details of WAEDC, please see [WAEDC](#).

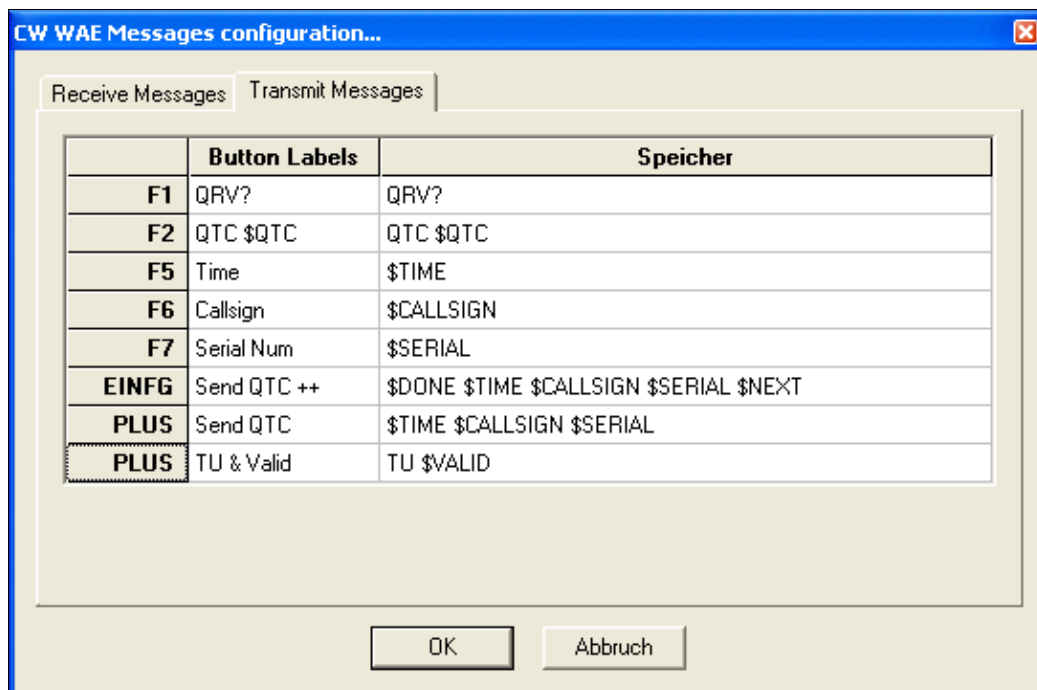

Additional messages (transmit) for QTC handling in the Worked All Europe DX Contest.

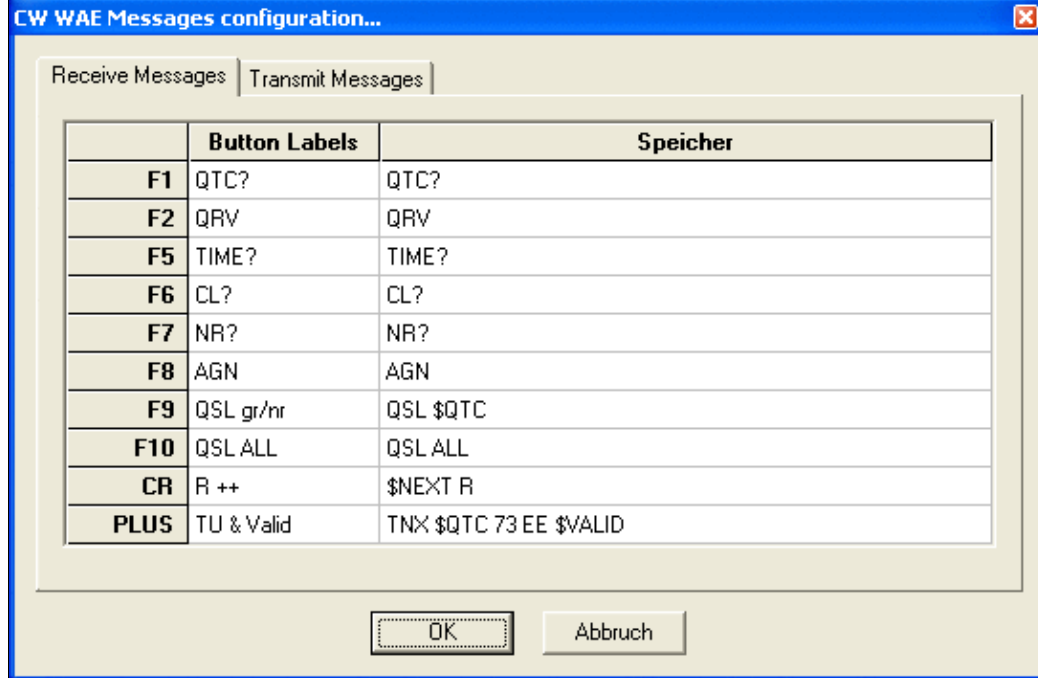

Additional messages (receive) for QTC handling in the Worked All Europe DX Contest.

### Custom variables...

Options | CW | Custom variables...

For quick access to this dialog, use the text command **VARIABLES**.

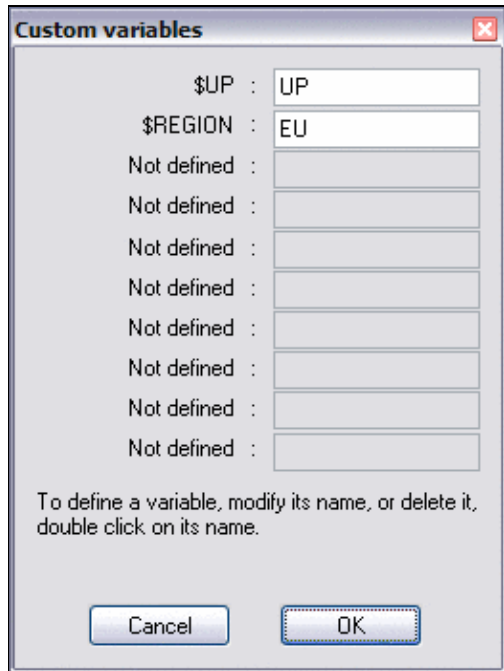

Custom message variables for DXpeditions or other purposes

Mainly useful for DXpeditions, this feature allows you to create custom variables to be used in CW or RTTY messages.

To define a new variable, double-click on the variable name or the words **Not defined**, and follow the prompts. All variables can be used in CW or RTTY messages, (one common set of custom variables is used regardless of mode).

For example, define [Plus] as

```
$CORRECT TU $MYCALL $REGION$UP $CR
```

then change the value of \$REGION as required by typing REGION [Enter] in the callsign field of the main logging window and following the prompts.

To rename a message variable, double-click on its name, and follow the prompts. To delete a message variable, rename it to an empty string.

**WARNING:** Don't try to add a variable name that is already used by Win-Test or it won't work.

## Serial number

Options | CW | Serial number

Equivalent text commands are **LZ**, **NOLZ**, **NOABBREV**, **SEMIABBREV**, **FULLABBREV** and **PROABBREV**.

**Leading zeros** - If checked, leading zeros for all serial numbers below 100 will be sent by Win-Test (text commands **LZ** and **NOLZ**)

**Spaced Digits** - When enabled, a half-space (^) is inserted between each digit of the serial, making it more readable at high speed.

There are 5 possible abbreviation levels for the serial numbers:

- **Not abbreviated** - all numbers are sent without any abbreviations or "cut numbers" (**NOABBREV**)
- **Half abbreviated** - only leading zeros are shortened to "T" (**SEMIABBREV**)
- **Abbreviated** - The 0 and the 9 are shortened to "T" and "N" (**FULLABBREV**)
- **Pro** - The 0, 1, 4, 5 and 9 are shortened to "T", "A", "V", "E" and "N" (**PROABBREV**)
- **Custom** - use the settings in the custom table. Each number can be shortened to a letter of your own choosing.

**Custom table...** - displays the dialog shown below:

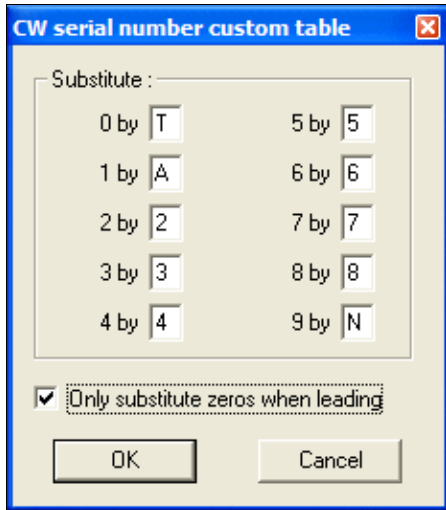

Customized abbreviations for sending CW serial numbers sent by Win-Test. 0, 1, and 9 are shortened to "T", "A", and "N", but only leading zeros are abbreviated.

This option only affects *serial numbers*, not numbers within callsigns.

## Correction

Options | CW | Correction

Equivalent to the [text commands](#) **CORRECT** and **NOCORRECT**.

Controls the value of the [\\$CORRECT message variable](#). When enabled, Win-Test automatically sends a call correction if the callsign sent ([\\$LOGGEDCALL](#)) by the [Ins] key is changed before you press [+] to log the QSO. This is most useful when the [+] key is programmed with **\$CORRECT TU \$MYCALL \$CR** or similar. **NOCORRECT** disables the feature.

When "Smart correction" is enabled ([text command](#): **SMART**), Win-Test resends only what needs to be sent (prefix, suffix, or full call). When disabled (**NOSMART**), Win-Test sends the full callsign for all corrections .

## Shortened spaces (CT spaces)

Options | CW | Shortened spaces (CT spaces)

Equivalent to the [text commands](#) **CTSPACE** and **NOCTSPACE**.

The standard spacing between CW words is 7 dits length, instead of 6 (known as "CT space"). With this option you can set it back to 6 dits if you want, achieving slightly shorter spacing between words.

## Auto sending...

Options | CW | Auto sending...

Equivalent to the [text commands](#) **CWAUTO**, **NOCWAUTO/CWAUTOOFF**, **CWAUTO3**, and **CWAUTO4**

This lets Win-Test automatically send the [Insert] message as soon as some number of characters are entered in the callsign field, eliminating the need to press the [Ins] key to send an exchange.

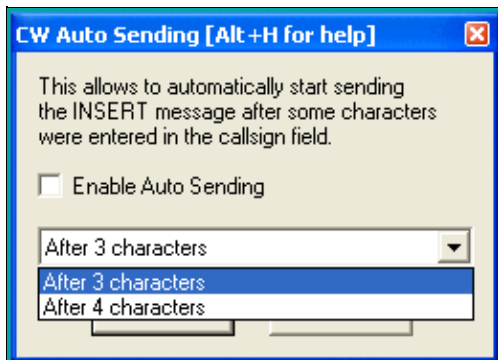

### Configuring Auto sending

When CW Auto Sending is enabled, if the cursor is in the callsign field, hitting **[Escape]** will disable Auto Sending for the current QSO if no CW is being transmitted. When you hit **[Escape]** during transmit, or when the cursor is not in the callsign field, it stops the current CW transmission, but does not disable the CW Auto Sending setting.

Detail: If there is a slash character in the callsign, the triggering starts after the slash.

## Remap keys in keyboard mode

Options | CW | Remap keys in keyboard mode

If you have remapped certain keys using the [Redefine keyboard keys](#) dialog or the **DEFINEKEYS** text command, these mappings are ignored when in [keyboard mode](#) **[Alt-K]**. So for example, if you have redefined the backslash key **[\]** to send your callsign, or the semicolon key **[ ; ]** as an alternative to the plus key **[+]**, those keys will not work the same when you are in keyboard mode. Check this option to have these remapped keys work consistently, whether you are in keyboard mode or not.

## Work dupes

Options | CW | Work dupes

CW and RTTY option to work dupes or not. If dupes are worked, the \$QSOB4 variable is ignored. The equivalent text commands are **WORKDUPE/NOWORKDUPE** or **WORKDUPEON/WORKDUPEOFF**. There is a different setting available per mode (CW or RTTY).

## Speed bursts

Options | CW | Speed bursts

CW option to enable/disable the speed bursts (+/-) without modifying the messages. Text commands are **BURSTS/NOBURSTS**. Useful to defeat CW skimmers on-demand.

## RTTY

Options | RTTY

This menu item allows you to setup the standard and additional messages for RTTY operation. It is enabled only when the selected operating mode is RTTY. (otherwise it is greyed out)

## Modify standard messages...

Options | RTTY | Modify standard messages...  
 The place to change the RTTY messages.

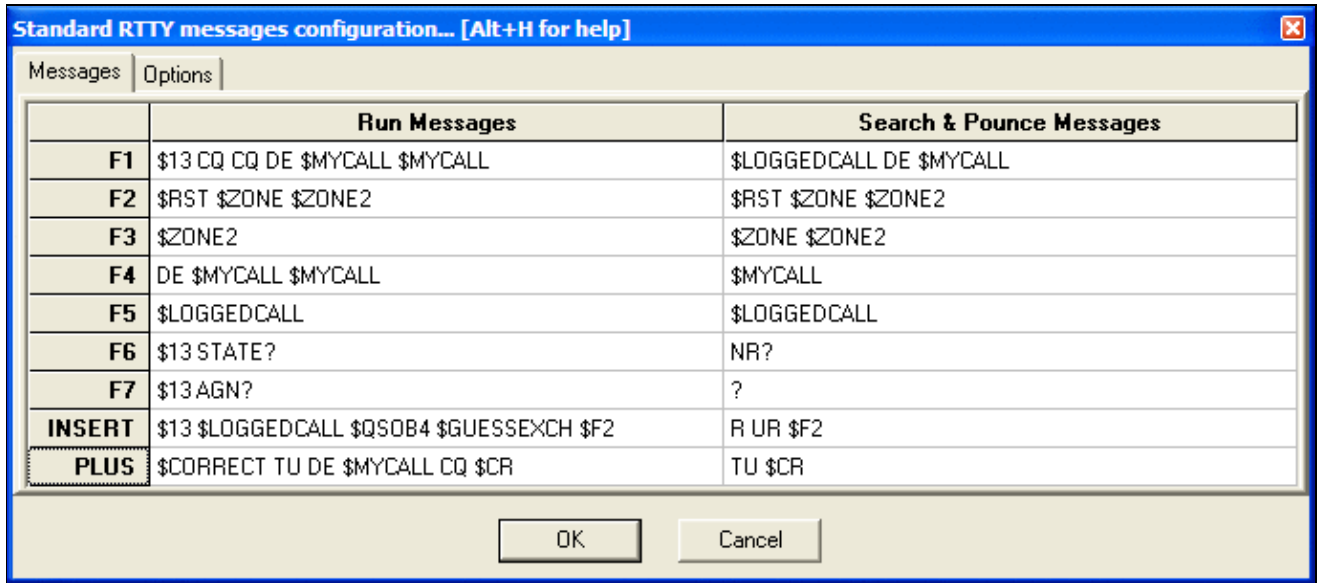

Modifying RTTY standard messages; you may also edit them one by one using **Shift+F1**, **Shift+F2** etc. Please have a look at the list of [Message Variables](#) you can use in the RTTY memories to control different aspects of the operation.

The Options tab of this window lets you redefine the \$QSOB4 macro. The only variable that can be used in this field is \$MYCALL, e.g. "QSO QRZ \$MYCALL".

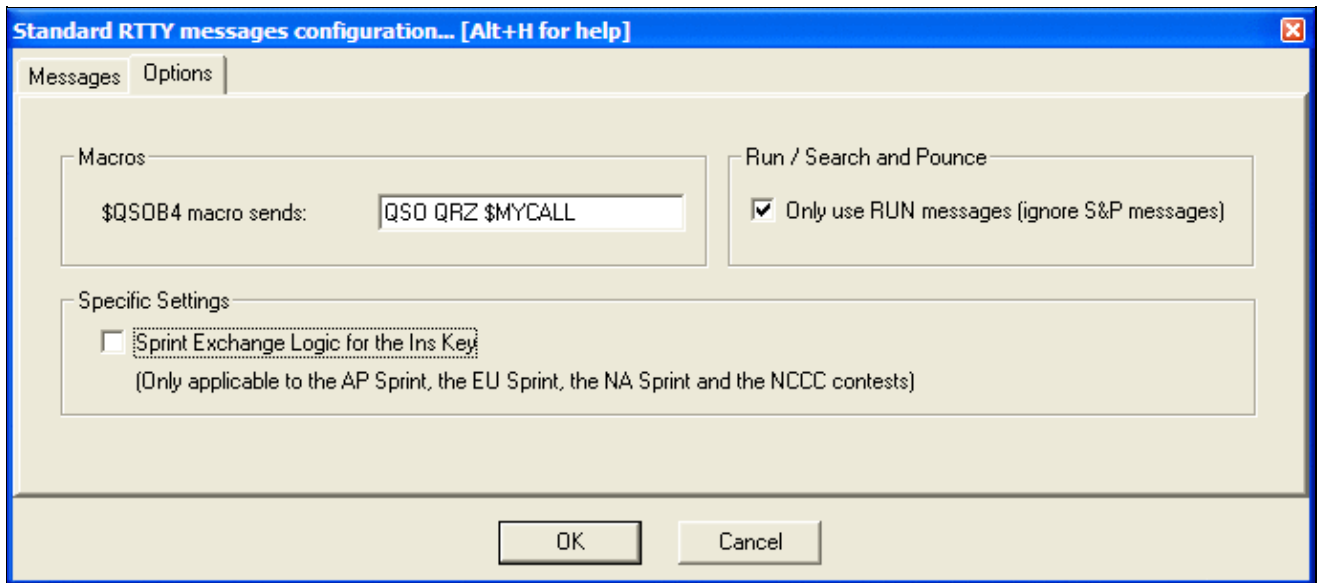



RTTY messages options.

Check **Only use RUN Messages (ignore S&P Messages)** to force Win-Test to use only one set of RTTY messages, regardless of operating mode.

## Modify additional messages...

Options | RTTY | Modify additional messages...

The place to create or modify additional RTTY messages which can be accessed using **Alt-C**. These memories can be used for transmitting QSL information, special greetings, QSY/sked information, ...

Field	Content	Action
F1:	TU 73 GL - QRZ DE \$MYCALL	Send
F2:		Send
F3:		Send
F4:		Send
F5:		Send
F6:		Send
F7:		Send
F8:		Send
F9:		Send
F10:		Send
F11:		Send
F12:		Send

Close Cancel

Additional RTTY messages that may be used occasionally like QSL info, greetings, etc. [Message Variables](#) can also be used within these additional messages.

## Modify WAE messages...

Options | RTTY | Modify WAE messages...

This function allows you to define RTTY message texts which are available during transmit/receive of QTC traffic. The QTC window is specific to the WAE DX Contest and can be opened using **Ctrl-L** (transmit QTCs) or **Alt-L** (receive QTCs). For more details of WAEDC, please see [WAEDC](#).

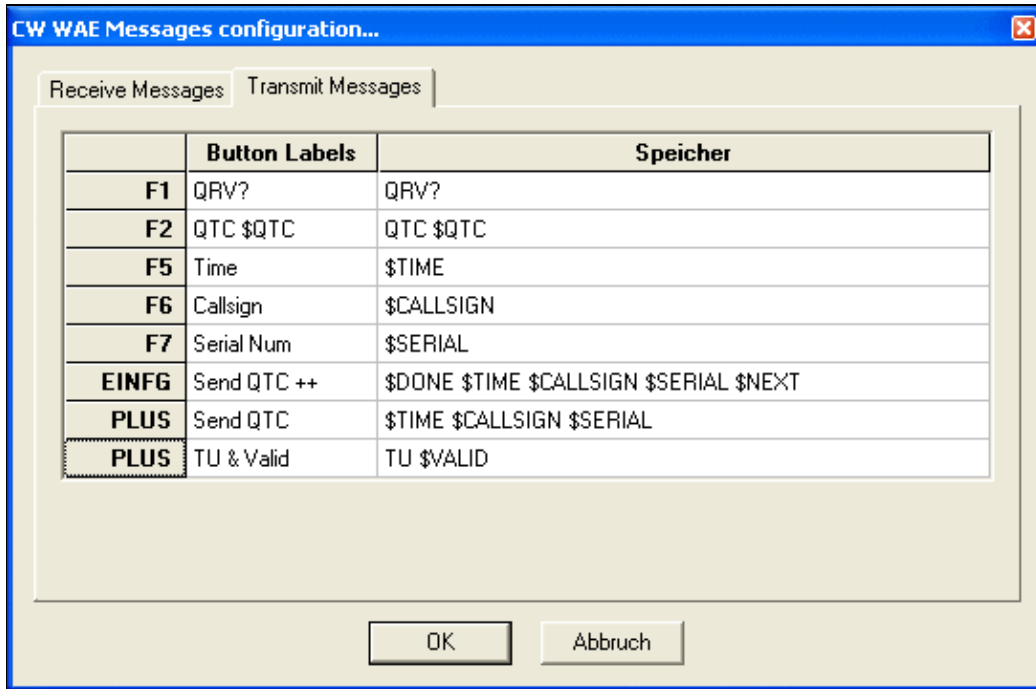

Additional messages (transmit) for QTC handling in the Worked All Europe DX Contest.

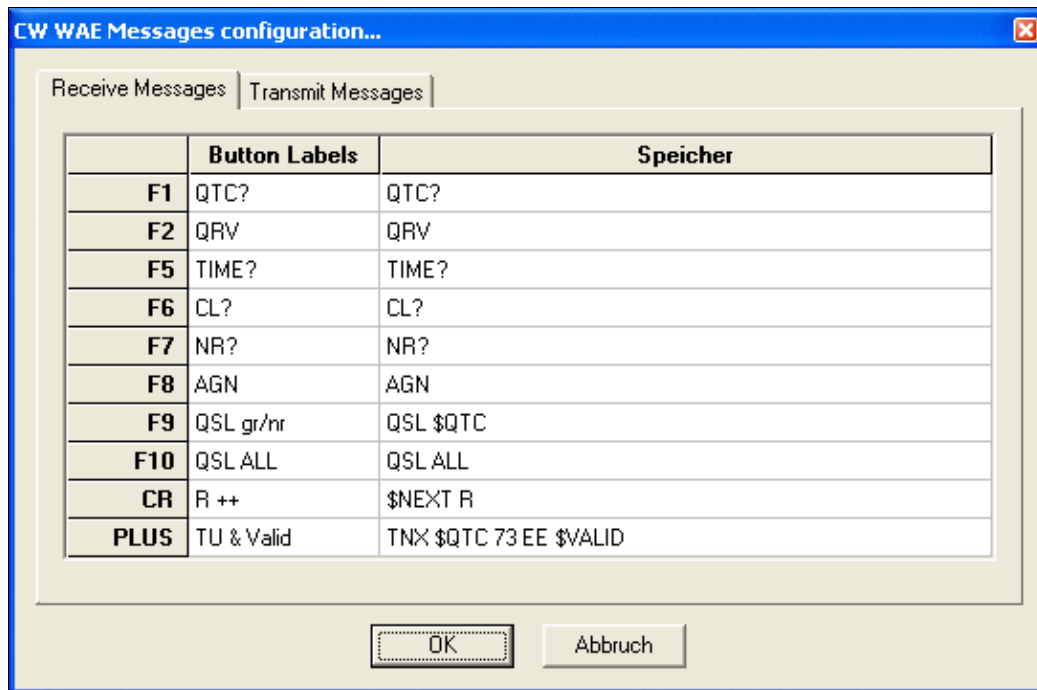

Additional messages (receive) for QTC handling in the Worked All Europe DX Contest.

## Custom variables...

Options | RTTY | Custom variables...

For quick access to this dialog, use the text command **VARIABLES**.

See Options | CW | Custom variables...

## Configure interfaces...

Options | Configure interfaces...

For quick access to this dialog, use the text command **SETUP**.

All the interfaces you wish to use with Win-Test can be parametered by using this dialog box.

**Interfaces configuration...**

**Serial ports**

<input type="checkbox"/>	COM1	Network	19200 8-N-1	Configure...
<input type="checkbox"/>	COM2	Network	19200 8-N-1	Configure...
<input type="checkbox"/>	COM3	Network	9600 8-N-1	Configure...
<input type="checkbox"/>	COM4	Network	19200 8-N-1	Configure...
<input checked="" type="checkbox"/>	COM5	Radio 1	4800 8-N-1	Configure...
<input checked="" type="checkbox"/>	COM6	Other interface...	9600 8-N-1 CW PTT	Configure...
<input type="checkbox"/>	COM7	Network	19200 8-N-1	Configure...
<input type="checkbox"/>	COM8	Network	19200 8-N-1	Configure...
<input type="checkbox"/>	COM9	Network	19200 8-N-1	Configure...
<input type="checkbox"/>	COM10	Network	19200 8-N-1	Configure...
<input type="checkbox"/>	COM11	Network	19200 8-N-1	Configure...
<input type="checkbox"/>	COM12	Network	19200 8-N-1	Configure...

**Printer ports**

LPT Configure...

**CW**

PTT ON delay (ms):

**Ethernet**

Enable ethernet network

Broadcast address:  By default

Port number:  By default

**Network protocol**

Advanced settings...

**Voice keyer**

Enable sound card

▼

Mute the microphone input when the DVK is playing

Mute the microphone input when the DVK is not playing

**Transceivers**

Radio 1:  ▼  Don't poll  Use CI-V Transceive Polling rate (ms):  ▼

Radio 2:  ▼  Don't poll  Use CI-V Transceive Polling rate (ms):  ▼

OK Cancel

## Interface Configuration

**Serial Ports**

The serial ports can be used for an RS-232 network (rarely used now), for a connection to a packet radio controller (also rarely used), for CW or PTT on/off keying output, for headphone audio control, for SO2R active radio control, or for an RS-232 (serial) radio, amplifier, SO2R box, or Winkey interface.

If using a radio or amplifier interface, you must first specify what model you are using. Press the **Default Settings** button to configure all serial port settings to the standard defaults for the selected radio model or Winkey (highly recommended).

If using an SO2R box, you can control it via serial commands (device type = microHAM, EZMaster, or OTRSP), or you can set the device type to "Other device" and use on/off activation of the DTR and RTS pins to control the SO2R box via "Classic Auto Control" hardware instead of via software commands.

Use the serial port configuration dialog to select the appropriate settings:

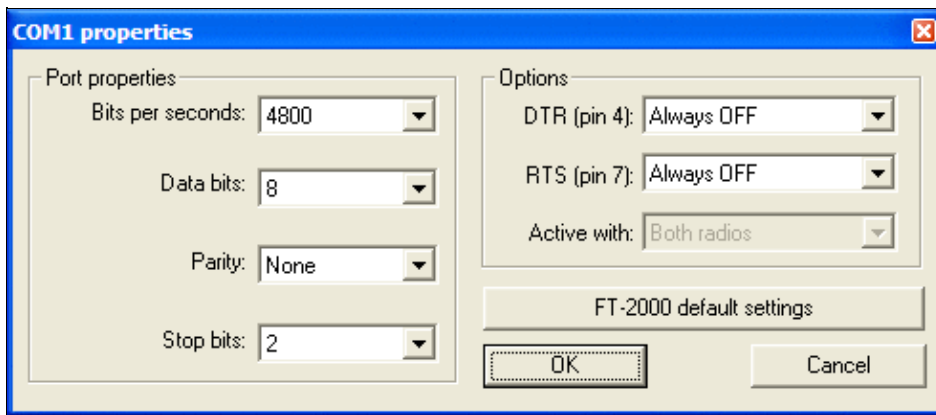

## Serial port configuration

The **DTR** (pin 4) and **RTS** (pin 7) options are:

- Handshake - RS-232 hardware handshake, supported by some radios
- CW - For on/off CW keying of Radio 1, Radio 2, or both, similar to LPT port CW keying. The convention is to use for DTR for CW and RTS (optionally) for PTT.
- PTT - For activating PTT on Radio 1, Radio 2, or both, when a CW or internal DVK message is sent.
- Always ON - Pin is always set "high" (required by some USB-to-Serial adapters and radios)
- Always OFF - Pin is always set "low"
- Active radio - Pin is connected to an SO2R box "Swap TX radio" line.
- Stereo RX Audio - Pin is connected to an SO2R box "Stereo on/off" line.
- Headphone control - Pin is connected to an SO2R box "Swap RX radio" line.

The **Active with** option is only available when PTT or CW is selected for DTR or RTS, otherwise it is grayed out.

- Radio 1 - PTT and CW is only sent when Radio 1 is active
- Radio 2 - PTT and CW is only sent when Radio 2 is active
- Both radios - PTT and CW is sent when either radio is active (external steering via SO2R box required)

**Note:** The pin numbering applies to a standard DB9 connector.

## Transceivers

This region of the interfaces configuration window lets you select the type of transceiver for radio 1 and 2 plus various settings like polling, polling rate (actually, delay before polling the radio again after the previous sequence) and if the ICOM specific CI-V feature is to be used or not. By the way, when you use an ICOM radio with an address different from factory settings, please see [WT.INI](#)

## Printer Ports

A parallel port can be used to send CW and other signals from Win-Test via [legacy keying interfaces](#), or the microHAM MK2R/MK2R+ operating in "Classic Auto Control" mode. Press [**Configure . . .**] to display the following dialog box:

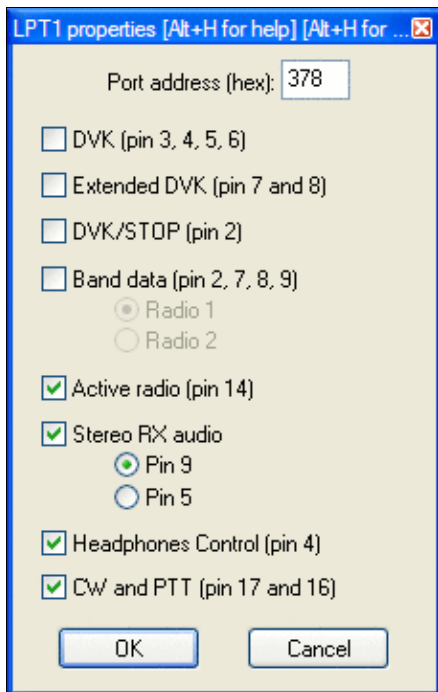

Parallel port configuration showing pin 14 used for TX Radio, Pin 9 for Stereo On/Off, and Pin 4 for RX Radio, Pin 17 for CW, and Pin 16 for PTT

Specify the address of your printer port in hex. Common values are **378** and **3BC**. To determine the address used by your printer port, open the Windows Device Manager (Start, Control Panel, System, Hardware tab, Device Manager; or Start, Run, **devmgmt.msc**). Select Ports (COM & LPT), Printer Port (LPT1), Right Click, Properties, and finally, click the Resources Tab. You will see **I/O range 0378 - 037A** or similar. Use the first address as your port address. If you do not specify the correct port address, Win-Test will appear to operate normally, but it will not key the radio at all.

## CW

PTT ON Delay specifies the time delay between first PTT closure and first CW output. When using an amplifier with a slow relay, this setting allows you to close the relay line well before RF is applied, which prevents the first dot or dash sent by Win-Test from being truncated. The delay between the PTT command and the effective CW transmission is adjustable between 0 (for QSK amps) to 1000 ms.

## Local Network

The Local Network interface is used to define Win-Test's local area network in a multi-operating environment. If needed, you can change the broadcast address and the port number used. If you ignore the meaning of these terms, note that there should normally be no need to modify the default values given by Win-Test. See [Networking](#) for more information.

## Network Protocol Advanced Settings

Under the Network Protocol Advanced Settings dialog you will find a way to restrict network traffic in very specific ways. **CAUTION:** Modifications to the default settings must be done with extreme care. It is intended for very particular configurations and purposes, mainly used by expert users. You are on your own!

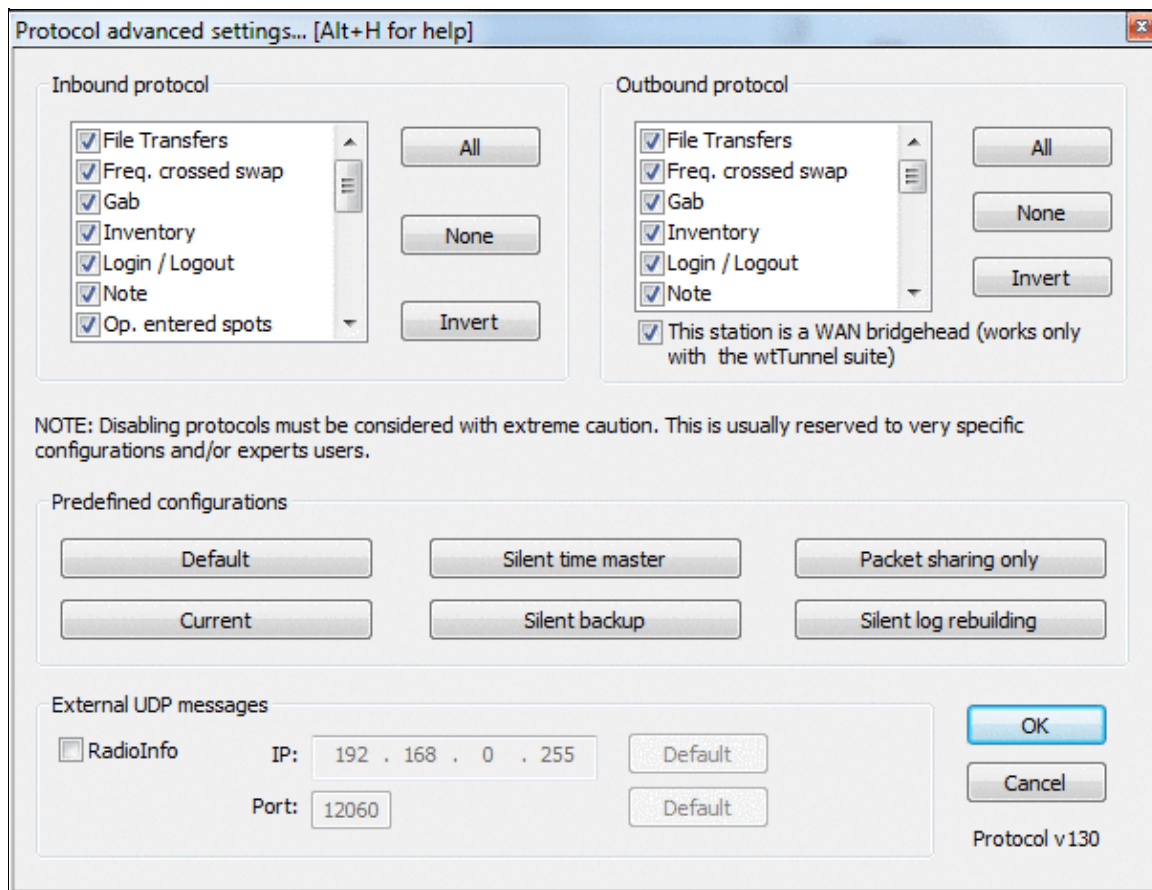

Network Protocol Advanced Settings allows you to fine-tune your network traffic. Network protocol version displayed in the right bottom corner.

Some pre-set typical configurations are available:

- **Silent time master:** Can be used if the computer is used *only* to distribute an accurate clock. This PC will not appear in the status window of any other networked computer. Note that with this setting, no QSOs will be recorded on (or sent from) any machine with this setting.
- **Silent backup:** Can be used if the computer is *only* used for backup purposes. This PC will not appear in the status window of any other networked computer.
- **Packet sharing only:** Can be used if stations are networked with different callsigns, and do not want a common log, but do want to share a common packet stream. It can be used for several co-located single-op stations on VHF/UHF, for example.
- **Silent log rebuilding:** Can be used if you need to rebuild from scratch a complete log from networked stations, without appearing in the status window of any other networked computer.

Note that in all settings, the station will still be visible in the network via the **INVENTORY** command.

[x] This station is a WAN bridgehead

This feature only works with the wtTunnel suite. To respect multi-op ethics, the wtTunnel package is *only* available for headquarters stations during the IARU HF contest. Check this box to restrict the synchronization



of QSO inventories to the local network to reduce network traffic when stations are at different sites on a wide area network (WAN).

See [The Bridgehead Concept](#) for further details.

To control external interfaces by UDP, Outbound RadioInfo external UDP messages capability was added, to allow using additional programs or devices. Already tested with the RF2K-S SSPA (see <https://www.rf-kit.de>).

## Voice Keyer

At last, if your computer has an embedded sound card, you can select and use it as a digital voice keyer by checking the appropriate box.

If you want to use a third-party software to record or modify voice messages, be sure to use the following file format : WAV, PCM, 8000 Hz sampling frequency, 1 channel (mono) and 16 bits per sample.

## WinKey configuration...

Options | Winkey configuration...

For quick access to this dialog, use the [text command](#) **WKSETUP**.

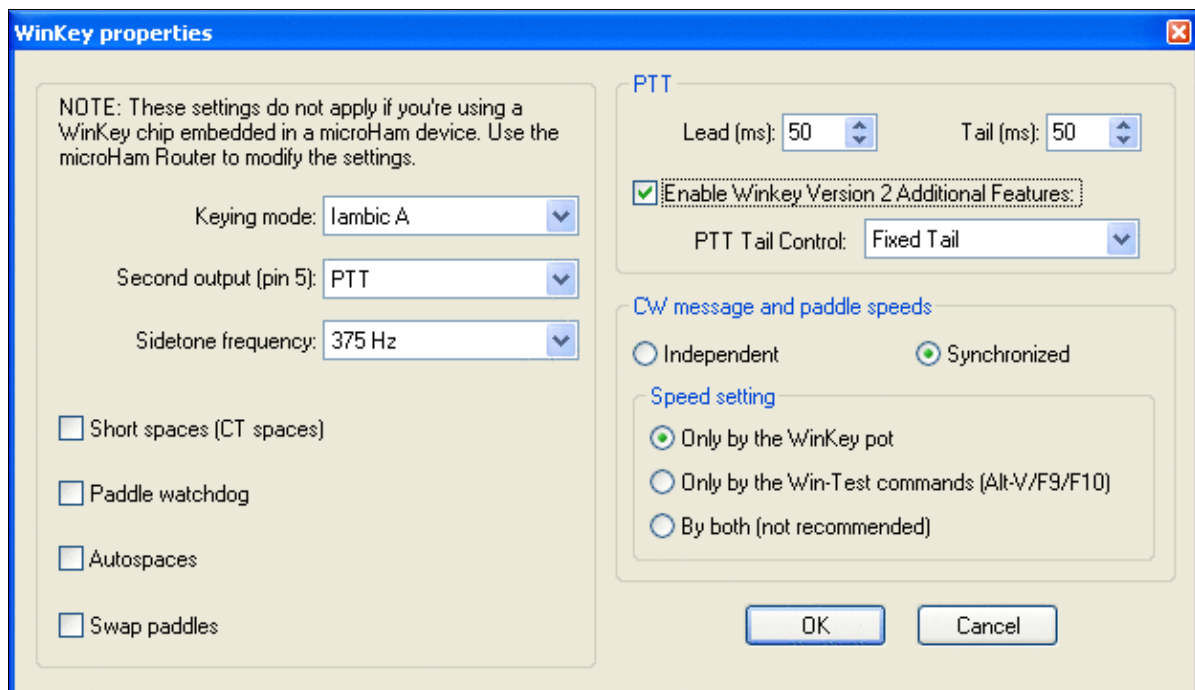

## Configuring the WinKey properties

- **Keying mode:**
  - ◆ **Iambic A** - Curtis A iambic timing
  - ◆ **Iambic B** - Curtis B iambic timing
  - ◆ **Ultimatic** - Non iambic mode
  - ◆ **Bug (semi-automatic)** - WinKey makes the dits and you make the dahs

In either iambic mode, alternating dits and dahs are sent while both paddles are held closed. In mode B, an extra alternate dit or dah is sent after both paddles are released. In Ultimatic mode, when both paddles are pressed, the keyer will send a continuous stream of whichever paddle was last pressed.

- **Second Output (pin 5)** (WinKey only, ignored by WinKey2 chip)
  - ◆ **PTT** - WinKey pin 5 acts as a PTT line
  - ◆ **Sidetone frequency** - WinKey pin 5 acts as a sidetone output
  - ◆ **Radio 2** - WinKey pin 5 keys a second radio
- **Sidetone Frequency** - sets WinKey oscillator sidetone on pin 5 (ignored by WinKey2 chip)
- **Short spaces (CT spaces)** - WinKey generates a 6-baud word space instead of a 7-baud space (1 baud = length of one dit)
- **Paddle watchdog** - disable the key output after 128 consecutive dits or dahs. This is to guard against the paddles being accidentally keyed continuously by your cat.
- **Autospaces** - If you pause for more than one dit time between a dit or dah, Winkey will interpret this as a letter-space and will not send the next dit or dah until a full letter-space time (3 dits) has passed
- **Swap paddles** - reverse the dit/dah paddles (e.g. for keying with the left hand)
- **PTT**
  - ◆ **PTT Lead(ms)** specify PTT lead (switch to transmit before CW begins)
  - ◆ **PTT Tail(ms)** specify PTT tail (keep transmitter up after CW has finished)
  - ◆ V2 of WinKey provides additional features:
    - ◇ PTT tail control (fixed, 1.00 letter space, 1.33, 1.66, 2.00)
- **CW Message and paddle speeds**
  - ◆ **Independent** - CW speed sent by the paddle is controlled by the WinKey speed knob, and CW speed set by Win-Test is controlled independently by the Win-Test keyboard commands (**[Alt-F9]**, **[Alt-F10]**, and **[Alt-V]**). In addition, both CW speeds will be displayed at the bottom of the Rate Window.
  - ◆ **Synchronized** - Win-Test will keep the CW speed synchronized, whether sent by paddles or by Win-Test
    - ◇ **Only by WinKey pot** - Only the WinKey speed knob will control CW speed; Win-Test speed commands sent via the keyboard are ignored.
    - ◇ **Only by the Win-Test commands (Alt-V/F9/F10)** - The WinKey speed knob is ignored and CW speed changes may only be controlled by the Win-Test keyboard commands (**[Alt-F9]**, **[Alt-F10]**, and **[Alt-V]**).
    - ◇ **By both (not recommended)** - CW speed may be controlled by either the WinKey speed knob or by Win-Test keyboard commands, but this setting is not recommended as there is no way to automatically turn the WinKey speed knob to match the CW speed set by Win-Test.

## EZMaster configuration...

Options | EZMaster configuration...

For quick access to this dialog, use the text command **EZSETUP**.

## Win-Test Wiki

Advanced SO2R mode and setting up scenarios requires external SO2R control equipment of the last generation, communicating with Win-Test via a USB port.

This menu option enables the user to configure five different option for EZMaster to work with Win-test:

### **CW Keyer**

Internal EZMaster CW Keyer (tick Enable WinKey Box) or Win-Test keyer (do not tick box).

### **Radio set-up**

In the image below find configuration for FT1000MP

### **Packet-Radio TNC**

### **Antenna configuration according to RX/TX**

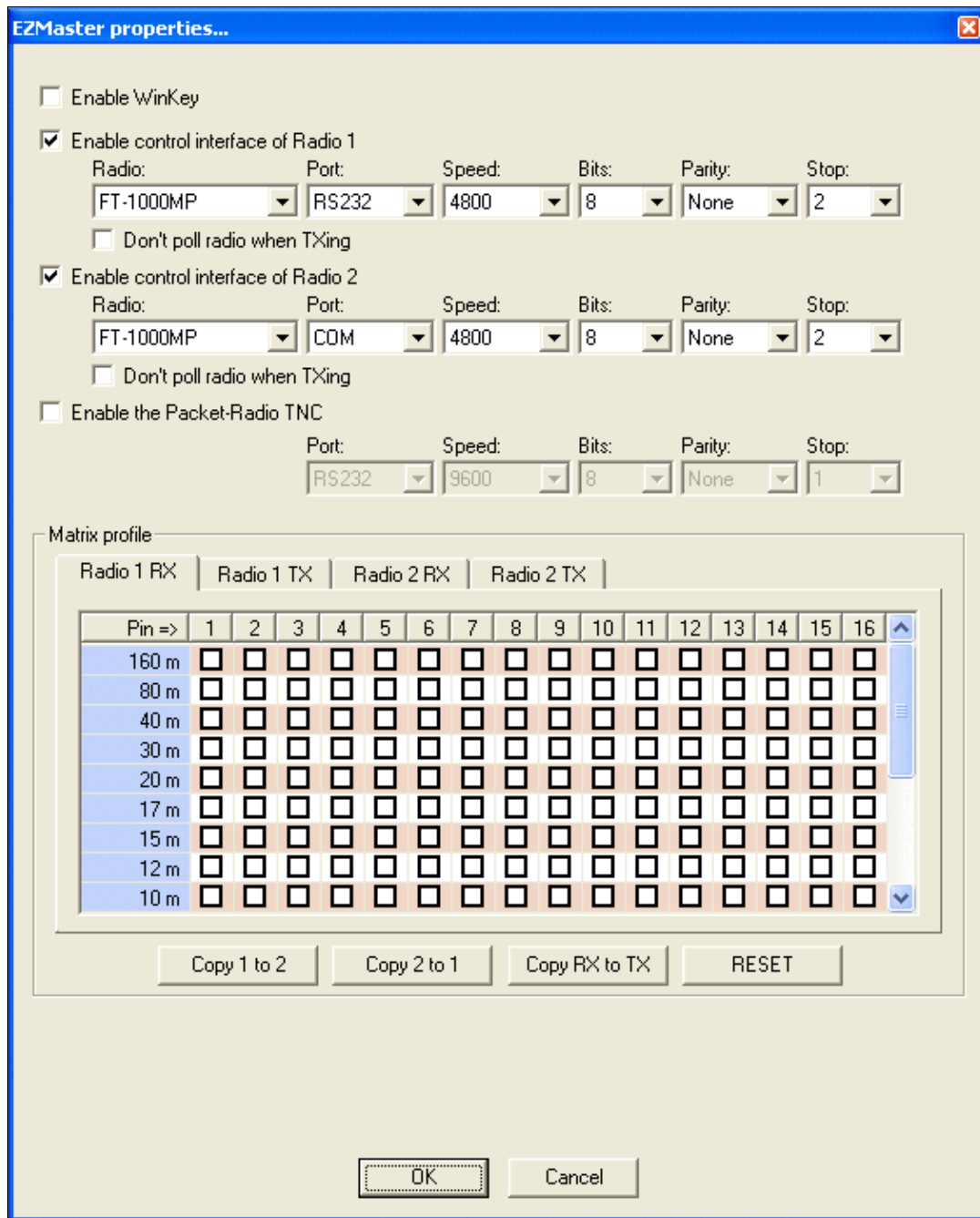

EZMaster configuration window

## MK/MKII/MK2R/u2R configuration...

Options | MK/MKII/MK2R/u2R configuration...

For quick access to this dialog, use the [text command](#) **MKSETUP**.

This option allows you to configure the microHAM devices microHAM Keyer, microHAM Keyer 2 and MK2R SO2R device. It lets you select if the microHAM protocol should be used for communication with the device. Moreover, you can specify, which pins on the ACC connected of the device will be activated, when the radio1 or radio 2 is tuned to a specific band.

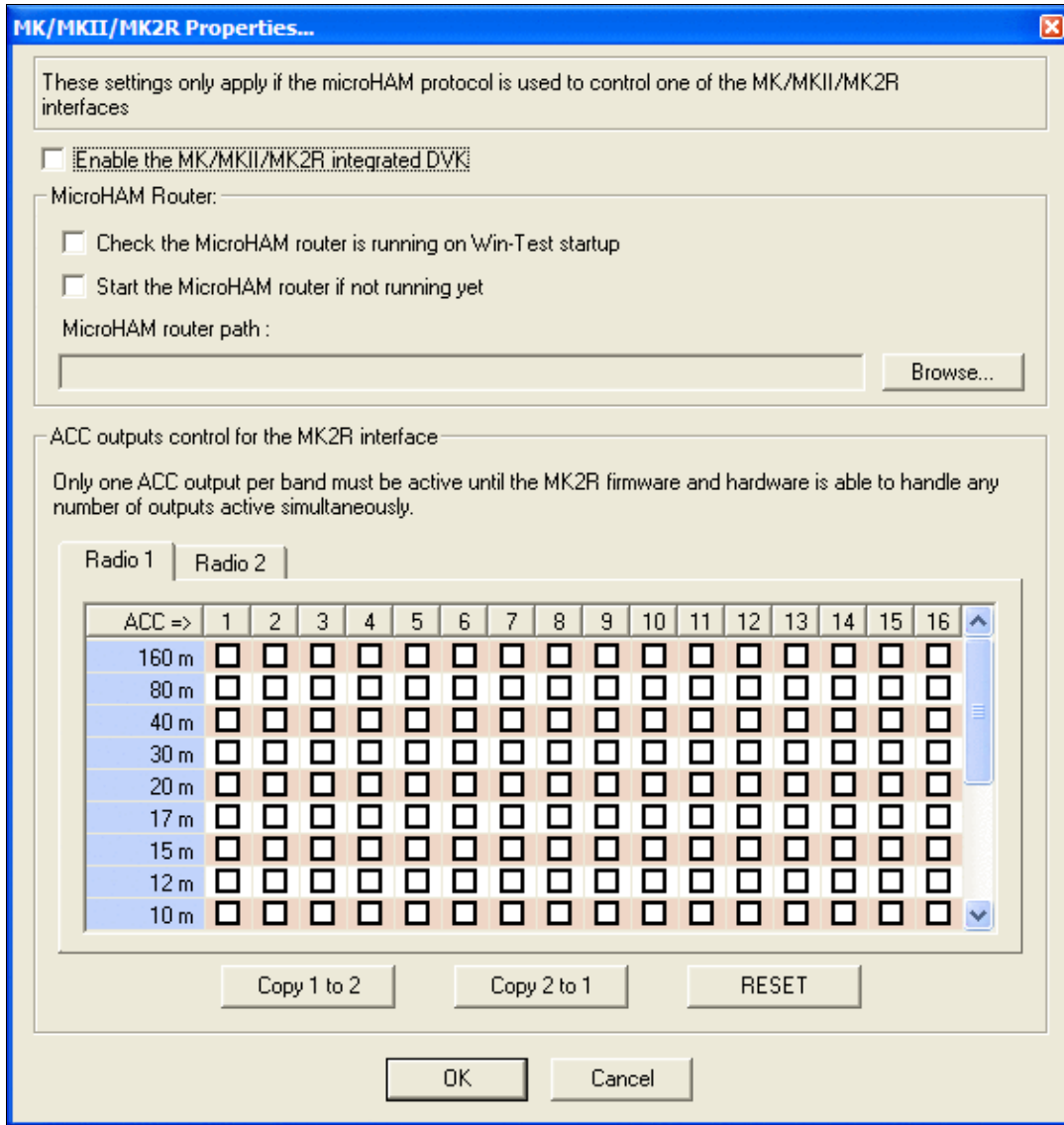

microHAM MK, MKII and MK2R configuration window

When an attached footswitch is used, two dedicated Lua scripts named **onMicrohamFsOn.wts** and **onMicrohamFsOff.wts** (not case-sensitive) are called. **wtArg** is set the radio number of the footswitch (0 for MK/MKII - 0 or 1 for MK2R/MK2R+/u2R depending on the footswitch that generated the event).

## OTRSP configuration...

Options | OTRSP configuration...

This option allows you to set up an Open Two Radio Switching Protocol (OTRSP) compatible device like the YCCC SO2R Box (for more information, visit <http://www.k1xm.org/OTRSP>).

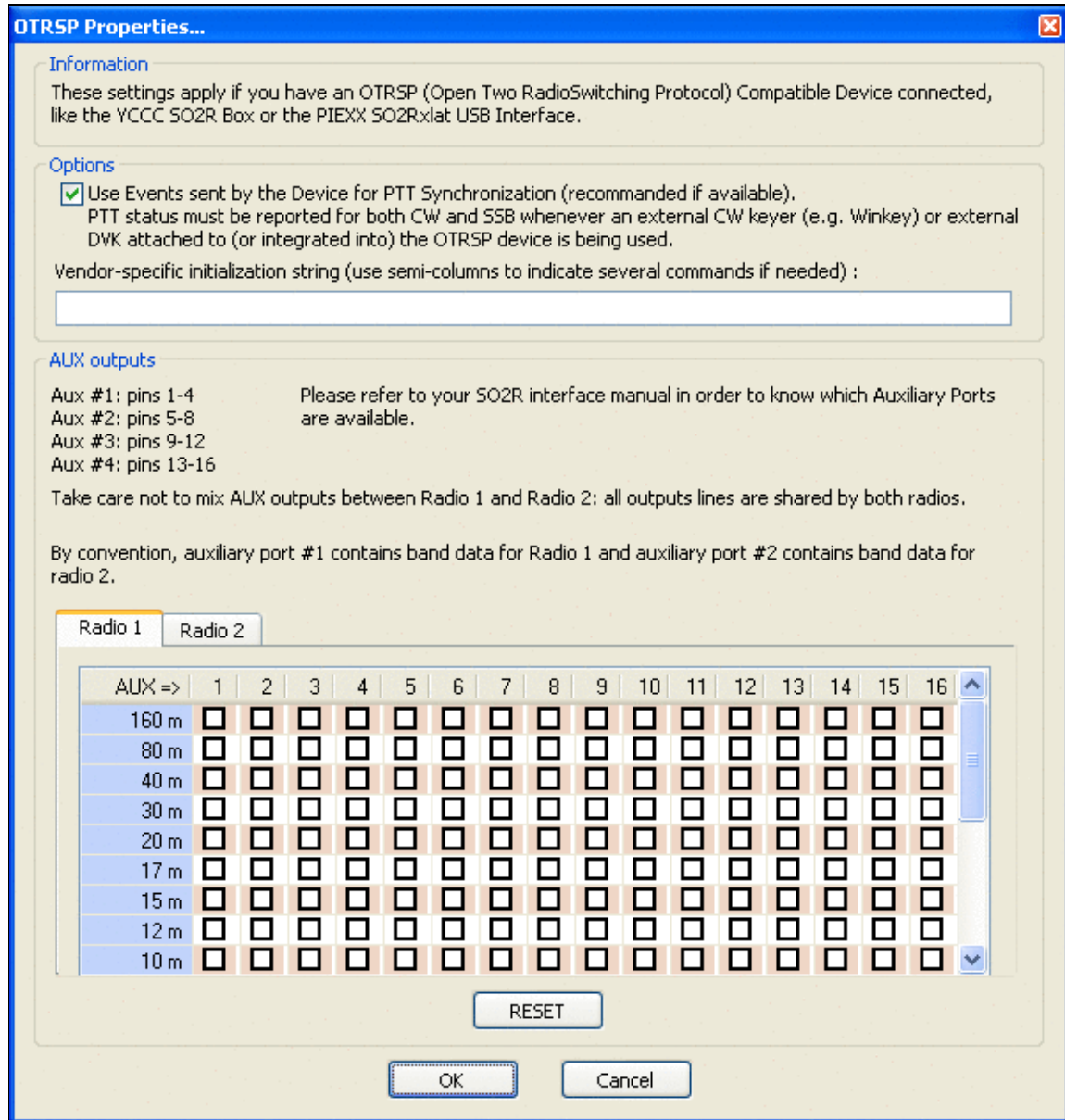

## OTRSP configuration window

If the OTRSP device has controls and if they can generate events, dedicated Lua scripts are called when events occur :

- **onOtrspCrOn.wts** and **onOtrspCrOff.wts** (not case-sensitive) are called when such a control has values 1 and 0 respectively. **wtArg** is set to the control number (0 to 9).
- **onOtrspCrEvent.wts** (not case-sensitive) is called for all states of the events. **wtArg** is set to  $(256 * cr) + state$  ( $cr = control\ number - 1$  to 9, and  $state = value\ of\ the\ state\ when\ the\ event\ occurred - 0$  to 255).

**Note:** If the PTT events are used, the control 0 is restricted to this usage, and doesn't fire the onOtrspCrOn/Off/Event.wts scripts. If the PTT events are not used, onOtrspCrEvent is not called when an event on this control occurs. Only the onOtrspCrOn/Off scripts are executed in this case.

## RTTY configuration...

Options | RTTY configuration...

For quick access to this dialog, use the text command **RTTYSETUP**.

This menu entry opens the control box for RTTY configuration.

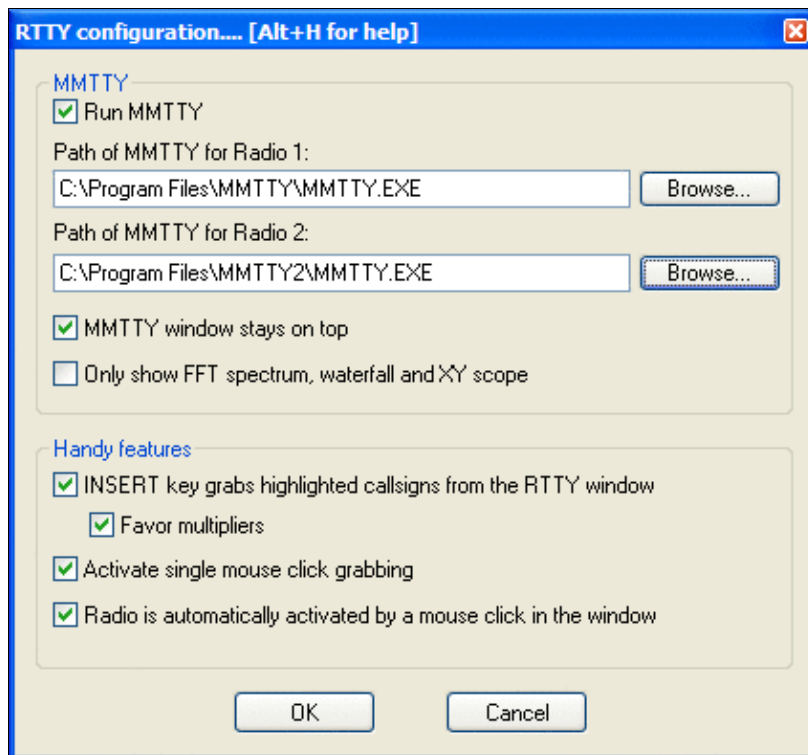

## RTTY Configuration Box

Please refer to the [RTTY chapter](#) for all the details.

## Frequency Offsets

This function is mainly used for a VHF/UHF/SHF setup involving a transverter. An HF radio tuned on 28 MHz is used as the user front-end which drives the transverter for 144 MHz or 432 MHz. Or a 144 MHz transceiver is used to drive a transverter to 5.7 and 10 GHz.

The point is that Win-Test only sees the frequency of the front-end. For example it would find the radio tuned to 28 MHz and simply ignore its frequency read-out when set up for a VHF/UHF contest. Likewise, the radio would ignore commands to tune to 144.054 from Win-Test because it is a HF transceiver that only knows 1.8-30 MHz. This is where the frequency offset feature comes in handy. It allows you to specify a frequency (in kHz) that will be added to any frequency read from the radio and subtracted from any frequency command that goes to the radio.

In other words, assume the frequency offset is set at 116000 kHz. The radio is tuned to 28054 kHz. Now Win-Test "sees" the radio at 144054 kHz, because the offset is added. Likewise, when the user clicks on a packet spot on 144088, Win-Test sends the radio to 28088 because the offset is subtracted.

This way, Win-Test gives you great flexibility to enter one offset per band per radio.

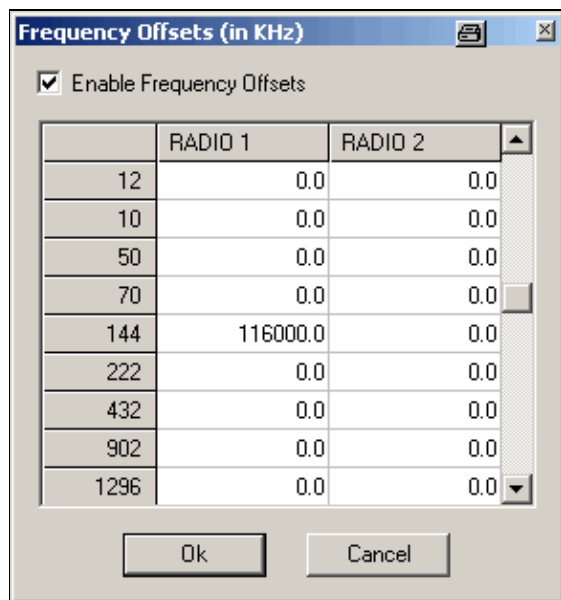



Frequency Offset allows you to use a transverter with Win-Test  
Text commands **OFFSETSETUP** (or **OFFSETSSETUP**) to open the dialog and. **OFFSET/NOOFFSET**, **OFFSETS/NOOFFSETS**, **OFFSETON/OFFSETOFF**, **OFFSETSON/OFFSETSOFF** to enable/disable the frequency offset.

## MP3 Configuration

Options | MP3 Configuration

For quick access to this dialog, use the text command **MP3SETUP**.

Allows you to select the sound device used for recording and playback in use with the contest recorder. You must have installed a MP3 ACM Codec (e.g. LAME, Fraunhofer). The encoder is not part of the Win-Test distribution.

Download LAME from [http://www.free-codecs.com/LAME\\_ACM\\_Codec\\_download.htm](http://www.free-codecs.com/LAME_ACM_Codec_download.htm). The version which worked at the time of this writing was 3.99.5. Follow instructions in the ZIP-File. With WinXP it used to work as described in <http://lists.f5mzn.org/pipermail/support/2010-January/079240.html>.

For Windows 7 and Windows 10, the important point is to run the installation a CMD window explicitly executed as Administrator.

Assuming, you have downloaded and unpacked the LAME ACM version to the directory C:\LAME, the following command will register the codec in Window's Audio Codec Manager:

```
cd %windir%\SysWOW64
rundll32 setupapi.dll,InstallHinfSection DefaultInstall 0 C:\LAME\LameACM.inf
```

For Windows 10 use this command:

```
C:\Windows\SysWOW64\rundll32.exe setupapi.dll,InstallHinfSection DefaultInstall 0 C:\LAME\
```

There may already be an encoder on your system due to other software previously installed, like the Fraunhofer IIS MPEG Layer-3 Codec. The Fraunhofer codec also works perfectly OK with Win-Test.

The default settings (Stereo/32000 Hz sample rate, 96 kBit/s bitrate) will produce a file of about 2 GB in size for an 48h contest.

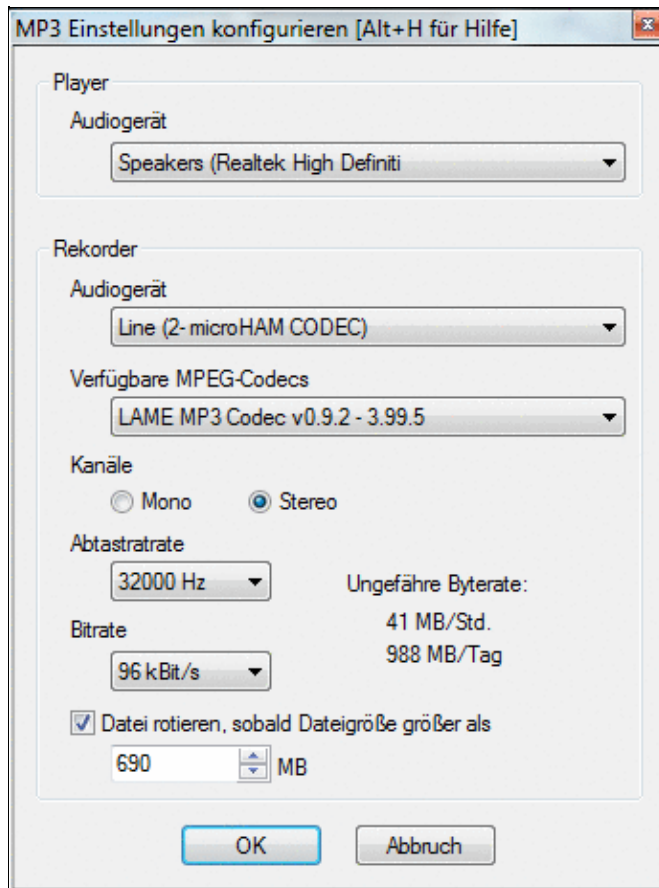

Display options for MP3/Contest Recorder configuration.

To make your MP3 recordings available on the Internet after the contest, see:

<http://lists.f5mzn.org/pipermail/support/2009-December/078951.html>

## Script Editor Configuration

This menu lets you configure the application to start when clicking the Edit button in the [Scripts Manager](#). Basically, every ASCII editor is usable, SciTE is the recommended editor as it provides syntax highlighting.

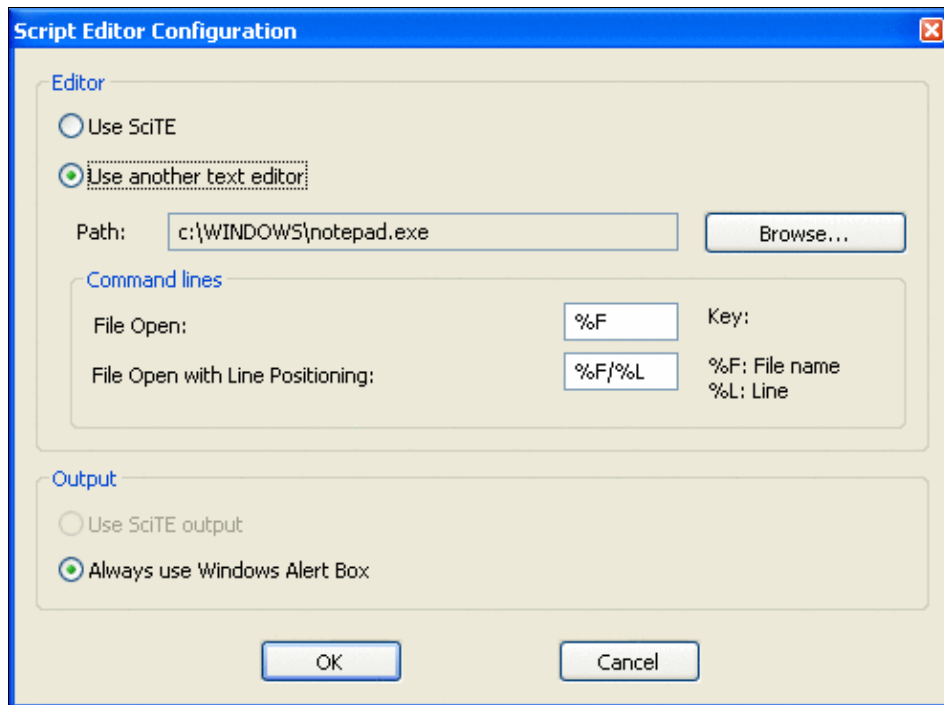

Configure the preferred editor to manage Lua scripts from within Win-Test

## Log

Options | Log

Allows you to change the display of the log entry area (the last 9 QSOs plus the current QSO entry line), including the Win-Test background color. You may select font size, colors, headings and so on.

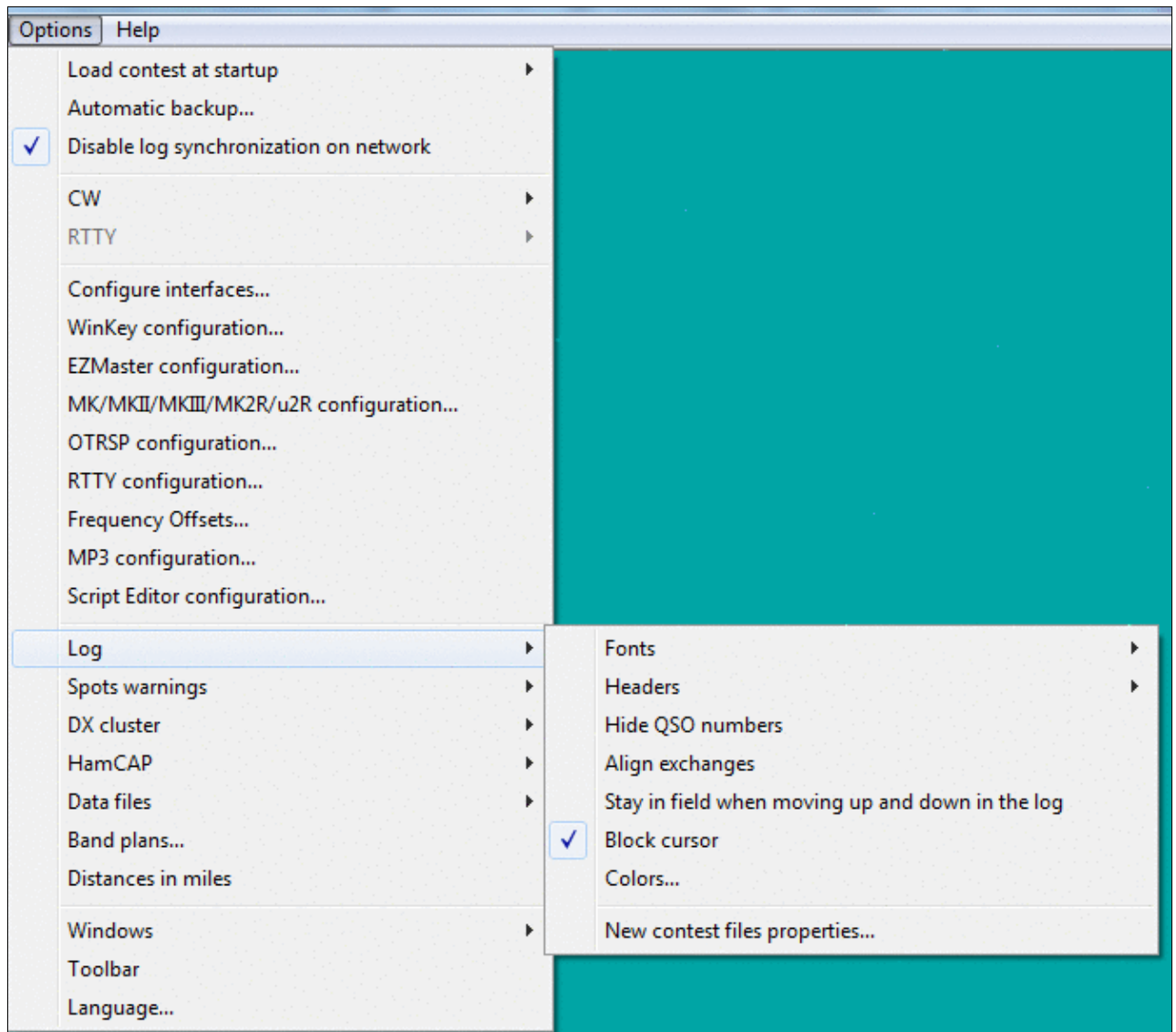

Display options for the log entry area.

## Fonts

Select the text font for the log entry area

## Headers

Controls the display of the column titles in the log entry area. The headers may be hidden, left aligned, or centered

## Hide QSO numbers

Hides the first column in the log entry area, to avoid confusion with the serial number sent, especially for multi-op entrants.

## Align Exchanges

Option to line up received exchanges in mixed mode.

## Stay in field when moving up and down in the log

Select this option to have the cursor move up and down as it would in a spreadsheet. For example, to stay in the report field when pressing the **[Up]** or **[Down]** cursor keys, instead of having the cursor jump to the beginning of the callsign field.

## Block Cursor

Allows you to change the red linking line cursor to a block cursor.

## Colors...

Use this option to change the background color for the entire screen, the color of the logging text, the header text, or the warning message text. Press the **[Factory colors]** button to restore these to the Win-Test default colors.

## New Contest Files Properties

This window lets you define a directory structure and file name template for newly created contest log files. This is a nice feature to keep contest files including MP3 recordings etc. well organised.

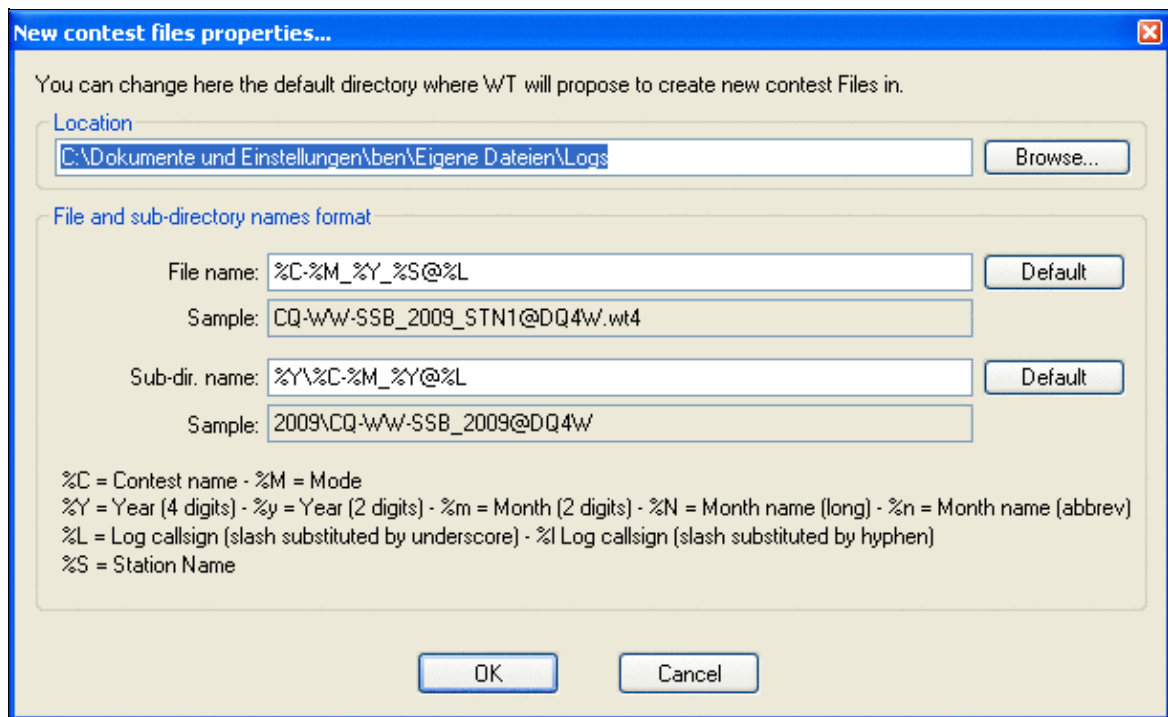

### New Contest File Properties dialog

The following macros may be used to specify the file name.

```
%C = Contest name
%I = Log callsign (slash substituted by hyphen)
%L = Log callsign (slash substituted by underscore)
%M = Mode
%m = Month (2 digits)
%N = Month name (long)
%n = Month name (abbrev)
%S = Station name
%Y = Year (4 digits)
%y = Year (2 digits)
```

## DXpedition Info Field

### Options | DXpedition Info Field

This submenu allows you to configure some options regarding the use of Win-Test on a DXpedition. It is only visible if you have selected the contest type DXpedition.

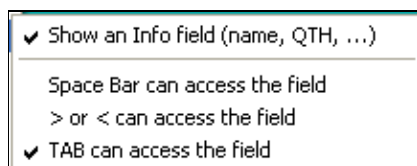

### Options available for DXpedition operation

An info field is available to store up to 13 characters of information with the QSO, e.g. the operator's name, QTH or other information that you wish to keep visible during the QSO. The info field can be accessed with the space bar, the [**>**] and [**<**] keys or the [**Tab**] key.

QSO	Mode	Bd	Time	Callsign	SentRcvd	Info	Dup
1	CW	20	12:28	DK20Y	599 599	MANFRED M15	
2	CW	20			599 599		

The DXpedition Info Field can store up to 13 characters. If you don't use space to switch fields, you can also enter a space character like shown above.

## Spot Warnings

When this option is enabled, the DX cluster spots are briefly displayed (as soon as they arrive), in the line under below the log entry line. You can choose to display only the spots of the current band and/or the new multipliers, as well as your own callsign (good to know when you're being spotted!). And of course you may want to hide dupes and invalid callsigns.

## DX Cluster

Options | DX Cluster

### DX Cluster window shortcuts

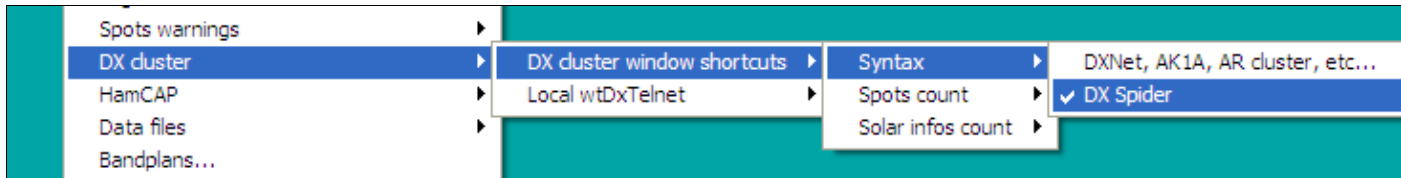

Selecting the syntax of your DX Cluster

This option controls the syntax of the DX-cluster node that you are using (DX Spider vs. AK1A, DXNet, etc.), and the count of spots and solar information requested by using the buttons in the DX cluster window.

### Start/stop wtDxTelnet automatically

When wtDxTelnet is installed in the Win-Test directory, this option allows you to start and stop this application from within Win-Test or start and stop it automatically when Win-Test is launched.

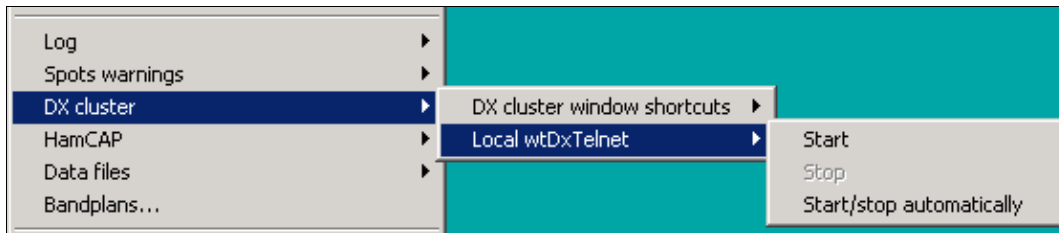

Starting and stopping wtDxTelnet from Win-test

## HamCAP

Options | HamCAP

With this menu option you can configure the way Win-Test will integrate with HamCAP (by VE3NEA). You can select if you want to see immediately the HamCAP window, as soon as you call for it with the shortcut **Ctrl-P**, or if you want it to calculate in background and you will recall the propagation forecast window later.

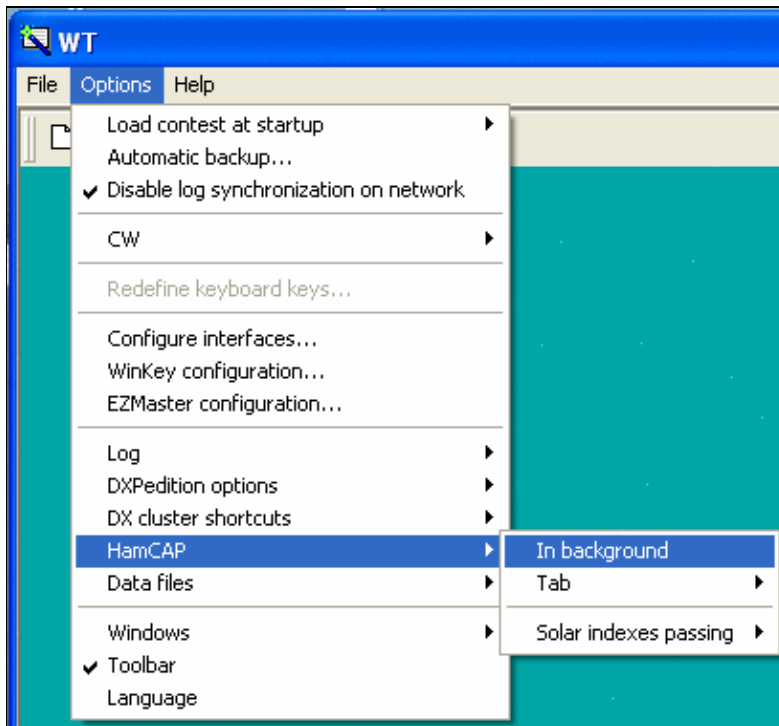



Option In Background

It is just a matter of taste and of how big is your monitor screen: if you have plenty of room, maybe you don't care to leave it in background (**In background** option **checked**), but in a visible part of the screen, so you don't lose the keyboard focus from the WT main window; otherwise you will see immediately HamCAP (**In background** option **unchecked**), and so you'll need to regain the focus with a mouse click.

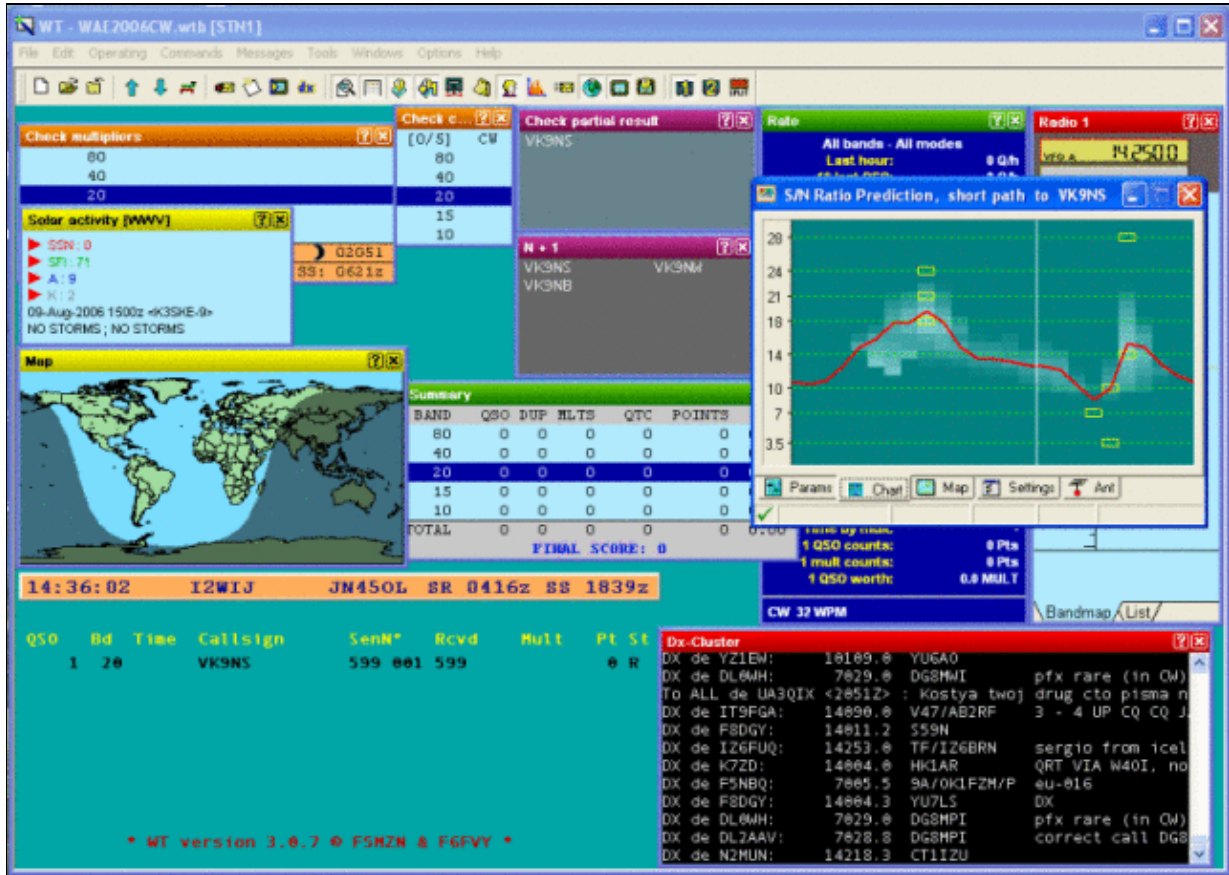

HamCAP in foreground

Then you need to setup which HamCAP tab you want to see first.

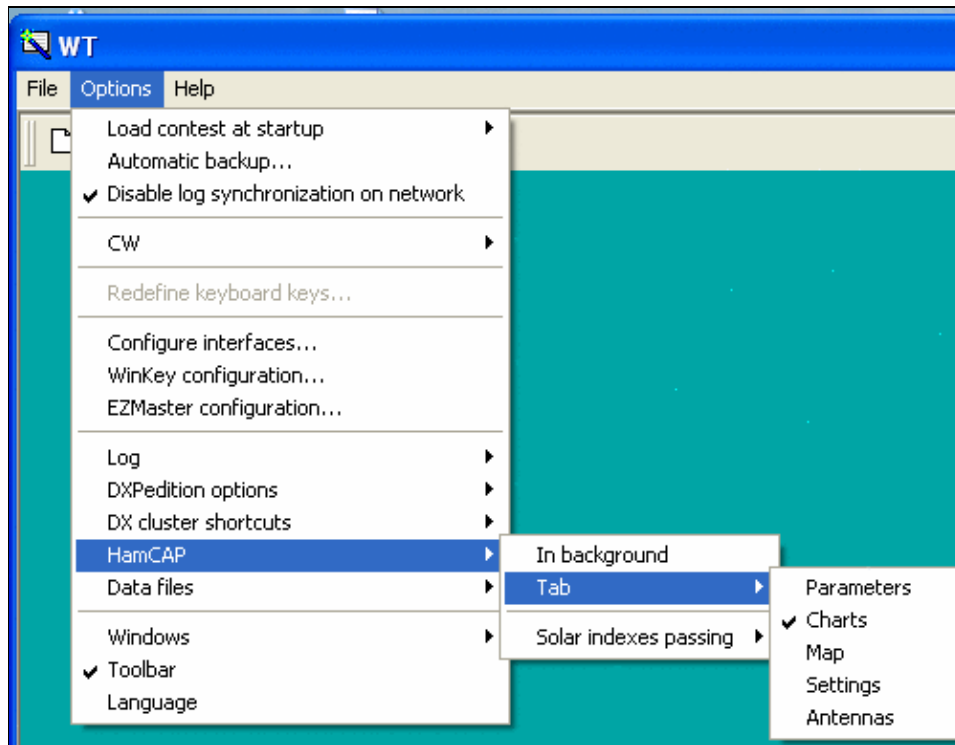

#### Option In Background

The most useful are the **Charts** or the **Map** tab, which are those that give the propagation information, while the others, namely Params, Settings, and Antennas, are useful in the HamCAP itself setup phase.

See [HamCAP](#) in this manual for more details on the setup phase.

Then you have to setup in which way HamCAP has to deal with Solar figures (SSN, SFI, A and K indexes). (See [Menu Windows Solar Activity](#) in this manual).

HamCAP has at least three different modes of operation:

- stand-alone
- in cooperation with [IonoProbe](#) (by VE3NEA)
- feeded by a calling application (Win-Test)

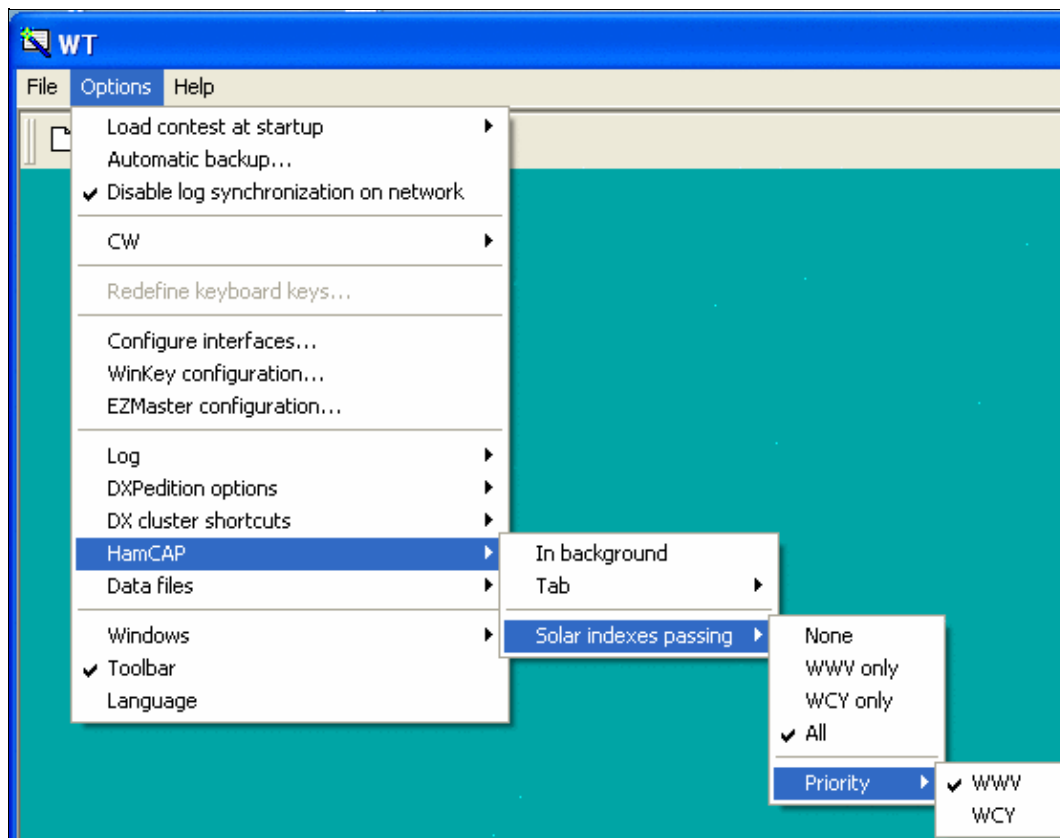

### Option Solar indexes passing

So, at this time, you should check one of the following options:

- **None**, if you don't want, or need, Win-Test to pass any data to HamCAP, which will be working in stand-alone mode or in cooperation with IonoProbe;
- **WWV only**, or **WCY only**, if you want Win-Test to pass the corresponding Solar figures, if present, to HamCAP;
- **All**, and then choose **Priority**, if you want to try to use both figures and Win-Test to pass the prioritized one in case both data are present.

## WAEDC

Options | WAEDC

Special option for the Worked All Europe DX Contest. This menu item is only visible when WAEDC Contest is selected.

For more information about Win-Test and WAEDC see WAEDC.

## Data files

Options | Data Files

Through this section you will be enabled to select four more different options in the pop-up menu as shown in the following picture.

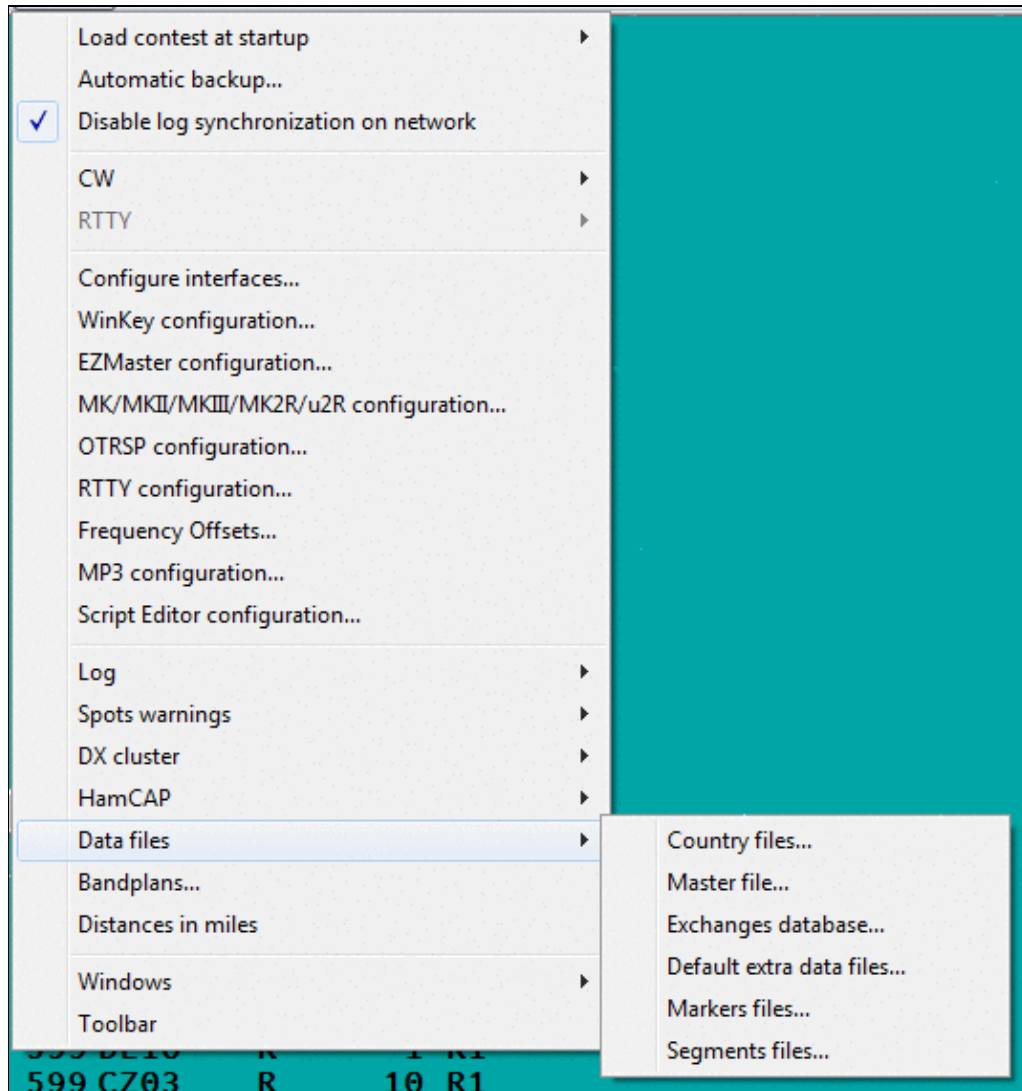

Selecting Options Data files section

## Country files...

Options | Data files | Country files...

Text command shortcut: COUNTRYFILES

This dialog controls which country file to use to identify multipliers. It is also used to calculate and pre-fill ITU and CQ Zones from country prefixes. There are three files to select from.

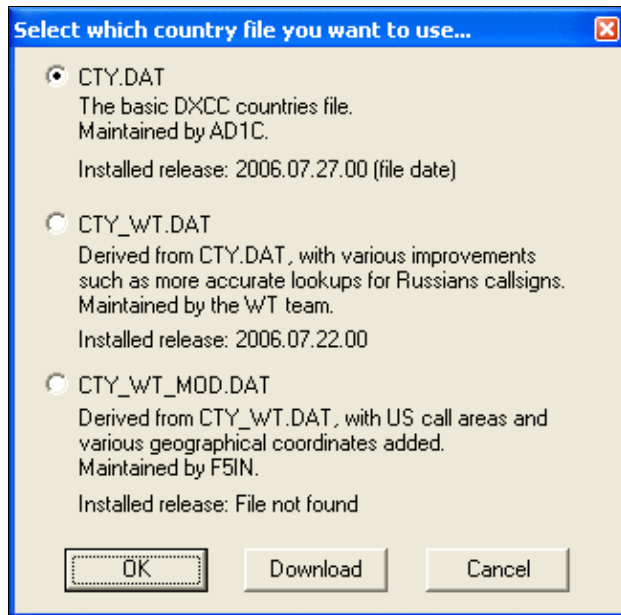

Selecting the appropriate CTY file

Selecting **CTY\_WT\_MOD.DAT** usually gives the most accurate results if you download the latest version. For a description of each file, see [Other Files](#).

You can start an immediate download from the Win-Test web site by selecting a file and clicking the **Download** button. After pressing **OK**, you will be prompted if you want to reload and re-score the log based on the updated country file.

Note that the file ends up in the user's virtual store, if you do not run Win-Test as an Administrator. This may create some confusion which file is actually being used.

## Master file...

Options | Data files | Master File...

Text command shortcut: MASTERFILE, EXCHDATABASE, EXCHFILE or EXCHFILES.

A window, indicating the name of the master file for this contest, what is the file currently used, the total number of records in the file, and release date. A Download button allows you to update directly from the [supercheckpartial.com](http://supercheckpartial.com) web site.

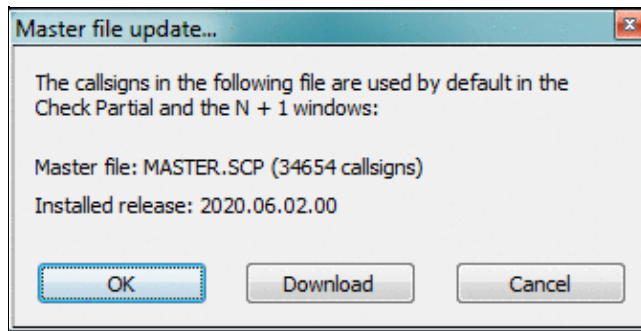

Master file information and update option

Note that the file ends up in the user's virtual store, if you do not run Win-Test as an Administrator. This may create some confusion which file is actually being used.

## Exchanges Database...

Options | Data files | Exchanges database...

Text command shortcut: EXCHDB, EXCHDATABASE, EXCHFILE or EXCHFILES.

A window, indicating the name of the exchanges file for this contest, what is the file currently used, the total number of records of this file, and the number of relevant records (if the DTB is used for different contests). A Download button allows you to update directly from the Win-Test web site.

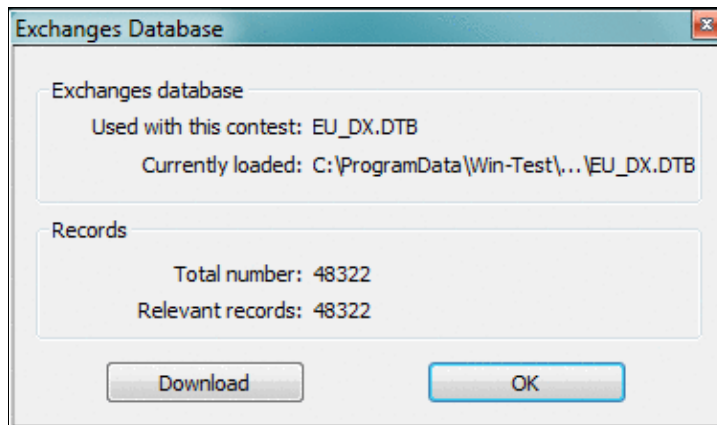

Exchanges database file information and update option

Note that the file ends up in the user's virtual store, if you do not run Win-Test as an Administrator. This may create some confusion which file is actually being used.

## Default extra data files...

Options | Data Files | Default extra data files...

This option will allow to select which EXTRA files WT will use to show specific information (like operator's name, IOTA references, club member names, etc.) in the Extra Information window (see [Menu:Windows Extra Information](#) for more details). When selecting this option a window will pop-up where you can check the files you need. You can see an example in the following picture.

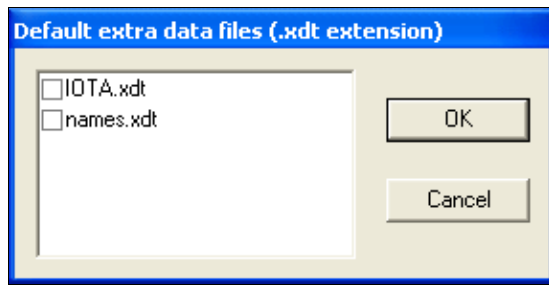

Selecting the Extra data files

## Markers files...

Options | Data Files | Markers files...

This option will allow to select which Markers files WT will use to show the relevant information in the BandMap. Please refer to the description of the band map's [context menu](#) for detailed information on these files. When selecting this option a window will pop up where you can check the files you wish to display information from. You can see an example in the following picture.

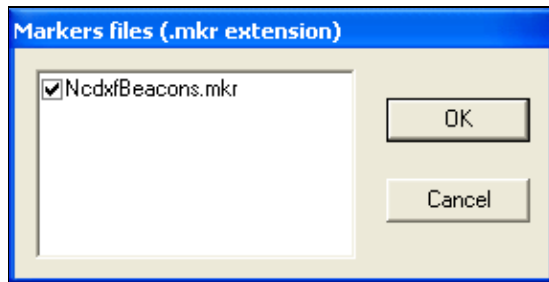

Selecting the Markers files

## Segments files...

Options | Data Files | Segments files...

This option will allow to select which segments files WT will use to show the relevant information in the BandMap. Please refer to the description of the band map's [context menu](#) for detailed information on these files. When selecting this option a window will pop up where you can check the files you wish to activate. You can see an example in the following picture.

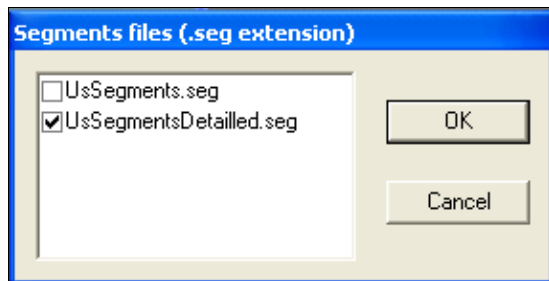

Selecting the Segments files

## Bandplans...

Options | Bandplans...

A flexible and powerful band plan management allows you to specify band boundaries on a permanent basis depending on the mode of operation. We all know, that on 40 m CW, the band goes up to 7100; on RTTY, the band goes from well below 7030 to 7100 etc. etc. Since Win-Test tries to filter incoming DX spots by frequency, this is the way to have Win-Test make the correct decision to drop the spot or display it as needed DX.

**Band plans setup...**

Bandplan: Default

Band: 40

<input checked="" type="checkbox"/> CW	7000.0	to	7040.0	<input checked="" type="checkbox"/> SSB	7040.0	to	7300.0
<input checked="" type="checkbox"/> RTTY	7035.0	to	7045.0	<input type="checkbox"/> FM		to	
<input type="checkbox"/> PSK		to		<input type="checkbox"/> PKT		to	
<input type="checkbox"/> HELL		to		<input type="checkbox"/> SAT		to	

All frequencies must be expressed in kHz

**Load**

Default	Bandplan 1	Bandplan 2	Bandplan 3	Bandplan 4
Bandplan 5	Bandplan 6	Bandplan 7	Bandplan 8	Bandplan 9

**Save as**

Default	Bandplan 1	Bandplan 2	Bandplan 3	Bandplan 4
Bandplan 5	Bandplan 6	Bandplan 7	Bandplan 8	Bandplan 9

Shift-click on the buttons above to rename or delete a created bandplan (except the Default one)

Use this current bandplan for the current log

Cancel OK



The Band Plan Manager window

Different band plans can be saved and re-loaded at a later time. It's smart to create a band plan for SSB, another for CW, yet another one for 160 CW etc.

## Windows

Options | Windows

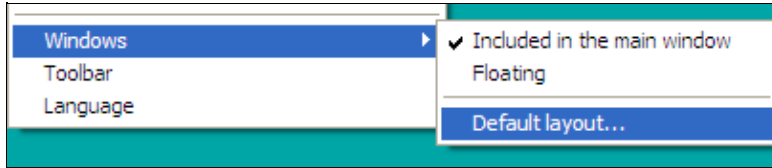

Selecting how child windows are displayed

The child windows of the application can either be included in the main Win-Test window, or float anywhere on the screen, thus allowing the Windows desktop or other running software to remain visible. If your video card and operating system support it, you can display Win-Test windows on more than one monitor.

Win-Test automatically saves the current window layout in the Win-Test binary log file (.wtb) whenever you exit. So, each log file can have a different window layout depending on the contest.

See [Positioning Windows](#) for more information about how to precisely rearrange the window layout to suit your preferences.

Once you have a window layout that you like, select `Default layout . . .` to save it as the default layout that will be used for new Win-Test logs. Win-Test displays the following dialog:

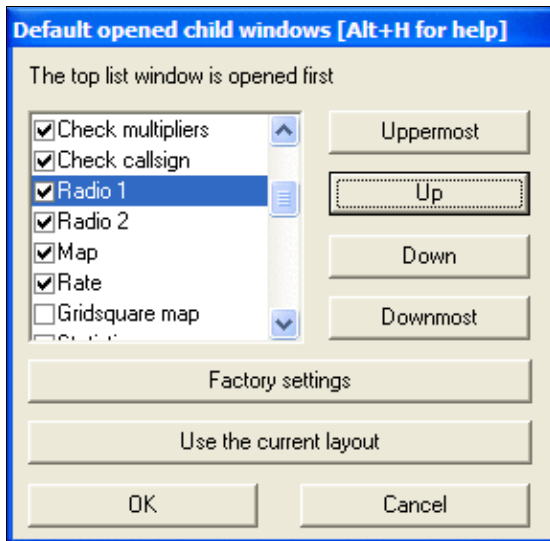

### Changing the default window layout

Updates to this dialog do *not* effect the current log's window layout; they only affect the default window layout to be used for new logs.

If you press [**Use the current layout**], Win-Test updates the list box so that it describes the current Window layout. Generally you'll want to press this button first.

The child windows are listed in the order that they will be *drawn*, so if two windows overlap, the window listed last will appear "on top" of any windows listed earlier.

Use the check boxes to indicate which child windows you want displayed by default.

- [**Uppermost**] - moves the highlighted child window to the top of the list, so that it will be drawn first, and appear *beneath* any windows drawn later.
- [**Up**] - moves the highlighted child window up one spot in the list
- [**Down**] - moves the highlighted child window down one spot in the list
- [**Downmost**] - moves the highlighted child window to the bottom of the list, so that it will be drawn last, and appear *on top of* any windows drawn earlier.
- [**Factory settings**] - restores the default window layout to the Win-Test factory default
- [**Use the current layout**] - updates the list to describe the child window layout being used by the current log
- [**OK**] - saves the displayed window list as the new Win-Test default, and closes the dialog. The layout is saved in the Win-Test initialization file (wt.ini). Pressing this button has *no effect* on the current window layout being used.
- [**Cancel**] - cancels all changes to the default child window layout and closes the dialog.

## Toolbar

Options | Toolbar

If this option is checked, the Icons toolbar is displayed below the menu.



Icon toolbar

Refer to the [Icon bar](#) chapter for a detailed explanation of all the pictorial symbols.

## Language

Options | Language

It is possible to choose the language of the Win-Test user interface. Currently supported languages are English, French, German, Italian and Spanish.



Selecting the Language

Win-Test has to restart when the language is switched.

[Back to Menus](#)

## Namespaces

- [Page](#)
- [Discussion](#)

## Variants

## Views

- [Read](#)
- [View source](#)
- [View history](#)

## More

- This page was last edited on 10 April 2023, at 07:00.
- [Privacy policy](#)
- [About Win-Test Wiki](#)
- [Disclaimers](#)



# Menus

From Win-Test Wiki

[Jump to navigation](#) [Jump to search](#)

## Contents

- [1 File](#)
- [2 Edit](#)
- [3 Operating](#)
- [4 Commands](#)
- [5 Messages](#)
- [6 Tools](#)
- [7 Windows](#)
- [8 Options](#)
- [9 Help](#)

## File

*Without a Win-Test file opened...*

- [New...](#)
- [Open...](#)
- [Import](#)
  - ◆ [Editest...](#)
  - ◆ [Cabrillo...](#)
- [Export](#)
  - ◆ [WT Version2...](#)
- [Merge logs...](#)
- [Clean log...](#)
- [Quit](#)

*With a Win-Test file opened...*

- [New...](#)
- [Open...](#)
- [Close...](#)
- [Create log files](#)
- [Backup Contest](#)
- [Update database](#)
- [Quit](#)

## Edit

- [Restore QSO](#)
- [Initialize QSO](#)
- [QSO date and time](#)
- [Edit serial number](#)

- [Delete QSO](#)
- [Delete all QSO...](#)
- [Goto QSO](#)
- [Move in my log only](#)

## **Operating**

- [Listen to the primary radio](#)
- [Listen to the secondary radio/headphone toggle](#)
- [Listen to the secondary radio during transmit/headphone latch](#)
- [Listen both radio/headphone split](#)
- [Revert to automatic control](#)
- [Technique](#)
- [Modify the scenarios](#)
- [Shift binds to the secondary radio](#)
- [The second footswitch binds to the secondary radio](#)

## **Commands**

- [QSY](#)
- [Keyboard mode](#)
- [CW Speed...](#)
- [CW weight...](#)
- [Carrier](#)
- [Split frequency](#)
- [QSY frequency](#)
- [QSY to run frequency](#)
- [Swap the frequency on both radios](#)
- [Take a sked](#)
- [Pass a station](#)
- [Copy-paste the previous QSO](#)
- [Receive QTC](#)
- [Transmit QTC](#)
- [DX-Cluster](#)
- [Spot](#)
- [Propagation forecast](#)
- [Insert into BandMap](#)
- [Active Radio](#)
- [Station Type](#)
- [CW Messages](#)

## **Messages**

- [Send a gab...](#)
- [Reply to the last private gab...](#)
- [Write a note regarding this QSO](#)

## **Tools**

- [Automatic CQ repeat](#)
- [Redefine keyboard keys](#)
- [Data entry](#)
- [Load an target file](#)
- [Export an target file](#)
- [Check log](#)

## **Windows**

- [Worked Gridsquares](#)
- [Worked Zones](#)
- [Worked DXCC](#)
- [Check Multipliers](#)
- [Search for Worked Multipliers](#)
- [Check Partial](#)
- [Check N + 1](#)
- [Status](#)
- [Skeds](#)
- [Summary](#)
- [Rate](#)
- [Statistics](#)
- [Gab](#)
- [World Map](#)
- [Radio 1](#)
- [Radio 2](#)
- [DX-Cluster Monitor](#)
- [DX-Cluster Announcements](#)
- [Clock](#)
- [SSB bargraph](#)

## **Options**

- [Load contest at startup](#)
- [Automatic backup...](#)
- [Disable log synchronization on network](#)
- [CW](#)
- [Configure interfaces...](#)
- [WinKey configuration...](#)
- [EZMaster configuration...](#)
- [RTTY configuration...](#)
- [Log](#)
- [Spots warnings](#)
- [DX cluster shortcuts](#)
- [HamCAP](#)
- [WAEDC](#)
- [Data files](#)
- [Bandplans...](#)

- [Windows](#)
- [Toolbar](#)
- [Language](#)

## **Help**

- [Register software](#)
- [Use online manual](#)
- [Reference manual](#)
- [About](#)

## **Namespaces**

- [Page](#)
- [Discussion](#)

## **Variants**

## **Views**

- [Read](#)
- [View source](#)
- [View history](#)

## **More**

- This page was last edited on 9 December 2016, at 23:43.

- [Privacy policy](#)
- [About Win-Test Wiki](#)
- [Disclaimers](#)



# Menu:Tools

From Win-Test Wiki

[Jump to navigation](#) [Jump to search](#)

## Menu:Tools

### Contents

- [1 Automatic CQ repeat](#)
- [2 Intelligent Quick QSL...](#)
- [3 Redefine keyboard keys](#)
  - ◆ [3.1 Remapping \[\\*\] and \[+\] when using Notebook or Mini keyboard](#)
  - ◆ [3.2 QWERTY and AZERTY Keyboards](#)
- [4 Data entry](#)
  - ◆ [4.1 Exchange guessing](#)
  - ◆ [4.2 Callsign check](#)
  - ◆ [4.3 Priority](#)
  - ◆ [4.4 Enable ESM](#)
  - ◆ [4.5 Disable CW cut numbers translation](#)
  - ◆ [4.6 Remap Slash to /P](#)
  - ◆ [4.7 Enable Run/S&P switching](#)
  - ◆ [4.8 Switch keyboard...](#)
- [5 Countdown timer...](#)
- [6 Scripts Manager](#)
  - ◆ [6.1 Introduction](#)
  - ◆ [6.2 # Notation](#)
  - ◆ [6.3 Calling Scripts via Text Command](#)
  - ◆ [6.4 Automatically Executed Scripts](#)
  - ◆ [6.5 Synchronous vs. asynchronous - the #@ Notation](#)
  - ◆ [6.6 Tips for Programming](#)
  - ◆ [6.7 Basic Examples](#)
    - ◇ [6.7.1 Example 1](#)
    - ◇ [6.7.2 Example 2](#)
    - ◇ [6.7.3 Example 3](#)
- [7 Load a target file](#)
- [8 Export a target file](#)
- [9 Check log](#)
- [10 Time shifting](#)
- [11 Correcting OP over a QSO range](#)
- [12 Download Files through the Network](#)

### Automatic CQ repeat

Use the [text command](#) **RPTDELAY** to get to this menu quickly.



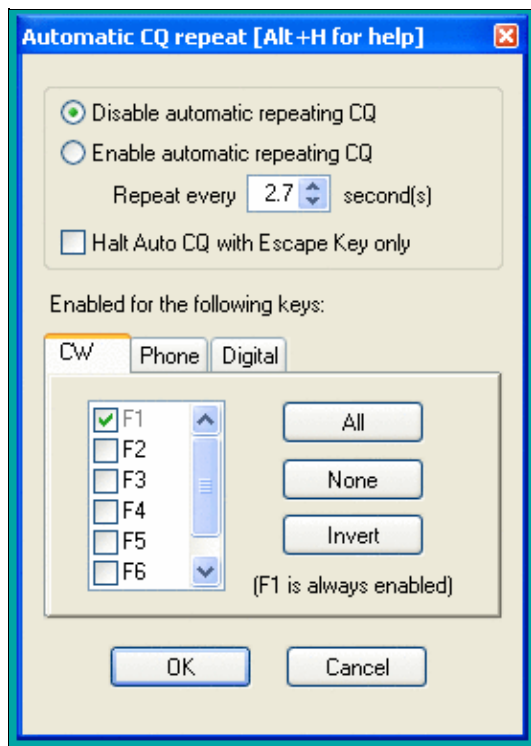

### Auto CQ Settings

This option allows you to automatically repeat messages after a certain amount of time if no key was pressed by the operator. This feature works on all modes and simulates the operator pressing one of the keys [F1] to [F7] key after so and so many seconds.

Traditionally, this is used for the [F1] key to auto-repeat CQ but it can also be used on other keys.

Contrary to CW operation, note that when using an external voice keyer on SSB (like the built-in DRU-2 in a Kenwood TS-850) Win-Test does not know when the message ends. For this reason, the time period to be set is the time that elapses between two CQ calls. This is also true for RTTY when using the MMTTY plug-in.

You may want to use the text commands **NORPT** or **RPT** to deactivate and later reactivate that function. Optionally, you may choose that only the Escape key deactivates the repeat function by clicking the appropriate option in the context menu or by **RPTESCONLY** and **NORPTESCONLY** text commands.

## Intelligent Quick QSL...

Use the text command **QUICKQSL** to get to this menu quickly. Use **QQSLON / QQSLOFF** or **QQSL / NOQQSL** text commands to enable (or disable) the Quick QSL feature.

This option controls the content of the two message variables **\$QQSLT** and **\$QQSLC**. When used, these variables change their content after so and so many seconds or when a number of QSOs have been logged. That way you can send a short QSL message to confirm the QSO in a pileup, but make sure your full callsign gets transmitted automatically every 2 minutes or every 5 QSOs only. So while most QSOs would be completed with **TU** or **EE** sometimes we would send a message like **TU F5MZN**.

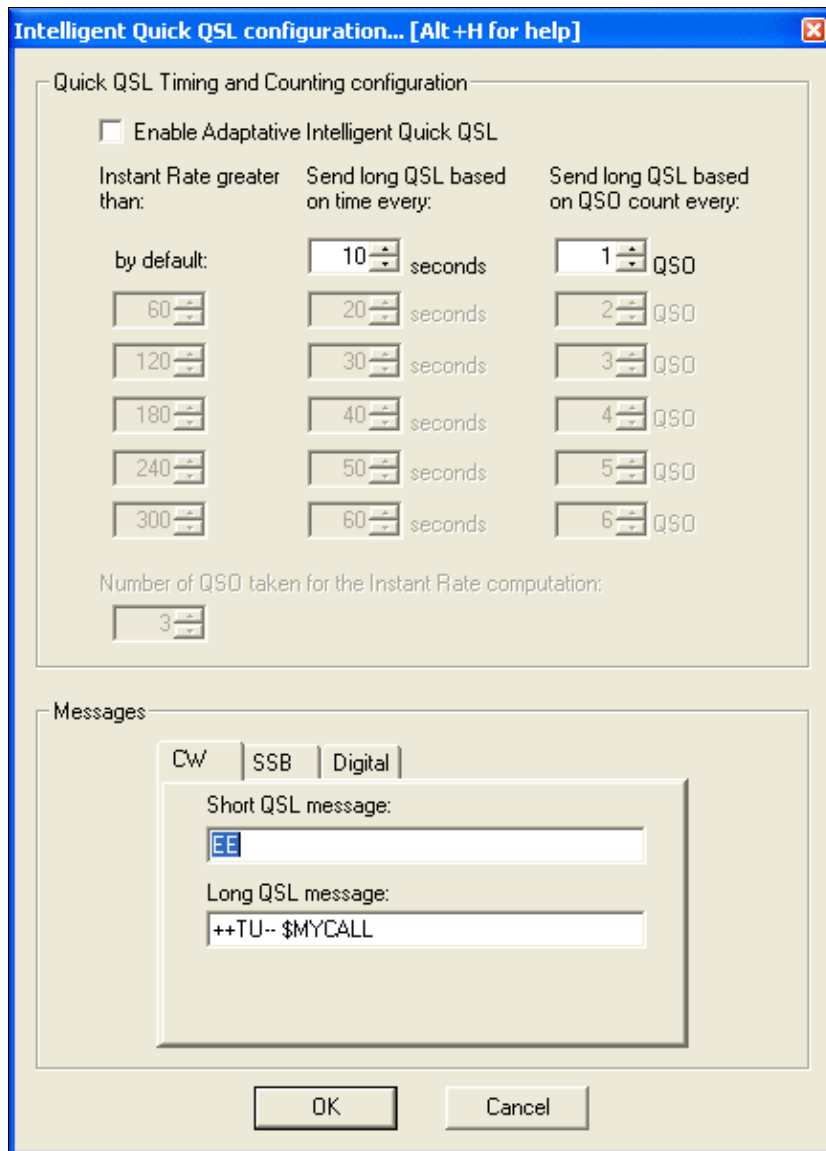

The intelligent quick QSL option allows you to automatically control sending of your own callsign every so often during a heavy pileup.

A timer (**\$QOQSLT** macro) or a counter (**\$QOQSLC** macro) are associated with these macros to determine if either a short or a long QSL message is to be transmitted. Additionally, this feature can be related to the current QSO rate (so-called adaptive intelligent quick QSL).

The **\$QOQSLC** and **\$QOQSLT** macros can either be used in the CW/RTTY Messages or in the advanced SO2R scenarios. It is also possible to use the feature in SSB (SO1R and SO2R not advanced) but this needs a specific configuration in the SSB tab of the configuration window.

In the **PLUS** message in the Standard CW messages configuration, replace **TU \$MYCALL** with **\$QOQSLC** or **\$QOQSLT**. Intelligent Quick QSL will then send a short QSL message or a long QSL message according to the set counter or the set timer in the respective variable.

The macro **\$QOQSLRESET** resets the timer or the counter like if the long QSL message were just sent. It makes sense to use this macro in each message you send your callsign in like CQ (**F1**) or MYCALL (**F4**). That way, you won't send a long QSL message after just having sent your call a few seconds before.

## Redefine keyboard keys

Use the text command **DEFINEKEYS** to get to this menu quickly.

On some keyboards, it is difficult to reach specific keys, so Win-Test allows you to re-define some of the keys on your keyboard.

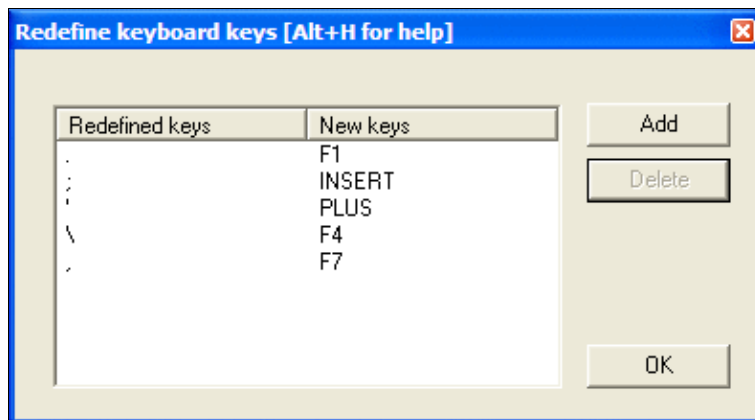

### Redefine Keyboard Keys

For example, to make the period key [ . ] call CQ, just like **[F1]**:

1. Press the **[Add]** button
2. Press the key you want to reprogram: the period key [ . ]
3. Press the key that does the function you want: the **[F1]** key
4. Press the **[OK]** button to save the changes, or press the **[Esc]** key to exit without saving any changes

To restore a remapped key to its default behavior, highlight a line by clicking on it with the mouse, then press the **[Delete]** button.

Remapping is done on a 1:1 basis. One keystroke becomes an alternate version of another. The original key still works as before. Keyboard remapping is saved in the wt.ini file, so the same map will automatically be used for all contests.

**WARNING:** Do not copy wt.ini from one machine to a new machine that already has a registered version of Win-Test, or else will have to re-enter the registration key on the new machine. See registration instructions.

In the example above, you can see how the commonly-used keys like **[F1]**, **[Ins]**, and **[+]** have all been remapped to keys that are much easier to reach on a U.S. keyboard, especially if you are a touch-typist. The keyboard map shown in the example was developed by N6TV for Team Vertical:

- **[.]** (the period key) calls CQ, just like **[F1]**
- **[;]** (the semicolon key) sends the message, just like the **[Ins]** key
- **[']** (the single-quote key) sends TU and logs the QSO, just like the **[+]** key
- **[\\]** (the backslash key, just above the **[Enter]** key on many U.S. keyboards) sends **\$MYCALL**, just like **[F4]**
- **[,]** (the comma key) sends a single question mark, just like **[F7]**

**NOTE:** Remapped keys are ignored in keyboard mode unless you enable the CW Option Remap keys in keyboard mode. It is generally a good idea to enable this option so that all message keys work the same, whether you are in keyboard mode or not.

## Remapping **[\*]** and **[+]** when using Notebook or Mini keyboard

By default, the asterisk key **[\*]** is used to switch active radios, and the plus key **[+]** is used to send "TU" and log a QSO. These keys are located on the numeric keypad of a full-sized keyboard. Win-Test does *not* treat these keys the same as **Shift-[\*]** and **Shift-[+]**, which is what you would normally press when typing text.

If you are using a Notebook, Laptop or "mini" keyboard without a separate numeric keypad on the right side, equivalent keys with special colored symbols become active only when you press the **[NumLock]** key. One of these keys should be labeled with an asterisk in a different color, and another should be the plus. For example, on a U.S. ThinkPad keyboard, the colored asterisk may be located on the **[P]** key, and the colored plus may be shared with the **[/]** key. Those are the keys to use when remapping, after activating Num Lock mode.

For example, to make Ctrl-S act as the "Switch Active Radio" key when using a keyboard without a numeric keypad:

1. Press the **[Add]** button
2. Press **[Ctrl-S]**
3. Press **Shift-[NumLock]** to enter Num Lock mode
4. Press the key that does the function of the asterisk when in Num Lock mode, perhaps the letter P?
5. Press **Shift-[NumLock]** again to exit Num Lock mode

If a single asterisk **\*** appears in the New Keys column as shown below, the key has been correctly defined. If it says **Shift \*** or something else, it has not.

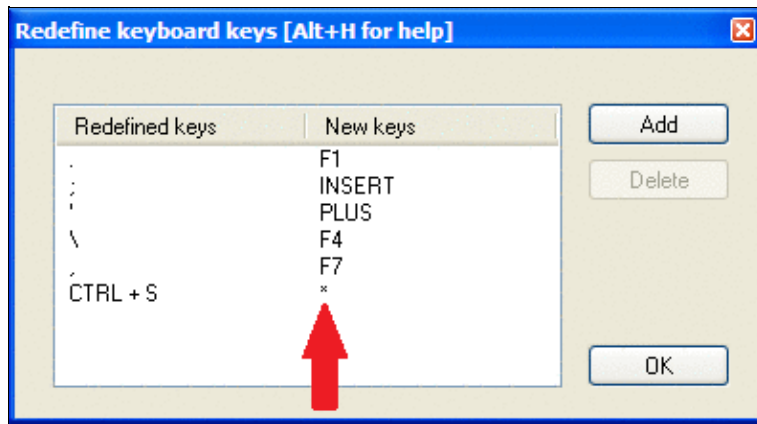

Redefine Keyboard Keys, with function of ASTERISK and PLUS keys properly re-assigned to other keys.  
**QWERTY and AZERTY Keyboards**

French (and some Belgian) users: Button added in the keys redefinitions dialog to load AZERTY redefinitions that allow the AZERTY keyboards users to access the numbers located on the top row without using the Shift or Shift Lock keys. They allow direct access to the ?, . and / keys of the bottom row as well. This button is displayed only when the language is set to French.

## Data entry

These functions describe settings that influence data entry to the log entry line.

## Exchange guessing

Exchange guessing is a feature of Win-Test that predicts the exchange that is going to be received before your QSO partner actually sends the report. In many contests a fixed piece of information is exchanged like the CQ zone in the CQWW contests, or ITU zone in IARU. This option allows you to select the way Win-Test fills in the exchange:

- pressing the space bar
- automatically
- after timeout

Note this option also acts on the various warnings (dupe, new mult, etc., if any) displayed under the log lines.

This feature saves you from continuously typing the same information over and over again but you better make yourself sure the guessed report is correct before you press the **[Enter]** key.

Please refer also to [Setting up Exchange Guessing in Win-Test](#) to know how to activate this feature for a specific contest.

**Note:** CQ zones in the USA and Russia will be guessed correctly (well, 99%) only when you have loaded F5IN's **CTY\_WT\_MOD.DAT** file. Otherwise Win-Test will always come up with the default zone of that country (5 for USA, 17 for UA9 and UA0). Please see [Data files](#) for more details on how to select the right **CTY** file.

## Callsign check

On the fly callsign pattern check based on the K1TTT callsign.pat file, described [here](#) (over 400 rules applied today). The latest version of callsign.pat may be downloaded [here](#).

Yellow text denotes a warning, red text denotes an invalid callsign.

5127 160 23:53 G3B	59 59 14	5127 160 23:53 G3B	59 59 14
5128 160 23:53 DR2W	59 59 14	5128 160 23:53 DR2W	59 59 14
5129 40 DP3Ø1DA	59 59 14	5129 40 DLOWB	59 59 14
* Call too long? *		* Starts with 3 characters! *	

Callsign possibly wrong

Callsign definitely wrong

Callsign pattern file location:

- Windows XP: C:\Documents and Settings\All Users\Application Data\Win-Test\extras\callsign.pat
- Windows Vista or Windows 7: C:\ProgramData\Win-Test\extras\callsign.pat

Updates may be downloaded from <http://download.win-test.com/files/extras/>.

You are encouraged to report to the author ([K1TTT](#)) any mistakes or updates needed in this file.

Callsigns which don't follow the usual rules, like RAEM, 5VDE, 7QAA, etc.) are grouped in the **exceptions.dat** file for easy updating.

## Priority

To change bands, you may wish to enter a frequency or band (m) into the callsign field. This option determines how these figures are to be understood by the program:

- Band - take 10,15,20,40,80,160 as a meter band
- Frequency - take the input as a frequency; shorted inputs as kHz

To make this a little more clear, if you enter 40:

- In the first case will switch the band to 40 meters (thus, enter 040 or 40.0 if you want to tune your radio to 040)
- In the second case it will tune your radio to decimal 040 on the current band (thus, enter 40M if you want to switch to 40 meters).

## Enable ESM

Win Test v4 comes with an Enter Sends Message (ESM) feature, well-known by users of TR LOG by N6TR. The functionality can be turned on or off via this menu item or using the [text commands](#) **ESM/NOESM**.

ESM relies on the following messages assignation:

F1: CQ

```
F2: Sent report  
F4: Mycall  
F5: Logged callsign ($LOGGED)  
F7: ? (or "Again ?" in phone)  
INSERT: Callsign + sent report  
PLUS: TU + enter Q
```

The basic functionality of ESM can be described like this:

- Pressing **[Enter]** with an empty callsign field, will send the **[F1]** message.
- Pressing **[Enter]** with a callsign filled in but no report will send the **[INSERT]** message.
- Pressing **[Enter]** with callsign and report filled in will send the **[PLUS]** message.
- Pressing **[Enter]** with callsign and partial report filled in will send **[F7]** message.

It makes CW/RTTY easier, as you use one key for most of the operations instead of the various F keys.

There are additional minor details to ESM, which are not described here. On top, ESM behaviour is user-modifiable by using a script editor.

Once ESM is enabled, the **[Enter]** key **can no longer** be used to silently log a QSO. The key combination **[Ctrl+Plus]** has been introduced and added for this purpose.

When using the SO2R advanced technique, the scenarios messages are used instead of the standard.

## Disable CW cut numbers translation

Allows to completely disable Win-Test's intelligent translation of cut numbers like **TTA** to **001**. Note that this translation is performed on a contest and worked station contextual basis. The equivalent text commands are **CUTON** and **CUTOFF**. Do not mix up with **CUT/NOCUT** that are reserved for CW cut numbers generation !

## Remap Slash to /P

This option allows you to map "/" to "/P" for Field Day, VHF/UHF contests and DX pedition mode.

## Enable Run/S&P switching

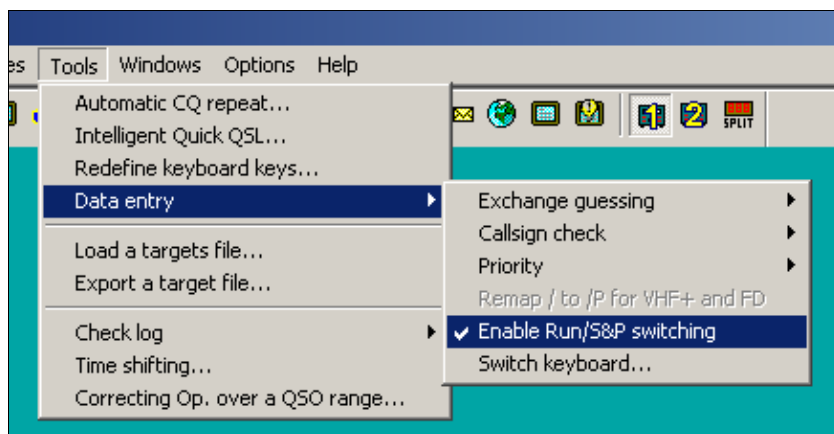

### Enable RUN/S&P switching

Allow switching between Run and Search & Pounce Operating Mode in order to have two different sets of CW/RTTY messages: one when running, and one when searching multipliers.

- The Run and S&P sets of messages are editable in the "Messages" Tab of the Standard CW/RTTY Messages Configuration window.
- Use **[Ctrl-tab]** to switch between RUN and S&P mode on the Primary Radio. The current mode is shown in the clock window. To change the mode of the Secondary Radio Window, use either **[Ctrl-Shift-tab]** or a mouse click on the appropriate control in the Secondary Radio Window.
- It is possible to configure WT to automatically populate the Band Map and wipe the data entry area whenever the operator changes the radio's frequency, if Search & Pounce mode is activated on that radio. This can be configured from the Band Map Properties dialog (right click in the Band Map window).

**Note:** Search & Pounce is not activated by default. To automatically populate the Band Map, you must switch to S&P mode.

**Note:** When switching from Run to S&P mode, Auto CQ and Auto CW Sending are automatically disabled.

### Switch keyboard...



Switch keyboard during the contest - useful for mult-national teams

Keyboard switching for international teams with different keyboards. It is enabled only if several keyboards are installed on your system. You can also access this dialog by entering the text commands **KEYBOARD** or **KEYB** for short.

### Countdown timer...

The countdown timer indicates exactly when the single operator can start operating again after a break. It's based on the time of the last QSO entered in the log, truncated to the minute.



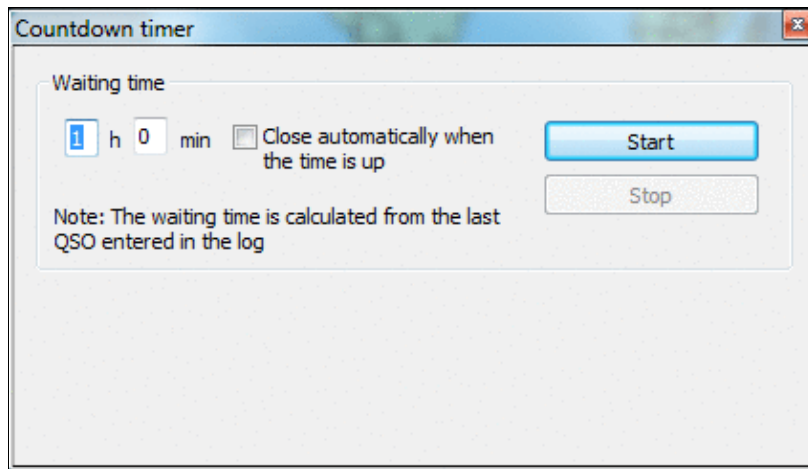

Countdown timer to plan breaks.

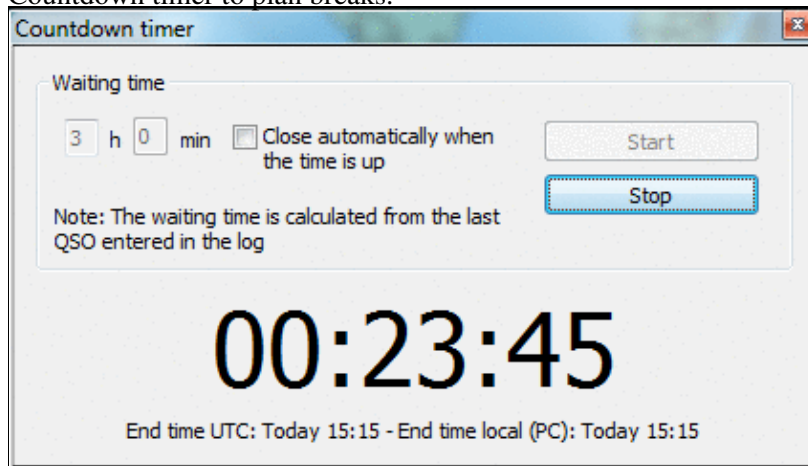

When running, it displays minutes when operation can commence.

You can also use the text command **TIMER/nnHmmM'** or **TIMER/nnHmm** (meaning nn hours and mm minutes), or **TIMER/xxH** (nn hours) or **TIMER/nnM** (nn minutes) to set and start the timer automatically.

## Scripts Manager

Allows to edit, create, delete or rename scripts. It's also used to assign a key and/or an argument to a script. Scripts are to be created and maintained by the user using the Lua programming language. See the [Win-test Lua API](#). For a reference of the Lua programming language, see <http://www.lua.org/manual/5.1/>. Sample Lua scripts demonstrating how to control the RIT and internal DVR (voice keyer) of the Elecraft K3 and other radios may be downloaded from <http://bit.ly/wtscripts>.

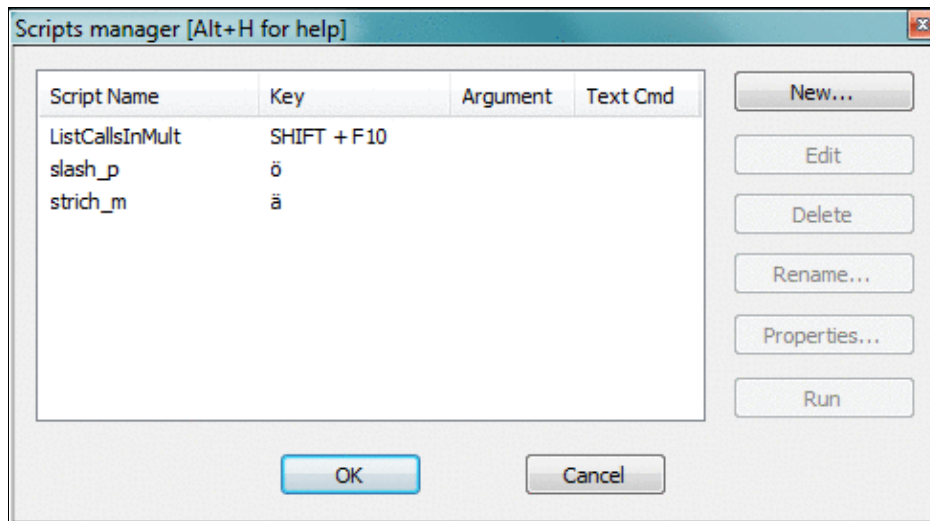

The Win-Test Scripts Manager to edit, create, delete or rename WTS scripts. You may also use the text command **SCRIPTS** to open the scripts manager.

By double-clicking an existing script, the default Editor is opened. Ctrl + Double click brings up the properties dialog.

Before you can modify scripts, you must configure an appropriate script editor. Per Default, Win-Test uses the SciTE Editor, which can be optionally installed. It does context sensitive highlighting, syntax checking etc. If you are only writing a simple script, Windows notepad.exe is probably sufficient.

## Introduction

The Win-Test scripting language gives the user the unique ability to achieve dynamic tasks in Win-Test. It also provides a way to share your work with other Win-Test users who don't have time or skill to write their own scripts.

ESM (Enter Sends Message) was the first Win-Test application where the scripting language **Lua** was used. The ESM function itself is a Lua script, embedded in Win-Test (not modifiable). But, it has been designed to be totally overridden by a user-written script if desired, i.e., you can write and use your own modified version of the ESM script to change the default ESM actions. See ESM Script (embedded into Win-Test) for the LUA source code.

To do this, the minimum requirement is to know some basics of a programming language. The Lua syntax is **very** simple for doing easy tasks. If you're comfortable with **any** programming language, you will learn Lua in minutes, at least for basic scripting involved in Win-Test. Many Win-Test API (Application Programming Interface) functions are provided to control various Win-Test features.

For a list of Win-Test API Functions and Constants, see API.

## # Notation

Scripts can either be called by pressing a key or from within a CW or RTTY message. For this, you must use the **#SCRIPTNAME (ARGUMENT)** notation. The argument (and parenthesis) are optional. The script will be called synchronously, but is executed in the main thread, meaning that it is not blocking the CW/RTTY

stream.

For example :

```
TU N6TV #CLEARIT
```

assuming your script is called **CLEARIT.wts** - or

```
TU #QSYUP(200)
```

assuming you created a script named **QSYUP.wts** to QSY up **wtArgument** Hz after a QSO.

## Calling Scripts via Text Command

Scripts may be triggered using a Text Command. **SCRIPT.wts** can be executed by entering **SCRIPT** in the callsign field.

An argument can be passed to the script by expanding it with a slash. **SCRIPT/5** will call **SCRIPT.wts** and pass the parameter "5" in the **wtArg** global variable. The argument is always passed as a string when the script is called from a text command. If no argument is specified, the default argument defined in the script manager will be used (if any).

## Automatically Executed Scripts

Some scripts are being executed automatically, whenever a specific event occurs.

<b>onFileOpen.wts</b>	Executed when .wt4 file is opened
<b>onFileClose.wts</b>	Executed when .wt4 file is closed
<b>onMicrohamFsOn.wts</b>	Executed, when microHAM footswitch is pressed
<b>onMicrohamFsOff.wts</b>	Executed, when microHAM footswitch is released
<b>onOtrspCrOn.wts</b>	Executed, when OTRSP control has value 1
<b>onOtrspCrOff.wts</b>	Executed, when OTRSP control has value 0
<b>onOtrspCrEvent.wts</b>	Executed, for all states of OTRSP events

## Synchronous vs. asynchronous - the #@ Notation

The scripts calls in the CW or RTTY messages are synchronous to the CW or the RTTY streams. To execute them asynchronously, they can be called with the #@ notation. Example:

```
-- script.wts
wtApp:AlertBox("Hello World!");
```

and the CW/RTTY message content is:

```
AAA #SCRIPT BBB
```

The keyer sends AAA, then "waits" until the user hits the OK button in the "Hello World!" alert box to send BBB. If the CW/RTTY message content is:

```
AAA #@SCRIPT BBB
```

The keyer sends AAA and starts the script (and the alert box is open), **but** it continues to key the rest of the message ("BBB") without waiting the user intervention. This is the asynchronous mode.

## Tips for Programming

1. Use the Scripts Manager to manage scripts, using a simple editor like Notepad. The scripts are stored in the {AppData}/All Users/Win-Test/scripts/ directory.
2. Before you can press the Edit button, make sure you have configured an ASCII editor in the Options Menu
3. If you wish to replace the built-in ESM script in Win-Test, save your script as "esm.wts". The value returned by your script will tell Win-Test what to do after it is executed:
  - ◆ If the return value is 0 (or if there is no return value), WT will run its own embedded script after yours.
  - ◆ If the return value is 1, WT will continue the Enter key process, without calling its embedded script.
  - ◆ And if the return value is -1, WT will stop the Enter key process, without calling its embedded script.
4. WT maintains two different QSO status: One for each radio. They are automatically cleared when the QSO is entered, if the operating mode (RUN/S&P) is switched or if the **wtQso:ClearStatus()** is executed.
5. Lua global variables are persistent between scripts calls. If you don't want this behavior, use local variables instead (keyword local).

## Basic Examples

### Example 1

```
-- esm.wts
wtApp:AlertBox("Enter key ! ESM rulez...");
return 0; -- This line can be omitted
-- end
```

No return value (or 0) => WT will execute this script (the alert box will be displayed), and the embedded script will be called after it.

### Example 2

```
-- esm.wts
wtApp:AlertBox("Enter key ! The key is processed by WT");
return 1;
-- end
```

The return value is 1 => After executing the script (the alert box will be displayed), WT will continue its own process and act exactly as if someone hit Enter. Read: It silently enters the QSO if it is OK. The embedded ESM script is ignored.

### Example 3

```
-- esm.wts
wtApp:AlertBox("Enter key ! The key processing is stopped");
return -1;
-- end
```

The return value is -1 => After executing the script (the alert box will be displayed), the embedded ESM script is ignored and WT will also ignore the Enter key process (no QSO is entered).

For a collection of more advanced programming examples please see [user contributed scripts](#) and [advanced programming examples](#).

## Load a target file

This option allows you to load a so-called target file - an ASCII file (maybe self-generated) that has QSO and multiplier targets for each hour of the contest. This is a nice way to integrate a plan into your contest environment to keep yourself motivated. In the old days we used to have a piece of paper on the wall - today Win-Test automatically tracks this information for your convenience.

Before you can load a target file you will have to create one or receive one from somebody else. Please see [Export a target file](#) on how to do that.

The content of the target file becomes visible in the statistics window (see [Statistics](#)) when you compare current standings with the values in the target file.

Loading a target file is usually a Pre-contest configuration task. Please refer to the usual [Pre-contest configuration](#) activities chapter in this manual.

A target file can also be loaded at any time during the contest. If you see your target score was too easy, you can load a new target to keep your motivation high. You set a target to break your national record, and now things go better and you see the possibility to break the continental record. How can you track this new situation? Preparing more than one file with different targets is a good practice: if conditions change then simply load the new target file and WT will show you how you are doing against that new target!

## Export a target file

This option allows you to create a target file from the log file currently loaded. It is useful to use last year's log as a start to create a target for this year's contest.

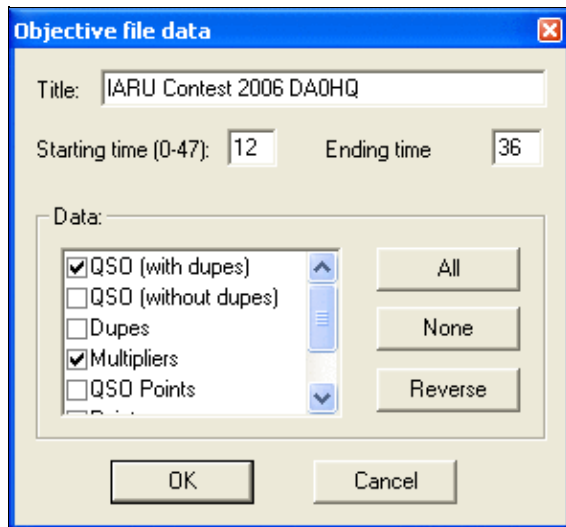

### Exporting a target (.obf) file

You should give a title to the target file to make clear what you're comparing to. Maybe you will want to change the target file to a more optimistic one when you'll realize band conditions are so great this time!

You may want to select which time frame to export (Starting time, ending time). Hours on Sunday have to be given in time + 24 hours so that 12:00 UTC on Sunday becomes 36.

Next you have to choose which columns to export to the target file. Normally you will want QSO count (with or without dupes), multipliers and points.

After pressing **OK** a file with the extension **.obf** will be created which will look similar to the file below:

```
#
# Target file generated by Win-Test
#
# VERSION 100
#
TITLE IARU Contest 2006 DA0HQ
START = 12
END = 36
12 QSO = 0 MULT = 0 POINTS = 0
13 QSO = 1 MULT = 1 POINTS = 1
14 QSO = 1 MULT = 1 POINTS = 1
15 QSO = 1 MULT = 1 POINTS = 1
16 QSO = 1 MULT = 1 POINTS = 1
17 QSO = 2 MULT = 2 POINTS = 4
18 QSO = 3 MULT = 2 POINTS = 4
19 QSO = 4 MULT = 2 POINTS = 6
20 QSO = 4 MULT = 2 POINTS = 6
21 QSO = 4 MULT = 2 POINTS = 6
22 QSO = 8 MULT = 3 POINTS = 18
23 QSO = 8 MULT = 3 POINTS = 18
24 QSO = 8 MULT = 3 POINTS = 18
25 QSO = 8 MULT = 3 POINTS = 18
26 QSO = 8 MULT = 3 POINTS = 18
27 QSO = 8 MULT = 3 POINTS = 18
28 QSO = 8 MULT = 3 POINTS = 18
29 QSO = 8 MULT = 3 POINTS = 18
30 QSO = 8 MULT = 3 POINTS = 18
31 QSO = 8 MULT = 3 POINTS = 18
```

## Win-Test Wiki

32 QSO = 18 MULT = 3 POINTS = 21  
33 QSO = 30 MULT = 5 POINTS = 45  
34 QSO = 42 MULT = 5 POINTS = 50  
35 QSO = 81 MULT = 7 POINTS = 224

As you can see the structure of the file is so easy to understand that you might want to use an ASCII editor to go and make some changes - or create it completely from scratch yourself using this template!

## Check log

This tool allows you to verify if special restrictions of the contest rules have been adhered to in this log. You have different options, depending on the category you choose (see pictures below):

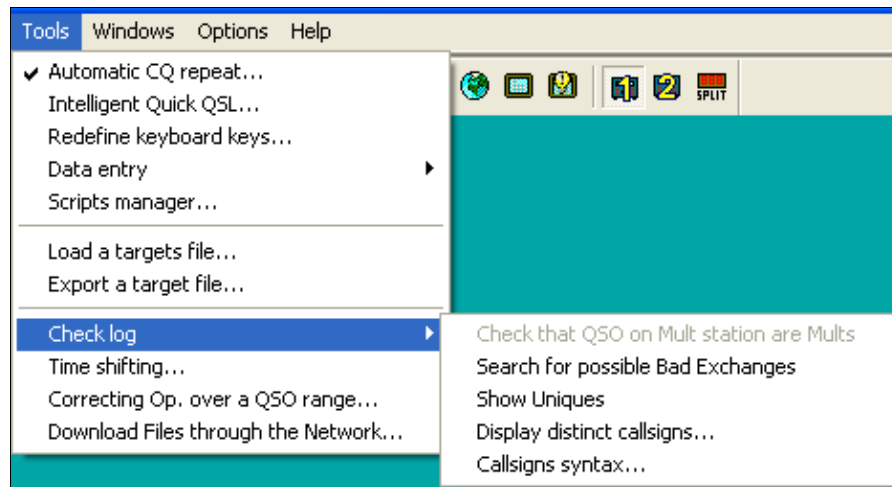

### Check Log feature for the single operator category

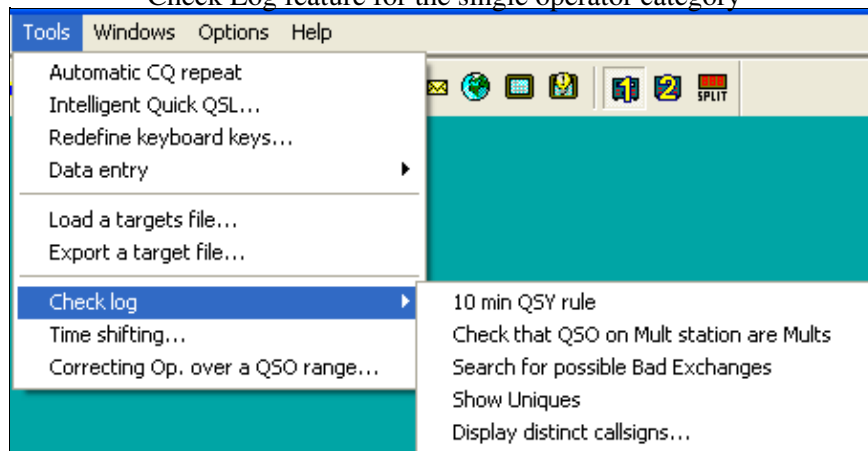

## Check Log feature for M/S category

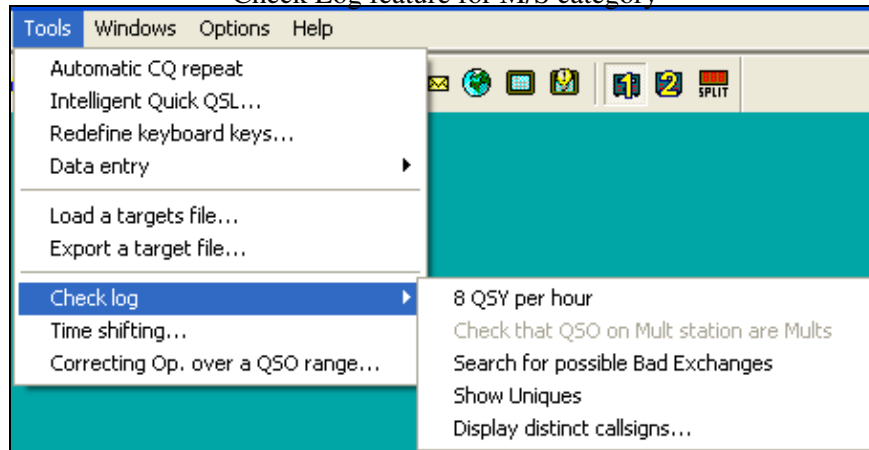

Check Log feature for the M2 category - note the differences in options offered. If you select a contest and/or category which does not have a QSY limit, this option will not show up.

Depending on the selected contest category, you may check for:

- **8 QSY per Hour:** Check the QSY count per hour (ARRL DX in M/2 category for example).
- **10 min QSY rule:** Check if the minimum time on a band has been respected (Multiplier station in a M/S effort during a CQWW DX for example).
- **Check that QSO on Mult station are Mults:** Check if all QSOs made on the multiplier station are actually multipliers. You may want to quote the exceptions (if any) when sending your log to the contest sponsor to avoid massive score reductions.
- **Search for possible Bad Exchanges:** Search the logged exchanges which are potentially bad, according to the database or to the other QSOs made with the same station during the contest. Works for CQWW, ARRL DX or any contest in which there is something which apparently is a zone. It also works for the VHF contest when a Gridsquare is logged.
- **Show Uniques:** Search N+1 for each unique logged callsign in the log. A unique callsign is a callsign that appears in the log only once (contact only on one band and mode, and no dupe). N+1 can be searched against the log, the callsign database (Master database) or both. It is possible to switch off N+1 searching for unique callsigns which are known to the callsign database.
- **Display distinct callsigns...:** Display all distinct callsigns of a log, and band(s)/mode(s) worked by each station. You can sort this report by callsign, by number of Q and by country.
- **Callsigns syntax...:** Match the callsigns to the callsign pattern file (see [Other Files](#)).
- **Open the notes linked to the current log:** Allows you to comfortably walk through your notes taken during the contest. Clicking on a line brings you to that specific QSO. Edit a note by selecting it and use **Alt-N** to modify the comment.
- **Open a different notes file:** Switch notes file, if more than one exists.
- **Download the LCR file:** Download your Log Check Report from the contest web site.



## Win-Test Wiki

- **Open a Different LCR file:** Switch to a different Log Check Report.

These are some of the typical reports you get:

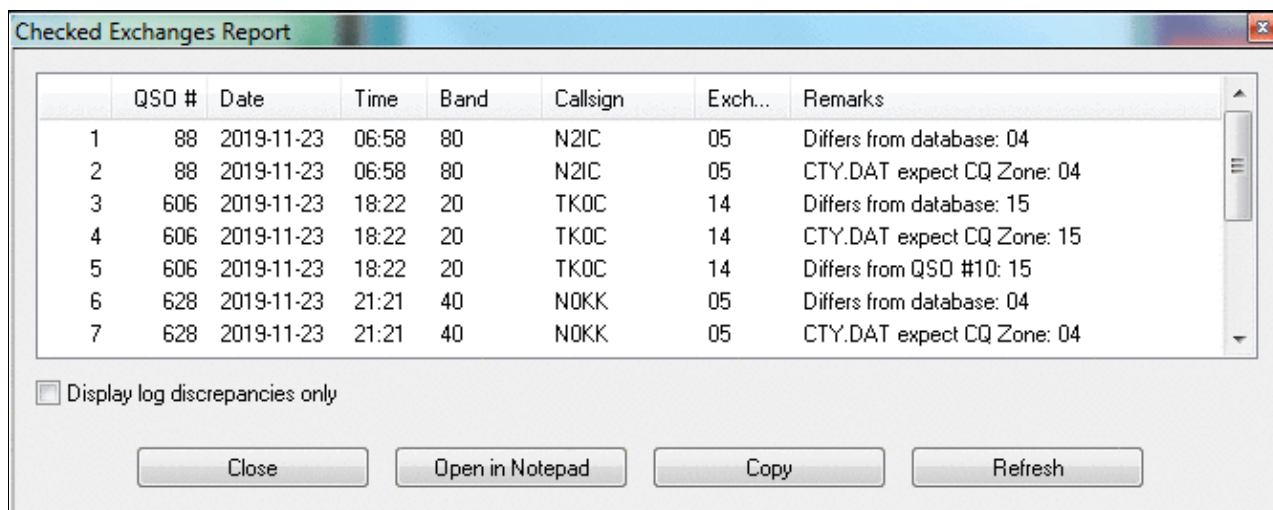

The screenshot shows a window titled "Checked Exchanges Report". It contains a table with 8 columns: QSO #, Date, Time, Band, Callsign, Exch..., and Remarks. There are 7 rows of data. Below the table is a checkbox labeled "Display log discrepancies only" which is unchecked. At the bottom are four buttons: "Close", "Open in Notepad", "Copy", and "Refresh".

QSO #	Date	Time	Band	Callsign	Exch...	Remarks	
1	88	2019-11-23	06:58	80	N2IC	05	Differs from database: 04
2	88	2019-11-23	06:58	80	N2IC	05	CTY.DAT expect CQ Zone: 04
3	606	2019-11-23	18:22	20	TK0C	14	Differs from database: 15
4	606	2019-11-23	18:22	20	TK0C	14	CTY.DAT expect CQ Zone: 15
5	606	2019-11-23	18:22	20	TK0C	14	Differs from QSO #10: 15
6	628	2019-11-23	21:21	40	N0KK	05	Differs from database: 04
7	628	2019-11-23	21:21	40	N0KK	05	CTY.DAT expect CQ Zone: 04

### Checked Exchanges Report

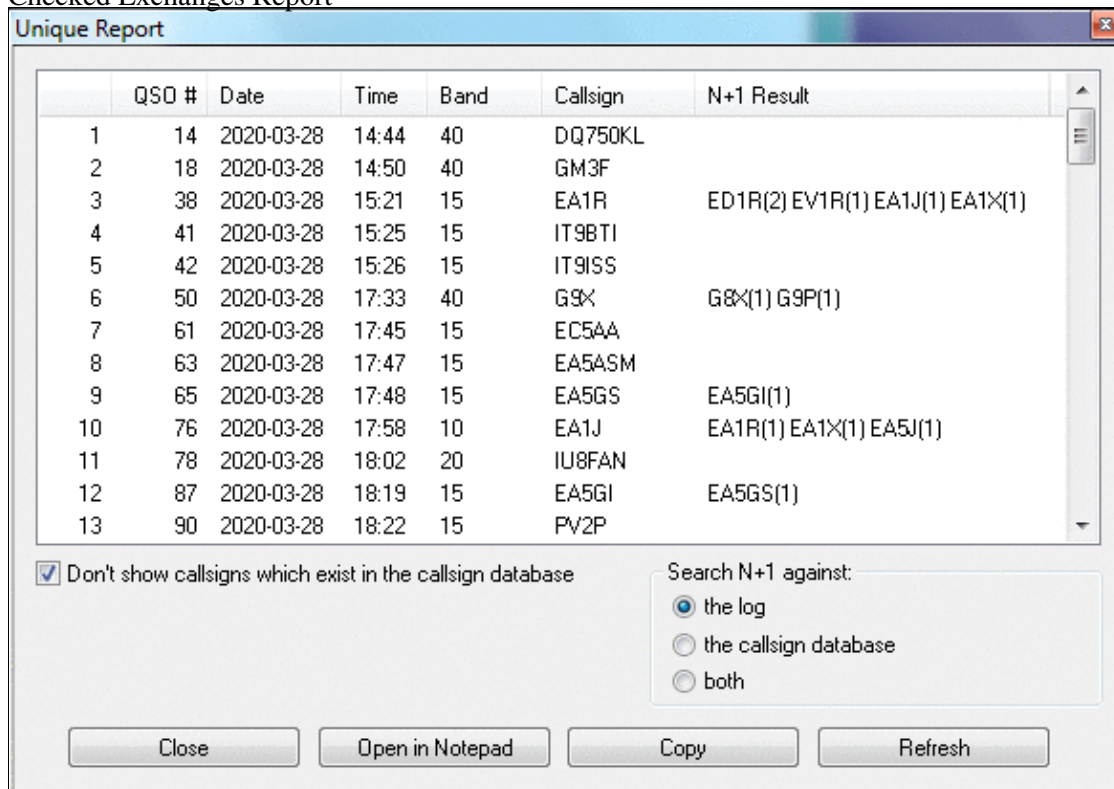

The screenshot shows a window titled "Unique Report". It contains a table with 7 columns: QSO #, Date, Time, Band, Callsign, and N+1 Result. There are 13 rows of data. Below the table is a checkbox labeled "Don't show callsigns which exist in the callsign database" which is checked. To the right of this checkbox is a section titled "Search N+1 against:" with three radio button options: "the log" (selected), "the callsign database", and "both". At the bottom are four buttons: "Close", "Open in Notepad", "Copy", and "Refresh".

QSO #	Date	Time	Band	Callsign	N+1 Result
1	14	2020-03-28	14:44	40	DQ750KL
2	18	2020-03-28	14:50	40	GM3F
3	38	2020-03-28	15:21	15	EA1R ED1R(2) EV1R(1) EA1J(1) EA1X(1)
4	41	2020-03-28	15:25	15	IT9BTI
5	42	2020-03-28	15:26	15	IT9ISS
6	50	2020-03-28	17:33	40	G9X G8X(1) G9P(1)
7	61	2020-03-28	17:45	15	EC5AA
8	63	2020-03-28	17:47	15	EA5ASM
9	65	2020-03-28	17:48	15	EA5GI(1)
10	76	2020-03-28	17:58	10	EA1J EA1R(1) EA1X(1) EA5J(1)
11	78	2020-03-28	18:02	20	IU8FAN
12	87	2020-03-28	18:19	15	EA5GI EA5GS(1)
13	90	2020-03-28	18:22	15	PV2P

Unique Report

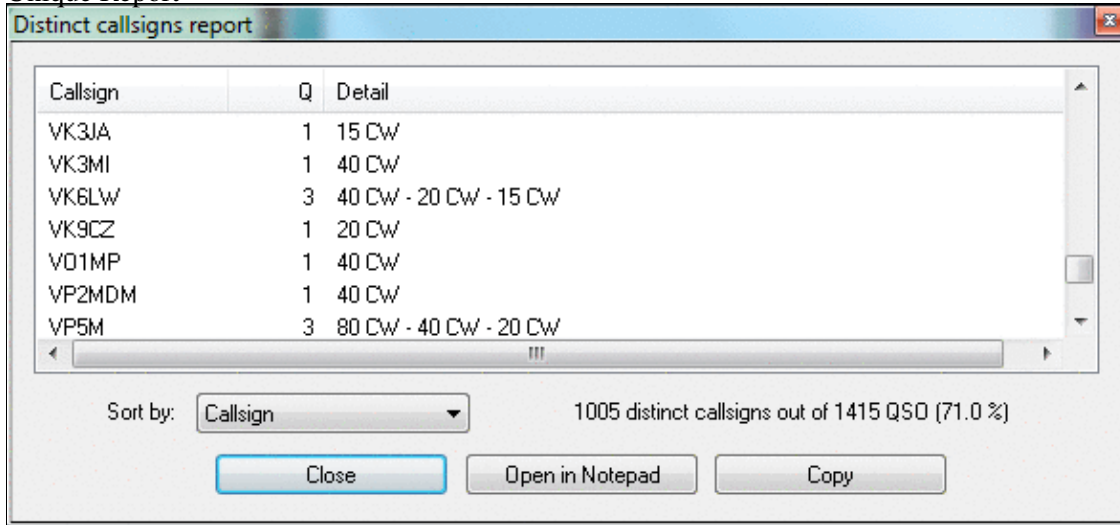

Distinct Callsigns Report - see who you worked on which bands/modes

You have the options of opening the report in a Notepad window for further processing. The Copy button allows you to Copy & Paste the data into a spreadsheet for comfortable filtering and processing. Additionally, you may press the Update button to create an updated report after you have done some changes to the log.

## Time shifting

This option allows you to **time shift** selected QSOs by any amount of time - either positive or negative. It lets you correct a constant time offset (like you had set the wrong date on the computer, or the clock was off by one hour). You may consider to use this option after the contest to avoid heavy manual editing of many QSO's time through the use of **Alt-F**.

The time shift can be applied to the entire log or to a range of QSOs, to the QSOs entered by your own station (this could make sense in a multi operator environment), to QSOs entered by several stations. Note that in a multi operator environment, one station should always be (or should have been) defined as the time master to establish a common time base in the network.

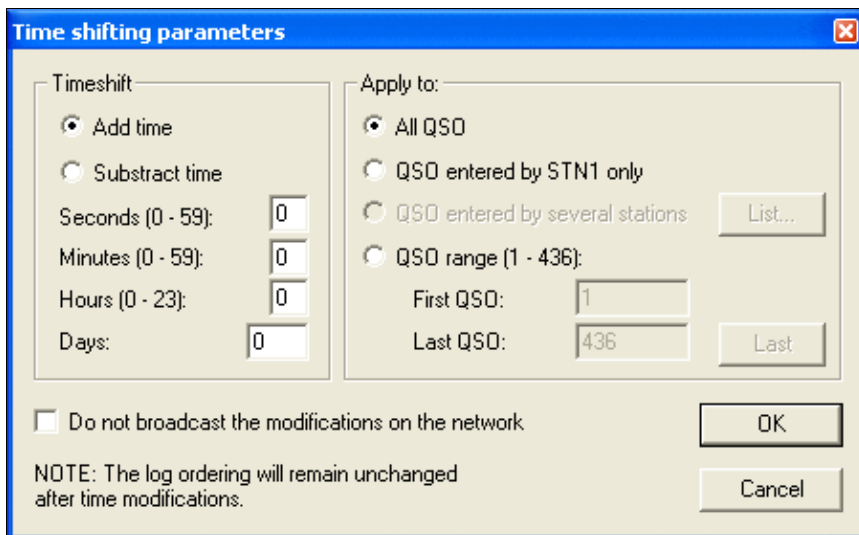

### Time Shifting Parameters

Even though this tool is supposed to be used after a contest to correct a wrong clock setting, each time change will be broadcasted to all other stations of the network by default. You can disable this broadcasting — if not needed.

Note that time shifting is pretty CPU consuming. It may take quite some time for large logs, because each QSO modification requires several internal structures (mainly statistics) to be updated accordingly. Time shifting **can not be cancelled** while it is in progress, to avoid any log inconsistency.

**Note:** Wise users will create a backup of their log before using this option.

## Correcting OP over a QSO range

This function lets you change (or add) the operator to a range of QSO. The QSOs are selectable by QSO number, by band, by mode or by callsign.

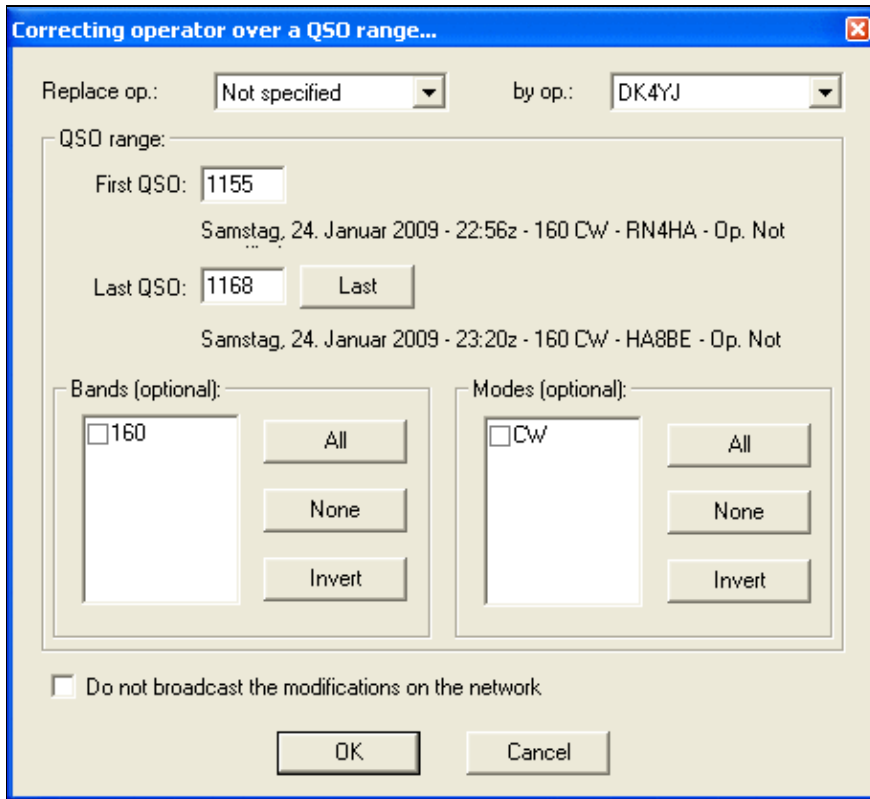

Tool to correct operator for a range of QSOs

## Download Files through the Network

To collect logs from different networked computers after a contest is over is the task of this function. Instead of having to visit each single computer, plug in the USB drive, copy the files over and move on to the next, this feature let's you collect the binary and notes files from all computers at once.

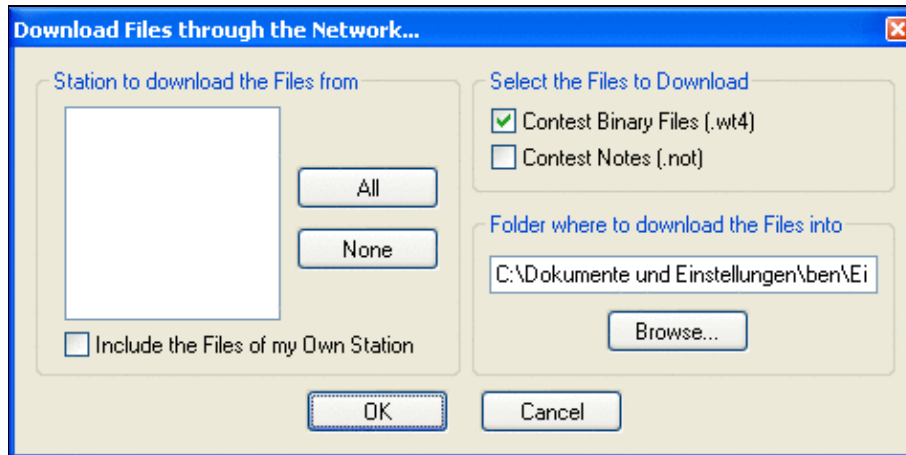

Collect files after the contest without leaving your chair

[Back to Menu](#)

## Namespaces

- [Page](#)
- [Discussion](#)

## Variants

## Views

- [Read](#)
- [View source](#)
- [View history](#)

## More

- This page was last edited on 9 April 2023, at 15:19.

- [Privacy policy](#)
- [About Win-Test Wiki](#)
- [Disclaimers](#)



# Menu:Windows

From Win-Test Wiki

[Jump to navigation](#) [Jump to search](#)

## Menu:Windows

Most of the windows have a context or "pop-up" menu which can be opened by right-clicking on the window.

All windows can be moved by "dragging" the title bar with the mouse pointer. Simply hold down the left mouse button while the cursor is over the title bar, and drag the window with the mouse. Another option is to hold down the **Ctrl** key and the left mouse button while the mouse pointer is positioned anywhere within a window (except for the RTTY reception windows), then drag.

**Tip:** Hold down the **Shift** key while dragging or resizing a window to "snap" it into position, right next to the edge of an adjacent window.

## Contents

- [1 Log Entry \(Main window\)](#)
- [2 Worked Gridsquares](#)
- [3 Worked Zones](#)
- [4 Worked DXCC](#)
- [5 Check Callsign](#)
- [6 Check Multipliers](#)
- [7 Search for Worked Multipliers or Partial QTH Locators](#)
- [8 Check Partial](#)s
- [9 Check N + 1](#)
- [10 Partner](#)
- [11 Status](#)
- [12 Skeds](#)
- [13 Solar Activity](#)
- [14 QSY Wizard](#)
- [15 Extra Information](#)
  - ◆ [15.1 XDT Files](#)
  - ◆ [15.2 Directives](#)
- [16 Summary](#)
  - ◆ [16.1 Live Score](#)
- [17 Rate](#)
  - ◆ [17.1 Graphs](#)
  - ◆ [17.2 Text Information](#)
  - ◆ [17.3 Context Menu](#)
- [18 Statistics](#)
- [19 Gab](#)
- [20 World Map](#)
- [21 Radio 1, Radio 2 \(Band Maps\)](#)
  - ◆ [21.1 Band Maps Context menu](#)
    - ◇ [21.1.1 Special cursors](#)
    - ◇ [21.1.2 Extended information](#)

- ◇ [21.1.3 Markers](#)
- ◇ [21.1.4 Segments](#)
- ◇ [21.1.5 Band Map properties](#)

- [22 Secondary Radio](#)
- [23 RTTY \(radio1, radio2\)](#)
- [24 Rotators](#)
- [25 DX-Cluster Monitor](#)
- [26 DX-Cluster Announcements](#)
- [27 NCDXF/IBP Beacons](#)
- [28 Clock](#)
- [29 Contest Recorder](#)
- [30 SSB bargraph](#)
- [31 Close all Windows](#)

## Log Entry (Main window)

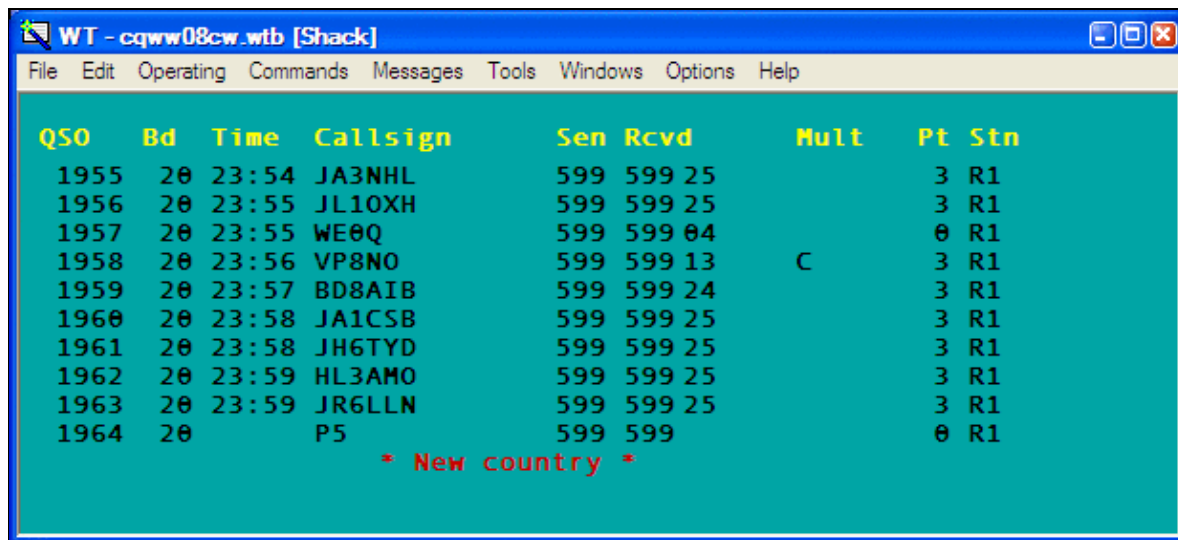

The screenshot shows the Win-Test main logging window titled "WT - cqww08cw.wtb [Shack]". The window has a menu bar with "File", "Edit", "Operating", "Commands", "Messages", "Tools", "Windows", "Options", and "Help". The main area displays a log of QSOs with the following columns: QSO, Bd, Time, Callsign, Sen, Rcvd, Mult, Pt, and Stn. The log contains ten entries, with the last one (QSO 1964) marked as a new country.

QSO	Bd	Time	Callsign	Sen	Rcvd	Mult	Pt	Stn
1955	20	23:54	JA3NHL	599	599 25		3	R1
1956	20	23:55	JL10XH	599	599 25		3	R1
1957	20	23:55	WE0Q	599	599 04		0	R1
1958	20	23:56	VP8NO	599	599 13	C	3	R1
1959	20	23:57	BD8AIB	599	599 24		3	R1
1960	20	23:58	JA1CSB	599	599 25		3	R1
1961	20	23:58	JH6TYD	599	599 25		3	R1
1962	20	23:59	HL3AMO	599	599 25		3	R1
1963	20	23:59	JR6LLN	599	599 25		3	R1
1964	20		P5	599	599		0	R1

\* New country \*

The Win-Test main logging window.

Use the Win-Test main window or "Log Entry" window to enter all QSOs made on the primary radio. The window displays the last nine QSOs in the log, plus a tenth line for entering the next QSO. The title bar displays the current log file name, the station name entered in the [Contest Configuration window](#) (e.g. "[Shack]"), and the current operator's callsign (for multi-ops that use the **OPON** or **LOGIN text commands**). By default, the Win-Test main window serves as a background for all other windows, but you may also choose to have every window "float" independently (see [Menu:Options#Windows](#)).

When you close the log entry window, Win-Test terminates.

Any QSO may be edited simply by typing over anything that needs correction. Use the **[Up arrow]** and **[Down arrow]** keys to edit previous QSOs. To restore the original QSO data, press **Ctrl-Z** before moving the cursor from that line. You can also delete a QSO (if single-op), though it is usually better to just enter a duplicate QSO -- see [Menu:Edit#Delete QSO](#) for more information.

When the cursor is positioned in the callsign field, data is entered in "insert mode", that is, typing does not replace characters, it only inserts them. In all other fields, data is entered in "overtyping mode". See [this entry in the FAQ](#) for the rationale.

The **[Spacebar]** key is used to quickly move the cursor back and forth between the callsign field and the received exchange field, skipping over the RST columns.

**Tip:** Enter a "?" character in the middle of a callsign or exchange as a placeholder for missing information, e.g. F?MZN. Then when you press **[Spacebar]**, the cursor will jump directly to the "?" character, and you can overwrite it with the missing data (even in the callsign field).

The **[Backspace]**, **[Del]**, **[Left arrow]**, **[Right arrow]**, **[Home]**, **[End]**, **[Ctrl][Left arrow]** and **[Ctrl][Right arrow]** keys operate conventionally, within a single field; they do not move the cursor outside of the current field.

The **[Tab]** key may be used to position the cursor under the RST sent column as well as callsign and exchange. The **[>]** and **[<]** keys work similarly, but they also allow you to move the cursor to the QSO time field for direct editing. You can also change the time, date, frequency, serial number sent and other fields of a QSO by positioning the cursor on any line and pressing **[Alt-F]** to display the Edit QSO pop-up menu.

You may scroll back through the entire log by pressing the **[PageUp]** and **[PageDown]** keys.

**Tip:** Press **Ctrl-PageUp** to scroll back in the log by 24 hours.

Enter a **QSO number** on the last line and press **[Ctrl-g]** to "Go to" that QSO number in the log. Press **[Ctrl-g] [Enter]** to return to the bottom of the log.

Enter a callsign, prefix or **beam heading** (0 to 360°) on the last line and press **[Ctrl]+[F12]** to rotate to that heading. Press **[Alt]+[F12]** for long (or "alternate") path. For more information, see Rotators.

Many other keys may be used in this window to assist with rapid data entry. For example, **[F11]** clears the entire QSO, whereas **Ctrl-W** clears only the current field. See Keys - Editing and moving around the QSO entry line.

The font size, background color, and header line attributes of this window may be adjusted by right clicking and selecting the **Log** option (see Menu:Options#Log). The yellow header text can be centered, left-justified, or completely hidden.

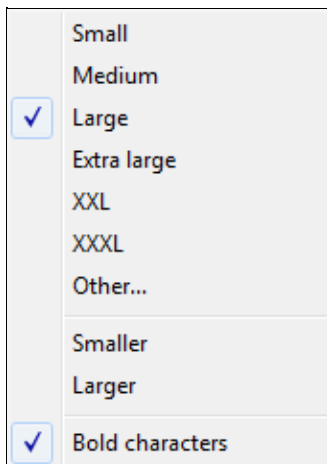

Changing the log font size of the log window.

The columns vary from contest to contest. In the CQ World-Wide example above,

- **QSO** - raw QSO number. Can be hidden using [Hide QSO numbers](#) (recommended for Multi-Multi contests with a sent serial number)
- **Bd** - band. Can be changed with [**Alt-F1**], [**Alt-F2**], or [**Alt-F**]
- **Time** - QSO time (UTC). Can be changed by moving the cursor with the [**<**] key, or [**Alt-F**]
- **Callsign** - Callsign of station worked.

**Tip:** Enter Win-Test [text commands](#) (menu shortcuts) in the callsign field.

- **Sen/Rcvd** - Sent and received exchanges
- **Mult** - multipliers and other information:
  - ◆ **C** - Country multiplier
  - ◆ **Z** - Zone multiplier
  - ◆ **DUPE** - Duplicate contact
  - ◆ **????** - Multiplier in received exchange field not recognized (e.g. unrecognized state or section abbreviation, zone number out of range)
  - ◆ **////** - Unrecognized country prefix
  - ◆ **!!!!** - Multiplier violation (non-mult worked by a Mult station in a Multi-single, band change violation, etc.)
  - ◆ *other* - Prefix, country, state, grid, etc. multiplier
- **Pt** - QSO points
- **Stn** - Station identifier (can be changed by pressing **Alt-Y** - see [Keys#Multi\\_Operator](#))
  - ◆ **R1/R2** - Run 1 or Run 2 (multi-two), or Radio 1 / Radio 2 (SO2R).
  - ◆ **R/M** - Run or Mult (Multi-single)
  - ◆ **+** (suffix) - Indicates QSO data entered by a support or [partner station](#)

Finally, a red information line at the bottom of the window displays additional information, such as

- **\* New zone \***
- **\* New country \***
- **\* Dupe with #1963 at 23:59Z 2008-11-30 (25) \***
- **\* Spotted by F5MZN \***
- Brief one-line packet cluster announcements of new multipliers

## Worked Gridsquares

Windows | Worked Gridsquares or **Alt-L**

Opens (or closes) the gridsquares window. The gridsquares worked are in grey, the red spots are the stations worked and the green spots are the stations spotted. The current gridsquare is displayed in red color to give an indication of direction. This works even with only four of the six characters entered.



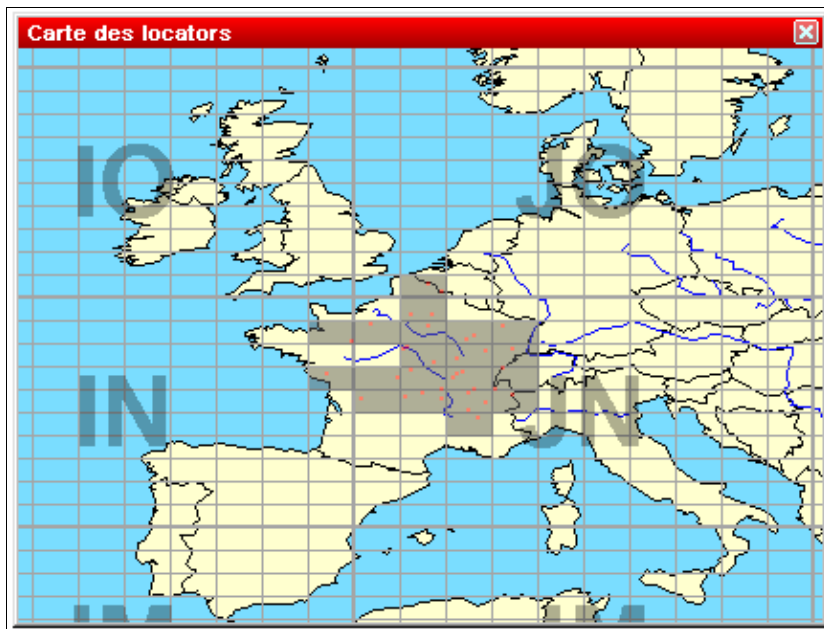

### Gridsquares Map

If the DX-Cluster Announcements window is opened and the gridsquare of a spot is known, passing the mouse over this spot will blink its location in this window.

Right click on the map to display the pop-up window:

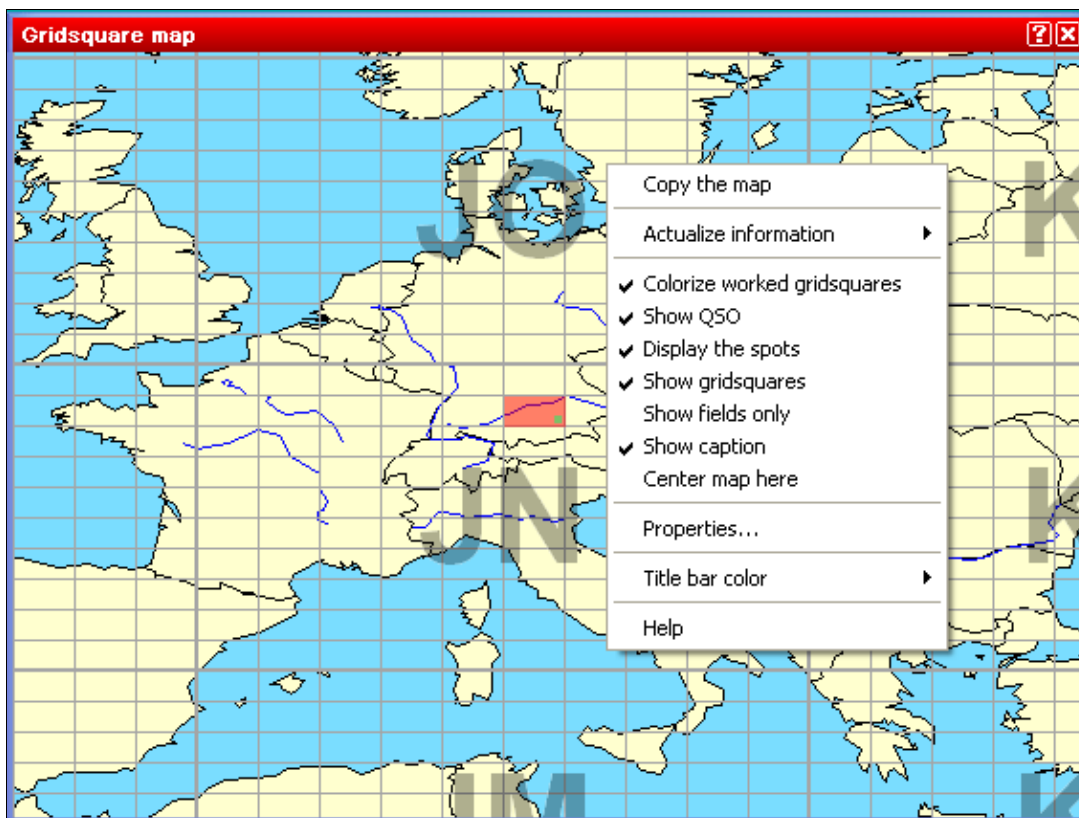

Gridsquare map pop-up window displayed by right-clicking on the map

- **Copy the map** copies the image to the Windows clipboard
- **Actualize Information** controls when the map will be updated:
  - ◆ Pressing the spacebar
  - ◆ Automatically
- **Colorize worked gridsquares** marks worked grid squares in gray
- **Show QSO** marks QSOs with a red dot
- **Display the spots** marks spotted stations with a green dot
- **Show gridsquares** draws the squares and the grid square lines
- **Show fields only** turns grid square outlines off
- **Show caption** displays the major grid square names (first two letters)
- **Center map here** lets you move the center of the map interactively.

**Note:** This option is available only if you have **not** selected "Always center on the operating QTH" in the Properties dialog (see below).

- **Properties...** allows you to modify several display parameters:

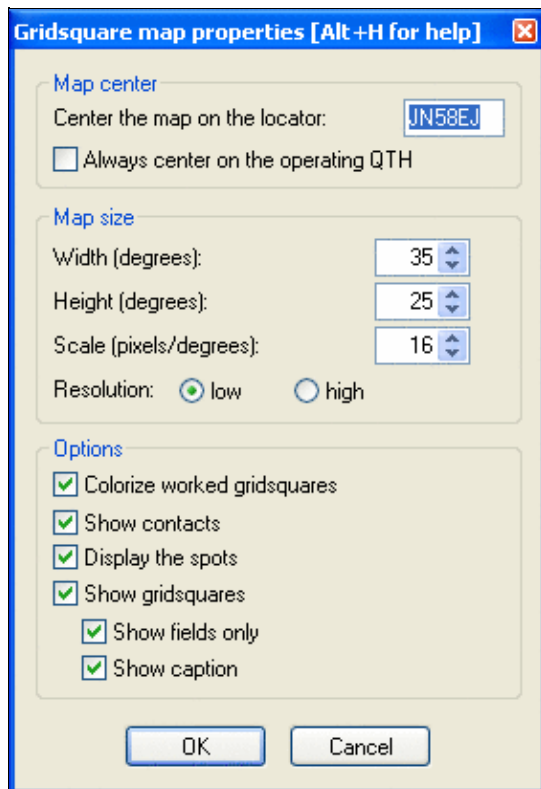

Gridsquares Map Properties

The larger the scale, the bigger the map.

## Worked Zones

Windows | Worked Zones or **Alt-Z**

Opens (or closes) the worked zones window. The title of this menu item will fit to the chosen contest. The window displays the worked multipliers (in blue) or not (in white) on the current band, and possibly the current mode.

Some examples:

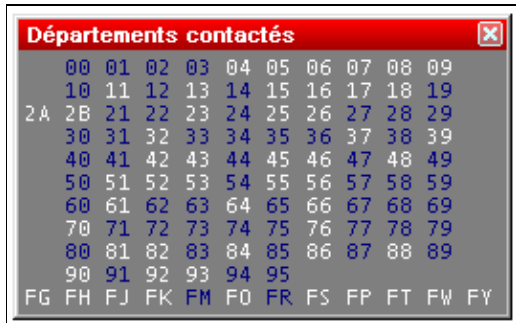

Worked departements window (French REF HF contest)



Worked states and provinces window (International ARRL DX contest)

Furthermore, with a right click on this window (if the contest is multi-bands and/or multi-modes) you can display the distribution of these multipliers by band (and/or mode).

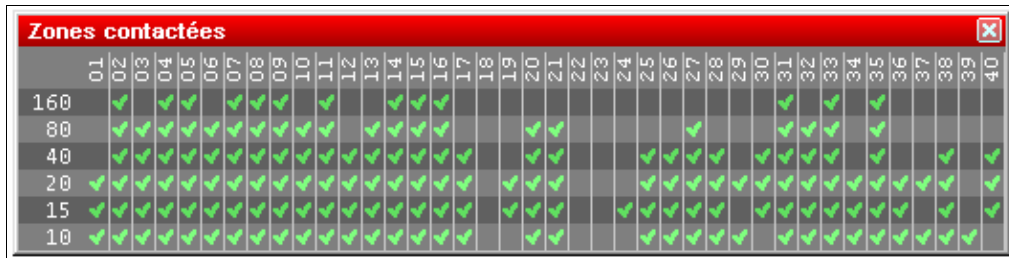

WAZ zones worked window by band (CQWW DX contest)

At last, the same contextual menu allows you to copy all the datas of this window into the clipboard as an image or a text, and directly paste it as a text file or an Excel (TM) or OpenOffice spreadsheet.

## Worked DXCC

Windows | Worked DXCC or **Alt-M**

Opens (or closes) the worked DXCC window. The title of this menu item will change with the contest chosen.

The screenshot shows a window titled "DXCC contactés" with a red header bar. The window is divided into two sections: "Amérique du Sud" and "Afrique", each with a yellow header bar. Each section contains a list of DXCC stations with their call signs and associated numerical data.

Amérique du Sud																				
3Y/p	: 160	80	40	20	15	10	8R	: 160	80	40	20	15	10	9Y	: 160	80	40	20	15	10
CE	: 160	80	40	20	15	10	CE0A	: 160	80	40	20	15	10	CE0X	: 160	80	40	20	15	10
CE0Z	: 160	80	40	20	15	10	CE9	: 160	80	40	20	15	10	CP	: 160	80	40	20	15	10
CX	: 160	80	40	20	15	10	FY	: 160	80	40	20	15	10	HC	: 160	80	40	20	15	10
HC8	: 160	80	40	20	15	10	HK	: 160	80	40	20	15	10	HK0/m	: 160	80	40	20	15	10
LU	: 160	80	40	20	15	10	OA	: 160	80	40	20	15	10	P4	: 160	80	40	20	15	10
PJ2	: 160	80	40	20	15	10	PY	: 160	80	40	20	15	10	PY0F	: 160	80	40	20	15	10
PY0S	: 160	80	40	20	15	10	PY0T	: 160	80	40	20	15	10	PZ	: 160	80	40	20	15	10
VP8	: 160	80	40	20	15	10	VP8/g	: 160	80	40	20	15	10	VP8/h	: 160	80	40	20	15	10
VP8/o	: 160	80	40	20	15	10	VP8/s	: 160	80	40	20	15	10	YW	: 160	80	40	20	15	10
ZP	: 160	80	40	20	15	10														

Afrique																				
3B6	: 160	80	40	20	15	10	3B8	: 160	80	40	20	15	10	3B9	: 160	80	40	20	15	10
3C	: 160	80	40	20	15	10	3C0	: 160	80	40	20	15	10	3DA	: 160	80	40	20	15	10
3V	: 160	80	40	20	15	10	3X	: 160	80	40	20	15	10	3Y/b	: 160	80	40	20	15	10
5A	: 160	80	40	20	15	10	5H	: 160	80	40	20	15	10	5N	: 160	80	40	20	15	10
5R	: 160	80	40	20	15	10	5T	: 160	80	40	20	15	10	5U	: 160	80	40	20	15	10
5V	: 160	80	40	20	15	10	5X	: 160	80	40	20	15	10	5Z	: 160	80	40	20	15	10
6W	: 160	80	40	20	15	10	7P	: 160	80	40	20	15	10	7Q	: 160	80	40	20	15	10
7X	: 160	80	40	20	15	10	9G	: 160	80	40	20	15	10	9J	: 160	80	40	20	15	10
9L	: 160	80	40	20	15	10	9Q	: 160	80	40	20	15	10	9U	: 160	80	40	20	15	10
9X	: 160	80	40	20	15	10	A2	: 160	80	40	20	15	10	C5	: 160	80	40	20	15	10
C9	: 160	80	40	20	15	10	CN	: 160	80	40	20	15	10	CT3	: 160	80	40	20	15	10
D2	: 160	80	40	20	15	10	D4	: 160	80	40	20	15	10	D6	: 160	80	40	20	15	10
E3	: 160	80	40	20	15	10	EA8	: 160	80	40	20	15	10	EA9	: 160	80	40	20	15	10
EL	: 160	80	40	20	15	10	ET	: 160	80	40	20	15	10	FH	: 160	80	40	20	15	10
FR	: 160	80	40	20	15	10	FR/g	: 160	80	40	20	15	10	FR/j	: 160	80	40	20	15	10
FR/t	: 160	80	40	20	15	10	FT8W	: 160	80	40	20	15	10	FT8X	: 160	80	40	20	15	10
FT8Z	: 160	80	40	20	15	10	IG9	: 160	80	40	20	15	10	J2	: 160	80	40	20	15	10
J5	: 160	80	40	20	15	10	S0	: 160	80	40	20	15	10	S7	: 160	80	40	20	15	10
CO	: 160	80	40	20	15	10	CT	: 160	80	40	20	15	10	CU	: 160	80	40	20	15	10

### Worked DXCC countries window

If one DXCC country has been worked on a band (possibly a mode), this band will be displayed in blue, otherwise it remains in white. This window is resizable.

A right click on this window allows to display the countries alphabetically sorted (within the same continent), or sorted by number of band/mode worked. More, to easily search for missing countries, the countries worked on all bands can be hidden (clean sweeps). Also, countries never worked in the contest can be hidden.

You can easily move to the next (or previous) bookmark - displayed on a yellow background by default - by holding the **Shift** key down, while rolling your mouse wheel.

Last, all the data included in this window can be copied as a text file, and pasted in text or directly in an Excel (TM) or OpenOffice spreadsheet, for a later analysis.

## Check Callsign

Windows | Check Callsign or **[F9]**

Opens (or closes) the worked callsign window. This window displays a checkmark if and on which bands a specific callsign has been logged before. Depending on the type of the contest, the display may show more than one column to display the different possible modes.

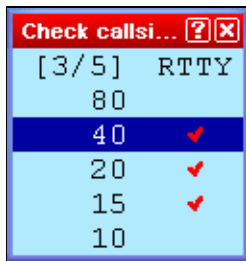

### The Check Callsign Window

Moving the mouse cursor over the checkmark will bring up additional information about this QSO. And a double-click on it will move the cursor to this QSO.

## Check Multipliers

Windows | Check Multipliers or **[F10]**

Opens (or closes) the checking multipliers window.

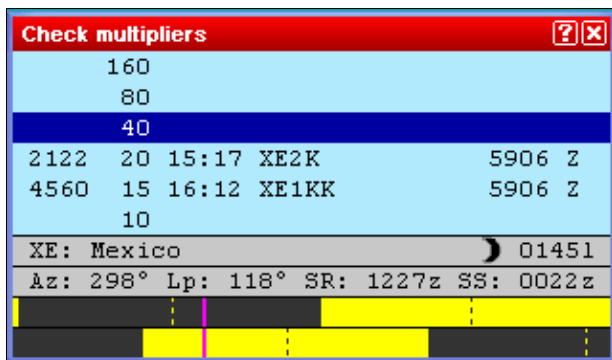

Check Multipliers window for the CQ World-Wide DX contest

To use this window, enter a callsign or country prefix in the data entry area of the main logging window. The dark blue line indicates the current band. The other lines indicate whether this multiplier has been worked or not on other bands (and in other modes if the contest rules permit). If the callsign entered has been worked on other bands, Win-Test displays those QSOs (in DXpedition mode, also the date of the QSO is displayed). Otherwise, the callsign of the first station worked in that multiplier on that band is displayed, if any. For the CQ World-Wide DX contest, display priority is: same callsign, same country and same zone. An uppercase "Z" in the last column indicates that the zone and country have been worked on the indicated band. A lowercase "z" means the zone has been worked, but not the country. And of course a blank line indicates that both the zone and country are needed. See also the [Search for Worked Multipliers](#) window.

Additional information about the multiplier is displayed at the bottom:

- The official country prefix and country name
- A small icon indicating if it is local day, night, or sunrise/sunset time in that country
- The current local time in that country (suffixed by a lowercase "l")
- The short (Az) and long path (Lp) beam headings (azimuths) to this multiplier (based on the station locator entered in the [Contest configuration screen](#))
- The sunrise (SR) and sunset (SS) time in this country, expressed as UTC (suffixed by a lowercase "z"). These times are computed from the geographical coordinates given taken from the CTY\* file or your QTH locator, if specified in the setup dialog.
- Graphical indication of the sun status on both sides of the QSO (may be disabled via the context menu)
  - ◆ Two yellow bars represent the sun over 24 hours of the day. The top bar displays the situation at the DX location, while the bottom bar represents your own location.
  - ◆ A pink cursor denotes current time.
  - ◆ Dotted lines represent local noon or local midnight.

A double click on a line will move the cursor to the specified QSO. Press [**Ctrl-End**] or [**Ctrl-G**], [**Enter**] to return the cursor to the blank line at the end of the data entry area.

Finally, using the context menu (right click on the window), you can change **Actualize information to Automatically** (recommended) or to **Pressing the space bar** to indicate when you want the check multiplier screen to be updated. "Automatically" updates the screen after each keystroke. Any modification in the received exchange field (e.g. zone) also updates this check multiplier window.

## Search for Worked Multipliers or Partial QTH Locators

Windows | Search for Worked Multipliers

Keyboard shortcut: **Shift+F10**

Lists all the callsigns logged in a specified multiplier (Zone, State, ARRL Section, Grid Square Locator, etc.).

To quickly list everyone you have logged in a particular multiplier, sorted by band, enter the multiplier in the *callsign* field and press **Shift+F10**. The [Check Partial Window](#) will be displayed in a different format, as shown below.

Résultat de la recherche des partiels			
80 :			
40 :	F5TRB	F6OXV	F8KLY
20 :	F6OXV	F8KLY	
15 :	F6OXV		
10 :			

Looking for a departement during the REF HF Contest

Résultat de la recherche des partiels			
160 :			
80 :			
40 :	JW5E	TF3W	
20 :	OX3UB	TF3W	
15 :	JW5E	OX3UB	TF3W
10 :			

Looking for a WAZ zone during the CQWW DX (Zone 40)

Résultat de la recherche des partiels						
160 :						
80 :	KE3VV	W3DOS				
40 :	KE3VV	W3DOS				
20 :	KA2OUS	KE3VV	W3DOS			
15 :	AJ3M	KE3VV	N3EPH	W3DOS	WA0LSS/P	WS6BR
10 :	AJ3M	KE3VV	N3WTO			

Looking for an US state during the ARRL DX Contest (here: District of Columbia, DC)

Any further typing in the callsign field restores the [Check Partial Window](#) to its normal appearance. You can also use **[Ctrl-W]**, **[Alt-W]**, or **[F11]** to erase the multiplier from the callsign field.

**Note:** This search only works for contests where the multiplier is logged as part of the exchange, so it doesn't work for the CQ WPX contest or the ARRL DX Contest (when operating from the U.S. and Canada).

For VHF/UHF/SHF... contests, this function is dedicated to partial QTH locator search. Enter the partial QTH locator either in the callsign or in the locator field and then press **Shift-F10**.

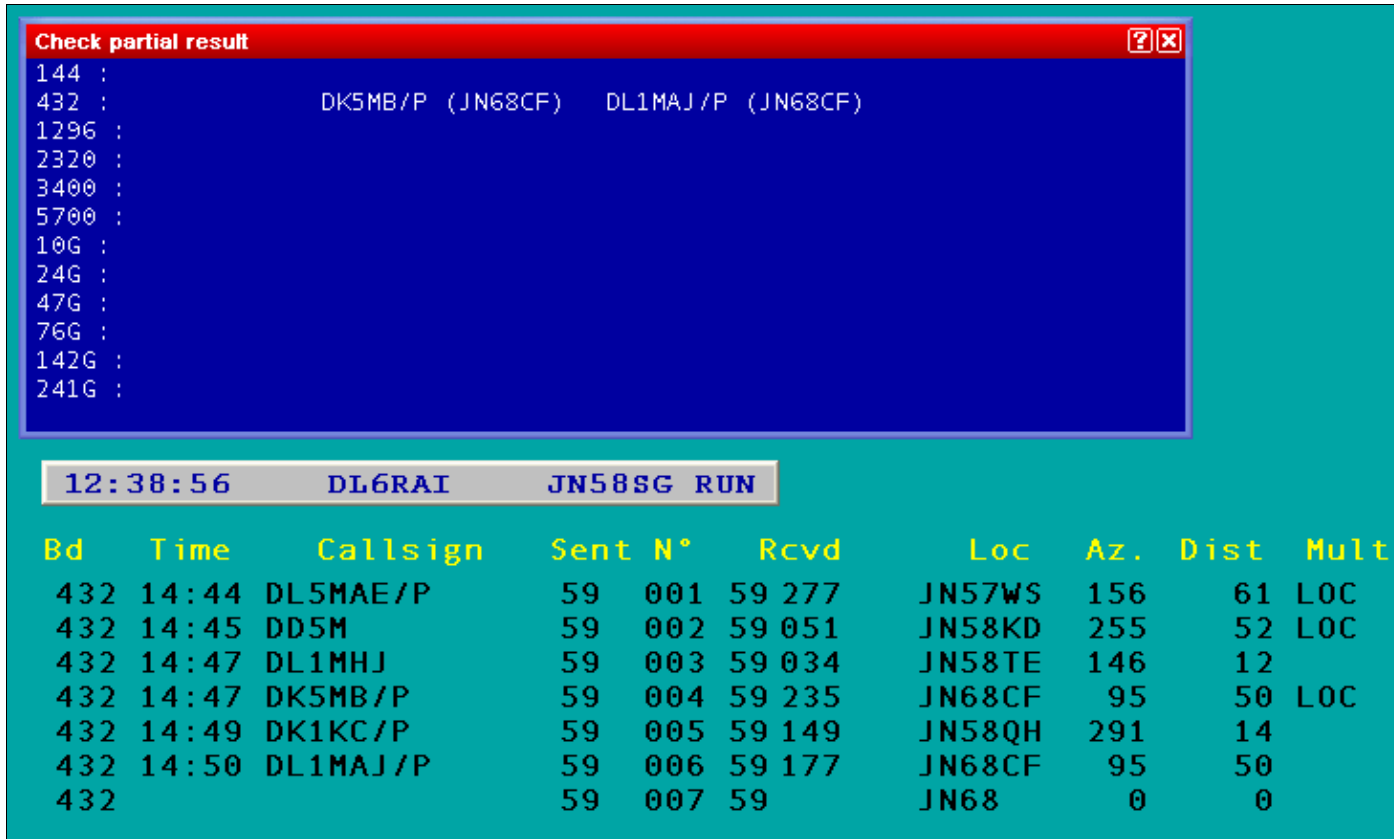

Searching call signs by QTH locator

## Check Partial

Windows | Check Partial or [F12]

Opens (or closes) the Check Partial window. The master file used is normally MASTER.SCP or DEFAULT.SCP or *contest.DTB*, as described under [Check Partial and Np1 Files](#).



Checking partials. Partial call sign entered: A2Q

If this window is open, and at least 3 characters are entered in the call sign logging field, Win-Test looks in the master database for the call signs including the 3-character string.

For example, in this upper screen-shot, the partial call sign entered is "A2Q". All the call signs found by Win-Test show this string.

The white call signs are those not worked yet. The green call signs are stations worked on another band, but not the current band. The red call signs are the dupes (call signs already worked on the current band).

You may also use the wildcard character "?" like "DL6?A?" to filter out unwanted calls.



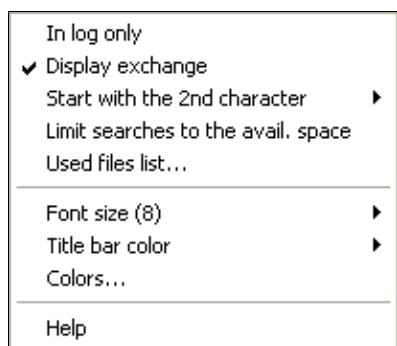

Available context menu options in the Check Partial window  
 Double clicking on a callsign copies it into the callsign logging field.

Right click in the window to brings up a context menu where you can choose if Win-Test is to use the master database or just your log. Another option is (in some contests) if you want to see the expected report in that window (from *contest.DTB*).

For slow contests, it might make sense to start the check partial search after the second letter is entered into the callsign field, rather than the third.

Another option allows you limit the number of callsigns displayed to fit the available space in the window.

Finally, the option **Used files list** will display the master file that Win-Test has loaded to feed the Check Partial window:

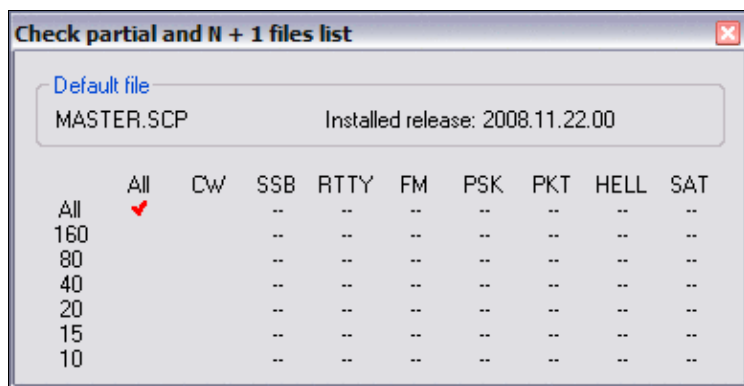

Used files list selected from Check Partial window pop-up menu

See [Check Partial and Np1 Files](#) for more info about naming super check files, search order, and how to update them.

In HF contests such as CQ World-Wide, you can enter a zone number in the **callsign** field and press **Shift+F10** to display a list of prefixes in that zone, and a list of stations worked in that zone.



Check partial window after entering 37 in the callsign field and pressing Shift+F10 to view countries in that zone. 5H3EE is in zone 37 and has been worked on 20m.

In VHF/UHF contests, pressing **Shift+F10** on a partial QTH locator changes the Check Partials Window to the Partial QTH Locator Search Window. This feature is helpful to identify stations in a VHF/UHF contest when you copy only the QTH locator.



Check Partial QTH Locator window

You may enter the partial QTH locator either in the callsign or in the QTH locator fields. A minimum of four characters has to be present in order to check the locator.

## Check N + 1

Windows | Check N + 1 or **[F8]**

Opens (or closes) the N + 1 window. The master file used is normally MASTER.SCP or DEFAULT.SCP or *contest.DTB*, as described under [Check Partial and Np1 Files](#).

If this window is open, and at least 3 characters are entered in the callsign logging field, Win-Test looks in the master database for the callsigns differing from the partial callsign by one character.

This command also detects 2-character swap (dyslexia), as well as one missing character.

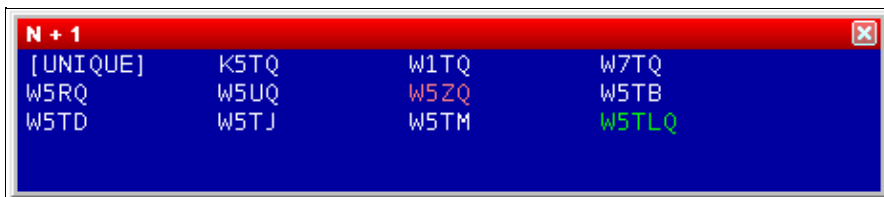

N + 1 window (Partial call entered: W5TQ)

If the callsign is not included in the master database, and has not been worked yet, it is considered a UNIQUE. Otherwise, it is displayed in the first position.



N + 1 window (Partial call entered: K3OK)

The white callsigns are the stations not yet worked. The green ones are those worked on another band, but not the current band. The red callsigns are dupes.

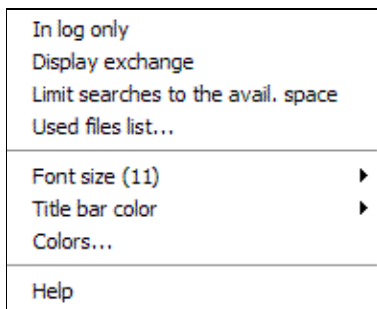

Available context menu options in the N+1 window

Double clicking on a callsign copies it into the callsign logging field.

A right click in the window brings up a context menu where you can choose to use the master database or just your log. A second option (in some contests) is if you want to see the expected report in that window (from *contest.DTB*). You may also wish to limit the number of callsigns displayed to the available space in the N+1 window. Finally, the option "Used files list" will display the master file that Win-Test has loaded to feed the Check Partials window.

## Partner

Windows | Partner

Opens (or closes) the partner window.



Partner window with two entries. You can now pull W6XR into the callsign field by pressing **Alt-1**

This feature is especially useful in a Multi-OP environment when facing large pile-ups and/or weak signals or when you are training a new operator.

Situation: You get several callers coming back to your CQ. You pull out one callsign - but sometimes you are able to copy another callsign or at least parts of it. If you could remember this second call after the first QSO, you'd be able to call the second station right away (without QRZ) and save time.

Improvement: Set up a second operator (OP2), a second computer and a second pair of headphones, sometimes a second receiver. Both OPs now open up the Partner window on their computer. The running operator OP1 continues like before: He works the first callsign. In the mean time, the OP2 supports OP1 to copy the callsign - or alternatively - he can add callsigns he copied from the pile-up by entering the callsign on the QSO entry field and then pressing **Alt-Enter**.

This callsign will now be displayed on all computers in the network that are set at the same band and mode. OP1 will see the new callsign after his first QSO and calls that station right away.

The Partner window can hold up to 9 callsigns, and these calls can be pulled into the callsign field with **Alt-1, Alt-2...Alt-9**. Usually this is done by OP1 to log that callsign, while OP2 uses this function to remove the call from the partner window. Once the QSO is logged, that callsign will disappear from both partner windows.

You can also swap the callsign field with one of the entries by pressing **Ctrl-1, Ctrl-2...Ctrl-9**.

Using message variables on CW and RTTY you can now enter a QSO (with correction or not), grab another callsign from the Partner window, and send the new report in one keystroke, by using:

```
$CORRECT TU $CR NOW $GRABPARTNER $NEXT $F2 (sends call if corrected before the TU)
```

for the **[Plus]** key, or

```
$CURRENT TU $CR NOW $GRABPARTNER $NEXT $F2 (resends full call before the TU)
```

assuming **\$F2** contains the report.

If you want to manually grab a callsign from the Partner window you can use:

```
$PREV TU NOW $LOGGED $F2
```

Then

1. Use the **[Enter]** key to silently enter the current QSO
2. Grab the next callsign from the Partner window (via double-click or Alt-n)
3. Send the message above

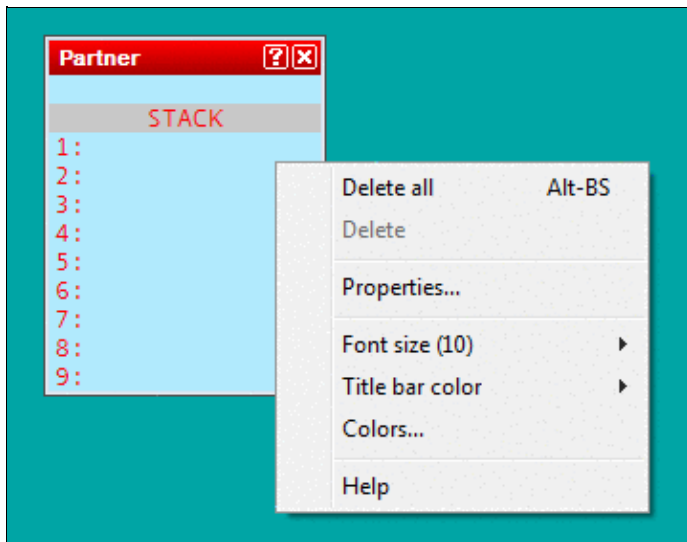

### Partner Window Context Menu

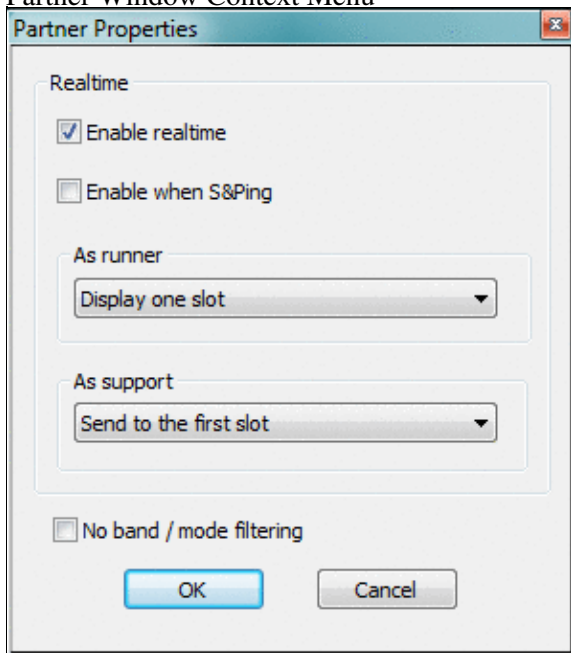

### Partner Window Properties

When a QSO is logged locally or via the network it is checked against the contents of the partner window, and - if found - removed from the partner window as it is now obsolete.

If automatic exchange guessing is enabled, a callsign grabbed from the partner window will have the exchange window filled in and will update the check partials and N+1 windows.

Finally, the entire Partner window content can be cleared by using the appropriate context menu item or by pressing **Alt-Backspace**. Individual entries can be removed via **Ctrl-Doubleclick**.

Up to three support partners can be engaged. If you do not want the partner to be limited by band and mode, use the "No band/mode filtering" option in the context menu of the partner window.

A **real-time** mode is available in the partner window's context menu. This allows the main operator to have a real-time view on what the partner(s) is(are) typing (character by character) so he/she does not have to wait until they press **Alt-Enter** in this time-critical situation. For this to work, the supporting partner has to change his station type to "Support" (see section [Menu:Commands#Station\\_Type](#)), indicated by **R+** on the QSO entry line.

In the context menu of the partner window there are two settings that can be done, when more than one partner (up to 3) is engaged:

- as support, must be selected to which slot this partner will send its real-time characters
- as runner, must be selected how many slot are being displayed at the partner window top

The runner will then grab a real-time slot with **Alt-Space**, or in all cases, he can also double-click on any callsign of this window.

## Status

Windows | Status or **Alt-J**  
Opens (or closes) the status window.

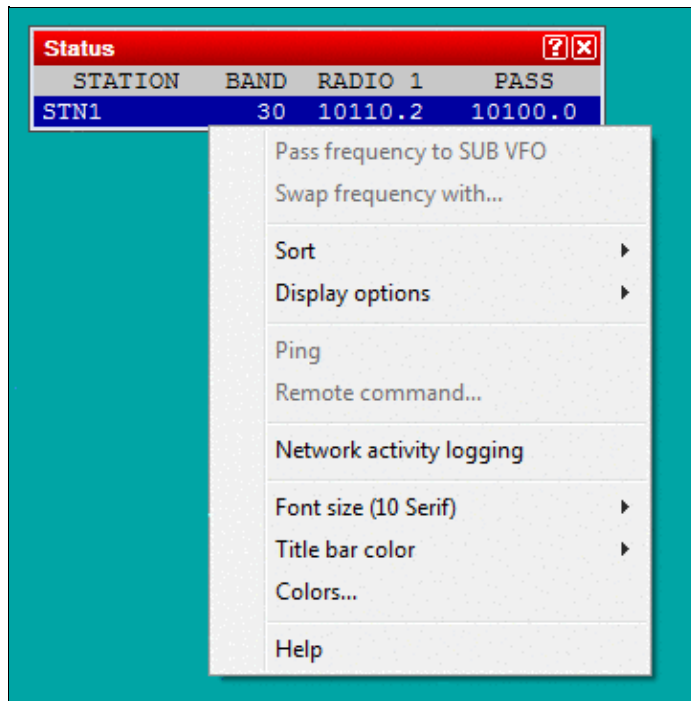

### Status Window

This window indicates the status of each station connected to the network. From left to right, are displayed :

- Station name
- Current band and mode
- Station type
- QSY frequency of the current band and mode
- Radio 1 frequency
- Radio 2 frequency
- Operator
- Time left before a possible QSY, according to the 10 minutes M/S rule, or "OK" if the station is allowed to make a QSY on another band. Note that this column only appears if the contest specifies this particular rule.

Your own station is displayed in a deep blue background. The active radio of each station has its frequency in red characters. The list may be by band and station names when it gets cluttered in a very large network by using the appropriate function in the context menu.

A double left click on a station name will display the chat dialog with this station name as default destination.

Opening the context menu with a right mouseclick will allow you to turn on network traffic logging. This might be useful for basic network troubleshooting. This log file uses the .ntk (stands for NeTwork) file extension.

Ping a specific station from the context menu on this station name and use "Ping XXX". The Win-Test version, the Master, Bridgehead, Sync indicators and the propagation time are returned in the Gab window (Alt-I). Reminder: You may also use the INV (stands for Inventory) text command to get a summary of the complete network.

A remote command to a specific station can be sent by opening the context menu on this station name and use "Send remote command to XXX...".

At last, a double left click on any frequency displayed will tune the current radio to that frequency.

## Skeds

Windows | Skeds or **Alt-B**  
 Opens (or closes) the skeds window.

Time	Frequency	Mode	Call Sign	Signal
12:59	21129.0	SSB	ZS6UN	[38]
13:14	14138.0	SSB	Z31CZ	[15]
13:18	14138.0	SSB	T94B	[15]
13:23	14138.0	SSB	MMOBRG	[14]
13:38	14138.0	SSB	EW1GA	[16]
19:14	21205.0	SSB	KHOAA	[27]
19:16	14138.0	SSB	KHOAA	[27]
19:21	14155.0	SSB	KHOAA	[26]
19:23	14247.0	SSB	AH2R	[27]
19:38	14138.0	SSB	VE8JL	[01]
21:25	14138.0	SSB	YS1JBL	[07]
21:35	14138.0	SSB	YS1JBL	[04]
23:41	7015.0	SSB	HSOZAA	[26]
23:43	7015.0	SSB	VP2MEG	[08]
23:49	7015.0	SSB	J69EN	08
23:55	21130.0	SSB	VP2MEG	[08]
00:43	7015.0	SSB	KL7HBK	[01]
01:34	7015.0	SSB	6Y4Y	[08]
01:37	7015.0	SSB	HK1JMF	[09]
02:39	3795.0	SSB	LW7DX	[13]
04:22	3751.0	SSB	5JOX	[07]
04:24	3730.0	SSB	LZ9W	[20]
06:03	1825.0	SSB	VE3BW/HR9	[07]
06:13	3775.0	SSB	TU2CI	[14]
06:17	1825.0	SSB	GMOB	[14]
06:26	3775.0	SSB	TG9AVV	[07]
06:27	3775.0	SSB	TG9AVV	[07]
06:34	1826.0	SSB	GI3NVW	[14]
06:42	1826.0	SSB	TI8M	[07]
06:45	3775.0	SSB	KH7X	[31] dans 8 min il nous entend !!!
06:59	3675.0	SSB	EA9PY	[33]



### Skeds Window

Skeds (Alt-E) and passed stations (Alt-D) are displayed in this window. See [Multi-op/Passing](#).

- A grey background means that the sked is over for more than 10 minutes.
- A yellow background means that the sked is planned within less than 10 minutes maximum (a "hot sked"). If the window was not open, it will pop-up to remind the operator of the hot sked. The pop-up will be suppressed, however, if Win-Test is running minimized.
- A green background means that the sked is planned in more than 10 minutes.

A - (minus) sign before the hour means that the sked is over for more than 24 hours. A + (plus) sign before the hour means that the sked is planned in more than 24 hours.

A right click allows to sort the skeds window by time or by band. You can also hide the older skeds, and modify or cancel a sked. In a multi operating configuration, the sked data are sent across the network.

At last, note that a double left click will tune the current radio on the sked frequency and capture the callsign of the scheduled station in the callsign logging field. You will thus just need to press [**Return**] after completing the QSO!

## Solar Activity

Windows | Solar Activity

This option displays solar activity data that has been received from the DX cluster connection. You can chose between SSN, SFI, K and A indexes. It is an interesting tool to discover trends in propagation during a contest.

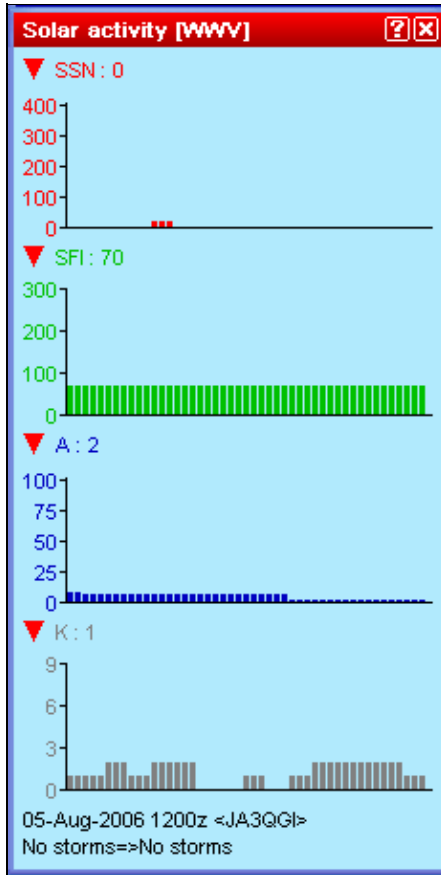

Solar Activity Window (WWV data)

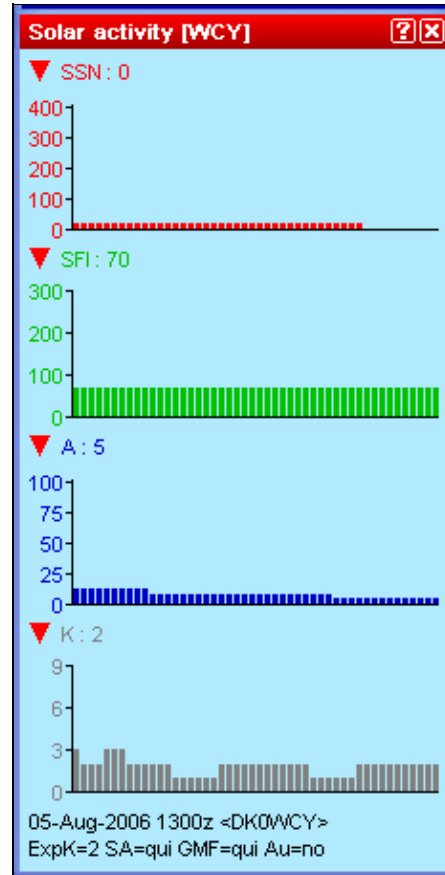

Solar Activity Window (from DK0WCY)

As there are two sources on the DX cluster for this kind of information, you may chose between WWV and WCY. This information can also be applied - in conjunction with HamCap - for specific propagation forecasts. See [Menu Options HamCAP](#) in this manual.

Click on the triangles to open or close a chart. You may open or close all charts at once by holding the **[Shift]** key down while clicking on one of the triangles.

## QSY Wizard

Windows | QSY Wizard

The QSY Wizard can only be used if [HamCAP](#) is installed and running. You must also have [Options | HamCAP | Tab](#) set to **Charts**.

After working a DX, pressing **Ctrl-P** will bring up the HamCAP window with a propagation prediction to this DX. Then, the QSY Wizard will display the bands on which to which a QSY or sked may be useful:

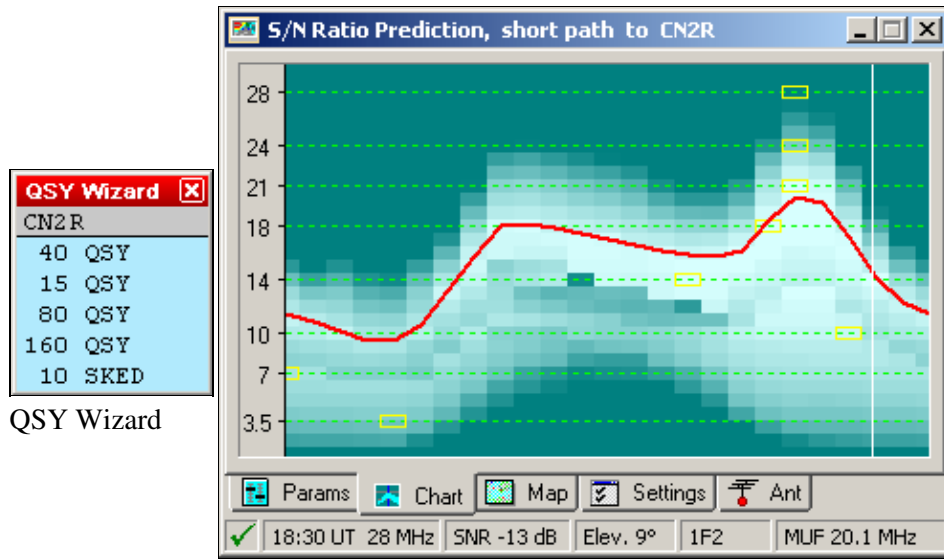

HamCAP prediction to CN2R

In the above example CN2R has been worked on 20m. After pressing **Ctrl-P** the wizard tells us that a QSY may be promising to 15, 40, 80 and 160m. For 10m, however, the wizard recommends a sked at 18:30 UT instead. This is the peak time predicted by HamCap for this path but MUF will be only be 20.1 MHz (the mouse cursor was over the 18:30/28MHz yellow square while creating this screenshot).

## Extra Information

This window displays data included in .XDT (eXtra DaTa) files. These files are textual and have a very basic syntax. These files are suitable for name lists (your favorite contest friends or club members, whose names you never get to remember in the middle of the contest) or information about a station's capabilities on other VHF/UHF/SHF bands so that you will want to ask for a sked.

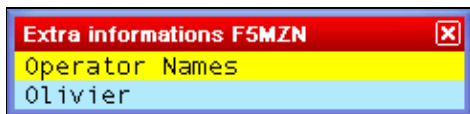

The Extra Data Files Window can be used to display additional useful information during the contest.

## XDT Files

The first column is the callsign of the station for which information is to be displayed. The rest of the line carries the information to display. There can be only one line per callsign. Lines have to be formatted in MS-DOS mode, i.e. CR/LF at the end.

You can set up to 10 default extra data files by the menu function **Options | Data files | Default data files**. These files will be opened with every log. They must be located in the WT installation directory. Refer to [Menu: Options Default extra data files...](#) for detailed information.

You can also add **log-specific** extra data files by using the **Extra files...** item in the context menu of this window (right-click to open the contextual menu). A new window will open-up where you can click the ADD button to browse the computer resources to locate and select the file you need (see picture).

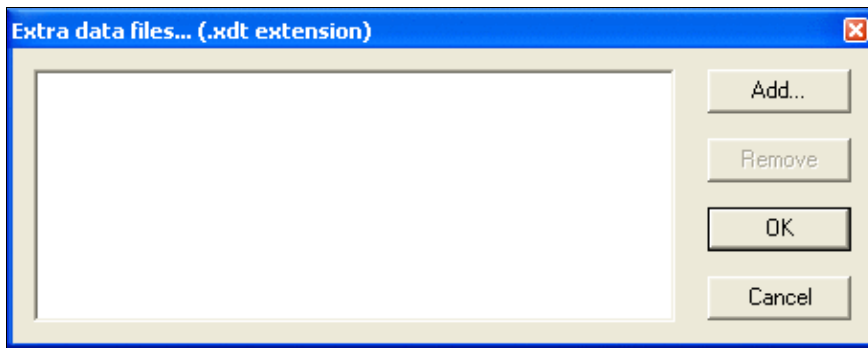

Click the ADD button to locate and select the file you need

There is no limitation to the location and the number of these log-specific files. The added file names and paths will then be save in a file with **.xdl** extension among all the other contest specific files (.LOG, .SUM, .pkt, .gab, .wtb, etc.).

If you modify an **.XDT** file while it is in use, you must reload it by using the **Reload files** item in the context menu.

**Note:** This function is designed to work with no more than a few thousand callsigns only. Don't try it with millions of lines or a Callbook file!

## Directives

Directives are special statements in the data file beginning with a hash sign and a space.

The **# TITLE** directive is used to display a title in the window, like this:

```
# TITLE Operator Names
CT1BOH Jose
DJ1YFK Fab
DL4NER Werner
DL6RAI Ben
F5HRY Herve
F5MZN Olivier
F6FVY Larry
M0CLW Simon
M3PHP Peter
```

The **# VARIABLE** directive allows you to send the extra information in a CW message by using a variable name. The variable name **must** begin with the \$ character.

Example: The following line will substitute the \$OPNAME string in the CW messages with the extra info included in this file, if the sent callsign has matching data.

```
# VARIABLE $OPNAME
```

**Note:** The variable substitution only works with the internal CW keyer.

## Summary

Windows | Summary or **Alt-S**

Opens (or closes) the scoring summary window.

Récapitulatif						
BANDE	QSO	DBL	DXC	CQ	POINTS	MOY
160	102	3	50	13	280	2.75
80	328	5	81	21	942	2.87
40	916	31	119	29	2652	2.90
20	1208	17	140	35	3532	2.92
15	2297	69	145	34	6701	2.92
10	4334	137	145	33	12762	2.94
TOTAL	9185	262	680	165	26869	2.93
<b>SCORE FINAL : 22 704 305</b>						

### Summary

The displayed number of QSO does not include the dupes. Thus, the QSO column displays only the QSO that have generated points.

A right click allows to copy the scoring summary data in the clipboard as an image or as a text file (in WT language or in English, depending on the contest).

## Live Score

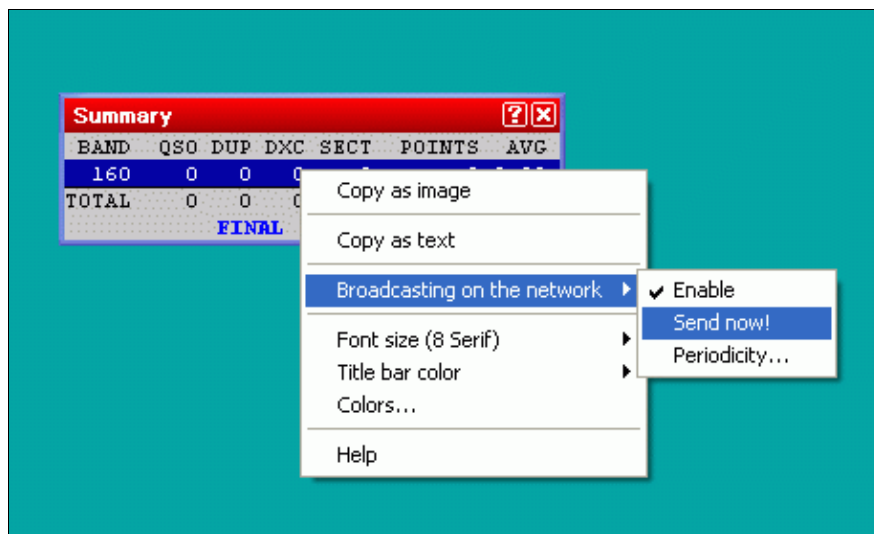

Enabling Live Score Broadcasting through the context menu

The context menu also allows you to configure and enable live score reporting by using a specific UDP broadcast protocol [1]. Please note that additional third-party software is needed to post your score to one of the live scoreboards on the internet.

For testing purposes, there is an option to create a live score broadcast "now"; typically, it will be broadcasted automatically once every five minutes or however you set up the periodicity. Live score broadcasting in a multi operator environment is limited to the station that is the network time master.

For further information about live scores, please see [2] and [3] (German language).

## Rate

Windows | Rate or **Alt-R**  
Opens (or closes) the rate window.

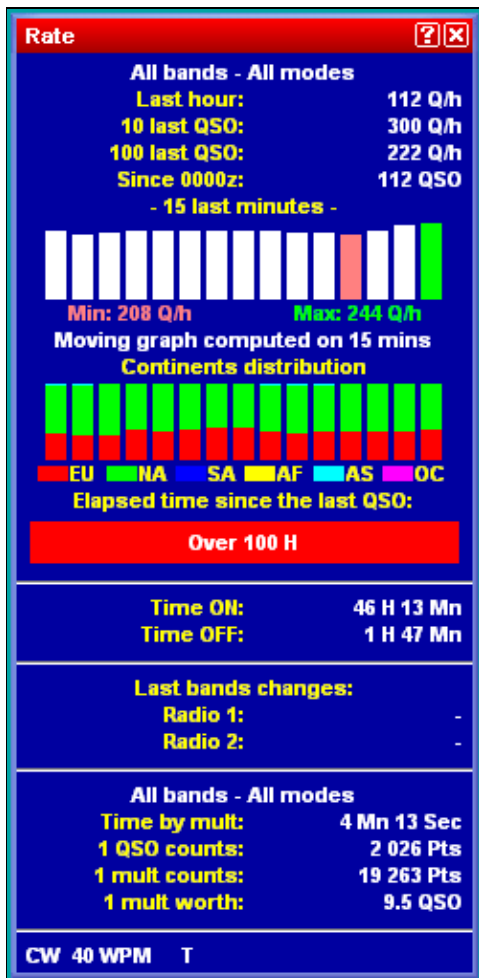

## Rate Window

This window is divided in different parts:

The upper part displays the rate of the last hour, of the last 10 QSO, and of the last 100 QSO. It also displays a moving graph of the rate, computed on the last 15 minutes before the current QSO. The lower portion of that window displays additional rate information in text format.

## Graphs

The graph is calculated on the last 15 minutes (default). Each bar, thus representing one minute on the air, calculates the moving average rate on the last X minutes, this time being selectable between 5 to 30 minutes. A short period will be selected for a contest with high rates (international HF, such as CQWW or WPX), and a longer one for a contest with slower rates (such as a national HF, or a VHF).

Below is a display that shows instant continent distribution of previous QSOs. It uses the same timing parameters as the instant rates above.

The QSO Timer Alarm progress bar appears below that. This bar gives a clear visual indication of the time elapsed since your last QSO. Right click and select **Off-time timer alarm** to set the full scale range of the progress bar. In the screen shot above, it is the red bar showing over 100H elapsed since the last QSO, but normally it is a green progress bar that advances from left to right. It begins as 100% green and slowly more of it turns red until it reaches full scale, when the bar becomes 100% red. The default scale is 5 minutes, but it is configurable between 1 and 120 minutes.

## Text Information

The next part displays information about Time ON and Time OFF. For new logs, the off-time calculation is based on the contest rules. You can still use a custom setting to check your operating efficiency. Right click and select **Off-time calculation threshold**. If the contest rule is unknown, 30 minutes will be used as a default threshold.

The next part shows information about band changes.

The central part gives general information about the point statistics of the contest, e.g. time by mult, QSO counts, Mult worth, etc.

The bottom part indicates the current mode and, in CW, the current speed, as well as the status of the automated CQ repeat mode. Some indicators that may appear there include:

- **CW** - Operating mode is set to CW (press **Ctrl-F1** or **Ctrl-F2** to change)
- **SSB** - Operating mode is set to Phone
- **RTTY** - Operating mode is set to RTTY
- **34 WPM** - CW speed in Words Per Minute (adjust with **Alt-F9**, **Alt-F10**, and **Alt-V**)
- **34/32 WPM** - Independent CW speed between Win-Test and WinKey pot (WinKey speed displayed on right)
- **S** - Operator is listening in Stereo mode (operator pressed **AltGr-S** or **Ctrl-Alt-S**, press **AltGr-A** or **Ctrl-Alt-A** to remove)
- **T** - Operator is listening to the Secondary Radio (operator pressed **AltGr-T** or **Ctrl-Alt-T**, press **AltGr-A** or **Ctrl-Alt-A** to remove)

- **REPEAT** - Automatic repeating CQ feature is active and [**F1**] has been pressed. See [Automatic CQ Repeat](#).

## Context Menu

A right click allows you to choose on what bands and modes these calculations have to be done:

- All : No filtering is done
- Current : Filters only QSO done in the mode and band of the current radio
- According to QSO : Filters only QSO done in the mode and band of the current QSO

You can also choose to display the calculations as :

- QSO / h : Only based on the number of QSO
- Points / QSO : Averages the points of the QSO
- Points QSO / h : Without the multipliers
- Points / h : Including the multipliers

Thresholds are defined and can be modified on the following properties:

- Instant moving graph window -how many minutes of history are taken into account
- Off Time Alarm - after how many minutes the color of the green bar will turn red
- Off-time calculation - after how much time of no QSO, time is counted towards off-time (may be contest specific)
- Last band change method - which event triggers the timer after a band change

Moreover, the contents of the rate window can be customized by selecting one or more of the following, which are listed under the **Display** menu item of the context menu:

- Instant rate moving graph
- Instant continents distribution
- Off-time timer
- Time ON / Time OFF
- Band Changes
- Band Changes elapsed times
- QSO/Mult ratio
- Distances Data

Finally, right click and select the **Copy** menu item to copy this window, as an image, to the Windows clipboard.

**Note:** The available menu items in the context menu may vary depending on where you right click in the window.

## Statistics

Windows | Statistics or [**Ctrl-F9**]  
Opens (or closes) the Statistics window, a rate sheet.



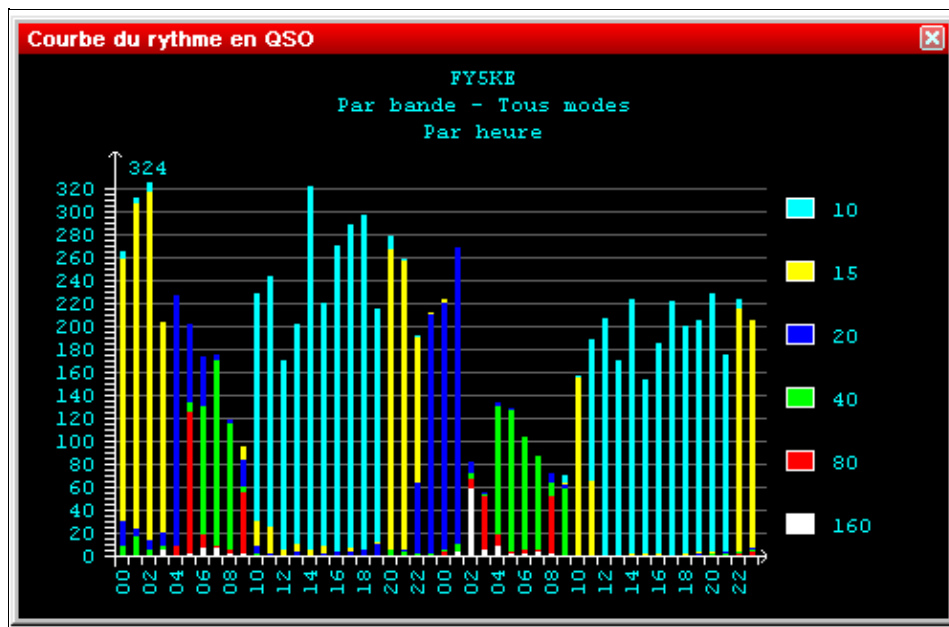

Statistics Window showing total QSOs made on all bands and modes, per hour  
 The size of this window can be changed by dragging the edges. The window displays the number of QSOs, hour by hour, for the entire contest period.

The time span is fixed depending on the contest type. For the shorter contests, the display spans 24 hours; for the major contests, it spans the full 48 hours. For DXpeditions, it is configurable from 1 to 15 days via the [Days...] button in the Contest Configuration window.

Switching to the **Targets** tab in the statistics window, you may compare your current score to a pre-loaded estimate, which may be derived from a previous contest operation or generated by hand. Positive offsets with respect to the target file are shown in green color, negative offsets in red color.

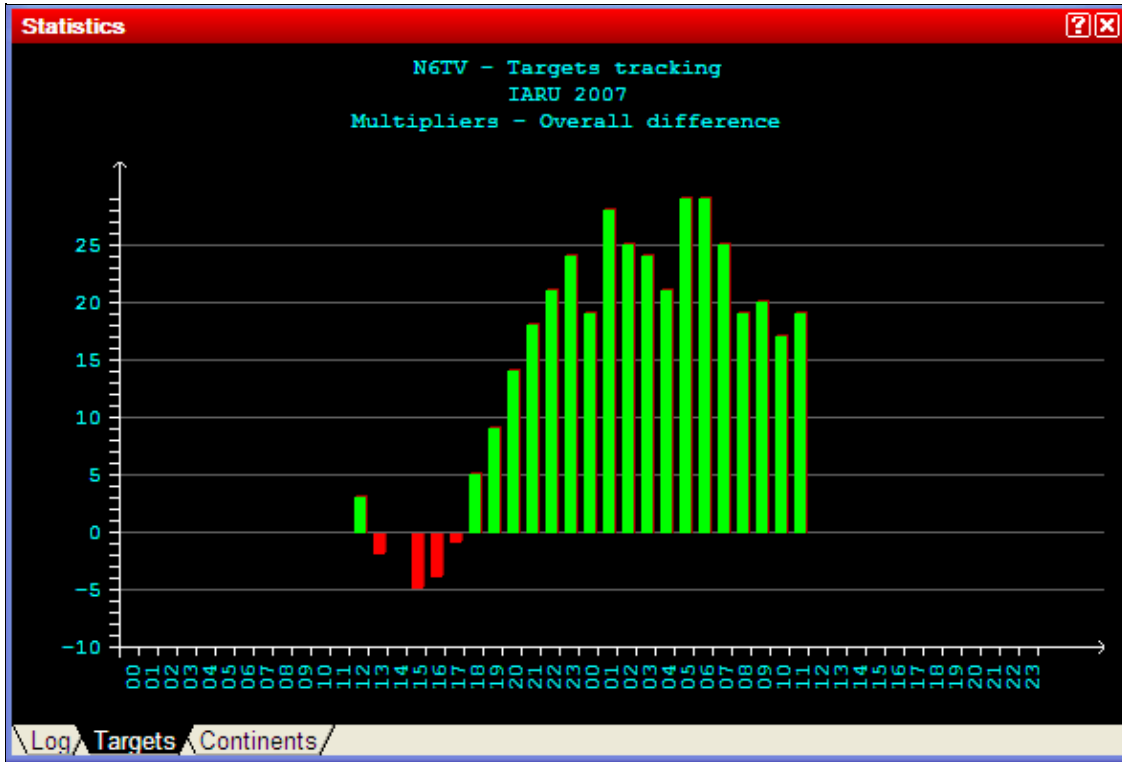

Cumulative (overall) Multiplier tracking vs. target  
You may also display hour-by-hour comparisons with the targets.

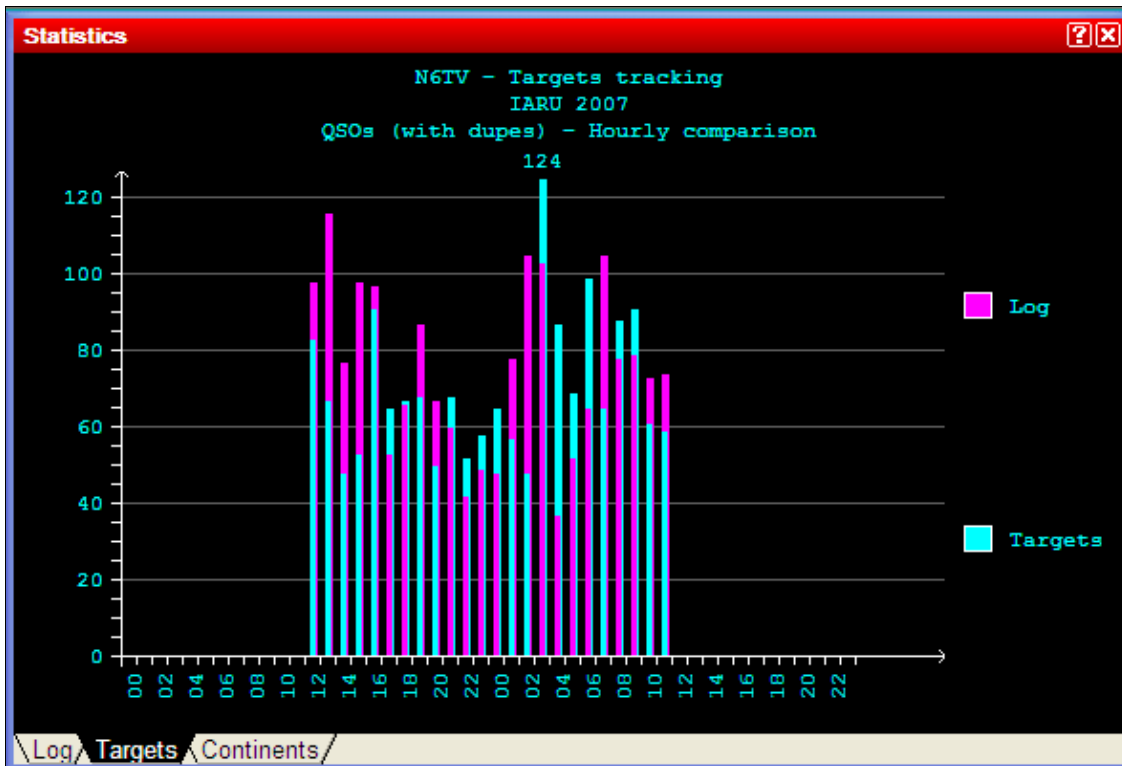

Hour by hour QSO tracking vs. target

Please see [Menu | Tools | Load a targets file...](#) for further information on exporting and loading target files.

Switching to the **Continents** tab displays continental QSO statistics.

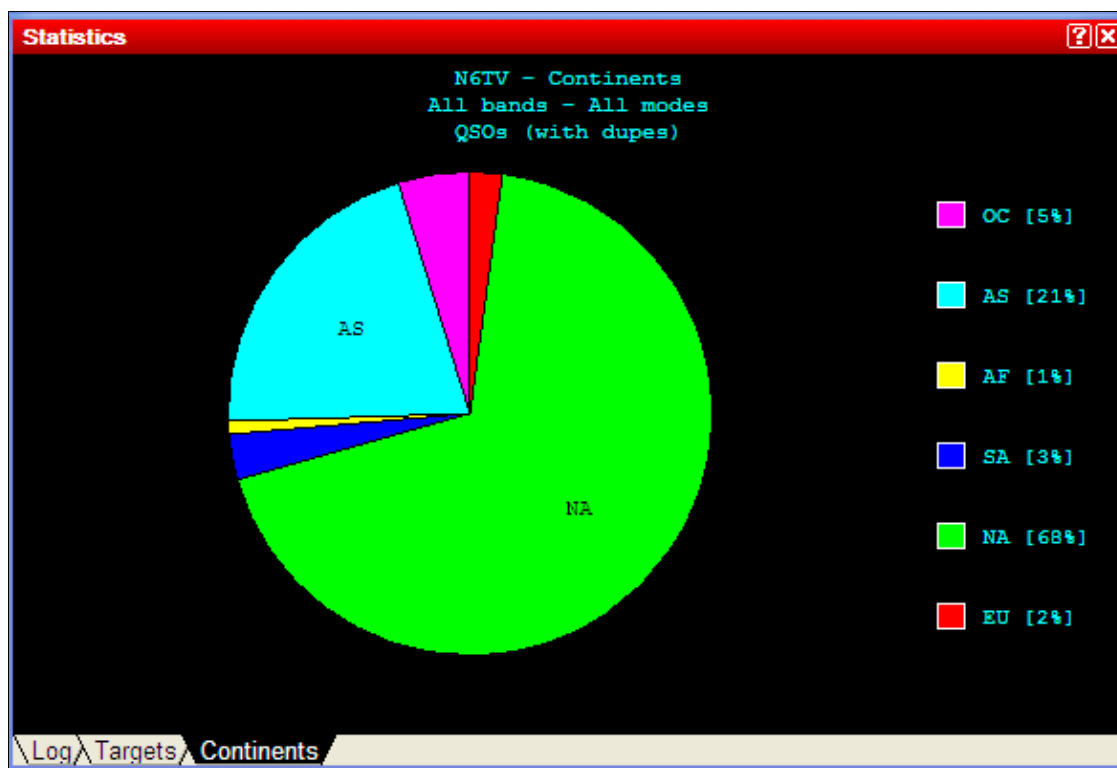

Continental QSO statistics

A right click allows to set different display options:

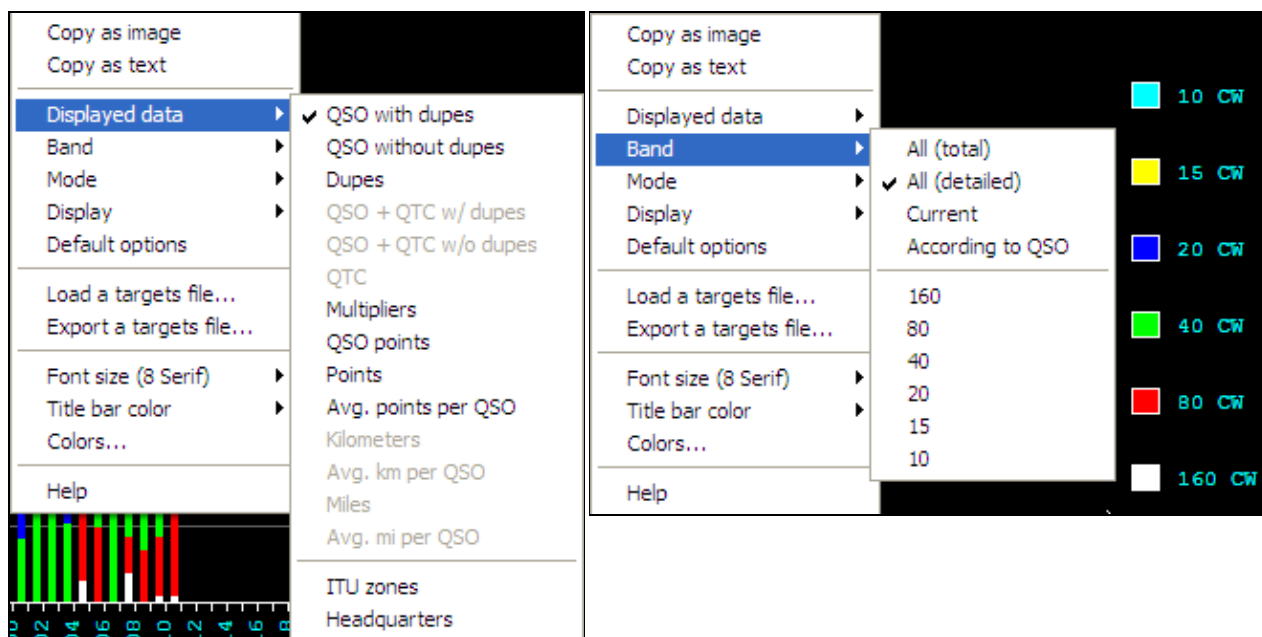

## Win-Test Wiki

Pop-up menu showing displayed data options    Pop-up menu showing band options  
Displayed Data

- Select which kind of data to display: QSOs, Multipliers, QSO Points, etc.

### Band

- All (total): Single color display, all bands combined
- All (detailed): Multicolor display, one color per band
- Current: Displays statistics for the current band
- According to QSO: Displays statistics for the band of the currently selected QSO

### Mode

- All (total): Single color display, all modes combined
- All (detailed): Multicolor display, one color per mode
- Current: Displays statistics for the current mode
- According to QSO: Displays statistics for the mode of the currently selected QSO

### Display

- By time: Displays an hour by hour comparison
- Overall: Displays a cumulative (overall total) comparison

Another option allows you to load a targets file for comparison, or export a targets file based on the current log.

Finally, it is possible to copy any of the Statistics windows as image or text to the Windows clipboard. Then you can copy the data into to a text document or even into an Excel® or OpenOffice spreadsheet.

## Gab

Windows | Gab or **Alt-I**

Opens (or closes) the gab window.

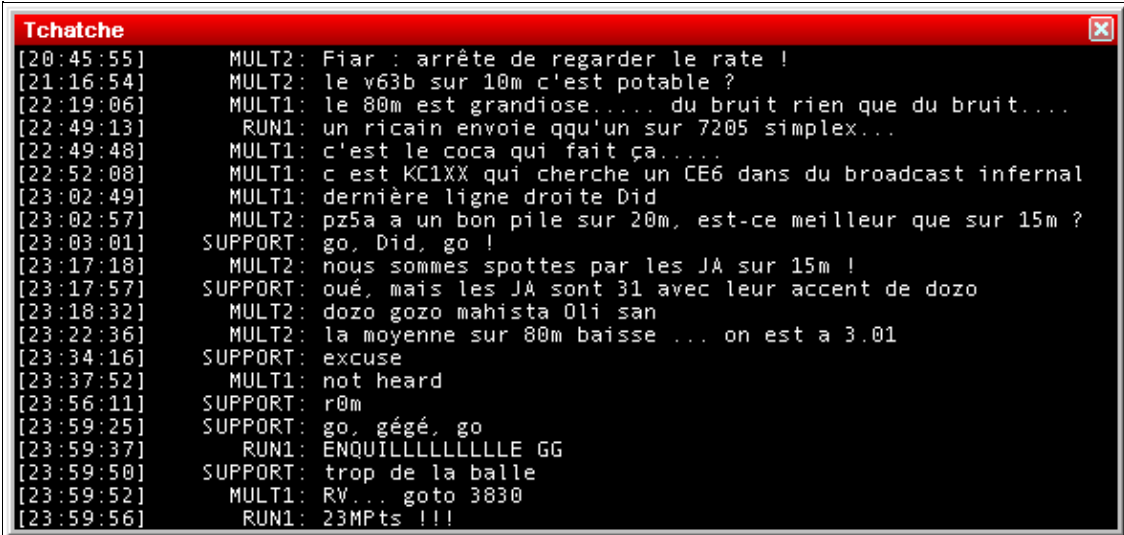

```

Tchatche
[20:45:55] MULT2: Fiar : arrête de regarder le rate !
[21:16:54] MULT2: le v63b sur 10m c'est potable ?
[22:19:06] MULT1: le 80m est grandiose.... du bruit rien que du bruit...
[22:49:13] RUN1: un ricain envoie qq'un sur 7205 simplex...
[22:49:48] MULT1: c'est le coca qui fait ça....
[22:52:08] MULT1: c est KC1XX qui cherche un CE6 dans du broadcast infernal
[23:02:49] MULT1: dernière ligne droite Did
[23:02:57] MULT2: pz5a a un bon pile sur 20m, est-ce meilleur que sur 15m ?
[23:03:01] SUPPORT: go, Did, go !
[23:17:18] MULT2: nous sommes spottes par les JA sur 15m !
[23:17:57] SUPPORT: oué, mais les JA sont 31 avec leur accent de dozo
[23:18:32] MULT2: dozo gozo mahista Oli san
[23:22:36] MULT2: la moyenne sur 80m baisse ... on est a 3.01
[23:34:16] SUPPORT: excuse
[23:37:52] MULT1: not heard
[23:56:11] SUPPORT: r0m
[23:59:25] SUPPORT: go, gégé, go
[23:59:37] RUN1: ENQUILLLLLLLLLLLE GG
[23:59:50] SUPPORT: trop de la balle
[23:59:52] MULT1: RV... goto 3830
[23:59:56] RUN1: 23MPts !!!

```

### Gab Window

All the gab chat is displayed in this window. With a right click, you can choose to display (or not) the time when the message was sent, including (or not) the seconds. Moreover, this window can be copied as an image.

In the context menu, the option "Taskbar flashing" can be selected to make the Windows Task Bar flash every time a gab is received.

All the gab chat is recorded in the .gab file of the current contest.

A double-click in a station name in this window will open the chat dialog, with this station name as default destination.

If the gab window becomes too cluttered, you may wish to clear it via the context menu.

## World Map

Windows | World Map

Opens (or closes) the map window

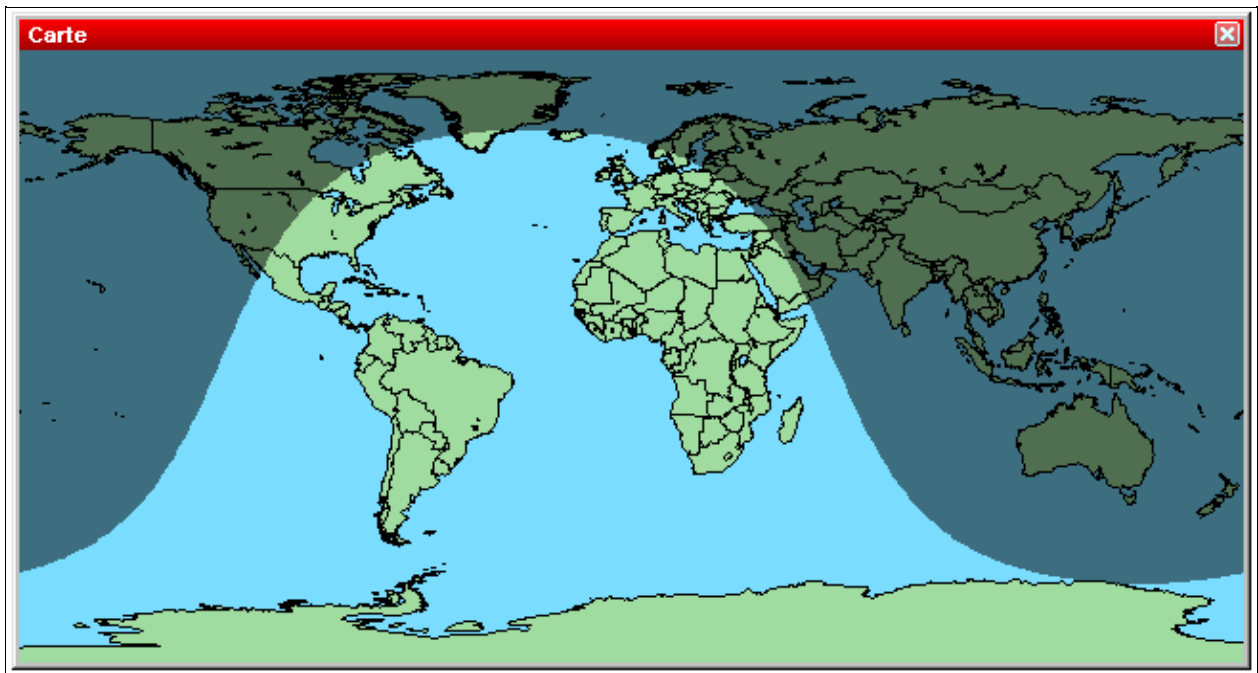

World Map

The World Map shows when you get spotted by someone.

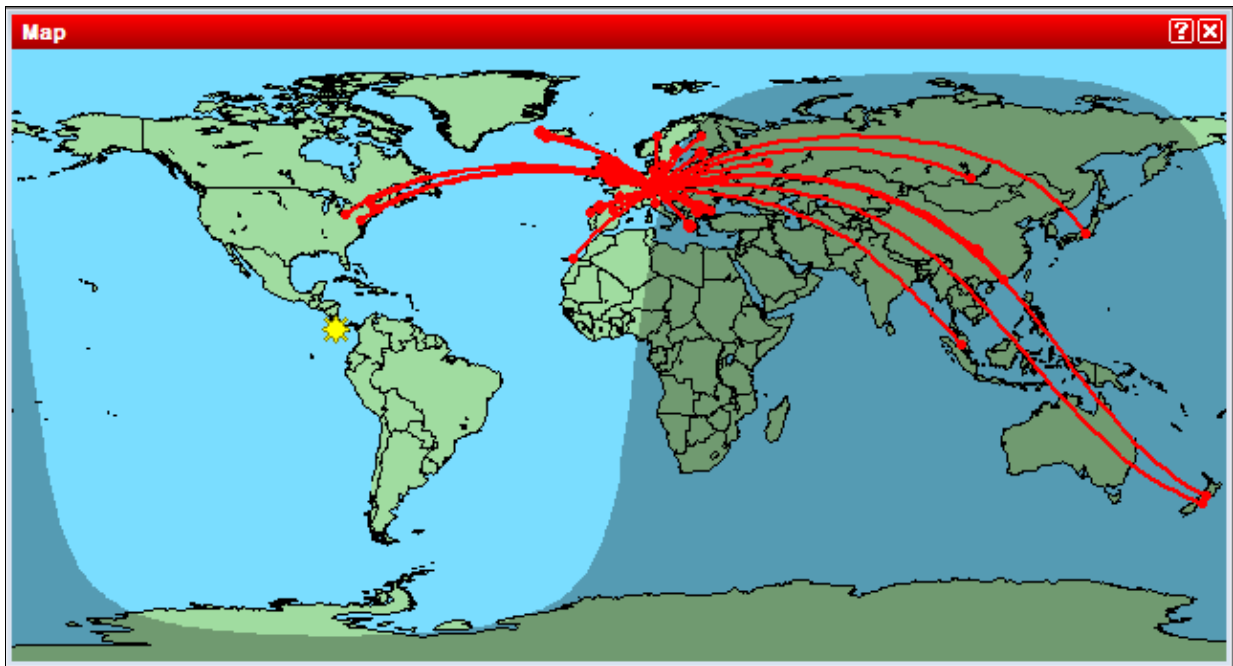

## Win-Test Wiki

World Map displaying when you are being heard.

The dimensions of this worldmap window can be modified. With a right click, you can display (or not) the grey-line. Moreover, you can increase or decrease the format (zoom). There is a number of options to select in the appropriate context menu.

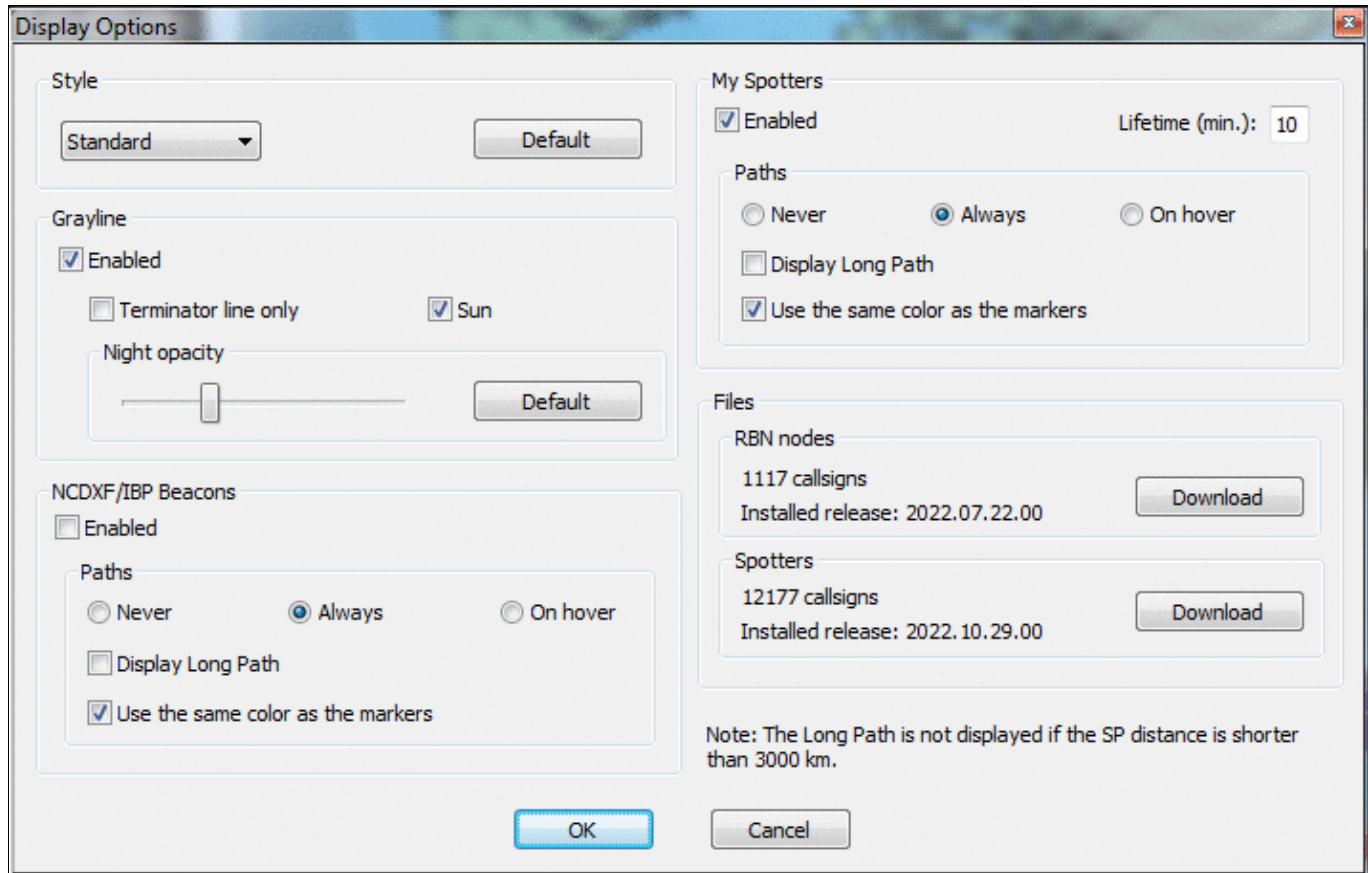

### World Map Context Menu

An additional option allows you to display only the greyline terminator plus a little symbol for the sun which makes reading the information a little easier at times.



World Map with light terminator

## **Radio 1, Radio 2 (Band Maps)**

Windows | Radio 1 or Windows | Radio 2  
Opens (or closes) the radio window.



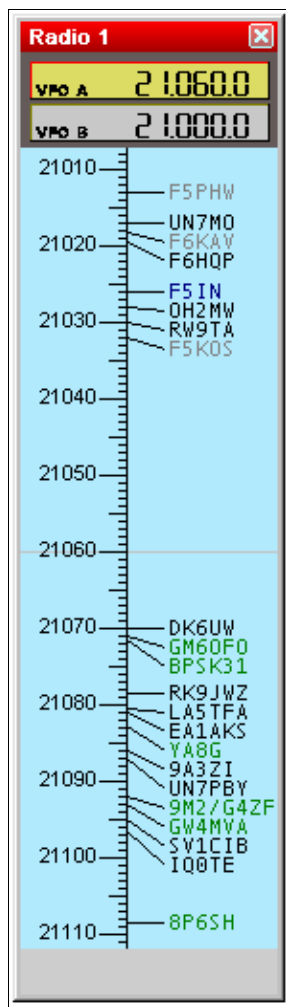

Radio window (band map)

These resizable windows are also called Band Maps.

The frequencies of the 2 VFOs are displayed. The active VFO has a yellow background.

If Win-Test has a DX cluster connection, the bandmaps are automatically fed from the DX cluster data stream, from logging contacts, and by manually adding information using **Ctrl-Enter** instead of **[Enter]**. Op-entered spots are protected from spots of the same DX on a freq inside the mode bandwidth window.

The green callsigns denote new multipliers, the black ones new callsigns (not worked so far), and dupes are in grey color and slanted font.

A double click on a callsign will automatically put the radio on the spot frequency and capture the callsign in the logging field. You just need to complete the QSO and press **[Enter]**! Press **[Alt-F4]** to return to your run frequency.

An **[Alt]**-double click on a callsign will load the spot frequency into the Sub VFO (VFO B), if your radio supports it.

While in split mode during 40m and 80m SSB operation, when adding a spot to the band map, Win-Test remembers both the RX and the TX VFO frequencies, and will store this information so that when you select the spot, both VFOs will be set correctly, and you'll be ready to call (unless the QSX frequency has changed in the mean time).

Moving the mouse pointer over a spot in the band map will bring up additional information, such as the age of the spot the callsign of the spotter, and any comments. Double-clicking the spot with the **[Ctrl]** key removes the spot from the band map (without confirmation).

Other key combinations can be used to operate with the Band Map.

### Band Maps Context menu

A right click on this window brings up its context menu.

- The top option in this Context Menu allows you to program the Sub VFO (if your radio supports it) with this spot.
- The **Propagation** submenu item allows you to gather propagation information via HamCAP (if installed)
- The next two entries **Modify...** and **Delete** allow you to change or remove spots in the band map. Note that you can quickly remove a spot by double-clicking it with the **[Ctrl]** key pressed.
- Additionally, you can change the scale of the band map display from 1:1 up to 30:1. The scale can also be set through the mouse wheel.
- More options are hidden in the sub menus Display Options and Properties... where one can set a lot of minor details of the band map.

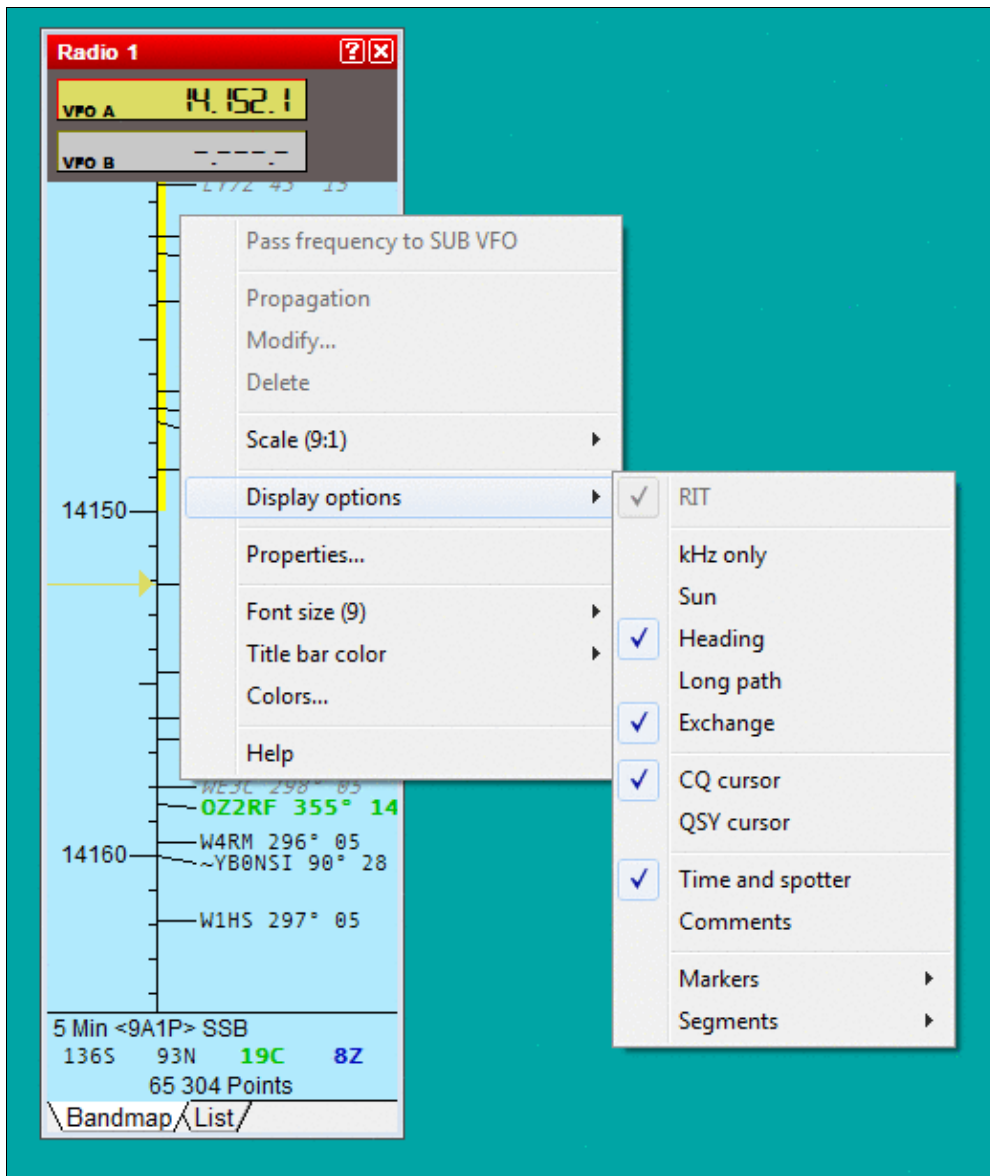

Band Map Context Menu

- 29S 11N at the bottom indicates there are 29 spots total, 11 new calls (not yet worked).
- The List tab of the band map has a context menu with several sorting options:

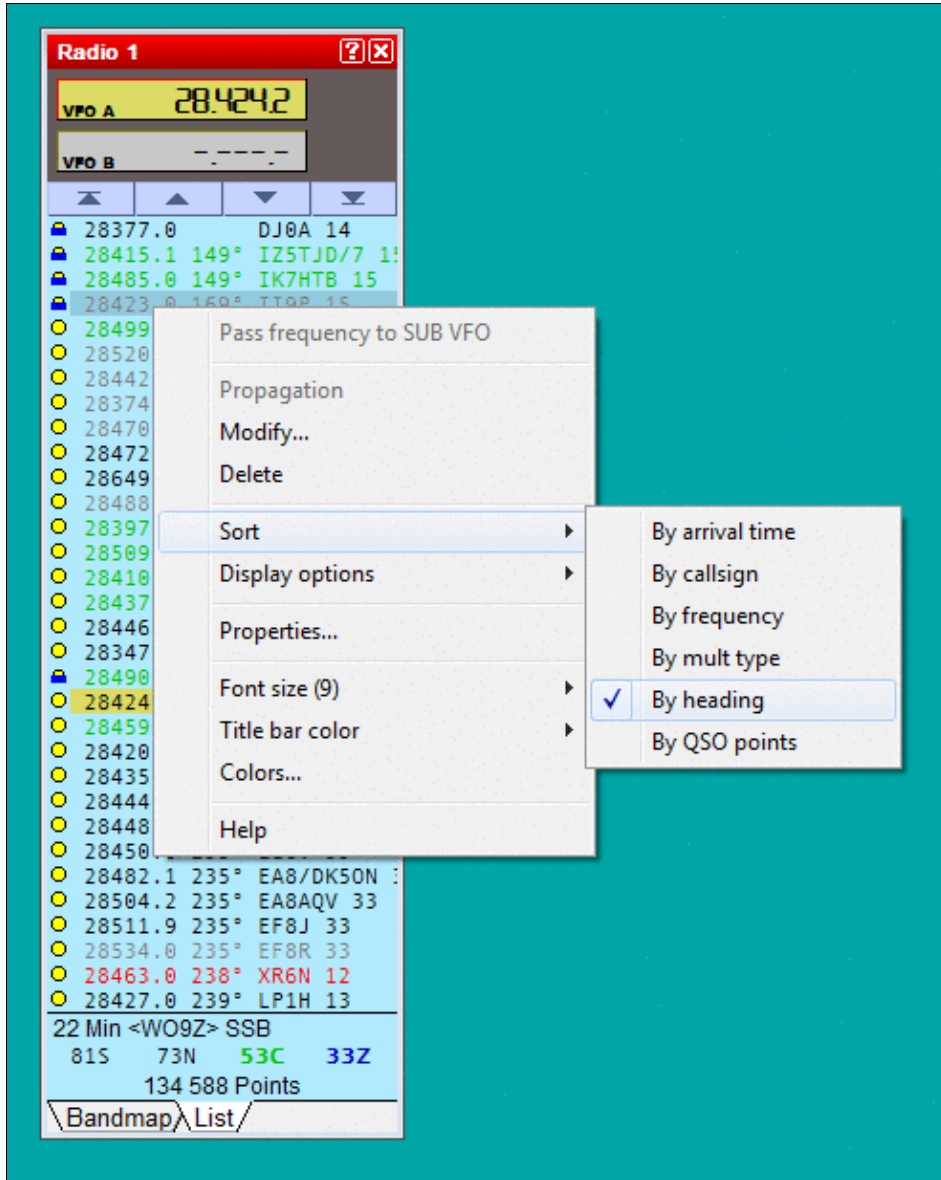

Band Map List View Context Menu - sorting options

- The List tab of the band map has a display option that lets you hide dupes and display additional information:

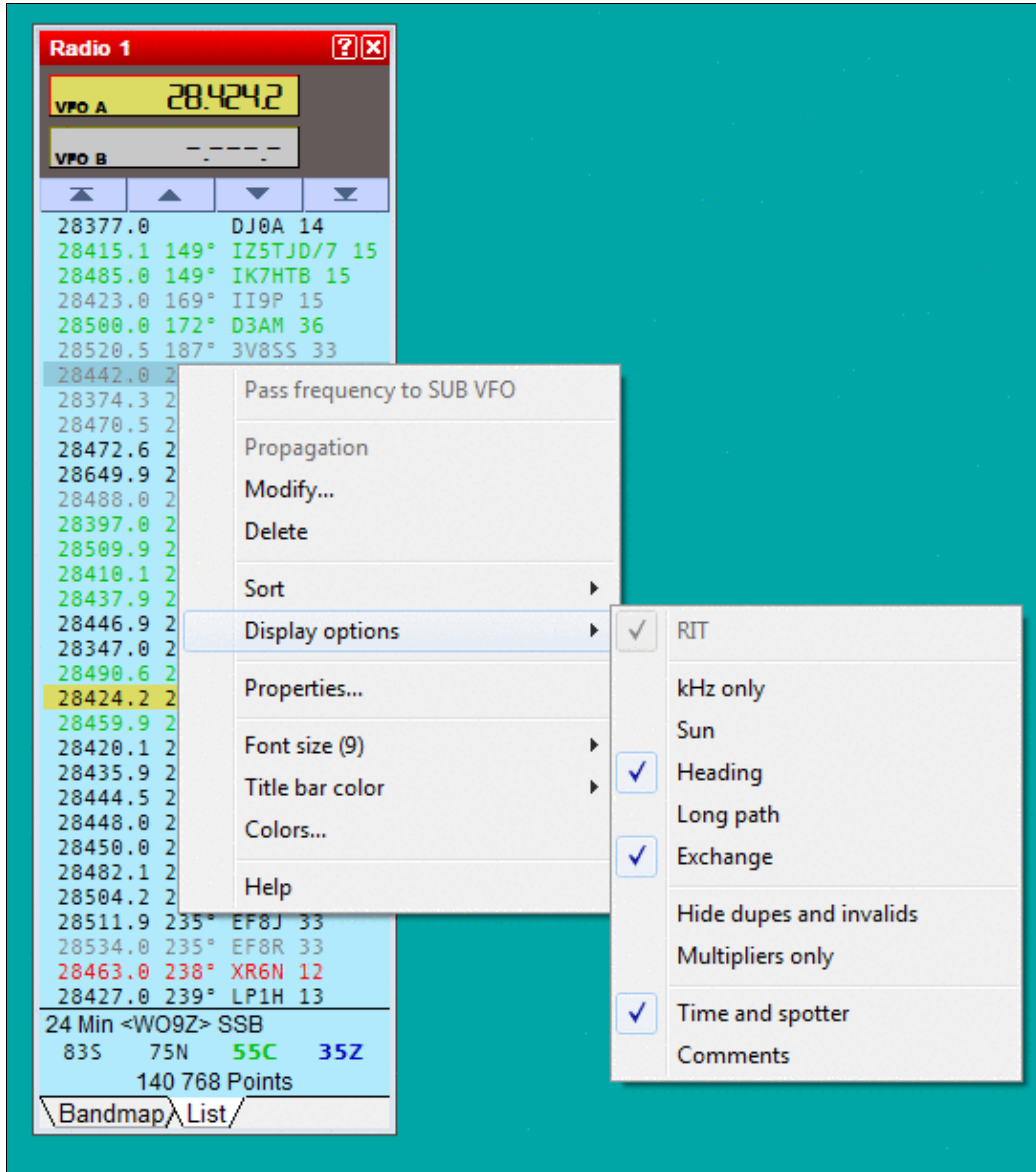

## Band Map List View Context Menu - hiding dupes

- You may toggle between band map and list view using **[Ctrl-tab]**

### Special cursors

Special indicators for the last CQ frequency or the QSY frequency (set with the PASSFREQ text command, or with the Commands | QSY frequency menu option) can also be activated (see picture).

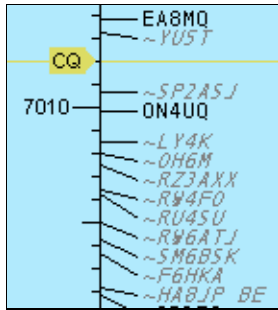

Band Map with CQ cursor

To enable them, tag the CQ cursor and/or the QSY cursor items in the Display Options submenu of the context menu itself.

### Extended information

The Display Options menu also allows you to select if the expected exchange will be displayed in the band map and other minor details, like day/sunrise/sunset/night symbols, time and sender, comments etc.

### Markers

The Display Options menu allows you to enable the displaying of markers. These can be useful for beacons and other known stations on the bands.

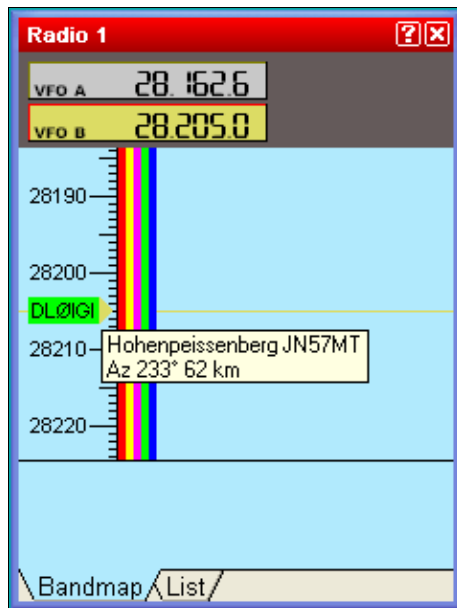

Band Map with a marker file for 10 m beacons loaded

Markers are defined by text files with a **.mkr** extension located in the Win-Test directory. WT can use and display up to 10 files simultaneously; they can be selected in the `Options | Data files | Markers files` menu. For detailed information, please see [Menu: Options Data files Markers files](#).

Marker display settings can be different for each radio. The syntax of the marker files is very basic and they are easy to create with a simple text editor like Notepad.

A marker is defined by its frequency (in kHz), a label (one word) and an optional tooltip (30 chars max.) that will flash when the mouse cursor is positioned on the marker for a few seconds. If you include a four or six character gridsquare locator, WT will display heading and distance to this gridsquare in the tooltip window.

Example:

```
28205 DL0IGI Hohenpeissenberg JN57MT
28257 DK0TEN Sipplinger Berg JN47NT
28277.5 DF0AAB Kiel JO54GH
```

Two **DIRECTIVES** (or **KEYWORDS**) define the background and foreground color:

- **# BACKGROUND** color => Sets the background color of the following markers in the file. If no color is specified, the default color is green.
- **# TEXT** color => Sets the text color of the following markers in the file. If no color is specified, the default color is black.

The known colors are: White, Black, Red, Green, Blue, Yellow, Magenta, Cyan. The case of the color is irrelevant, so "green" and "Green" are identical.

Example :

```
# BACKGROUND white
# TEXT green
#
14100 Bcn NCDXF Beacon
```

This will display a white marker with a green text "Bcn". The associated tooltip will be "NCDXF Beacon". As usual, you can double-click on a marker to set the current radio on the frequency of the marker. A sample file **NcdxfBeacons.mkr** is located in the WT repository at: <http://download.win-test.com/files/markers/>. It displays markers for each NCDXF beacon.

You may build your own marker files (VHF beacons etc.) and share it with the WT community if you want.

### Segments

WT can display band allocations for different license types in the bandmap tab of the radio windows. This allows you to select a run frequency which is in right band segment for US-Advanced or US-Novice amateurs for example.

Band segments are defined by text files with a **.seg** extension located in the Win-Test Extras directory. WT can use and display up to 10 files simultaneously; they can be selected in the Options | Data files | Segments files menu. Please find more detailed information in [Menu: Options Data files Segments files](#).

Due to space constraints - you can't have more than 5 segments displayed per band for any given frequency.

The segments display settings can be different for each radio.

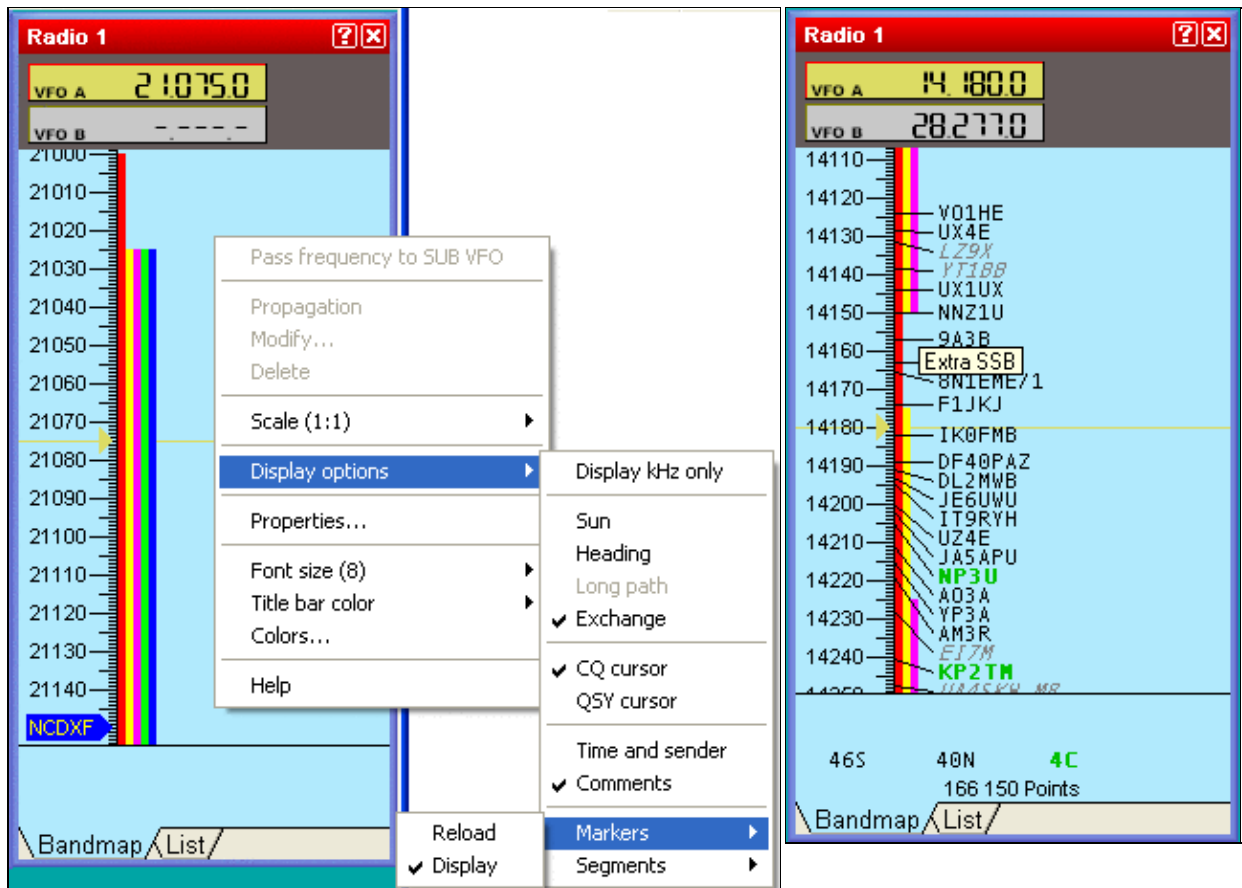



### Band Map with marker and segments

### Band Map with US band allocation

The syntax of the segments files is very basic, and the files are easily created with a simple text editor like Notepad. A segment is defined by specifying its lowest and its highest frequency (in kHz). The two frequencies may be linked by an hyphen for easier reading. An optional tooltip text (30 chars max.) can be given to explain the meaning of the color segment. By placing the mouse cursor over a colored line in the band map display, the tooltip will display.

The BandMap segment color is indicated by the DIRECTIVE (keyword) COLOR like given below. The known colors are: White, Black, Red, Green, Blue, Yellow, Magenta, Cyan. The case of the color name is irrelevant. If no color is specified, the segments will be displayed in yellow.

Example:

```
# COLOR Red
14000-14150 Extra CW
14150-14350 Extra SSB
# COLOR Yellow
14025-14150 Advanced CW
14175-14350 Advanced SSB
# COLOR Magenta
14025-14150 General CW
14225-14350 General SSB
```

This will display the US band allocation in the 20-m-band.

The segments order, and potential overlaps in the file are irrelevant. WT will take care to display them in an optimized way.

Two sample files are located in the WT repository at <http://download.win-test.com/files/segments/>

- **UsSegmentsDetailed.seg** displays all band segments for every US licence type.
- **UsSegments.seg** displays all band segments in which all US licencees are potentially active.

You may create your own band segments files for other countries, regions, etc. and share them with the WT community if you want.

### Band Map properties

Selecting **Properties...** in the context menu of the Radio 1 or Radio 2 band map windows displays the Bandmaps Properties window:

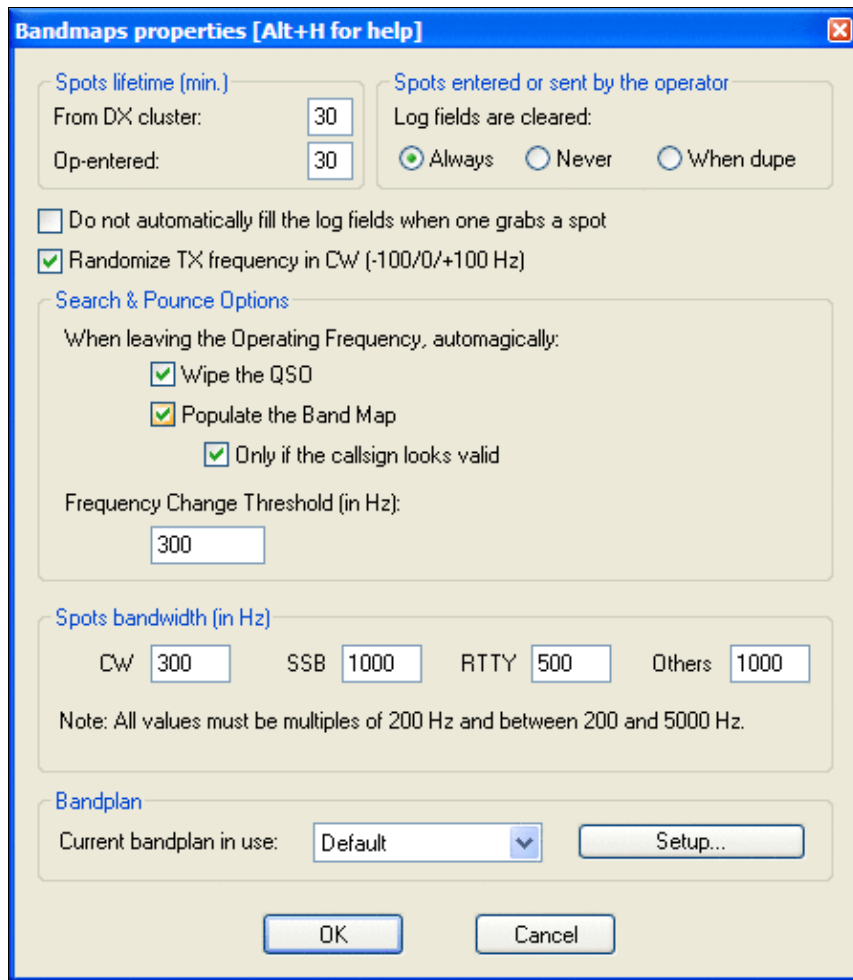

### Bandmap properties window

Here you can define the lifetime of two kinds of spots, control the behavior of the logging window when you press **[Ctrl-Enter]** to create an operator-entered spot, control the automatic entry of data in the logging window when you grab a spot in the bandmap (via double click), select random 100 Hz TX frequency offsets to improve the chances of calling a spot on a clearer frequency (recommended), and the spot bandwidth for each mode (CW, SSB, RTTY) which is used to determine when two spots are on the same frequency. The spot bandwidth can be set between 0 Hz and 5000 Hz, in 100 Hz steps. The lifetime of spots in the band map can be changed from the default (60 minutes) to any other value below 100 minutes.

Search & Pounce Options allow you to add spots to the band map without having to press **[Ctrl-Enter]**. Simply enter the callsign and turn the VFO by the specified frequency change threshold to automatically populate the band map.

**Note:** To automatically populate the Band Map, you must be in S&P mode. Search & Pounce is not activated by default. Select **Tools | Data entry | Enable Run/S&P switching** (text command shortcut: **RUNSP [Enter]**), and then press **[Ctrl-tab]** once to toggle from Run to S&P mode. The clock window indicates the current mode.

## Secondary Radio

Windows | Secondary Radio

Opens (or closes) the Secondary Radio window.

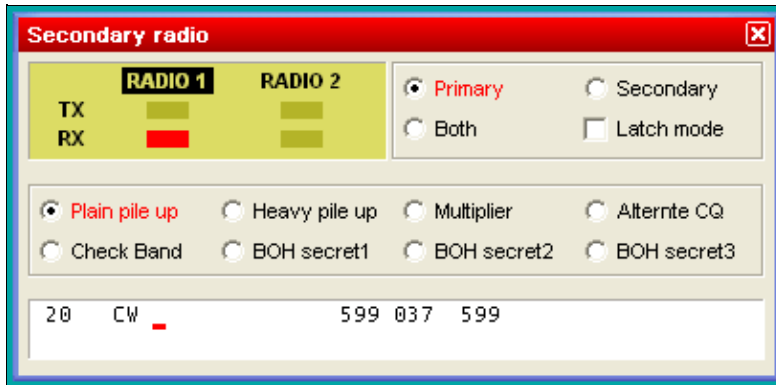

### Secondary Radio Window

This window controls the "other" radio that is currently not in use during SO2R operation, not necessarily radio 2. For more information, please see [SO2R/Second radio window](#).

## RTTY (radio1, radio2)

Windows | RTTY (radio 1)

Windows | RTTY (radio 2)

Opens (or closes) the RTTY Transit/Receive windows.

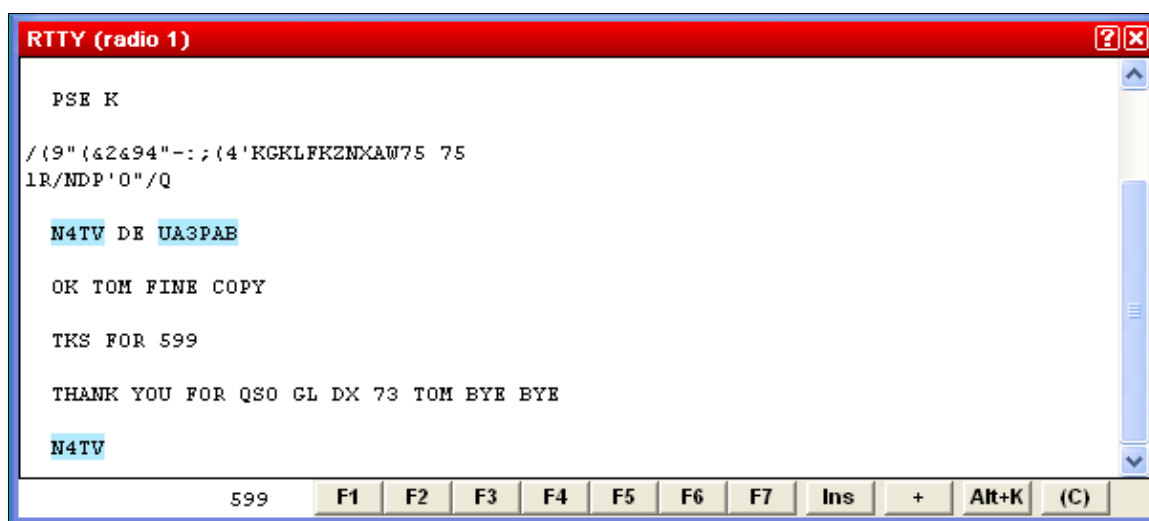

### RTTY TX/RX Window

For more information, see [RTTY Receive/Transmit window](#) in the [RTTY](#) chapter.

## Rotators

Windows | Rotators

Opens (or closes) the Rotators window, which displays the true beam heading (after adding any programmed offsets) of all the antennas available on the current operating band or bands (two bands if using two radios).

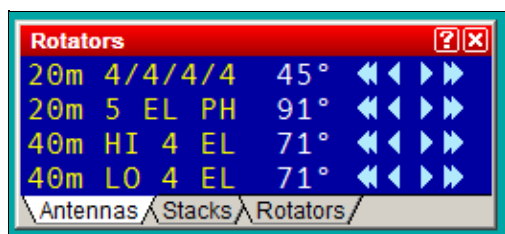

Rotators window with true heading of four antennas on current operating bands

The three tabs at the bottom may be used to select what is displayed:

- **Antennas** - Display the true beam heading (by antenna name) of all named antennas defined for the current operating band or bands. Any defined antenna offsets are used to calculate the displayed heading. Arrow buttons can be used to rotate one antenna at a time.
- **Stacks** - Display the true beam heading of any wtRotator "Stacks" (or "Groups") on the current band. The buttons may be used to rotate the entire stack at once to the same heading, even if each antenna has a separate rotator. The heading of the first rotator added to a stack or group determines which heading is shown for the stack (even if another antenna in the stack is currently pointing in a different direction).
- **Rotators** - Display *all* connected rotators (by rotator name), regardless of band, and the heading of each, as displayed on the control box. Any antenna offsets are ignored.

Click on the arrow buttons to rotate the current antenna, stack, or rotator as follows:

- [ $\ll$ ] - Rotate  $45^\circ$  counter-clockwise
- [ $\lt$ ] - Rotate  $15^\circ$  counter-clockwise

- [**>**] - Rotate 15° clockwise
- [**>>**] - Rotate 45° clockwise

You may also enter a callsign, DXCC prefix, or beam heading in the Win-Test logging Window, and press [**Ctrl**]-**F12** to rotate all antennas defined on the current band to desired heading (assuming your Grid Square or "Locator" is properly defined in the Contest Configuration screen).

*Right click* on the dark blue area of the Rotators window to display the pop-up menu.

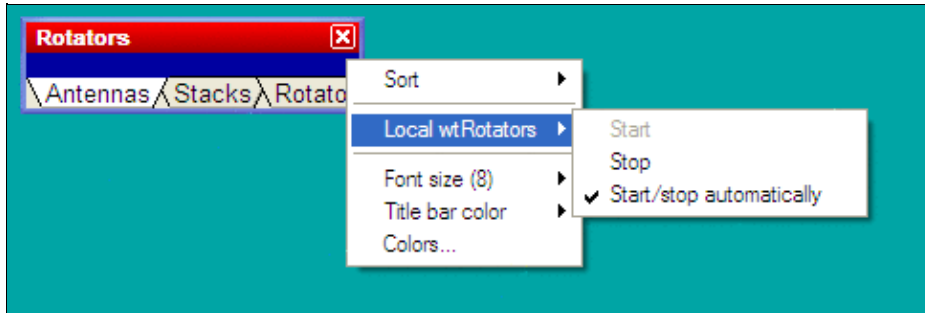

Rotators window with pop-up menus

Use the pop-menu to sort the list, change font size, or start or stop the companion program, **wtRotators**, on the local PC. wtRotators is a program that communicates with one or more rotators, similar to the way that wtDxTelnet communicates with one or more packet clusters. It can be located on the current computer or a separate computer on the LAN, whichever computer is physically connected to a rotator's serial port.

Select the **Start/stop automatically** option to have Win-Test automatically start and stop the wtRotators program on the local computer whenever you open or close Win-Test.

See the [Rotators](#) main topic for more information about configuring and using wtRotators with Win-Test.

## DX-Cluster Monitor

Windows | DX-Cluster monitor or **Alt-O**  
Opens (or closes) the DX Cluster monitoring window.

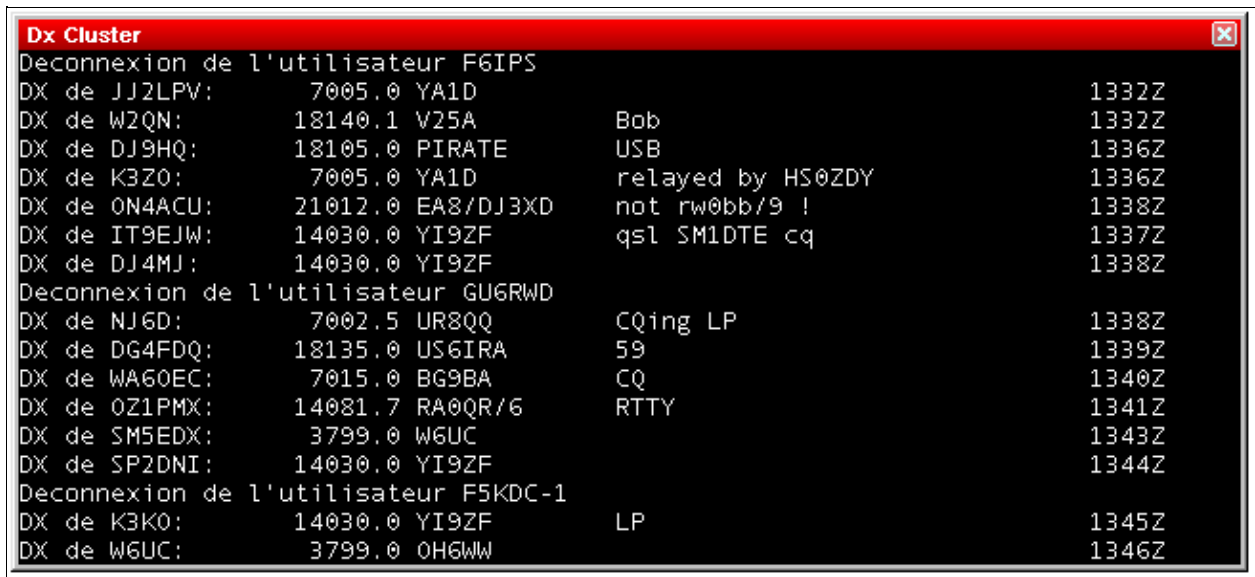

**DX Cluster monitoring window**

The contents of this window are logged to to the **.pkt** file. Logging can optionally be disabled to save disk space or to prevent malware scanners from slowing down the system -- in particular, when a lot of spots is being received (e.g. via RBN). To disable logging, right-click in the window and uncheck "Stream logging".

The window is scrollable so that you can step back through history, back - even to the beginning of the file. The scrolled window will not update when new spots arrive. However, there is a little hint in the title bar like **[+1138 lines]**. In order to see all spots which have arrived in the mean time you have to move the scrollbar back to the end of the window.

For more information regarding the setup of DX Cluster connections, please see [Commands | DX Cluster](#)

## DX-Cluster Announcements

Windows | DX-Cluster Announcements or **Alt-A**  
 Opens (or closes) the DX cluster announcements window.



### DX Cluster Announcements Window

This window gathers all the spots coming from the DX cluster. New multipliers are green, other stations (but not dupes) are black.

A double click on a selected line will automatically switch the active radio to the spot frequency, and will grab the call and enter it in the callsign logging field. You just need to complete the QSO and press **[Return]**.

QSX information (like QSX 7239) is parsed from the comment field of the spot and handled correctly, so that when you click on such a spot, the transceiver will switch to split mode, put VFO A on the RX frequency and VFO B on the TX frequency. QSX is indicated by an asterisk (\*) character on the spotted callsign. Cross-band QSX frequencies are being ignored.

With a right click, you can choose to display only new multipliers, only spots entered by the operator and/or selected bands:

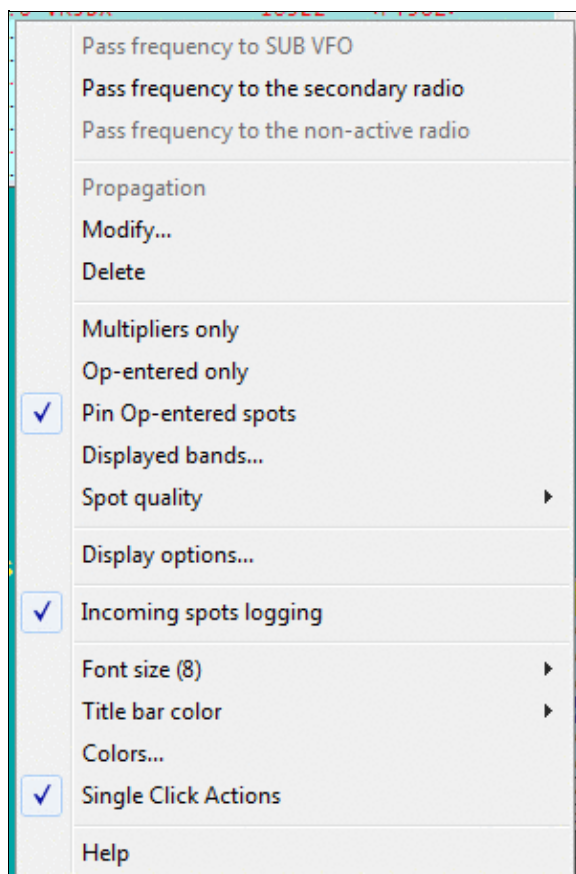

## Win-Test Wiki

Band selection pop-up menu for the DX Cluster Announcements window

Op-entered spots enable you to enter spots on your own - they will be marked with a circonflex and remain at the bottom of the announcements window and not overwritten by incoming DX Cluster spots.

CT1BOH's quality tags can be used to filter out unwanted spots (if supported by your Skimmer or DX Cluster). Check the appropriate fields in the context menu to select spots you want.

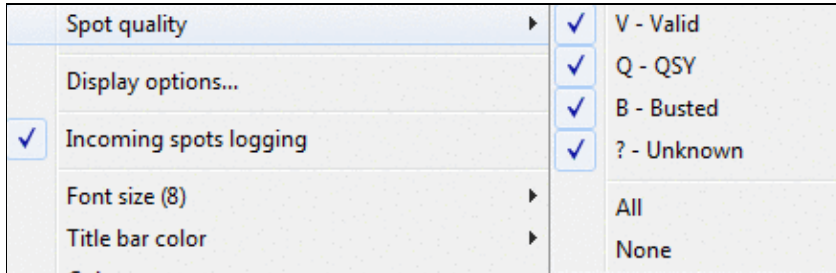

Enable spot quality for the DX Cluster Announcements window

All spots are logged to the corresponding **.dxc** file in the log directory. Logging can be disabled to save disk space or prevent malware scanners from slowing down the system - in particular, when a lot of spots is being received (e.g. via RBN). Manually entered spots are still being logged to the **.dxc** file.

The displayed information is selectable (local time as a sun symbol, exchange, time spotted, spot comments, spot quality, beam heading, and the callsign of the spotter):

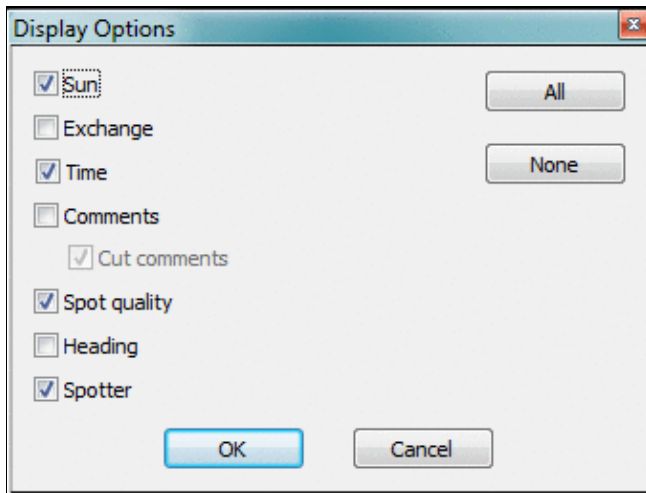



Display options for the DX Cluster Announcements window  
 Additional shortcuts:

- **[Ctrl] + Dbl click** on a spot removes the spot from the Announcements window (without confirmation).
- **[Alt] + Dbl click** on a spot loads the spot frequency in the sub VFO of the active radio (if your radio supports it)

For more information regarding the setup of DX Cluster connections, please see [Commands | DX Cluster](#)

## NCDXF/IBP Beacons

Displays the transmission schedule of the NCDXF / IBP (International Beacons Project) beacons. A double click on a line sends the radio to the beacon freq. An "i" (stands for "info") in the status column indicates a comment you can read by hovering the mouse over it.

FREQ	BEACON	DIST.	SP	LP	ST.
14100.0	VE8AT	6748 km	346°	166°	ON i
18110.0	4U1UN	6490 km	297°	117°	ON
21150.0	YV5B	8478 km	268°	88°	ON
24930.0	0A4B	10906 km	261°	81°	ON
28200.0	LU4AA	11526 km	233°	53°	ON

NCDXF/IBP Beacons Window allows you to keep an eye on propagation conditions.

## Clock

Windows | Clock

Opens (or closes) the clock window.

11:50:26	I2WIJ	JN450L	SR 0507z	SS 1723z	S/P
12:00:05	I2WIJ	JN450L	SR 0507z	SS 1723z	RUN

Clock window samples

To set time in Win-Test, you don't need to change the computer time. You just need to adjust the computer clock in the local time, within the right time zone. Win-Test will compute the UTC time from this information.

The color of the time display changes in minutes 59 and 00, to prepare an operator changeover in a multi-op environment.

This window also displays sunrise and sunset times (SR and SS) according to your location. To catch your eye, the color of these times will change when you are within 30 minutes of sunrise or sunset times.

This window also displays your Locator (which is needed if you want that WT exactly compute SR/SS times as well as Bearings and distance to the correspondent) and the Win-Test operating mode, RUN or S/P, according to your operating needs. For details on this feature see also [Menu:Tools Data entry](#).

Just as a side note, WinXP allows you to synchronize your computer's clock time through the Internet. Please see more details on Microsoft's support pages ([overview](#) and [details](#)).

The font type and size, as well as the background and all the usual window colors can be changed through the context menu using a right mouse click on that window.

## Contest Recorder

Windows | Contest Recorder

Opens (or closes) the Contest Recorder window.

Before recording, right click and select [MP3 Configuration](#) to set the recording parameters.

A right-click on the Recorder window provides help to the keyboard shortcuts. Use `right-click | Files Information` to see information about recorded files, or to delete recorded files. Start the recording by pressing **AltGr-O** or using the text command shortcut: **RECORD** or **STARTRECORD**, stop the recording using **NORECORD** or **STOPRECORD**.

The recording is a standard MP3 file which can be played on any MP3 player. Win-Test actually saves timestamps in the MP3 files which allows for a quick navigation when run from within Win-Test. Win-Test creates sequential files up to a specific size (690 MBytes by default) and then switches to a new file.

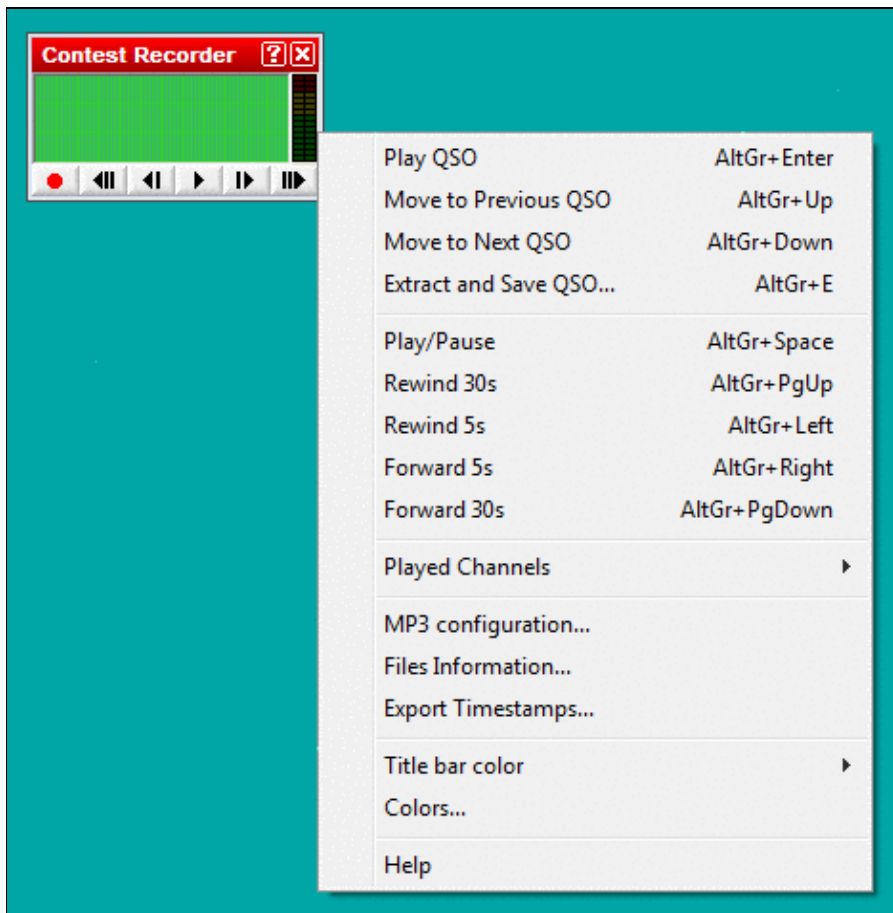

### Contest Recorder window with context menu

The Contest recorder is a powerful tool to check your copying abilities, verify notes you have made during the contest or let others listen to what was audible on your end of the QSO. The shortcut **AltGr+Enter** quickly lets you jump to a specific QSO recording and you can then use the fast forward and fast backward functions to play it over and again.

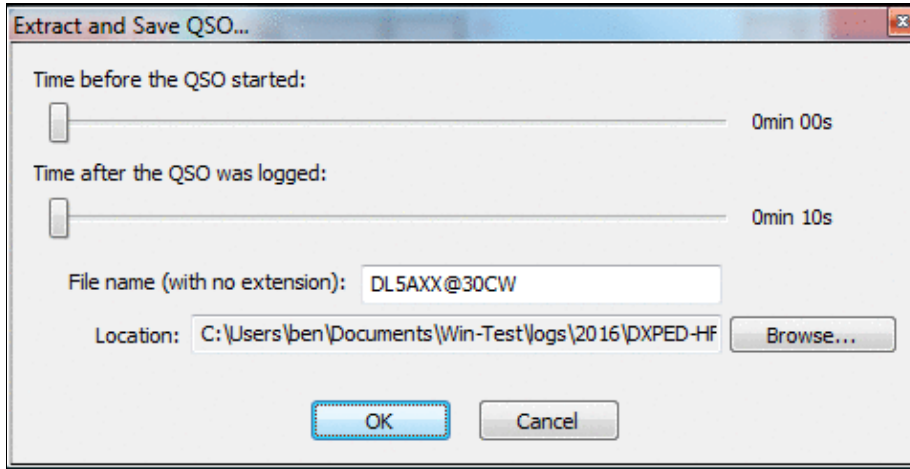

### Extract QSO dialog

Please note that in some contests, modifying your log after the contest is against the rules. However, it is never prohibited to go back to your log after having received your UBN report from the contest sponsor and find out why you failed to copy something or assumed a QSO where it wasn't a perfect QSO.

In very fierce competitions like WRTC, teams must provide a complete recording of the whole contest (both receive and transmit audio) to their referee. To record the transmit signal can be tricky and may require additional hardware, as some radios do not supply the monitor signal on the audio output line.

Win-Test uses the "standard" MP3 tags.

```
Title : Contest name + Category mode + File number (starting at 000)
Artist : Callsign
Album : Station
Year : Contest year (1st QSO)
```

In order to play QSOs, the MP3 tags must match the settings in the current .wt4 file. Otherwise, the recorder will display the message "No record for station X", with X being the current station number.

N6TV gave a comprehensive presentation on the subject at the Visalia International DX Convention 2019 which you can find on his web page:

[https://www.kkn.net/~n6tv/N6TV\\_Visalia\\_2019\\_Recording\\_A\\_Contest.pdf](https://www.kkn.net/~n6tv/N6TV_Visalia_2019_Recording_A_Contest.pdf)

## SSB bargraph

Windows | SSB bargraph  
Opens (or closes) the SSB bargraph window



SSB bargraph window

This bargraph displays the audio level of the Win-Test's digital voice player (if used, of course). The appropriate level is the yellow part of this bargraph. The windows can be rotated by 90 degrees.

## Close all Windows

Windows | Close all windows

Closes all windows except the log entry area in the left lower area.

[Back to Menus](#)

## Namespaces

- [Page](#)
- [Discussion](#)

## Variants

## Views

- [Read](#)
- [View source](#)
- [View history](#)

## More

- This page was last edited on 9 April 2023, at 15:44.

- [Privacy policy](#)
- [About Win-Test Wiki](#)
- [Disclaimers](#)

- The logo for MediaWiki, featuring a sun icon and the text "Powered By MediaWiki".

# Message variables

From Win-Test Wiki

[Jump to navigation](#) [Jump to search](#)

## Messages Variables

These variables can be used in programming CW messages using the F-keys. Some of these variables do not actually create output but rather perform actions at specific points in time, like the **\$CR** symbol.

### Contents

- [1 CW / RTTY automation](#)
- [2 RTTY only](#)
- [3 Action](#)
- [4 SO2R](#)
- [5 WAEDC QTC related](#)
- [6 Custom variables](#)

### CW / RTTY automation

- **\$CHECK**: send license year (ARRL SS only)
- **\$CORRECT**: sends a call correction, if any (see [correction](#))
- **\$CURRENT** (or **\$CURRENTCALL**): Sends the callsign of the current QSO *despite* the presence of a \$CR later in the message. The \$CR (carriage return) is always executed on message keypress. See [Windows | Partner](#) for usage examples. It is also useful in ESM (Enter Sends Message) mode in lieu of \$LOGGEDCALL.
- **\$F1 . . . \$F7**: sends the message associated with F1 ... F7 function key
- **\$FREQnn**: Where *nn* is a band (e.g. \$FREQ160, \$FREQ80 etc.). Useful in a multi-op as a canned message "PSE QSY \$FREQ15". Sends the frequency of the primary radio of the first networked station found on this band with the following priority : R, R+, M, and M+. In addition, in CW, if the frequency is within 100 Hz of a kHz boundary, the decimal point is omitted, e.g. 14021.09 is sent as 14021 and 14021.10 is sent as 14021R1.
- **\$FREQP**: contains the frequency of the primary radio (useful for passing mults)
- **\$FREQS**: contains the frequency of the secondary radio (useful for passing mults)
- **\$GRIDFIELD** (or **\$LOC4**, **\$GRID4**): contains the 4-char QTH locator (Maidenhead square) of the entrant
- **\$GRIDSQUARE** (or **\$LOC6**, **\$GRID6**): contains the 6-char QTH locator (Maidenhead square) of the entrant
- **\$INSERT**: sends message in the [**Ins**] key
- **\$ISLAND**: sends IOTA Reference (i.e. EU001, AF001, ...) (IOTA Contest)
- **\$LOGGED** (or **\$LOGGEDCALL**): sends what is typed in the callsign field of the current QSO, or if blank, the previous QSO
- **\$MSG1 . . . \$MSG12**: sends additional CW messages (see [Modify additional messages](#))
- **\$MYCALL**: sends callsign set in [contest configuration](#)
- **\$MYNAME**: sends operator name, set in [contest configuration](#)
- **\$NEXT** (or **\$NEXTCALL**): sends the callsign of the next QSO line when a \$CR is included in the message.
- **\$NEXTSERIAL**: sends next QSO serial number (current QSO serial number plus 1)

- **\$PLUS**: sends message in the [+ ] key
- **\$PREV** (or **\$PREVCALL**): sends the callsign on the previous QSO line.
- **\$PREVSERIAL**: sends previous QSO serial number (current QSO serial number minus 1)
- **\$QOQLC**: sends Quick QSL message based QSOs made (see [Intelligent Quick QSL](#))
- **\$QOQLT**: sends Quick QSL message based on time passed (see [Intelligent Quick QSL](#))
- **\$QOQLRESET**: reset the timer or the counter like if the long QSL message were just sent.
- **\$QSOB4**: sends the QSOB4 message and cancels the remainder of the current message, if the current QSO is a dupe, otherwise sends nothing (see [Modify standard messages](#))
- **\$RAWSERIAL**: sends the serial number of the QSO with leading zeros and without any abbreviation
- **\$RST**: sends report from RST Sent field (normally **5NN** for CW, **599** for RTTY)
- **\$SERIAL**: sends current QSO Serial Number, or previous serial number if the line with the cursor is blank.
- **\$STATE**: sends State/Province set in [contest configuration](#) (Exchange)
- **\$YEAR**: sends year nr set in [contest configuration](#) (i.e. EUHFC, AA)
- **\$ZONE**: sends zone nr set in [contest configuration](#)
- **&xy**: sends a [Morse prosign](#) where xy represents the two characters forming the prosign, e.g. &AS, &AR, &BK, &BT, &CL, &KN, &SK, etc.
- **+**: increase speed by 4 wpm
- **-**: decrease speed by 4 wpm
- **^**: the halfspace character with 1/2 dot duration
- **~**: (tilde) at then end of a variable means "no space" will be inserted, e.g. \$NEXT~? sends the next callsign followed by a question mark, with no space in between

## RTTY only

- **\$13**: send carriage return character (start print on a new line)
- **\$SERIE**: send the complete QTC block (WAEDC only)

## Action

- **\$CR**: works like hitting **[Enter]** (log QSO)
- **\$GRAB1 - \$GRAB9**: Grabs spot 1 to 9 from the [Partner window](#) and inserts it in the callsign field.
- **\$GRABRT1 - \$GRABRT3**: Grabs realtime spot 1 to 3 from the [Partner window](#) and inserts it in the callsign field.
- **\$GRABPARTNER**: grabs the first callsign from the [Partner window](#) and inserts it in the callsign field. See usage notes under [Partner window](#).
- **\$GRABSPOT**: grabs spot on the current frequency
- **\$GUESSEXCH** (or **\$GUESSEXCHANGE**): mimics a space bar hit, filling the exchange field(s) if possible, but the cursor remains in the same edit field.
- **\$REPEAT**: restarts the [automatic repeating CQ](#) sequence (if enabled), after pausing for the specified interval. Most useful at the end of the [\[Plus\] key message](#) to avoid having to press [F1] to start CQing again.
- **\$RSTEXCHSENT**: Resets the "exchangeSent" flag of the active QSO (useful only for [ESM scripts](#))
- **\$SETEXCHSENT**: Sets the "exchangeSent" flag of the active QSO (useful only for [ESM scripts](#))
- **\$SPACEBAR**: works like hitting spacebar-key (move cursor to the next most-used field)
- **\$TAB**: works like hitting **[Tab]** (move cursor to next field)

## SO2R

- **\$ALTERNATECQ** (or **\$ACQ**): swaps primary and secondary radios and send CQ on the secondary radio
- **\$CQ**: same as **\$ALTERNATECQ** but does not swap radios
- **\$LATCH**: sets latch mode
- **\$MK2R=cmd**: send a specific MK2R command to the microHAM MK2R SO2R box. See [Integrated SO2R boxes](#) for usage notes.
- **\$R1R1**: set audio of Radio 1 to left and right ear
- **\$R1R2**: set audio of Radio 1 to left and audio of Radio 2 to right ear
- **\$R2R1**: set audio of Radio 2 to left and audio of Radio 1 to right ear
- **\$R2R2**: set audio of Radio 2 to left and right ear
- **\$RESET**: cancels any manual change made in the audio control
- **\$TR1**: transmit on primary radio
- **\$TR2**: transmit on secondary radio

## WAEDC QTC related

- **\$CALLSIGN**: send callsign of the current QTC
- **\$DONE**: if all QTC are sent: mimic the **[+]** key
- **\$FIELD**: this variable takes the value "GROUP", "TIME", "CL" or "NR", depending on the kind of QTC field where the cursor is located
- **\$GRNR**: sends group & number of the received QTC
- **\$NEXT**: move focus to the next QTC line
- **\$QTC**: sends group & number of the transmitted QTC
- **\$QTCROW**: Row number of cursor location in the QTC window. Very useful to create a function key sending the message **PSE RPT QTC NR \$QTCROW \$QTCROW** in WAEDC RTTY to request repetition of a specific QTC.
- **\$RAWTIME**: send time without cut numbers in CW
- **\$SERIAL**: send serial number of the current QTC
- **\$SERIE**: send the complete QTC block (specific to RTTY)
- **\$TIME**: send time of the current QTC
- **\$VALID**: save everything and close the window

## Custom variables

The user may define "custom" variables with any unused name. They can be used in messages and easily updated while operating. They are mostly intended for the DXPedition mode, but they work for all CW and RTTY logs.

For example, one could define

- **\$REGION** as "EU", "NA", etc.
- **\$UP** as "UP" or "UP 5"

See [Options | CW | Custom variables...](#) for usage notes.

## Namespaces

- [Page](#)
- [Discussion](#)

## Variants

## Views

- [Read](#)
- [View source](#)
- [View history](#)

## More

- This page was last edited on 30 December 2021, at 12:41.
- [Privacy policy](#)
- [About Win-Test Wiki](#)
- [Disclaimers](#)





# Message variables

From Win-Test Wiki

[Jump to navigation](#) [Jump to search](#)

## Messages Variables

These variables can be used in programming CW messages using the F-keys. Some of these variables do not actually create output but rather perform actions at specific points in time, like the **\$CR** symbol.

### Contents

- [1 CW / RTTY automation](#)
- [2 RTTY only](#)
- [3 Action](#)
- [4 SO2R](#)
- [5 WAEDC QTC related](#)
- [6 Custom variables](#)

### CW / RTTY automation

- **\$CHECK**: send license year (ARRL SS only)
- **\$CORRECT**: sends a call correction, if any (see [correction](#))
- **\$CURRENT** (or **\$CURRENTCALL**): Sends the callsign of the current QSO *despite* the presence of a \$CR later in the message. The \$CR (carriage return) is always executed on message keypress. See [Windows | Partner](#) for usage examples. It is also useful in ESM (Enter Sends Message) mode in lieu of \$LOGGEDCALL.
- **\$F1 . . . \$F7**: sends the message associated with F1 ... F7 function key
- **\$FREQnn**: Where *nn* is a band (e.g. \$FREQ160, \$FREQ80 etc.). Useful in a multi-op as a canned message "PSE QSY \$FREQ15". Sends the frequency of the primary radio of the first networked station found on this band with the following priority : R, R+, M, and M+. In addition, in CW, if the frequency is within 100 Hz of a kHz boundary, the decimal point is omitted, e.g. 14021.09 is sent as 14021 and 14021.10 is sent as 14021R1.
- **\$FREQP**: contains the frequency of the primary radio (useful for passing mults)
- **\$FREQS**: contains the frequency of the secondary radio (useful for passing mults)
- **\$GRIDFIELD** (or **\$LOC4**, **\$GRID4**): contains the 4-char QTH locator (Maidenhead square) of the entrant
- **\$GRIDSQUARE** (or **\$LOC6**, **\$GRID6**): contains the 6-char QTH locator (Maidenhead square) of the entrant
- **\$INSERT**: sends message in the [**Ins**] key
- **\$ISLAND**: sends IOTA Reference (i.e. EU001, AF001, ...) (IOTA Contest)
- **\$LOGGED** (or **\$LOGGEDCALL**): sends what is typed in the callsign field of the current QSO, or if blank, the previous QSO
- **\$MSG1 . . . \$MSG12**: sends additional CW messages (see [Modify additional messages](#))
- **\$MYCALL**: sends callsign set in [contest configuration](#)
- **\$MYNAME**: sends operator name, set in [contest configuration](#)
- **\$NEXT** (or **\$NEXTCALL**): sends the callsign of the next QSO line when a \$CR is included in the message.
- **\$NEXTSERIAL**: sends next QSO serial number (current QSO serial number plus 1)

- **\$PLUS**: sends message in the **[+]** key
- **\$PREV** (or **\$PREVCALL**): sends the callsign on the previous QSO line.
- **\$PREVSERIAL**: sends previous QSO serial number (current QSO serial number minus 1)
- **\$QOQLC**: sends Quick QSL message based QSOs made (see [Intelligent Quick QSL](#))
- **\$QOQLT**: sends Quick QSL message based on time passed (see [Intelligent Quick QSL](#))
- **\$QOQLRESET**: reset the timer or the counter like if the long QSL message were just sent.
- **\$QSOB4**: sends the QSOB4 message and cancels the remainder of the current message, if the current QSO is a dupe, otherwise sends nothing (see [Modify standard messages](#))
- **\$RAWSERIAL**: sends the serial number of the QSO with leading zeros and without any abbreviation
- **\$RST**: sends report from RST Sent field (normally **5NN** for CW, **599** for RTTY)
- **\$SERIAL**: sends current QSO Serial Number, or previous serial number if the line with the cursor is blank.
- **\$STATE**: sends State/Province set in [contest configuration](#) (Exchange)
- **\$YEAR**: sends year nr set in [contest configuration](#) (i.e. EUHFC, AA)
- **\$ZONE**: sends zone nr set in [contest configuration](#)
- **&xy**: sends a [Morse prosign](#) where xy represents the two characters forming the prosign, e.g. &AS, &AR, &BK, &BT, &CL, &KN, &SK, etc.
- **+**: increase speed by 4 wpm
- **-**: decrease speed by 4 wpm
- **^**: the halfspace character with 1/2 dot duration
- **~**: (tilde) at then end of a variable means "no space" will be inserted, e.g. \$NEXT~? sends the next callsign followed by a question mark, with no space in between

## RTTY only

- **\$13**: send carriage return character (start print on a new line)
- **\$SERIE**: send the complete QTC block (WAEDC only)

## Action

- **\$CR**: works like hitting **[Enter]** (log QSO)
- **\$GRAB1** - **\$GRAB9**: Grabs spot 1 to 9 from the [Partner window](#) and inserts it in the callsign field.
- **\$GRABRT1** - **\$GRABRT3**: Grabs realtime spot 1 to 3 from the [Partner window](#) and inserts it in the callsign field.
- **\$GRABPARTNER**: grabs the first callsign from the [Partner window](#) and inserts it in the callsign field. See usage notes under [Partner window](#).
- **\$GRABSPOT**: grabs spot on the current frequency
- **\$GUESSEXCH** (or **\$GUESSEXCHANGE**): mimics a space bar hit, filling the exchange field(s) if possible, but the cursor remains in the same edit field.
- **\$REPEAT**: restarts the [automatic repeating CQ](#) sequence (if enabled), after pausing for the specified interval. Most useful at the end of the [\[Plus\] key message](#) to avoid having to press **[F1]** to start CQing again.
- **\$RSTEXCHSENT**: Resets the "exchangeSent" flag of the active QSO (useful only for [ESM scripts](#))
- **\$SETEXCHSENT**: Sets the "exchangeSent" flag of the active QSO (useful only for [ESM scripts](#))
- **\$SPACEBAR**: works like hitting spacebar-key (move cursor to the next most-used field)
- **\$TAB**: works like hitting **[Tab]** (move cursor to next field)

## SO2R

- **\$ALTERNATECQ** (or **\$ACQ**): swaps primary and secondary radios and send CQ on the secondary radio
- **\$CQ**: same as **\$ALTERNATECQ** but does not swap radios
- **\$LATCH**: sets latch mode
- **\$MK2R=cmd**: send a specific MK2R command to the microHAM MK2R SO2R box. See [Integrated SO2R boxes](#) for usage notes.
- **\$R1R1**: set audio of Radio 1 to left and right ear
- **\$R1R2**: set audio of Radio 1 to left and audio of Radio 2 to right ear
- **\$R2R1**: set audio of Radio 2 to left and audio of Radio 1 to right ear
- **\$R2R2**: set audio of Radio 2 to left and right ear
- **\$RESET**: cancels any manual change made in the audio control
- **\$TR1**: transmit on primary radio
- **\$TR2**: transmit on secondary radio

## WAEDC QTC related

- **\$CALLSIGN**: send callsign of the current QTC
- **\$DONE**: if all QTC are sent: mimic the **[+]** key
- **\$FIELD**: this variable takes the value "GROUP", "TIME", "CL" or "NR", depending on the kind of QTC field where the cursor is located
- **\$GRNR**: sends group & number of the received QTC
- **\$NEXT**: move focus to the next QTC line
- **\$QTC**: sends group & number of the transmitted QTC
- **\$QTCROW**: Row number of cursor location in the QTC window. Very useful to create a function key sending the message **PSE RPT QTC NR \$QTCROW \$QTCROW** in WAEDC RTTY to request repetition of a specific QTC.
- **\$RAWTIME**: send time without cut numbers in CW
- **\$SERIAL**: send serial number of the current QTC
- **\$SERIE**: send the complete QTC block (specific to RTTY)
- **\$TIME**: send time of the current QTC
- **\$VALID**: save everything and close the window

## Custom variables

The user may define "custom" variables with any unused name. They can be used in messages and easily updated while operating. They are mostly intended for the DXPedition mode, but they work for all CW and RTTY logs.

For example, one could define

- **\$REGION** as "EU", "NA", etc.
- **\$UP** as "UP" or "UP 5"

See [Options | CW | Custom variables...](#) for usage notes.

## Namespaces

- [Page](#)
- [Discussion](#)

## Variants

## Views

- [Read](#)
- [View source](#)
- [View history](#)

## More

- This page was last edited on 30 December 2021, at 12:41.

- [Privacy policy](#)
- [About Win-Test Wiki](#)
- [Disclaimers](#)

- The logo for MediaWiki, featuring a yellow sun icon and the text "Powered By MediaWiki".

# SO2R/MK2R

From Win-Test Wiki

[Jump to navigation](#) [Jump to search](#)

## Contents

- [1 Setting up the MK2R for use with Win-Test](#)
  - ◆ [1.1 Setting up the technique](#)
  - ◆ [1.2 Setting up the \[Shift\] key for secondary radio](#)
  - ◆ [1.3 Setting up the \[Caps Lock\] key for secondary radio](#)
  - ◆ [1.4 Setting the SO2R Control box](#)
    - ◇ [1.4.1 Device Router COM ports creation](#)
    - ◇ [1.4.2 Device Router COM ports setting](#)
    - ◇ [1.4.3 Device Router Audio Switching setting](#)
    - ◇ [1.4.4 Device Router Audio Mixer volume setting](#)
    - ◇ [1.4.5 Device Router PTT and FSK setting](#)
    - ◇ [1.4.6 Device Router Internal CW Keyer setting](#)
    - ◇ [1.4.7 Device Router CW Messages setting](#)
    - ◇ [1.4.8 Device Router FSK Messages setting](#)
    - ◇ [1.4.9 Device Router DVK Voice Messages setting](#)
    - ◇ [1.4.10 Device Router Keyboard setting](#)
    - ◇ [1.4.11 Device Router SO2R Behaviour setting](#)
    - ◇ [1.4.12 Device Router ACC port setting](#)
    - ◇ [1.4.13 Device Router SO2R Audio switching setting](#)
    - ◇ [1.4.14 Device Router SAVE your setting](#)
    - ◇ [1.4.15 Device Router Overall Device setting view](#)
    - ◇ [1.4.16 Device Router set Win-Test Interfaces configuration](#)
- [2 See also](#)
  - ◆ [2.1 External sources](#)

## Setting up the MK2R for use with Win-Test

Advanced SO2R mode and setting up scenarios requires external SO2R control equipment of the last generation, communicating with Win-Test via a USB port. MK2R from MicroHAM has this possibility.

### Setting up the technique

The user must check in the menu `Operating | Technique | Advanced SO2R`.

### Setting up the [Shift] key for secondary radio

The user must check in the menu `Operating | Shift binds to the secondary radio`.

### Setting up the [Caps Lock] key for secondary radio

The user must check in the menu `Operating | Caps Lock binds to the secondary radio`.

## Setting the SO2R Control box

Shown below are screen shots of a step-by-step setup procedure.

### Device Router COM ports creation

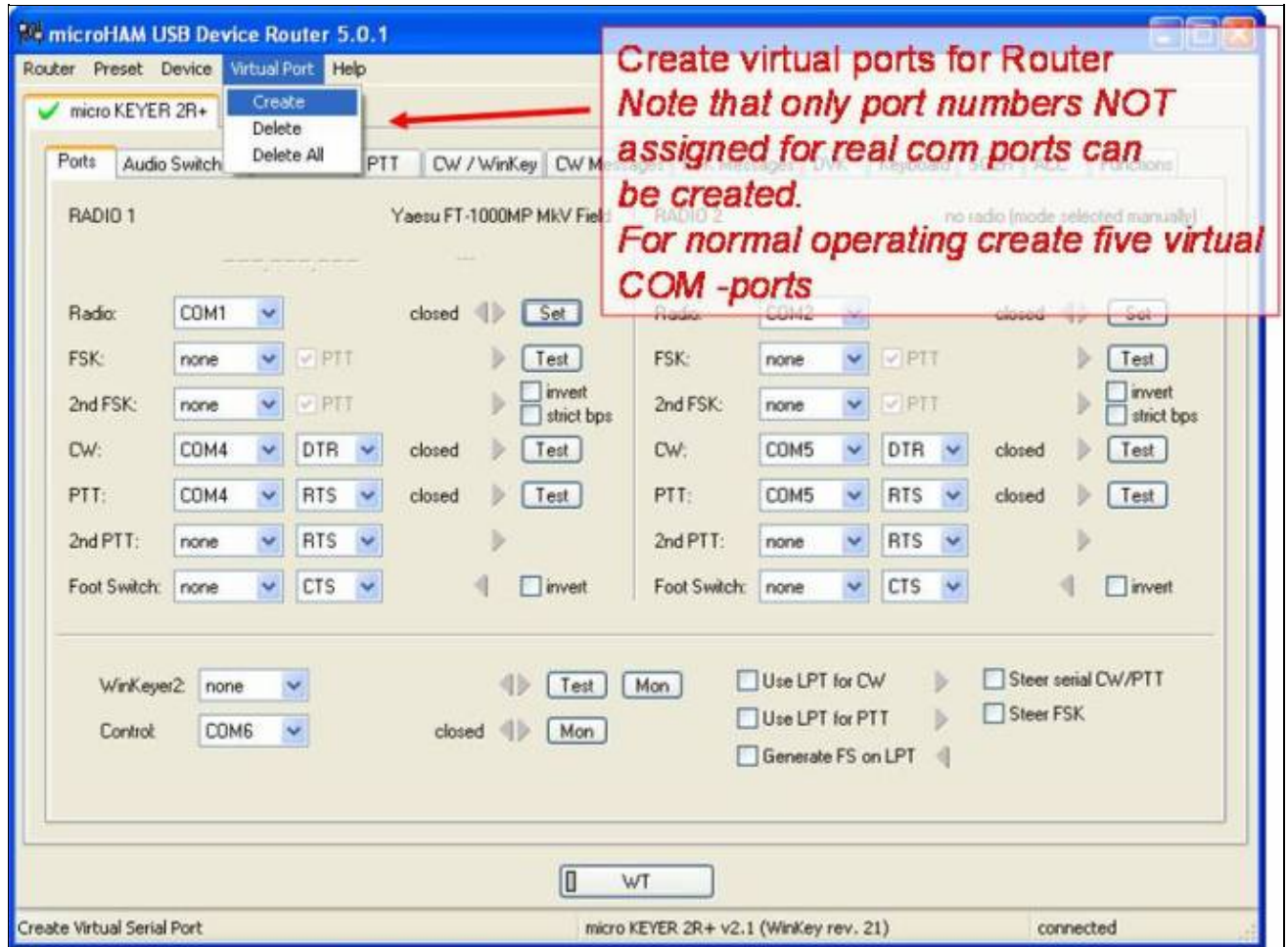

COM ports creation

**Device Router COM ports setting**

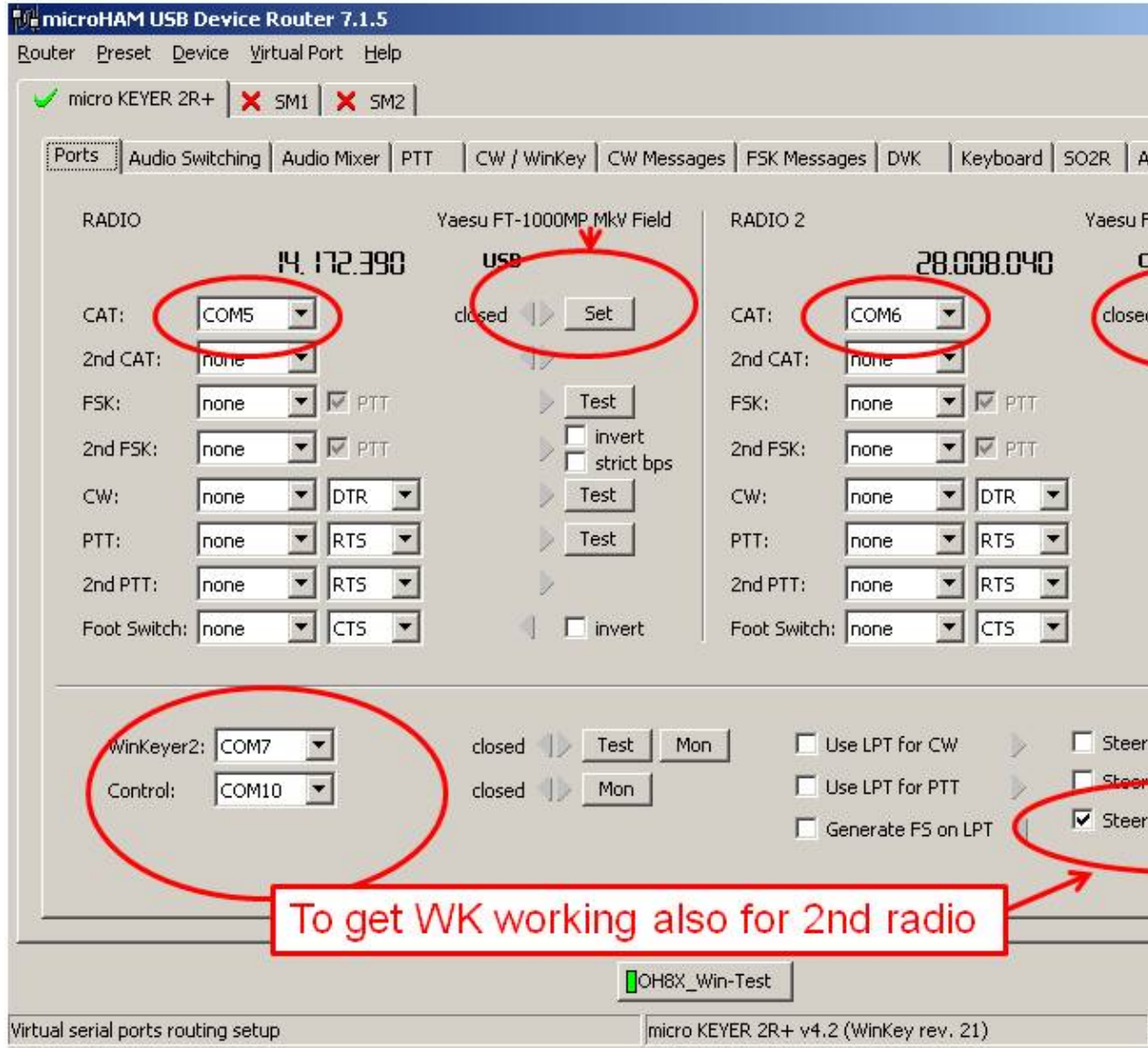

COM port setting

Device Router Audio Switching setting

The screenshot shows the 'microHAM USB Device Router 7.1.5' software interface. At the top, there are menu options: Router, Preset, Device, Virtual Port, and Help. Below the menu, there are status indicators for 'micro KEYER 2R+' (checked), 'SM1' (unchecked), and 'SM2' (unchecked). The main interface is divided into sections for 'Radio 1' and 'Radio 2'. Each radio section has a 'VOICE CODEC (SC1)' and a 'RADIO' section. The 'VOICE CODEC (SC1)' section includes 'OUTPUT' and 'MIC INPUT' labels with red arrows indicating signal flow. The 'RADIO' section includes 'REAR AUDIO' and 'FRONT MIC' labels, a radio icon, and a 'VOX or command PTT' checkbox. To the right of the radio sections, there are radio buttons labeled 'A', 'B', and 'C'. Below the radio sections, there are additional settings for 'Audio switching', 'CW', 'VOICE', 'FSK/DIGITAL', and 'VOICE/DIGITAL'. A red box with white text is overlaid on the interface, containing the text: 'May be problem on 40M SSB, Either select voice settings or modify digital band map for SSB contests'. The bottom of the interface shows a status bar with 'OH8X\_Win-Test' and 'Microphone, sound card & Radio routing setup'.



audio switching setting

### Device Router Audio Mixer volume setting

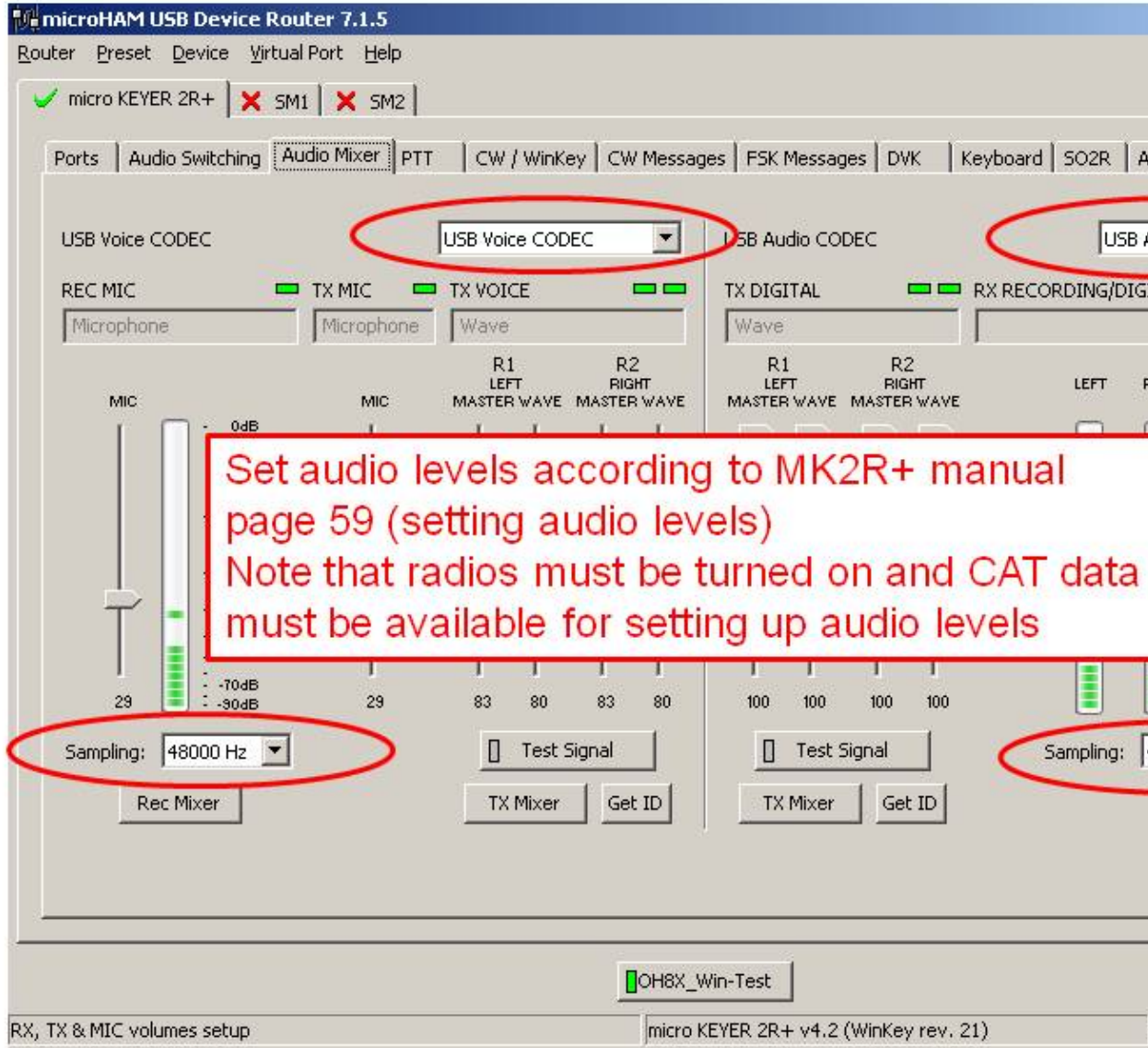

Audio Mixer volume setting

### Device Router PTT and FSK setting

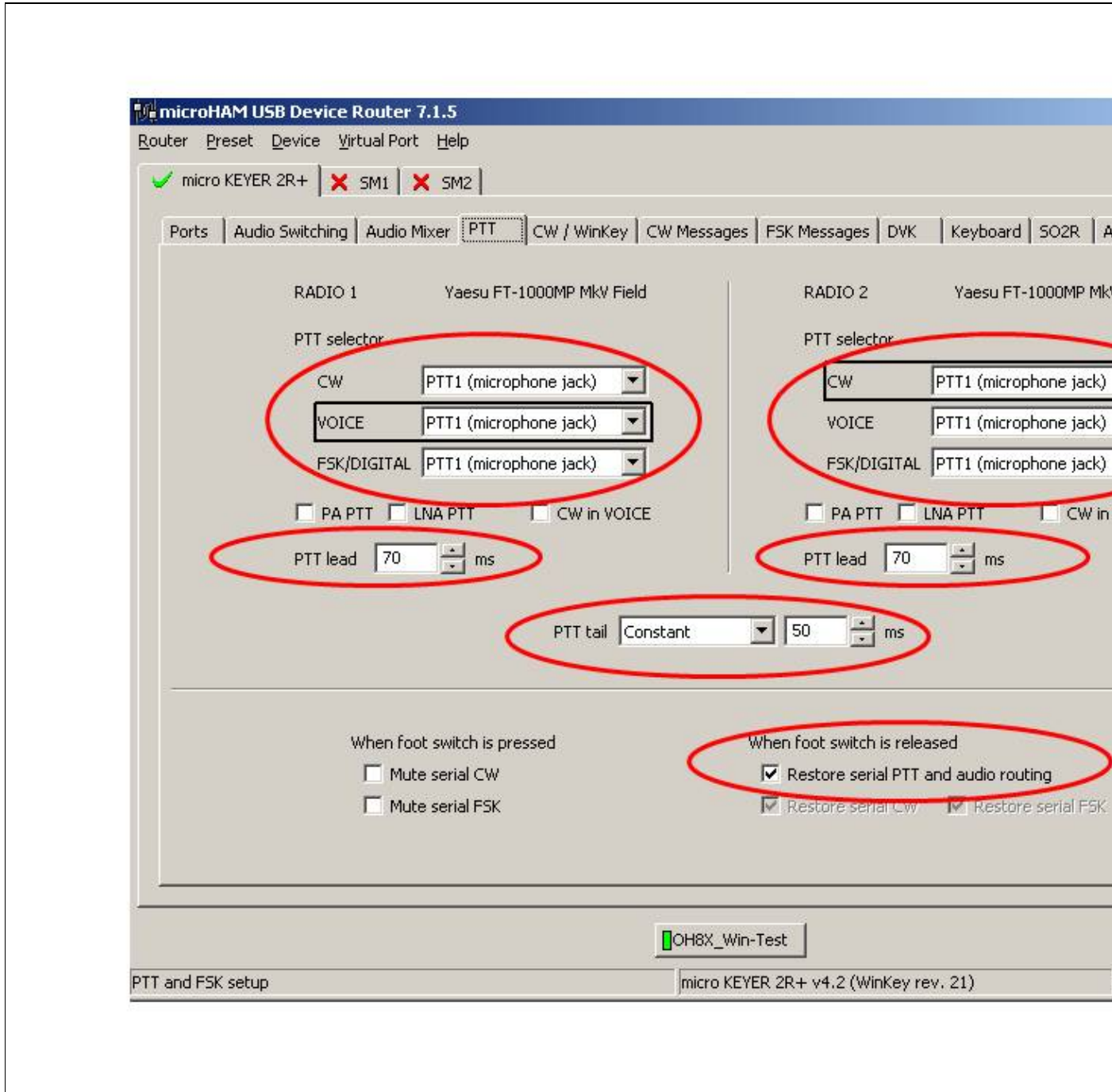

PTT and FSK setting

### Device Router Internal CW Keyer setting

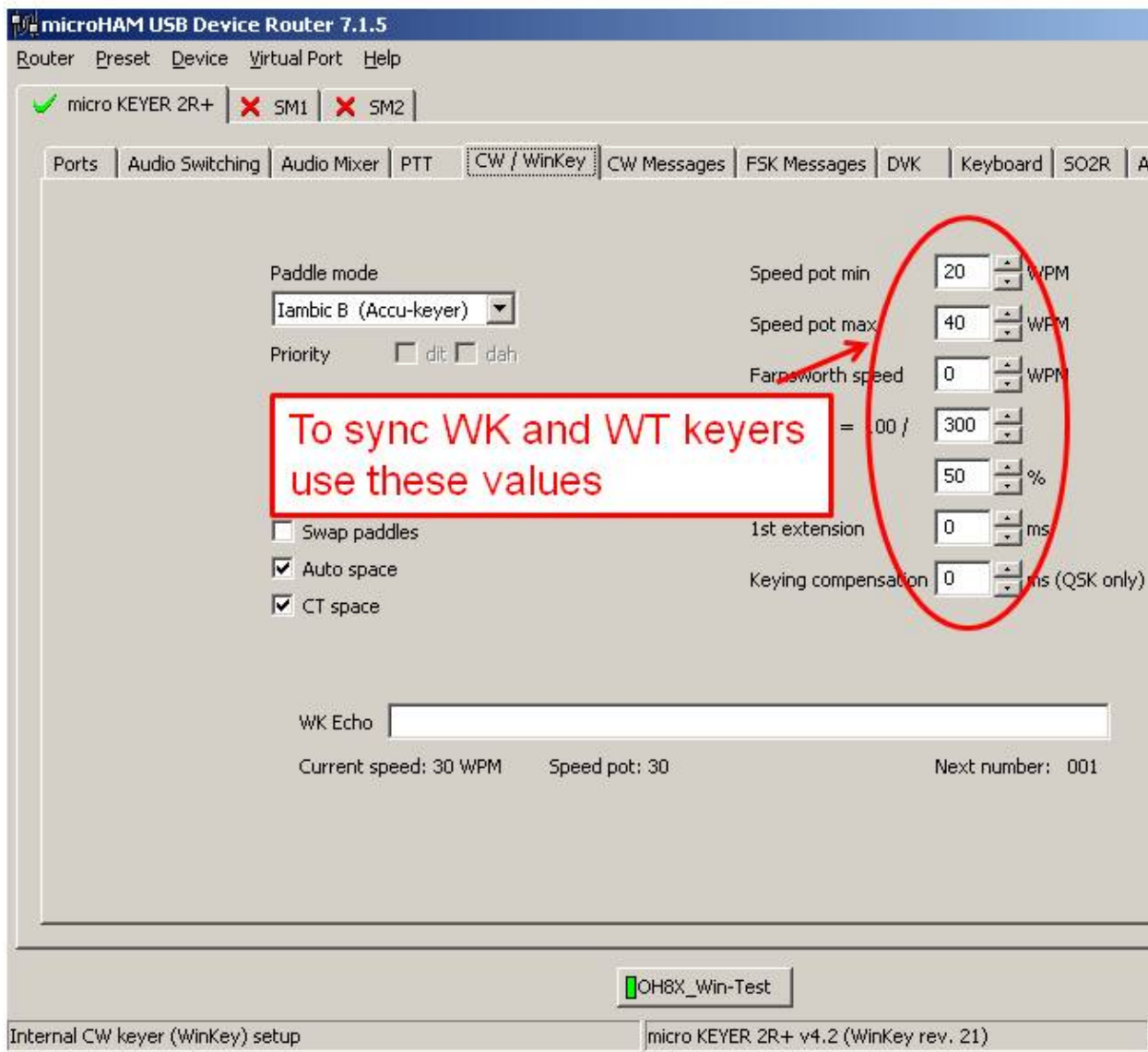

Internal CW Keyer setting

### Device Router CW Messages setting

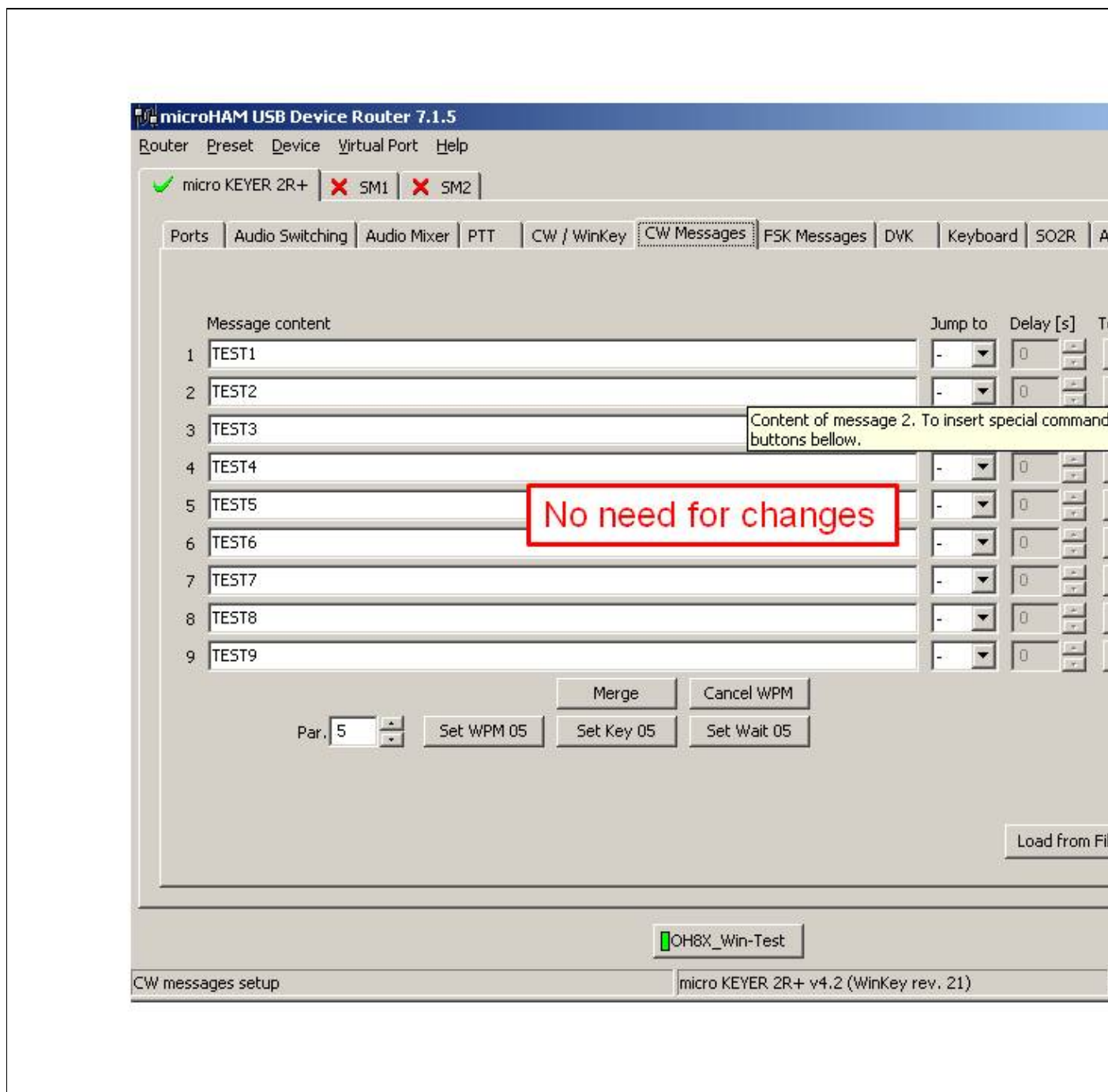

CW Messages setting

### Device Router FSK Messages setting

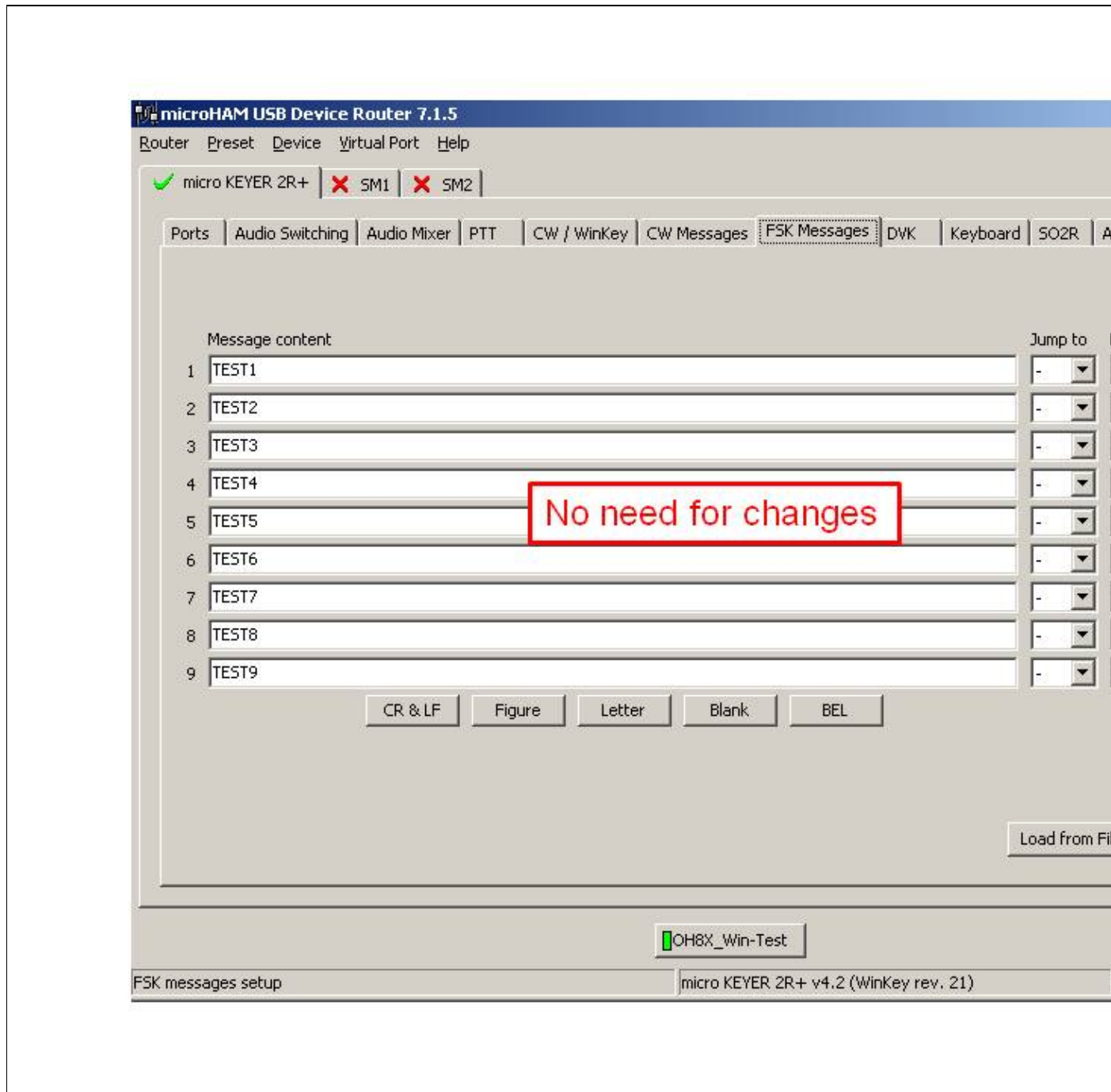

FSK Messages setting

**Device Router DVK Voice Messages setting**

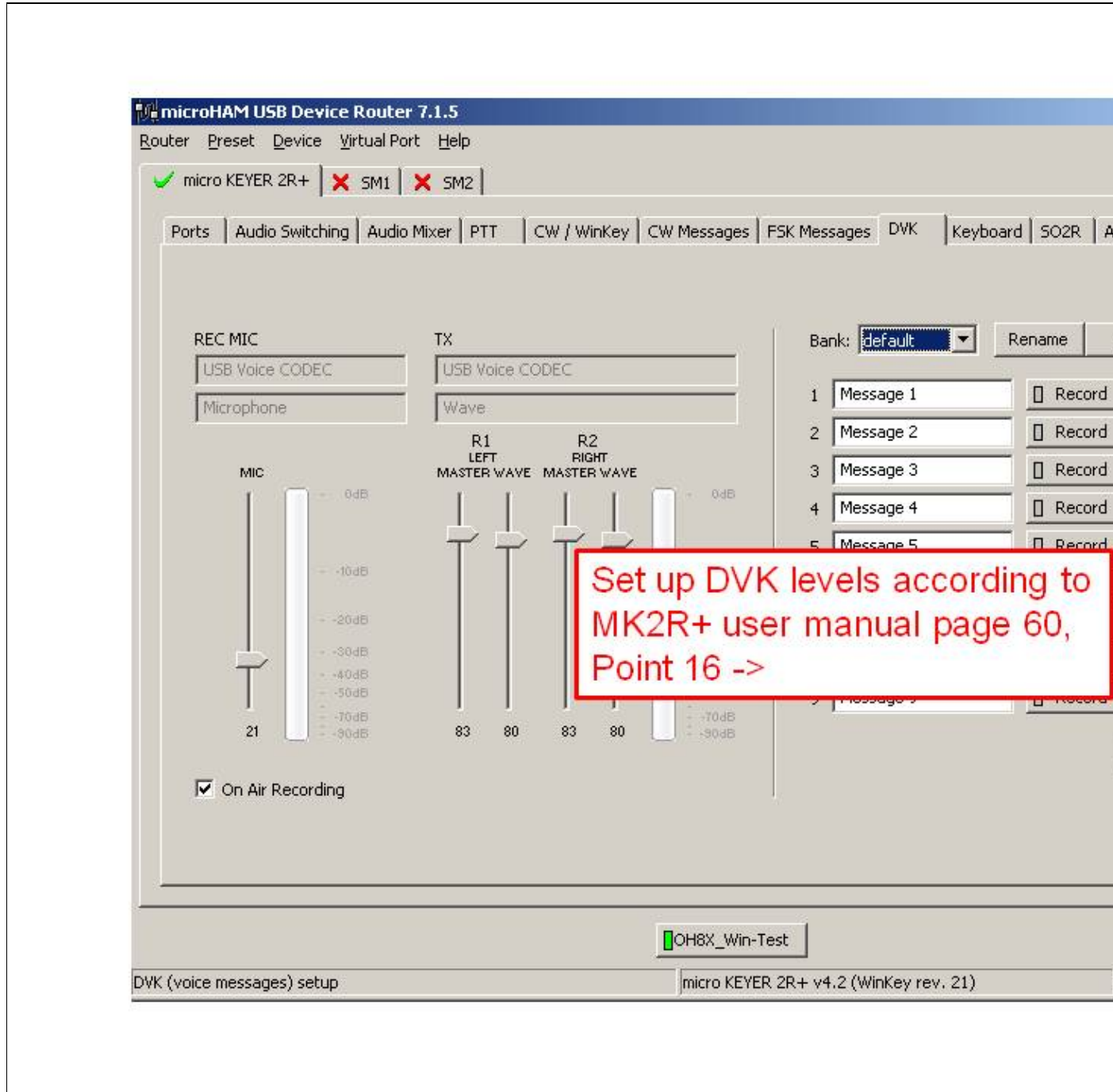

DVK Voice Messages setting  
**Device Router Keyboard setting**

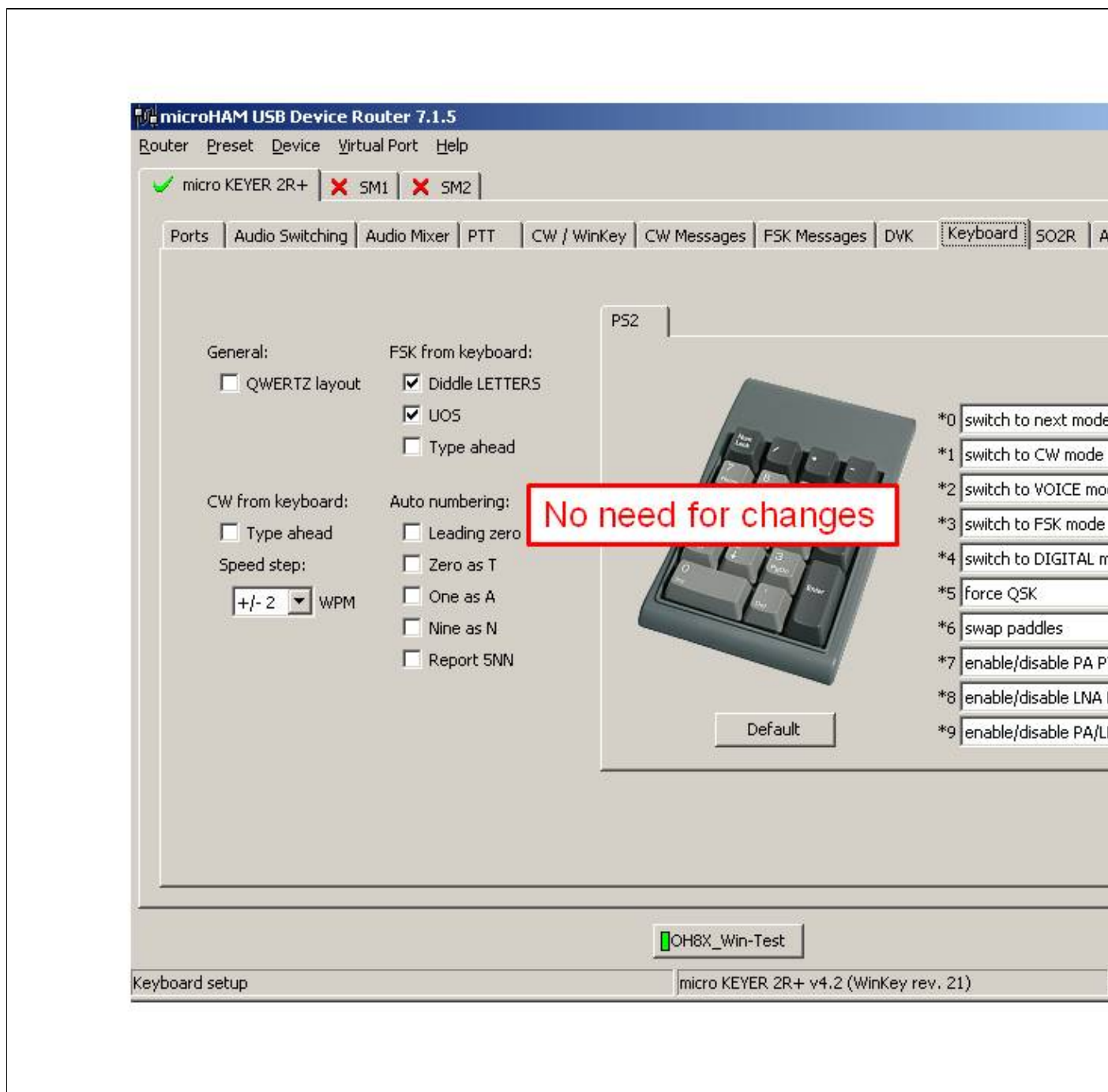

Keyboard setting

**Device Router SO2R Behaviour setting**

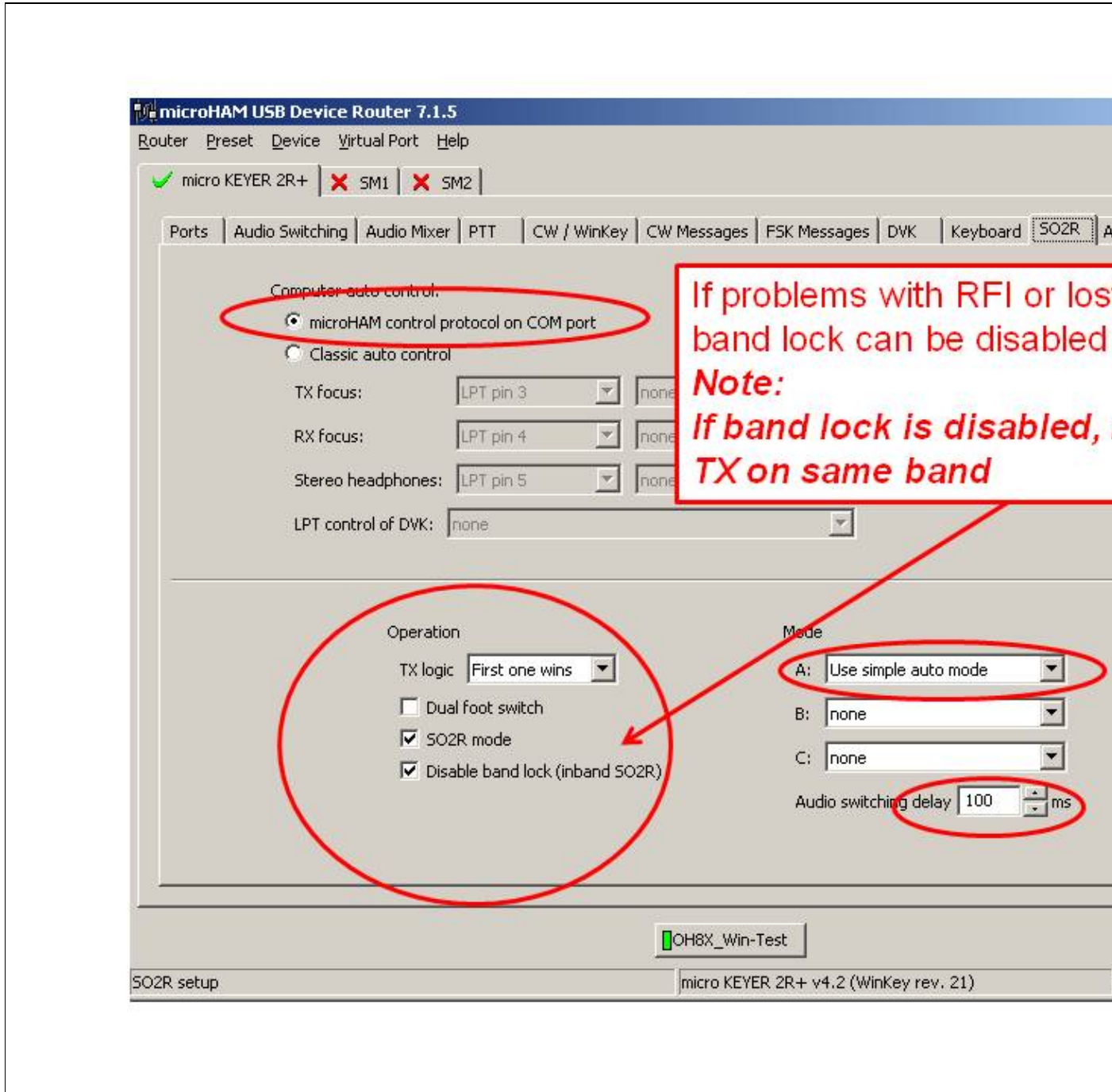



SO2R Behaviour setting

**Device Router ACC port setting**

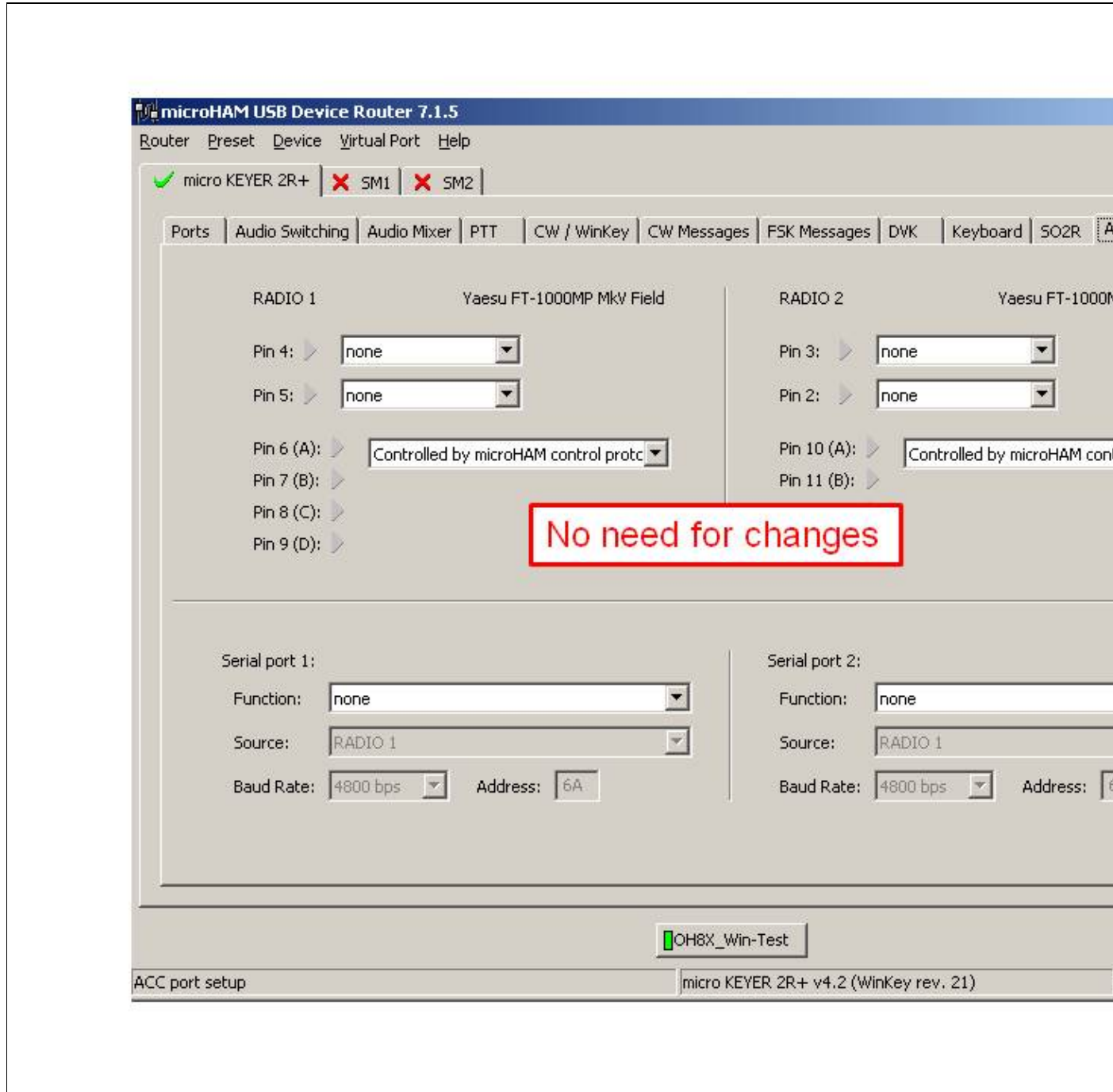

ACC port setting

### Device Router SO2R Audio switching setting

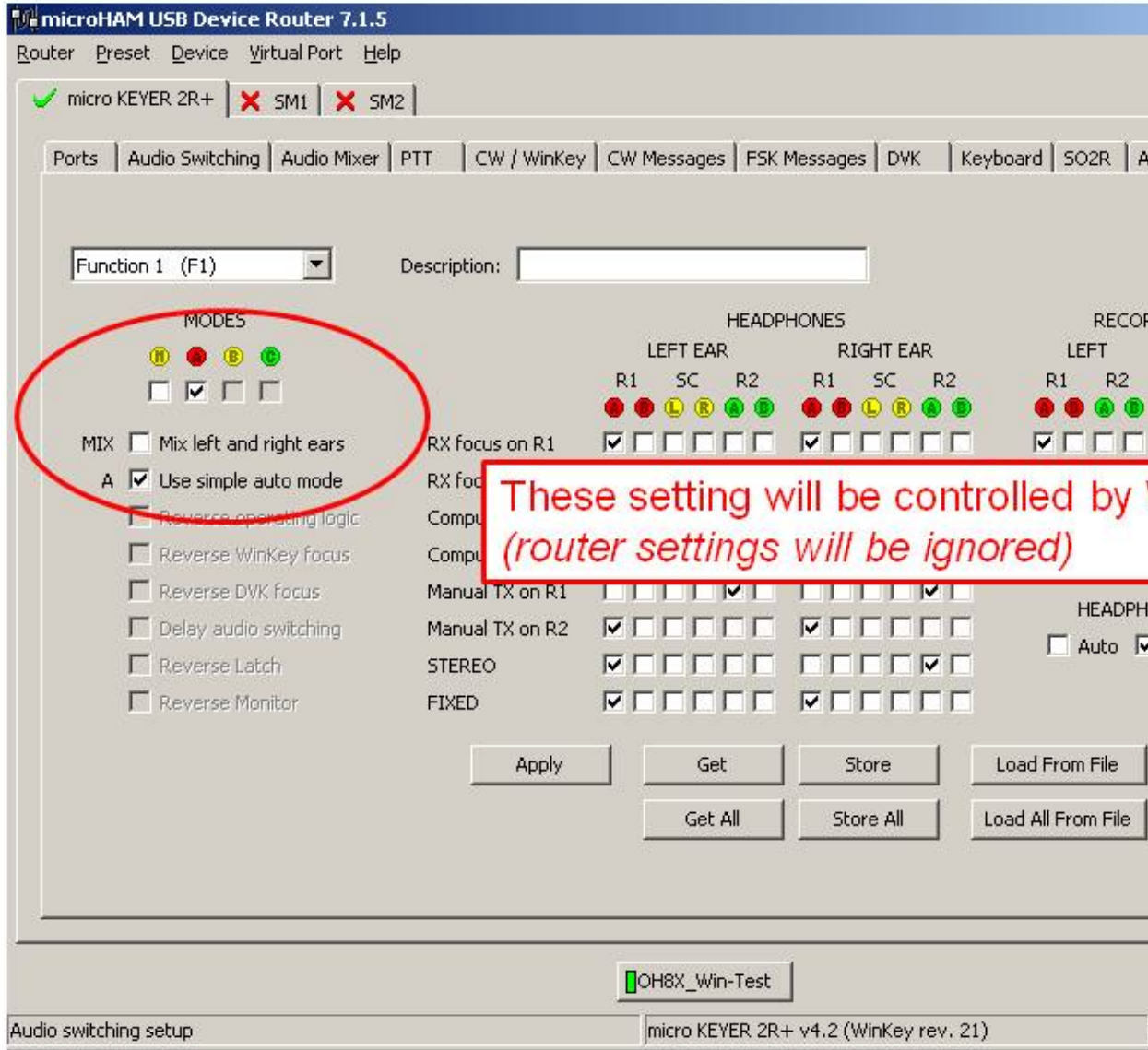

SO2R Audio switching setting

**Device Router SAVE your setting**

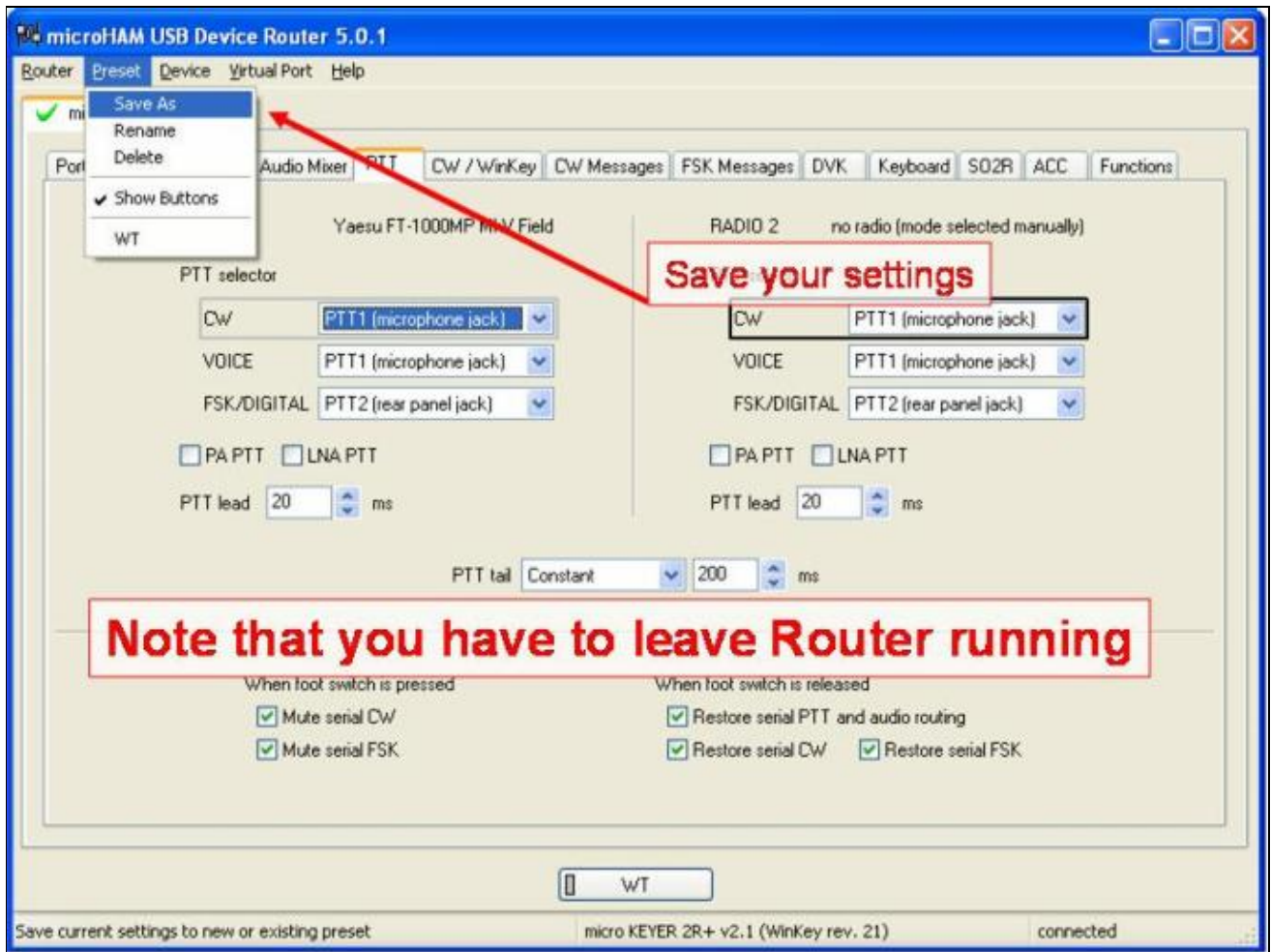

SAVE your setting

**Device Router Overall Device setting view**

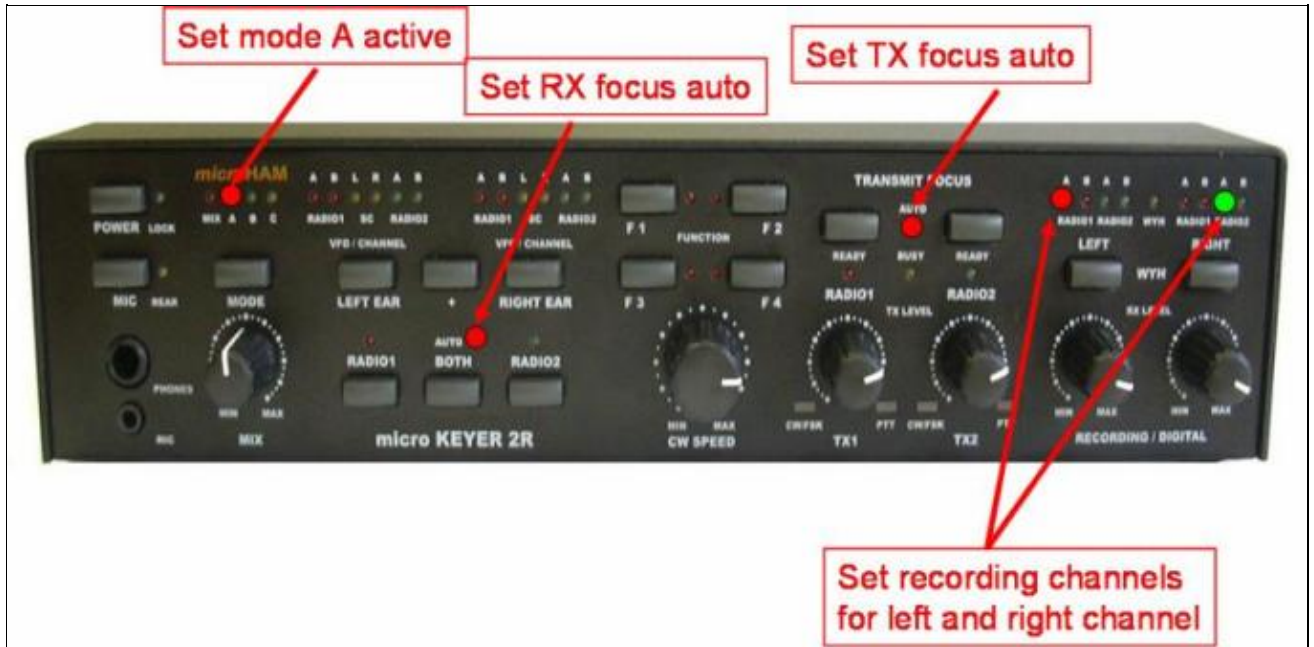

Overall Device setting view

**Device Router set Win-Test Interfaces configuration**

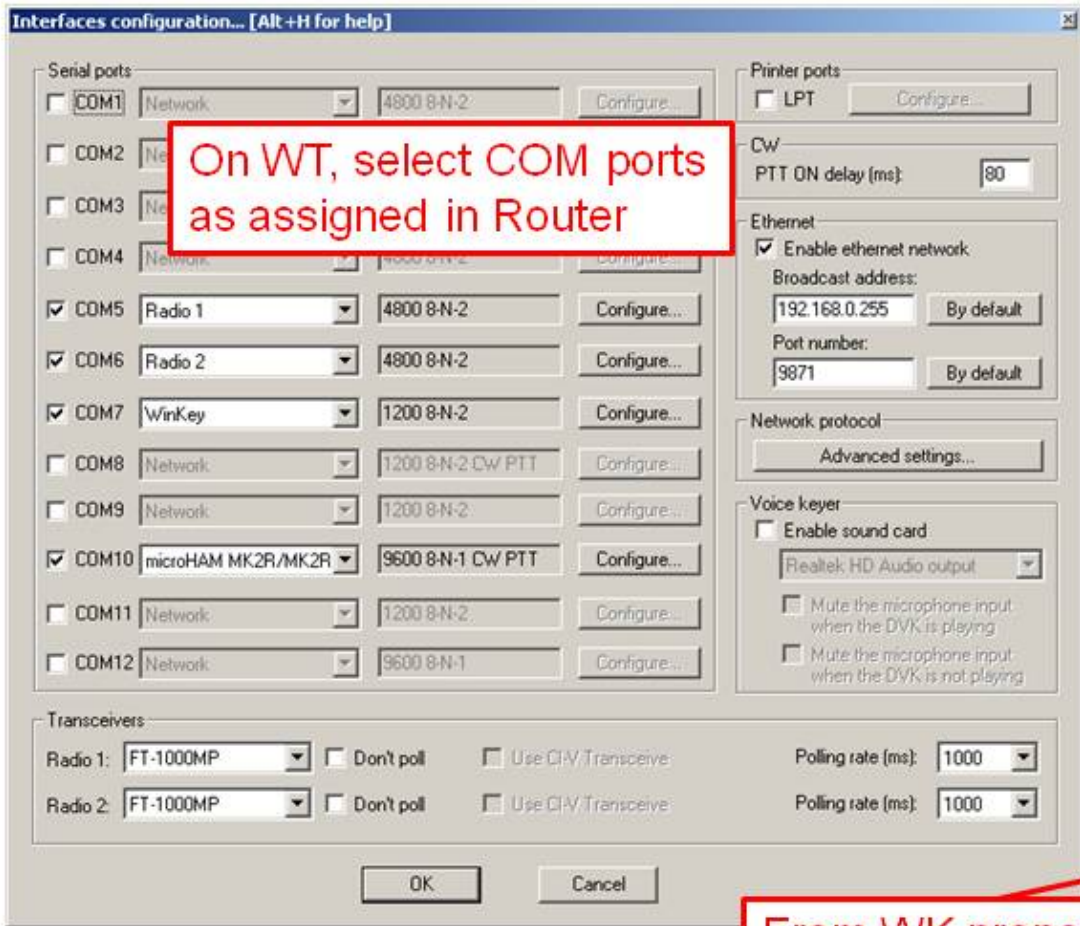

On WT, select COM ports as assigned in Router

From WK properties select indendent speed to keep WT and WK in sync.

Win-Test Interfaces configuration

## See also

## External sources

- [microHAM MK2R/MK2R+ and Win-Test setup guide](#) - PDF document
- [microHAM logger integration page](#)
- [microHAM web site](#)

## Namespaces

- [Page](#)
- [Discussion](#)

## Variants

## Views

- [Read](#)
- [View source](#)
- [View history](#)

## More

- This page was last edited on 12 September 2013, at 14:24.

- [Privacy policy](#)
- [About Win-Test Wiki](#)
- [Disclaimers](#)



# SO2R/MK2R

From Win-Test Wiki

[Jump to navigation](#) [Jump to search](#)

## Contents

- [1 Setting up the MK2R for use with Win-Test](#)
  - ◆ [1.1 Setting up the technique](#)
  - ◆ [1.2 Setting up the \[Shift\] key for secondary radio](#)
  - ◆ [1.3 Setting up the \[Caps Lock\] key for secondary radio](#)
  - ◆ [1.4 Setting the SO2R Control box](#)
    - ◇ [1.4.1 Device Router COM ports creation](#)
    - ◇ [1.4.2 Device Router COM ports setting](#)
    - ◇ [1.4.3 Device Router Audio Switching setting](#)
    - ◇ [1.4.4 Device Router Audio Mixer volume setting](#)
    - ◇ [1.4.5 Device Router PTT and FSK setting](#)
    - ◇ [1.4.6 Device Router Internal CW Keyer setting](#)
    - ◇ [1.4.7 Device Router CW Messages setting](#)
    - ◇ [1.4.8 Device Router FSK Messages setting](#)
    - ◇ [1.4.9 Device Router DVK Voice Messages setting](#)
    - ◇ [1.4.10 Device Router Keyboard setting](#)
    - ◇ [1.4.11 Device Router SO2R Behaviour setting](#)
    - ◇ [1.4.12 Device Router ACC port setting](#)
    - ◇ [1.4.13 Device Router SO2R Audio switching setting](#)
    - ◇ [1.4.14 Device Router SAVE your setting](#)
    - ◇ [1.4.15 Device Router Overall Device setting view](#)
    - ◇ [1.4.16 Device Router set Win-Test Interfaces configuration](#)
- [2 See also](#)
  - ◆ [2.1 External sources](#)

## Setting up the MK2R for use with Win-Test

Advanced SO2R mode and setting up scenarios requires external SO2R control equipment of the last generation, communicating with Win-Test via a USB port. MK2R from MicroHAM has this possibility.

### Setting up the technique

The user must check in the menu `Operating | Technique | Advanced SO2R`.

### Setting up the [Shift] key for secondary radio

The user must check in the menu `Operating | Shift binds to the secondary radio`.

### Setting up the [Caps Lock] key for secondary radio

The user must check in the menu `Operating | Caps Lock binds to the secondary radio`.

## Setting the SO2R Control box

Shown below are screen shots of a step-by-step setup procedure.

### Device Router COM ports creation

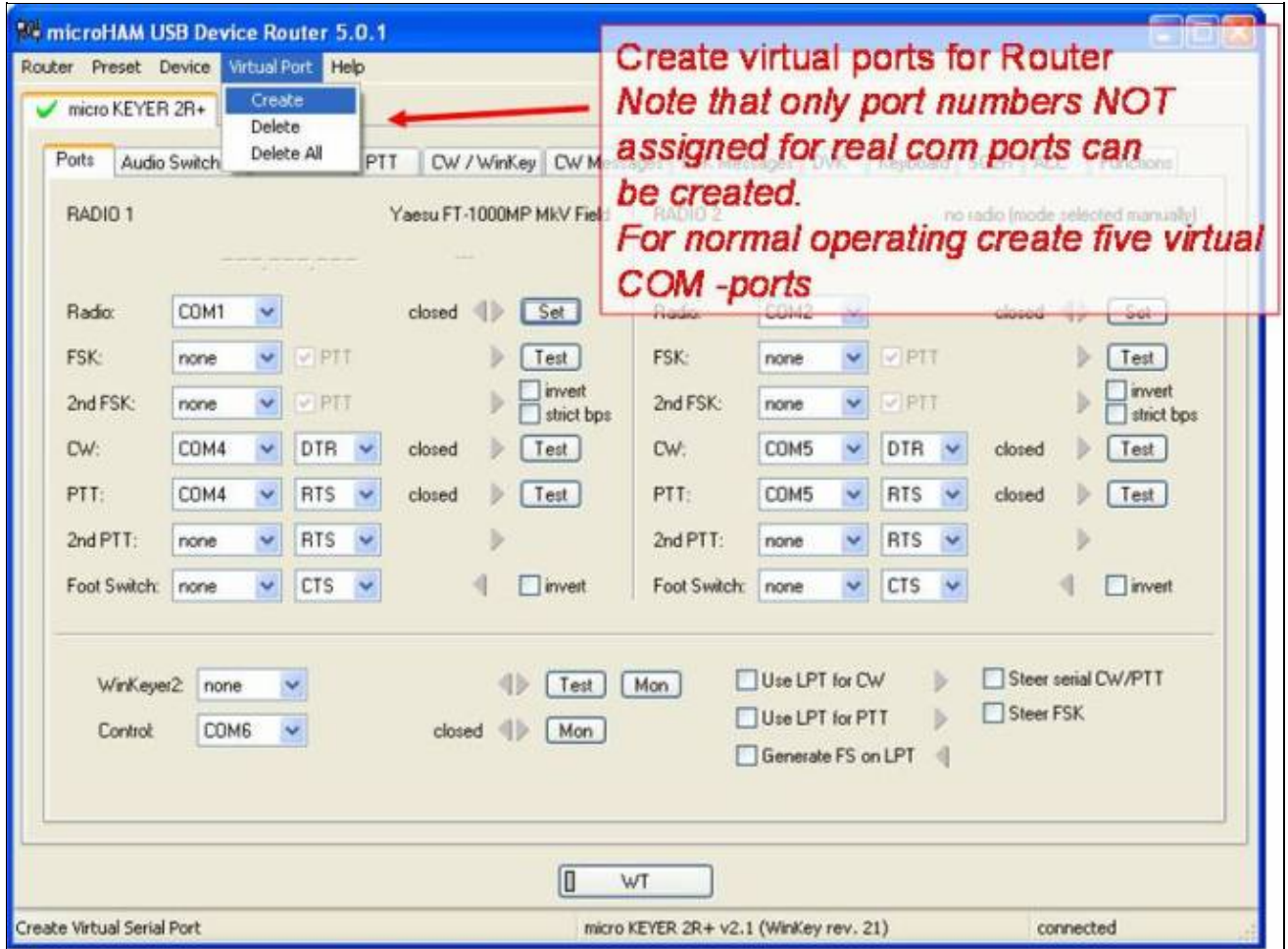



COM ports creation

**Device Router COM ports setting**

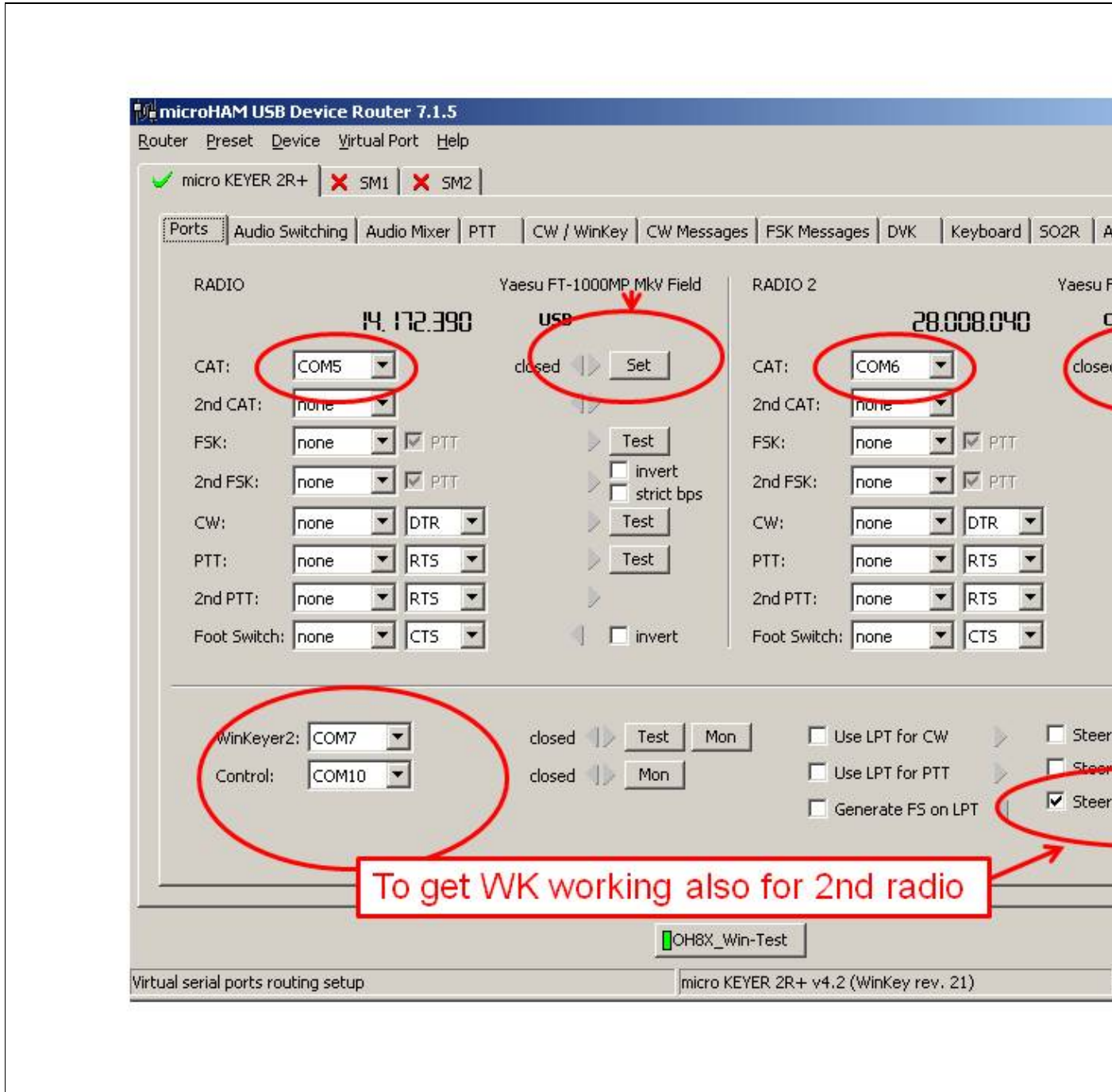

COM port setting

Device Router Audio Switching setting

The screenshot shows the 'microHAM USB Device Router 7.1.5' software interface. At the top, there are menu options: Router, Preset, Device, Virtual Port, and Help. Below the menu, there are status indicators for 'micro KEYER 2R+' (checked), 'SM1' (unchecked), and 'SM2' (unchecked). The main interface is divided into sections for 'Radio 1' and 'Radio 2'. Each radio section has a 'VOICE CODEC (SC1)' and a 'RADIO' section. The 'VOICE CODEC (SC1)' section includes 'OUTPUT' and 'MIC INPUT' labels with red arrows indicating signal flow. The 'RADIO' section includes 'REAR AUDIO' and 'FRONT MIC' labels, a radio icon, and a 'VOX or command PTT' checkbox. To the right of the radio sections, there are radio buttons labeled 'A', 'B', and 'C'. Below the radio sections, there are additional settings for 'Audio switching', 'CW', 'VOICE', 'FSK/DIGITAL', and 'VOICE/DIGITAL'. A red box with white text is overlaid on the interface, containing the text: 'May be problem on 40M SSB, Either select voice settings or modify digital band map for SSB contests'. The bottom of the interface shows a status bar with 'OH8X\_Win-Test' and 'Microphone, sound card & Radio routing setup'.

audio switching setting

**Device Router Audio Mixer volume setting**

microHAM USB Device Router 7.1.5

Router Preset Device Virtual Port Help

micro KEYER 2R+ SM1 SM2

Ports Audio Switching **Audio Mixer** PTT CW / WinKey CW Messages FSK Messages DVK Keyboard SO2R A

USB Voice CODEC **USB Voice CODEC** USB Audio CODEC **USB A**

REC MIC TX MIC TX VOICE TX DIGITAL RX RECORDING/DIG

Microphone Microphone Wave Wave

MIC MIC R1 LEFT R2 RIGHT R1 LEFT R2 RIGHT

0dB MASTER WAVE MASTER WAVE MASTER WAVE MASTER WAVE

-70dB -90dB

29 29 83 80 83 80 100 100 100 100

**Sampling: 48000 Hz** Test Signal Test Signal **Sampling:**

Rec Mixer TX Mixer Get ID TX Mixer Get ID

OH8X\_Win-Test

RX, TX & MIC volumes setup micro KEYER 2R+ v4.2 (WinKey rev. 21)

Set audio levels according to MK2R+ manual page 59 (setting audio levels)  
Note that radios must be turned on and CAT data must be available for setting up audio levels

Audio Mixer volume setting

**Device Router PTT and FSK setting**

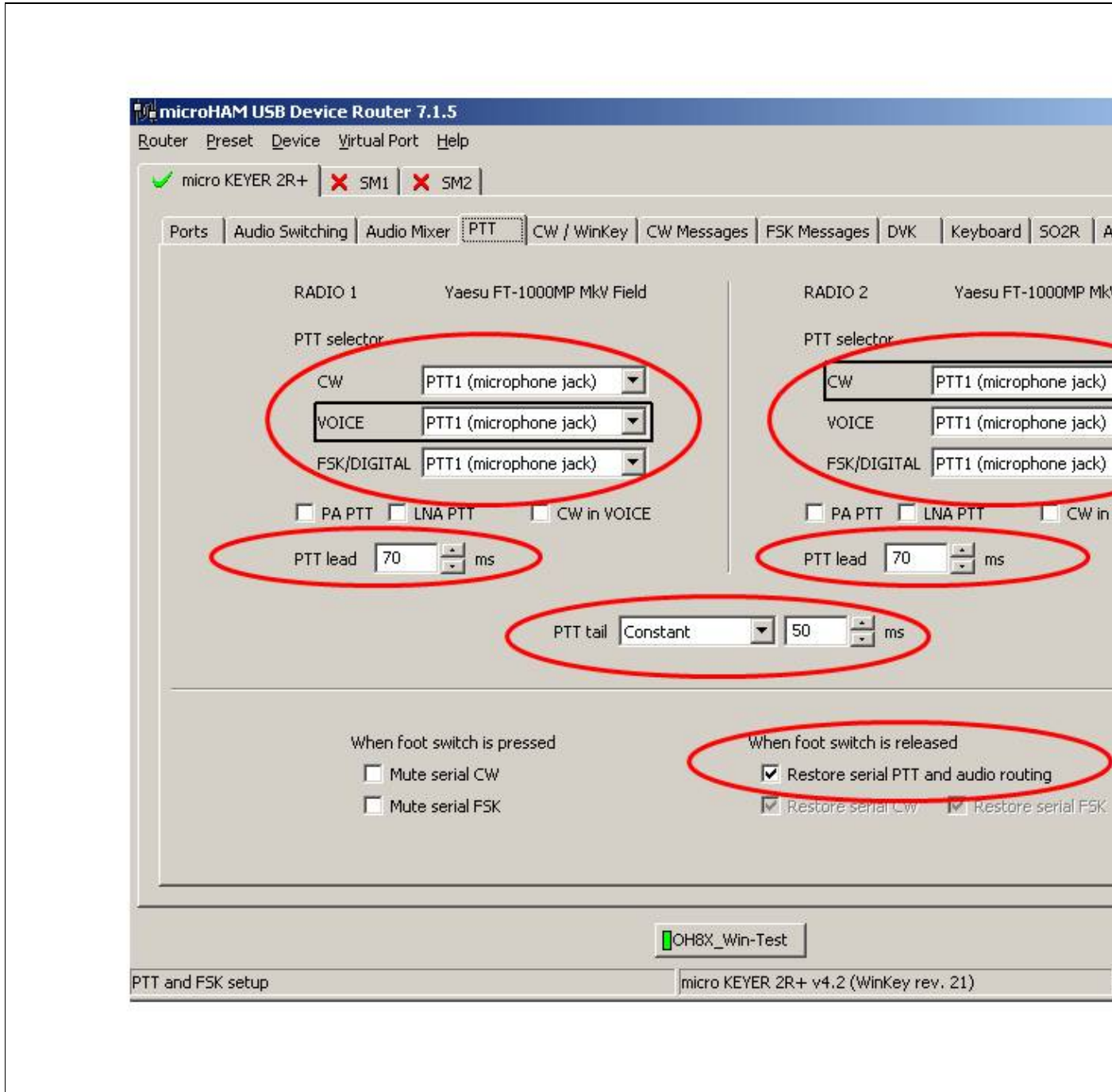

PTT and FSK setting

### Device Router Internal CW Keyer setting

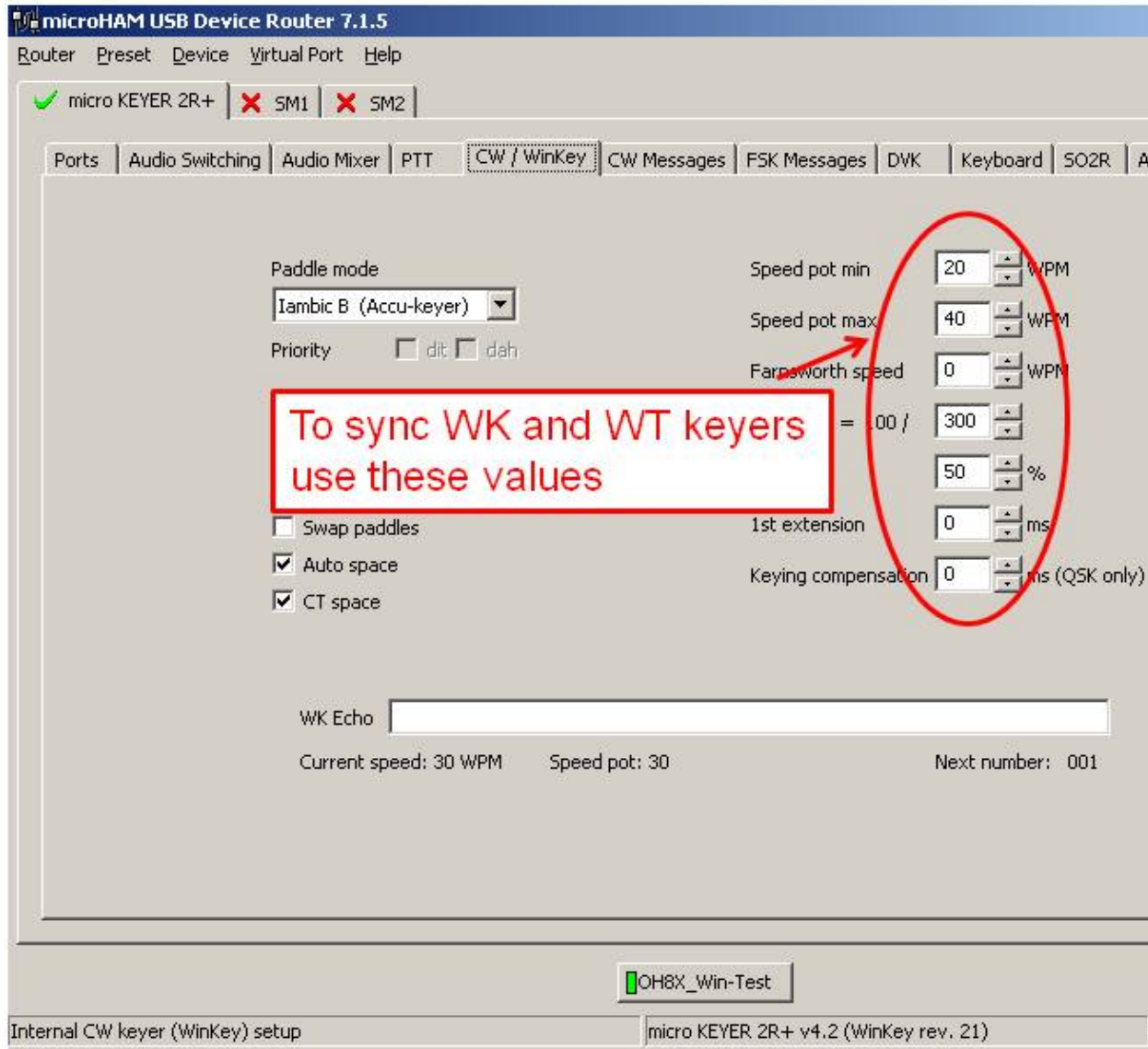

Internal CW Keyer setting

### Device Router CW Messages setting

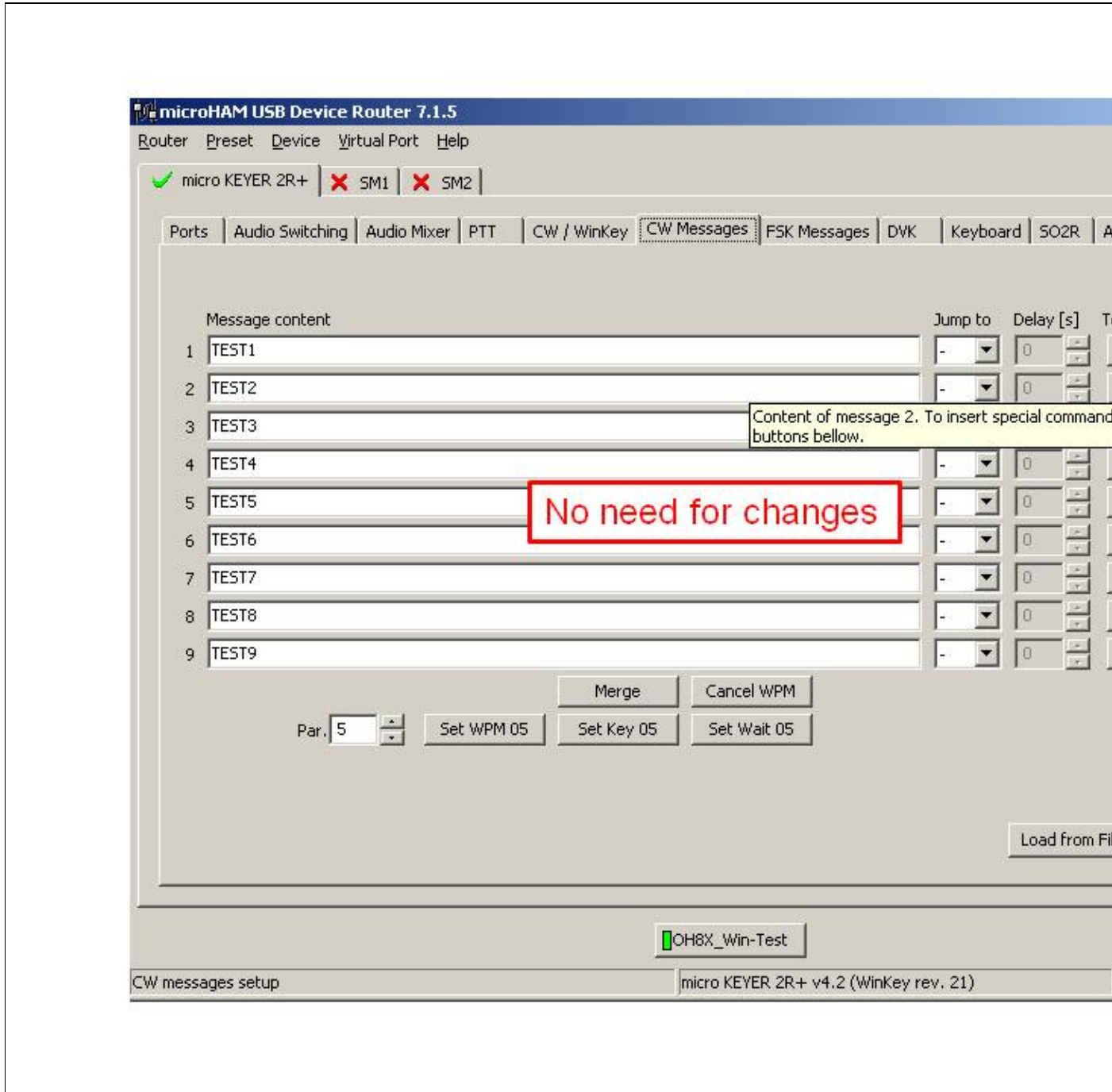

CW Messages setting

**Device Router FSK Messages setting**

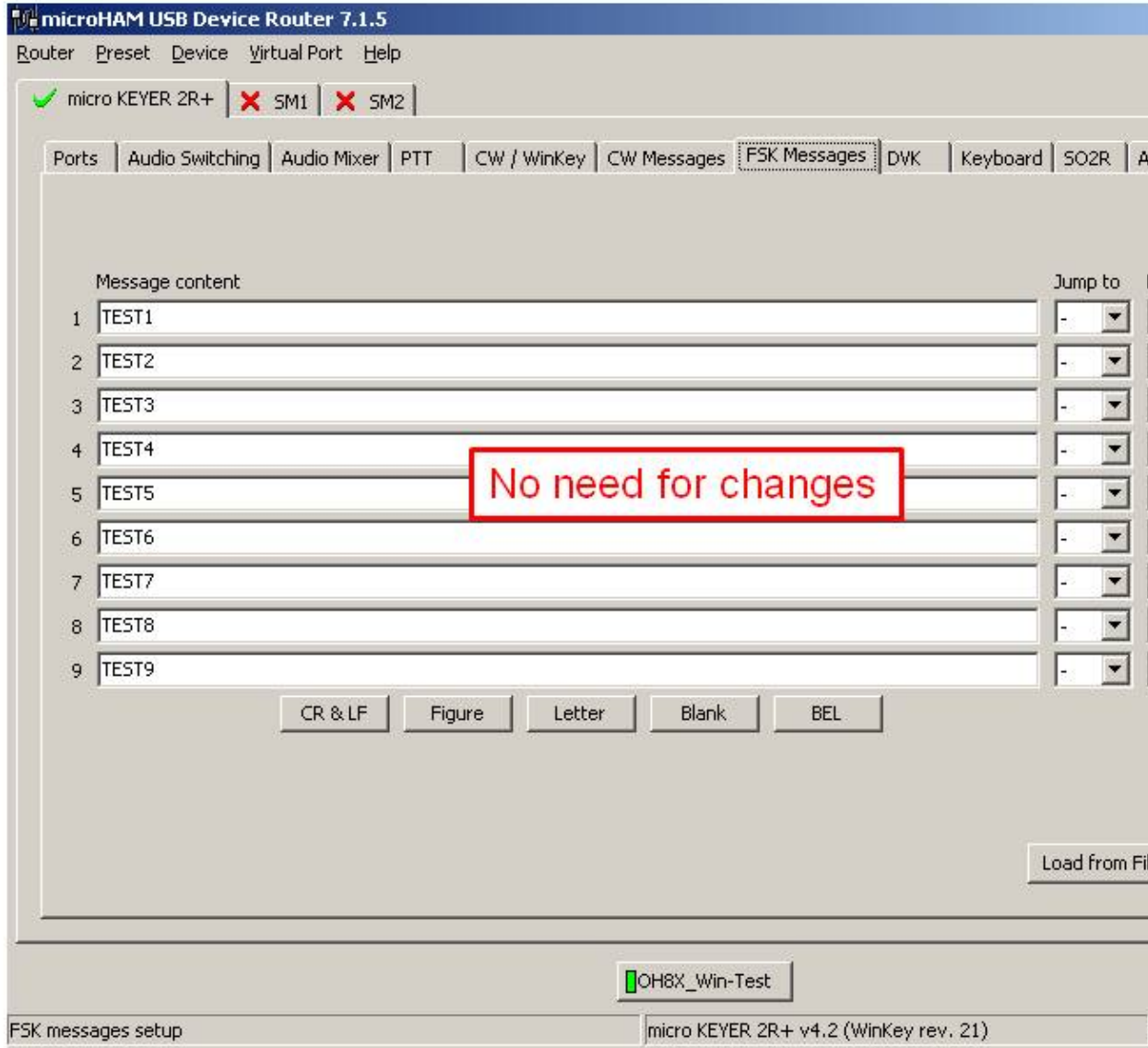

FSK Messages setting

### Device Router DVK Voice Messages setting

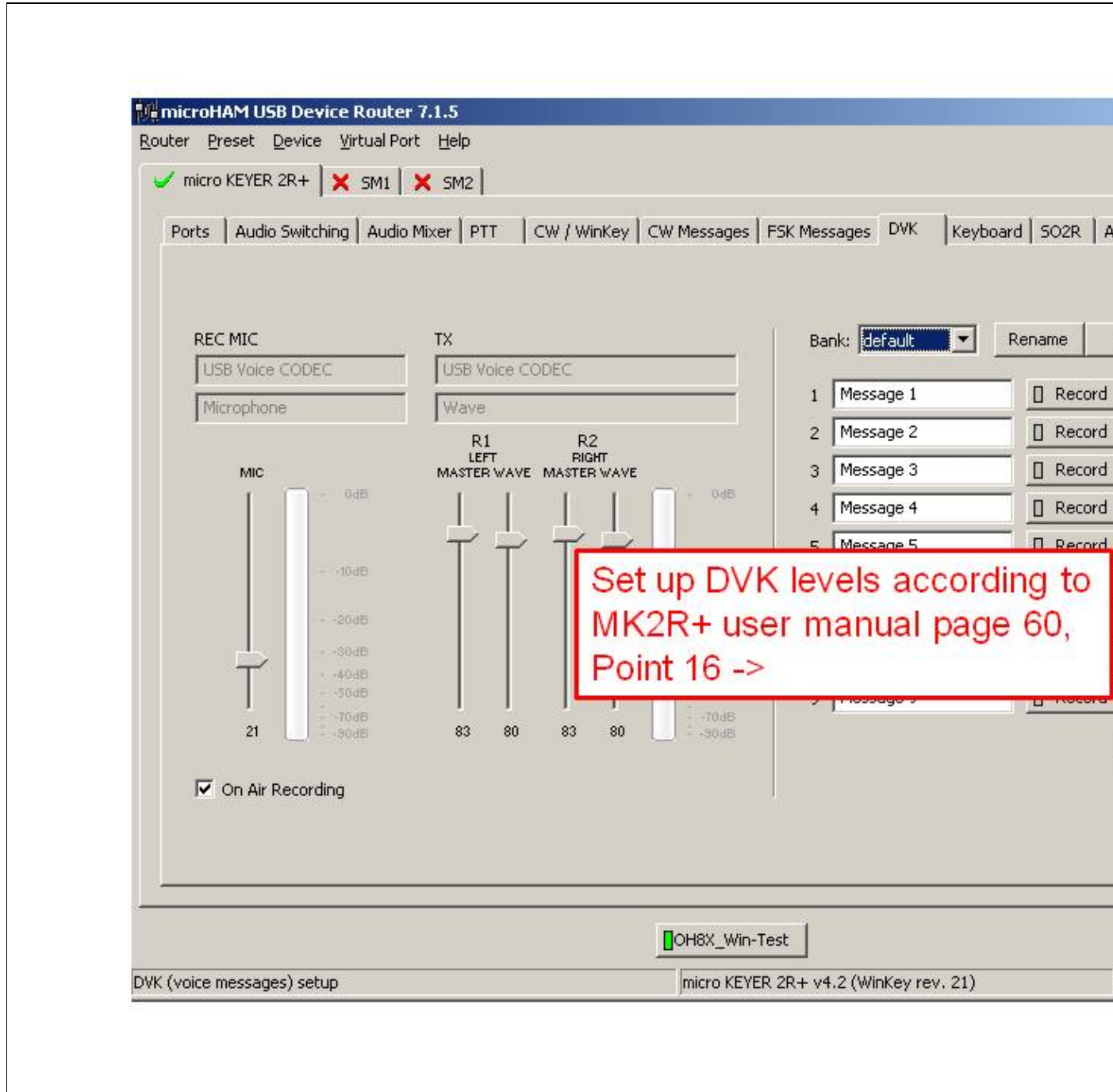



DVK Voice Messages setting  
**Device Router Keyboard setting**

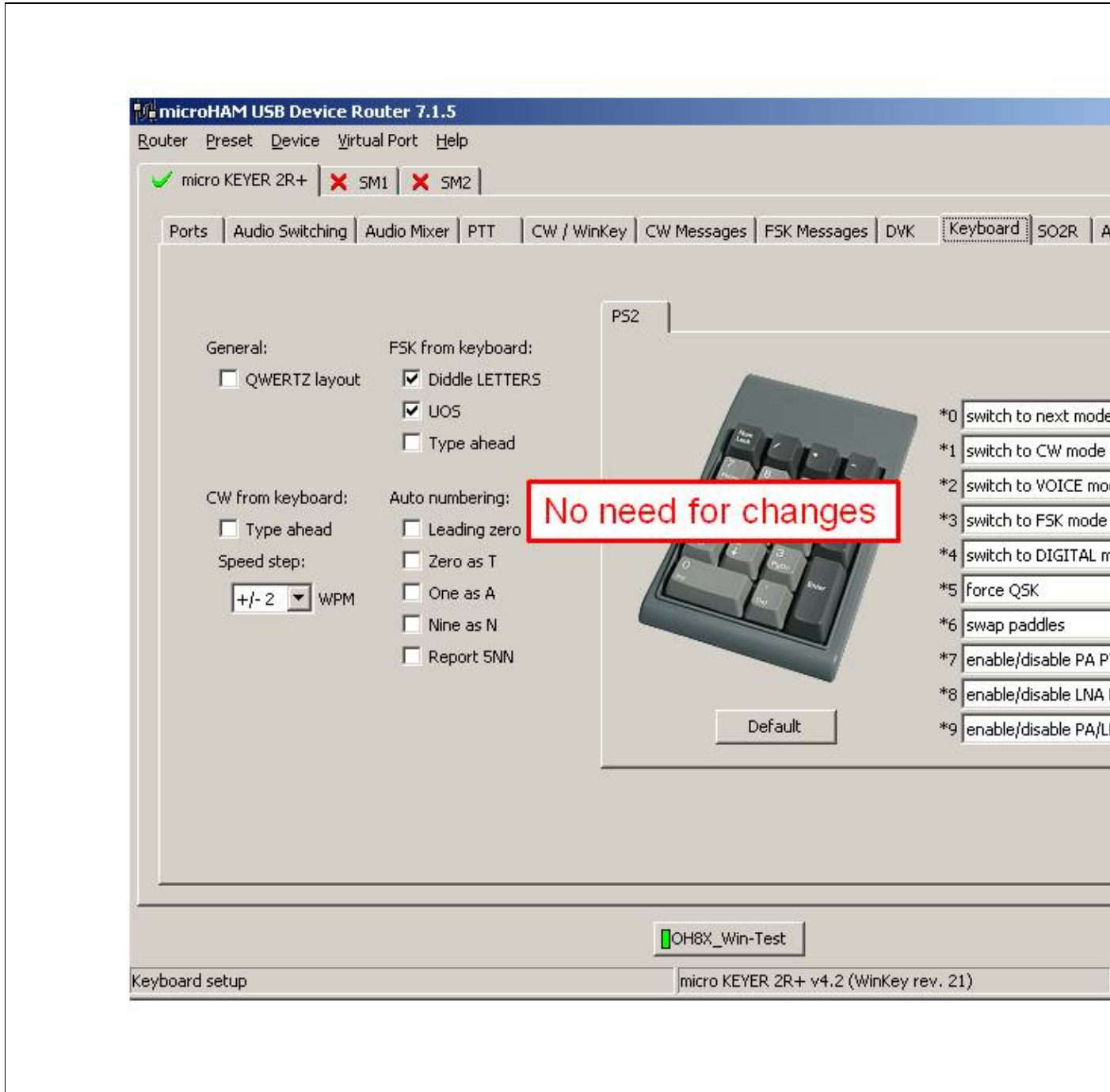

Keyboard setting

**Device Router SO2R Behaviour setting**



SO2R Behaviour setting

**Device Router ACC port setting**

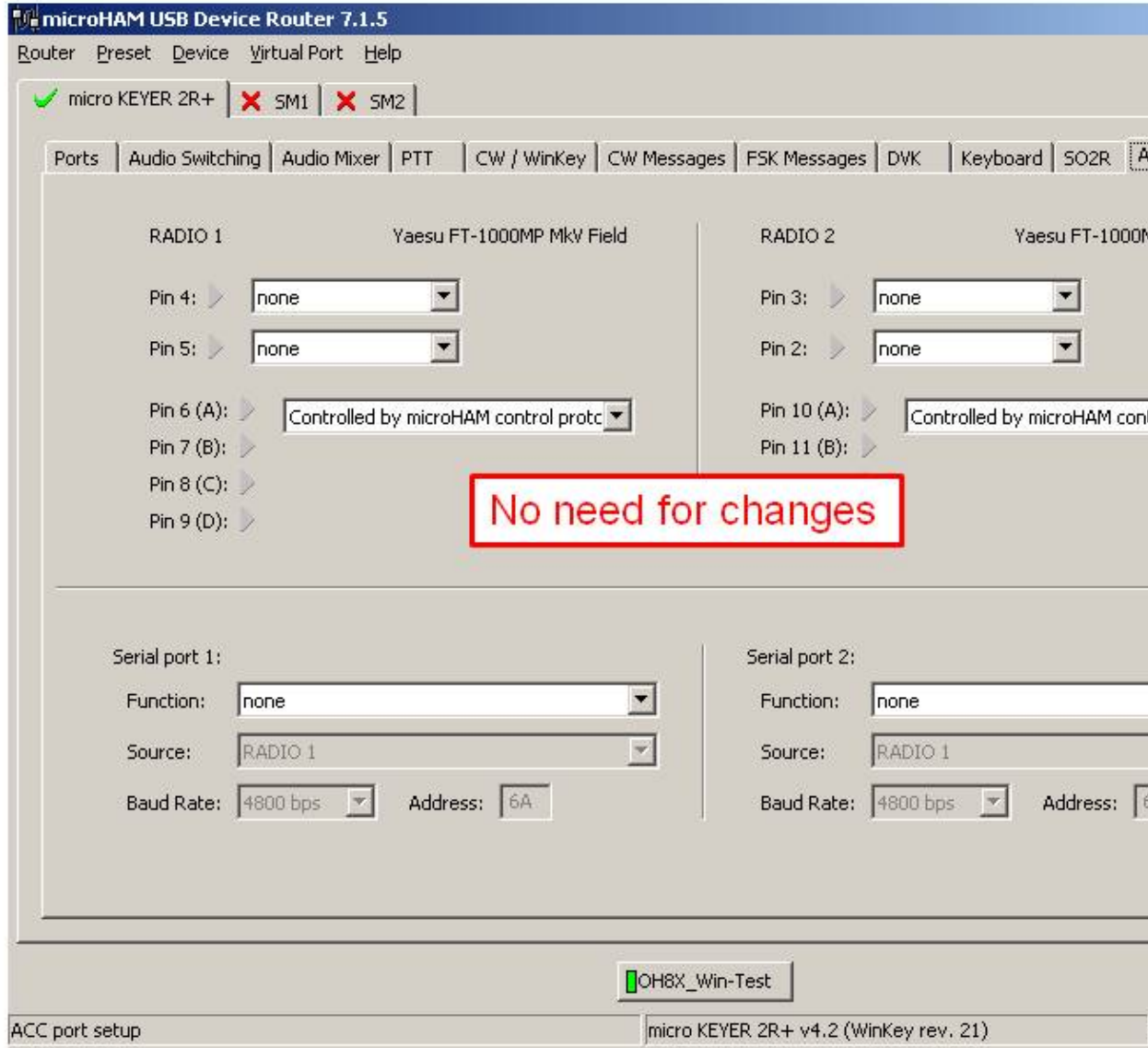

ACC port setting

### Device Router SO2R Audio switching setting

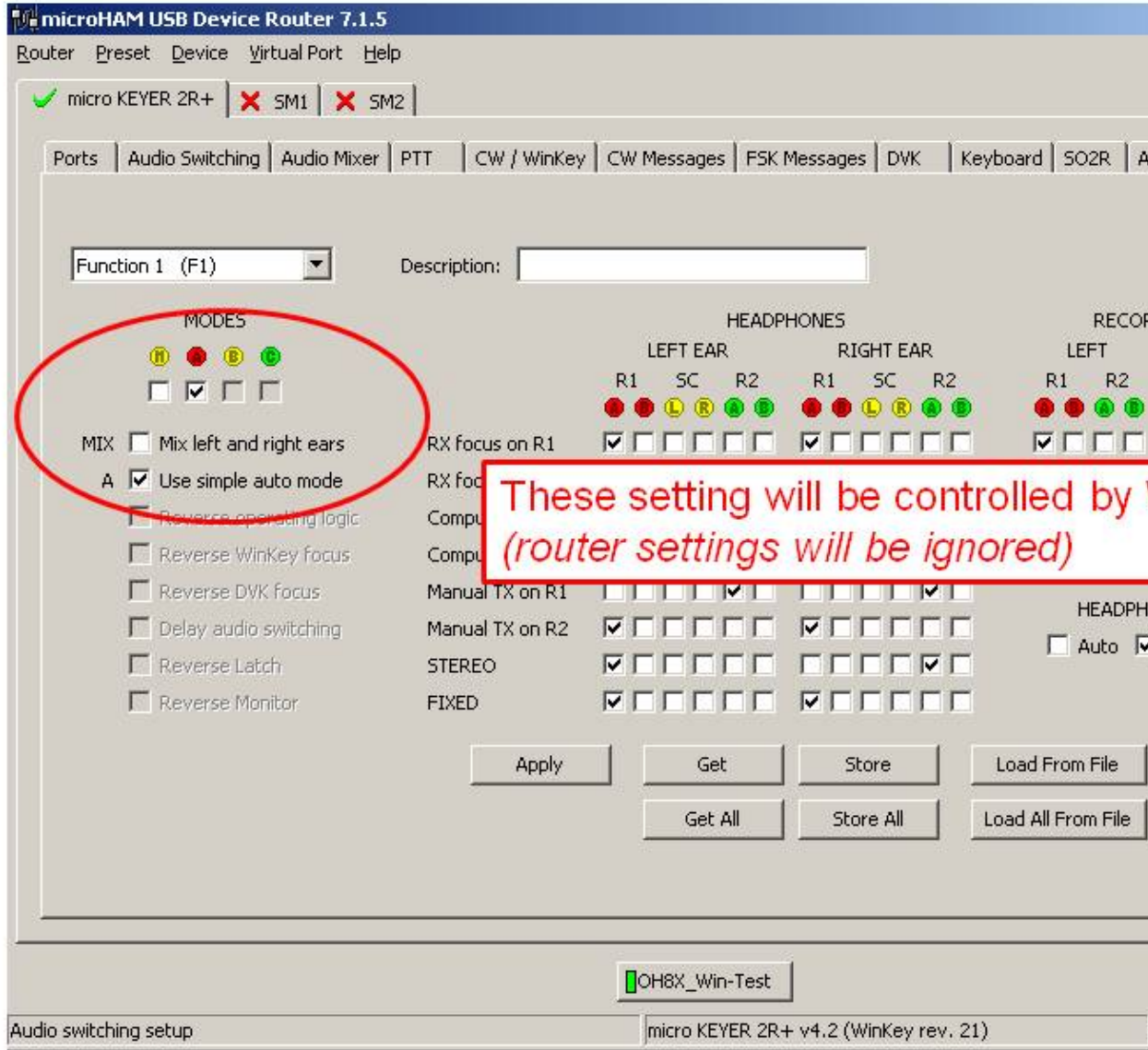

SO2R Audio switching setting

### Device Router **SAVE** your setting

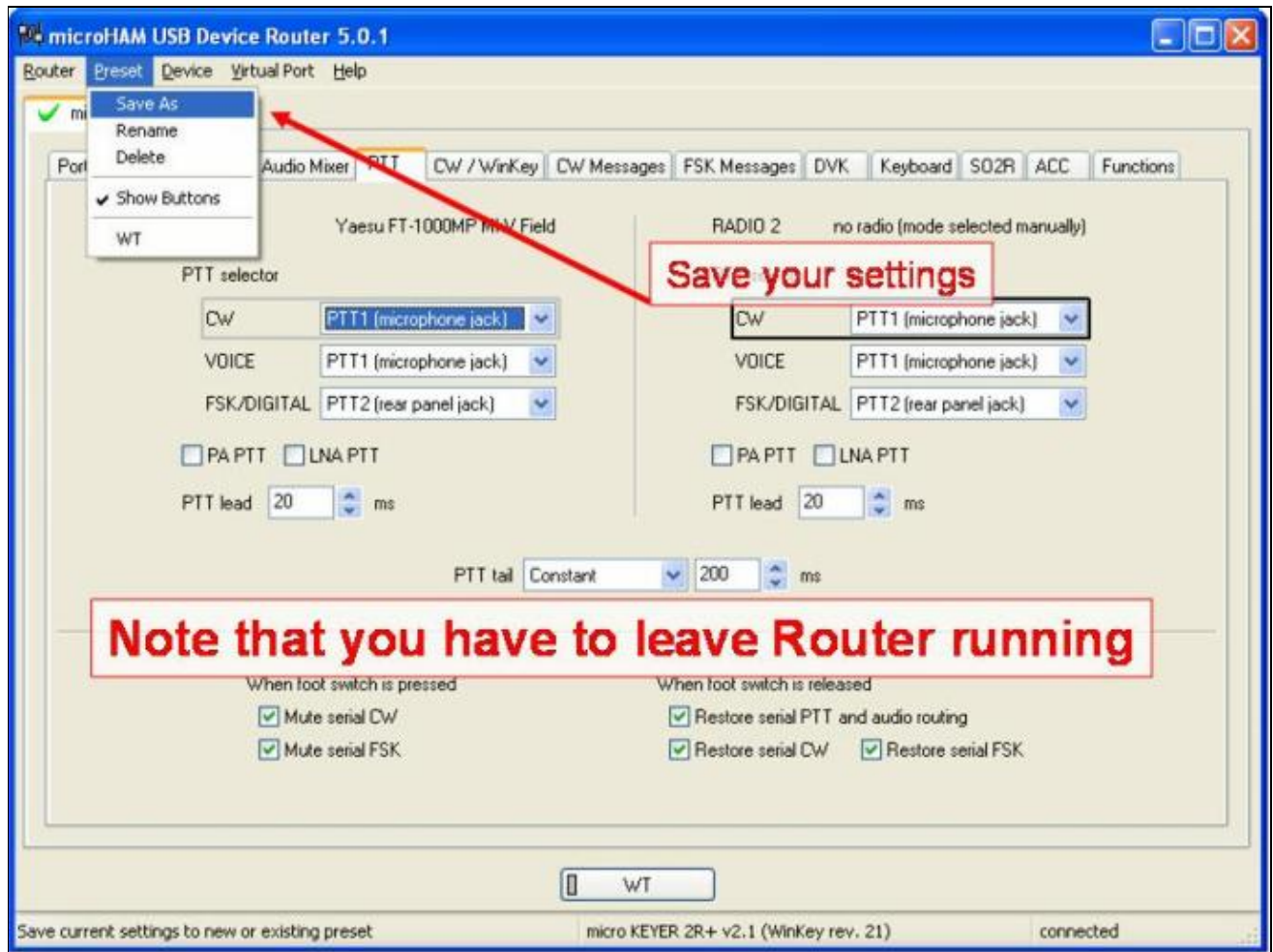

SAVE your setting

**Device Router Overall Device setting view**

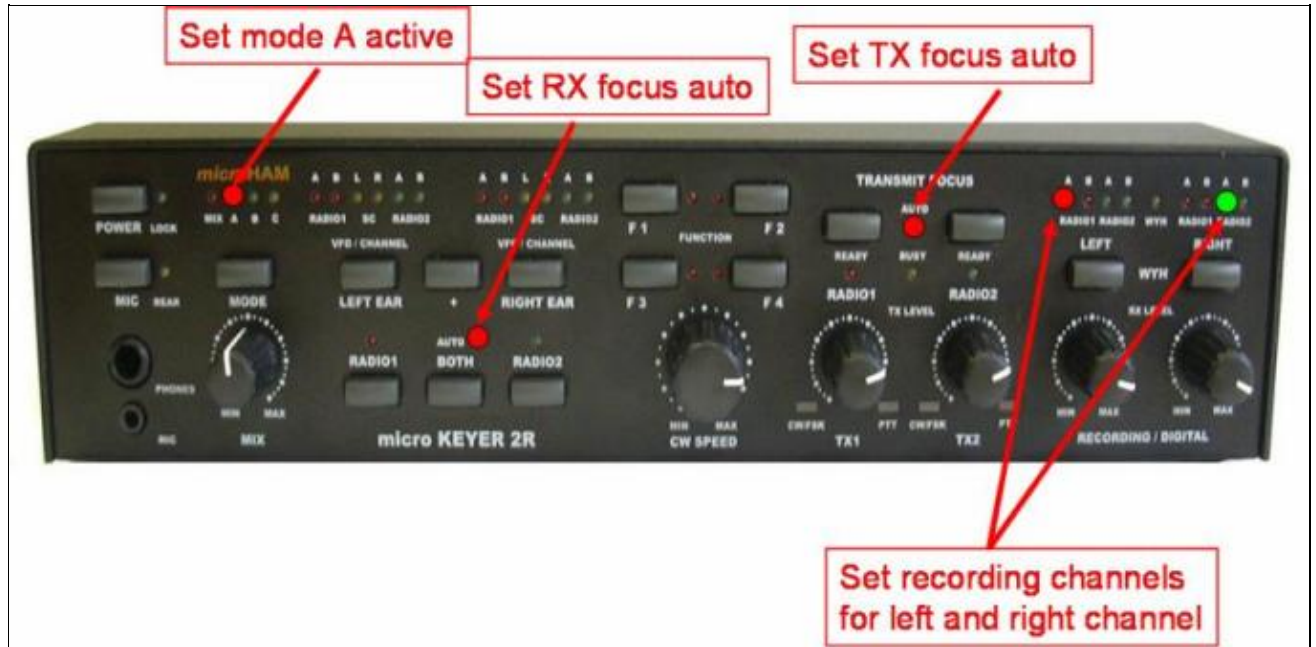

Overall Device setting view

**Device Router set Win-Test Interfaces configuration**

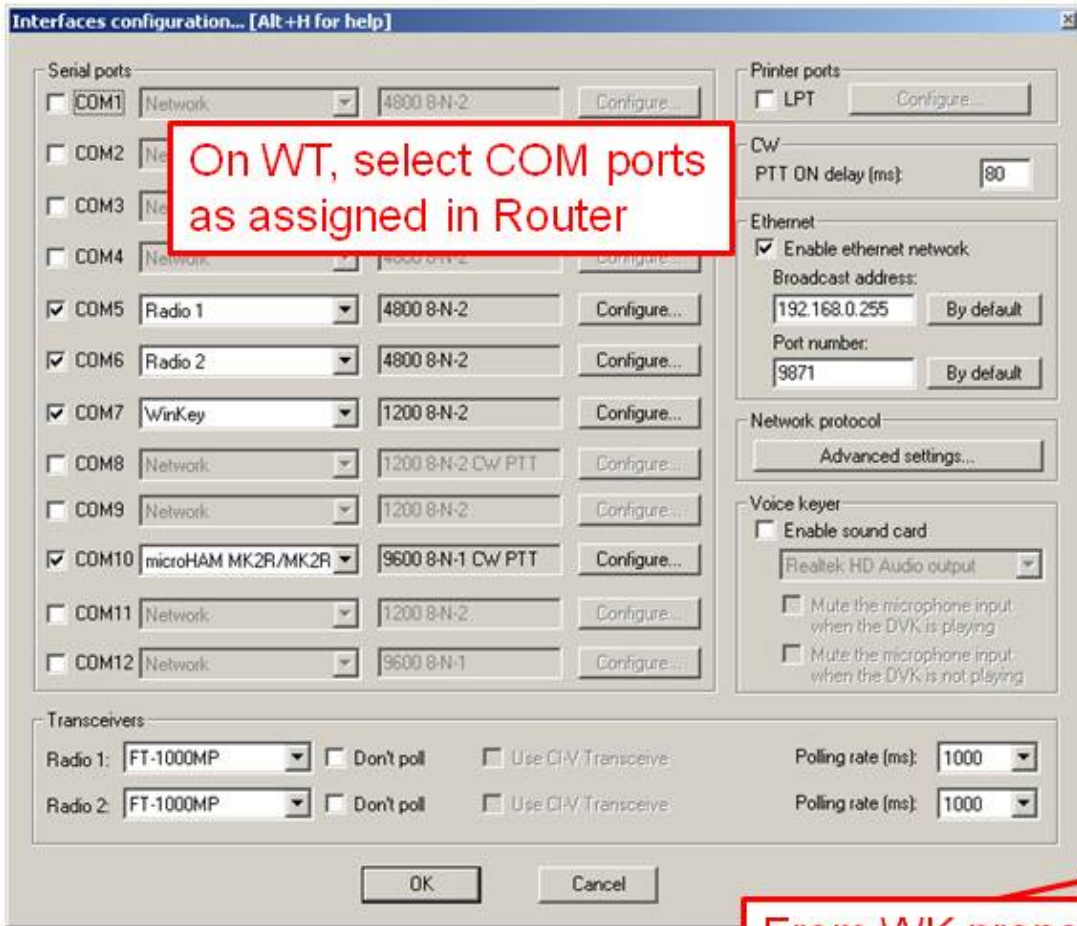

On WT, select COM ports as assigned in Router

From WK properties select indendent speed to keep WT and WK in sync.

Win-Test Interfaces configuration

## See also

### External sources

- [microHAM MK2R/MK2R+ and Win-Test setup guide](#) - PDF document
- [microHAM logger integration page](#)
- [microHAM web site](#)

### Namespaces

- [Page](#)
- [Discussion](#)

### Variants

### Views

- [Read](#)
- [View source](#)
- [View history](#)

### More

- This page was last edited on 12 September 2013, at 14:24.

- [Privacy policy](#)
- [About Win-Test Wiki](#)
- [Disclaimers](#)





# Networking

From Win-Test Wiki

[Jump to navigation](#) [Jump to search](#)

Multi-op networking in Win-Test assumes you know at least a little about the TCP/IP protocol (in particular IP addressing and subnetting). This document outlines what you need to do to configure Win-Test for use across an local network in Win-Test.

## Contents

- [1 Step 1: Configuring your Windows network](#)
- [2 Step 2: Configuring Win-Test for multi-op networking](#)
  - ◆ [2.1 Settings for Win-Test networking on different IP ranges](#)
- [3 Step 3: Testing the network](#)
- [4 Log Synchronization](#)
- [5 Large Networks](#)
  - ◆ [5.1 WT Tunnel](#)
  - ◆ [5.2 Traffic Shaping](#)
  - ◆ [5.3 The Bridgehead Concept](#)
  - ◆ [5.4 Starting at 0 OSOs](#)
- [6 See Also](#)
  - ◆ [6.1 In the manual](#)
  - ◆ [6.2 External sources](#)

## Step 1: Configuring your Windows network

The first step is to configure your Windows network on all machines that you intend to run Win-Test on. You will need to set a fixed IP address on each machine and ensure the subnet mask matches on all machines. For an answer to the question, why DHCP is not recommended see [\[1\]](#).

You can view your networking configuration by visiting Windows' *Control Panel*, and double-clicking on the *Networking* icon. Ensure that the TCP/IP protocol is installed on *all* machines.

For simplicity, it is recommended you use an IP address in the range **192.168.0.x** where 'x' is a number from 1 to 254. A nice idea is to assign addresses systematically, like

```
192.168.0.160 (160m)
192.168.0.80 (80m)
192.168.0.40 (40m)
192.168.0.20 (20m)
192.168.0.15 (15m)
192.168.0.10 (10m)
192.168.0.99 (Spare)
```

or a some similar method to quickly translate an IP address to a station, and vice versa. If one PC is getting lots of packet errors due to RFI problems or hardware problems, it can be quickly identified by the failing IP address [\[2\]](#).

The subnet to match should be **255.255.255.0**. Of course, the IP address should be *different* on each machine (increment 'x' by one for simplicity) but the subnet mask should be the *same* (i.e.

255 . 255 . 255 . 0). This is very important!

A screenshot of what to expect (Windows XP):

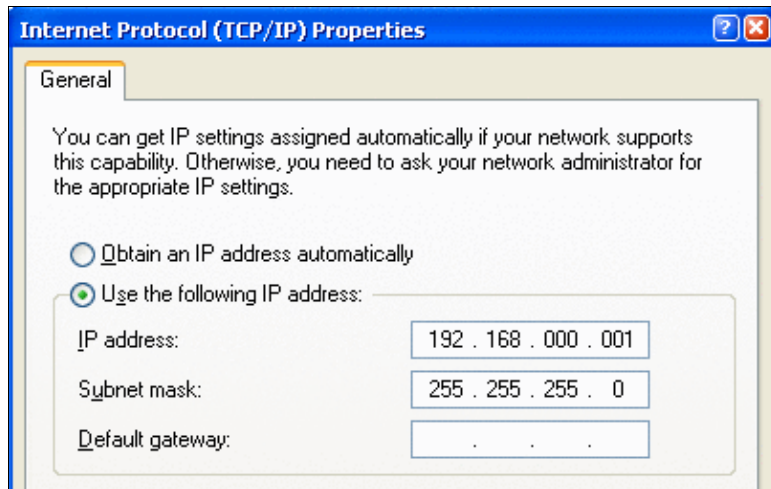

For configuring networking on a **single computer** to connect Win-Test and wtDxTelnet, please see [DX Cluster/Telnet](#).

## Step 2: Configuring Win-Test for multi-op networking

The next step is to configure Win-Test itself to match your network configuration. This is a very easy task, especially if you have chosen to do the wise thing and configure your Windows network as instructed in step 1.

To configure Win-Test, you'll have to open the `Configure Interfaces` dialog box, located under the `Options` menu in Win-Test. You'll see a section on the right-hand side of this window titled '`Local`' and within this section, a checkbox with the text `Enable local network`. Ensure this box is ticked.

If you followed step 1, and configured your Windows network to have addresses in the range `192 . 168 . 0 . x` with the subnet mask `255 . 255 . 255 . 0`, then simply use the details as given in the following image:

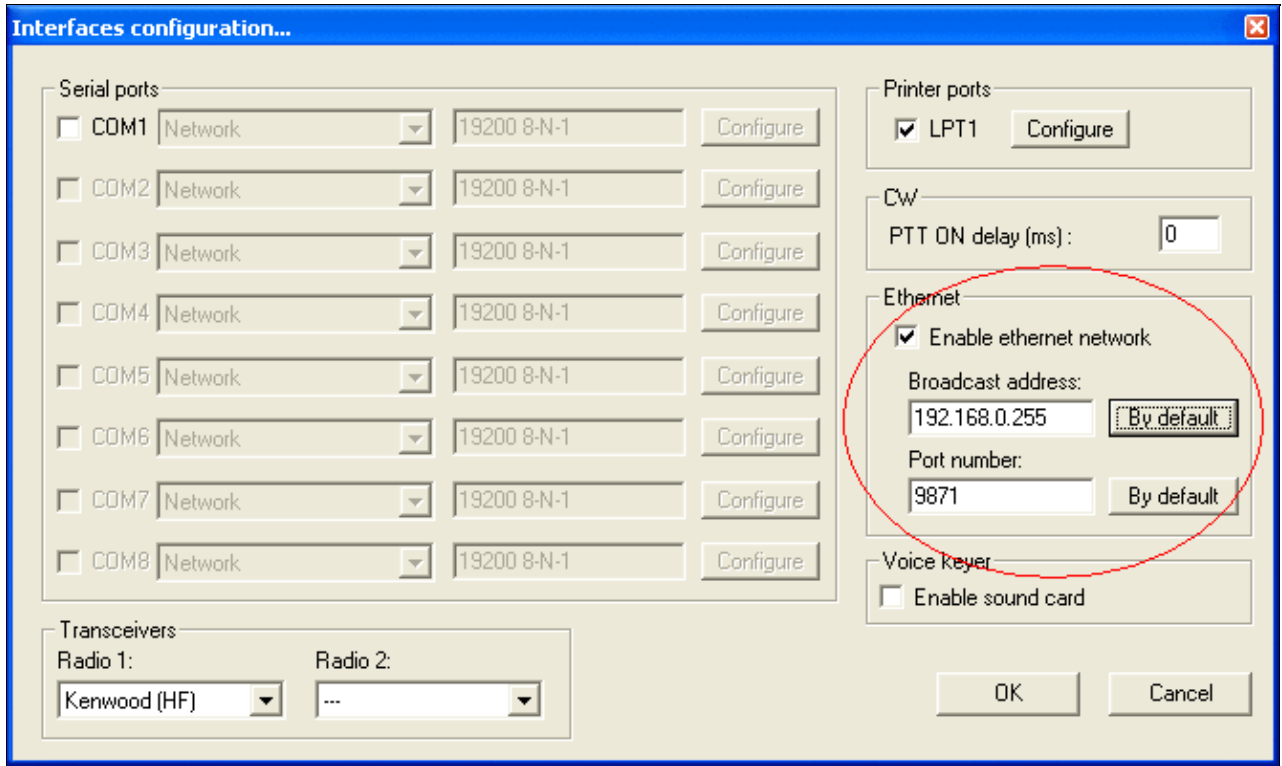

It is recommended you leave the port number as-is (set to 9871).

## Settings for Win-Test networking on different IP ranges

If you have opted to use a different IP range than given in step 1, or if you are unable to control the IP addressing on your network, then here are the settings you require to enter in the networking configuration in Win-Test for other common internal IP addresses:

*Please note: Some numbers rounded to three digits for clarity*

IP address	Subnet	Win-Test configuration
10.000.000.x	255.255.255.000	10.000.000.255
10.000.001.x	255.255.000.000	10.000.255.255
10.001.001.x	255.000.000.000	10.255.255.255
172.16.000.x	255.255.255.000	172.16.000.255
172.16.001.x	255.255.000.000	172.16.255.255

If, for whatever reason, you seem unable to get Win-Test networked using your IP address range/subnet, please send an email to the [Win-Test support mailing list](#).

This has already been said, but it shall be said again: *It is very important that you have matching broadcast addresses and port numbers on **all** the Win-Test machines running on the network.* Failure to do so may result

in partial log data being received by a machine whose broadcast address is incorrectly set - sometimes not always obvious until the contest is underway!

## Step 3: Testing the network

By this stage, you have successfully configured both Windows and Win-Test for a multi-op environment. As a result, you should be able to open a test log (as always, ensuring you choose the same contest across the entire network) and try sending some gab messages to/from each machine. Use the **Alt+G** keyboard shortcut to open the gab window.

You can also enable time distribution across the network to ensure all Win-Test networked machines have times that match. Designate one machine on your network to control the time for the remainder of the network (perhaps you have a standalone machine running Win-Test and wtDxTelnet for monitoring and DX cluster access respectively?) and on this machine, tick the box that says **Enable time distribution across the network** when opening a log. Please refer to the [Menu:File new:Network Parameters](#) chapter for more details.

This is all that needs to be done - no settings have to be changed on the rest of the network.

You will probably now want to configure WtDxTelnet, a stand-alone application included in the Win-Test package for telnet DX cluster access. Follow the link below (under the 'See Also' section).

## Log Synchronization

Log Synchronization has been introduced with Release 3.0.0.

It is based on a peer-to-peer model, where WT opened logs can be synchronized between all stations on a network, on-the-fly and without the need of a central server.

If new stations come in the network, or a station become alive after a reboot, during a contest, their logs are automatically updated, in a full transparent way and, of course, you still can run and enter QSOs while the synchronization process is in progress.

Log synchronization is turned on by default. The menu option [Disable log synchronization on network](#) will let the user turn off synchronization.

Please note that, in some circumstances, log synchronization can be automatically disabled. See note below:

**Note:** When a log is being opened in a networked environment, the date of the first QSO must match the others logs date with 20 days tolerance. If not, a warning will come up and the networking and synchronization will be disabled on this machine. You can override this behaviour if you really know what you're doing!

Please see [Merge Logs](#) and [Multi-op/Issues/Editing serials](#) for more information about log synchronization.

## Large Networks

Large networks, spanning 20, 30 or more computers, probably connected via GRPS, Wireless and broadband links develop their own characteristics. Win-Test allows for several optimizations to keep network traffic at a

reasonable level to avoid congestion, delays and other unwanted effects. The large network often combines a few computers in a LAN with other LANs via a WAN connection.

## WT Tunnel

A specific program available only on special request that allows to establish a wide area Win-Test network via the Internet. This program is run on a central server and all other stations connect to this server via an application called the WT Tunnel.

## Traffic Shaping

Win-Test allows traffic shaping by configuring enabled and disabled protocol types. This allows setting up, for example, a silent backup on the network, or a scenario where two stations only share packet spots on the network, but nothing else.

## The Bridgehead Concept

This feature works with the wtTunnel suite **only**. To respect multi-op ethics, the wtTunnel package is *only* available to headquarter stations during the IARU HF contest.

In a large network it makes little sense for every computer to synchronize with every other computer. The traffic becomes extremely high, latency increases and data loss may occur. This is where the bridgehead concept comes into play.

In every LAN, one designated station serves as a hub, collects all local QSOs and shares them with other bridgehead stations through the WAN. Other bridgehead stations on the WAN distribute the information in their LANs so that in the end, every computer will have the complete log.

Every computer in the LAN, *except the bridgehead computer*, will leave this box *unchecked* in the Network Protocol Advanced Settings dialog

The bridgehead computer *will* check this box, so that it will synchronize with all computers:

[x] This station is a WAN bridgehead

## Starting at 0 QSOs

Before the beginning of a contest like the IARU Radiosport, where many stations are spread out all over the country, or at a multi-op, every log needs to start with 0 QSOs. However, since some operators may have logged a few contacts before the contest, the control station of the network may need to use the **REMOTE** command dialog to remotely delete all of these QSOs from all logs right before the contest starts. See clearing all logs before the start.

## See Also

### In the manual

- Multi-op contesting
- Configuring WtDxTelnet and Win-Test for telnet DX cluster access

## External sources

- [Subnet calculator](#) (web page that help in defining Subnet Masks and Broadcast Addresses)

## Namespaces

- [Page](#)
- [Discussion](#)

## Variants

## Views

- [Read](#)
- [View source](#)
- [View history](#)

## More

- This page was last edited on 24 November 2022, at 11:27.
- [Privacy policy](#)
- [About Win-Test Wiki](#)
- [Disclaimers](#)



# Networking

From Win-Test Wiki

[Jump to navigation](#) [Jump to search](#)

Multi-op networking in Win-Test assumes you know at least a little about the TCP/IP protocol (in particular IP addressing and subnetting). This document outlines what you need to do to configure Win-Test for use across an local network in Win-Test.

## Contents

- [1 Step 1: Configuring your Windows network](#)
- [2 Step 2: Configuring Win-Test for multi-op networking](#)
  - ◆ [2.1 Settings for Win-Test networking on different IP ranges](#)
- [3 Step 3: Testing the network](#)
- [4 Log Synchronization](#)
- [5 Large Networks](#)
  - ◆ [5.1 WT Tunnel](#)
  - ◆ [5.2 Traffic Shaping](#)
  - ◆ [5.3 The Bridgehead Concept](#)
  - ◆ [5.4 Starting at 0 OSOs](#)
- [6 See Also](#)
  - ◆ [6.1 In the manual](#)
  - ◆ [6.2 External sources](#)

## Step 1: Configuring your Windows network

The first step is to configure your Windows network on all machines that you intend to run Win-Test on. You will need to set a fixed IP address on each machine and ensure the subnet mask matches on all machines. For an answer to the question, why DHCP is not recommended see [\[1\]](#).

You can view your networking configuration by visiting Windows' *Control Panel*, and double-clicking on the *Networking* icon. Ensure that the TCP/IP protocol is installed on *all* machines.

For simplicity, it is recommended you use an IP address in the range **192.168.0.x** where 'x' is a number from 1 to 254. A nice idea is to assign addresses systematically, like

```
192.168.0.160 (160m)
192.168.0.80 (80m)
192.168.0.40 (40m)
192.168.0.20 (20m)
192.168.0.15 (15m)
192.168.0.10 (10m)
192.168.0.99 (Spare)
```

or a some similar method to quickly translate an IP address to a station, and vice versa. If one PC is getting lots of packet errors due to RFI problems or hardware problems, it can be quickly identified by the failing IP address [\[2\]](#).

The subnet to match should be **255.255.255.0**. Of course, the IP address should be *different* on each machine (increment 'x' by one for simplicity) but the subnet mask should be the *same* (i.e.

255 . 255 . 255 . 0). This is very important!

A screenshot of what to expect (Windows XP):

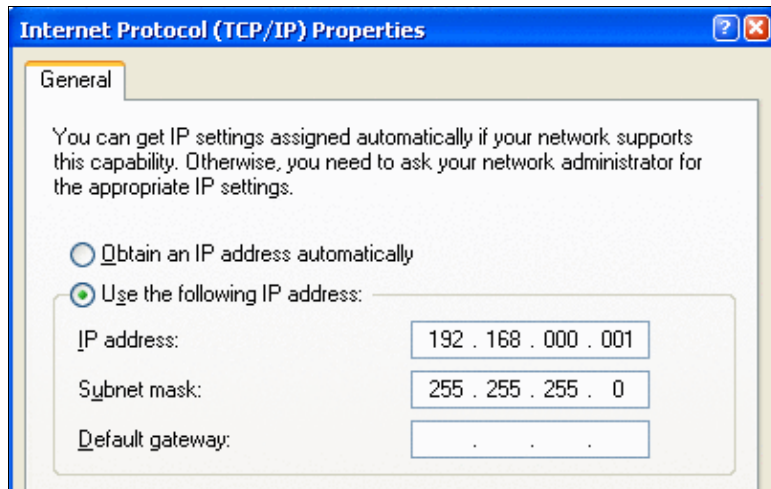

For configuring networking on a **single computer** to connect Win-Test and wtDxTelnet, please see [DX Cluster/Telnet](#).

## Step 2: Configuring Win-Test for multi-op networking

The next step is to configure Win-Test itself to match your network configuration. This is a very easy task, especially if you have chosen to do the wise thing and configure your Windows network as instructed in step 1.

To configure Win-Test, you'll have to open the `Configure Interfaces` dialog box, located under the `Options` menu in Win-Test. You'll see a section on the right-hand side of this window titled '`Local`' and within this section, a checkbox with the text `Enable local network`. Ensure this box is ticked.

If you followed step 1, and configured your Windows network to have addresses in the range `192 . 168 . 0 . x` with the subnet mask `255 . 255 . 255 . 0`, then simply use the details as given in the following image:



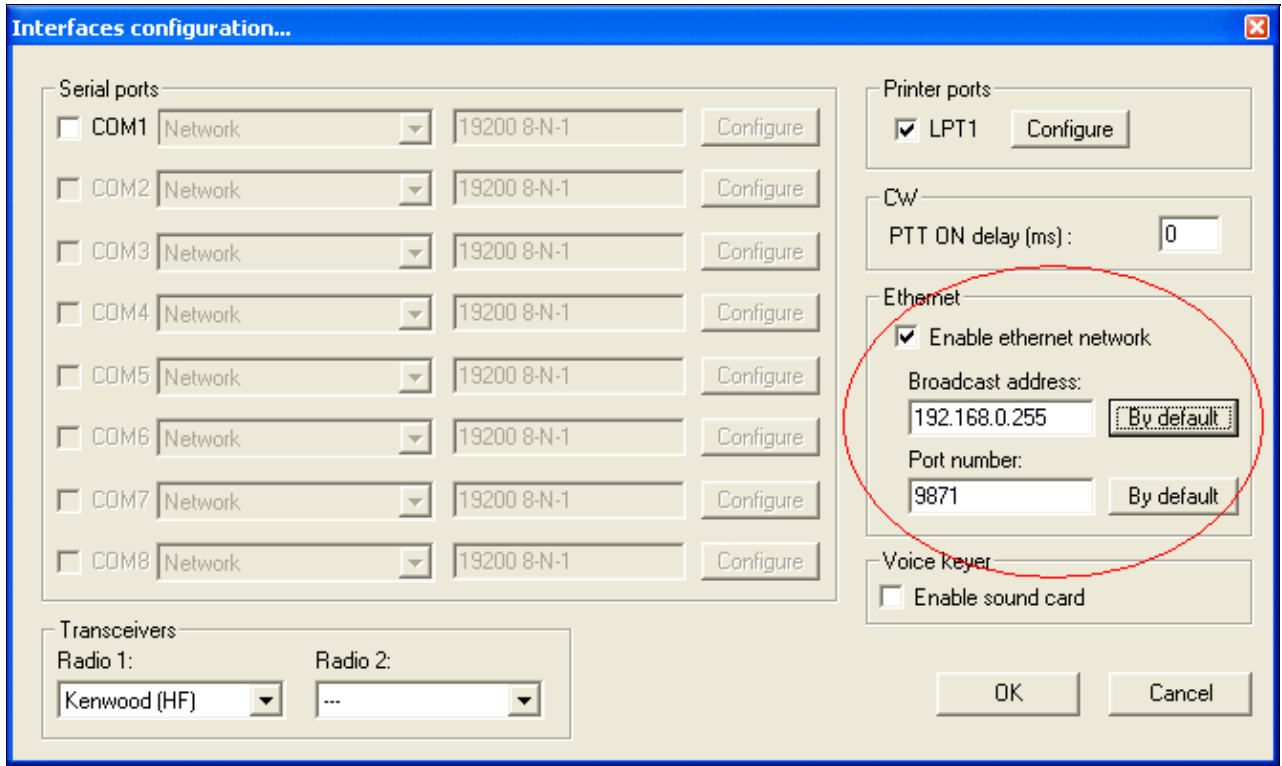

It is recommended you leave the port number as-is (set to 9871).

## Settings for Win-Test networking on different IP ranges

If you have opted to use a different IP range than given in step 1, or if you are unable to control the IP addressing on your network, then here are the settings you require to enter in the networking configuration in Win-Test for other common internal IP addresses:

*Please note: Some numbers rounded to three digits for clarity*

IP address	Subnet	Win-Test configuration
10.000.000.x	255.255.255.000	10.000.000.255
10.000.001.x	255.255.000.000	10.000.255.255
10.001.001.x	255.000.000.000	10.255.255.255
172.16.000.x	255.255.255.000	172.16.000.255
172.16.001.x	255.255.000.000	172.16.255.255

If, for whatever reason, you seem unable to get Win-Test networked using your IP address range/subnet, please send an email to the [Win-Test support mailing list](#).

This has already been said, but it shall be said again: *It is very important that you have matching broadcast addresses and port numbers on **all** the Win-Test machines running on the network.* Failure to do so may result

in partial log data being received by a machine whose broadcast address is incorrectly set - sometimes not always obvious until the contest is underway!

## Step 3: Testing the network

By this stage, you have successfully configured both Windows and Win-Test for a multi-op environment. As a result, you should be able to open a test log (as always, ensuring you choose the same contest across the entire network) and try sending some gab messages to/from each machine. Use the **Alt+G** keyboard shortcut to open the gab window.

You can also enable time distribution across the network to ensure all Win-Test networked machines have times that match. Designate one machine on your network to control the time for the remainder of the network (perhaps you have a standalone machine running Win-Test and wtDxTelnet for monitoring and DX cluster access respectively?) and on this machine, tick the box that says **Enable time distribution across the network** when opening a log. Please refer to the [Menu:File new:Network Parameters](#) chapter for more details.

This is all that needs to be done - no settings have to be changed on the rest of the network.

You will probably now want to configure WtDxTelnet, a stand-alone application included in the Win-Test package for telnet DX cluster access. Follow the link below (under the 'See Also' section).

## Log Synchronization

Log Synchronization has been introduced with Release 3.0.0.

It is based on a peer-to-peer model, where WT opened logs can be synchronized between all stations on a network, on-the-fly and without the need of a central server.

If new stations come in the network, or a station become alive after a reboot, during a contest, their logs are automatically updated, in a full transparent way and, of course, you still can run and enter QSOs while the synchronization process is in progress.

Log synchronization is turned on by default. The menu option [Disable log synchronization on network](#) will let the user turn off synchronization.

Please note that, in some circumstances, log synchronization can be automatically disabled. See note below:

**Note:** When a log is being opened in a networked environment, the date of the first QSO must match the others logs date with 20 days tolerance. If not, a warning will come up and the networking and synchronization will be disabled on this machine. You can override this behaviour if you really know what you're doing!

Please see [Merge Logs](#) and [Multi-op/Issues/Editing serials](#) for more information about log synchronization.

## Large Networks

Large networks, spanning 20, 30 or more computers, probably connected via GRPS, Wireless and broadband links develop their own characteristics. Win-Test allows for several optimizations to keep network traffic at a

reasonable level to avoid congestion, delays and other unwanted effects. The large network often combines a few computers in a LAN with other LANs via a WAN connection.

## WT Tunnel

A specific program available only on special request that allows to establish a wide area Win-Test network via the Internet. This program is run on a central server and all other stations connect to this server via an application called the WT Tunnel.

## Traffic Shaping

Win-Test allows traffic shaping by configuring enabled and disabled protocol types. This allows setting up, for example, a silent backup on the network, or a scenario where two stations only share packet spots on the network, but nothing else.

## The Bridgehead Concept

This feature works with the wtTunnel suite **only**. To respect multi-op ethics, the wtTunnel package is *only* available to headquarter stations during the IARU HF contest.

In a large network it makes little sense for every computer to synchronize with every other computer. The traffic becomes extremely high, latency increases and data loss may occur. This is where the bridgehead concept comes into play.

In every LAN, one designated station serves as a hub, collects all local QSOs and shares them with other bridgehead stations through the WAN. Other bridgehead stations on the WAN distribute the information in their LANs so that in the end, every computer will have the complete log.

Every computer in the LAN, *except the bridgehead computer*, will leave this box *unchecked* in the Network Protocol Advanced Settings dialog

The bridgehead computer *will* check this box, so that it will synchronize with all computers:

[x] This station is a WAN bridgehead

## Starting at 0 QSOs

Before the beginning of a contest like the IARU Radiosport, where many stations are spread out all over the country, or at a multi-op, every log needs to start with 0 QSOs. However, since some operators may have logged a few contacts before the contest, the control station of the network may need to use the **REMOTE** command dialog to remotely delete all of these QSOs from all logs right before the contest starts. See clearing all logs before the start.

## See Also

### In the manual

- Multi-op contesting
- Configuring WtDxTelnet and Win-Test for telnet DX cluster access

## External sources

- [Subnet calculator](#) (web page that help in defining Subnet Masks and Broadcast Addresses)

## Namespaces

- [Page](#)
- [Discussion](#)

## Variants

## Views

- [Read](#)
- [View source](#)
- [View history](#)

## More

- This page was last edited on 24 November 2022, at 11:27.

- [Privacy policy](#)
- [About Win-Test Wiki](#)
- [Disclaimers](#)



# New Log

From Win-Test Wiki

[Jump to navigation](#) [Jump to search](#)

Creating a new log in Win-Test is a two step process. Of course, this only needs to be done once, prior to the contest.

## Contents

- [1 Step 1: Setup your log](#)
  - ◆ [1.1 Editing the contest configuration](#)
- [2 Step 2: Choosing a file name for your log](#)
- [3 Opening your log automatically upon opening Win-Test](#)
- [4 See Also](#)

## Step 1: Setup your log

After starting Win-Test, click on the `File | New...` menu option or click the "New" toolbar icon. For more details, see [Menu:File\\_new](#). The contest configuration screen is shown first:

# Win-Test Wiki

**Contest configuration**

**Station**

Callsign:  Locator:  Exchange (zone, ...):

DXCC Prefix:  WAZ zone:  ITU zone:  State/Province/Other:

Name:

Address:

Address:

Address:

Club:

**Load**

**Save as**

**Contest**

Contest:    This month only

Category:  Mode:

Overlay:  Band plan:

Class:  Power:

Operators:

**Network**

Station:   Enable time distribution across the network

Hopefully this screen will be quite self-explanatory, but here's a brief summary of what the various entry fields indicate. For more details, refer to [Menu:File\\_new#Contest Configuration](#):

- **Callsign** - enter the callsign which you plan to use during the contest
- **Locator** - must be filled with a complete locator (ex: CM97CF). To determine your locator, go to <http://f6fvy.free.fr/qthLocator/fullScreen.php>, find your location on the interactive map, and click on it to display your grid square number. This value is used to calculate beam headings and sunrise/sunset times for your QTH.
- **Exchange (zone, ...)** - If this field is editable, enter a CQ zone for the CQ WW contests, your year of first licence for the EU HF Championship, year of birth for the All Asian contest, your state for the NA Sprint, etc. It may be disabled for contests which require a serial number. If the contest has a Domestic-side and a DX-side where a serial must be sent, enter "DX". Sets the **\$ZONE**, **\$STATE**, or **\$YEAR** [message variables](#) for CW messages, depending on the contest.
- **DXCC Prefix** - your station's standard country prefix, from [cty.dat](#)
- **WAZ zone** - your station's CQ zone number
- **ITU zone** - your station's ITU zone number
- **State/Province/Other** - your station's U.S. state, Canadian province, or "DX".
- **Name** - the name which you want to be inserted into the final Cabrillo/ADIF log file
- **Address** - the address which you want to be inserted into the final Cabrillo/ADIF log file
- **Club** - the name of your radio club, for the Cabrillo log file (do not abbreviate)
- **Load** - click one of these buttons to quickly load address and configuration information saved previously (one of five different configurations may be selected). This avoids retyping everything when you create a new log.
- **Save as** - click one of these buttons to save the current address and configuration information in one of the five preset buttons. You will be prompted to name the button.
- **Contest** - this is a drop-down list from which you choose the contest which you plan to partake in. Check **[This month only]** to shorten this list considerably. If you select DX Expedition, press the **[Days . . .]** button to set the span of the [Statistics Window](#) from 1 to 15 days.
- **Category** - choose the appropriate category which you plan to enter in the contest
- **Mode** - CW, PHONE, MIXED, RTTY, DIGITAL, or All modes?
- **Overlay** - if the particular contest supports a 'contest overlay' (e.g. CQ WPX), choose it from this drop-down list
- **Band plan** - click **[Setup . . .]** to set up frequency ranges, and Win-Test will automatically filter packet spots by frequency, showing only those spots that apply to your selected contest mode. See [Bandplans](#) for more information.
- **Class** - the power class you plan to enter (drop-down list)
- **Op. name** - the operator's name, sets the **\$MYNAME** [message variable](#)
- **Operators** - this operator list will be inserted into the final Cabrillo log file. It must be a space-delimited list of operator callsign(s). You may also list the callsign of the host station by placing an "@" character in front of the callsign within the operator list.
- **Station** - station name, only important in a multi-op environment where each networked computer needs its own unique identifier. Check **[Enable time distribution across the network]** if you want this computer's clock to be the "master clock" for all networked computers.

Click one of the **Save as** buttons to save address and other information. Click **[OK]** to open your newly created log. That's it! This only needs to be done once per contest log.

## Editing the contest configuration

You can make changes in the above contest configuration dialog at any time by re-opening the log file. To do

this, use the **REOPEN** or **OPEN** text command, or go to the File | Open menu option in Win-Test, and choose the appropriate log filename. Click Open and once again you will be greeted with the configuration dialog box. You can make any changes you like here and then click **[OK]**.

## Step 2: Choosing a file name for your log

After selecting the contest type in step 1, you will see a window similar to the one below.

By default, Win-Test will generate a name for the log and place it in a new folder (or "sub-directory") named after the particular contest.

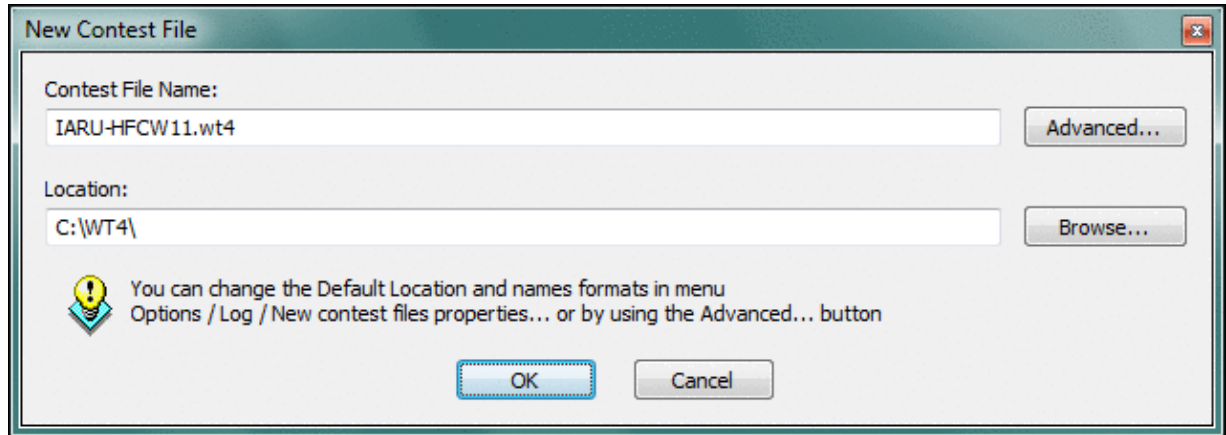

Dialog allowing you to customize the name and location of your log file

## Opening your log automatically upon opening Win-Test

If you wish, you can have Win-Test automatically open the last opened log file upon start-up. This is very convenient during a contest; all you have to do is double-click the Win-Test icon on the desktop and the log file will be opened.

To enable this feature, use the Win-Test menu to select Options | Load contest at startup | Enabled.

Close Win-Test and then restart to verify that it works.

After opening a log automatically, you can easily modify anything entered on the contest configuration screen by typing the text command **REOPEN**.

Note: by pressing and holding the **[Ctrl]** key during Win-Test startup, automatic file loading will be ignored. You may also use the "-n" command line option to achieve the same affect:

```
wt -n
```

## See Also

- [Menu:File\\_new](#)
- [Menu:File\\_new#Open](#)
- [Menu:File\\_new#Export](#)



## Namespaces

- [Page](#)
- [Discussion](#)

## Variants

## Views

- [Read](#)
- [View source](#)
- [View history](#)

## More

- This page was last edited on 16 October 2011, at 23:51.
- [Privacy policy](#)
- [About Win-Test Wiki](#)
- [Disclaimers](#)



# New Log

From Win-Test Wiki

[Jump to navigation](#) [Jump to search](#)

Creating a new log in Win-Test is a two step process. Of course, this only needs to be done once, prior to the contest.

## Contents

- [1 Step 1: Setup your log](#)
  - ◆ [1.1 Editing the contest configuration](#)
- [2 Step 2: Choosing a file name for your log](#)
- [3 Opening your log automatically upon opening Win-Test](#)
- [4 See Also](#)

## Step 1: Setup your log

After starting Win-Test, click on the `File | New...` menu option or click the "New" toolbar icon. For more details, see [Menu:File\\_new](#). The contest configuration screen is shown first:

# Win-Test Wiki

**Contest configuration** ✖

**Station**

Callsign:  Locator:  Exchange (zone, ...):   ?

DXCC Prefix:  WAZ zone:  ITU zone:  State/Province/Other:

Name:

Address:

Address:

Address:

Club:

**Load**

**Save as**

**Contest**

Contest:    This month only

Category:  Mode:

Overlay:  Band plan:

Class:  Power:

Operators:

**Network**

Station:   Enable time distribution across the network

Hopefully this screen will be quite self-explanatory, but here's a brief summary of what the various entry fields indicate. For more details, refer to [Menu:File\\_new#Contest Configuration](#):

- **Callsign** - enter the callsign which you plan to use during the contest
- **Locator** - must be filled with a complete locator (ex: CM97CF). To determine your locator, go to <http://f6fvy.free.fr/qthLocator/fullScreen.php>, find your location on the interactive map, and click on it to display your grid square number. This value is used to calculate beam headings and sunrise/sunset times for your QTH.
- **Exchange (zone, ...)** - If this field is editable, enter a CQ zone for the CQ WW contests, your year of first licence for the EU HF Championship, year of birth for the All Asian contest, your state for the NA Sprint, etc. It may be disabled for contests which require a serial number. If the contest has a Domestic-side and a DX-side where a serial must be sent, enter "DX". Sets the **\$ZONE**, **\$STATE**, or **\$YEAR** [message variables](#) for CW messages, depending on the contest.
- **DXCC Prefix** - your station's standard country prefix, from [\\_cty.dat](#)
- **WAZ zone** - your station's CQ zone number
- **ITU zone** - your station's ITU zone number
- **State/Province/Other** - your station's U.S. state, Canadian province, or "DX".
- **Name** - the name which you want to be inserted into the final Cabrillo/ADIF log file
- **Address** - the address which you want to be inserted into the final Cabrillo/ADIF log file
- **Club** - the name of your radio club, for the Cabrillo log file (do not abbreviate)
- **Load** - click one of these buttons to quickly load address and configuration information saved previously (one of five different configurations may be selected). This avoids retyping everything when you create a new log.
- **Save as** - click one of these buttons to save the current address and configuration information in one of the five preset buttons. You will be prompted to name the button.
- **Contest** - this is a drop-down list from which you choose the contest which you plan to partake in. Check **[This month only]** to shorten this list considerably. If you select DX Expedition, press the **[Days . . .]** button to set the span of the [Statistics Window](#) from 1 to 15 days.
- **Category** - choose the appropriate category which you plan to enter in the contest
- **Mode** - CW, PHONE, MIXED, RTTY, DIGITAL, or All modes?
- **Overlay** - if the particular contest supports a 'contest overlay' (e.g. CQ WPX), choose it from this drop-down list
- **Band plan** - click **[Setup . . .]** to set up frequency ranges, and Win-Test will automatically filter packet spots by frequency, showing only those spots that apply to your selected contest mode. See [Bandplans](#) for more information.
- **Class** - the power class you plan to enter (drop-down list)
- **Op. name** - the operator's name, sets the **\$MYNAME** [message variable](#)
- **Operators** - this operator list will be inserted into the final Cabrillo log file. It must be a space-delimited list of operator callsign(s). You may also list the callsign of the host station by placing an "@" character in front of the callsign within the operator list.
- **Station** - station name, only important in a multi-op environment where each networked computer needs its own unique identifier. Check **[Enable time distribution across the network]** if you want this computer's clock to be the "master clock" for all networked computers.

Click one of the **Save as** buttons to save address and other information. Click **[OK]** to open your newly created log. That's it! This only needs to be done once per contest log.

## Editing the contest configuration

You can make changes in the above contest configuration dialog at any time by re-opening the log file. To do

this, use the **REOPEN** or **OPEN** [text command](#), or go to the File | Open menu option in Win-Test, and choose the appropriate log filename. Click Open and once again you will be greeted with the configuration dialog box. You can make any changes you like here and then click **[OK]**.

## Step 2: Choosing a file name for your log

After selecting the contest type in step 1, you will see a window similar to the one below.

By default, Win-Test will generate a name for the log and place it in a new folder (or "sub-directory") named after the particular contest.

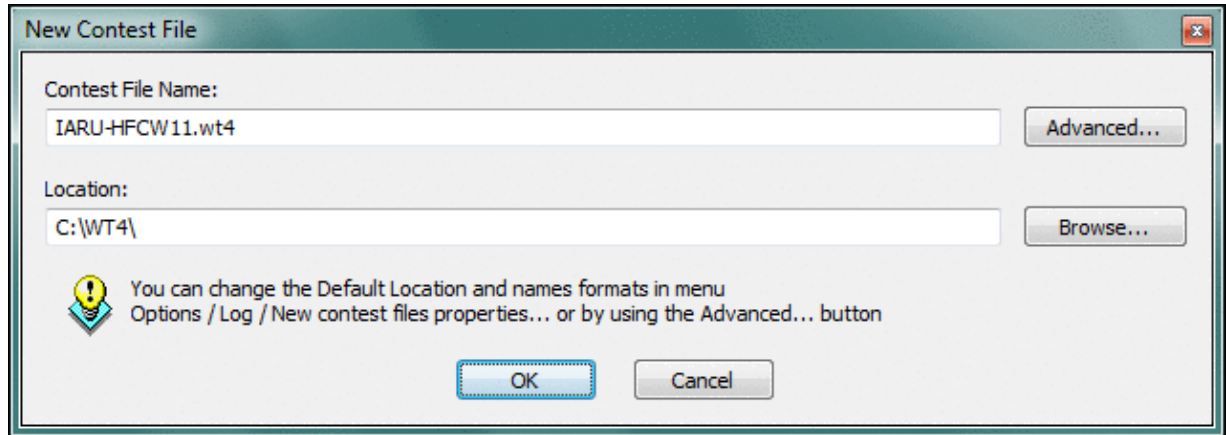

Dialog allowing you to customize the name and location of your log file

## Opening your log automatically upon opening Win-Test

If you wish, you can have Win-Test automatically open the last opened log file upon start-up. This is very convenient during a contest; all you have to do is double-click the Win-Test icon on the desktop and the log file will be opened.

To enable this feature, use the Win-Test menu to select Options | Load contest at startup | Enabled.

Close Win-Test and then restart to verify that it works.

After opening a log automatically, you can easily modify anything entered on the contest configuration screen by typing the [text command](#) **REOPEN**.

Note: by pressing and holding the **[Ctrl]** key during Win-Test startup, automatic file loading will be ignored. You may also use the "-n" command line option to achieve the same affect:

```
wt -n
```

## See Also

- [Menu:File\\_new](#)
- [Menu:File\\_new#Open](#)
- [Menu:File\\_new#Export](#)

## Namespaces

- [Page](#)
- [Discussion](#)

## Variants

## Views

- [Read](#)
- [View source](#)
- [View history](#)

## More

- This page was last edited on 16 October 2011, at 23:51.

- [Privacy policy](#)
- [About Win-Test Wiki](#)
- [Disclaimers](#)



# Multi-op/Issues/Non Multipliers

From Win-Test Wiki

[Jump to navigation](#) [Jump to search](#)

## Non Multipliers

Sometimes the multiplier station makes a QSO which turns out not to be a multiplier. This could have been an oversight by the operator, or the logs were not in sync, or the new RUN station operator forgot to change its status. This violation is indicated by WT showing four exclamation marks (!!!!) in the QSO entry line, like this:

QSO	Bd	Time	Callsign	Sent	NÂ°	Rcvd	Mult	Pts	Stn
1	15	11:23	DF2RG	599	001	599001	DF2	1	R
2	15	11:24	DK2OY	599	002	599001	DK2	1	R
3	15	11:25	DF3CB	599	003	599001	DF3	1	R
4	20	11:26	DF2PY	599	001	599009	!!!!	1	M
5	15		—	599	004	599		0	R

Problem: if you leave the QSO in your log, you will probably be penalized. If you delete the QSO from your log, DF2PY will be penalized without him having made any mistake.

So, how to get out of this dilemma?

- make 20 meters the new RUN band immediately, change the status of that QSO to RUN and go!
- work DF2PY again on the same band and mode later and delete the first QSO (by replacing his callsign by yours)
- leave it to the contest administrators; you may probably lose some QSOs because of violating the 10 minute rule (if there is any)

Note that can also occurs if your station/computer is supposed to toggle between RUN to MULT status in a Multi-op effort. If you were a MULT station, and start a new run without inadvertently changing your status to RUN, this tag will remind you to do so! You can also use **Alt-Y** (or **Ctrl-F3**) to toggle the RUN/MULT status of a previous QSO.

## Namespaces

- [Page](#)
- [Discussion](#)

## Variants

## Views

- [Read](#)
- [View source](#)
- [View history](#)

## More

- This page was last edited on 9 March 2007, at 13:29.

- [Privacy policy](#)
- [About Win-Test Wiki](#)
- [Disclaimers](#)





# Multi-op/Issues/Non Multipliers

From Win-Test Wiki

[Jump to navigation](#) [Jump to search](#)

## Non Multipliers

Sometimes the multiplier station makes a QSO which turns out not to be a multiplier. This could have been an oversight by the operator, or the logs were not in sync, or the new RUN station operator forgot to change its status. This violation is indicated by WT showing four exclamation marks (!!!!) in the QSO entry line, like this:

QSO	Bd	Time	Callsign	Sent	NÂ°	Rcvd	Mult	PtsStn
1	15	11:23	DF2RG	599	001	599001	DF2	1 R
2	15	11:24	DK2OY	599	002	599001	DK2	1 R
3	15	11:25	DF3CB	599	003	599001	DF3	1 R
4	20	11:26	DF2PY	599	001	599009	!!!!	1 M
5	15		—	599	004	599		0 R

Problem: if you leave the QSO in your log, you will probably be penalized. If you delete the QSO from your log, DF2PY will be penalized without him having made any mistake.

So, how to get out of this dilemma?

- make 20 meters the new RUN band immediately, change the status of that QSO to RUN and go!
- work DF2PY again on the same band and mode later and delete the first QSO (by replacing his callsign by yours)
- leave it to the contest administrators; you may probably lose some QSOs because of violating the 10 minute rule (if there is any)

Note that can also occurs if your station/computer is supposed to toggle between RUN to MULT status in a Multi-op effort. If you were a MULT station, and start a new run without inadvertently changing your status to RUN, this tag will remind you to do so! You can also use **Alt-Y** (or **Ctrl-F3**) to toggle the RUN/MULT status of a previous QSO.

## Namespaces

- [Page](#)
- [Discussion](#)

## Variants

## Views

- [Read](#)
- [View source](#)
- [View history](#)

## More

- This page was last edited on 9 March 2007, at 13:29.

- [Privacy policy](#)
- [About Win-Test Wiki](#)
- [Disclaimers](#)



# Other Files

From Win-Test Wiki

[Jump to navigation](#) [Jump to search](#)

Other files in the Win-Test directory:

- **wt.ini**: Win-Test's initialization file. It contains information saved from the previous Win-Test session, including file name, callsign, grid locator, address, window positions and color settings. DO NOT MODIFY - unless you know what you are doing! Starting wt.exe with the **-i** or **--alternative-ini** parameter allows you to select a specific .INI file. This way you can create templates for different situations, and use different desktop icons to select them. For more information, see [WT.INI](#).
- **cty.dat**: DXCC countries file. Updated by AD1C. The latest version is available at <http://www.country-files.com>. Since November 16, 2007, Jim also took over maintaining these Win-Test specific files:
  - ◆ **cty\_wt.dat**: Extended DXCC countries file. It contains CQ and ITU zones for VE and VK prefixes and for most of the Russian call areas. The latest version is included in AD1C's file set.
  - ◆ **cty\_wt\_mod.dat**: Extended and detailed DXCC countries file. Initiated by F5IN based on the **cty\_wt.dat** file. It contains CQ and ITU zones for former US prefixes, Lat. and Long. coordinates and time offset for many country exceptions. The latest version is included in AD1C's file set.
- **cty\_cmw.dat**: Commonwealth countries file (used in the RSGB Commonwealth contest).
- **cty\_cqm.dat**: R-100 countries file (used in the CQ M contest).
- **cty\_eec.dat**: European Economic Community countries file (used in the UBA contest).
- **cty\_obl.dat**: Russian oblasts decoding file. It also contains Ukrainian oblasts (used in RDXC). The latest version is available at <http://download.win-test.com/files/country/>.
- **mode.dat**: Allocation of CW, SSB, RTTY sections inside amateur bands. Used by Win-Test to gather the mode of the incoming DX spots by frequency. It may be necessary to adapt this file to your needs especially on 40m CW. **Note**: The use of this file is deprecated since the band plans feature has been introduced (v. 3.2.0).
- **gridsquare\_map.bmp** and **map.dta**: Files used by Win-Test to draw the gridsquares and world maps. You cannot edit them.
- **(\* .dat)**: Regional multiplier and equivalence files. Depending on the contest, they allow Win-Test to accept alternate abbreviations for ARRL Sections, Canadian Provinces, U.S. States, U.S. Counties, Russian Oblasts, etc. The latest equivalence files may be downloaded from <http://download.win-test.com/files/equivalence/>
  - ◆ **ariprov.dat**: Italian provinces (ARI Contest)
  - ◆ **arrlsec.dat**: ARRL/RAC sections (ARRL Sweepstakes and ARRL Field Day)
  - ◆ **naqp.dat**: U.S. States and Canadian Provinces (North American QSO Party)
  - ◆ **na\_sprint.dat**: U.S. States and Canadian Provinces (North American Sprint and NCCC Sprint)
  - ◆ **oblasts.dat**: Russian Oblasts (Russian DX contest)
  - ◆ **states.dat**: U.S. States (ARRL 10m, ARRL DX (DX side), and CQWW 160m contests)
  - ◆ **veprov.dat**: Canadian Provinces (RAC Canada Day and Canada Winter contests)
- **callsign.pat**: Located in the extras directory, this file contains syntactic rules for callsigns

## Namespaces

- [Page](#)
- [Discussion](#)

## Variants

## Views

- [Read](#)
- [View source](#)
- [View history](#)

## More

- This page was last edited on 10 December 2016, at 00:34.
- [Privacy policy](#)
- [About Win-Test Wiki](#)
- [Disclaimers](#)



# Other Files

From Win-Test Wiki

[Jump to navigation](#) [Jump to search](#)

Other files in the Win-Test directory:

- **wt.ini**: Win-Test's initialization file. It contains information saved from the previous Win-Test session, including file name, callsign, grid locator, address, window positions and color settings. DO NOT MODIFY - unless you know what you are doing! Starting wt.exe with the **-i** or **--alternative-ini** parameter allows you to select a specific .INI file. This way you can create templates for different situations, and use different desktop icons to select them. For more information, see [WT.INI](#).
- **cty.dat**: DXCC countries file. Updated by AD1C. The latest version is available at <http://www.country-files.com>. Since November 16, 2007, Jim also took over maintaining these Win-Test specific files:
  - ◆ **cty\_wt.dat**: Extended DXCC countries file. It contains CQ and ITU zones for VE and VK prefixes and for most of the Russian call areas. The latest version is included in AD1C's file set.
  - ◆ **cty\_wt\_mod.dat**: Extended and detailed DXCC countries file. Initiated by F5IN based on the **cty\_wt.dat** file. It contains CQ and ITU zones for former US prefixes, Lat. and Long. coordinates and time offset for many country exceptions. The latest version is included in AD1C's file set.
- **cty\_cmw.dat**: Commonwealth countries file (used in the RSGB Commonwealth contest).
- **cty\_cqm.dat**: R-100 countries file (used in the CQ M contest).
- **cty\_eec.dat**: European Economic Community countries file (used in the UBA contest).
- **cty\_obl.dat**: Russian oblasts decoding file. It also contains Ukrainian oblasts (used in RDXC). The latest version is available at <http://download.win-test.com/files/country/>.
- **mode.dat**: Allocation of CW, SSB, RTTY sections inside amateur bands. Used by Win-Test to gather the mode of the incoming DX spots by frequency. It may be necessary to adapt this file to your needs especially on 40m CW. **Note**: The use of this file is deprecated since the band plans feature has been introduced (v. 3.2.0).
- **gridsquare\_map.bmp** and **map.dta**: Files used by Win-Test to draw the gridsquares and world maps. You cannot edit them.
- **(\* .dat)**: Regional multiplier and equivalence files. Depending on the contest, they allow Win-Test to accept alternate abbreviations for ARRL Sections, Canadian Provinces, U.S. States, U.S. Counties, Russian Oblasts, etc. The latest equivalence files may be downloaded from <http://download.win-test.com/files/equivalence/>
  - ◆ **ariprov.dat**: Italian provinces (ARI Contest)
  - ◆ **arrlsec.dat**: ARRL/RAC sections (ARRL Sweepstakes and ARRL Field Day)
  - ◆ **naqp.dat**: U.S. States and Canadian Provinces (North American QSO Party)
  - ◆ **na\_sprint.dat**: U.S. States and Canadian Provinces (North American Sprint and NCCC Sprint)
  - ◆ **oblasts.dat**: Russian Oblasts (Russian DX contest)
  - ◆ **states.dat**: U.S. States (ARRL 10m, ARRL DX (DX side), and CQWW 160m contests)
  - ◆ **veprov.dat**: Canadian Provinces (RAC Canada Day and Canada Winter contests)
- **callsign.pat**: Located in the extras directory, this file contains syntactic rules for callsigns

## Namespaces

- [Page](#)
- [Discussion](#)

## Variants

## Views

- [Read](#)
- [View source](#)
- [View history](#)

## More

- This page was last edited on 10 December 2016, at 00:34.

- [Privacy policy](#)
- [About Win-Test Wiki](#)
- [Disclaimers](#)



# DX Cluster/Packet

From Win-Test Wiki

< [DX Cluster](#)

[Jump to navigation](#) [Jump to search](#)

## Contents

- [1 TNC pre-test](#)
  - ◆ [1.1 TheFirmware or WA8DED](#)
  - ◆ [1.2 TAPR](#)
- [2 Win-Test TNC set-up](#)
- [3 Testing the Setup](#)
- [4 Connecting node](#)
- [5 Disconnecting node](#)
- [6 See also](#)

## TNC pre-test

Before you can use a TNC with Win-Test, it should first be tested with a simple terminal program like Hyperterm provided with Windows. Do not try to get started with PAXON or other elusive software!

There are two types of TNC firmware:

- the WA8DED flavor (often also called: The Firmware, TF)
- the TAPR flavor

Both types allow switching the TNC into KISS mode, which is - however - not useful for our application.

When you turn the TNC on, the startup message will tell you what kind of software you have.

## TheFirmware or WA8DED

The following messages are displayed on a Symek TNC2H using TF mode:

```
TheFirmware Version 2.7 DAMA/SMACK/XHOST (2553 Bytes * 10 Channel)
  Copyright by NORD<<LINK, 14-Sep-94
    Free for non-commercial usage

Checksum (CBCB) = CBCB
```

In TF mode, commands are sent to the TNC using **[Escape]** followed by a command character. **[Escape] I** for example will allow you to set the outgoing callsign and to connect to a station, use **[Escape] C**. Here is a sample session. When pressing the Escape key, the TNC displays an asterisk followed by a blank character.

```
* idl6rai
* i
* DL6RAI *
* s1
```

## Win-Test Wiki

```
* CHANNEL NOT CONNECTED *
* cdb0pv

* (1) CONNECTED to DB0PV *^G
RMNC/FlexNet V3.3h - DB0PV/Muenchen - JN58SD - RU682 9600Bd FSK (G3RUH)
=>c db0clx

*** connected to DB0CLX
Hallo Ben, hier ist db0clx mit Clx5.04.
Cluster: 5 Links, 10 Nodes, 7 lokale Benutzer, max: 27.
Letzter Start: 23-Jul-2006 0058Z - Laufzeit: 65.20:35:15

dl6rai de db0clx 26-Sep-2006 2133Z clx >
q
73's Ben de db0clx

*** reconnected to DB0PV
=>q

73!
* (1) DISCONNECTED fm DB0PV *^G
```

## TAPR

TNCs in the TAPR mode, usually come up this way, or similar. The main characteristic for TAPR is the **cmd:** prompt. By the way, most TAPR TNCs use 7E1 (7 data bits - Even parity - 1 stop bit) COM port settings at 9600 baud, which is different from the typical 8N1 (8 data bits - No parity - 1 stop bit) settings.

```
SYMEK GmbH DK9SJ TNC2 EPROM
TAPR AX.25 Level 2 Vers 2.0
Release 1.1.8 30-08-92 32k
Checksum $67
cmd:
```

At the **cmd:** prompt you are able to enter commands. Let's do a simple session in TAPR mode to make it clear.

```
cmd:mycall dl6rai
MYCALL was NOCALL
cmd:c db0pv
cmd:*** CONNECTED to DB0PV
RMNC/FlexNet V3.3h - DB0PV/Muenchen - JN58SD - RU682 9600Bd FSK (G3RUH)
=>c db0clx

*** connected to DB0CLX
Hallo Ben, hier ist db0clx mit Clx5.04.
Cluster: 5 Links, 10 Nodes, 7 lokale Benutzer, max: 27.
Letzter Start: 23-Jul-2006 0058Z - Laufzeit: 65.20:37:40

dl6rai de db0clx 26-Sep-2006 2136Z clx >
q
73's Ben de db0clx

*** reconnected to DB0PV
=>q

73! *** DISCONNECTED^@
```



Initially we set the outgoing and then connect. Note that the **cmd:** prompt goes away the moment you are connected.

## Win-Test TNC set-up

To set-up TNC, open the menu `Options | Configure Interfaces`. Set up the correct COM port parameters, the same as those used before in the terminal program.

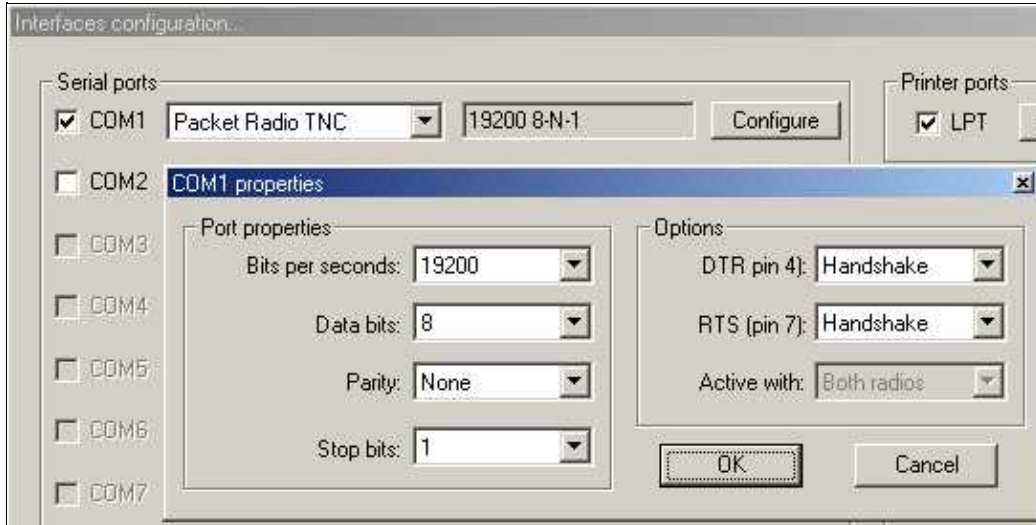

### TNC Configuration

**Note:** When using a simple three wire RS-232 cable on a real (physical) COM port, be sure to change DTR and RTS settings to "Always OFF". Otherwise you may see the start-up message of the TNC firmware but then not be able to send commands to the TNC.

## Testing the Setup

To verify that the TNC set-up and the connection are correct, open the DX-Cluster monitor window (**Alt+O**). After powering the TNC on, the startup message should appear as before in the terminal program. If this works fine, proceed - else try to find the problem and fix it.

## Connecting node

Once you have configured the appropriate COM port for your TNC in Win-Test, you should be able to connect to your local node.

Open the DX cluster window by using **Alt+T** to send a command to the TNC.

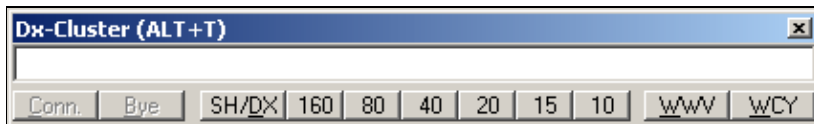

DX Cluster window - used to send commands to TNC or DX Cluster

To control the TNC, you may need to send an Escape character (in TF mode). Pressing **[Escape]** in the DX-Cluster window is not possible because the window would close. To send **[Escape]** to the TNC, you

must press `Ctrl-E`.

The following information is provided for a TNC in TF mode. TAPR works accordingly, but commands are different.

Check first if your call sign is already saved in the TNC. If not, no connection is possible. To check your call sign type in DX cluster window: `Ctrl+E I`. You can now see the TNC reply in the monitor window, e.g.: NO CALL or DL8NAS. If the call sign is not correct, type: `Ctrl-E I <call>` (i.e. `Ctrl-E I DL8NAS`) to change or restore it.

Channels are used to establish several AX.25 connections at the same time. After power-on, the TNC is usually on channel 0, where no connection is possible, only monitor mode. The command to change to channel 1 is: `Ctrl-E S1`. Message in monitor window: CHANNEL NOT CONNECTED

The connect command to your local node: `Ctrl-E C<node>` where `<node>` is the callsign of your local node.

You can follow how the connection is built in the DX-cluster monitor window. When connection is established, you may want to connect to your preferred DX-Cluster. It is important that all commands, after the initial connect, are sent without a leading **[Escape]**! These are normal inputs in the DX-cluster window, e.g.: `C DB0SDF-7` where `C` is the connect command to your local node, to connect to the DX cluster DB0SDF-7.

After the connection to your preferred DX-cluster has been established, you can use the buttons of the DX-CL window to list DX announcements or solar information. You can use the packet monitor window (`Alt+O`) to check the connection status and to see data that are coming in from the TNC. Spots should begin filling up the bandmap at this stage.

If no DX announcements arrive in that window, check the DX-Cluster options set-up:

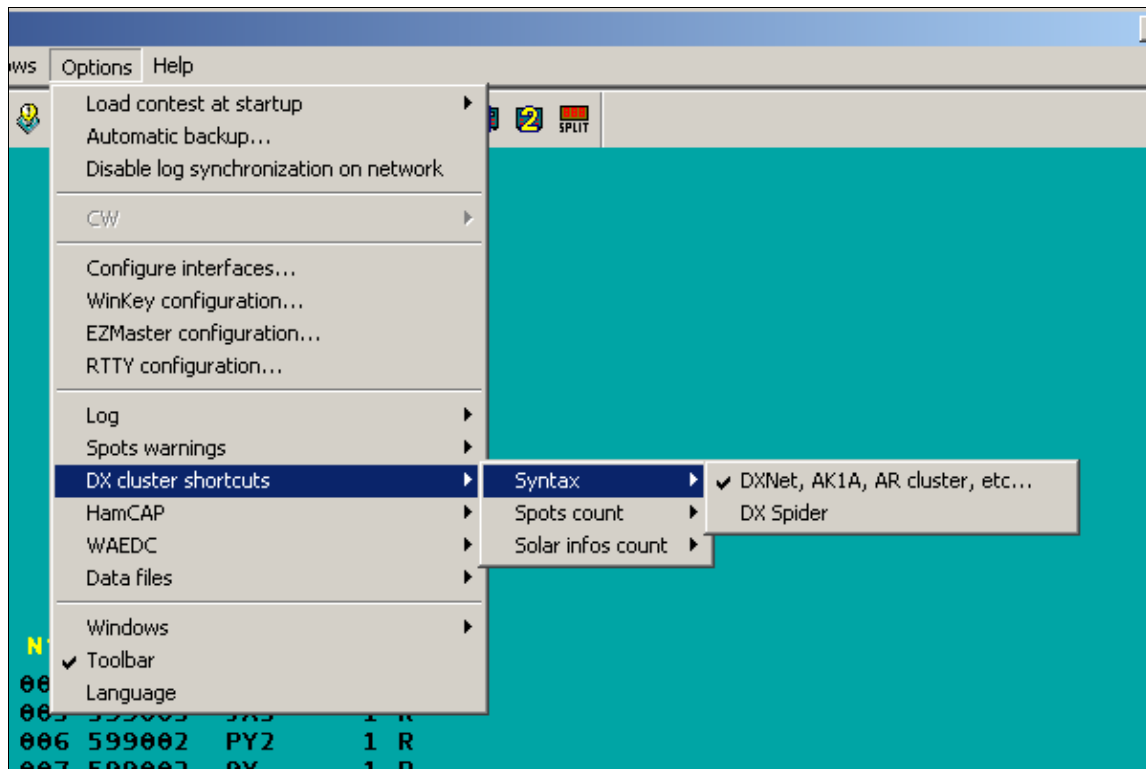

DX Cluster setup - are you using AK1A or DXSpider?

## Disconnecting node

To leave the DX cluster, use `bye` command in the DX-Cluster window. After reconnect to your local node, type the TNC command `CTRL+E D` to disconnect from your local node.

Other important TNC commands are:

`CTRL+E T16`: set TX delay, normally around 16 (12..20)

A summary of TNC commands set with TF OS can be found here: [The Firmware TF 2.6 Commands](#)

Sep. 25. 06, DL8NAS, Sigi

## See also

- [Connecting via telnet to a DX cluster](#)

## Namespaces

- [Page](#)
- [Discussion](#)

## Variants

## Views

- [Read](#)
- [View source](#)
- [View history](#)

## More

- This page was last edited on 27 October 2009, at 05:47.

- [Privacy policy](#)
- [About Win-Test Wiki](#)
- [Disclaimers](#)



# DX Cluster/Packet

From Win-Test Wiki

< [DX Cluster](#)

[Jump to navigation](#) [Jump to search](#)

## Contents

- [1 TNC pre-test](#)
  - ◆ [1.1 TheFirmware or WA8DED](#)
  - ◆ [1.2 TAPR](#)
- [2 Win-Test TNC set-up](#)
- [3 Testing the Setup](#)
- [4 Connecting node](#)
- [5 Disconnecting node](#)
- [6 See also](#)

## TNC pre-test

Before you can use a TNC with Win-Test, it should first be tested with a simple terminal program like Hyperterm provided with Windows. Do not try to get started with PAXON or other elusive software!

There are two types of TNC firmware:

- the WA8DED flavor (often also called: The Firmware, TF)
- the TAPR flavor

Both types allow switching the TNC into KISS mode, which is - however - not useful for our application.

When you turn the TNC on, the startup message will tell you what kind of software you have.

## TheFirmware or WA8DED

The following messages are displayed on a Symek TNC2H using TF mode:

```
TheFirmware Version 2.7 DAMA/SMACK/XHOST (2553 Bytes * 10 Channel)
  Copyright by NORD<<LINK, 14-Sep-94
    Free for non-commercial usage

Checksum (CBCB) = CBCB
```

In TF mode, commands are sent to the TNC using **[Escape]** followed by a command character. **[Escape] I** for example will allow you to set the outgoing callsign and to connect to a station, use **[Escape] C**. Here is a sample session. When pressing the Escape key, the TNC displays an asterisk followed by a blank character.

```
* idl6rai
* i
* DL6RAI *
* s1
```

## Win-Test Wiki

```
* CHANNEL NOT CONNECTED *
* cdb0pv

* (1) CONNECTED to DB0PV *^G
RMNC/FlexNet V3.3h - DB0PV/Muenchen - JN58SD - RU682 9600Bd FSK (G3RUH)
=>c db0clx

*** connected to DB0CLX
Hallo Ben, hier ist db0clx mit Clx5.04.
Cluster: 5 Links, 10 Nodes, 7 lokale Benutzer, max: 27.
Letzter Start: 23-Jul-2006 0058Z - Laufzeit: 65.20:35:15

dl6rai de db0clx 26-Sep-2006 2133Z clx >
q
73's Ben de db0clx

*** reconnected to DB0PV
=>q

73!
* (1) DISCONNECTED fm DB0PV *^G
```

## TAPR

TNCs in the TAPR mode, usually come up this way, or similar. The main characteristic for TAPR is the **cmd:** prompt. By the way, most TAPR TNCs use 7E1 (7 data bits - Even parity - 1 stop bit) COM port settings at 9600 baud, which is different from the typical 8N1 (8 data bits - No parity - 1 stop bit) settings.

```
SYMEK GmbH DK9SJ TNC2 EPROM
TAPR AX.25 Level 2 Vers 2.0
Release 1.1.8 30-08-92 32k
Checksum $67
cmd:
```

At the **cmd:** prompt you are able to enter commands. Let's do a simple session in TAPR mode to make it clear.

```
cmd:mycall dl6rai
MYCALL was NOCALL
cmd:c db0pv
cmd:*** CONNECTED to DB0PV
RMNC/FlexNet V3.3h - DB0PV/Muenchen - JN58SD - RU682 9600Bd FSK (G3RUH)
=>c db0clx

*** connected to DB0CLX
Hallo Ben, hier ist db0clx mit Clx5.04.
Cluster: 5 Links, 10 Nodes, 7 lokale Benutzer, max: 27.
Letzter Start: 23-Jul-2006 0058Z - Laufzeit: 65.20:37:40

dl6rai de db0clx 26-Sep-2006 2136Z clx >
q
73's Ben de db0clx

*** reconnected to DB0PV
=>q

73! *** DISCONNECTED^@
```

Initially we set the outgoing and then connect. Note that the **cmd:** prompt goes away the moment you are connected.

## Win-Test TNC set-up

To set-up TNC, open the menu `Options | Configure Interfaces`. Set up the correct COM port parameters, the same as those used before in the terminal program.

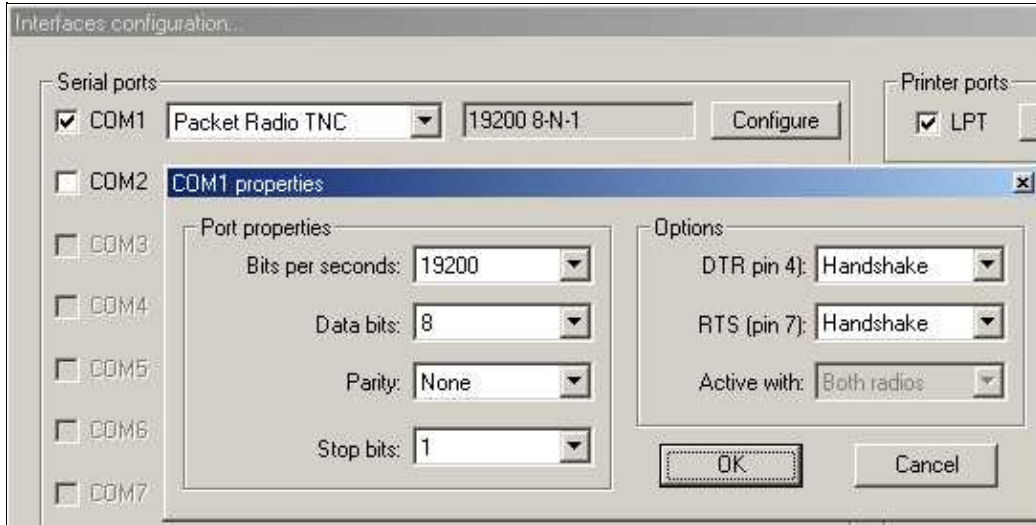

### TNC Configuration

**Note:** When using a simple three wire RS-232 cable on a real (physical) COM port, be sure to change DTR and RTS settings to "Always OFF". Otherwise you may see the start-up message of the TNC firmware but then not be able to send commands to the TNC.

## Testing the Setup

To verify that the TNC set-up and the connection are correct, open the DX-Cluster monitor window (**Alt+O**). After powering the TNC on, the startup message should appear as before in the terminal program. If this works fine, proceed - else try to find the problem and fix it.

## Connecting node

Once you have configured the appropriate COM port for your TNC in Win-Test, you should be able to connect to your local node.

Open the DX cluster window by using **Alt+T** to send a command to the TNC.

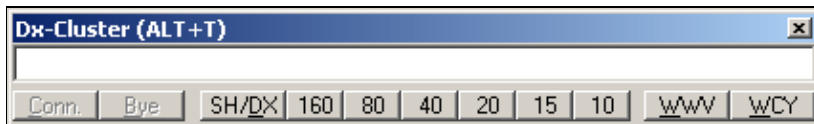

DX Cluster window - used to send commands to TNC or DX Cluster

To control the TNC, you may need to send an Escape character (in TF mode). Pressing **[Escape]** in the DX-Cluster window is not possible because the window would close. To send **[Escape]** to the TNC, you

must press `Ctrl-E`.

The following information is provided for a TNC in TF mode. TAPR works accordingly, but commands are different.

Check first if your call sign is already saved in the TNC. If not, no connection is possible. To check your call sign type in DX cluster window: `Ctrl+E I`. You can now see the TNC reply in the monitor window, e.g.: NO CALL or DL8NAS. If the call sign is not correct, type: `Ctrl-E I <call>` (i.e. `Ctrl-E I DL8NAS`) to change or restore it.

Channels are used to establish several AX.25 connections at the same time. After power-on, the TNC is usually on channel 0, where no connection is possible, only monitor mode. The command to change to channel 1 is: `Ctrl-E S1`. Message in monitor window: CHANNEL NOT CONNECTED

The connect command to your local node: `Ctrl-E C<node>` where `<node>` is the callsign of your local node.

You can follow how the connection is built in the DX-cluster monitor window. When connection is established, you may want to connect to your preferred DX-Cluster. It is important that all commands, after the initial connect, are sent without a leading **[Escape]**! These are normal inputs in the DX-cluster window, e.g.: `C DB0SDF-7` where `C` is the connect command to your local node, to connect to the DX cluster DB0SDF-7.

After the connection to your preferred DX-cluster has been established, you can use the buttons of the DX-CL window to list DX announcements or solar information. You can use the packet monitor window (`Alt+O`) to check the connection status and to see data that are coming in from the TNC. Spots should begin filling up the bandmap at this stage.

If no DX announcements arrive in that window, check the DX-Cluster options set-up:



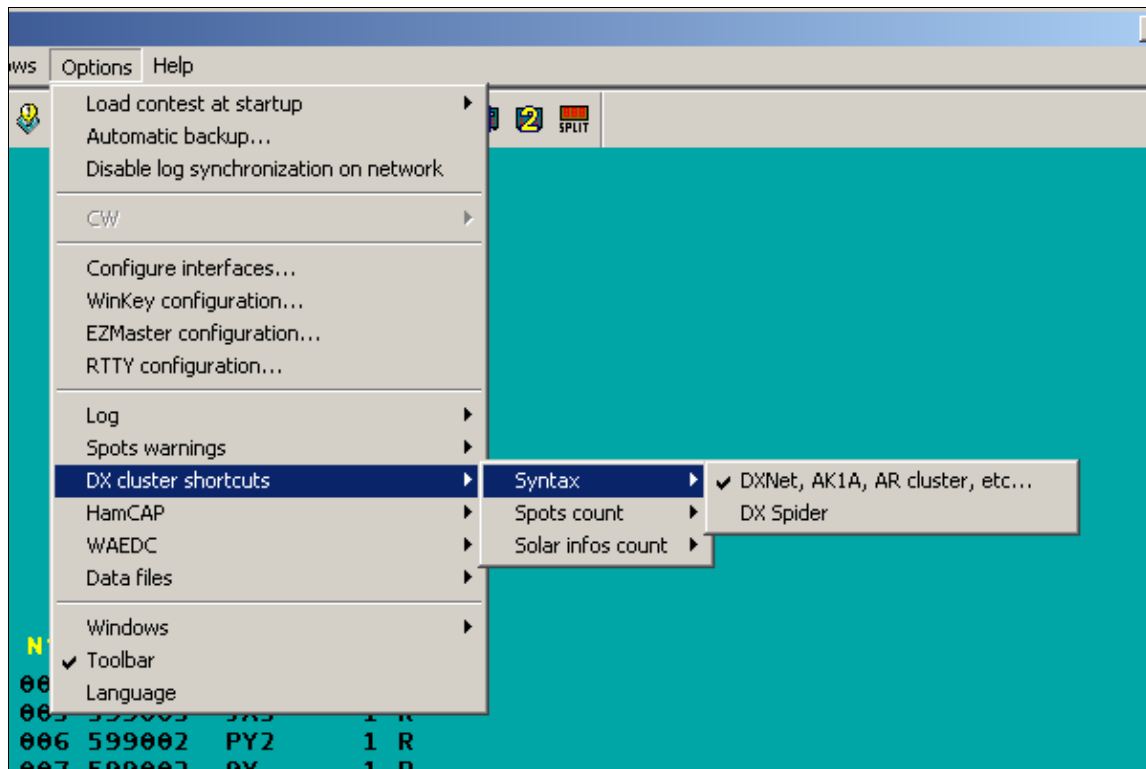

DX Cluster setup - are you using AK1A or DXSpider?

## Disconnecting node

To leave the DX cluster, use `bye` command in the DX-Cluster window. After reconnect to your local node, type the TNC command `CTRL+E D` to disconnect from your local node.

Other important TNC commands are:

`CTRL+E T16`: set TX delay, normally around 16 (12..20)

A summary of TNC commands set with TF OS can be found here: [The Firmware TF 2.6 Commands](#)

Sep. 25. 06, DL8NAS, Sigi

## See also

- [Connecting via telnet to a DX cluster](#)

## Namespaces

- [Page](#)
- [Discussion](#)

## Variants

## Views

- [Read](#)
- [View source](#)
- [View history](#)

## More

- This page was last edited on 27 October 2009, at 05:47.

- [Privacy policy](#)
- [About Win-Test Wiki](#)
- [Disclaimers](#)



# Multi-op/Passing

From Win-Test Wiki

[Jump to navigation](#) [Jump to search](#)

Passing multipliers between stations in a multi-op environment is key to success. Win-Test naturally handles multiplier passing very efficiently.

## Contents

- [1 Checking if a multiplier is required on another band](#)
- [2 Passing the multiplier itself](#)
- [3 Alerting the other operator\(s\) about the mult](#)
- [4 Working the passed station](#)
- [5 See also](#)

## Checking if a multiplier is required on another band

The first step to realise whether to pass a multiplier or not is to use the 'check multiplier' window (Windows | Check multiplier menu option, or **F10** keyboard shortcut). In conjunction with the status window (at your station) which tells you the frequency the other station(s) are on, you can see if you need and if you can to pass a multiplier or not.

For example, MULT1 station is on 21291, tuning up the band. RUN station works D4X which, according to the check multiplier window is a mult on 15m! So, the RUN operator should pass this station to 15m...

## Passing the multiplier itself

The frequency you pass the station to is very important but it is up to your team decide how to organise this. In the status windows you will notice a *QSY Freq* which should be the frequency the operator passes the mult to. However, it is up to your team members to ensure this frequency is kept up-to-date and clear of QRM (so it should usually be away from the centre of contest activity). The QSY frequency can be changed at any time by going to the Commands | QSY Frequency menu option. Simply enter the frequency or tune the rig to the frequency you want to set the QSY frequency to and click the button displaying the frequency (just to the right of the text entry field). Click OK and the change is made.

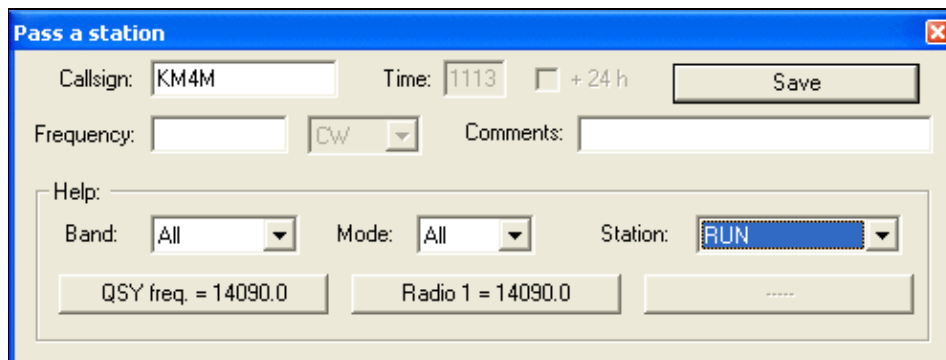

## Win-Test Wiki

Use the **Alt+D** keyboard shortcut to open the 'Pass a station' window. Many entry fields within this window are automatically filled for ease of use (and to save time!).

The callsign will be the most recent entered in the log at your operating position. If the station is moving instantly, you can leave the time too (which will be the current time by default). You can choose to either manually enter the frequency, or alternatively, you could use one of the 'Help' drop-down boxes (as shown above). The easiest way is to use the 'station' drop-down, which shows all stations on the network.

Let's imagine there's a MULT1 on the network, and we know he's on 15m. Choose 'MULT1' from the drop-down list, and you'll now notice the three buttons just beneath the drop-down lists now have different text - the QSY frequency and current radio 1 frequency as seen on the status window and at the MULT1 operating position. Remember earlier we discussed that you should always be passing stations to the QSY freq if at all possible.

You now simply have to click one of these buttons (e.g. QSY freq, radio 1, ...) and then type a comment if you wish (often not necessary). Click the 'save' button and the sked is saved.

## Alerting the other operator(s) about the mult

So now we've saved the sked (and thus effectively 'passed' the mult to the other operating position) but how is the other operator informed of the move? Well, we have the beauty of the 'skeds' window, which is found by going to the Windows | Skeds menu (or using the **Alt+B** keyboard shortcut):

# Win-Test Wiki

Skeds				
12:59	21129.0	SSB	ZS6UN	[38]
13:14	14138.0	SSB	Z31CZ	[15]
13:18	14138.0	SSB	T94B	[15]
13:23	14138.0	SSB	MMOBRG	[14]
13:38	14138.0	SSB	EW1GA	[16]
19:14	21205.0	SSB	KHOAA	[27]
19:16	14138.0	SSB	KHOAA	[27]
19:21	14155.0	SSB	KHOAA	[26]
19:23	14247.0	SSB	AH2R	[27]
19:38	14138.0	SSB	VE8JL	[01]
21:25	14138.0	SSB	YS1JBL	[07]
21:35	14138.0	SSB	YS1JBL	[04]
23:41	7015.0	SSB	HSOZAA	[26]
23:43	7015.0	SSB	VP2MEG	[08]
23:49	7015.0	SSB	J69EN	08
23:55	21130.0	SSB	VP2MEG	[08]
00:43	7015.0	SSB	KL7HBK	[01]
01:34	7015.0	SSB	6Y4Y	[08]
01:37	7015.0	SSB	HK1JMF	[09]
02:39	3795.0	SSB	LW7DX	[13]
04:22	3751.0	SSB	5JOX	[07]
04:24	3730.0	SSB	LZ9W	[20]
06:03	1825.0	SSB	VE3BW/HR9	[07]
06:13	3775.0	SSB	TU2CI	[14]
06:17	1825.0	SSB	GMOB	[14]
06:26	3775.0	SSB	TG9AVV	[07]
06:27	3775.0	SSB	TG9AVV	[07]
06:34	1826.0	SSB	GI3NVW	[14]
06:42	1826.0	SSB	TI8M	[07]
06:45	3775.0	SSB	KH7X	[31] dans 8 min il nous entend !!!
06:59	3675.0	SSB	EA9PY	[33]

The above screenshot shows the three colours which you will experience in this window. Basically, those stations with a grey background have been 'missed', i.e. the sked is more than 10 minutes old; those with a yellow background are imminent, i.e. within a 10-minute window; those with a turquoise (light blue) background are more than 10 minutes away.

The skeds window, like the [gab messaging](#) window, does **not** need to be open all the time for you to keep track of skeds. When a sked is imminent (i.e. those with a yellow background), the skeds window will open automatically!

In the example we used above, where we were passing KM4M, the sked window would pop-up on the MULT1 operating position and would look something like this:

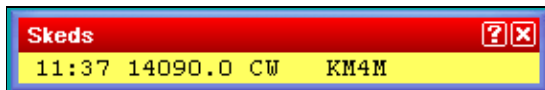

You could also use a [gab message](#) just to ensure the other op knows the mult is coming!

## Working the passed station

Working a station which has been passed to you is a simple case of double-clicking the callsign in the sked window. Double-clicking KM4M in the example above would tune to the radio to 14090.0 and also fill in the callsign entry field in the log so all you need to do is call the station and await their response! : )

After that, switching back to the RUN frequency can be accomplished by just pressing **Alt-F4** or selecting

Commands | QSY to run frequency

Simple, eh?

## See also

- [Message gabbing](#)
- [Understanding the status window](#)
- ...

## Namespaces

- [Page](#)
- [Discussion](#)

## Variants

## Views

- [Read](#)
- [View source](#)
- [View history](#)

## More

- This page was last edited on 13 April 2007, at 12:09.

- [Privacy policy](#)
- [About Win-Test Wiki](#)
- [Disclaimers](#)



# Positioning Windows

From Win-Test Wiki

[Jump to navigation](#) [Jump to search](#)

Window positioning is very easy in Win-Test. Simply click and hold the title bar on the window in question, and drag it where you want it! You can also click inside the windows while holding the Ctrl key. Releasing the mouse button will fix it in that position. Windows can be overlapped without any problem.

## Floating window layout

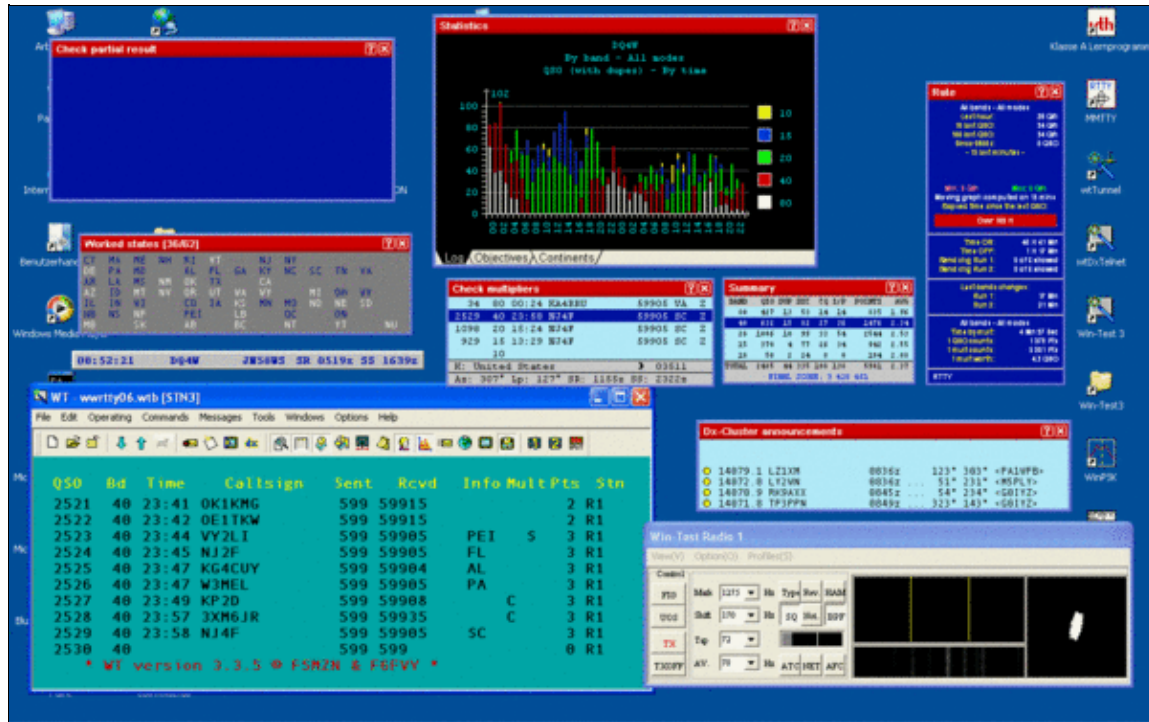



The floating windows option in Win-Test allows you to freely move WT's windows around on your Windows desktop.

By default, Win-Test positions all its child windows within one big window (with a green CT-like background). However, we understand this may not be to everyone's liking. As a result, there is a [floating window option](#) which will position all the child windows where you like with the main window being resized also to just show the log data. Press the Enlarge symbol to the right of the image caption (the two little squares) to display a hi resolution version of this image.

## Configuring windows

Right clicking on a window enables you to configure various options specific to that window. For example, with most windows you can change the titlebar background colour (default is red for all windows) and also change the font size, weight and typeface (sans-serif or serif).

## Changing the log font

You can configure the log font settings (size, weight and sans-serif/serif) by going to the `Options | Log | Font` menu. These settings can of course be altered at any stage during a contest with an opened log. You can also modify the font size by using your mouse wheel while holding the `[Ctrl]` key down (a la Mozilla/Firefox). Currently, there are four fonts: small, medium, large, extra large which you can use in regular or bold print.

## Resizing windows

Textual windows can be resized in height by steps of the font height by dragging the mouse while holding the `[Shift]` key down. This ensures no line will be cut.

## Moving windows

If you hold the `[Shift]` key down while you move a window, it will "snap" at most to the other opened windows, or at least will be aligned with them.

## See Also

- [Options | Windows](#) for information on how to save the current window layout as a default for new logs.

## Namespaces

- [Page](#)
- [Discussion](#)

## Variants

## Views

- [Read](#)
- [View source](#)

- [View history](#)

## More

- This page was last edited on 3 June 2008, at 00:29.

- [Privacy policy](#)
- [About Win-Test Wiki](#)
- [Disclaimers](#)



# Positioning Windows

From Win-Test Wiki

[Jump to navigation](#) [Jump to search](#)

Window positioning is very easy in Win-Test. Simply click and hold the title bar on the window in question, and drag it where you want it! You can also click inside the windows while holding the Ctrl key. Releasing the mouse button will fix it in that position. Windows can be overlapped without any problem.

## Floating window layout

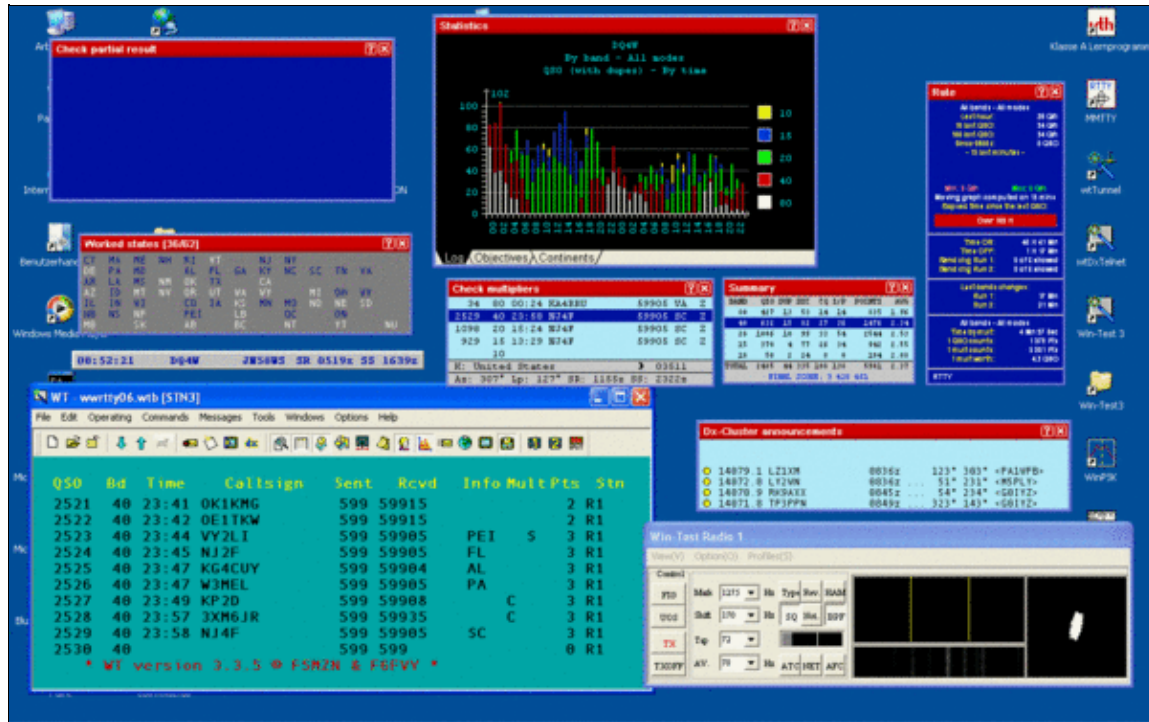

The floating windows option in Win-Test allows you to freely move WT's windows around on your Windows desktop.

By default, Win-Test positions all its child windows within one big window (with a green CT-like background). However, we understand this may not be to everyone's liking. As a result, there is a [floating window option](#) which will position all the child windows where you like with the main window being resized also to just show the log data. Press the Enlarge symbol to the right of the image caption (the two little squares) to display a hi resolution version of this image.

## Configuring windows

Right clicking on a window enables you to configure various options specific to that window. For example, with most windows you can change the titlebar background colour (default is red for all windows) and also change the font size, weight and typeface (sans-serif or serif).

## Changing the log font

You can configure the log font settings (size, weight and sans-serif/serif) by going to the `Options | Log | Font` menu. These settings can of course be altered at any stage during a contest with an opened log. You can also modify the font size by using your mouse wheel while holding the `[Ctrl]` key down (a la Mozilla/Firefox). Currently, there are four fonts: small, medium, large, extra large which you can use in regular or bold print.

## Resizing windows

Textual windows can be resized in height by steps of the font height by dragging the mouse while holding the `[Shift]` key down. This ensures no line will be cut.

## Moving windows

If you hold the `[Shift]` key down while you move a window, it will "snap" at most to the other opened windows, or at least will be aligned with them.

## See Also

- [Options | Windows](#) for information on how to save the current window layout as a default for new logs.

## Namespaces

- [Page](#)
- [Discussion](#)

## Variants

## Views

- [Read](#)
- [View source](#)

- [View history](#)

## More

- This page was last edited on 3 June 2008, at 00:29.

- [Privacy policy](#)
- [About Win-Test Wiki](#)
- [Disclaimers](#)



# Preface

From Win-Test Wiki

[Jump to navigation](#) [Jump to search](#)

The Win-Test wiki documentation project was originally started as an additional source of information for Win-Test users. As time progressed, more and more Win-Test users assisted and the wiki as seen now is the culmination of many people's contributions to the project. A big thank you to everyone who has helped!

## Mailing list

An email-based [mailing list](#) exists for Win-Test users. This is the **primary source** for support. The Win-Test community are very helpful and the Win-Test developers are also very active on the reflector. It is highly recommended all Win-Test users subscribe. Please do not contact the Win-Test developers directly - they have private lives and your email may well be overlooked, missed or ignored if you do so.

## Namespaces

- [Page](#)
- [Discussion](#)

## Variants

## Views

- [Read](#)
- [View source](#)
- [View history](#)

## More

- This page was last edited on 27 December 2023, at 01:15.
- [Privacy policy](#)
- [About Win-Test Wiki](#)
- [Disclaimers](#)



# SO1R/Radio control

From Win-Test Wiki

[Jump to navigation](#) [Jump to search](#)

## SO1R/Radio Control

The next step: controlling your radio. Why would you want to do that?

- Never forget to QSY in the log; push buttons on the radio and the computer follows you
- Fast QSY by using **Alt-F1**, **Alt-F2** or simply by entering a frequency
- Log the exact frequency of QSOs - so you can later analyse your operation
- Use the Band Map (with or without DX Cluster)
- Point and click to jump to a needed station and return to your frequency

### Hardware

In order to connect your radio to the COM port, you will need additional hardware in most cases. Most transceivers' serial ports come with TTL level while on the COM port you need RS-232 level. You have the option of buying a commercial interface for your radio or build one yourself.

Second, many modern computers lack a serial COM port. Some years ago it was a standard to have COM1 and COM2 but nowadays there are few applications for these ports. However, the ubiquitous USB port allows you to generate virtual COM ports again, often called COM5, COM6 etc.

### Setup

Next, setup your radio in the [Configure Interfaces](#) dialog in the Option menu. Select the correct settings for your radio. Kenwood, for example, usually requires 4800 bit/s 8N1.

Close the setup menu and enter a frequency in the callsign entry field like **7033**. The radio should now jump to 7.033 MHz.

When that works, go to the next step. Open up the [Radio 1](#) band map window through the Windows | Radio 1 menu. Watch the frequency display move when you turn the VFO.

### Namespaces

- [Page](#)
- [Discussion](#)

### Variants

### Views

- [Read](#)
- [View source](#)
- [View history](#)

## More

- This page was last edited on 15 July 2011, at 05:33.

- [Privacy policy](#)
- [About Win-Test Wiki](#)
- [Disclaimers](#)





# SO1R/Radio control

From Win-Test Wiki

[Jump to navigation](#) [Jump to search](#)

## SO1R/Radio Control

The next step: controlling your radio. Why would you want to do that?

- Never forget to QSY in the log; push buttons on the radio and the computer follows you
- Fast QSY by using **Alt-F1**, **Alt-F2** or simply by entering a frequency
- Log the exact frequency of QSOs - so you can later analyse your operation
- Use the Band Map (with or without DX Cluster)
- Point and click to jump to a needed station and return to your frequency

### Hardware

In order to connect your radio to the COM port, you will need additional hardware in most cases. Most transceivers' serial ports come with TTL level while on the COM port you need RS-232 level. You have the option of buying a commercial interface for your radio or build one yourself.

Second, many modern computers lack a serial COM port. Some years ago it was a standard to have COM1 and COM2 but nowadays there are few applications for these ports. However, the ubiquitous USB port allows you to generate virtual COM ports again, often called COM5, COM6 etc.

### Setup

Next, setup your radio in the [Configure Interfaces](#) dialog in the Option menu. Select the correct settings for your radio. Kenwood, for example, usually requires 4800 bit/s 8N1.

Close the setup menu and enter a frequency in the callsign entry field like **7033**. The radio should now jump to 7.033 MHz.

When that works, go to the next step. Open up the [Radio 1](#) band map window through the Windows | Radio 1 menu. Watch the frequency display move when you turn the VFO.

### Namespaces

- [Page](#)
- [Discussion](#)

### Variants

### Views

- [Read](#)
- [View source](#)
- [View history](#)

## More

- This page was last edited on 15 July 2011, at 05:33.

- [Privacy policy](#)
- [About Win-Test Wiki](#)
- [Disclaimers](#)



# Release Notes

From Win-Test Wiki

[Jump to navigation](#) [Jump to search](#)

## Contents

- [1 Release information 4.47.0 \(to be released\)](#)
  - ◆ [1.1 Bugfixes](#)
  - ◆ [1.2 New features](#)
- [2 Release information 4.46.0 \(January 17th, 2023\)](#)
  - ◆ [2.1 Bugfixes](#)
  - ◆ [2.2 New features](#)
- [3 Release information 4.45.0 \(October 18th, 2022\)](#)
  - ◆ [3.1 Bugfixes](#)
  - ◆ [3.2 New features](#)
- [4 Release information 4.44.0 \(July 22nd, 2022\)](#)
  - ◆ [4.1 Bugfixes](#)
  - ◆ [4.2 New features](#)
- [5 Release information 4.43.0 \(July 1st, 2022\)](#)
  - ◆ [5.1 Bugfixes](#)
  - ◆ [5.2 New features](#)
- [6 Release information 4.42.0 \(May 20, 2022\)](#)
  - ◆ [6.1 Bugfixes](#)
  - ◆ [6.2 New features](#)
- [7 Release information 4.41.0 \(Feb 15, 2022\)](#)
  - ◆ [7.1 Bugfixes](#)
  - ◆ [7.2 New features](#)
- [8 Release information 4.40.0 \(Jan 18, 2022\)](#)
  - ◆ [8.1 Bugfixes](#)
  - ◆ [8.2 New features](#)
- [9 Release information 4.39.0 \(Dec 6, 2021\)](#)
  - ◆ [9.1 Bugfixes](#)
  - ◆ [9.2 New features](#)
- [10 Release information 4.38.1 \(Oct 25, 2021\)](#)
  - ◆ [10.1 Bugfixes](#)
- [11 Release information 4.38.0 \(Oct 25, 2021\)](#)
  - ◆ [11.1 Bugfixes](#)
  - ◆ [11.2 New features](#)
- [12 Release information 4.37 \(June 29, 2021\)](#)
  - ◆ [12.1 Bugfixes](#)
  - ◆ [12.2 New features](#)
- [13 Release information 4.36 \(May 19, 2021\)](#)
  - ◆ [13.1 Bugfixes](#)
  - ◆ [13.2 New features](#)
- [14 Release information 4.35 \(Apr. 9, 2021\)](#)
  - ◆ [14.1 Bugfixes](#)
  - ◆ [14.2 New features](#)
- [15 Release information 4.34.1 \(Feb. 5, 2021\)](#)
  - ◆ [15.1 Bugfixes](#)

- [16 Release information 4.34.0 \(Jan. 25, 2021\)](#)
  - ◆ [16.1 New features](#)
  - ◆ [16.2 Bugfixes](#)
- [17 Release information 4.33.0 \(October 14, 2020\)](#)
  - ◆ [17.1 New features](#)
  - ◆ [17.2 Bugfixes](#)
- [18 Release information 4.32.0 \(September 1, 2020\)](#)
  - ◆ [18.1 New Features](#)
  - ◆ [18.2 Bugfixes](#)
- [19 Release information 4.31.0 \(June 28, 2020\)](#)
  - ◆ [19.1 New Features](#)
- [20 Release information 4.30.0 \(Jan 16, 2020\)](#)
  - ◆ [20.1 Bugfixes](#)
  - ◆ [20.2 New Features](#)
- [21 Release information 4.29.0 \(July 5, 2019\)](#)
  - ◆ [21.1 Bugfixes](#)
  - ◆ [21.2 New Features](#)
- [22 Release information 4.28.0 \(June 15, 2018\)](#)
  - ◆ [22.1 Bugfixes](#)
  - ◆ [22.2 New Features](#)
- [23 Release information 4.27.0 \(Jan 4, 2018\)](#)
  - ◆ [23.1 Bugfixes](#)
  - ◆ [23.2 New Features](#)
- [24 Release information 4.26.0 \(Nov 19, 2017\)](#)
  - ◆ [24.1 Bugfixes](#)
  - ◆ [24.2 New Features](#)
- [25 Release information \(4.25.0\) \(June 28, 2017\)](#)
  - ◆ [25.1 Bugfixes](#)
  - ◆ [25.2 New Features](#)
- [26 Release information \(4.24.0\) \(January 20, 2017\)](#)
  - ◆ [26.1 Bugfixes](#)
  - ◆ [26.2 New Features](#)
- [27 Release information \(4.23.0\) \(October 21, 2016\)](#)
  - ◆ [27.1 Bugfixes](#)
  - ◆ [27.2 New Features](#)
- [28 Release information \(4.22.0\) \(August 26, 2016\)](#)
  - ◆ [28.1 Bugfixes](#)
  - ◆ [28.2 New Features](#)
- [29 Release information \(4.21.0\) \(June 27, 2016\)](#)
  - ◆ [29.1 Bugfixes](#)
  - ◆ [29.2 New Features](#)
- [30 Release information \(4.20.0\) \(January 17, 2016\)](#)
  - ◆ [30.1 Bugfixes](#)
  - ◆ [30.2 New Features](#)
- [31 Release information \(4.19.0\) \(October 15, 2015\)](#)
  - ◆ [31.1 Bugfixes](#)
  - ◆ [31.2 New Features](#)
- [32 Release information \(4.18.0\) \(September 25, 2015\)](#)
  - ◆ [32.1 Bugfixes](#)
  - ◆ [32.2 New Features](#)
- [33 Release information \(4.17.0\) \(June 30, 2015\)](#)

- ◆ [33.1 Bugfixes](#)
- ◆ [33.2 New Features](#)
- [34 Release information \(4.16.0\) \(Mar 17, 2015\)](#)
  - ◆ [34.1 Bugfixes](#)
  - ◆ [34.2 New Features](#)
- [35 Release information \(4.15.0\) \(Nov 22, 2014\)](#)
  - ◆ [35.1 Bugfixes](#)
  - ◆ [35.2 New Features](#)
- [36 Release information \(4.14.0\) \(Oct 19, 2014\)](#)
  - ◆ [36.1 Bugfixes](#)
  - ◆ [36.2 New Features](#)
- [37 Release information \(4.13.0\) \(Jun 30, 2014\)](#)
  - ◆ [37.1 Bugfixes](#)
  - ◆ [37.2 New Features](#)
- [38 Release information \(4.12.0\) \(February 10, 2014\)](#)
  - ◆ [38.1 Bugfixes](#)
  - ◆ [38.2 New Features](#)
- [39 Release information \(4.11.0\) \(October 20, 2013\)](#)
  - ◆ [39.1 Bugfixes](#)
  - ◆ [39.2 New Features](#)
- [40 Release information \(4.10.0\) \(October 23, 2012\)](#)
  - ◆ [40.1 Bugfixes](#)
  - ◆ [40.2 New Features](#)
- [41 Release information \(4.9.1\) \(October 27, 2011\)](#)
  - ◆ [41.1 Bugfixes](#)
- [42 Release information \(4.9.0\) \(October 26, 2011\)](#)
  - ◆ [42.1 Bugfixes](#)
  - ◆ [42.2 New Features](#)
- [43 Release information \(4.8.0\) \(June 26, 2011\)](#)
  - ◆ [43.1 Bugfixes](#)
  - ◆ [43.2 New Features](#)
- [44 Release information \(4.7.0\) \(December 2, 2010\)](#)
  - ◆ [44.1 Bugfixes](#)
  - ◆ [44.2 New Features](#)
- [45 Release information \(4.6.1\) \(Released only for demo and DxPed versions\)](#)
  - ◆ [45.1 Bugfixes](#)
  - ◆ [45.2 New Features](#)
- [46 Release information \(4.6.0\) \(October 24, 2010\)](#)
  - ◆ [46.1 Bugfixes](#)
  - ◆ [46.2 New Features](#)
- [47 Release information \(4.5.2\) \(July 3, 2010\)](#)
  - ◆ [47.1 Bugfixes](#)
- [48 Release information \(4.5.1\) \(June 27, 2010\)](#)
  - ◆ [48.1 Bugfixes](#)
- [49 Release information \(4.5.0\) \(June 5, 2010\)](#)
  - ◆ [49.1 New Features](#)
  - ◆ [49.2 Bugfixes](#)
- [50 Release information \(4.4.0\) \(January 17, 2010\)](#)
  - ◆ [50.1 Bugfixes](#)
  - ◆ [50.2 New Features](#)
- [51 Release information \(4.3.0\) \(November 23, 2009\)](#)

- ◆ [51.1 Bugfixes](#)
- ◆ [51.2 New Features](#)
- [52 Release information \(4.2.0\) \(October 21, 2009\)](#)
  - ◆ [52.1 Bugfixes](#)
  - ◆ [52.2 New Features](#)
- [53 Release information \(4.1.0\) \(August 8, 2009\)](#)
  - ◆ [53.1 New Features](#)
  - ◆ [53.2 Bugfixes](#)
- [54 Release information \(4.0.1\) \(June 30, 2009\)](#)
  - ◆ [54.1 Bugfixes](#)
- [55 Release information \(4.0.0\) \(June 26, 2009\)](#)
  - ◆ [55.1 New Features](#)

## Release information 4.47.0 (to be released)

### Bugfixes

- When hovering an hyperlink, the hand cursor was not always displayed.
- HA DX contest : It was not possible to edit the serial sent (for non-HA stns). Tnx DJ8EW, DL6RAI.
- DARC Easter : The worked mults wnd (Alt-M) didn't display the correct data. Tnx DL7YS.
- F10 window : Under some circumstances and for specific contests, it could crash the program. Tnx PA2A.

### New features

- Lua API version string is 1.10.0
- Yuri Gagarin International DX Contest disabled because of the new rules where the same exchange can be counted differently (per band, or per band and mode) depending on its nature. The code can't cope with that.
- New text command : LOADMSGs to open the current op. directory and allow loading CW or RTTY messages.
- Lua : wtQso:SetSentSerial(nSerial) : If applicable, set the serial of the current QSO.
- Self-spot allowed for the ARRL DX, ARRL Sweepstakes and Russian DX. Complain to the ARRL and SRR if you want to stop this madness. Tnx N6TV.
- Lua : wtGab:Send now accepts a third optional boolean parameter to \*not\* log the sent gab. New API syntax : wtGab:Send(strText[, strToStation [, bDontLog]]). Tnx KD4D. Ex : wtGab:Send("Hello world!", "STN45", true) will send "Hello world!" as a gab to STN45, but won't log/display it in the sender Gab window.
- Lua : onBandChange event : If the radio is out of bands, the value of wtArg when onBandChange is called is set to "0/RadioId". Tnx TK5EP.
- Lua : New wtApp:Timeout(nDuration) added. Similar to wtApp:Sleep except Win-Test is not blocked while it is executed. nDuration expressed in ms.
- Lua : New wtApp:TimeoutBox(nDuration, [strText, [bAbortEnabled]]) API added. Displays a modal dialog box with a timeout progress bar, an optional centered text and an (optionally enabled) abort button. The duration is expressed in milliseconds (min 100). Win-Test is not blocked while it is executed.
- File / Explore now only copies the path if the Shift key is held.
- Fix bug : The NA Sprint LCR parser failed under some circumstances. Tnx N6TV.
- All CQ Contests : Restrictions regarding Russia and Belarus are now lifted. Tnx PA2A.
- CQWW RTTY : LCR parser added. Tnx F5UII.

- Option added in the World Map display to the differentiate skimmers spots from the human spots.

## Release information 4.46.0 (January 17th, 2023)

### Bugfixes

- ARRL RTTY Roundup : The Check Mult window (F10) was not filled properly. Tnx PA2A.
- When entering your own callsign in the log (to cancel a QSO), your own location was displayed on the spots map (if enabled).
- FT-891 : Code totally rewritten and it now works as expected. Tnx RX3APM for report, and DK5MR for testing.

### New features

- Lua API version string is 1.9.0
- Lua : wtApp:TextCommand now accepts "\*" as strStn to send to all stations of the network.
- Lua : New local variable wtFrom. Set to nil by default. Contains the name of the station that sent the text command thru network to run a local script. Can be useful when two (or more) stations exchange data with scripts.
- Lua : New onBandChange event when there is a band change. wtArg includes the band name and the radio as strings (ex : "10/0" for 10m on radio1). Reminder : The band name can have letters in it (2KM, 10G etc.) onBandChange.wts example : \_, \_, band, radio = string.find(wtArg, "(%d+[GKM]\*)/(%d+)") wtApp:AlertBox("RadioID: " .. radio .. " Band: " .. band). Tnx TK5EP.
- WAG : LCR parser added.
- Cabrillo import : When the Cabrillo contest identifier is unknown, Win-Test now offers the possibility to choose the contest the log is referring to.
- Radio wnd / List view : When possible, set an inactive VFO indicator. Tnx DJ0ZY.
- Carrier / Tune timer : The remaining time is now displayed in the Stop button caption.
- Explore Current op. directory added to the File menu. Two (similar) Lua API added to get this path : - wtApp:GetCurrentOpPath() - wtOp:GetPath()
- Lua : New wtKeyer:Load(strFileName) API to load messages from a .smsgs file. If no path is specified, the current op. directory is used. Tnx F6IFY.
- The default directory to save or load CW/RTTY messages is now set to the current op. directory.
- The QTC transmit and receive dialogs are checked to be always visible even if their positions were saved with a different monitors configuration. Tnx F5UII.
- The WAE messages can now be saved and loaded.
- Partner Wnd : After a Q is entered and the window is cleaned, the remaining content stays in place to not mess up the \$GRABn variables. Tnx FY5KE.
- Scripts manager : Refresh button added. Useful if you alter directly the scripts directory.
- Ctrl-X now prompts for a text command to be executed on the current QSO if it applies.
- The log caret / cursor can now be displayed as a solid block (Options / Log). Text commands : BLOCKCARET / NOBLOCKCARET or BLOCKCURSOR / NOBLOCKCURSOR. Tnx DL6RAI.
- When archiving, the full path of the generated zip file is copied to the clipboard.
- When using RUN vs S&P, Alt-F4 (return to the last RUN CQ freq) switches automatically to RUN. Tnx F5UII.
- WAE : Following the rules, if the received serial is set to 000, points are credited only if it is a new mult. Tnx F5UII.
- Text commands : "NOTES" added as a text command to open the notes file attached to the current log.

- Partner window : Partial callsigns or callsigns with wildcard character(s) '?' are now removed if they match the callsign entered in the log. Tnx FY5KE.
- Checkmark added to the freq offsets menu item if they're enabled.
- The summary data broadcast is now allowed for single-ops, independently of the Master setting in the contest configuration dialog. Tnx K2RET.

## Release information 4.45.0 (October 18th, 2022)

### Bugfixes

- Flex 6000 series added. Fixes the RTTY filter selection bug with the Kenwood interface. Only one slice is displayed, unless the split is selected. Tnx DL6DH, DL8OH, DL6RAI.
- IARU FD R1 : /MM stations do not count as mult. Tnx DL6RAI.
- WAEDC : When the Alt-M window was copied, the numerical call areas of the countries that apply weren't used. Tnx DL6RAI.
- OK1WC Challenge : When the callsign length was over 8 chars, the mult extraction (last char of the suffix) wasn't working correctly. Tnx DJ0ZY/DD5M.
- IOTA contest : In Multi-1 category, the QSO numbering was wrong. Tnx DL6RAI and others.

### New features

- Outbound RadioInfo external UDP messages capability added in the interfaces settings dialog (network advanced settings), to make easier to use additional programs or devices. Already tested with the rf-kit.de RF2K-S SSPA. Tnx F5HRY.
- Freq offsets : New text commands to access the setup : OFFSETSETUP (or OFFSETSSETUP). New text commands to enable/disable the freq offsets: OFFSET/NOOFFSET, OFFSETS/NOOFFSET, OFFSETON/OFFSETOFF, OFFSETSON/OFFSETSOFF. Tnx F5UII.
- OCDX : /M, /MM and /P do not count as prefix multipliers.
- New setting dialog (Commands / Carrier timer...) to enable or not the carrier/tune (Ctrl-T) timer and set its duration. Tnx F5HRY.
- The /LH callsign extension (LightHouse) doesn't interfere anymore in the DXCC entity resolution. Tnx F5UII.
- DXPed HF : Distance added to the geographical data of the F10 wnd. Tnx F5UII.
- Yaesu Band data code for 60m added on the LPT output. As the default code (identical to 40m) can interfere with other bands, the user can choose to use the 50 MHz (6m) band code or an unused code. Tnx FY5FY.
- Text and CSV export : The format YYMMDD is added to the fields list. Tnx F6AJA.
- IOTA contest : Cabrillo updated to v3.
- IOTA contest : Rules 2022 : The Q with Russian and Belarus stations count 0 point and don't count as multipliers. See <https://www.rsgbcc.org/hf/rules/2022/riota.shtml> (RSGB IOTA Contest website) for details.

## Release information 4.44.0 (July 22nd, 2022)

### Bugfixes

- REG1TEST files : The QSO points and the claimed score were always set to 0 by default. Tnx F1EZG @ TM5R.



## New features

- When applying exchange(s) to entered QSOs (Ctrl-F10), the numbers of found QSO and updated QSO are notified.

## Release information 4.43.0 (July 1st, 2022)

### Bugfixes

- Bugfix : The CW default messages for the REF DDFM 50 MHz were wrong.
- Bugfix : The title of the LPT port properties dialog was incorrect.
- Bugfix : When using markers in the bandmap and if the marker text was totally visible, the first line of the tooltip was empty. Tnx F6BGC.

## New features

- All Asian DX : Cabrillo updated to v3.
- Generic VHF+ contests have been extended to accommodate contests where a fixed exchange is sent instead of a serial number. Just enter this exchange in the "Exchange" field of the contest configuration dialog. If this entry field remains empty, the usual serial numbers are used. Tnx DL6RAI, DJ0ZY.
- All VHF+ generic contests are no more limited to 6-char grids (locators) and now accept 4-char grids (locators) exchanges as well.
- New option in the Cabrillo options dialog and the REG1TEST options dialog to set the claimed score to 0 point. Useful if you are using a contest template that is not fully adapted to the scoring method, and you don't want to mess up the claimed scores (if any).
- The names of two microwaves bands over 76 GHz were wrong. They are now correctly labelled 122G and 134G, instead of 119G and 142G. Tnx F4CWN.
- New band data code available on the LPT output, designed for VHF+ bands, from 50 MHz to 122 GHz. Tnx F4CWN.
- Band plans : New option to reject (automatic) spots outside the defined segments for a given mode, acting as filters. Tnx DL3DXX. Reminder : By default, the band plans are used to determine the mode of the (non-automatic) spots. They don't act as freq filters.
- Merge Logs : When sorting logs and if the timestamps of two (or more) QSO are identical (can happen if logs were imported from Cabrillo files), Win-Test now relies on the serial sent (if any) to order these QSO. Tnx N6TV.
- Yaesu FTDX-10 added. Tnx DL4LAM.

## Release information 4.42.0 (May 20, 2022)

### Bugfixes

- The display options of the zones window(s) (Alt+Z) were not always correctly retained between sessions. Tnx F5LIW.
- Notes report dlg : After editing a note, the log caret (cursor) wasn't restored.

## New features

- When creating your Cabrillo log, you can now also submit it in one click to the Super Check Partial Database. This feature requires wtScpSubmit.dll which is included in the latest Win-Test installers. If needed, this dll is also available at <http://download.win-test.com/utlils/wtScpSubmit.dll>. It must be placed in the Win-Test installation directory. Under some circumstances (especially with oldest OS), you may need MSVCP140.dll and/or others to be installed on your system. The easiest way is to install the latest Microsoft Visual C++ Redistributable packages for Visual Studio X86 available here: [https://aka.ms/vs/17/release/vc\\_redist.x86.exe](https://aka.ms/vs/17/release/vc_redist.x86.exe). Finally, on Win7, to ensure TLS 1.1 and 1.2 are enabled, apply this easy fix <https://is.gd/QlOgBg>
- CQ-M : 10-minute rule for MOST (M/S) entries removed (rules 2022).
- Add LCR parsers to the CQ-M, RAEM, and Yuri Gagarin DX contests.
- Add the Out Of Band sections to the CQ WW and CQ WPX LCR parsers. Tnx F6KOP.
- OK/OM : Rules 2022 : The Q with Russian and Belarus stations count 0 point and don't count as multipliers. See <http://www.okomdx.crk.cz/> (OK-OM DX contest website) for details.
- Interfaces Setup dialog : The keying compensation can now be negative (in the case where the TRX extends the keying). Tnx N6TV.
- CQWPX : Rules 2022 : The Q with Russian and Belarus stations count 0 point and don't count as multipliers. See <https://is.gd/HIMOLP> (CQWPX blog) for details.
- Lua : It's now possible to attach Lua scripts to text commands that are identical to mode names ("SSB", "CW", "RTTY", etc.). In these cases, the script will be called \*after\* the command is processed normally by Win-Test. Tnx TK5EP.
- The DX spots window (Alt+A) display options are now interactive.
- World Map : Options : The colors of the paths can now be the same as the markers.

## Release information 4.41.0 (Feb 15, 2022)

### Bugfixes

- REG1TEST / EDI : Under some circumstances, the output file wasn't created. Tnx OZ1ZAA.
- \$MSG10 was actually sending the additional MSG1 instead of MSG10. A 20-year old typo in the code ! Tnx SP5KP.

### New features

- Lua API version string is 1.8.0
- Op-entered spots are now protected from spots of the same DX on a freq inside the mode bandwidth window. Tnx DL6RAI.
- NA Sprint : LCR parser updated. Tnx N6TV.
- New countdown timer added (Tools menu or TIMER text command), especially for the single-ops. It indicates exactly when they can operate again after a pause. It's based on the time of the last QSO entered in the log, truncated to the minute. You can also use the text command TIMER/nnHmM or TIMER/nnHm (meaning nn hours and mm minutes), or TIMER/xxH (nn hours) or TIMER/nnM (nn minutes) to set and start the timer automatically. Tnx F5NZY.
- Shortcuts added to some of the reports buttons.
- QSO times are now by default considered as truncated to the minute for Time ON / Time OFF calculations and the QSY rules. Tnx F5NKX.
- Contest Recorder : AltGr+O, and text commands RECORD/NORECORD (and STARTRECORD/STOPRECORD) added to Start/Stop recording.

- UBA DX : Updated to comply with the rules 2022. Tnx F5LIW.
- World Map : "Copy content as image" menu item added.
- RTTY windows : Esc button added. Tnx PA2A.
- Notes report dialog. It's now possible to edit a note by selecting it and use Alt-N to modify the comment. Tnx F4CWN.
- REF HF : For M/S entrants, the compliance of the 10-min rule can be checked by using the appropriate item in the Tools / Check log menu.
- REF HF : Timer added in the Alt-J wnd for the M/S entrants.
- Lua : New wtRadio\* API : wtRadio\*:GetBand(), wtRadio\*:GetMode() and wtRadio\*:GetCqData() added. GetBand() and GetMode() return the current band and mode of the radio. GetCqData() return a Lua table with various data on the last sent CQ (that are stored for Alt-F4) : "freq", "qsx", "band", "mode" and "wpm" (for CW).
- World Map : New options to display short and longs paths for "my spotters" and the NCDXF beacons.
- New "NCDXF" text command to set the active radio on the NCDXF beacons frequency (if it applies).
- New option in the world map display option to show the NCDXF beacon that currently transmits if the radio is on the NCDXF frequency (+/- 100 Hz).
- The world map display options are now interactive. Different styles and a night opacity slider are also added.
- The "copy as image" feature now also copies the image in PNG format, to extend the paste scope (mail, twitter etc.).
- The RBN nodes and frequent spotters databases can be directly updated with the contextual menu of the map wnd (Display options).

## Release information 4.40.0 (Jan 18, 2022)

### Bugfixes

- Automatic op-entered spots during QSOs (especially in S&P) were not replaced by DX-cluster / external spots.
- When sending a gab composed of CAPITAL letters, do not shake our own gab window.

### New features

- Interface dialog : The usable COM ports are now extended up to COM32. The parameters list now also displays the Handshake (HS), Always ON (ON) and Always OFF (OFF) settings, and are ordered by Pin (DTR then RTS). Tnx DL5XJ, DL6RAI.
- New NCDXF/IBP Beacons window : Displays the transmission schedule of the NCDXF / IBP (International Beacons Project) beacons. A double click on a line gets the radio on the beacon freq. An "i" (stands for "info") in the status column indicates a comment you can read by hovering the mouse over it. Tnx VE3SUN.
- LCR : Croatian CW contest LCR parser added.
- LCR : Parser for CQ WW LCR updated. Works for preview and final reports.
- New feature : You can now grab a spot from the visible spots in the Radio windows or in the DX-cluster window by entering the callsign (or some letters of it) and Ctrl-Space.
- REF HF and REF 160m : LCR process updated. Tnx F4CWN.
- French (and some Belgian) users : Button added in the keys redefinitions dialog to load AZERTY redefinitions that allow the AZERTY keyboards users to access the numbers located on the top row without using the Shift or Shift Lock keys. They allow direct access to the ?, . and / keys of the

bottom row as well. This button is displayed only when the language is set to French.

## Release information 4.39.0 (Dec 6, 2021)

### Bugfixes

- Bugfix : For several contests, the columns headers were overlapping. Tnx F5HRY.
- WinKey : When using +/- in messages, the speed was randomly not reset to its initial value and the next message was sent with an incorrect greater speed. Tnx NN7CW and DL6RAI for their detailed reports and numerous tests to fix this long-standing bug.
- OK/OM CW DX-side : The district information display in the Mult window (F10) was broken.
- When Win-Test was started from the command line with an alternate application data directory (-a switch), the directory name wasn't unquoted. Tnx F1HAR.

### New features

- DX cluster (Alt-A) and Radio windows : The CT1BOH spot quality tags can now be displayed if they're sent by the skimmer. You can also filter the displayed spots by tag when applicable. Unless it's disabled by the user, in the list tab of the Radio window, the displayed spots are grouped by quality before being sorted. Tnx ES5TV.
- Script Manager : Hyperlink to the Lua API reference web page added.
- Op-entered spots are kept until worked or deleted on purpose, even if other stations are externally spotted on their frequencies. Tnx DL6RAI.
- Radio wnd : List tab : When spots are sorted by points or mult type, the second sorting criteria is now the beam heading rather than the spot frequency. Tnx DL6RAI.
- Gab : To draw attention, any gab text containing only CAPITAL letters now shakes the recipients gab window.
- SCP files : Defensive coding to attempt to prevent at best against crashes under some circumstances with badly-formatted or corrupted SCP or MASTER files. Tnx SP5KP.
- RDA Contest : LCR view added.
- OK/OM CW : 10 mins timer enabled for M/S category. RUN stations only.
- Larger log font sizes available for short-sighted ;-) Tnx TA2SE, W1NN.
- DX Spots window (Alt-A) : New option to pin the op-entered spots to the bottom of the window so you can always see them. Tnx DL6RAI.
- WAG : The output Cabrillo file is now following the v3 specs. Tnx DL1RTL.
- EU-DX : Multipliers list updated. Tnx IK6QON.

## Release information 4.38.1 (Oct 25, 2021)

### Bugfixes

- After importing a Cabrillo file, the resulting wt4 file couldn't be opened by Win-Test 4.38.0. Tnx F5LIW.

## Release information 4.38.0 (Oct 25, 2021)

## Bugfixes

- LCR parser fixed for the CQ WPX reports.
- CW : The spaced digits option was not read when starting Win-Test. Despite the checked option in the menu item, it was not enabled.
- CQWW VHF : When using the default CW messages, the sent grid was 6-char instead of 4-char. Tnx F5HRY.
- IARU HF : There are cases where different DXCC entities have the same Society (ex OH and OH0) and were counted as different mults.
- The "Dupes included or not in QSO counts and avg calculations" string in the summary text was always in local language even if summary in English was selected.

## New features

- Lua API version string is 1.7.0
- Defensive coding to check the log file when opening to prevent file corruptions. Tnx DL1DAW.
- Workaround for the USBSER.SYS bug that doesn't update the RTS line until DTR is accessed. Tnx R2AXZ (author of the Blue Pill Serial Monster).
- RDA Contest : Cabrillo updated to v3.
- WAE Transmit and Receive windows : New messages available.
- WAE : New CW variable \$RAWTIME to send the QTC time with cut numbers disabled.
- WAE : Transmit QTC window : A QTC line can now be directly sent by using the corresponding numeric key (0 sends the line labelled 10).
- Lua : New wtContest API : wtContest:GetCategoryId(), wtContest:GetModeCategoryId(), wtContest:GetPowerClassId() and wtContest:GetOverlayId() added.
- Lua : For standardization purposes, the microHam and OTRSP events scripts are now renamed :

```
microhamFsOn -> onMicrohamFsOn
microhamFsOff -> onMicrohamFsOff
otrspCrOn -> onOtrspCrOn
otrspCrOff -> onOtrspCrOff
otrspCrEvent -> onOtrspCrEvent
```

For now, to maintain compatibility, the script legacy names are still executed.

- Lua : New scripts called on log opening (onFileOpen) and on log closing (onFileClose).
- EU HF : The Cabrillo header is updated (EUHFC instead of EU-HF). Tnx DL6RAI.
- CQWW DX : The Youth overlay is added to the Overlay drop-down list.
- CQWW DX : The Explorer category is added to the Category drop-down list (Single-Op Explorer and Multi-Op Explorer).
- In the contest settings dlg, you can now set the default power class to use when creating new logs. Tnx DL6RAI.
- New archiving feature : File / Archive... (or ARCHIVE text command). It creates a timestamped zipped file in the log directory of the files related to the current log that are selected. Warning : Archiving audio recordings file that are usually pretty large can take a while... Be patient.
- For standardization purposes, all timestamped files are now timestamped to the nearest second.
- Time Shifting : The selection of the QSO and the stations are now independent. And a backup of the log is automatically performed before proceeding. Tnx EA7X/EF4HQ.
- Marconi Memorial HF : Points per QSO updated.

## Release information 4.37 (June 29, 2021)

### Bugfixes

- VHF+ contests : Sorting the Spots list by QSO points (related to distance if it can be computed) wasn't working.
- When copying the Summary wnd as text, the "Generated by Win-Test" line was missing. Tnx DL6RAI.
- Summary wnd : When using a language different from English, some column titles were incorrectly truncated.

### New features

- WAE : Rules 2021 : BY is added to the call area multipliers (so Chinese stations with different digits in their prefix count as different mults). Tnx DL7YS.
- ARRL FD : The "Covid" rule (Home stations can work home stations) is extended to 2021. Tnx VE2FWW.
- KCJ and KCJ Top Band contests rules updated. Tnx JI1RXQ.
- VHF+ contests : Discrepancies between gridsquares in the log for different bands weren't displayed in the Bad Exchanges check report. Tnx F4CWN.
- ARRL 10m : LCR viewer updated to fit to the new LCR format.
- The question mark character is now enabled in all QSO input fields, and the cursor is positioned on it when cycling the fields. Tnx N6TV.
- CW : New option for spaced digits in serials : When enabled, a half-space (^) is inserted between each digits of the serial, making it more readable at high speed.
- F10 Wnd : In DXPed HF or VHF, the date of the QSO is now displayed.

## Release information 4.36 (May 19, 2021)

### Bugfixes

- In Phone, when entering a (very) long exchange, the cursor might insert a ghost space character at the end of the field.
- VHF+ contests : Under some circumstances, when the automatic exchange (grid) guessing was set, the Check Partial wnd wasn't updated anymore after the field was automatically filled.

### New features

- CQ-M : Scoring is now updated and follows the rules 2021.
- IARU HF : In M/S (Mixed only) category, the 10-min status timer now takes into account mode changes. Tnx HA6OI.
- HA DX : The Cabrillo output file now includes the RUN/MULT indicator for the M/S entrants. Tnx HA6OI.
- YOTA (Youngsters On The Air) contest implemented.
- ARI DX / ARI 40-80 : Provinces list and exchange equivalence file (ARIPROV.DAT) updated. Tnx HB9AMO, DL6RAI.
- City, State/Prov, Postal Code and Country separate fields added to the contest settings dialog to improve the compatibility with the Cabrillo v3 header fields. These fields are assembled together to maintain the back compatibility with the Cabrillo v2 format if needed. It is highly recommended to

edit your saved profiles (if any) by loading, editing and saving them one by one in the dialog.

- CQMM DX implemented.
- All file dialogs are now resizable.
- YUDX : LCR view added.
- LCR viewer : Column order unified.
- OK/OM Contest SSB : This contest was not listed when the contests of the month checkbox (in April) was selected. Tnx F1HAR.
- OK/OM contest : You can now directly download your LCR in Win-Test from the "rejected" link in the final results and preliminary results page.

## Release information 4.35 (Apr. 9, 2021)

### Bugfixes

- OK/OM Contest SSB : When entering as non OK/OM, the points credit was wrong when working an OK/OM stn. Tnx F1HAR.
- When parsing the DX cluster stream, lines were discarded if the callsign of the spotter was longer than 9 characters (ex : 3V/KF5EYY-#, K4VET-1-# or JR1BFZ/2-#) and the freq higher than 9999.9 MHz. Tnx DL6RAI.
- RSGB Commonwealth Contest : The off-time value wasn't specified for this contest (60 mins) and the default value (15 mins) was used instead. Tnx M0UNN.
- Tools / Automatic CQ Repeat : The delay between CQ was not saved between sessions. Tnx F4CWN.
- Tools / Search for possible bad exchanges : If there was no log discrepancies and a check against the database was requested, it was not displayed. Tnx F4CWN.
- Lua : wtQso:IsModeCw() was always returning false.

### New features

- King Of Spain : The 10 min rule for the multi-op entrants is now removed.
- Radio Wnd : Ctrl+R shortcut added to allow cycle the view tabs without using your mouse.
- Option added in the dialog to replace op in batch, to match any operator already entered.
- LZ DX contest : LCR view added.
- SPDX : The limitation on the number of band/mode changes during a clock hour in all categories is now removed.
- RTTY windows : It's now possible to log the data stream to files created with the .ry1 and .ry2 extensions. Tnx DL6RAI.
- The default off-time when not specified in the rules is now set to 30 minutes instead of 15.
- WAEDC : LCR review added. Tnx DL7YS, DL6RAI.
- DX Cluster Announces (Alt+A) : Exchanges can now be displayed (if it applies). Tnx F4CWN.
- DX Cluster announces (Alt+A) : New dialog to facilitate the choice of bands to be displayed, replacing the sub-menus. Tnx F5HRY.
- Alt+F4 / Alt+F5 : When running in CW, the current CW speed is saved when CQ'ing (or using Alt+F5), and is restored when QSYing back to the saved run frequency.
- UI : All textual child windows that can be resized with the mouse (Check Partial (F12), N + 1 (F8), Skeds (Alt+B), Gab (Alt+I), Stats (Ctrl+F9), Radios, RTTY, DX Cluster monitor (Alt+O) and announces (Alt+A)) are now resized according to the size of the font used. To remove this constraint and resize freely, keep the Shift key down while resizing.
- Cabrillo output : The @ character is now allowed in the operators list. Tnx N6TV.
- ARRL DX : Band changes restrictions set to 10 for the M/S category, according to the new rules. Tnx N1PSE.

- Check Partial (F12) : In some cases, when multiple wildcard characters ('?') were used, no search was performed. It's no longer the case as soon as there are at least 2 characters that are not wildcards in the pattern to search. Tnx F4CWN.
- PACC : Cabrillo v3 output implemented.
- Summary wnd : For the Instagrammers and such, your callsign is now added to the window title. Tnx F6BGC.
- Multi-Distributed category introduced.
- More restrictive checks applied to the exchanges database to dump malformed callsigns or exchanges.
- New Exchanges Database information dialog : Options / Data files / Exchanges database... Text commands : EXCHDB, EXCHDATABASE, EXCHFILE or EXCHFILES. Tnx N6TV, DL5YM.
- LCR : Add instructions if Win-Test can't directly download and/or process LCR for some contests.
- RDXC : MOST indicators (0 and 1 for RUN and MULT) added to the Cabrillo output file. The 6-char grid square is now also required for all entrants. Tnx UA9QCQ.
- The callsign exceptions (callsigns that don't follow the usual rules, like RAEM, 5VDE, 7QAA, etc.) are no more hardcoded and are now grouped in the exceptions.dat file (in the /extras directory) for easy updating.
- CQWW 160m : Cabrillo v3 output implemented. Tnx N6TV.
- ADIF output : QSO with my own callsign are always discarded. Tnx N6TV.

## Release information 4.34.1 (Feb. 5, 2021)

### Bugfixes

- EU-DX Contest : The 10m band was missing in the summary. Tnx F1DUZ.
- EU-DX Contest : CW and SSB columns added for the Mixed category.
- Italian translation DLL updated.

## Release information 4.34.0 (Jan. 25, 2021)

### New features

- Lua API version string is 1.6.0
- QQSLON / QQSLOFF or QQSL / NOQQSL text commands to enable (or disable) the Quick QSL feature. QUICKQSL still opens the Quick QSL settings dialog. Tnx F6IFY.
- EU-DX Contest added. Requires EU.DAT countries file. Tnx IK6QON.
- Lua : wtRadio\*:SetFreq(fFreq) and wtRadio\*:SetFreq(fFreq, nVfo) now ignore the freq if it's outside of any band, and return with no error message. Tnx F6IFY.
- Lua : wtQso:IsModeDigital() and wtQso:IsModeCw() added.
- Lua : nQsoNum (optional) added as argument to wtQso:GetData([nQsoNum]) function.
- LCR : IARU HF LCR processing rules updated.
- 5VDE added as an exception callsign.
- LCR : If Win-Test supports LCR review and the contest has been entered in a multi-op category, an Operator column is added in the review dialog. Tnx F5HRY.
- OK/OM contest : LCR processing added. Requires to save the "rejected QSO" page as an html file and to load it in Win-Test. Tnx F8BXI.
- CQWW DX : LCR processing rules updated to fit the new CQWW LCR format.
- ARRL Contests : The ARRL has finally unified the US States and VE provinces and territories lists, and the Prince Edward Island abbreviation is now PE for the ARRL DX, ARRL 10 and ARRL roundup RTTY contests.



- NAQP : The Prince Edward Island abbreviation is now PE. Tnx N6TV and AC0W.
- NA Sprints : The Prince Edward Island abbreviation is now PE.
- NRAU contest : New abbreviations for some Fylke / Lan / Province / Region updated. Tnx ES7GM.
- Script manager : The minus key located in the numpad is now considered different from the key located in the character keys. To be consistent, the same rule applies when redefining keys. Tnx F5HRY.
- JIDX : 160m added to the SSB leg. Tnx N6TV and N6KI.
- Icom IC-705 added. Tnx OH1MA.
- "Ethernet network" reworded as "Local Network" to prevent confusion. Tnx FY5FY.

### Bugfixes

- CQWW 160m : The exchange database file ARRL-USVE.DTB wasn't loaded. Tnx DL4MM.
- UK/EI : If the district field was manually filled before the serial number, that field was emptied when the cursor got back to the callsign. Tnx PA2A.
- RAEM Contest : The polar circle location (giving extra bonus points) was slightly wrong.
- The IC-9100 couldn't work... Because of a stupid typo ! Tnx DL2AKT and N6TV.
- WAE RTTY : When the log was reopened, the next sent QTC group number was wrong. Tnx DL6RAI, DJ9MH and DJ4MZ.

## Release information 4.33.0 (October 14, 2020)

### New features

- ARRL SS, ARRL 160, ARRL FD : PE (Prince Edward Island) section added. Tnx W1NN.
- MicroHAM MKIII interface added. Tnx G0HSA, OM7ZZ.
- When a file error occurs when saving DX-cluster data, the user can now Cancel to abort further writing attempts. Tnx DL5MLO.
- Exchanges Databases (.DTB files) : Defensive coding to attempt to prevent at best against crashes under some circumstances with badly-formatted or corrupted databases files. Tnx OK1DSZ @ OK4C.

### Bugfixes

- AGCW-DTC : 2 points Club stations list updated. Tnx DL6RAI.
- WAG : The Exchanges file (WAG\_DL.DTB) wasn't correctly loaded for DL entrants. Tnx DL4NAC and DL6RAI.
- All Asian DX contest : Cabrillo CONTEST: line text fixed. Tnx VA2EW.

## Release information 4.32.0 (September 1, 2020)

### New Features

- YO DX HF : Contest rules updated (160m added + points for /MM stations).
- WAE DX side : QTC line numbers displayed for easy retrieval in case of repeat request.
- All reports dialogs can now be vertically resized to display more or less list rows. The window placements are also globally saved.
- File / Update Exch Database : A confirmation dialog is now displayed and a backup of the current DTB file is done, before proceeding.
- New Check Partial search processing for VHF+ logs :

In VHF+ contests logs, you can now enter a partial callsign (in the callsign field) and/or a partial locator / grid (in the grid square field) to refine searches in the Check Partial wnd (F12).

The minimum number of chars to start the search for the callsign field is set by the contextual menu (3 by default), and set to 2 characters for the locator.

Finally, in both fields you can also use wildcards characters '?' to represent a character. Ex: "JN?8EQ" will search for all callsigns with locator JN08EQ, JN18EQ, JN28EQ, ... JN98EQ.

Inspired by DL2NBU DOS software. Tnx DL6RAI.

## Bugfixes

- callsign.pat updated. Tnx DL6RAI.
- RDAC : RDA.DAT (district list) updated.
- The audio record button is now disabled when recorded audio is playing.
- IOTA Mixed : Summary columns weren't consistent with the rest of them, and created a bug when used with Unipost (cqcontest.net). Tnx DL6RAI.
- When the same callsign was spotted on both sides of a sub-band limit (so, it was considered spotted in both modes), Ctrl-Up/Down kept grabbing these two callsigns alternately. Tnx F5UTN @ TM0HQ.
- ARI Sezioni : Rules and mult list updated. Tnx IV3IYH. Mult List : <http://download.win-test.com/databases/ARISEC.DAT>
- EU HF Championship : The content of the EU\_HF.DTB database was ignored. Tnx EW2AA.
- MMC HF wasn't showing up in the contests of the month in July. Tnx DL6RAI.
- LCR review added for ARRL 160, NA Sprint, ARRL Sweepstakes. Tnx N6TV.
- Elecraft K4 added. Tnx N6TV.

## Release information 4.31.0 (June 28, 2020)

### New Features

- Lua API version string is 1.5.0
- Lua : wtApp:PostMessage, wtApp:SendMessage and wtApp:GetLastError added. Tnx F6BEE for inspiration. See description and syntax in <http://download.win-test.com/v4/lua/LuaApiDoc.txt>
- ARRL FD : Covid-19 rule exception : Class D stations may work all other Field Day stations, including other Class D stations, for points. Tnx K6ZB.
- Log Checking Report (LCR) review added in the Tools / Check log menu. For now, only the following LCR are processed :
  - ◆ CQWW DX
  - ◆ CQWW WPX
  - ◆ ARRL DX
  - ◆ ARRL 10m
  - ◆ IARU HF
  - ◆ EU HF
  - ◆ SAC
  - ◆ KOS
  - ◆ REF HF
  - ◆ VHF+ contests if adjudicated with LX

Mainly, because these LCR are public, or because I had one ;-). Any textual (or html) LCR can theoretically be implemented, as long as I have access to a sample.

## Win-Test Wiki

For various reasons, sometimes the "Download LCR" may not work. In that case, try to download the LCR with your browser and save it in a convenient location (the log directory is the best choice). You can "attach" it to your log by using the "Save" button in the report dialog.

- Dx-Cluster window (Alt-T) : Number of Macros increased to 8. Tnx PA2A.
- Dx-Cluster macro editor : Window enlarged, and the edit field now wraps to improve readability. Tnx PA2A.
- The merge dialog now displays "compact paths".
- NRAU Baltic mults list updated. Tnx LB3RE.
- Review of the exchanges databases files to prevent mixing different exchanges between contests. Also, if a contest uses only a part of a database file, the rest is kept untouched if the database is updated with Win-Test.
- Depending on the contest and, if it applies, whose side you're on (DX side or domestic), the callsigns from the master file (namely MASTER.SCP/DTA or .DTB/SCP) are filtered to display only relevant results in the Check Partial and N+1 windows.
- The master file in use can now be directly updated from the Internet (like the CTY files) by using the Options / Data files / Master file menu, or by using the "Used File list" item in the contextual menu of the Check Partial or N+1 windows.

Note : The recommended default master file to use is MASTER.SCP, maintained by Stu K6TU (<http://http://supercheckpartial.com/>).

Reminder : You can also use contest-specific master files (recommended only for minor national or regional contests) named after the list located at

[http://download.win-test.com/files/checkPartial/%23\\_READ\\_ME\\_%23.TXT](http://download.win-test.com/files/checkPartial/%23_READ_ME_%23.TXT) These files do not replace the default master file, but complement it at runtime.

- In the contest settings dialog, contests no longer taking place have been removed from the list.
- New REBOOT (or RESTARTPC) text command added. It closes the current log and restarts the host PC. Tnx F8CRH, F6BEE.
- When the exchanges database is updated, a notification message is displayed at the bottom of log. Tnx DL6RAI.

## Release information 4.30.0 (Jan 16, 2020)

### Bugfixes

- If the backup volume was unmounted, disabling the next backups was failing. Tnx F6HJO. (Task #388)
- Under some specific circumstances, the Single-Op Assisted category wasn't taken into account when importing such a Cabrillo file. Tnx TO1A.
- With multi monitors systems and under some specific circumstances, choosing colors with mouse was impossible. Tnx KL0R.
- The headers row was always included in the CSV output file, whatever the setting was. Tnx F5LIW.
- The LCD display of the contest recorder wnd wasn't always properly updated when using a language different from English.

### New Features

- HA DX contest rules updated. Tnx HA6OI, HA1AG, F5LIW and others.
- UFT contest rules updated. Tnx F6CEL.

- Yaesu FTDX101 added. Tnx RA1ANY, RA3AUU.
- Icom IC-9700 added. Tnx F1ULQ.
- WAEDC : Cabrillo output file upgraded to v3 specs.
- WAEDC DX side : Send QTC dialog (Ctrl-L) now displays the maximum available QTC to send (if any). You can modify the number of QTC to send, or only display the already sent QTC, with F9 (or the "QTC / Show sent" button). F8 allows to modify the recipient callsign.
- QSO and distinct callsigns counts added in the distinct callsigns report when sorted by country.
- "Copy" button added to the log check dialogs, allowing to easily paste reports in a spreadsheet.

## Release information 4.29.0 (July 5, 2019)

### Bugfixes

- When a exception callsign and a prefix were identical in the CTY file, and under some specific circumstances, the DXCC lookup function could fail. Tnx F5LIW.
- FOC Marathon : Stats are now displayed on 3 days. Tnx F5NZY.
- RSGB AFS : Dupe count on 40m was wrong. Tnx G0HSA.
- REF 160m : The total and final score lines weren't displayed in the summary window.
- RTTY : Messages with embedded scripts were hanging Win-Test. Tnx N6TV.

### New Features

- YU DX Contest rules updated. Tnx F5IN.
- Spot Warnings : When you're spotted, the spot comment, if any, is now displayed.
- RSGB HF contests : District Code for Norwich has been changed from "NR" to "NK". Tnx F1ICS.
- ADIF export : Output fields reordered and STATION\_CALLSIGN field added. Tnx YT9TP.
- IARU HF : Cabrillo v3 output file implemented. Fixes also task #384. Tnx OH6XX, N6TV and others.

## Release information 4.28.0 (June 15, 2018)

### Bugfixes

- When no MP3 CODEC were detected, start recording was displaying the MP3 settings dialog in an endless loop. Tnx N6TV.
- ARI Contest : Serial numbers for DX stations have separate numbering per band. Tnx ES5TV.
- Validation controls of the split freq edit field strengthened.

### New Features

- Single-click actions option added to all windows where it makes sense. Tnx K5WQG, N6TV.
- The callsign "6OX" is accepted despite its exotic syntax.
- CQWW RTTY : DC mult added according to the 2018 rules. Tnx W0YK.
- Internal CW keyer (LPT and serial outputs) : Keying compensation added (0 to 20 ms) in the Interfaces setup dlg. Tnx N6TV.
- Icom IC-7610 added. Tnx N6TV.
- REF contest : Off-time periods dialog removed. Tnx F5LEN.
- CW / RTTY : Work dupes by default. Tnx F6IRA.

## Release information 4.27.0 (Jan 4, 2018)

### Bugfixes

- RAC contest : Despite the rules indicate MIXED (CW + SSB) category only entries, the F10 wnd wasn't correctly scaled when using a single-mode category. Tnx SP5KP.
- Statistics Wnd (Ctrl-F9) : Under some specific circumstances, the log data weren't correctly displayed in the targets tab. Tnx F5LIW.
- Auto-repeat mode was broken (silly me !). Tnx VE2FWW, N6TV, W4DD and many others.

### New Features

- DARC XMAS : Sprint logic exchange now applicable for this contest. Tnx K3LR and N6TV.

## Release information 4.26.0 (Nov 19, 2017)

### Bugfixes

- When prefixes or callareas are mults, some special callsigns weren't correctly taken into account. Tnx OF100FI/O.
- Status wnd (Alt-J) : Under some specific circumstances, the stations count displayed in the title bar was wrong.

### New Features

- LZ DX : QSO and DUPES columns were inverted in the summary window in single-mode categories, and CW and SSB columns were swapped in Mixed category. Tnx W3SE / ZL3TE.
- SAC : Wire-Only overlay category added. Tnx OH1RX.
- CSV and text exports : Serial sent text format is identical to the format used in the log. Tnx F5LIW.
- Gab wnd (Alt-I) : Can be cleared now with a CLEARGAB text command.

## Release information (4.25.0) (June 28, 2017)

### Bugfixes

- VHF+ contest : The ODX was broken under some specific circumstances. Tnx F5HRY/P.
- SPDX Contest : The summary window was broken. Tnx SP5KP, F5LIW and others. (Task #380)
- Asia-Pacific sprint : Win-Test was unable to write the output Cabrillo file. Tnx UA9YE.
- Some AltGr (Ctrl + Alt) keys were not correctly displayed when defined in the script manager or the DEFINEKEYS command.
- Under some very specific circumstances of networking connection / disconnection and sync enabling / disabling, the log file could be corrupted. Tnx PA2A @ PI4CC.

### New Features

- Helvetia contest : New rules 2017 implemented. Tnx HB9AMO and others.
- ARI DX : Allowed bands and 10-minute rule adapted to the rules 2017. Tnx IZ1LBG. (Task #379)

- RSGB AFS : 40m added. Tnx G3RTE.
- The displayed bands selection for the Check Callsign (F9), Check DXCC (Alt-M), Check Mult (F10) and Check Zone (Alt-Z) windows is now done in a dialog box instead of menu items. Tnx F5LIW.
- NA Sprint SSB : The Multipliers list is updated and is now similar to the mult list of the CW/RTTY legs . Also, the equivalence is now NA\_SPRINT.DAT for all legs, and has been updated on the repository. Tnx KA9FOX.

## Release information (4.24.0) (January 20, 2017)

### Bugfixes

- Under some circumstances, the rotators wnd was flickering.
- NA Sprint CW/RTTY : Multipliers list updated. Tnx N6TV, N6TR. Note : You must update your NA\_CW\_RTTY\_SPRINT.DAT equivalence file if you use it, to get credit for the new mults.
- DXPed HF logs : The country list used is now the DXCC one, not the "CQWW" one.
- FT1000 : VFO-B frequency setting enabled. Tnx DL6RAI.
- FT1000 : When setting a split freq, the filter setting wasn't retained. Tnx DL6RAI.
- Typo in a menu item. Tnx DL6RAI.
- When a callsign was grabbed, the realtime slot of the partners windows were not updated.
- Cabrillo : The alternate frequency option wasn't working for multi-ops logs.
- Under some OS display settings, the Alt-F dialog was truncated. Tnx HA3LN.
- After editing logged QSO, the Alt-J QSY timers were not always accurate.

### New Features

- New network protocol version 1.30 released. Reminder: If you use WT in a networked environment, you must have the same WT version on all machines!
- Lua API version string is 1.4.0
- To make the 3830scores.com reporting easier, the summary columns of the mixed mode contests are reordered.
- DXPed logs (HF and VHF) : The reports entry fields ignore keys which are not digits. Tnx DL6RAI.
- Summary wnd (Alt-S) : Displayed bands can be selected. This selection is in sync with the Check Callsign (F9), the Check DXCC (Alt-M), the Check Mult (F10) and the Check Zone (Alt-Z) windows. Note: It's only a display selection to save space : You can still QSY and enter Q on the hidden bands. And all bands are taken into account in the summary totals.
- 60m band added for the DXPed HF logs. NOTES:

1) Considering the various freq allocations depending on the country, a minimal band plan has been implemented in the Default band plan. You can modify it, according to your needs. Your custom band plans (if any) must be updated as well.

2) DXPed log files containing 60m QSO can't be read with previous versions of Win-Test. Tnx DL6RAI for testing.

- NAQP : Mult list and various other things updated according to the new rules. Tnx KL9A.
- ARRL 10m contest : Following the new rules, the multiplier "DF" is changed to "CMX". Tnx N6TV, N5KO.
- Lua : wtQso:GetData API : Gridsquare added in the table returned. Tnx N6TV.
- If a station type is sticked, its type is checked against the rules of a newly created contest file, and can be forced to the default Run type if needed. Tnx N6KI and N6TV.

## Release information (4.23.0) (October 21, 2016)

### Bugfixes

- WAG DX side : The NM exchange (Non Member) was considered as a N multiplier.
- Alt-F4 : The the CAT activity has now decreased , and the function was broken for mixed-mode logs. Tnx N6TV.
- Entering any text command in Secondary Radio Window moved it to the wrong band. Tnx N6TV. (Task #370/373)
- WAE : Under some circumstances, the log and QTC backup files were corrupted. Tnx F5LIW.
- VHF+ contests : When a gridsquare of a logged QSO was modified, the points weren't correctly computed on the other networked computers, leading to a score difference between them. Tnx DL8AAU.
- Under some circumstances of simultaneous log openings on different machines in a network, Win-Test could crash. Tnx W9PA @ K3LR.

### New Features

- Split Freq dlg : Now accepts offsets from the current frequency. E.g.: If your freq is 7020 and you enter +1.1, the split freq will be adjusted to 7021.1. Negative values (-1.1 for ex.) also work.
- UK/EI DX contest added. Tnx SQ8N.
- Secondary Radio wnd : Columns headings added. The color can be adjusted with the Colors (contextual) menu. Tnx N6TV.
- Radios : FT891, FTDX1200, FTDX3000 and FTDX5000 added. Tnx N6TV.
- WAE Phone : DX side : The INS and CR keys and buttons are now enabled in the transmit QTC dialog. The CR button tags the current QTC as sent. The INS button does the same, and makes the next QTC as the current one. It clearly makes the QTC transmission much easier to follow. Tnx F1HAR.

## Release information (4.22.0) (August 26, 2016)

### Bugfixes

- WAEDC : DX side CW / SSB : The potential QTC weren't displayed in the radio wnd (bandmap or list) despite the option was checked.
- WAEDC : The left and right arrows now work correctly in the dialog to chose the number of QTC to send.
- QTC transmit dlg : The active QTC wasn't correctly highlighted when using the Ctrl-Fx buttons.
- The default Check Partial / N + 1 file for VHF contests was HF.DTB instead of VHF.DTB. Tnx DK5KMA.
- When 4.20 and 4.21 were on the same LAN (not recommended), with sync enabled, 4.21 was hanging. Tnx N6TV.
- IARU HF : If an HQ was only 2 characters long, it was ignored.

### New Features

- WAE CW : DX side : The CW speed used when sending the QTC is now preserved between sessions, and the Rate wnd is updated accordingly. No need to juggle with Alt-F9/F10 anymore.
- Callsign Wnd (F9) : Tooltip more readable.

- New behaviour of the \$NEXT variable in the QTC transmit messages to make life much easier (and less confusing) for the DX stations in the WAEDC CW contest.
  - ◆ \$NEXT must be the first variable in the Ins message. The default message is now: \$NEXT \$DONE \$TIME \$CALLSIGN \$SERIAL
  - ◆ Update your current message if it is not up to date
  - ◆ When \$NEXT is executed, the active QTC jumps to the next one ONLY if the current QTC has been already sent.
  - ◆ With this new behaviour, the usual QTC transmission sequence is now:
    - ◇ Ctrl-L / Enter (or 1 to 9) to chose the number of QTC to send (usually 10).
    - ◇ After the QTC dlg shows up, exchange the QRV? and the QTC series number with the recipient.
    - ◇ From now, hit Ins for every QTC to send, one after the other.
    - ◇ If the receipient requests a full resend of the QTC just sent, use CR. If he requests an individual field, use the appropriate Fx key or button. If the QTC is ack'ed, use Ins to send the next one.
    - ◇ When all QTC of the series have been sent (and acknowledged), use Ins one last time (or Plus) to thank and save the QTC series.
  - ◆ In these conditions, you normally shouldn't need to use the Up/Down arrows anymore unless exceptional circumstances.
- CW and RTTY : New \$RAWSERIAL variable. Sends the serial number of the QSO with leading zeros and without any abbreviation. Now used in the default F3 msg (if it applies) to repeat the serial in a more traditional way. It also works in the QTC messages.
- Script manager dialog : Ctrl + Double click on a script brings up the properties dialog.
- IOTA contest
  - ◆ If the IOTA ref is pre-filled from the callsign field content, the new IOTA warning is now displayed if applicable. Tnx F5LIW.
  - ◆ EXPERIMENTAL : Separate numbering for Multi-One and Multi-Two categories : The RUN or RUN1 stations use a sequence of odd numbers (starting at 1), and the MULT or RUN2 stations use a sequence of even numbers (starting at 2).
  - ◆ Multi-Two category added. Tnx G3WVG.
  - ◆ The WAE entities list is now used to prefill the island reference more accurately (ex GM/s stations). Tnx N6TV.
- The DVK bargraph can now be horizontal (default) or vertical.
- Internal DVK : The first and last 100 ms of the messages are now truncated to prevent the keys and mouse clicks to be heard. Tnx SM5AJV and N6TV.
- RTTY shortcuts buttons are now a bit thicker to accommodate older eyes. Tnx SP5GRM.
- Additional CW and RTTY variables :
  - ◆ \$LOC4 and \$GRID4 are equivalent to \$GRIDFIELD.
  - ◆ \$LOC6 and \$GRID6 are equivalent to \$GRIDSQUARE or \$LOCATOR.

## Release information (4.21.0) (June 27, 2016)

### Bugfixes

- The CW "No sound" menu item state wasn't consistent with the CW sound status.
- The check mark on Options / Disable Log Sync wasn't consistent when no log was opened.
- The station name displayed in the network error dlg when several masters were on the same LAN wasn't correct.
- Gridsquares map window (Alt-L) : Mouse wheel actions were broken since version 4.7.0 !
- Stew Perry contest was using VHF.DTB instead of DEFAULT.SCP. Tnx N6TV. (Task #184).



## Win-Test Wiki

- Serial communications : Under some circumstances, especially with some USB drivers under Windows 10, the inbound stream was not correctly processed. Tnx Jan @ remoterig.com
- Voice keyer (DVK) : Under some circumstances, some audio output devices may miss in the Interfaces settings dialog.
- French Championship : QSO with FT entities are now credited with 15 pts instead of 6. Tnx F4SGU.
- Remote dlg : The text command is now limited to 13 chars, to comply with the log entry field. Tnx N6TV. (Task #368)

## New Features

- Lua API version string is 1.3.0
- IARU HF : Duplicate HQ abbreviations are now managed. (Task #350)
- The login / logout protocols can be now disabled as the other ones in the advanced network settings.
- Log Sync : Better overall performance. Tnx DJ7TO, DL5MLO and the DA0HQ team.
- Cabrillo Options : New options similar to the File / Clean file options, but the QSO exclusions (or editions) are \*only\* temporary for the Cabrillo file output.
- ADIF Options : QSO range added.
- Mult Wnd (Alt-M) : The "hide clean sweeps" and "hide never worked" options are maintained during the text / SYLK copy. Tnx ES5TV.
- Tune dlg : For safety, added a 30-second timeout to automatically stop tuning no matter what.
- Stew Perry Challenge : Added for March, June and October.
- Lua : wtQso:GetData API : stnName and stnFlags added in the table returned. Tnx N6TV.
- CW Auto Send : Updated to allow its use when both radios are in RUN mode. Tnx SM5AJV, N6TV.
- Lua : wtApp:TextCommand updated to add strStation and nNotificationID arguments. Tnx N6TV.
- Standard and additional messages : New import / export features. Tnx N6TV.
- Clean log dlg : New option to remove 0 points QSO from the log. Tnx K3LR, N6TV.
- Radios : IC-7300 added. Tnx N6TV.
- CQ WPX RTTY : M/S entrants are now allowed to 10 band changes. Tnx EC1KR.

## Release information (4.20.0) (January 17, 2016)

### Bugfixes

- ARRL 10m : Tools / Check Bad Exchanges was broken.
- Under some circumstances, the default contest log names were broken.
- ARRL SS : Correct label for the sections field.

### New Features

- Radios : IC-7600, IC-7800, IC-7850, IC-7851 : New code for a better management of these radios. It requires the latest firmwares. Tnx N6TV, K3LR, K9LA (Icom America), ICOM France, HRO Sunnyvale (CA), AA6W and K6SSJ.
- Radios : FT-991 added. Tnx N6TV, SP5IOU.
- Radio Wnd : New option to enable / disable the RIT display, when applicable. Tnx F5LIW, K3LR.
- PACC contest : Rules 2016. Dutch provinces (for non-PA) and DXCC and call areas (for PA) now count as mult per band and per mode when taking part in Mixed category. Tnx PA5M.
- French Championship : Rules 2016 applied. Tnx F5LEN.
- Radio Wnd : Ctrl-Up / Ctrl-Down in the list view doesn't lose cursor when a Q is entered. Tnx K5KG. (Task #364).

- LZ DX Contest : New rules 2015 for LZ stations applied. The only limitation is the 10-min rule for the M/S station, which is always applied for band \*or mode\* change, independently of the status of the station (RUN or MULT). Tnx LZ2CJ.
- ARRL SS : Default CW msgs updated. Tnx W2GD, N6TV.
- ARRL SS : Added new message variable \$PREC (precedence) for the ARRL Sweepstakes, automatically determined from entry class and power level. Tnx N6TV.
- Log check reports : QSO with own callsign are now ignored. Tnx FY5KE.
- Status wnd (Alt-J) : X-min rule timers now ignore QSO with own callsign. Tnx FY5KE.
- Check country wnd (F10) : QSO with own callsign are now ignored. Tnx FY5KE.

## Release information (4.19.0) (October 15, 2015)

### Bugfixes

- SAC contest : This contest wasn't displayed in October if the "This month only" checkbox was enabled despite the SSB leg takes place in October. Tnx F5LIW.
- Rate Wnd (Alt-R). Various QSO rate statistics were wrong. Tnx CT1BOH.
- FT1000 : The TRX was switched to RTTY-USB for high bands instead of RTTY-LSB. Tnx DL6RAI @ P49V.

### New Features

- CAUTION: New network protocol version 1.29 released. Reminder: If you use WT in a networked environment, you must have the same WT version on all machines!
- Status Wnd (Alt-J) : Best effort to display the TX freq of the radios. Radio brand and model dependent. Tnx N6TV. Note : Icom users will need the latest Icom firmware, and the latest OmniRig rig definition files (check the N6TV files) to get chances to see VFO B displayed for Icom radios, especially if they want to use split mode.
- Experimental : VHF+ spots : When the comment is using the "Locator<Prop>Locator" format, the second locator is now considered as the DX locator. Tnx G3ZAY, F5HRY.
- Radio Wnd : Spot mode (according to the used band plan) added in the tooltip text.

## Release information (4.18.0) (September 25, 2015)

### Bugfixes

- NA Sprint : Tools / Check log / Search for possible bad exchanges was broken. Tnx N6TV.
- Rate Wnd (Alt-R). Various QSO and Mult statistics were wrong. Tnx CT1BOH.
- REG1TEST : The mode code is now output in the QSO records. It can be optionally omitted for contests where the mode is not stated in the rules, in accordance to the REG1TEST format specifications.
- WAEDC : The 10-min violations check was performed on the RUN and MULT stations, while this rule only applies to the RUN stations. Tnx DL1EKC.
- Partial (F12) and NP1 (F8) windows : While modifying an already entered QSO, the callsign of the original QSO wasn't correctly ignored during the searches. Tnx FY5FY.
- WAE : Receiving QTC : If the callsign of the QTC sender was modified, and the receiving dialog was cancelled, the modification remained.
- The Win-Test version number is no more extracted from the language file DLL, but rather from the exe itself, to get the correct string when having multiple Win-Test versions in the same directory. Tnx

F5TTU, F6BGC.

- When used in a network environment, a QSO entered on the secondary radio had a wrong serial number on the other machines of the network. Tnx DL5AOJ.
- Radio wnd : Under some circumstances, when your own callsign was entered in the bandmap (Ctrl-Enter), it was displayed as a new mult. Tnx TM0HQ.
- The action on Options / Disable Log Sync wasn't consistent when no log was opened.
- Toolbar : The tooltip text for the summary icon was missing since the very first version of Win-Test ! ;-)
- Bugfix : Alt-F dlg : Under some circumstances, the QSO op. was not specified.

## New Features

- WAE : Receive QTC dlg : Received serials are now formatted with leading zeroes if needed. Tnx F5LIW.
- WAE : Receive QTC dlg : Received times with 2 numbers (minutes) are now set to the correct hour according to the received time of the previous QTC. Tnx F5LIW.
- Radios : IC-7100 and IC-7200 added. Tnx N6TV.
- Cabrillo output file (v3) : eMail address tag added.
- Cabrillo output file (v3) : New option to indicate if you wish to receive, if eligible, a paper certificate sent via postal mail by the contest sponsor. The contest sponsor may or may not honor this tag, and if so may or may not use opt-in or opt-out as the default.
- Cabrillo output file : New option to output the "alternate" frequency for split QSO. May be useful if the available CAT data for your radio can't be used to determine accurately the TX freq vs the RX freq.
- Several specific installers lacked the installation of the msflxgrd.ocx library. Tnx F5UPO.
- CW : SOUND/NOSOUND and associated menu items : This option is now always disabled when Win-Test runs under an operating system after Vista included. It means that it will not work for those OS, and \*may\* work on previous OS, depending on the hardware. In all cases, it is very recommended to rely on the TRX internal sidetone instead.
- WAEDC : The SAVELOG, COPYLOG commands and the automatic backups now include the QTC files. Tnx GW3SQX @ GW7O.
- ARRL DX, ARRL 10m and ARRL 160m contests : The Cabrillo output files are now compliant with the v3 specs. Tnx F5PHW.
- Edit menu : New item : Apply exchange to every QSO with...(Ctrl-F10) When applicable, it allows to update exchanges of every Q whose the callsign is identical to the callsign of the current Q, with the exchange(s) of this Q.
- Gab Wnd (Alt-I) : New contextual menu item to clear the content of the window.
- Cabrillo file : Win-Test now ensures the operators list is correctly space-delimited.
- The protocol version is now displayed in the Advanced Settings dlg of the network.
- Status Wnd (Alt-J) : When using a multi-op network, you can now send a remote command to a specific station by opening the context menu on this station name and use "Send remote command to XXX...".
- COPYLOG command : Notification added. Tnx TM0HQ.
- Ctrl + PageUp / PageDown now browses the log by 12h steps instead of 24h initially. This makes it usable for 24h long contests.
- Status Wnd (Alt-J) : When using a multi-op network, you can now ping a specific station by opening the context menu on this station name and use "Ping XXX". The Win-Test version, the Master, Bridgehead, Sync indicators and the propagation time are returned in the Gab window (Alt-I).  
Reminder : You can use the INV (stands for Inventory) text command to get a summary of the complete network.

- Enhanced replies to the inventory command (INV) with a log sync enabled indicator (S vs s).
- IARU HF : Mult wnd (F10) : AC, R1, R2 and R3 labels updated.
- Contest settings dialog : To prevent any side effect (especially with the network), the syntax of the station name is checked, and 'exotic' characters are replaced by an underscore if needed. Tnx F1UVN @ TM0HQ.
- Alt-F dlg : The read-only station name field is now disabled.

## Release information (4.17.0) (June 30, 2015)

### Bugfixes

- The ODX per band were sometimes wrong after band modifications of specific QSO. Tnx F1PKY @ F5KMB.
- IARU 50 MHz (and higher) contests : The Psect field of the output files are now in accordance to the REG1TEST specs. Tnx F2DX, OK2ZI.
- MP3 configuration dialog : Under some circumstances, an error loop could occur. Tnx DL6RAI. (Task #363)
- FT2000 : Under some circumstances, read frequencies were not consistent. Tnx F8DBF, F4DXW.
- For some contests, a QSO entered with your own callsign didn't count 0 points. Tnx N6TV. (Task #362)
- MP3 QSO extract : There was a few seconds offset in the recording.
- SP DX contest : When provinces were displayed with the "all bands" option \*and\* alphabetically, the "Z" province was missing. Tnx DL6RAI. (Task #360).

### New Features

- CAUTION: New network protocol version 1.28 released. Reminder: If you use WT in a networked environment, you must have the same WT version on all machines!
- Status Wnd (Alt-J) : New column for the current op. added. Cf OPON/OPOFF or LOGIN/LOGOUT commands or use nicknames. Tnx ES5TV.
- Set QSO freq dlg (Alt-F): Swap main / QSX freq button added.
- Rate Wnd (Alt-R) : When entering in a category where modes can be mixed, the elapsed time between band changes now takes account of modes as well.
- CQ-M contest : To be compliant with the new rules 2015, there is no more multiplier station, even in M/S. Tnx RU3DNN.
- ARI contest : A station can now be set as a MULT station. The 10 min timer in the Alt-J wnd considers band and mode changes. Tnx ES5TV.
- OK OM DX : Win-Test is now adapted to comply to the new SSB rules. To make things easier, the CW leg is kept unchanged ! Read carefully the rules before entering. Tnx ON5GQ.
- Contest recorder : QSO extraction to a mp3 file : The QSO extraction parameters are now (1) the time before the QSO was `_STARTED_` (0 sec by default - it means the clip starts at the same time when you listen to the QSO with AltGr-Enter) and (2) the time after the QSO was `_ENTERED_` (10 sec by default). Tnx ES5TV.
- ARRL DX and ARRL 10 : When exporting logs in ADIF, the DC "state" is replaced by MD. Tnx F8ATS.
- Lua : `wtScript:AssignArgument` now takes the strings "true" and "false" as boolean arguments. Numeric values do not require double quotes. Tnx N6TV.
- Script manager : Properties dlg : Now accepts a default argument even if no key is defined for the script. But, in any case, a key or a text command must be defined to allow a default argument. Tnx N6TV.

## Release information (4.16.0) (Mar 17, 2015)

### Bugfixes

- REF HF : FS now does count for a French dept instead of a DXCC entity. The final scores were not affected by this bug. Tnx F4EJL.
- If the default directory at launch time wasn't the app directory, the automatic starts of wtDxTelnet and wtRotators were failing. Tnx F5LIW.
- Ctrl-Del (delete spot from bandmap) was broken. Tnx N6TV. (Task #354)
- Network advanced settings dialog : The last outbound protocol was always enabled, despite its setting. Tnx F1HAR.
- Common prefixes to GM and GM/s were considered as GM even if the WAE list was used. Tnx N6TV. (Task #355)

### New Features

- Spanish and German translations updated. Tnx EB2RA and DL6RAI.
- LUA : Because of a conflict name with the wtScript class, the wtScript variable (name of the Topmost script) is now replaced with wtRootScript. Tnx N6TV.
- RDXC : R7K - Crimea (RK) and R7R - Sevastopol (SE) added to the mults list. Use the latest CTY\_OBL.DAT accordingly. Tnx RU3DNN.
- Lua : wtContest:GetMyCallsign() and wtStatus:GetMyStation() added. Tnx N6TV.
- Registration dialog : The QR codes of the registration URL are enlarged.
- ICOM radios : IC-970, IC-9100 and IC-7850 added. Tnx OK8WW, EA8RM and K3LR.
- ARRL DX (DX side) : To strictly comply with the current rules (section 5.2.2), the PEI multiplier (VY2) is now labelled PE. The STATES.DAT is also accordingly updated on the usual repository <http://download.win-test.com/files/equivalence/> .
- NA Sprint : Because of the different multipliers per leg, the equivalence files must now be NA\_SSB\_SPRINT.DAT and NA\_CW\_RTTY\_SPRINT.DAT. They are available on the usual repository <http://download.win-test.com/files/equivalence/> . Tnx KD4D and N6TV.
- NA Sprint : DC and the usual 14 Canadian provinces and territories are now considered as multipliers for the Phone leg (the MAR mult. is no longer used). Tnx KW8N.
- UBA DX : Mult stations are now allowed for Multi-Op (Single TX) entries. Also, the 10-min timer for RUN stations is now displayed in the status window (Alt-J). Tnx RU3DNN.
- NA Sprint : KL stations are now considered as US stations and their state (AK) is now in the states list. KH6 stations are also considered as US stations for the Phone leg, and their state (HI) is now in the states list. During the CW / RTTY legs, KH6 stations are considered as DX stations (not NA). Tnx N6TV.
- ARRL 10m : Mixed mode category forced in the Cabrillo output for the M/S entries.
- Script properties : Tooltip added over the key edit field with the key code and modifiers values. It can help for the wtScript:AssignKeyCode function. Tnx N6TV.
- Scripts manager : Run button added. The selected script is run the same way as if it were run by the assigned key (if any), and with the argument set in the properties dialog (if any). Tnx N6TV.
- Lua : wtScript:AssignFKKey and wtScript:AssignKeyCode functions added. Tnx N6TV.
- Script Manager : Error message added when the SciTE or the script editor weren't correctly installed or configured. Tnx DL6RAI.
- New CW and RTTY variables introduced : \$GRAB1 to \$GRAB9 to grab from the partner stack slots, and \$GRABRT1 to GRABRT3 to grab from the partner realtime slots.

## Release information (4.15.0) (Nov 22, 2014)

### Bugfixes

- When a voice message contained several script calls in a row, only one out of two was executed. Tnx N6TV.
- ARRL SS : When a callsign is grabbed, the cursor is now set to the serial field. Tnx AC6T, N6TV. (Task #353)
- When not using advanced SO2R with Shift bound to the secondary radio, Shift-Enter now has no action. Tnx N6TV.
- Partner window: The SUPPORT / NOSUPPORT (or PARTNER / NOPARTNER) commands didn't resize the window properly.
- Partner window context menu: The "Remove" item was enabled for empty slots while it was supposed to be grayed.
- Partner stack: If the same callsign was in two adjacent slots in the Partner stack, only one of them was cleared when the callsign was entered in the log.

### New Features

- CAUTION: New network protocol version 1.27 released. Reminder: If you use WT in a networked environment, you must have the same WT version on all machines!
- Contest recorder : AltGr+E shortcut added as "Extract and Save QSO". Tnx N6TV.
- LZ-DX contest : 10 min. CQWW DX rule applied to the M/S entrants, but currently limited to the band changes (the mode changes are ignored). Tnx RU3DNN.
- Partner : There are now two different colors for data entered as Run or as Support. Useful when there are several partner positions for one run. Tnx F5HRY@TM0HQ.

## Release information (4.14.0) (Oct 19, 2014)

### Bugfixes

- When several mp3 record files from different stations for a given contest were used, the rewind and forward functions led to a crash. Tnx DL8AAU@DR9A.
- Radio wnd: When using a Windows font size option different from 100%, the VFO displays didn't scale up well. Tnx N6XI, N6TV.
- Lua: An error occurred when calling a script with the double-quote key. Tnx N6TV.
- RDAC: The Tools / Check log / Search for bad exchanges function was not working for the RDAC contest. Tnx SP5KP
- In the Alt-M wnd, when data were ordered by number of worked bands/modes, and never worked mults were hidden, the sweep clean mults were always displayed, despite this option was set or not. Tnx CT1BOH.

### New Features

- CAUTION: New network protocol version 1.26 released. Reminder: If you use WT in a networked environment, you must have the same WT version on all machines!
- New notes file format and network protocol to ease log corrections within Win-Test. Check the new last items of the Tools / Check log menu.

- Partner: New properties dialog to set the various options. By default, the realtime keystrokes network transmission is disabled when switched to the S&P mode. It can be enabled by choice in this properties dialog. Tnx TM0HQ & N6TV.
- IARU HF: A '?' indicator is now displayed when the received exchange is not an ITU zone, AC, R1, R2 or R3, or not composed of letters only.
- New option in Tools / Check log / Search for bad exchanges, to detect exchanges discrepancies in the log only.
- Merge report redesigned: All conflicts are ordered by time and also by station name.
- The Date/Time dialog (Alt-F) now indicates the station who entered the QSO. Not editable. Tnx F8CRH@TM0HQ.
- New Goto Callsign edit menu (Shortcut Shift+Ctrl+G) to set the cursor on a QSO with a given callsign. By default, the callsign of the current QSO is searched. If it is empty (i.e. if the cursor is set to the last (empty) line of the log), a dialog is opened. The search is done backwards.
- New CW option to enable/disable the speed bursts (+/-) without modifying the messages. Text commands are BURSTS / NOBURSTS. Useful to defeat CW skimmers on-demand.
- Interfaces setup dialog: The lists for each COM port are now reordered to comply with the most current needs.

## Release information (4.13.0) (Jun 30, 2014)

### Bugfixes

- REF DDFM 50 MHz contest : Default CW msgs were using \$GRIDSQUARE (6-char locator) instead of \$GRIDFIELD (4-char locator). Tnx F2DX.
- Gab window (Alt-I) : If the content was scrolled back, a double-click on a line set an incorrect default recipient in the opened Gab/Talk dialog. Tnx F8CRH@F6KRK.
- REF VHF contest : Win-Test was asking for the "departement" in the contest settings dialog (was useless), and the help dialog was inappropriate. Tnx F5HRY.
- CQ-M contest : Contest identifier for the Cabrillo and ADIF output files were misspelled. Tnx RU3RQ. (Task #348).
- WPX : The prefix of VY2MGY/3 now resolved as VY3. Tnx N6TV. (Task #347).
- Bugfix : Lua : wtApp:CallScript(name, arg) was always casting arg to a string. Tnx N6TV.

### New Features

- EF6 added as a valid exception callsign. Tnx F6FDR.
- Radio windows - List view : In the "Sort by Mult Type" view, the non-mults stations are now sorted by QSO points in descending order. Tnx G3WW.
- Radio windows - List view : New sorting option by QSO points in descending order, irrelevant of mults, added. Tnx G3WW.
- WRTC 2014 and IARU HF : Check multiplier wnd (F10) : New label for HQs "entities" to prevent confusion with DXCC entities. Tnx CT1BOH.
- Log : The column header of the serial sent (if any) is now correctly labeled ("No."). Tnx N6TV.
- Options / Log / Align exchanges : New option to line up received exchanges in mixed mode. Tnx N6TV.
- WRTC 2014 : Worked Mults wnd (Alt-M). The "copy as text" menu item is now enabled. Tnx CT1BOH.
- WRTC 2014 : /MM stations are not counting for DXCC entity, and are credited depending on their ITU zone. Tnx KM3T.
- WRTC 2014 : The country list used is DXCC (not WAE). Tnx KM3T.

- WRTC 2014 : In the contest configuration dialog, the zone is set to 8, the Gridsquare is set to FN42fg and can't be modified.
- The very singular 7QNL (and future 7QAA) callsigns are now accepted. Their prefixes are also resolved as 7Q0. Tnx PA3FYM.
- Lookup function for the DXCC entities resolver refactored to allow easier extension for cases like the newly introduced 4Y1A and C7A, when callsigns are assigned to two entities.
- RTTY : Fields assignments updated for the NCCC Sprint. Tnx AA2MF.
- King Of Spain contest : SMR multiplier added. Tnx EA4TX.
- Marconi HF : New points rules applied. Tnx IK6BAK.
- Lua : In CW, when chaining wtKeyer:Play() instructions, the word space between the string arguments will be omitted if they end with a "~". Example :

```
wtKeyer:Play(string1)
wtKeyer:Play(string2)
```

Will omit the word space between string1 and string2 if string1 ends with a "~". Tnx N6TV.

## Release information (4.12.0) (February 10, 2014)

### Bugfixes

- UBA DX : The format of the output cabrillo file didn't stick to the required specs. Tnx ON5GQ.
- DARC 10 : Under some circumstances, the DOK field was cleared while it wasn't necessary. Tnx DJ4MZ.
- Lua : The wtApp:CallScript function was always returning a nil value when used with two parameters. Tnx N6TV.
- The log sync enables / disabled setting was not correctly saved between logs openings. Tnx DK9TN@ED6A.

### New Features

- DARC 10 : The NM exchange (Non Member) is no more considered as a multiplier. Tnx DJ4MZ.
- Radios : IC-7410 added. Tnx DL6RAI.
- Script Manager : Various UI enhancements and API bugfixes. Tnx N6TV.
- Clear Log : The station type (RUN, MULT, etc.) setting is now preserved when this function is performed. Tnx DK9TN@TK4W.
- Network : Time distribution : A warning now pops up when time sync frames are received, and the Windows user who started Win-Test hasn't enough privilege to modify the system clock. Tnx P40L, N6TV.
- Lua : wtQso:GetData() returned table updated for the specific ARRL Sweepstakes contest. The QSO# received is in the "rstReceived" index, and the Precedence letter is in the "miscInfo2Received" index. Tnx N6TV. (Task #338).
- Mult Window (Alt-M) : New "Hide never worked" option added. Pretty experimental for now, depending on the contest. Tnx CT1BOH.
- Radio windows : The spot selected by a right click is now highlighted to prevent confusion. The highlight color calculation now also works for dark hues. Tnx AD1C@K0RF.
- Stats window : In CQWW DX, the zones / overall display was clipped to the last hour when a new zone was worked.
- Radio windows : Time / Spotter and Comments display options added in the list view. These settings are common to both views. Tnx CT1BOH.



## Release information (4.11.0) (October 20, 2013)

### Bugfixes

- CQWW RTTY : The check log tool for the number of allowed QSY per hour in M/S was broken. Tnx DL9YAJ @ DR5N.
- Frequency offsets weren't always correctly processed, especially on the secondary radio. Tnx DL5AOJ.
- Extra Data files : Depending on the newline character(s) and other various parameters, the displayed data could be incorrect. Tnx IK0HBN, N6TV.
- When a log was entirely entered manually, the date of QSO wasn't correctly set when using the "<" or ">" keys to access and fill the time field. Tnx F5LEN.
- Under some circumstances of startup order and various settings, a "20 days older or newer log" false alert might be triggered. Tnx F6BGC @ TM0HQ.
- RDAC Contest : Exchanges for callsigns ending with /x (x = 0 to 9) are now searched in the database and the log. Tnx SP5KP.
- AGCW HNY : The (optional) AGCW membership number entry field was emptied when it was not supposed to be ! Tnx DJ0ZY.
- Displayed ODX inconstancy under some circumstances when a QSO was deleted. Tnx DL6RAI.
- RAEM : The coordinates entry field was emptied when it was not supposed to be ! Tnx DJ0ZY.
- When using the GOTO function by entering a QSO number and Ctrl-G, the pattern analyser warning message (if any) is now cleared.
- The modifications entered into the Freq Offsets dialog are now taken into account immediately. No need to reload the current log. Tnx YL2GD.
- When using a K3, changing band by entering its wavelength was sometimes setting the wrong LSB/USB mode. Tnx M0VFC (Task #326)
- Under some circumstances, a random character could be entered in the Info field in a DXPed log, when using the Up/Down arrows in this field.

### New Features

- Networking : Sockets initializations updated to comply with the usage of Win-Test in a Linux / Wine environment. The wtCom.dll must be updated (v2.0.4 or better) as well for this usage if needed. Tnx AA6KJ.
- ADIF
  - ◆ output : Addition of the CREATED\_TIMESTAMP field in the header, and the CONTEST\_ID field in every QSO record, when applicable.
  - ◆ Export : The ADIF country code is now added to the QSO record. Requires using the latest CTY\_WT.DAT or CTY\_WT\_MOD.DAT country files (02 August 2013 or later). Tnx AD1C.
- CQWW DX Contest
  - ◆ The overlay "Classic" category has been added in the contest configuration dialog. It only adds the appropriate line in the Cabrillo output file.
  - ◆ The overlay category Xtreme is added in the contest configuration dialog, and in the Cabrillo file output as well. Tnx KL1A.
- WAE Contest
  - ◆ The special calculation for the creation of the offtime section in the Cabrillo file has been removed, being now obsolete. Tnx DL6RAI.
  - ◆ Offtime threshold is now set to one hour.
- Lua

- ◆ wtQso:GetData() function added. Returns a table with fields of the current Qso. The current available keys are "time", "band", "mode", "freq", "callsign", "rstSent", "serialSent", "rstReceived", "exchReceived", "miscInfoReceived", "miscInfo2Received".
- ◆ wtApp:GetLogFileName() and wtApp:GetIniFileName() functions added. Tnx N6TV.
- UFT contest : Win-Test is now adapted to the new rules 2013. Tnx F6CEL.
- YU DX contest : Totally rewritten because of the new rules 2013 (see <http://yudx.yu1srs.org.rs/2013/rules.html>). Tnx YU0W and F5IN.
- SPDX Contest : The "12 band or mode changes per one clock hour" rule is now implemented. A simultaneous change of band \*and\* mode (Ex: 80m CW -> 40m SSB) counts as 2 changes. Tnx SQ2GXO.
- New Tools / Data entry / Priority / Callsign option to ignore any freq or band changes when entering digits only in the callsign field. Tnx P40L, N6TV.
- RAC Winter and Canada Day Contests : The 10-minute rule for the multi-single entrants is now implemented. Tnx VE3JM and N6TV.
- Russian 160 meter : New rules implemented.  
<http://www.radio.ru/cq/contest/rule-results/index2012.shtml>. Tnx RZ3DX.
- QR Code added in the registration dialog to help mobile phones users.

## Release information (4.10.0) (October 23, 2012)

### Bugfixes

- YO DX Contest : The child and log windows are now compliant with the chosen mode category (CW, SSB or MIXED). Previously, the mixed mode only was assumed.
- NAQP : The K8 mark for "zones window" (Alt-Z) was labeled K81 instead. Tnx NX5M.
- Text and CSV files options dialogs : The Del key was acting as "Remove all" instead of "Remove".  
Reminder : Shift-Del acts now as "Remove all", Del acts as "Remove", Shift-Ins acts as "Add all" and Ins acts as "Add". Tnx TM0HQ.
- In the logfile fixing process, the backed up file had a wrong file extension (it was always .wtb). Tnx TM0HQ.
- Status wnd (Alt-J) : Not always correctly ordered when sorted by freq/name. Tnx TM0HQ.
- CQ VHF and CQ 160 : ARRL Section added in the Cabrillo output file for US/VE entrants (Task #323). Tnx W9ZRX & N6TV.
- FT1000(D) : The IF filter setting is retained per mode when grabbing a spot. Tnx DL6FBL @ DR1A.
- Under some concurrency circumstances in a multi-op environment, Win-Test could crash when deleting or modifying spots in the Alt-A or the radio wnds (Task #318). Tnx N6TV.

### New Features

- ARRL Sweepstakes, ARRL FD and ARRL 160 meter contests : ARRL/RAC sections list updated to comply with the four new RAC administrative sections (ONN, ONS, ONE, GTA), replacing the split Ontario Section. (Task #321)
- Auto CQ : New option in the appropriate dialog to halt the auto CQ with the Esc key only. Equivalent text commands are RPTESCONLY and NORPTESCONLY. Tnx N6TV.

- ARI Sezioni: Cabrillo output compliant with rules 2012. Tnx I2WIJ.
- ARI DX : Cabrillo output compliant with rules 2012. Tnx I2WIJ.
- IOTA : New rules 2012 implemented :
  - ◆ For multi-op (island) stations, display of Band/Mode changes in the rate window (Alt-R).
  - ◆ Cabrillo file : QSO lines now include RUN or MULT identifiers.
  - ◆ The score for World to World QSOs is reduced from 3 points to 2 points.
  - ◆ Island Stations now receive 5 points for World Station QSOs.
  - ◆ Island Stations now receive also 5 points when working their own Island.
- RDXC : Oblasts window (Alt-Z) updated following the new list 2012. Tnx HA1AG, SP5KP, F5IN.
- Check partial (F12) and NP1 (F8) wnds : The [UNIQUE] word has now its own background and text colors to draw the attention of the operator. Tnx CT1BOH.
- JIDX : Cabrillo file : QSO lines format updated to comply with the new format specifications for the multi-op category. (See task #317). Tnx N6TV.

## Release information (4.9.1) (October 27, 2011)

### Bugfixes

- Fix an issue with missing resources which might make WT to crash.

## Release information (4.9.0) (October 26, 2011)

### Bugfixes

- Problem in Spanish language file fixed. Tks N6TV.
- The exceptions callsigns of the CTY\*.DAT files were wrongly parsed when operated from another DXCC entity (ex. W6HGF/KH0). Tnx JE2UFF.
- During a Cabrillo import, if the format of the QSO line wasn't correct, the error message was off one on the QSO number. Tnx W6IZT.
- IARU HF contest : The mode entry was empty in the output Cabrillo file for multi-op categories. It is now set to mixed. Tnx F1HAR @ TM0HQ.
- The Kenwood radio protocol was broken when sending CAT commands with frequencies above the 3420 MHz band. Tnx W8ZN.
- Task #310 : IARU HF contest : For US/VE stations, the ARRL section is now required, instead of the state or the province. Tnx N6TV.
- Entering your own callsign in the bandmap (Ctrl-Enter) was displaying a "spotted by..." alert. Tnx F5JSD @ TM0HQ.

### New Features

- When a new file is created, the usage of a network drive is checked and strongly discouraged to prevent log inconstancy. Tnx VK8DX @ 4W6A
- WAEDC : Time shift can now be applied to the QTC. Tnx DL8RDL.
- NCCC Sprint : New rule 2011 : 15m QSO are now permitted. (See task #312). Tnx N6TV.

## Release information (4.8.0) (June 26, 2011)

### Bugfixes

- Task #308 : JIDX : 160m QSO points counted 1 pt instead of 4. Tnx N6KI and N6TV.
- Under some circumstances, DXped audio recordings were not correctly tagged, the file information dialog was incomplete, and the QSO playbacks failed. Tnx VE3EY @ TO3A.

### New Features

- ADIF : PROGRAMID and PROGRAMVERSION fields added in the file header. Tnx IZ8MBW.
- LPT Interface : 50 MHz, 144 MHz and 432 (440) MHz band data outputs added. Tnx W8ZN and N6TV.
- Callsign check rules : The pathetic 9HOHSJ callsign is now added as an exception (like RAEM, JY1 and TX9). Tnx OH2OT, F5HRY.
- PACC contest : New rule 2011 : QSO are now allowed in each mode for mixed categories. Tnx PA2A.
- RSGB 160m contest : Single-mode CW-only restriction removed to comply with the new rules 2011. QSO and bonuses are now allowed for each mode. Tnx G3XSV.
- NAQP : Cabrillo output : The DXCC prefix is now indicated instead of "DX" for North American stations outside of K/VE. Tnx WA7BNM.
- DARC XMas contest : New rules 2010 : "NM" is allowed as a exchange from the German stations, but is no more credited as a mult. Tnx DJ3WE.
- DX Spots window (Alt-A) : New option to enable/disable logging of the incoming spots in the .dxc file. It is enabled by default. Under some circumstances (slow antivirus inspection, slow HDD, etc.), saving every spot (especially when using the RBN) was making Win-Test less responsive. The op-entered spots are always saved to allow their restoration on log startup. Tnx HA1AG @ ED9M.
- Packet window (Alt-O) : New option to enable/disable logging of the packet stream in the .pkt file. It is enabled by default. Under some circumstances (slow antivirus inspection, slow HDD, etc.), saving the packet data stream (especially when using the RBN) was making Win-Test less responsive. Tnx HA1AG @ ED9M.

## Release information (4.7.0) (December 2, 2010)

### Bugfixes

- Task #300 : WAEDC RTTY : The sent QTC group number was not taken into account by the other connected machines, and therefore the QTC numbering was garbled in M/\* environment. Tnx

DL6RAI.

- Task #266 : WAEDC RTTY : No \*New Mult\* warning. Tnx DL6RAI.
- WAEDC : Number of QTC to send dialog : Even if some buttons were disabled, their associated "number keys" were still active.
- WAEDC : Sending QTC dialog (Ctrl-L) : In "show" context, and if messages were sent under some circumstances, Win-Test could crash. Tnx IW1QN.
- WAEDC : Under some circumstances, sent QTC were not always correctly saved.
- WAEDC : When the number of QTC to be sent is 0 (no more QTC available), all "number keys" and Enter are now ignored in the appropriate dialog.
- Task #298 : Spacebar key didn't always work properly in the ARRL Sweepstakes contest. Tnx N6TV.
- Task #297 : Double-click on Check Multipliers window (F10) didn't work in ARRL Sweepstakes. Tnx N6TV
- Under some circumstances, if data entered in the time field didn't follow the HH:MM or HHMM format, it could lead to a crash. Tnx N6TV.
- WinKey : Speed bursts were not executed if located just before the \$LOGGED variable. Tnx ES5TV.

## New Features

- CW Autosend : Feature temporarily disabled when Alt-Space (grab from the RT partner slot), Alt-1..9 (grab from the partner stack) and Ctrl-1..9 (exchange with the partner stack) are used. Tnx ES5TV, N6TV.
- ARRL 10m contest : New Mexican multipliers added. The name of the database (which is now different from the other ARRL contests) is now ARRL\_10M.DTB. Several XE stations (around 300) have been added in the current file: [http://download.win-test.com/databases/ARRL\\_10M.DTB](http://download.win-test.com/databases/ARRL_10M.DTB)
- MouseWheel actions are now compatible with HiRes optical mice like the Microsoft Wireless LASER Mouse 8000. Tnx W9ZRX, N6TV.
- Bandmap properties : The minimum spot bandwidth is now 0 Hz (!). Tnx SM2WMV.
- IC775 : Force narrow IF filters when grabbing callsigns in CW. Tnx YL2GD.

## Release information (4.6.1) (Released only for demo and DxPed versions)

### Bugfixes

- The default directory name for a "DX expedition (VHF and above)" log was wrong. Tnx DJ4MZ.

- When a callsign was entered by a dbl-click in the N+1 or the partials wnd, and if this feature was set to automatic, the callsign check status wasn't updated. Tnx ES5TV.

## New Features

- COPYLOGCLEAR text command added. Equivalent to the COPYLOG command immediately followed by a CLEARLOG command. Tnx CT1BOH.
- QTC receive dlg : New variable \$QTCROW introduced indicating the QTC line number where the cursor is located. Mainly used in RTTY for asking a resent of a specific line. The default F8 button message is now "AGN QTC \$QTCROW?" in this mode. Tnx DK4WA.

## Release information (4.6.0) (October 24, 2010)

### Bugfixes

- Task #296 : Check mult window (F10) was not updated properly when using in ESM mode with S&P mode selected. Tnx N6TV.
- Under some circumstances, the default filename of a contest log could contain invalid characters. Tnx G0ORH.
- Second zones window : The labels display option was not restored.
- When grabbing a callsign in the RTTY window, the realtime partner window field wasn't updated. Tnx ES5TV.
- Task #290 : On restart, Win-Test didn't remember the last SO2R scenario that was selected. Tnx N6TV.
- WAEDC : QTC receive dialog (Alt-L). Using the INSERT key in this dlg was crashing Win-Test.
- Task #291 : RadioWnd : Ctrl-Up/Down weren't working properly in list mode. Tnx ES5TV.
- Under some circonstances, Win-Test could crash when started with the CapsLock key engaged.
- Advanced SO2R CW messages dialog : The Esc and Enter keys now work.
- WAEDC : Clock wnd : QTC in stock was always displayed for M/S entrants regardless of their location (EU or DX).
- WAEDC : Clock wnd : QTC in stock value was not immediately updated after a Q was received thru the network.
- EZMaster, MK/MKII/... and OTRSP setup dialogs : The Esc and Enter keys were not correctly handled.
- Transmit QTC window (Ctrl-L) : Under some circonstances, the context-oriented background colors were not correctly updated.

## Win-Test Wiki

- WAEDC : After receiving QTC, the potential QTC counts in the bandmaps were not always updated. Tnx DF9LJ.
- WAEDC : Every time a Cabrillo file or a summary file was written, the QTC counts were increased. Tnx DF9LJ, DL6RAI, and several others.
- KCJ : TG (Tochigi) and NR (Nara) multipliers were missing in the Alt-Z window. Tnx F5IN.
- NAC 10 : Exchange sent are now 6-positions gridsquares. Tnx SM6FKF.
- Task #284. Your own call incorrectly counted one HQ if such an exchange was entered. Tnx TM0HQ, N6TV.
- DX cluster (Alt-A) and radio wnds : If the SP or the LP value of the spot was 0Â°, heading was not displayed. Tnx SM5AJV/SE5E.
- Task #282: Under some circumstances the QSO number displayed in the report for possible bad exchanges was wrong. Tnx DF1DX.

## New Features

- CAUTION: New network protocol version 1.25 released. Reminder: If you use WT in a networked environment, you must have the same WT version on all machines!
- The wtArg (and wtArgument) variables are now local to the called script.
- For phone contesting, scripts can be called from the Advanced SO2R scenarios with the #SCRIPT or #@SCRIPT notation.
- Lua scripting: New input API:
  - ◇ wtApp:InputUpperText(Prompt, Title, Default) If Title or Prompt is empty, a default text is used. Typed letters are automatically upper-cased while entering.
- Lua scripting: New wtGab API introduced:
  - ◇ wtGab:Send(strText[, strToStation]) sends a gab strText to strToStation. If strToStation is omitted, the text is sent to the whole network.
- NCCC Sprint : New rules implemented. Tnx K9MMS, N6TV.
- CQWW RTTY : In M/S category, the band changes counts are now displayed for the RUN and the MULT stations in the rate window (Alt-R). Tnx ES5TV.
- Edition keys : To improve the compatibility with CT, Ctrl-B, Ctrl-D and Ctrl-F keys are now processed in the log fields. Tnx N5KO, N6TV.
- WAEDC : QTC receive dialog (Alt-L) : New \$FIELD variable introduced. This variable takes the value "GROUP", "TIME", "CL" or "NR", depending on the kind of QTC field where the insertion point is located.

## Win-Test Wiki

- New CW and RTTY options to work dupes or not. If dupes are worked, the \$QSOB4 variable is ignored. The equivalent text commands are WORKDUPE/NOWORKDUPE or WORKDUPEON/WORKDUPEOFF. There is a different setting available per mode (CW or RTTY).
- Task #205 : The \$RxRy variables located in the end of a CW message, if any, are automatically appended to the content of the \$QSOB4 message if played. Tnx N6TV.
- The \$QSOB4 variable can now include scripts calls.
- The scripts calls in the CW or RTTY messages are now synchronous to the CW or the RTTY streams. To execute them asynchronously, they can be called with the #@ notation. Example :

```
-- script.wts
wtApp:AlertBox("Hello World!");
```

and the CW/RTTY message content is :

```
AAA #SCRIPT BBB
```

The keyer sends AAA, then "waits" until the user hits the OK button in the "Hello World!" alert box to send BBB.

If the CW/RTTY message content is:

```
AAA #@SCRIPT BBB
```

The keyer sends AAA and starts the script (and the alert box is open), \*but\* it continues to key the rest of the message ("BBB") without waiting the user intervention. This is the asynchronous mode.

- Lua scripting : One new wtKeyer API introduced :
  - ◇ wtKeyer:Insert(strMessage) : Works for the CW and RTTY keyers. When used in a synchronous script, it gives the possibility to "fill-in" data into the CW/RTTY message. It is recommended to use it only in the synchronous mode (see above) to ensure data are inserted in the right place. WARNING : strMessage can only contain textual data (no variable or script call). It is \*not\* interpreted by the CW/RTTY parser (except the +/- speed bursts).
- Lua scripting : New wtStatus API introduced :
  - ◇ wtStatus:GetList() returns a table with names of the stations in the network.
  - ◇ wtStatus:GetStatus(strStation) returns a table with fields of the status of a given station. Returns nil if this station doesn't exist. The table keys are "band" "mode" "currentRadio" "radio1Freq" "radio2Freq" "radio1IsManual" "radio2IsManual" "passFreq" "type" and "qsyStatusId".
  - ◇ wtStatus:GetFreq(strBand[, strMode]) returns the "best" pass freq for a given band and mode. To determine this frequency, it uses the same algorithm as the \$FREQnn variable.
- Lua scripting : New wtOtrsp API introduced :
  - ◇ wtOtrsp:GetDeviceName() returns the name of the OTRSP attached device.
  - ◇ wtOtrsp:GetFirmwareVersion() returns the firmware version of the OTRSP attached device.



## Win-Test Wiki

NOTE : Some devices do not support this API, and return an empty string.

◇ wtOtrsp:Send(strCommand) sends a command string to the OTRSP attached device. The trailing <CR> character is optional, and is appended if needed.

- Scripts manager dialog usability improved. Tnx N6TV.
- OTRSP : If the OTRSP device has controls and if they can generate events, dedicated Lua scripts are called when events occur :
  - ◇ otrspCrOn.wts and otrspCrOff.wts (not case-sensitive) are called when such a control has values 1 and 0 respectively. wtArg is set to the control number (0 to 9).
  - ◇ otrspCrEvent.wts (not case-sensitive) is called for all states of the events. wtArg is set to (256 \* cr) + state (cr = control number - 1 to 9, and state = value of the state when the event occurred - 0 to 255).

WARNING : If the PTT events are used, the control 0 is restricted to this usage, and doesn't fire the otrspCrOn/Off/Event.wts scripts. If the PTT events are not used, otrspCrEvent is not called when an event on this control occurred. Only the otrspCrOn/Off scripts are executed.

- microHAM devices : When an attached footswitch is used, two dedicated Lua scripts named microhamFsOn.wts and microhamFsOff.wts (not case-sensitive) are called. wtArg is set the radio number of the footswitch (0 for MK/MKII - 0 or 1 for MK2R/MK2R+/u2R depending

on the footswitch that generated the event).

- Elecraft K3 : To circumvent erratic loss of control when used with various other devices, CAT stacked commands are now sent in a delayed sequence. Tnx N6TV, N6XI, and others.
- Lua Scripting : New wtMicroham API introduced :
  - ◇ wtMicroham:GetDeviceId() returns the ID of the microHAM attached device. Check the Lua constants for interpretation.
  - ◇ wtMicroham:GetFirmwareVersion() returns the firmware version string of the microHAM attached device.
  - ◇ wtMicroham:Send(strCommand) sends a command string to the microHAM attached device . The trailing <CR> character is optional, and is appended if needed.

Tnx ES5TV, N6TV, OM7ZZ.

- Contest settings dialog: The contest combo box is now divided in sections.
- Status Wnd (Alt-J) : Code rewritten to adapt the window columns to the contest in progress : The band is displayed if the current contest is multi-band. The mode is displayed if the current contest is multi-mode, and the type (R, M, etc.) is only displayed for Multi-Op HF contests. Also, when the CQWW M/S multiplier rule is used, new indicators are displayed in the QSY column.
- Status Wnd (Alt-J) : Rewording of "QSY Freq" to "Pass Freq". Menu items adapted too.
- Status Wnd (Alt-J) : When operating in SO1R/Multi-Op technique, the Radio 2 freq is automatically hidden, and the Radio 1 freq is now using the same color as the other items of the line.

## Win-Test Wiki

- RDA Contest : All DXCC entities are taken into account for multipliers, even the Russian ones. Tnx UA2FF and RX3RC.
- COPYLOG text command added : Duplicate the current log file (.wt4) in the current log directory with a timestamp added in its name. Useful to quickly save the current log right after a contest warm-up, just before clearing it (CLEARLOG) and start the contest. Tnx DL6RAI for inspiration.
- MP3 Contest Player : You can now select which channel(s) - Left, Right or Stereo - to listen to. When Left or Right is selected, this channel is sent to both outputs for a more pleasant listening. Useful to listen to true SO2R stereo recordings. The shortcuts (AltGr+C for Left / AltGr+V for Stereo / AltGr+B for Right) have been chosen for their location on the keyboard.
- WAEDC : Received QTC window (Alt-L) : The contest recorder keys are now active also in this window.
- RDA contest : ADIF export : The first two chars of received district (if applicable) are saved as STATE field and the district (reformatted as XX-dd) is saved as CNTY. Tnx UA2FF.
- RDA contest : For Russian entrants, a QSO with a /P Russian station (assumed to be a C1 or C2 stations) is now credited with 10 pts. Note that using /P for C1 or C2 stations is *\*not\** mandatory (Check the note 5.2 of the English rules). Tnx UA6AA.
- WAEDC : Received QTC window (Alt-L) : The ESC key only works if no field have been edited (and closes the dialog). If a field has been edited, the ESC has no action (except interrupting CW etc.). Tnx F5VIH/SV3SJ.
- WAEDC : Transmit and Receive QTC windows (Ctrl-L and Alt-L): Modified wordings for some buttons, and easier usability for users, especially when using Esc and Ctrl-L/Alt-L to close these windows. Tnx DL6RAI, DF9LF, G3TXF.
- WAEDC : Transmit QTC window (Ctrl-L) : In CW or RTTY, if no QTC is sent, the Ctrl-L and Esc keys close the dialog with no confirmation asked. Tnx DL6RAI.
- WAEDC : Receive QTC window (Alt-L) : If no field is edited, the Alt-L and Esc keys close the dialog with no confirmation asked. Tnx DL6RAI.
- WAEDC : Receive QTC window (Alt-L) : To improve consistency with the log edition keys, a new key set is introduced :

```
Alt-Arrows : Moving from one field to another (replace Ctrl-Arrows)
Shift-Backspace: Delete all the characters left of the cursor
Shift-Del: Delete all characters under and right of the cursor
Ctrl-A: Like [Home]
Ctrl-E: Like [End]
Ctrl-W: Clear the current field
Ctrl-K: Like [Shift-Del]
Ctrl-Z: Undo field edition
Ctrl-Left arrow: Like [Home]
Ctrl-Right arrow: Like [End]
```

Tnx F5VIH/SV3SJ

## Win-Test Wiki

- WAEDC : If the "Show additional information on QTC traffic" option is enabled, the callsign syntax check status messages are no more displayed, to free the message line for the QTC status. Only applies to the WAEDC. Tnx DJ0ZY.
- LUA scripting : Two new global variables wtScript and wtCurrentScript introduced. wtScript contains the name of the top-most called script, with no extension, and wtCurrentScript contains the script name currently executed (no extension). For example :

```
-- foo.wts
wtApp:AlertBox(wtScript .. " / " .. wtCurrentScript);
wtApp:CallScript("bar");
return -1;
--

-- bar.wts
wtApp:AlertBox(wtScript .. " / " .. wtCurrentScript);
--
```

When foo is executed, the first alert box will display "foo / foo" and the next one will display "foo / bar". Tnx N6TV.

- Check country wnd (F10) : New option to display (or not) the sun charts. Tnx N6TV.
- ESM embedded script : When using the SO2R advanced technique, the scenarios messages are used instead of the standard ones. Tnx SM2WMV, N6TV and F6IFY.
- Remote commands dialog : Various different options for the notification are now allowed.
- Script manager : Added the possibility to attach a text command to a script. You can even pass a argument with the SCRIPT/ARGUMENT syntax (ex : SCRIPT/5 will call script.wts and the wtArg value is set to the string "5" - Caution : The argument is *\*always\** passed as a string when the script is called from a text command). If no argument is specified, the default argument defined in the script manager will be used (if any). Tnx N6TV.
- IARU HF : Mult wnd (Alt-M) can now be copied as text (and pasted as text or directly in a spreadsheet program). Does not apply for the WRTC version that has a different multiplier rule.
- IOTA : Even if IOTA.DAT is not installed, IOTA references that are syntactically valid are now taken into account for points credits and are written in the Cabrillo file. Tnx SM3CER.
- IOTA : Mult wnd (Alt-M) can now be copied as text (and pasted as text or directly in a spreadsheet program). Tnx G3TXF.
- The check logs tools reports are now adapted to the mixed contests.
- Enhanced replies to the inventory command (INV) with bridgehead and time masters indicators (B vs b and T vs t).
- BRIDGEHEAD/NOBRIDGEHEAD text commands added.
- IARU HF : "BA" added to the exception list of the cut numbers translation, despite this abbreviation is not listed as the official one of the E7HQ Society. Cf <http://www.iaru.org/iaru-soc.html> Tnx

UA6AA and many others.

## Release information (4.5.2) (July 3, 2010)

### Bugfixes

- Bugfix : Fixed a problem with registration in some versions.

## Release information (4.5.1) (June 27, 2010)

### Bugfixes

- Bugfix : MP3 information files dialog could lead to a crash if no mp3 file were present in the current log directory.
- Bugfix : ARI Sezioni - RTTY : Only valid 4 digits codes can be now grabbed from the RTTY wnd as an exchange. Tnx IKOCHU.

## Release information (4.5.0) (June 5, 2010)

### New Features

CAUTION: New network protocol version 1.24 released

Reminder: If you use WT in a networked environment, you must have the same WT version on all machines!

These network modifications only affect the use of Win-Test in a WAN environment, and requires wtTunnel 1.12 (to be released) to be effective.

- Workaround: YCCC SO2R Box outputs were not working as expected. At this time, AUX1 and AUX3 are assigned to Radio1, and AUX2 and AUX4 to Radio2. This will be customizable in the future.
- Added a Extraction Feature in Contest Recorder (right-click in the Contest Recorder Window, and chose the "Extract and Save QSO" menu).
- Text commands : MP3SETUP and SCRIPTS commands added. Tnx N6TV.
- Scripts manager dlg : The delete key now acts like clicking on the Delete button.
- New microHam device "USB micro2R" supported. Tks OM7ZZ.
- Radio Wnd and DX Cluster Wnd (Alt-A) : New leading indicator (#) introduced to tag spots coming from a CW Skimmer (aka the spotter callsign ends with "-#").
- CW cut numbers translation : New option in Tools / Data entry to disable the automatic translation. Note that this translation is performed on a contest and worked station contextual basis. The equivalent text commands are CUTON and CUTOFF. Do not use CUT/NO CUT that are reserved for

CW cut numbers generation ! Tnx N6TV.

- EXPERIMENTAL : New "Always On Top" option in the Options / Windows menu. Can also be (re)set with text commands. Tnx N6TV.

## Bugfixes

- Bugfix : IC-7600 : Split was broken. Tnx N3MX, I2WIJ.
- Bugfix : In M/\* configuration, and under certain circumstances, the mp3 files list associated with a station in the MP3 file information dialog could be wrong.
- ARRL DX : CW cut numbers are translated for DXCC stations worked from the US/VE side.
- MP3 setup : Only the CBR codecs are now displayed in the setup dialogs. The usage of the ABR codecs (most of the LAME ACM ones) is too erratic to be trusted in. Tnx N6TV.
- Bugfix : REF HF : Cut numbers were translated for TK stations (2A). Tnx F5CQ.
- Bugfix : Additional CW messages (Alt-C) : When no log is opened, the function keys are now disabled.
- Bugfix : Recorder wnd : Under certain circumstances, the buttons tooltips were not always displayed.
- Bugfix : HA DX contest : When working contest from the HA side, cut numbers were always translated, whereas it had to be so for non-HA callsigns only. Tnx HA3LN.
- Contest Recorder: the "rotate file" option were disabling the AutoStart one. Fixed. Thanks IK2JUB.

## Release information (4.4.0) (January 17, 2010)

### Bugfixes

- Bugfix (#255): K1EL WinKey USB CW timing becomes very poor (Farnsworth style) when PTT delay is default 50 ms. This was caused by too low hardcoded value (80ms) of the PTT Tail delay. This delay is now configurable in the Winkey Properties Dialog Box. Tks F5JSD, SM5AJV, KL7RA and N6TV.
- Bugfix (#253): Input Wave Device was not properly selected in the Contest Recorder Module. Tks N6TV, NR5M.
- MP3 files information dialog : Under certain circumstances, the displayed stop time and duration of the selected file were wrong. Tnx N6TV.
- Bugfix (#271) : Packet window (Alt-T) was losing focus when the gab window was automatically closed. Tnx DL6RAI.
- Bugfix (#272) : Under certain circumstances, pattern checking flags were not updated if an entered callsign was modified. Tnx DL6RAI.

## Win-Test Wiki

- DARC 10 : Leading zeros addition for serial received was broken. Tnx DK1AX.
- Bugfix : MP3 files recorded in 2009 couldn't be listened to anymore in Win-Test in 2010 ;-) ! Tnx DL6RAI.
- Bugfix : Stew Perry : Under certain circumstances, an overflow error could happen in distance calculations for Q inside the same GridSquare as the entrant. Tnx VE3TA.
- Bugfix (Task #270) : ARRL 10 : When running the contest from the DX side, the serial sent was not editable. Tnx CX6VM.
- Bugfix : RTTY wnds : Left-click to activate (and right-click to open the contextual menu) in the text area were broken. Also, the possibility to Ctrl-Drag these windows has been added.
- Bugfix : ARI 40/80 contest in RTTY : The provinces can now be grabbed in the RTTY wnd. Also fixed for the ARI International Contest. Tnx IK0CHU.
- Bugfix : The Inventory and Score broadcast network frames could have bad data. Tnx SV3SJ/F5VIH.
- Bugfix : After opening a non-empty log, the first PgUp press was not updating the child windows.

## New Features

- Added some new features of the WK2 (WKUSB) for the PTT Tail. Tks F5JSD, K1EL.
- OmniRig supported as an alternative to the WT build-in Radio Control. Right-click on the Radio Window then choose "OmniRig Settings" in order to properly configure OmniRig for your Radio.
- IC-703 rig added.
- First attempt in OTRSP (Open Two Radio Switching Protocol) protocol support. Tested with the YCCC SO2R Box but not in real conditions. Tks K1XM.
- Log output : Progress bar implemented. Tnx TF3CW.
- Edit / Move in my log menu item has now text commands equivalents: MOVEINMYLOG (or SCROLLMYLOG) and NOMOVEINMYLOG (or NOSROLLMYLOG). Tnx 5B4WN.
- Rate wnd (Alt-R) : Two methods are now available to display the elapsed time since the last band changes. Tnx F1NGP and TK5EP.
- MRU (Most Recently Used) file list added in the File menu.
- IC-7600 rig added.
- ICOM rigs : Radio list rearranged alphabetically in the Interface Setup dialog.
- Bugfix : RTTY wnds : The invert function was also inverting the character next to the selection.
- RTTY wnds : Mirror zone enlarged to allow 4-figures serials.

## Win-Test Wiki

- RTTY wnds : Callsigns found in the database or in the log are now displayed in bold.
- RTTY wnds : Colors management added.
- Grid Squares wnd : It can now be enlarged to the entire world. Tnx F8BBL.
- Grid Squares wnd : New options in the contextual menu to display fields only, and to center the map on a specific point more easily (it requires the map is NOT centered on the Home QTH in the properties dialog).
- Grid Squares wnd : The resolution (low or high) chosen in the properties dialog wasn't properly saved.
- CQWW WPX Contests (Task #269) : Various updates to comply with the new rules introduced in 2010. Tnx K5ZD, W0YK.
- ARRL Contests : Default Off-time period set to 30 mins. Tnx CX6VM and DL6RAI.
- New "-n" or "--noautoload" switch allowed in the command line to disable the autoload log feature. Tnx N6TV (The only Win-Test user who runs it from the command line ;-)).
- Startup time reduced.
- CSV and Text exports : HF logs can now export distance and heading. CAUTION : To ensure consistency with the VHF logs exports (and many geographical processing softwares or online apps), the longitude is now positive for East, and negative for West.
- Tools / Check log / Callsigns syntax check added. Uses the pattern callsigns rules file (callsign.pat).
- LUA : wtArg can now be used to get the optional argument set in the Script Manager or in a #SCRIPT(argument) call. To ensure compatibility, wtArgument remains usable.
- Bugfix : Under some circonstances, some key assignments to scripts were not working properly. Tnx DJ0ZY.
- Script key assignment dialog : If no key is assigned, the argument field is now automatically cleared and disabled.
- Lua : New API to get the type and the manufactuer of the radios: wtRadio\*:GetTypeId() and wtRadio\*:GetManufacturerId(). Reminder : wtRadio\* applies to wtRadio, wtRadioInactive, wtRadioPrimary, wtRadioSecondary, wtRadio1 or wtRadio2. New Lua WT constants are introduced for this purpose. A new directory on our download repository has been created to gather the API and the constants lists : <http://download.win-test.com/v4/lua/>
- REF 160 : As non-domestic stations can send non-numeric exchanges the CW cut numbers translation is now disabled. Tnx F5IN.

## Release information (4.3.0) (November 23, 2009)

## Bugfixes

- Bugfix: playing back MP3s recorded on different stations was broken. Tks FY5KE.
- Contest Recorder (#253): USB Voice Codec was not detected due to a trailing space in the Codec Name. Fixed. Tks N6TV.
- Bugfix (#182): Wrong QSX Frequency in Self-generated Spots. Tks K1GQ.
- Bugfix (#262): CQ Repeat doesn't stop for Secondary Radio. Tks DJ0ZY.
- Bugfix (#259): Pressing Alt-1 in Secondary Radio window moves QSO to wrong band. Alt-1/2/3/... are now active only with the Primary radio and when the Partner Wnd is open. Tks N6TV.
- Bugfix (#251): NA Sprint - LOCATION record not written to Cabrillo file header. Done also for IARU HF, NAQP and NCCC Sprints. Tks N6TV.
- Bugfix (#243): WPX contest now requires LOCATION in Cabrillo. Done also for CQWW even if it doesn't seem required yet. Tks N6TV.
- Bugfix : Ukrainian DX contest and RDXC : Cut numbers were translated even for Oblasts. Tnx F5IN and RK1AA.
- UFT HF : Under some circumstances, the received report was not correctly translated with cut numbers. Tnx F5IN.
- CQWW M/S : The 10-minute mult timer in the status window (Alt-J) was broken. Tnx FY5KE.

## New Features

- Italian translation added. Tks IV3IYH!
- Search for Possible Bad Exchanges against bad formatted serial number implemented. Tks N6TV.
- Added some basic checks for ARRL SS in the "Search for Possible Bad Exchanges" tool. Tks N6TV.
- The '<' and '>' keys are now interpreted by the Secondary Radio Window as well, as far as the SHIFT key is not used for binding to the Secondary Radio Window (task #216). Tks N6TV.
- WAE : When using the keyboard mode in the QTC transmitting and receiving dialogs, the Enter key was mis-interpreted. And now, in CW, the "what you type" field is also updated. Tnx DL6RAI and DJ4MZ.
- Lua : New API to play the additional CW/RTTY messages (Alt-C set)

```
wtKeyer:PlayAdditionalMsg(AdditionalMsgIndex)
```

AdditionalMsgIndex is the index of the Alt-C messages set (1 to 12). Others are ignored. This API is useful when these messages contains variables. If not, you can still use wtKeyer:Play("\$MSGx").



## Win-Test Wiki

- Lua: New API introduced to get various interesting directories paths:

wtApp:GetLogPath()	Current log directory path
wtApp:GetAppPath()	Win-Test installation directory path
wtApp:GetCfgPath()	\cfg directory path
wtApp:GetCtyPath()	\countryFiles directory path
wtApp:GetDatabasePath()	\databases directory path
wtApp:GetOpPath()	\ops directory path
wtApp:GetScriptPath()	\scripts directory path
wtApp:GetExtraPath()	\extras directory path

- WAE : Transmit and Receive QTC windows : Scripts are now allowed in the predefined CW/RTTY messages (use the #SCRIPT notation as usual). Tnx DL6RAI.
- Ukrainian DX contest : Rules 2009 now accept single mode entries for DX : Cabrillo file output updated. Tnx F5IN.

## Release information (4.2.0) (October 21, 2009)

### Bugfixes

- Bugfix: Conversion of binary file containing QTC from v3 to v4. Tks DJ4MZ.
- Better support of Win7 and Wine/Linux.
- Bugfix (#258): Failure of swap radio key to switch rx focus for the MK2R+ as long as one not manually changed the rx focus to stereo or transmitted anything in CW. Tks GW3NJW, OH1JT, OM7ZZ, W4TV.
- Cosmetic: avoid rx focus leds flickering when switching tx focus. Tks OM7ZZ.
- Bugfix (#187): Ctrl-Shift-Tab doesn't appear to toggle RUN / S&P in Secondary radio window. Tks N6TV, GW3NJW.
- Bugfix : K3 serial port default setup modified : The number of stop bits was wrong - It is now set to one stop bit, according to the K3 users manual. Tnx N6TV.
- ON Winter and Spring contests : Sections list updated. Tnx F5IN and ON5GQ.
- Bugfix (#257) : CQWW DX RTTY : Cabrillo template modified to match the specs. Tnx N6TV.
- Bugfix : CQWW DX RTTY : Allowed band changes modified to 8 in MS and M2 categories (rules 2009). Tnx F5JY.
- Bugfix (#164): TI5/NP3D is now parsed as TI. Tnx JE2UFF/W2UFF.
- CTY files : 4U30VIC now considered as 4U1V in an appropriate way. Tnx DL6LAU.
- Bugfix : After reloading a WAE log, the QTC count in the Summary window was wrong. Tnx DK1AX.

## New Features

- Scripting: wtQso:GetModeId() and wtKeyer:GrabHighlightedCallsign() function added. Note that wtKeyer:GrabHighlightedCallsign() works only in RTTY, and relies on the INSERT key option set in the RTTY setup dialog.
- New option in the Clock wnd to "wizz" this window a la MSN at rounded hours, to draw attention of the op (useful in multi-op configurations).
- New feature in Tools / Scripts manager... : Allows to edit, create, delete or rename scripts. It's also used to assign a key and/or an argument to a script (its value will be available in the wtArgument global variable).
- Scripts called by an assigned key can return +1 to be called again *after* the WT key processing occurred. A new API wtApp:IsPostKeyProcess() is introduced to distinguish the "pre"- process from the "post"-process.

Example:

RunSPSwitch.wts (assigned to Ctrl-Tab) :

```
if (wtApp:IsPostKeyProcess()) then
  if (wtQso:IsOperatingModeRun()) then
    wtApp:SetWindowColor(-1, 0, 165, 165);
  else
    wtApp:SetWindowColor(-1, 128,128,128);
  end;
else
  return 1; -- Triggers a post key process call
end;
```

Note : This feature works only for users scripts called with an assigned key (and *not* with embedded overridden scripts).

- Scripts can now be called from a CW or a RTTY message. You must use the #SCRIPTNAME(ARGUMENT) notation. The argument (and parenthesis) are optional. The script will be called synchronously, but is executed in the main thread, meaning that it is not blocking the CW/RTTY stream.
- New feature in Options / Script Editor configuration : Allows to use any external text editor to edit scripts. The default text editor is a custom package of SciTE (Scintilla Text Editor - free and open source) available on our repository

[http://download.win-test.com/utls/SciTE\\_for\\_Win-Test.zip](http://download.win-test.com/utls/SciTE_for_Win-Test.zip)

Unzip the package and move the entire SciTE folder in the Win-Test installation directory.

- YO DX Contest : Rules 2009 : In mixed mode, a station can be worked in both modes. Tnx N2YO.
- Tools / Check log for possible bad exchanges : When the contest do not use serial numbers, use the QSO index in the report remarks. Tnx F1HAR @ TM0HQ.

- Keys redefinitions : The Pause and Scroll-Lock keys can now be used. Be warned that Ctrl-Scroll-Lock and Ctrl-Pause (that are considered as "identical" by the system) are used by Windows to cancel dialogs. Thus, it is advisable to not use them for key redefinition.

## Release information (4.1.0) (August 8, 2009)

### New Features

- IOTA contest: "Search for possible bad exchanges" (tools menu) implemented.
- Rotator Azimuth orders are now based on the locator instead of the DXCC on 50 MHz and above. On 50 MHz and 70 MHz, if the locator field is empty in the log, then the azimuth is computed against the DXCC prefix.
- New text commands RUNSP/NORUNSP and RUNSPON/RUNSPOFF to enable or not the RUN/S&P switching. Tnx N6TV.
- New contest files : You can now customize the file name and sub dir formats. See Options / Log / New contest files properties... Tnx N6TV.
- IOTA contest : Default IOTA reference is now guessed, according to the new CTY\_IOTA.DAT file (must be in the countryFiles directory). This file is based on DXCC countries, callsign prefixes, call areas and oblasts.
- IOTA contest : Check mult wnd (F10) : IOTA references are now autocompleted for check during QSO entry.
- New File menu items to explore more easily several WT-related directories. Tnx F5VIH/SV3SJ and N6TV.
- DX Window (Alt-A) : Spot can be now passed to the secondary radio or the non-active radio. Tnx DL8WAA.
- M2/Orion rotators added in wtRotators. Tks IK0HBN.
- The RRTC Cabrillo files are now following the version 3 specs. And the contest name is modified as "OZCHR". Tnx F5VIH/SV3SJ.
- CW and RTTY msgs enlarged to 120 characters.
- Extra information files : Multiple spaces or tabs can now separate the callsign from the data. Tnx G0ORH.
- New File dialog : Ensures the validity of the entered file name. Tnx DJ7MGQ.
- ESM : S&P : When the entered callsign is a dupe, WT now blocks call. To override this behaviour, use F4 to call and F2 to send exchange (by default). Tnx GW3NJW.

- VHF+ contests : Mode is now displayed in the main log wnd if the contest has been set to handle several modes (Mixed or All modes). Tnx DK2ZF and DL5NAH.

## Bugfixes

- The displayed azimuth in the Rotator Window could be wrong in the "Stacks" and "Rotors" tabs.
- EUHF : Statistics window (Ctrl-F9) limited to one day. Tnx F5VIH/SV3SJ.
- IOTA contest : When an invalid IOTA was entered, clearing the field afterwards wasn't clearing the '?' flag.
- Contest Recorder:
  - ◆ Infinite loop in MP3 file rotations. Tks DD5FZ.
  - ◆ Memory Leak using LAME encoder.
  - ◆ MP3 Codec enumeration in the player. WT was not always detecting the appropriate Codec.
  - ◆ Playback with Windows VISTA. Note that the LAME Codec is an Encoder Codec only.
- When radios were swapped (\*), the ESM QSO status was somewhat messy.
- For some contests, the letters for cut numbers were inappropriately translated.
- After a WT v3 file conversion, the main window caption was not updated.
- MP3 files information : The file date was off by one month. Tnx F5VIH/SV3SJ.
- Cabrillo Import : The station name for all worked QSO was CABRILLO. Now, it uses the name entered in the Contest Settings dialog. Tnx F5VIH/SV3SJ.
- Callsign text color wasn't reset after F11 or empty callsign if the callsign check wasn't automatic. Tnx DJ0ZY.
- Delete QSO : Several structures inconsistencies fixed when a Q was deleted in the middle of the log.
- In REG1TEST exports (European Standard File for V/UHF Contests), QSO logged in mode different than CW or SSB was not well formatted. Tks DL5NAH.
- Options / Log / Colors... menu was broken. Tnx F5LIW.
- Check Country wnd (F10) : Sun status bars now display "NO DATA" when SS and SR are not computed (JW, JX etc.). Tnx DJ0ZY.
- (Task #245) Network advanced settings : The Bridgehead setting was not saved. Tnx KL7RA and N6TV.
- Opening a .wtb file in the command line, by drag'n'drop or a double-click on it was starting an infinite loop. Tnx N6TV.

## Release information (4.0.1) (June 30, 2009)

### Bugfixes

- Options / Toolbar setting was ignored on startup. Tnx N6TV.
- ESM was broken. Tnx F1HAR.
- Registration Key was broken.

## Release information (4.0.0) (June 26, 2009)

First release of Win-Test version 4

Minimum requirements : WinXP (2k not tested but may work - feedbacks welcome). PIII 500 MHz - 64 MB RAM - 800 x 600 screen res.

### New Features

Summary of the new features:

- Rotators Controls
- Integrated MP3 contest recorder and player: Use the Options / MP3 configuration to set the audio device that will record and play the file, the various sampling and bit rate settings. You can also set a maximum filesize. Over this limit, additional files will be automatically created. To start recording click on the record button of the window (a blinking red square will be displayed in the clock window too). Once the contest is over, click on the record button again to stop recording. Now, you can browse your log with usual arrow keys and to listen to a specific Q but clicking the Play button or use the AltGr-Enter combination (some keyboard do not have an AltGr key, so use Ctrl+Alt instead). You can also go back and forward with the adapted buttons or use AltGr-Left and Right. To pause/play, you can use the AltGr-Space combination.
- ESM (Enter Sends Message): Enabled/Disabled by the Tools/Data entry/ESM Enabled menu. You can also use the ESM/NOESM or ESMON/ESMOFF text commands. It relies on the following messages assignation :

```
F1 : CQ
F2 : Sent report
F4 : Mycall
F5 : Logged callsign ($LOGGED)
F7 : ? (or "Again ?" in phone)
INSERT : Callsign + sent report
PLUS : TU + enter Q
```

When the ESM is enabled, as the return key \*can't\* be used anymore to log silently a QSO, the key combination Ctrl+Plus has been introduced and added for this purpose.

- Variable speed for the integrated voice keyer : An exclusive Win-Test feature! You can play your voice files at a different speed (between -20% and +70%) from the original recording speed. Record

## Win-Test Wiki

your voice files at normal speed, and use Alt-F9/F10 (as in CW mode) to play them at a different speed. The speed is displayed at the bottom of the (Rate) Alt-R window.

- On the fly callsign pattern check based on the K1TTT callsign.pat file (over 400 rules applied today). Use the Tools / Data entry / Callsign check menu option. You are encouraged to report the author any mistakes or improvements of this file (k1ttt@arrl.net). The file is located in the cfg directory (see below).
- Improved F10 window with graphical indication of the sun status on both sides of the QSO.
- Keyboard mode (Alt-K) enhanced. The backspace is not supported yet and replaced by "E E " like you do when you use a regular key.
- Data (.wt4) and notes (.not) files can be transferred thru the WT network without needing any file or directory sharing. Very convenient to gather all logs in a multi-stations environment once the contest is over. Use the Tools / Download thru the network... menu.
- Enhanced compatibility with Vista and Seven (Auxiliary and ini files are now stored in directories these OS accept with no additional rights:

```
Windows XP : Documents and Settings\All users\Application Data\Win-Test\  
Windows Vista : ProgramData\Win-Test\
```

Note that these directories may be hidden by Windows Explorer. Check the Folders Options of Windows Explorer.

Several sub-directories are created and used by Win-Test. Their names are self-explanatory.

## Namespaces

- [Page](#)
- [Discussion](#)

## Variants

## Views

- [Read](#)
- [View source](#)
- [View history](#)

## More

- This page was last edited on 12 April 2023, at 16:55.
- [Privacy policy](#)
- [About Win-Test Wiki](#)
- [Disclaimers](#)



# Release Notes V3

From Win-Test Wiki

[Jump to navigation](#) [Jump to search](#)

## Release Notes

### Contents

- [1 Release information \(3.27.1-dev\) \(nightly\)](#)
  - ◆ [1.1 Bugfixes](#)
- [2 Release information \(3.27.0\) \(Jun 9, 2009\)](#)
  - ◆ [2.1 New Features](#)
  - ◆ [2.2 Bug Fixes](#)
- [3 Release information \(3.26.0\) \(Mar 26, 2009\)](#)
  - ◆ [3.1 New Features](#)
  - ◆ [3.2 Bugfixes](#)
- [4 Release information \(3.25.1\) \(Feb 13, 2009\)](#)
  - ◆ [4.1 New Features](#)
  - ◆ [4.2 Bugfixes](#)
- [5 Release information \(3.24.0\) \(Jan 15, 2009\)](#)
  - ◆ [5.1 New Features](#)
  - ◆ [5.2 Bugfixes](#)
- [6 Release information \(3.23.0\) \(Oct 22, 2008\)](#)
  - ◆ [6.1 New Features](#)
- [7 Release information \(3.22.0\) \(Sep 16, 2008\)](#)
  - ◆ [7.1 New Features](#)
  - ◆ [7.2 Bugfixes](#)
- [8 Release information \(3.21.0\) \(June 23, 2008\)](#)
  - ◆ [8.1 New Features](#)
  - ◆ [8.2 Bugfixes](#)
- [9 Release information \(3.20.0\) \(May 14, 2008\)](#)
  - ◆ [9.1 Bugfixes](#)
- [10 Release information \(3.19.0\) \(Jan 24, 2008\)](#)
  - ◆ [10.1 New Features](#)
  - ◆ [10.2 Bugfixes](#)
- [11 Release information \(3.18.0\) \(Nov 3, 2007\)](#)
  - ◆ [11.1 General](#)
  - ◆ [11.2 New Features](#)
  - ◆ [11.3 Bugfixes](#)
- [12 Release information \(3.17.0\) \(Oct 21, 2007\)](#)
  - ◆ [12.1 General](#)
  - ◆ [12.2 New Features](#)
  - ◆ [12.3 Bugfixes](#)
- [13 Release information \(3.16.0\) \(Sep 7, 2007\)](#)
  - ◆ [13.1 New Features](#)
  - ◆ [13.2 Bugfixes](#)
- [14 Release information \(3.15.0\) \(Aug 8, 2007\)](#)
  - ◆ [14.1 New Features](#)



- ◆ [14.2 Bugfixes](#)
- [15 Release information \(3.14.0\) \(Jul 25, 2007\)](#)
  - ◆ [15.1 Features](#)
  - ◆ [15.2 Bugfixes](#)
- [16 Release information \(3.13.0\) \(Jul 23, 2007\)](#)
  - ◆ [16.1 General](#)
  - ◆ [16.2 Features](#)
  - ◆ [16.3 Bugfixes](#)
- [17 Release information \(3.12.0\) \(Jul 11, 2007\)](#)
  - ◆ [17.1 Features](#)
  - ◆ [17.2 Bugfixes](#)
- [18 Release information \(3.11.0\) \(May 18, 2007\)](#)
  - ◆ [18.1 General](#)
  - ◆ [18.2 Features](#)
  - ◆ [18.3 Bugfixes](#)
- [19 Release information \(3.10.0\) \(Mar 22, 2007\)](#)
  - ◆ [19.1 Features](#)
  - ◆ [19.2 Bugfixes](#)
- [20 Release information \(3.9.0\) \(Mar 13, 2007\)](#)
  - ◆ [20.1 Features](#)
  - ◆ [20.2 Bugfixes](#)
- [21 Release information \(3.8.6\) \(Feb 26, 2007\)](#)
  - ◆ [21.1 Features](#)
  - ◆ [21.2 Bugfixes](#)
- [22 Release information \(3.8.4\) \(Feb 8, 2007\)](#)
  - ◆ [22.1 Features](#)
  - ◆ [22.2 Bugfixes](#)
- [23 Release information \(3.8.0\) \(Jan 18, 2007\)](#)
  - ◆ [23.1 Features](#)
  - ◆ [23.2 Bugfixes](#)
- [24 Release information \(3.7.0\) \(Dec 1, 2006\)](#)
  - ◆ [24.1 General](#)
  - ◆ [24.2 Features](#)
  - ◆ [24.3 Bugfixes](#)
- [25 Release information \(3.6.2\) \(Nov 23, 2006\)](#)
  - ◆ [25.1 Bugfixes](#)
- [26 Release information \(3.6.1\) \(Nov 21, 2006\)](#)
  - ◆ [26.1 Bugfixes](#)
- [27 Release information \(3.6.0\) \(Nov 20, 2006\)](#)
  - ◆ [27.1 General](#)
  - ◆ [27.2 New Features](#)
  - ◆ [27.3 Bugfixes](#)
- [28 Release information \(3.5.0\) \(Oct 22, 2006\)](#)
  - ◆ [28.1 General](#)
  - ◆ [28.2 New Features](#)
  - ◆ [28.3 Bugfixes](#)
- [29 Release information \(3.4.5\) \(Oct. 8, 2006\)](#)
  - ◆ [29.1 New Features](#)
  - ◆ [29.2 Bugfixes](#)
- [30 Release information \(3.3.5\) \(Sep 20, 2006\)](#)
  - ◆ [30.1 General](#)

- ◆ [30.2 New Features](#)
- ◆ [30.3 Bugfixes](#)
- [31 Release information \(3.2.0\) \(Aug 30, 2006\)](#)
  - ◆ [31.1 General](#)
  - ◆ [31.2 New Features](#)
  - ◆ [31.3 Bugfixes](#)
- [32 Release information \(3.1.0\) \(Jul 27, 2006\)](#)
  - ◆ [32.1 General](#)
  - ◆ [32.2 New features](#)
  - ◆ [32.3 Bug fixes](#)
- [33 Release information \(3.0.0\) \(Jun 22, 2006\)](#)
  - ◆ [33.1 New features](#)

## Release information (3.27.1-dev) (nightly)

### Bugfixes

- The Tools / Data entry menu was lost ! Tnx OH6XX.
- For some contests, the letters for cut numbers were inappropriately translated.

## Release information (3.27.0) (Jun 9, 2009)

### New Features

- Log entry : In CW, and when applicable (depending on the contest and station worked), letters for cut numbers are translated. Only works for newly entered QSOs. Tnx N6TV.
- New option in the bandmap properties to randomize a small offset (-100 Hz/0/+100 Hz) of the transmitting frequency of a grabbed spot. Works only in CW mode. Tnx F5VIH/SV3SJ.

### Bug Fixes

- Several typos fixed. Tnx DL6RAI.

## Release information (3.26.0) (Mar 26, 2009)

### New Features

- Partner window : Delete item added to the contextual menu. You can also use a Ctrl-Dbl-Click a la Bandmap. No confirmation asked.
- RTTY windows : The middle mouse button acts the same as the left mouse button in the stream display, except that selection (if any) is stacked in the Partner window.
- RTTY and CW : New variables.

`$(CURRENT)` (or `$(CURRENTCALL)`) : Sends the callsign of the current QSO \*despite\* the presence

## Win-Test Wiki

\$NEXT (or \$NEXTCALL) : Sends the callsign of the next QSO line when a \$CR is included in  
\$PREV (or \$PREVCALL) : Sends the callsign of the previous QSO line.  
\$GRABPARTNER : Grabs the first callsign from the Partner window and insert it in the call

To summarize, you can now enter a QSO (with correction or not), grab another callsign from the Partner window and send his report in one keystroke, by using :

```
$CORRECT TU $CR NOW $GRABPARTNER $NEXT $F2 (w/correction)
```

or

```
$CURRENT TU $CR NOW $GRABPARTNER $NEXT $F2 (full call) ($F2 is supposed to be the sent report)
```

If you want to manually grab a callsign from the Partner window you can use :

```
$PREV TU NOW $LOGGED $F2 ($F2 is supposed to be the sent report)
```

1/ Use the enter key to silently enter the current Q 2/ Grab the next callsign from the Partner wnd (dbl-click or Alt-n) 3/ Send the above message

- Custom variables support added. Mostly designed for the DXPed mode, this feature allows to create custom variables and set the value very quickly. Example : \$REGION or \$UP for a split up value.

Use the Options / CW (or RTTY) / Custom variables... menu to set the names and the value of these variables to be used in your CW or RTTY messages. You can also use the VARIABLES text command.

You can also easily set a variable value by entering its name in the callsign and "Enter". WARNING : Don't chose a variable name that is already used or it won't work... Tnx K5AC @ K5D.

- Yaesu FT-450 supported. Tnx F8IJV, F6DEX.
- Yaesu FT-950 supported. Tnx EA8AY.
- ARRL DX and ARRL 10 : KH6 and KL7 stations are now exclusively identified as being not located in HI and AK by the CTY\*.DAT file. Tnx AD1C and G4MJS.
- CW and RTTY keyers : \$FREQnn (like \$FREQ160, \$FREQ80 etc.) variables added. Sends the freq of the primary radio of the first networked station found on this band with the following priority : R, R+, M, and M+. In addition, in CW, if the frequency is round, no decimal point (or kHz) are send. If not, the decimal point is replaced by an R. Ex 14021.0 is sent as 14021 and 14021.1 is sent as 14021R1.
- Status Window (Alt-J) : To improve consistency across the software, new contextual menu item to Pass a frequency to the Sub VFO of the active radio (if the radio permits). An Alt-Dbl-Click on the frequency works too, like in the bandmaps windows.
- Sked Window (Alt-B) : To improve consistency across the software, an Alt-Dbl-Click on a sked passes its frequency to the Sub VFO of the active radio (if the radio permits), like in the bandmaps windows.
- CW / RTTY : The leading zeros setting is now different for each mode, but the text commands (LZ/NOLZ etc.) remain the same. Tnx N6TV, KR7X.

## Win-Test Wiki

- RTTY setup : New option to favor or not auto-highlighted mults when using the Ins key. Tnx TK5EP.
- RTTY wnds : New option in the contextual menu to "invert" (Letters / Figures) the selection. Tnx DL6RAI.
- RTTY wnds : The 599nn, 599nnn and 599nnnn reports are now correctly interpreted and the 599 part is stripped. Tnx DL4NER.
- PACC contest new rules : Non-PA stations are no more restricted to mixed mode. The Cabrillo output has been consequently updated. Tnx F5IN.

## Bugfixes

- Under certain conditions the CLEARLOGNOW text command could lead to a crash. Tnx DL6RAI @ DQ4W.
- UBA Spring contests : Sections were missing in the section list displayed in the Alt-Z wnd. Tnx F5IN, ON7TK.
- ARRL Contests : The content of the ARRL-SECTION or LOCATION field of the Cabrillo output file can be modified to comply with the ARRL/RAC sections list. Tnx W2NRA.
- (Task #241) Minimum offtime for CQWW 160 is now 30 min. Tnx K1DG.
- NAQP and NA Sprint RTTY : The \$MYNAME wasn't working in this mode. Tnx YV5TX.
- (Task #239) Packet monitor wnd (Alt-O) : Scrollbar issues when its content is over 65535 lines. So, this wnd is now limited to the last 65535 lines. Tnx G4MJS.
- CQWW WPX now appears in the current month contest if we are in february (because of the RTTY leg). Tnx DL6RAI.

## Release information (3.25.1) (Feb 13, 2009)

### New Features

- CQWW WPX RTTY : Rules 2009 : The band-change limit for MS is increased to 8 per hour.
- DX Cluster Wnd (Alt-A) : New option to display only the op-entered spots. Tnx YL2GD.
- CQWW 160 : Zones wnd : Copy as text enabled. Tnx G3TXF.
- CQWW WPX : RTTY M/S => Numbering sequence for whole log for M/S and numbering per band for the other M/? categories.

### Bugfixes

- Bugfix : Stats wnd (Ctrl-F9) : If the contest spread over two days (CQWW 160 rules 2009 for example), it was impossible to export a target file over 48 hrs. Tnx OK1VWK @ OL7R.

## Win-Test Wiki

- Bugfix : Stats wnd (Ctrl-F9) : If the contest spread over two days (CQWW 160 rules 2009 for example), some drawings were broken.
- Bugfix : Task #211 : NA Sprint : Network protocol was broken. Tnx N6TV.
- Bugfix : Task #236 : FOC Marathon : The exchange filling function failed after a band change. Tnx N6TV.
- Bugfix : Task #233 : Rate Wnd (Alt-R) : CQWW 160 : Under certain circonstances the pts per QSO calculation was wrong. Tnx DL1ELY, DL6RAI.
- Bugfix : Task #230 : Options / Windows / Default layout... was crashing Win-Test. Tnx N6TV.
- Bugfix : NCCC Sprint : Canadian Maritime "provinces" are now using the MAR identifiers, like for the NA Sprint. N6TV.
- Bugfix: Task #228: wrong QSX frequency in spots with K3. Also apply to Kenwood Radios. Tks W9ZRX, N6TV.
- Bugfix: ALT+F3 and K3: inverted frequencies into an ALT-F3 Spot. Tks W9ZRX.

## Release information (3.24.0) (Jan 15, 2009)

### New Features

- CQWW WPX : New rules 2009 : In M/S category the trailing 0/1 indicator in the Cabrillo file now indicates if a callsign has been worked by a RUN or a MULT station.
- RAEM Contest implemented. Tnx F5IN.
- Keyboard mode : New options in Options / CW and Option / RTTY to enable or not keys remapping while in keyboard mode. Cf Task #172. Tnx N6TV.
- Contest settings dlg : The exchange help message box pop-ups if it is required and empty. Tnx W7UPF, N6TV.
- CQWW 160 : Win-Test is now compliant with the new rules 2009.
- Sked window (Alt-B) : You can send the sked freq in the sub VFO if applicable. Tnx TM2Y.
- CTY files : The "virtual" OVER entity (if any) is ignored. The VER\* callsigns too.
- WAE messages : \$LOGGEDCALL (or \$LOGGED) can now be used in these messages. Tnx DK4WA.
- Clock wnd : The RUN/S&P indicator is displayed only if this switch is enabled (Tools / Data entry menu). Tnx F1HAR @ FY5KE.
- Statistics : All text reports are now formatted with | separators instead of ! chars. Tnx N6TV.

## Bugfixes

- NAQP and SCCC Sprint : VO1/VO2 province is now NL instead of NF. Tnx NX5M.
- Rate wnd (Alt-R) : Under some circumstances, the calculations were wrong for monoband contests. Tnx AC0W.
- ARRL 10m : US/VE multipliers weren't correctly displayed in the Check Multipliers wnd (F10). Tnx CX6VM.
- Task #221 : ARRL SS Cabrillo file import failed. Tnx N6TV.
- Task #171
- ARRL 160 : ADIF file export now uses the ARRL\_SECT field. Also fixed for the ARRL SS, ARRL FD and the ARRL 10 uses the STATE or VE\_PROV field when applicable. Tnx AD1C, W1EQ.
- Task #222 : M/S log import now correctly assigns the RUN and MULT flags following the new Cabrillo implementation. Tnx I4UFH, N6TV.
- Task #218 : The exchange help in the contest configuration now works for the ARRL SS. Tnx N6TV.
- ARRL SS : Serial sent is now editable (Edit / Serial sent) Tnx N6TV.
- WAE RTTY : QTC transmission : A QSO with a 000 as serial number was interrupting the transmission of the serie. Tnx DK4WA.
- MK setup dlg : Under some circumstances, chosen options were deleted when setting the router path. Tnx FY5KE.
- Task #214 - QSX frequency (if any) was missing in ALT-F3 when spotting the previously logged QSO. Tks DL4NER, NQ4I, W9ZRX, N6TV.
- Task #215 (Clicking on QSX spots (split) doesn't work right with Yaesu radios) - fix to be tested.
- Some AltGr (Alt+Ctrl) shortcut was also launching either Alt or Ctrl ones. Fixed.

## Release information (3.23.0) (Oct 22, 2008)

### New Features

- Spanish language is now included. Thanks EB2CYQ for this excellent job!
- CQWW RTTY : ADIF export : Task #213 - US State (or VE province) is now exported when applicable. Tnx N6TV.
- Radios : Omni VII process reviewed and fixed. Note that the TenTec protocol has some limitations Win-Test can't circumvent. For example Win-Test can't know which VFO is transmitting. A big "thanks" to F5FLN (owner of RFPA/RFHam <http://www.rfpa.com/> and <http://www.rfham.com/>) who lent us an Omni VII for testing. Tnx F5LVL.

- RTTY keyboard mode (Alt-K) : The Ctrl-M and Ctrl-Enter combinations now send linefeeds. Tnx DJ4MZ, N6TV.

## Release information (3.22.0) (Sep 16, 2008)

CAUTION: New network protocol version 1.23 released

Reminder: If you use WT in a networked environment, you must have the same WT version on all machines!

### New Features

- Voice Keyer module rewritten.
- CQWW M/S Category : The Cabrillo file format now uses a different indicator whether the QSO has been worked with a RUN or a MULT station. Tnx K1EA, F6BEE.
- RDA Contest : Russian stations : DXCC countries are now counted per band. Tnx UA1ACC.
- RDA Contest : R1FJ and R1MV are now considered as Russian Stations and their RDA is processed as valid. Tnx G3TXF, OR2A and others.
- The bridgehead concept has been revised to decrease the required bandwidth for log synchronization across a WAN. This new implementation is only effective when used with the updated WtTunnel v1.10. The updated WtTunnel suite will be available only for the next IARU HF contest, and, as usual, its use will be restricted to the HQ stations.
- Radio wnds : Ctrl-Up/Down are now usable with all sorting options.
- WAEDC : DX side : QTC-in-stock count is now displayed in the Clock wnd. Tnx K5KG.
- WAEDC : Radio wnds : New option in the list view to display the "potential QTCers". Tnx IZ3EYZ.
- RRTC (Russian Radiosport Team Championship) added. Tnx RA3AUU.
- New text commands added :
  - ◆ AUTORELOAD: Equ. to Options / Load contest at startup / Enabled
  - ◆ NOAUTORELOAD: Equ. to Options / Load contest at startup / Disabled

### Bugfixes

- WAE : Radio wnds : List view : The "potential QTC" option was not working correctly. Tnx IZ3EYZ.
- Radio wnds : Bandmap view : Scale 1:8 menu item was not working. Tnx TM1W.
- ARRL FD. Some ARRL sections weren't considered: AK, PAC, PR and VI. Tnx VE2FU, N6TV
- ARRL FD. QSO between home stations are now tagged as invalid and count as 0 pts. Tnx VE2FU.

- Helvetia VHF/UHF/Microwave Contest : Locator partial check is now working the same way as the other VHF+ contests. Tnx HB9CZF.
- Split Mode with IC7700. Tks K3LR.

## Release information (3.21.0) (June 23, 2008)

CAUTION: New network protocol version 1.22 released

Reminder: If you use WT in a networked environment, you must have the same WT version on all machines!

### New Features

- Operators management : Reserved for Multi-Ops : When an operator logs in, Win-Test now automatically tries to run an executable (.exe, .bat or .com) named op\_"callsign" which must be located in the Win-Test installation directory. For example, if DL6RAI logs in, WT will try to run op\_dl6rai.exe (or .bat or .com), if this file exists. If the callsign includes a "/" character, it will be replaced by an underscore ("\_"). This feature may be useful to automate various actions. Tnx DK4YJ for giving the idea.
- NA RTTY Sprint : The special "legal dupe" rule being abandoned for this mode, Win-Test is now processing dupes the same way as for the SSB and CW legs. Tnx W0YK.
- Win-Test now manages a lock mechanism to prevent several program instances running on the same machine to open the same log. Tnx N6TV.
- CW and RTTY messages dlg : Keystrokes are now automatically upper-cased while entering.
- Partial QTH locator search enhanced (Shift - F10):
  - ◆ Only applies to the VHF+ contests
  - ◆ Partial locator can be entered in the callsign field - or -
  - ◆ Partial locator can be entered in the locator field with four characters at least
- Automatic CQ repeat : New options in the setting dialog to use this function for functions keys different from F1, depending on the mode. Can be useful, for example, in Phone when using CQ messages in different languages.
- Automatic CQ repeat : The repeat interval can be set even if the function is disabled.
- CW Autosend : Setting dlg slightly modified to split the Enable / Disable toggle from the minimum entered chars setting.
- CW Autosend : The triggering chars count now starts after the first '/' if there is one in the callsign. Tnx ES5TV.
- Shift and NumLock bindings settings are now ignored when using an operating technique different from the Advanced SO2R. Tnx SM5AJV.
- New option in the help menu to display text command tips for menu items. The equivalent text commands for this option are TXTCMDTIP / NOTXTCMDTIP, or TEXTCMDTIP /



NOTEXTCMDTIP. Tnx N6TV.

- CW/RTTY Messages options : New option to ignore the S&P messages when switching to the S&P operating mode. Only the Sprint logic for the Insert key acts as expected, if enabled. Tnx ES5TV and N6TV.
- CW/RTTY Messages options : The Sprint logic for the Insert Key now also applies for the AP Sprint. Tnx N6TV.
- New \$NEXTSERIAL and \$PREVSERIAL CW and RTTY variables. Sends the next or the previous serial number of the current QSO line. Tnx ES5TV.
- New text commands added :
  - ◆ WKSETUP: Equivalent to Options / WinKey configuration...
  - ◆ EZSETUP: Equivalent to Options / EZMaster configuration...
  - ◆ MKSETUP: Equivalent to Options / MK/MKII/MK2R configuration...
  - ◆ RTTYSETUP: Equivalent to Options / RTTY configuration...
  - ◆ QUICKQSL: Equivalent to Tools / Intelligent Quick QSL...
  - ◆ AUTOCQ/NOAUTOCQ: Enables/disables the Repeat mode
  - ◆ CQAUTO/NOCQAUTO: (ditto)
  - ◆ CWAUTO/NOCWAUTO: Enables/disable the CW Auto Send
  - ◆ AUTOCW/NOAUTOCW: (ditto)
  - ◆ CWAUTOON/CWAUTOOFF: (ditto)
  - ◆ AUTOCWON/AUTOCWOFF: (ditto)
  - ◆ RPTDELAY: Equivalent to Tools / Automatic CQ repeat, with the focus set to the repeat interval field
  - ◆ CTYFILE(S) / COUNTRYFILE(S): Eq. to Options / Data files / Country files...
- RUN / S&P operating : When the repeat mode is enabled, changing to S&P operating disables the repeat and the autosend modes. Tnx ES5TV.
- Alt-F : QSO operator added to the editable fields. Modifications, if any, are propagated across the network.
- New feature added in the Tools menu to allow the correction of the operator for a range of QSO.

Even if this tool is more supposed to be used after a contest, or a DXPed, to correct a wrong or forgotten entry, each correction is broadcasted to the other stns of the network by default. You can disable this broadcasting to save time, if not needed.

The easiest way to correct a range of Q, is to set the cursor log on the first Q to correct and select the menu item. The operator combo will be then already set. Then, adjust the last Q to correct by using the arrow keys (and optionally the band(s) and mode(s)).

Note that corrections are pretty CPU intensive and it may take a certain amount of time for large logs, because each QSO modification requires internal structures to be updated.

Note : Hesitating and wise users are encouraged to perform a backup of their log before proceeding. These corrections can't be cancelled while they are progress, to avoid any log inconsistency... Tnx G3TXF and F6IFY.

## Win-Test Wiki

- WinKey properties : New options to set speed with the WK pot. only, or the WT commands when using the "Sync speed" option.
- User Interface : Following the programming guidelines, all menu items requesting additional information to complete are now ending with an ellipsis.

### Bugfixes

- Several bugfixes and improvements on the WinKey speed. Tasks #122, 162 and various reports. Tnx N6TV, K1EL, F6IFY, OM7ZZ and many others.
- Task #128. CW and RTTY messages dialog now handle the Enter and Esc keys as expected. Tnx N6TV.
- WAE QTC transmitting and receiving messages dialog now handle the Enter and Esc keys as expected.
- QuickQsl dialog : The Enter and Esc keys work as expected while editing the messages.
- Task #173 : The decimal point is now accepted when editing QSO frequency or QSO frequency in the Alt-F dlg. Tnx N6TV
- Task #138 : In S&P, F1 was setting the CQ frequency. Tnx SV3SJ/F5VIH.
- RTTY windows : Under some circumstances, the automatic grabbing with the INSERT key was broken. Tnx W0YK.

### Release information (3.20.0) (May 14, 2008)

- King Of Spain contest : Points per QSO updated following the official URE rules. Tnx EA5FQ.
- RTTY wnds : A new (C) button (stands for "Clear", like on a calculator) added to clear the TX/RX window; Tnx G3SVD and N6TV.
- RTTY wnds : The mouse wheel now acts like in the other Win-Test child windows. It means that you can scroll, or goto the start or the end of the window (by using Shift + Wheel), or change the font size a la Firefox/Mozilla by using Ctrl + Wheel. The small icon to quickly scroll to the end of the window (located in the title bar of the window) is also enabled.
- RTTY wnds : Shift + Click on a message button opens it for edition.
- Log exports : New export LogSearch format to comply with Marios 5B4WN log search php script. In the options dialog, you can specify a range of Q to be exported, and zip the output file (so its name will be "blahblah.LGS.ZIP"). Tnx TX5C and 5B4WN.
- Added a LogSearch export option in the Automatic Backup function. In this case, the entire log will be exported (the range option of the log exports dialog doesn't apply), \*but\* the zip option set is applied.

## Win-Test Wiki

Note: Contrarily to the WTB backup, the LogSearch exports are not done in a separate background thread. Thus, it is not recommended to enable this option on a running station because WT will be unavailable for logging for a while every time an export is in progress. During this period of time, an empty file named "LOCK" is created in the backup directory, and deleted once the export is completed. This ensures file integrity check for a third party application using the export file.

- New report in Tools / Check log menu to display all distinct callsigns of a log, and band(s)/mode(s) worked by each station. You can sort this report by callsign, by number of Q and by country. This report can also be opened in the Windows notepad. Tnx WA1S @ TX5C.
- Keyboard switching for international teams with different keyboards. To help these users, a new switching dialog is added in the Tools | Data entry menu. It is enabled only if several keyboards are installed in your system. You can also access this dialog by entering the text commands KEYBOARD or KEYB for short.

We remind you that you can also switch keyboard by using the text command KEYB/xxx where xxx is the abbreviated language code described here:

<http://www.microsoft.com/globaldev/reference/winxp/langtla.msp>

For example : KEYB/FRA, KEYB/ENU or KEYB/ENG etc.

For convenience, this abbreviation is also mentioned in the keyboard switching dialog.

- Rate wnd (Alt-R) : By default for new logs, the calculated offtime is now based on the contest rule. You can still use a custom setting to check your operating (in)efficiency. If the contest rule is unknown, 15 minutes will be used. Tnx DL6RAI, N6TV and others.
- Interfaces : New option in the MK/MKII/MK2 setting dialog to check if the microHAM router software is running. Tnx F2JD @ FO5A/MM ;-)
- Interfaces : New option in the MK/MKII/MK2 setting dialog to start the microHAM router if it not running yet.
- Interfaces : When a COM port can't be opened, you now have the possibility to retry opening, to continue with this port closed for this session only, or to disable it permanently.
- Log wnd : WT can now display a QSO count over 99999 in DXPed mode. Tnx ES5TV @ VP6DX.
- Packet parser modified to comply with the CWSkimmer telnet pseudo-cluster syntax (the # char is now accepted). Tnx N4ZR.
- Startup : If Win-Test is started with the Ctrl key down, it doesn't automatically load the previous opened log.
- Merge dialog :
  - ◆ In the "Add file" dialog, you can now select multiple files at once. Tnx TX5C.
  - ◆ New button to designate the master file. Tnx TX5C.
  - ◆ New option to load the master file once merging is completed.
- New continent field available in the CSV and TXT export files. Tnx VA7DX @ TX5C.

## Win-Test Wiki

- Callsign checks are now a bit more restrictive to prevent typing errors. Tnx WA1S @ TX5C.
- DXPed mode : You can now specify the duration of the operation (between 1 and 15 days) in the contest settings dialog, to fit the stats wnd horizontal range (Ctrl-F9). You have to enlarge this wnd if needed. Tnx TX5C.
- DXPed mode : Default Insert key msg modified (no more dupe check). F3 default message also modified to "\$LOGGEDCALL ?". Tnx TX5C.

## Bugfixes

- Black Bandmap with FT-847/FT-897. Tks G4FAL.
- ARI DX contest : Typo in the provinces list : FO instead of FC (I4). Tnx G3TXF.
- RTTY wnds : If text was selected and the font size was modified, the selection rectangle wasn't modified, and further selection on received text before the size modification was wrong.
- Task #170. HamCap Propagation forecast now also works with the callsign entered in the secondary radio window. Tnx N6TV.
- Task #192. CheckPartial (F8) and N+1 (F12) wnds : Dupes display failed when callsigns were entered in the secondary radio wnd. Tnx N6TV.
- Task #193. Data files specified in command line launch with no extension generated erroneous extra files names. Tnx N6TV.
- Task #194. CheckCallsign wnd (F9) wasn't working for the ARRL VHF contests (and probably other VHF+ contests). Tnx K1TR.
- Task #191. When using a WinKey, the paddles activation cancels the repeat mode if enabled. Tnx N6TV.
- Radio wnds : Under some specific circonstances, the bandmap view could display garbage.
- The CSV export settings weren't saved. Tnx N6TV.

## Release information (3.19.0) (Jan 24, 2008)

### New Features

- Added IC-7700 and Tentec Orion II in the list of supported radios.
- Basic Operators management

Foreword: This feature is very limited, and will *\*not\** be further extended in this major version of Win-Test (v3). It is mainly added to help DXPeditioners for the web log search scripts, and for various DX or testers challenges (RRDXA etc.)

New text commands : OPON (or LOGIN), OPOFF (or LOGOUT).

## Win-Test Wiki

This feature is only available to multi-op logs.

If you entered a list of operators in the contest settings dialog when creating the log, it will be parsed to init the combo-box. You can also add ops "on the fly" to this combo box.

If you add nicknames to ops of this list (joe, jack, william, averell, josette or whatever - letters and numbers are accepted, allowing exotic nicks like l33t etc.), you can enter them as text commands to quickly change operator, without using the OPON command.

Op. callsigns are limited to 7 chars, while nicks are limited to 13 chars.

The operator changing is propagated across the network, meaning that if you login on a station, you will be automatically logged out of the previous one you were logged on (if any).

The ADIF file export includes the op callsign in the QSO record, if an op. has been defined for that QSO.

The text and CSV export files are also enhanced to allow the inclusion the op. callsign.

- New KEYB text command: Designed for international multi-op teams. You can now switch keyboard to use in WT with a KEYB/xxx text command following the abbreviated language code described there: <http://www.microsoft.com/globaldev/reference/winxp/langtla.msp>. For example : KEYB/FRA, or KEYB/ENG etc. Caution: The keyboards layouts must have been installed in the Windows language bar before using! This portion of code is CERN-approved. Tnx F6IFY, F5VIH/SV3SJ.
- ARRL SS : The licence year log entry field title is now Chk (stands for Check). Tnx N6TV.
- ARRL SS : New \$CHECK variable added to send your licence year. This variable only works for this contest. Tnx N6TV.
- CTY files : To strengthen the parsing of these files, all trailing spaces are now ignored. Tnx W9ZRX and AD1C.
- CTY files : The parser now supports leading equal symbols (=) of the future CTY files. Tnx AD1C.

## Bugfixes

- The "elapsed time since the last QSO" bargraph was not displayed anymore. Fixed.
- Orion II Radios not properly set when grabbing QSX spots from the bandmap. Close bug report #159. Tks K1GQ (KC1XX). Note: still not 100% operational.
- Task #174 of the BTS : Using [Alt-F1/F2] to fix band of already logged QSO entered on the secondary radio was changing the rig, which is not expected. Fixed. Tks N6TV.
- NAQP M/2 (only) : Edit current op. name menu item added. The equivalent text commands are OPNAME or MYNAME. Tnx N4CU.
- Radio Wnd / Bandmap view : Max. zoom extended. Tnx G3RXQ.

## Win-Test Wiki

- ARRL RTTY Round-Up implemented. Tnx F6IFY.
- ARRL 160 : The Cabrillo file now marks empty exchanges (for DX side stations) with "---" to comply with the ARRL robot. Tnx F5IN, N5KO.
- Objectives renamed as Targets. Tnx G3TXF.
- NAQP : Cabrillo file : Op name field was broken in M/2. And Transmitter ID added in M/2 only. Tnx N4CU, N6TV, N5KO.
- CQWW 160 : Default band (160) was broken. Tnx DL6RAI.
- Bugfix : Left-handed users who used the appropriate Windows mouse settings weren't able to move the Clock and SSB bargraph windows. Tnx JQ1BVI.
- ARRL SS : The exchange guessings were not reset when the callsign was modified. Tnx N6TV.
- Tools : Check exchanges : Inconsistent behaviour under certain circumstances.
- When opening or creating an empty log, it was locked from the OS point of view, even after closing it in WT. Tnx N6TV.

## Release information (3.18.0) (Nov 3, 2007)

### General

- Some improvements done in the microHam MKII protocol support. **This version of Win-Test does now request USB device Router v5.0.3 or later.**

### New Features

- MK2R/MK2R: WT does now display the firmware version number of the device in the "detected" message shown at the startup.
- WT can now control the microKeyer through the microHam protocol as well. This is useful to control the USB Device Router DVK which should give better result in audio and radio switching than using the WT integrated Voice Keyer. Tks microHam company.
- < and > key behaviours changed. Regardless the SO2R status,
  - < key will now switch to the previous field of the main log
  - > key will now switch to the next field of the main log

### Bugfixes

- Bugfix: MK2R/MK2R+ was not configurable anymore. Fixed. Tks OH2UA.
- Bugfix: IC-275/475/1275 communication problems fixed. Tks IK2JUB.

- Bugfix: Frequency Offset fixed with IC-735.
- Bugfix: With an FT1000MP and some other rigs, band map follows TX freq instead of RX freq when operating Split. Tks N6TV.
- ARRL SS : Stats are now displayed on 3 days. Tnx N6TV.
- ARRL SS : Every QSO field must be filled to enter it. Tnx N6TV.
- ARRL SS : Dupe warning now indicated the received serial of the former QSO. Tnx N6TV

## Release information (3.17.0) (Oct 21, 2007)

### General

- **CAUTION : New network protocol version 1.21 released. Reminder : If you use WT in a networked environment, you must have the same protocol version on all machines !**

### New Features

- The microHAM micro KEYER II is now supported. WT can control this interface using the microHAM protocol in order to use the DVK.

For that, create/select a free COM port for "Control:" in the "microHAM USB Device Router", then select "microHAM MKII" as a connected device for the corresponding COM port in the "Interface Configuration" window of WT.

Tks microHAM company for great support!

- Asia Pacific Sprint added.
- JARTS WW RTTY Contest added.
- LPT address can be set between 0200 and FFFF (hex). Tnx VE5ZX

### Bugfixes

- Bugfix: Sprint logic feature (CW messages option) was not working for the EU Sprint. Tnx S51DS.
- Bugfix: Under certain circumstances, the correct local help files were not opened. Tnx W9ZRX.
- Bugfix: CQWW RTTY : Except under certain circumstances, the zone wasn't filled for K/VE when a QSO has been made with the current stn on another band. Tnx DL5AXX, T93Y.
- Bugfix: Task #141 - NA Sprint : Alaska stations (KL) entered in the log are now listed with an AK exchange in the Cabrillo file. This also applies to the NCCC Sprint. Tnx N6TV.
- Bugfix: When entering a QSX freq for a spot, WT was picking up the same transmit freq and re-listed that as the QSX instead of picking the second VFO freq. Tks NQ4I.

- Bugfix: Under some circumstances, the Map (Grayline) Window was not properly opened when opening a new log. Fixed.

## Release information (3.16.0) (Sep 7, 2007)

### New Features

- Intelligent Quick QSL can now be adaptive according to the Instant Rate. See the "Intelligent Quick QSL configuration..." window (in menu "Tools") for details. Tks CT1BOH.
- Added new macro \$QQLRESET. This macro reset the timer or the counter like if the long QSL message were just sent. It makes sense to use this macro in each message you send your callsign in like CQ (F1 key) or MYCALL (F4 key). That way, you won't send a long QSL message after sending your call a few seconds before. Tks CT1BOH.
- Added new macros \$FREQP and \$FREQS - Feature request #8. These new macros send accordingly the frequency of the Primary radio and the frequency of the Secondary radio. Tks OH4JFN.
- New qualifications to the Kenwood Radios (as well as radios based on the same protocol, like SDR-1000, Elecraft):
  - ◇ Under certain circumstances, the mode was not read correctly at the startup of Win-Test
  - ◇ Added the BandMap "Pass to Sub VFO" feature
  - ◇ When entering a frequency in the callsign field, the RIT is cleared (as far as it is enabled).
- Editing of the Frequency of a logged QSO - Feature request #117. In addition to its Date and Time (ALT+F shortcut, or in menu Edit). Tks DL4NER.
- Alt-F9/F10 now always change the CW speed by 2 WPM up or down, regardless of the current CW speed (can be odd or even). Tks N6TV.
- F11 also wipes the time field if done on the last QSO in the log.
- CQIR contest added.

For the IRTS 75-year anniversary, make 75 QSO and you enter a draw to win a week for two in Kinnitty Casle (flights included). For detailed rules, see <http://www.irts.ie/COIR>

- SARTG RTTY contest added.
- LOTW contest added.
- SCC Championship RTTY contest added. Requires CTY\_LUPROV.DAT file.
- CQWW RTTY : When an US/VE stn is worked, entering his state/province is now mandatory. Tnx F6IFY.
- Keyboard mode dialog (Alt-K) revisited. The dlg labels are more descriptive than before, and in RTTY you can chain predefined msgs with keystrokes, as in CW. The only difference is that in RTTY, [Esc] empties the TX buffer, but let the PTT ON, so you can enter keystrokes again, unless



you close the window (which resets the PTT).

- Spots warning : New option to be warned when spotted on the current band/mode only. Tnx I4UFH.
- Radio windows : Markers and segments files can also be set with the bandmap display contextual menu.

## Bugfixes

- Bugfix: SWAPing two radios (in SO2R mode) in a mixed mode contest might get Mode changes hazardous! In addition, VFO-B programming when at least one of the Radio is an Icom gave over. Tks MMOBQI.
- Bugfix: Chaining 1-char long CW messages or using the CW Keyboard Mode with WinKey was sometimes causing speed changes (speed was actually set to the pot speed). Fixed. Tks DL5AXX.
- Bugfix: RTTY was set using the upper side band for frequencies above 10 MHz. Fixed. Tks VE2FWW.
- Bugfix: QTC might be hidden when for portable stations (like N1AA/6). Fixed. Tks DJ0ZY.
- Bugfix: Closing QTC session with "+" causes QSO entry problem if the serial number is not set. Bug report #123. Fixed. Tks DL1IAO.
- Bugfix: Task #137: "PTT to Wrong Radio after sending something to 2nd radio". In SO2R, if using Alternate CQ, the TX focus stays on "wrong radio" when starting QSO. In addition, the TX focus also stays on the secondary radio when one sends something on it. Both fixed. Tks OH2UA.
- Bugfix: Task #130: "Broken TRX-Control with TenTec Orion". After about 30 min, communication with Orion trx was not working anymore. Fixed. Tks DJ0ZY.
- Bugfix : WAEDC contest : In the QTC transmit or receive dialogs, the CR and + keys didn't work as expected in SSB mode. Tnx ES5TV.
- Bugfix : WAEDC contest : The ADIF STX field wasn't set. Tnx F5UKL.
- Bugfix : Stats wnd (Ctrl-F9) : Under certain circonstances, the displayed graph wasn't correct on this window opening. Tnx DJ0ZY.
- Bugfix : Some mixup in the parity labels and abbreviations of the COM properties dialog. It is advisable to check your COM settings, especially if some of your interfaces use Even or Odd parities. Tnx DG7RO.
- Bugfix : Notes are stored in the local .NOT file even if outbound protocol is disabled. Tnx N6TV.
- Bugfix : [Esc] didn't always stop messages keying (CW or RTTY). Bug report #132. Tnx DJ0ZY.
- Bugfix : Under certain circonstances, Cabrillo v3 files import failed. Tnx F5LEN.

## Release information (3.15.0) (Aug 8, 2007)

### New Features

- New set of CW/RTTY variables dedicated to the WAE
  - ◇ Receive QTC window:
    - \$MYCALL: Send my callsign
    - \$VALID: Save everything and close the window
    - \$QTC: Send <group>/<number>
    - \$NEXT: Move focus to the next QTC line
  - ◇ Transmit QTC window:
    - \$MYCALL: Send my callsign
    - \$VALID: Save everything and close the window
    - \$QTC: Send <group>/<number>
    - \$NEXT: Move focus down to the next QTC line
    - \$13: Send carriage return character (specific to RTTY)
    - \$TIME: Send time of the current QTC
    - \$CALLSIGN: Send callsign of the current QTC
    - \$SERIAL: Send serial number of the current QTC
    - \$DONE: If all QTC are sent: mimic the + key
    - \$SERIE: Send the QTC serie (specific to RTTY)
- The CW/RTTY messages specific to the WAE contest (QTC Receive/Transmit) windows can now be redefined in the menu "Options | CW/RTTY | Modify WAE messages...".

It is also possible to modify the label texts of the buttons for both the "QTC Transmit" and the "QTC Receive" windows. The variable \$QTC can be used and will be replaced by the appropriate QTC group/number in the "QTC Transmit" window.

- RTTY leg of the WAE contest now supported in beta test.

QTC groups and series will be highlighted in the RTTY window.

Assuming you receive the following sequence:

```
QTC: 65/2 QTC: 65/2
0917-GI8HXY-146
0918-G8UBJ-068
```

First click on one of the highlighted "QTC: 65/2": this will automatically open the "QTC Receive" window and fill the QTC group field.

Then click on each QTC serie highlighted lines. Again, they will be passed automatically to the "QTC Receive" window.

- Sub VFO programming from the bandmap: added for Tentec Orion, FT-2000, FTDX-9000
- SWAP Radios feature rewritten. To be tested with various rigs!

## Win-Test Wiki

- CW-Reverse mode added for some Radios:

- ◇ Orion
- ◇ All Kenwood Radios supporting CW-Reverse
- ◇ All radios using a Kenwood-based protocol which are supporting CW-Reverse (Elecraft, SDR-1000).
- ◇ All Icom which are supporting CW-Reverse.
- ◇ FT-1000MP/MkV, FT-2000, FTDX-9000

Other rigs can be considered as far as the protocol can handle it.

Please tell us!

There is no setting in WT in order to enable/disable this feature.

Just set the CW Reverse on the radio, WT will remember that setting for the next time the mode must be programmed onto the radio.

- ARRL Field Day: LOG layout reorganized.
- FT-1000MP: RIT is cleared but status is preserved when frequency change. Tks N6TV.
- V/UHF and 50/70/V/UHF contests with gridsquares as mults and one point per QSO. Tnx G4HSU & G4PIQ.

## Bugfixes

- Bugfix: In the WAE contest, opening the QTC Receive/Transmit window was not working as expected. Fixed. Tks IZ3EYZ.
- Bugfix: Polling Rate Combo Box of the "Interface Configuration" window was empty. Fixed.
- Bugfix: Transmitting status in the Secondary Radio fixed in RTTY mode. Tested with no SO2R interface.
- Bugfix: Selecting a single non-alphanumeric in the RTTY windows issued a crash. Fixed. Tks DL6RAI.
- Bugfix: The CQ repeat mode was not activated when clicking on the "F1" button of the RTTY window. Fixed. Tks VE2FWW.
- Bugfix: Under certain circumstances, a dupe QSO was not credited to 0 point in both NCCC Sprint and NA RTTY Sprint contests. Tks N6TV.
- Bugfix: FT-2000 / FT-9000, the active VFO in WT was thrall to the RX VFO of the radio. Correct way is to thrall the TX VFO of the radio. Fixed. Tks G4IRN.
- Bugfix: VFO B programming of the Orion fixed. In addition, a timer now ensures to always wait at least 100ms between each commands sending. Tks SM6CNN.
- Bugfix: NAQP, NA Sprint and NCCC: Database Updates was saving the OP Name instead of the State/Province/Country. Fixed. Tks N6TV.

- Bugfix: ARRL Field Day: ARRL/RAC official sections modified according to the rules. Tks VE3SY, 9A5CW, N6TV.
- Bugfix: in RTTY, QSOB4 was not working anymore. Fixed. Tks IN3JJI.
- Bugfix : All V/UHF contests : A QSO with own callsign gave one point.
- Bugfix : CW smartcorrect : Text commands are ignored now. Tnx N6TV.

## Release information (3.14.0) (Jul 25, 2007)

### Features

- Done some improvements and bugfixes in the NAQP contest. It now uses a specific "Equivalent State/Province" file: NAQP.DAT. It also uses the Cabrillo v3 specs for generating logs for the contest sponsor. The RTTY leg also supported.
- Added NCCC Sprint (NS) contest.
- The Run and S&P radio buttons of the Secondary Radio Window are now hidden when S&P mode is not active. Tks CT1BOH.
- New text command "MESSAGES" to open the "Standard CW/RTTY messages configuration" window (menu "Options | CW/RTTY | Modify Standard Messages). Text command "MSGs" is an equivalent. Tks N6TV.
- Elecraft K3 added to the list of supported radios. Tks F6BEE.
- Run/S&P switching capability menu renamed to improve the user interface.

### Bugfixes

- Bugfix : IOTA contest (and several others) : The guessed exchange was not correct. Tnx DL4CF.
- Bugfix: WT Windows of an imported Cabrillo log were not opened at startup. In addition, WT was loosing Focus. Fixed. Tks N6TV, I4UFH.
- Bugfix: Under certain circonstances, the exchange was not filled in for stations previously worked. Fixed. Tks N6TV.

## Release information (3.13.0) (Jul 23, 2007)

### General

**CAUTION : New network protocol version 1.20 released - Reminder : If you use WT in a networked environment, you must have the same WT version on all machines !**

## Features

- The generated CABRILLO files for both CQWW DX and WPX are now in the CABRILLO V3 Format.
  - Cabrillo V3 (in addition to Cabrillo V2) can be imported.
  - NAQP fields reorganized. Unfortunately, this inverted the "OP name" and "State/Province/Country" field in the WTB binary file. It means that if you open an old NAQP file done with Win-Test, the "OP name" and "State/Province/Country" will be on the wrong places. There is a workaround if you want to open an old NAQP file with the latest version of Win-Test: revert to an old WT version and generate a Cabrillo file from it. Then install again the latest Win-Test version, and import the generated Cabrillo. My apologies for these troubles but it was making sense to invert these fields in order to be more efficient with that contest, as well as with NA Sprint, NCCC... which share some of the same code.
  - NA Sprint contest added. Log for the contest sponsor is generated using the CABRILLO V3 specifications. Note that the State/Province will contain DX for non-US/VE stations whatever the operator logged in the field. Tks W0YK, N5KO, K3LR, N6TV and others.
  - Added support of the new TenTec Omni VII radio, which is actually based on the Jupiter command sets.
  - Added a Search & Pounce Operating Mode feature in order to have two different sets of CW/RTTY messages: one when running, and one when searching multipliers.
    - ◇ The Run and S&P sets of messages are editable in the "Messages" Tab of the "Standard CW/RTTY Messages Configuration..." window.
    - ◇ Use CTRL+TAB to switch between RUN and S&P mode on the Primary Radio. The status of this mode is shown in the clock window. To change the mode of the Secondary Radio Window, use either SHIFT+CTRL+TAB or a mouse click on the appropriate control in the Secondary Radio Window.
    - ◇ It is possible to configure WT to automatically wipe the logged QSO or populate the Band Map when the operator changes the radio frequency, as soon as the Search & pounce mode is activated on that radio. This can be configured from the "Band Map Properties" (right click in the Band Map windows).
- NB:** Search & Pounce is not activated by default. This can be done in the menu "Tools | Data Entry | Search and Pounce".
- The \$QSOB4 content macro can be redefined in the "Options" Tab of the "Standard CW/RTTY Messages Configuration..." window. That macro doesn't support any variable in, except \$MYCALL. Tks N6TV.
  - **Sprint Logic** feature added. Applicable in the EU Sprint, NA Sprint and the NCCC Sprint contests. When activated, WT decides which INSERT CW/RTTY Message must be sent according to the "Rcvd QSO Number" field.

## Win-Test Wiki

- ◇ When that field is empty, WT assumes that the operator just called CQ, and then sends the INSERT message of the "RUN" mode.
- ◇ When that field is not empty, WT assumes that the operator just replied to a CQ, and then sends the INSERT message of the "S&P" mode.
- ◇ This feature can be enabled/disabled in the "Options" Tab of the "Standard CW/RTTY Messages Configuration..." window. Other contests are not affected by this option.

Tks N6TV, K3LR, K0XP, N2NL and many others.

- New option to "Stay in Field when moving in the log", in order to avoid having the cursor always back on the callsign field. Option is in menu "Option | Log".
- Summary wnd (Alt-S) : New option to include or not the dupes in the QSO counts and the avg calculations.
- REG1TEST files : The New Country flag in VHF+ contests is now set in an appropriate manner. Tnx HB9DFD.
- QSO deletion : The warning message is now more informative. Tnx N6TV.

## Bugfixes

- Bugfix: In the specific case where one was operating a contest with a separate serial number per band, changing band on the Secondary Radio when the cursor was not in the last position of the log in the Primary Radio, the serial number set for the Secondary Radio might be wrong. Fixed.
- Bugfix: The Precedence field were not corrected in the log when modified in a previous logged QSO. Fixed.
- Bugfix: The Multiplier window was always showing DXCC for all bands, even for a contest which the band doesn't care in for DXCC multipliers. Fixed. Tks N6TV.
- Bugfix : The INVENTORY command was filtered by WtTunnelSrv and could only be used within a LAN. Tnx F6IFY.
- Bugfix : Internal CW generator : Under certain circumstances, the inter characters space was dropped. Tnx TA2RC, OH2UA.
- Bugfix : Log display : When working CW or RTTY, a 5-char received exchange was truncated. Tnx F5HRY/TM0HQ.
- Bugfix : When using Ctrl-K to delete characters behind the cursor in CW, and under other certain circumstances, \$LOGGED was not updated. Tnx N6TV, CT1BOH.
- Bugfix : Under certain circumstances there was no separator space between zones in the Alt-Z wnd, when marks were displayed.

## Release information (3.12.0) (Jul 11, 2007)

### Features

- Frequency Offsets (ie when the rig is used with a transverter) added. Settings can be done in the menu "Options | Frequency Offsets".
- Helvetia VHF/UHF/Microwave contest added. Tnx HB9DFD, HB9DUP, HB9CEX and others...
- IOTA contest : If an IOTA ref is entered in the appropriate field of the log, \*only\* QSOs with this IOTA are displayed in the multipliers wnd (F10). Tnx MM0BQI.
- IOTA contest : If an island reference is entered in the Exchange input field of the contest configuration dialog, the CW messages include it in the predefined messages. Tnx TA2RC.
- The summary file (.sum) now uses the standard CRLF newline characters. Tnx DL6RAI.
- Internal CW generator (LPT and COM outputs) : The PTT hold time is shortened. It is abt one dot long now. Tnx YT1NT.
- DXpedition HD : Dupes count added in the summary wnd, and DUPE indicator added at the end of log lines, if applicable. Tnx G4IRN.

### Bugfixes

- Bugfix : REG1TEST output log was broken.
- Bugfix : CQWW WPX M/2 : Under some conditions, the sent serial number wasn't consistant when a spot was grabbed. Tnx DL6RAI.
- Bugfix : Some english spellings fixed. Tnx G3TXF

## Release information (3.11.0) (May 18, 2007)

### General

**CAUTION : New network protocol version 1.18 released - Reminder : If you use WT in a networked environment, you must have the same WT version on all machines !**

### Features

- Help files : Online help now leads to the Win-Test wiki site. Every dialog and child window has its own help page. Special tnx to the wiki team M0CLW, DL6RAI, DL4NER, I2WIJ.
- VHF+ contests : Distances can be expressed in miles :

New option to display distances in miles in all windows except the stats windows where new items were added (Miles and avg mi/QSO) to ensure compatibility and consistancy. The objectives keywords allowed for distances are now :

Distance in km => KM DISTKM  
Avg distance in km => AVGKM KMAVG  
Distance in miles => MI DISTMI MILES  
Avg distance in miles => AVGMI MIAVG

To avoid any confusion, the DIST and DISTANCE keywords are no more valid. A new field has also been added in the export function to get QSO distance in miles. Tnx K3LR, W9ZRX.

- Gridsquares map (Alt-L) : The current gridsquare (4-chars) is displayed even if the callsign field is empty. Tnx DK5TX.
- Interface setup dialog : The last part of the IP broadcast address can now be different from 255. Tnx SP5ELA.
- Field Day IARU Rgn 1 (RSGB) : CW and SSB legs have now different method of scoring, according to the different RSGB rules. Tnx G3TXF, GM0ELP, G3UFY and others...
- JIDX contest : 160m band added for the CW leg. Tnx F5IN.
- ARI contests : The (IS0) Medio Campidano province abbreviation changed from MD to VS. Tnx ON5GQ.
- RDXC : SH oblast renamed to YA (official abbreviation, according to the RDXC website). The WT\_OBL.DAT and OBLASTS.DAT file are now updated accordingly. Tnx HA1AG.
- New option in the Options / Automatic backup dlg to notify the user when a backup is completed by a warning under the log lines.
- Markers files (.mkr extension) : If the comment includes a valid 4-char or 6-char grid square, the tooltip displays the heading and the distance to this grid square. It also displays the marker label if it is not entirely visible in the bandmap wnd.

## Bugfixes

- Bugfix : Helvetia (H26) contest : Mixed category allows only one QSO per band, whatever mode used. And Cabrillo output log in multi category now mentions the mode category (CW, SSB, or MIXED). Tnx DJ3WE and HB9CZF.
- Bugfix : Spelling and grammar mistakes in menus and dialogs. Tnx ES5TV, DL6RAI.
- Bugfix : WPX contest : Some very long and fake callsigns (like SIROCCO92, EIOLEKUINO, WWWWWWWWWWWW1 or such) could crash WT. Tnx ES5TV and 9A5CW.

## Release information (3.10.0) (Mar 22, 2007)

### Features

- New tool : Time shifting, in the Tools menu.



## Win-Test Wiki

You can time shift selected Qsos by any amount of time amount in both directions. You can apply the time shift for the entire log, for the Qso entered by your own station, for Qso entered by several stns, or a range of Qsos.

Even if this tool is more supposed to be used after a contest, to correct a wrong clock setting, each time corrections is broadcasted to the other stns of the network by default. You can disable this broadcasting to save time, if not needed.

Note that time shifting is pretty CPU intensive and it may take a certain amount of time for large logs, because each Qso modification requires internal structures (mainly statistics) to be updated.

**Note** : Hesitating and wise users are encouraged to perform a backup of their log before proceeding. Time shifting can't be cancelled while it is in progress, to avoid any log inconsistency..

- Main log window : New option in Options / Log menu to hide the QSO number column. Tnx RW3AH, SM3WMV.
- Main log and secondary radio windows : To ease reading, the received RS(T) and the received exchange are now separated by an half space wide blank area.

Note that it is still *\*one unique\** field. It is only a display trick.

- New feature : Band segments for bandmaps

You can now display segments in the bandmap tab of the radio windows. Segments are defined by textual files with a .seg extension located in the Win-Test directory. You can use and display up to 10 files simultaneously, by selecting them in the Options / Data files / Segments files... menu.

Note that, because of the available area constraints, you can't have more than 5 segments displayed per band for a given frequency.

You can display or not the loaded segments by using the contextual menu item Display Options / Segments / Display. This setting can be different for each radio.

The syntax of the segments files is very basic, and are very easy to create with a simple text editor like notepad.

A segment is defined by its minimum frequency (in kHz), its maximum frequency (in kHz) and an optional tooltip (30 chars max.). The two frequencies can be linked by an hyphen.

Two sample files are located in the WT repository: <http://download.win-test.com/files/segments/>

◇ **UsSegmentsDetailed.seg** displays all band segments for every US licence type.

◇ **UsSegments.seg** displays all band segments in which all US licencees are potentially active.

Tnx DL1MGB for inspiration.

- New feature : Markers for bandmaps.

## Win-Test Wiki

You can now display markers in the bandmap tab of the radio windows. Markers are defined by textual files with a .mkr extension located in the Win-Test directory. You can use and display up to 10 files simultaneously, by selecting them in the Options / Data files / Markers files... menu.

You can display or not the loaded markers by using the contextual menu item Display Options / Markers / Display. This setting can be different for each radio.

The syntax of the markers files is very basic, and are very easy to create with a simple text editor like notepad.

As usual, you can double-click on a marker to set the current radio on the freq. of the marker.

A sample file is located in WT repository: <http://download.win-test.com/files/markers/>

◇ **NcdxfBeacons.mkr** it displays markers for each NCDXF beacon.

Tnx DL1MGB for inspiration.

- WPX contest : Mult wnd (Alt-M). Band selection menu item removed. It also applies for the RDAC contest. Tnx I4UFH.

## Bugfixes

- Bugfix: \$TR1 and \$TR2 macros were not working using the microHam MK2R interface. Fixed. Tks OH2UA.

## Release information (3.9.0) (Mar 13, 2007)

### Features

- Added a tool for searching the logged exchanges which are potentially bad according to the database or to the other QSO made with the same station during the contest. Works for CQWW, ARRL DX or any contest in which there is something which apparent to a zone. It also works for the VHF contest when a gridsquare is logged. Look at this tool in menu "Tools | Check Log | Search for possible Bad Exchanges".
- Added a tool for searching N+1 for each unique logged callsign in the log. A unique callsign is considered as this as soon as it appears only one time in the log (contact only on one band and mode, and no dupe).

N+1 can be searched against the log, the callsign database (master database) or both.

It is possible to disable the N+1 search for the unique callsigns which are known in the callsign database. Look at this tool in menu "Tools | Check Log | Show Uniques".

- Coordinates (Long/Lat) expressed as decimal degrees added in the fields list which can be exported in text or CSV format. They are calculated from the country file used when the log was created, or the

gridsquare received, if any (mostly in VHF+ contests).

- QSO time in Unix time stamp format, frequency in MHz and QSX in MHz also added in the fields list which can be exported in text or CSV format.
- RDXC : Summary wnd (Alt-S) : Dupe column added for mixed category, and consistency check between the mixed category and a monomode category:
  - ◊ QSO column : Includes QSOs (even invalid ones) but not the dupes
  - ◊ Dupes column : Includes dupes only
  - ◊ Avg column = Total pts for the band / QSO column (see above).

Tnx I2WIJ

## Bugfixes

- Bugfix: "\$STR1" and "\$STR2" commands were not working in SSB when placed at the end of a scenario. Fixed.

## Release information (3.8.6) (Feb 26, 2007)

### Features

- It is now possible to use any "\$MACROS" (\$F1, \$F2...) in the additional messages as well. Tks N1FIC.
- Child wnds positions, sizes, colors and Z-orders are saved in a "smarter way" than before. Tnx DL6RAI.

### Bugfixes

- Bugfix: Workaround: Reverting back to the old way to ESCape a voice message. This is an emergency fix, just before a major contest. Tks EI3JE and I2WIJ.
- Bugfix: The RTTY additional RTTY message (ALT-C) was producing CW. Tks DL1IAO.
- Bugfix: When Keyboard Mode (ALT-K) is initiated during an F-key message ALT-K will not accept any more input when the type ahead buffer got empty (i.e. when typing too slow). Fixed. Tks DL1IAO.
- Bugfix: When pressing INS in an empty log line, no serial number is sent. Fixed. Tks DL1IAO.
- Bugfix : WPX RTTY : 160m band removed. Tnx F5CQ.
- Bugfix : WPX RTTY : Scoring updated. Tnx F5CQ.
- Bugfix : WPX RTTY : Serial numbering for M/2 category is now compliant with the rules : One

numbering sequence per transmitter.

## Release information (3.8.4) (Feb 8, 2007)

### Features

- New shortcuts introduced in [Spots wnd (Alt-A)] and in [radio Bandmap] --Tnx DL4NER, W9ZRX @ K3LR and G3OZF.
  - ◊ Ctrl + Dbl click on a spot deletes this spot (no warning)
  - ◊ Alt + Dbl click on a spot loads the sub VFO (if applicable)
- Edited spots are now considered as op-entered and are transmitted across the network. Tnx DL6RAI.
- Check partial window contextual menu items regarding the 2-char options re-labelled to improve the user interface. Tnx DL6RAI.
- Data entered in the contest settings dialog are now trimmed. Tnx W9ZRX @ K3LR.
- The CW Narrow Filter is now set on the IC-765. Tks DK4YJ & K8BB. Done also for the IC-756. Tks F5VIH/SV3SJ.

### Bugfixes

- Bugfix: Frequency was not read correctly on a FT-1000 when inserting a spot in the bandmap. The Split mode was not working either. Fixed. Tks N8TR.
- Bugfix: DK4YJ reported that sending mode information to his IC-765 always changes the filter bandwidth to 2.4 KHz in CW. For this reason, ALT+F4 now changes the mode of the radio only when necessary. Tks DK4YJ.
- Bugfix: With the "Independent speed" option in WinKey ticked, using ++ or -- in the message was changing speed to the paddle speed. Tks VE2FU.
- Bugfix: the \* key used to switch radios in SO2R caused an Icom radio that is being switched to always activate the VFO-A as default. Fixed. Tks K8BB.
- Bugfix: Station names containing a space in the first position of the string was misordered in the "Send GAB" window. Fixed. Tnx W9ZRX @ K3LR.
- Bugfix: Tentec Omni VI support is now based on the Generic Icom settings. Tks K7SV, DK4YJ and F6IFY.
- Bugfix: Entering Split on any Icom radios was always setting the mode to SSB, regardless of the current mode. Fixed. Tks K3LR.
- Bugfix: Protocol issue with either the FT-2000 or the FTDX-9000, grabbing a callsign from the bandmap was activating the split on the radio. Tks F8CIL, G4IRN.

## Release information (3.8.0) (Jan 18, 2007)

### Features

- Radio wnd / Bandmap tab : New CQ and QSY cursors to display the last CQ freq and the QSY freq of the band. These cursors can be displayed or not, according to the contextual menu settings (Display options).
- NAQP contest : When entering a NA QSO, WT now ensures all field are filled. Tnx K8BB.
- Summary columns re-order for:
  - ◇ the ARRL DX to BAND/QSO/MULTS/DXCC/DUPES
  - ◇ the CQWW DX to BAND/QSO/CQ/DXCC/DUPES/POINTS/AVGwhich is the usually used order. Tks K3LR.
- MicroHAM MK2R SO2R Protocol is now fully supported. To enable it:
  - ◇ in microHAM USB Device Router, check "microHAM SO2R protocol on COM port" in the "SO2R" tab. You can also specify "SO2R protocol controled" for RADIO 1 and/or RADIO 2 in the "ACC" tab if you want to let Win-Test control the ACC outputs to switch the antennas.
  - ◇ in Win-Test, select "MicroHAM MK2R" on the COM port the USB Device Router is attached to for SO2R control. As it is a virtual COM port, the COM port configuration (bauds, parity...) has no effect: you can choose anything.

The new macro `$MK2R=<cmd>` has been added in order to send any protocol to the MK2R from a scenario. This can be usefull to set a specific audio configuration which is not a standard R1R1, R1R2 or R2R2. For example, `$MK2R=FRD100000010000` will configure the headphones audio to "Left=RADIO1,MAIN VFO and Right=Radio1,SUB VFO". Please report to the SO2R protocol specification of the MK2R to get details on the `FRDxxxxxxxxxx` command as well as on other ones.

Note that WinKey and PTT/CW events of the Win-Test integrated keyers are not handled by the protocol. It means that if you want to use Win-Key or the WT integrated keyers you must configure them separately. The PTT/CW signals can share the COM port used for the SO2R control. WinKey will require a different COM port in any case.

- In RTTY Configuration Window: Added two options:
  - ◇ MMTTY window stays on top: when enable, the MMTTY window will be always visible
  - ◇ Only show FFT spectrum, waterfall and XY scope: when enable, the MMTTY window is minimized, and does not show the Menu nor the Command Buttons.
- Added a new "RTTY" entry in menu "Options" to allow modifying the standard and additionnal messages. Also allowed to access the messages entry in the menu "Command".

## Bugfixes

- Bugfix: Internal keyer + Winkey. Tks G3SJJ.
- Bugfix: the "Copy-Paste the previous QSO" function is now available only when the cursor is on the last line of the log. Tks DL6RAI.
- Bugfix: TXing in RTTY was not canceled anymore pressing the ESC Key. Fixed. Tks F2JD.
- Bugfix: Focus problem with MMTTY is fixed. Tks DL6RAI.
- Bugfix: using a SO2R interface based on LPT port, in a message like "\$F1 \$TR2 \$MSG1", the \$TR2 macro had no effect. Fixed. Tks S51TA.
- Bugfix: Using WinKey, the CW speed of the paddle was changing under certain circumstances. Fixed. Tks DJ3WE and G3SJJ.
- Bugfix : NAQP contest : Under some circumstances, the SPC field was cleared while editing the QSO. Tnx K8BB.
- Bugfix : PACC contest : From PA side, working PA stns gave credit for province. Now, it only gives credit for PA DXCC country. Tnx PC2A.

## Release information (3.7.0) (Dec 1, 2006)

### General

3.7.0 introduces station profiles to help users who are frequently changing of callsigns / address etc... and an integrated file fixer for corrupted data files.

### Features

- The "Goto QSO" command now checks if the QSO where we want to move from is valid. It also validates that QSO before moving.
- Bandmap properties : You can now set two different lifetimes for DX cluster spots and op-entered callsigns. The maximum DX cluster spots lifetime is 60 minutes, and the op-entered spots lifetime is 120 minutes. Tnx ES5TV.
- Main log wnd : Any entered Q by a MULT stn which is not a mult is tagged with an "!!!!" indicator.
- Radio wnds : The last used tab is saved as default for further reloading or new log creation. Tnx ES5TV.
- Stats wnd : The last used tab is saved as default for further reloading or new log creation.
- The QSX freq of a cross-band spot is now ignored. Tnx DL4NER.
- Corrupted files can now be fixed once an error is detected while loading. The original file is saved

with an "\_err" suffix appended to its name. CAUTION : This fix function doesn't work with corrupted data described here: <http://www.f5mzn.org/pipermail/support/2006-November/072424.html>

- Real-time scoring informations entry fields added in the contest settings dialog : DXCC prefix, WAZ and ITU zones, State/Prov/Other. \*These data are only useful for real-time scoring\* and are not used for other purposes in Win-Test. They are not yet available in the SUMMARY network frames (to come). Tnx 5B4WN/G0WWW.
- The initial CW speed for new files can now be set by using the Options | CW | Initial speed... menu item; Tnx I2WIJ.
- You can now record 5 different station infos (callsign, name, address, etc.) presets (also called station profiles) in the contest settings dialog.

### Bugfixes

- Bugfix: packet cluster window content was lost after any change in the "Interface Configuration" window. Fixed.
- Bugfix: with the "Spot entered or sent by the operator, Log Fields are cleared" activated, sending a spot for the QSO logged above was clearing the line on the screen. Fixed. BTW, WT now takes the last QSO logged on the current station (if any) rather than the last QSO logged on any station of the network.
- Bugfix: REPEAT mode was not working with WinKey, nor the TX LED in the secondary radio window. Fixed. Tks F5JSD.
- Bugfix : When grabbing a spot, the N+1 and checkPartial wnds were not updated. Tnx DL4NER.
- Bugfix : The default "+" CW message wasn't including a trailing space after the \$CORRECT variable. This error led to a bad implementation of the \$CORRECT variable, and an extra space was inserted if the default message wasn't used. Tnx PA2A, DL4NER and others.

### Release information (3.6.2) (Nov 23, 2006)

#### Bugfixes

- Bugfix: in SO2R, repeat mode was not interrupted by a transmission on the secondary radio when using the SHIFT key. Fixed. Tks CT1ILT (CT6A).
- Bugfix: entering a callsign in the bandmap with an SO2R setup using two FT-1000D/MP/MK5 or two FT-100 or two FT-900 was in certain conditions inserting the entry into the wrong bandmap. Tks CT1BOH (CT3NT), CU2/OH2UA.

### Release information (3.6.1) (Nov 21, 2006)

## Bugfixes

- Bugfix: Double click on the WTB file was broken. Fixed. Tks I2WIJ.
- Bugfix: In SO2R Advanced Mode, when the secondary radio was bound with CAPS LOCK, automatic CQ was always stopping as soon as the operator pressed any key. Fixed. Tks CT1ILT (6Y3T, CT6A).

## Release information (3.6.0) (Nov 20, 2006)

### General

**CAUTION : New network protocol version 1.17 released - Reminder : If you use WT in a networked environment, you must have the same WT version on all machines !**

### New Features

- Added command line arguments:

◇ wt.exe [--alternative-inil-i <infile>] [WTB file to load] Tks DL6RAI.

- Added a "Polling Rate" option in the Interface Configuration Windows. Note that it is not exactly the Polling Rate which is defined here, but the delay before polling the radio again after the previous sequence is done. This delay is not so accurate with every radio. Check by yourself to see what is the value which best fits your needs!
- SteppIR controler is now supported with an Y cable. Special thanks to G3BJ.
- Main window : Extra large font added. Tnx W2RU.
- New graphics in the rate wnd (Alt-R) : Instant continents distribution. Uses the same moving parameters as the instant rates chart. Tnx CT1BOH.
- Rate wnd (Alt-R) : New options to display or hide non-essential sections of this wnd.
- New text commands QSX and NOQSX (equivalent to SPLIT and NOSPLIT).
- New text command REMAPKEYS (equivalent to DEFINEKEYS)
- Partner wnd : New real-time feature to display the callsign field of the partner(s) log(s) while he (she) is entering a callsign. See the contextual menu of this window. A runner can have up to three different support partners. To grab the first real-time slot, use Alt-Space. In all cases, you can also double-click on any callsign of this window. Tnx K3LR
- DX cluster (Alt-A) and radio wnds : A "\*" indicator is displayed before the spot callsign when there is a QSX for this spot. Tnx K3LR.



## Win-Test Wiki

- Send spot dlg (Alt-F3) : The log fields clearing after a spot has been sent is applied the same way as the self-entered spots (see the bandmaps properties contextual menu dialog).
- Score sending : "Send now!" menu item added in the summary contextual menu. It is enabled only if the score sending is enabled.
- Commands | Station type : The settings can now be sticked to the computer. If so, it will be used for any newly created logs. Tnx K3LR.
- Stats wnd (Ctrl-F9) : DXPed : Stats period extended to 4 days.
- DXPed HF and VHF+ logs : The ADIF export includes the info field in the NOTES ADIF field. Tnx FY1FL.
- Status wnd (Alt-J) : The list can now be sorted by band and by stations names if several stations are on the same band.

## Bugfixes

- Bugfix : Most of the VHF+ contests didn't have a final score line in the summary window (Alt-S), which prevented any real-time score posting. Tnx F5LEN.
- Bugfix : Alt-F4 set the radio in split (even if it originally wasn't) and a QSX freq in the nirvana ! Tnx DL6RAI, DL4NER and others.
- Bugfix: FT-1000MP in SO2R mode: in Split Mode, swaping radios was inverting TX and RX frequencies on the FT-1000MP/Mk5. Tks EA5BY and F5CWU.
- Bugfix: Could not enter a QSO to the bandmap from 2nd radio window. Everytime a callsign was typed to 2nd radio window and CTRL-Enter was pressed, the QSO was set in main radio band map to the exact QRG of the main radio. Fixed. Tks OH2UA.
- Bugfix: Using WinKey, the \$CORRECT variable was sending the logged callsign in every case, even if the callsign was not changed by the operator. Tks G3BJ (G5W).
- Bugfix: the selection of the active Sound Card when more than one is available was broken. Fixed.
- Bugfix: a short delay might be introduced when ESCaping (stopping) a recorded message played by the Internal Voice Keyer. Tks K3LR.
- Bugfix: stereo signal was not working on LPT port Pin 5. Fixed. Tks 5B4WN/G0WWW & GM0GAV.

## Release information (3.5.0) (Oct 22, 2006)

## General

**CAUTION : New network protocol version 1.16 released - Reminder : If you use WT in a networked environment, you must have the same WT version on all machines !**

## New Features

- Added CTRL+S as a shortcut for the menu "Commands | Swap the frequency on both radios". Tks EA5FV & co.
- CheckPartial and N+1 SCP files : If a DEFAULT.SCP or DEFAULT.DTA is in the WT directory, it will be used as default file for partial and N+1 checks instead of contest-specific default file. Tnx ES5TV.
- When a log is opened in a networked environment, the date of the first QSO must match the others logs date with 20 days tolerance. If not, a warning is issued and the network and the sync are disabled by default on this machine. You can override this behaviour if you really know what you're doing!
- NRAU Activity Contest (NAC) : 50 and 70 MHz added. Tnx SM3PZG.
- TXT and CSV file exports : New fields added : Date (DD-Mmm-YYYY), date (DD-Mmm-YY), Freq in Hz, QSO in kHz and Hz.

## Bugfixes

- Bugfix : RELOAD'ing a file was disabling the integrated keyer (Phone or CW) and could lead to a major crash under some particular circumstances.
- Bugfix : NRAU Activity Contest (NAC) : Bonus points per new gridsquare are now considered in the score. Tnx DL1OJ.
- Bugfix : NRAU Activity Contest (NAC) : The spacebar now loops the cursor between callsign, received RST and gridquare fields. Tnx DL1OJ.
- Bugfix : MMTTY windows were closing themselves after 10s. Fixed. Tks everybody! :)

## Release information (3.4.5) (Oct. 8, 2006)

### New Features

- Added two "Intelligent Quick Qsl" Macros: \$QQSLT and \$QQSLC. When used, these macros send two different confirmation messages, one a short QSL message (like TU or EE) and one long QSL message (like TU F5MZN).
  - ◇ A timer (\$QQSLT macro) or a counter (\$QQSLC macro) are associated with these macros to determine if either a short or a long QSL message is to be transmitted.
  - ◇ That way you can send a most of the time a short QSL message to confirm the QSO in a pileup, sending your full callsign automatically every minute or 5 QSO only.

## Win-Test Wiki

- ◇ You can adapt the counter or timer values as well as the short and long messages in the "Intelligent Quick QSL" configuration window, from the Tools menu.
- ◇ You can use the \$QQSLC and \$QQSLT macros either in the CW/RTTY Messages or in the advanced SO2R scenarios. It is also possible to use the feature in SSB (SO1R and SO2R not advanced) but this needs a specific configuration in the SSB tab of "Intelligent Quick QSL" configuration window.
- Caps Lock can now be used to bind the keyboard to the Secondary Radio Window. This can be enabled or disabled in the Operating menu. Tks SM3WMV.
- Signal "Headphones Control" (called "RX Focus" in the MK2R microHam SO2R interface) is now available on LPT, pin 4. This signal allows to control which radio you want to listen in the Headphones. Must be enabled in the LPT Configuration Window. Low = RADIO 1, High = RADIO 2.
- Signal "Headphones Control" and "Stereo RX Audio" are now available on either DTR or RTS pins of any serial COM ports. That way, the MK2R microHam SO2R interface can be fully controlled through a single USB cable.
- Microham MK2R interface is now supported in SO2R Advanced mode.
- QSY wizard wnd : Ensure that HamCAP is alive and that the chart tab is in the one selected in the Options | HamCAP | Tab menu. If not, the label "Disabled" is displayed in the window. Tnx SM3WMV.
- Worldmap window : New option to display only the terminator of the greyline. If chosen, a small sun symbol also is displayed on the map.
- Secondary radio wnd : When a binding key is used (see Operating menu), the color background of the QSO area is changed. Tnx F6IFY
- Secondary radio wnd : Complete color management, similar to the other child wnds.
- Check Partial files : WT now accepts the master.dta (CT format) or master.scp (textual) files as default check partial files for the HF contests. Note that the scp format is a bit quicker to load than the dta format.
- Ctrl-W in the sent report or exchange fields now resets this field to the default 59 or 599 report (depending on the mode). Tnx LX1NO.
- To enhance the CT compatibility, Ctrl-K now deletes the content of the current field, from the cursor position to the end of the field. It also works for the secondary radio with the Shift key, if this option is engaged in the Operating menu.
- Register dialog : The light-headed licences can now enter their account customer number to recall it when needed.
- New options to start and stop locally wtDxTelnet in the Options / DX cluster menu. wtDxTelnet \*must\* be installed in the same directory as WT (which is its default installation directory).

## Win-Test Wiki

- Macros added in the Packet Dlg window (Alt-T). To edit a macro button Shift-Click on it. Note that the Conn and Bye btns are still disabled for now. This should be improved in the future.
- Numerous new labelling and graphics elements resizing to accomodate with the German language version. Tnx DL6RAI.
- Split freq dlg (Minus key) : The entered freq is checked against the current band. Tnx W9ZRX.
- CheckPartial files : If a general contest-specific file is loaded, no band, mode or band/mode default file is loaded.
- ON Contest 80m, 6m and 2m added. Tnx F5IN.

## Bugfixes

- Bugfix : UBA Spring contests : Small inconstancies in the UBA sections list. Tnx F5IN.
- Bugfix : CQWW RTTY : The guessed zone from a previous entered Q was not filled if using the spacebar guessing. Tnx DJ1OJ and DL6RAI.
- Bugfix : Packet Dlg wnd (Alt-T) : SH/WWV and SH/WCY were sharing the same accelerator key (Alt-W). Now, SH/WCY uses Alt-Y.
- Bugfix : Under some conditions, WWV announcements coming from DXNet packet clusters were not always considered.
- Bugfix : The taskbar was flashing if the Packet Dlg (Alt-T) was in foreground, and a private gab was received.
- Bugfix : The WCY and WWV text commands were closing the solar activity wnd if it was opened, instead of changing data source.
- Bugfix : Packet Dlg (Alt-T). Even when using the macros and shortcuts buttons, the focus is now always set to the entry field.
- Bugfix : CQWW RTTY : When changing band by Alt-F1/F2, the states/provinces window was not updated. Tnx DL6RAI @ DQ4W.
- Bugfix : CQWW RTTY : Under some conditions, the zone and the state/province fields weren't updated after grab. Tnx DL6RAI @ DQ4W.
- Bugfix: Sending a spot with ALT+F3 with split activated was not transmitting the RX frequency correctly. Fixed. Tks W9ZRX & K3LR.
- Bugfix: CTRL + ENTER in split mode fixed. Tks W9ZRX & K3LR.

## Release information (3.3.5) (Sep 20, 2006)

### General

**CAUTION : New network protocol version 1.15 released - Reminder : If you use WT in a networked environment, you must have the same WT version on all machines !**

### New Features

- Added support for the Yaesu FTDX-9000 radio. Tks VE6SH, OM7ZZ.
- Added support for the Yaesu FT-2000 radio.
- Added support for the Yaesu FT-857. Tks M0CRY.
- Icom radios: CI-V mode is back again as an option (you can now decide if you want to poll the radio or use the CI-V mode). This option is available in the "Interface configuration" window. Tks W9ZRX, K3LR.
- Programming an Icom radio is now more reliable (a check is done to ensure that the radio got the protocol) and more faster. Tks W9ZRX, K3LR.
- New option to start (resp. stop) wtDxTelnet when WT is started (resp. stopped) automatically in the Options / DX cluster menu. wtDxTelnet \*must\* be installed in the same directory as WT (which is its default installation directory).
- New RESTART text command, to (guess what ?) restart Win-Test.
- QSX are now parsed from the packet stream and are handled in the bandmaps and the DX cluster spots wnd (Alt-A). The split freq is also handled when spots are entered by the op with Ctrl-Enter (or Ctrl-J). Tnx K3LR.
- CQWW Contest : RTTY leg implemented. This implementation is not totally complete but is fully usable to take part in the competition. It will be improved later, especially when the new databases designs (including multi-field guessing) will be implemented.
- Child wnds : Font size : New menu items added to get larger and smaller font by one point, and a new "Other..." item to set a non-listed font size. Tnx W9ZRX @ K3LR.
- CheckPartial and N + 1 files can now be different of the "database" DTB file associated with the contest.

◇ WT now accept SCP (stands Super Check Partial) plain text files (one callsign per line - no ordering required), DTA CT files and DTB files for compatibility.

◇ The preferred format is SCP (plain text).

◇ Furthermore, WT now also accepts specialised CheckPartial files by band and by mode for a given contest. This improves log accurancy and QSO rates.

Please, read: [http://download.win-test.com/files/checkPartial/#\\_READ\\_ME#.TXT](http://download.win-test.com/files/checkPartial/#_READ_ME#.TXT) for more informations.

- CheckPartial (F8) and N+1 (F12) wnds : New contextual menu item to list the used files for the searches.
- WAE Contest : EU Side : The new multiplier warning now claims "New multiplier" instead of "New prefix". The multiplier indicator in the bandmap status has also been changed from C (Country) to M (Mult). Tnx DL1MGB.

## Bugfixes

- Bugfix : SAC contest : In M/M category only, the serial numbering is different for each band. Tnx SM6DYK.
- Bugfix : SAC contest : The CW variable \$SERIAL wasn't included in the default messages. Tnx I2WIJ and F5IN.
- Bugfix : Internal CW keyer : If a message was interrupted by ESC while a burst was sent, the speed didn't revert to the original speed. Tnx OH2UA, OH1JT and F6IFY.
- Bugfix: IC-7800 was not controlled as expected. Fixed. Tks W9ZRX, K3LR.
- Bugfix: under CW autosending mode, pressing ESC was disabling this feature in any case which was not always wished. From now, pressing ESC will disable autosending mode as soon as the key is not pressed when the radio is transmitting or if the caret is not in the callsign field. Tks ES5TV, UA6AA.

## Release information (3.2.0) (Aug 30, 2006)

### General

- CIS contest : Adapted to the new rules 2006 (bands : 160m to 10m). The Contests of the month feature is also updated. Tnx F5IN.
- RDA Contest : Cursor positioning after exchange guessing modified, depending on the guessed region or district and the callsign. Tnx HA1AG, UA6AA.
- TOEC contest : It is now held in September instead of August. Thus, the "Contests of the month" checkbox feature is updated. Tnx F5IN.

### New Features

- CheckPartial (F12) and N+1 (F8) windows :  
New option in the contextual menu to limit searches to the available space of these windows. It is only useful for very slow configurations : For a given callsign, once the window is filled, no more search is performed, even if the window is resized.  
By default, this option is disabled, meaning that if more matching callsigns are available (because [+n] is displayed), you can now display them by enlarging these windows on the fly.
- New network protocol advanced settings dlg in the interface settings dlg.

**CAUTION: Modifications of the default settings must be considered with an extreme attention. It is reserved for very particular configurations or purposes, mainly used by expert users. You're on your own!**

We offer some preset example configurations :

- ◇ Silent time master : Can be used if the computer is used to \*only\* distribute an accurate clock. It will not appear in the status wnd of the other networked computers, but it will be listed in an INVENTORY command. Note that NO QSO will be recorded on (and sent from) this machine with this preset.
- ◇ Silent backup : Can be used if the computer is \*only\* used for this purpose : It will not appear

## Win-Test Wiki

in the status window of the other networked computers, but will be listed in a INVENTORY command.

- ◇ Packet sharing : Can be used if different stations are networked with different callsigns, do not want a common log, but want to share a common packet stream. Can be used for several single-ops stations for example.
- ◇ Silent log rebuilding : Can be used if you need to rebuild from scratch a complete log from networked stations, without appearing in the status wnd of the other networked computers, but will be listed in a INVENTORY command.

- User interface : You can now drag any child wnd (except the RTTY windows) by using the Ctrl key (held down) and left-click anywhere in the wnd. It avoids to click strictly in the title bar region.
- New feature : Flexible and powerful bandplans management. See (among others) the Options / Bandplans menu item.
- Partner wnd : You can now enter data from the secondary radio wnd. Tnx OH4JFN.
- Partner wnd : New "No band/mode filtering" contextual option added. Might be useful in some unusual cases.
- New options in the integrated voice keyer settings to mute or not the microphone input.  
Reminder : These settings can be modified on the fly with the following text commands :

- MIC : Enables the mic input when the VK is not playing
- NOMIC : Mutes the mic input when the VK is not playing (\*)
- MICWHENPLAY : Enables the mic input when the VK is playing
- NOMICWHENPLAY : Mutes the mic input when the VK is playing (\*)

(\*) Default settings.

- Band changes Alt-F1/F2 : WT is now compliant with WL and CT :  
ALT-F1 Next lower band 20 -> 40 -> 80 -> 160 -> 10 -> 15 -> 20  
ALT-F2 Next higher band 20 -> 15 -> 10 -> 160 -> 80 -> 40 -> 20  
"Lower" means "Lower frequency"... The menu item labels, and the toolbar tooltips are consistent with this behaviour. Tnx I2WIJ, DL4NER, F6BEE.
- New Options / Windows / Default opened windows feature. This dialog allows you to select the default windows which are opened when a new contest log is created.
- Check partial wnd (F12) and N+1 (F8) wnd : A double click on a callsign inserts it in the callsign field. Tnx F6IRF.
- New extra informations window (Alt-X => Stands for eXtra). This window displays data included in .xdt (eXtra DaTa) files. These files are textual and have a very basic "Callsign Data" syntax. The # TITLE directive is used to display a title in the wnd.  
You can set up to 10 default extra data files by a new menu (Options / Data files / Default data files). : These files will be opened with every log. They must be located in the WT installation directory. You can also add log-specific extra data files by using the "Extra files..." item in the contextual menu of this wnd. There is no limitation to the location and the number of these log-specific files.  
Some usages of this new feature :

- ◇ VHFers can have a database of stations QRV on such or such band, to ask for a QSY.
- ◇ Operators names
- ◇ List of WT users ;-)
- ◇ etc...

This feature is tailored to deal with few thousands of callsigns only. Don't try it with millions of lines !

If you modify an .xdt file while it is in use, you must reload it by using the "Reload files" item menu.

## Win-Test Wiki

The # VARIABLE directive allows you to send the extra information in a CW message by using a variable name. The variable name \*must\* begin with the \$ character.

Example : # VARIABLE \$OPNAME will substitute the \$OPNAME string in the CW messages with the extra info included in this file, if the sent callsign has matching data.

**CAUTION : The variable substitution only works with the internal CW keyer for now.**

- To enhance CT compatibility, Alt-F5 saves the current mode and freq as the Run freq/mode. It means you can use this command to "store" these data without using the F1 key.
- ADIF export : If a power level is set in the contest setup dialog, this string is exported in the TX\_PWR field of every QSO record. Tnx W4TME.
- ADIF export : New option to include the contest name in the NOTES field of every QSO. Tnx W4TME.
- Cabrillo export : New option to exclude modes in the Cabrillo file. Tnx TM0HQ.

## Bugfixes

- Bugfix : CheckPartial wnd (F12) : In some cases, the result list was wrong if the pattern started or ended with a question mark.
- Bugfix : N+1 wnd (F8) : If the wnd width was smaller than one resultcell, WT crashed. Tnx DJ3WE.
- Bugfix : CheckPartial wnd (F12) : In some cases, the result list was truncated, although there was more available empty space.
- Bugfix : Some frequency fields (especially in dialogs) didn't accept the dot character.
- Bugfix : Partner wnd : Ctrl-# (exchange current callsign with line #) was crashing partner WTs.
- Bugfix : WAEDC : After entering the keyboard mode while the QTC window was opened (Alt-L), WT was crashing on the first keypress Tnx DL1MGB.
- Bugfix : Internal CW keyer : Speed modifications by Alt-F9/F10 during the +/- "bursts" \*should\* work now. Tnx OH2UA, OH4JFN, F5VIH and others.
- Bugfix : Check country wnd (F10) : The geographical and timezone exceptions included in the CTY\_WT\_MOD.DAT weren't used in the WAE, RGSB 15/10 and PACC contests. Tnx F5IN.
- Bugfix : After entering a freq, and hitting Alt-Up, the keyer sent the freq instead of the callsign ! Tnx F6BEE.

## Release information (3.1.0) (Jul 27, 2006)

### General

- **CAUTION : New network protocol version 1.14 released. Reminder : If you use WT in a networked environment, you must have the same protocol version on all machines !**

### New features

- Reverse mult check (Shift-F10) : If the mults are mode-dependent, (IOTA contest, ARRL 10 for ex.) worked stations are ordered by band and mode.
- Check mult wnd (F10) : When automatic update is engaged, any modification in the received exchange field updates this wnd accordingly. Tnx OH4JFN.
- Check mult wnd (F10) : New CQWW DX display policy for all displayed bands. Tnx OH4JFN.



1. The exact callsign is searched
  2. If not found, the same country with the same zone is searched
  3. If not found, the same country whatever zone is searched
  4. In all cases a zone indicator is also displayed :
    - ◆ 'Z' means the current zone is already worked in the current country.
    - ◆ 'z' means the current zone is already worked in another country.
- Contest settings dlg : New button to help filling the exchange field.
  - COM properties dlg : New button to set default settings depending on the COM port usage. Must be tested in the real world !
  - New Tools / Data entry / Remap slash to portable in VHF+ and FD option. This only works for callsign field in the log, for all VHF+ (DXPed included) and Field Day contests.
  - Automatic and on-demand backups (Options / Automatic backup) : You can now get one different timestamped file per backup. Tnx DL5MLO @ DA0HQ.
  - Backups : If a backup fails, you are asked if you want to disable the next automatic backups, if any.
  - Partner wnd : When a QSO is entered, or got from the network, the logged callsign is checked against the content of the partner wnd, and accordingly removed from it. Tnx DL1MGB & DL6RAI @ DA0HQ.
  - Partner wnd : When automatic exchange guessing is enabled, any grabbed callsign from the partner wnd is checked and exchange field is filled accordingly. The check partial and N+1 windows are now also updated. Tnx DL1MGB & DL6RAI @ DA0HQ.
  - Sked wnd (Alt-B) : Pops up for a hot sked only if the main WT window is not iconic, to avoid visual annoyance.
  - Commands / Remote command menu item added. Only enabled if there are several stns on the network.
  - Remote command dlg : You can now also locally apply the entered command.
  - Send gab dialog (Alt-G) : If the text starts with "/me", it is replaced with the station name, and the text is emphasized with leading and trailing star character (\*), a la IRC.
  - Status Wnd (Alt-J) : You can now enable (or disable) logging a summary of the network activity. Might be useful for network basic troubleshootings. This log uses the .ntk (stands for NeTwork) file extension.

## Bug fixes

- Bugfix : Under some circumstances, when a sync was in progress, multipliers tables were totally messed up ! Tnx TM0HQ and DA0HQ
- Bugfix : Automatic backup dlg : Setting the backup file path was disabling the automatic backup. Tnx DL5MLO @ DA0HQ.
- Bugfix : Merge progress bar title was corrupted. It now displays the master file name.
- Bugfix : If clocks were not in sync, the offtime timer could display negative time ! Tnx TM0HQ.
- Bugfix : INV (or INVENTORY) command : All networked stations were getting back the status, although only the sender was supposed to.
- Bugfix : Sked wnd (Alt-B) : Under some circumstances, the scrollbar was not initialized as expected.

## Release information (3.0.0) (Jun 22, 2006)

## New features

- RTTY support : Based on the MMTTY package (which must be installed separately), the 2-radios RTTY windows now allow you to take part in the RTTY contests with the same user experience as CW and Phone contests.
- Windows colors customization : Every color in the child windows can now be modified and saved on-the-fly. It means you instantaneously see the window aspect as you modify colors. No "try and see", nor numerous "apply" ! Of course, you can always revert to the factory settings if needed for one or all colors of the considered window.
- Log synchronization : Based on a peer-to-peer model, opened logs can be synchronized between all stations on-the-fly, without need of a central server. If new stations come in the network during a contest, their logs are automatically updated. Of course, you still can run and enter QSOs even if the sync is in progress.
- Partner window : Very useful in multi-op environment, if you have 2 ops (or more) listening the same frequency : The partner(s) can easily help his runner by entering callsigns (or part of callsigns) he hears.
- Remote commands : In a networked environment, you can send text commands to one, several or all connected stations. Every sent command is acknowledged in the Gab window.
- New log binary file format : The v2 binary format of the log files was no more adapted to add new major enhancements. Thus, we decided to expand it to allow more data per recorded QSO. The conversion to this new format is fully automatic. WT 3 will automatically convert your v2 logs to the v3 format, and save the original v2 file with the wt2 extension (mylog.wt2) if you want. This allows you to re-open this file with a WT 2 - just in case !

## Namespaces

- [Page](#)
- [Discussion](#)

## Variants

## Views

- [Read](#)
- [View source](#)
- [View history](#)

## More

- This page was last edited on 3 August 2009, at 08:17.
- [Privacy policy](#)
- [About Win-Test Wiki](#)
- [Disclaimers](#)



# Release Notes V3

From Win-Test Wiki

[Jump to navigation](#) [Jump to search](#)

## Release Notes

### Contents

- [1 Release information \(3.27.1-dev\) \(nightly\)](#)
  - ◆ [1.1 Bugfixes](#)
- [2 Release information \(3.27.0\) \(Jun 9, 2009\)](#)
  - ◆ [2.1 New Features](#)
  - ◆ [2.2 Bug Fixes](#)
- [3 Release information \(3.26.0\) \(Mar 26, 2009\)](#)
  - ◆ [3.1 New Features](#)
  - ◆ [3.2 Bugfixes](#)
- [4 Release information \(3.25.1\) \(Feb 13, 2009\)](#)
  - ◆ [4.1 New Features](#)
  - ◆ [4.2 Bugfixes](#)
- [5 Release information \(3.24.0\) \(Jan 15, 2009\)](#)
  - ◆ [5.1 New Features](#)
  - ◆ [5.2 Bugfixes](#)
- [6 Release information \(3.23.0\) \(Oct 22, 2008\)](#)
  - ◆ [6.1 New Features](#)
- [7 Release information \(3.22.0\) \(Sep 16, 2008\)](#)
  - ◆ [7.1 New Features](#)
  - ◆ [7.2 Bugfixes](#)
- [8 Release information \(3.21.0\) \(June 23, 2008\)](#)
  - ◆ [8.1 New Features](#)
  - ◆ [8.2 Bugfixes](#)
- [9 Release information \(3.20.0\) \(May 14, 2008\)](#)
  - ◆ [9.1 Bugfixes](#)
- [10 Release information \(3.19.0\) \(Jan 24, 2008\)](#)
  - ◆ [10.1 New Features](#)
  - ◆ [10.2 Bugfixes](#)
- [11 Release information \(3.18.0\) \(Nov 3, 2007\)](#)
  - ◆ [11.1 General](#)
  - ◆ [11.2 New Features](#)
  - ◆ [11.3 Bugfixes](#)
- [12 Release information \(3.17.0\) \(Oct 21, 2007\)](#)
  - ◆ [12.1 General](#)
  - ◆ [12.2 New Features](#)
  - ◆ [12.3 Bugfixes](#)
- [13 Release information \(3.16.0\) \(Sep 7, 2007\)](#)
  - ◆ [13.1 New Features](#)
  - ◆ [13.2 Bugfixes](#)
- [14 Release information \(3.15.0\) \(Aug 8, 2007\)](#)
  - ◆ [14.1 New Features](#)

- ◆ [14.2 Bugfixes](#)
- [15 Release information \(3.14.0\) \(Jul 25, 2007\)](#)
  - ◆ [15.1 Features](#)
  - ◆ [15.2 Bugfixes](#)
- [16 Release information \(3.13.0\) \(Jul 23, 2007\)](#)
  - ◆ [16.1 General](#)
  - ◆ [16.2 Features](#)
  - ◆ [16.3 Bugfixes](#)
- [17 Release information \(3.12.0\) \(Jul 11, 2007\)](#)
  - ◆ [17.1 Features](#)
  - ◆ [17.2 Bugfixes](#)
- [18 Release information \(3.11.0\) \(May 18, 2007\)](#)
  - ◆ [18.1 General](#)
  - ◆ [18.2 Features](#)
  - ◆ [18.3 Bugfixes](#)
- [19 Release information \(3.10.0\) \(Mar 22, 2007\)](#)
  - ◆ [19.1 Features](#)
  - ◆ [19.2 Bugfixes](#)
- [20 Release information \(3.9.0\) \(Mar 13, 2007\)](#)
  - ◆ [20.1 Features](#)
  - ◆ [20.2 Bugfixes](#)
- [21 Release information \(3.8.6\) \(Feb 26, 2007\)](#)
  - ◆ [21.1 Features](#)
  - ◆ [21.2 Bugfixes](#)
- [22 Release information \(3.8.4\) \(Feb 8, 2007\)](#)
  - ◆ [22.1 Features](#)
  - ◆ [22.2 Bugfixes](#)
- [23 Release information \(3.8.0\) \(Jan 18, 2007\)](#)
  - ◆ [23.1 Features](#)
  - ◆ [23.2 Bugfixes](#)
- [24 Release information \(3.7.0\) \(Dec 1, 2006\)](#)
  - ◆ [24.1 General](#)
  - ◆ [24.2 Features](#)
  - ◆ [24.3 Bugfixes](#)
- [25 Release information \(3.6.2\) \(Nov 23, 2006\)](#)
  - ◆ [25.1 Bugfixes](#)
- [26 Release information \(3.6.1\) \(Nov 21, 2006\)](#)
  - ◆ [26.1 Bugfixes](#)
- [27 Release information \(3.6.0\) \(Nov 20, 2006\)](#)
  - ◆ [27.1 General](#)
  - ◆ [27.2 New Features](#)
  - ◆ [27.3 Bugfixes](#)
- [28 Release information \(3.5.0\) \(Oct 22, 2006\)](#)
  - ◆ [28.1 General](#)
  - ◆ [28.2 New Features](#)
  - ◆ [28.3 Bugfixes](#)
- [29 Release information \(3.4.5\) \(Oct. 8, 2006\)](#)
  - ◆ [29.1 New Features](#)
  - ◆ [29.2 Bugfixes](#)
- [30 Release information \(3.3.5\) \(Sep 20, 2006\)](#)
  - ◆ [30.1 General](#)

- ◆ [30.2 New Features](#)
- ◆ [30.3 Bugfixes](#)
- [31 Release information \(3.2.0\) \(Aug 30, 2006\)](#)
  - ◆ [31.1 General](#)
  - ◆ [31.2 New Features](#)
  - ◆ [31.3 Bugfixes](#)
- [32 Release information \(3.1.0\) \(Jul 27, 2006\)](#)
  - ◆ [32.1 General](#)
  - ◆ [32.2 New features](#)
  - ◆ [32.3 Bug fixes](#)
- [33 Release information \(3.0.0\) \(Jun 22, 2006\)](#)
  - ◆ [33.1 New features](#)

## Release information (3.27.1-dev) (nightly)

### Bugfixes

- The Tools / Data entry menu was lost ! Tnx OH6XX.
- For some contests, the letters for cut numbers were inappropriately translated.

## Release information (3.27.0) (Jun 9, 2009)

### New Features

- Log entry : In CW, and when applicable (depending on the contest and station worked), letters for cut numbers are translated. Only works for newly entered QSOs. Tnx N6TV.
- New option in the bandmap properties to randomize a small offset (-100 Hz/0/+100 Hz) of the transmitting frequency of a grabbed spot. Works only in CW mode. Tnx F5VIH/SV3SJ.

### Bug Fixes

- Several typos fixed. Tnx DL6RAI.

## Release information (3.26.0) (Mar 26, 2009)

### New Features

- Partner window : Delete item added to the contextual menu. You can also use a Ctrl-Dbl-Click a la Bandmap. No confirmation asked.
- RTTY windows : The middle mouse button acts the same as the left mouse button in the stream display, except that selection (if any) is stacked in the Partner window.
- RTTY and CW : New variables.

`$(CURRENT)` (or `$(CURRENTCALL)`) : Sends the callsign of the current QSO \*despite\* the presence

## Win-Test Wiki

\$NEXT (or \$NEXTCALL) : Sends the callsign of the next QSO line when a \$CR is included in  
\$PREV (or \$PREVCALL) : Sends the callsign of the previous QSO line.  
\$GRABPARTNER : Grabs the first callsign from the Partner window and insert it in the call

To summarize, you can now enter a QSO (with correction or not), grab another callsign from the Partner window and send his report in one keystroke, by using :

```
$CORRECT TU $CR NOW $GRABPARTNER $NEXT $F2 (w/correction)
```

or

```
$CURRENT TU $CR NOW $GRABPARTNER $NEXT $F2 (full call) ($F2 is supposed to be the sent report)
```

If you want to manually grab a callsign from the Partner window you can use :

```
$PREV TU NOW $LOGGED $F2 ($F2 is supposed to be the sent report)
```

1/ Use the enter key to silently enter the current Q 2/ Grab the next callsign from the Partner wnd (dbl-click or Alt-n) 3/ Send the above message

- Custom variables support added. Mostly designed for the DXPed mode, this feature allows to create custom variables and set the value very quickly. Example : \$REGION or \$UP for a split up value.

Use the Options / CW (or RTTY) / Custom variables... menu to set the names and the value of these variables to be used in your CW or RTTY messages. You can also use the VARIABLES text command.

You can also easily set a variable value by entering its name in the callsign and "Enter". WARNING : Don't chose a variable name that is already used or it won't work... Tnx K5AC @ K5D.

- Yaesu FT-450 supported. Tnx F8IJV, F6DEX.
- Yaesu FT-950 supported. Tnx EA8AY.
- ARRL DX and ARRL 10 : KH6 and KL7 stations are now exclusively identified as being not located in HI and AK by the CTY\*.DAT file. Tnx AD1C and G4MJS.
- CW and RTTY keyers : \$FREQnn (like \$FREQ160, \$FREQ80 etc.) variables added. Sends the freq of the primary radio of the first networked station found on this band with the following priority : R, R+, M, and M+. In addition, in CW, if the frequency is round, no decimal point (or kHz) are send. If not, the decimal point is replaced by an R. Ex 14021.0 is sent as 14021 and 14021.1 is sent as 14021R1.
- Status Window (Alt-J) : To improve consistency across the software, new contextual menu item to Pass a frequency to the Sub VFO of the active radio (if the radio permits). An Alt-Dbl-Click on the frequency works too, like in the bandmaps windows.
- Sked Window (Alt-B) : To improve consistency across the software, an Alt-Dbl-Click on a sked passes its frequency to the Sub VFO of the active radio (if the radio permits), like in the bandmaps windows.
- CW / RTTY : The leading zeros setting is now different for each mode, but the text commands (LZ/NOLZ etc.) remain the same. Tnx N6TV, KR7X.

## Win-Test Wiki

- RTTY setup : New option to favor or not auto-highlighted mults when using the Ins key. Tnx TK5EP.
- RTTY wnds : New option in the contextual menu to "invert" (Letters / Figures) the selection. Tnx DL6RAI.
- RTTY wnds : The 599nn, 599nnn and 599nnnn reports are now correctly interpreted and the 599 part is stripped. Tnx DL4NER.
- PACC contest new rules : Non-PA stations are no more restricted to mixed mode. The Cabrillo output has been consequently updated. Tnx F5IN.

## Bugfixes

- Under certain conditions the CLEARLOGNOW text command could lead to a crash. Tnx DL6RAI @ DQ4W.
- UBA Spring contests : Sections were missing in the section list displayed in the Alt-Z wnd. Tnx F5IN, ON7TK.
- ARRL Contests : The content of the ARRL-SECTION or LOCATION field of the Cabrillo output file can be modified to comply with the ARRL/RAC sections list. Tnx W2NRA.
- (Task #241) Minimum offtime for CQWW 160 is now 30 min. Tnx K1DG.
- NAQP and NA Sprint RTTY : The \$MYNAME wasn't working in this mode. Tnx YV5TX.
- (Task #239) Packet monitor wnd (Alt-O) : Scrollbar issues when its content is over 65535 lines. So, this wnd is now limited to the last 65535 lines. Tnx G4MJS.
- CQWW WPX now appears in the current month contest if we are in february (because of the RTTY leg). Tnx DL6RAI.

## Release information (3.25.1) (Feb 13, 2009)

### New Features

- CQWW WPX RTTY : Rules 2009 : The band-change limit for MS is increased to 8 per hour.
- DX Cluster Wnd (Alt-A) : New option to display only the op-entered spots. Tnx YL2GD.
- CQWW 160 : Zones wnd : Copy as text enabled. Tnx G3TXF.
- CQWW WPX : RTTY M/S => Numbering sequence for whole log for M/S and numbering per band for the other M/? categories.

### Bugfixes

- Bugfix : Stats wnd (Ctrl-F9) : If the contest spread over two days (CQWW 160 rules 2009 for example), it was impossible to export a target file over 48 hrs. Tnx OK1VWK @ OL7R.



## Win-Test Wiki

- Bugfix : Stats wnd (Ctrl-F9) : If the contest spread over two days (CQWW 160 rules 2009 for example), some drawings were broken.
- Bugfix : Task #211 : NA Sprint : Network protocol was broken. Tnx N6TV.
- Bugfix : Task #236 : FOC Marathon : The exchange filling function failed after a band change. Tnx N6TV.
- Bugfix : Task #233 : Rate Wnd (Alt-R) : CQWW 160 : Under certain circonstances the pts per QSO calculation was wrong. Tnx DL1ELY, DL6RAI.
- Bugfix : Task #230 : Options / Windows / Default layout... was crashing Win-Test. Tnx N6TV.
- Bugfix : NCCC Sprint : Canadian Maritime "provinces" are now using the MAR identifiers, like for the NA Sprint. N6TV.
- Bugfix: Task #228: wrong QSX frequency in spots with K3. Also apply to Kenwood Radios. Tks W9ZRX, N6TV.
- Bugfix: ALT+F3 and K3: inverted frequencies into an ALT-F3 Spot. Tks W9ZRX.

## Release information (3.24.0) (Jan 15, 2009)

### New Features

- CQWW WPX : New rules 2009 : In M/S category the trailing 0/1 indicator in the Cabrillo file now indicates if a callsign has been worked by a RUN or a MULT station.
- RAEM Contest implemented. Tnx F5IN.
- Keyboard mode : New options in Options / CW and Option / RTTY to enable or not keys remapping while in keyboard mode. Cf Task #172. Tnx N6TV.
- Contest settings dlg : The exchange help message box pop-ups if it is required and empty. Tnx W7UPF, N6TV.
- CQWW 160 : Win-Test is now compliant with the new rules 2009.
- Sked window (Alt-B) : You can send the sked freq in the sub VFO if applicable. Tnx TM2Y.
- CTY files : The "virtual" OVER entity (if any) is ignored. The VER\* callsigns too.
- WAE messages : \$LOGGEDCALL (or \$LOGGED) can now be used in these messages. Tnx DK4WA.
- Clock wnd : The RUN/S&P indicator is displayed only if this switch is enabled (Tools / Data entry menu). Tnx F1HAR @ FY5KE.
- Statistics : All text reports are now formatted with | separators instead of ! chars. Tnx N6TV.

## Bugfixes

- NAQP and SCCC Sprint : VO1/VO2 province is now NL instead of NF. Tnx NX5M.
- Rate wnd (Alt-R) : Under some circumstances, the calculations were wrong for monoband contests. Tnx AC0W.
- ARRL 10m : US/VE multipliers weren't correctly displayed in the Check Multipliers wnd (F10). Tnx CX6VM.
- Task #221 : ARRL SS Cabrillo file import failed. Tnx N6TV.
- Task #171
- ARRL 160 : ADIF file export now uses the ARRL\_SECT field. Also fixed for the ARRL SS, ARRL FD and the ARRL 10 uses the STATE or VE\_PROV field when applicable. Tnx AD1C, W1EQ.
- Task #222 : M/S log import now correctly assigns the RUN and MULT flags following the new Cabrillo implementation. Tnx I4UFH, N6TV.
- Task #218 : The exchange help in the contest configuration now works for the ARRL SS. Tnx N6TV.
- ARRL SS : Serial sent is now editable (Edit / Serial sent) Tnx N6TV.
- WAE RTTY : QTC transmission : A QSO with a 000 as serial number was interrupting the transmission of the serie. Tnx DK4WA.
- MK setup dlg : Under some circumstances, chosen options were deleted when setting the router path. Tnx FY5KE.
- Task #214 - QSX frequency (if any) was missing in ALT-F3 when spotting the previously logged QSO. Tks DL4NER, NQ4I, W9ZRX, N6TV.
- Task #215 (Clicking on QSX spots (split) doesn't work right with Yaesu radios) - fix to be tested.
- Some AltGr (Alt+Ctrl) shortcut was also launching either Alt or Ctrl ones. Fixed.

## Release information (3.23.0) (Oct 22, 2008)

### New Features

- Spanish language is now included. Thanks EB2CYQ for this excellent job!
- CQWW RTTY : ADIF export : Task #213 - US State (or VE province) is now exported when applicable. Tnx N6TV.
- Radios : Omni VII process reviewed and fixed. Note that the TenTec protocol has some limitations Win-Test can't circumvent. For example Win-Test can't know which VFO is transmitting. A big "thanks" to F5FLN (owner of RFPA/RFHam <http://www.rfpa.com/> and <http://www.rfham.com/>) who lent us an Omni VII for testing. Tnx F5LVL.

- RTTY keyboard mode (Alt-K) : The Ctrl-M and Ctrl-Enter combinations now send linefeeds. Tnx DJ4MZ, N6TV.

## Release information (3.22.0) (Sep 16, 2008)

CAUTION: New network protocol version 1.23 released

Reminder: If you use WT in a networked environment, you must have the same WT version on all machines!

### New Features

- Voice Keyer module rewritten.
- CQWW M/S Category : The Cabrillo file format now uses a different indicator whether the QSO has been worked with a RUN or a MULT station. Tnx K1EA, F6BEE.
- RDA Contest : Russian stations : DXCC countries are now counted per band. Tnx UA1ACC.
- RDA Contest : R1FJ and R1MV are now considered as Russian Stations and their RDA is processed as valid. Tnx G3TXF, OR2A and others.
- The bridgehead concept has been revised to decrease the required bandwidth for log synchronization across a WAN. This new implementation is only effective when used with the updated WtTunnel v1.10. The updated WtTunnel suite will be available only for the next IARU HF contest, and, as usual, its use will be restricted to the HQ stations.
- Radio wnds : Ctrl-Up/Down are now usable with all sorting options.
- WAEDC : DX side : QTC-in-stock count is now displayed in the Clock wnd. Tnx K5KG.
- WAEDC : Radio wnds : New option in the list view to display the "potential QTCers". Tnx IZ3EYZ.
- RRTC (Russian Radiosport Team Championship) added. Tnx RA3AUU.
- New text commands added :
  - ◆ AUTORELOAD: Equ. to Options / Load contest at startup / Enabled
  - ◆ NOAUTORELOAD: Equ. to Options / Load contest at startup / Disabled

### Bugfixes

- WAE : Radio wnds : List view : The "potential QTC" option was not working correctly. Tnx IZ3EYZ.
- Radio wnds : Bandmap view : Scale 1:8 menu item was not working. Tnx TM1W.
- ARRL FD. Some ARRL sections weren't considered: AK, PAC, PR and VI. Tnx VE2FU, N6TV
- ARRL FD. QSO between home stations are now tagged as invalid and count as 0 pts. Tnx VE2FU.

- Helvetia VHF/UHF/Microwave Contest : Locator partial check is now working the same way as the other VHF+ contests. Tnx HB9CZF.
- Split Mode with IC7700. Tks K3LR.

## Release information (3.21.0) (June 23, 2008)

CAUTION: New network protocol version 1.22 released

Reminder: If you use WT in a networked environment, you must have the same WT version on all machines!

### New Features

- Operators management : Reserved for Multi-Ops : When an operator logs in, Win-Test now automatically tries to run an executable (.exe, .bat or .com) named op\_"callsign" which must be located in the Win-Test installation directory. For example, if DL6RAI logs in, WT will try to run op\_dl6rai.exe (or .bat or .com), if this file exists. If the callsign includes a "/" character, it will be replaced by an underscore ("\_"). This feature may be useful to automate various actions. Tnx DK4YJ for giving the idea.
- NA RTTY Sprint : The special "legal dupe" rule being abandoned for this mode, Win-Test is now processing dupes the same way as for the SSB and CW legs. Tnx W0YK.
- Win-Test now manages a lock mechanism to prevent several program instances running on the same machine to open the same log. Tnx N6TV.
- CW and RTTY messages dlg : Keystrokes are now automatically upper-cased while entering.
- Partial QTH locator search enhanced (Shift - F10):
  - ◆ Only applies to the VHF+ contests
  - ◆ Partial locator can be entered in the callsign field - or -
  - ◆ Partial locator can be entered in the locator field with four characters at least
- Automatic CQ repeat : New options in the setting dialog to use this function for functions keys different from F1, depending on the mode. Can be useful, for example, in Phone when using CQ messages in different languages.
- Automatic CQ repeat : The repeat interval can be set even if the function is disabled.
- CW Autosend : Setting dlg slightly modified to split the Enable / Disable toggle from the minimum entered chars setting.
- CW Autosend : The triggering chars count now starts after the first '/' if there is one in the callsign. Tnx ES5TV.
- Shift and NumLock bindings settings are now ignored when using an operating technique different from the Advanced SO2R. Tnx SM5AJV.
- New option in the help menu to display text command tips for menu items. The equivalent text commands for this option are TXTCMDTIP / NOTXTCMDTIP, or TEXTCMDTIP /

NOTEXTCMDTIP. Tnx N6TV.

- CW/RTTY Messages options : New option to ignore the S&P messages when switching to the S&P operating mode. Only the Sprint logic for the Insert key acts as expected, if enabled. Tnx ES5TV and N6TV.
- CW/RTTY Messages options : The Sprint logic for the Insert Key now also applies for the AP Sprint. Tnx N6TV.
- New \$NEXTSERIAL and \$PREVSERIAL CW and RTTY variables. Sends the next or the previous serial number of the current QSO line. Tnx ES5TV.
- New text commands added :
  - ◆ WKSETUP: Equivalent to Options / WinKey configuration...
  - ◆ EZSETUP: Equivalent to Options / EZMaster configuration...
  - ◆ MKSETUP: Equivalent to Options / MK/MKII/MK2R configuration...
  - ◆ RTTYSETUP: Equivalent to Options / RTTY configuration...
  - ◆ QUICKQSL: Equivalent to Tools / Intelligent Quick QSL...
  - ◆ AUTOCQ/NOAUTOCQ: Enables/disables the Repeat mode
  - ◆ CQAUTO/NOCQAUTO: (ditto)
  - ◆ CWAUTO/NOCWAUTO: Enables/disable the CW Auto Send
  - ◆ AUTOCW/NOAUTOCW: (ditto)
  - ◆ CWAUTOON/CWAUTOOFF: (ditto)
  - ◆ AUTOCWON/AUTOCWOFF: (ditto)
  - ◆ RPTDELAY: Equivalent to Tools / Automatic CQ repeat, with the focus set to the repeat interval field
  - ◆ CTYFILE(S) / COUNTRYFILE(S): Eq. to Options / Data files / Country files...
- RUN / S&P operating : When the repeat mode is enabled, changing to S&P operating disables the repeat and the autosend modes. Tnx ES5TV.
- Alt-F : QSO operator added to the editable fields. Modifications, if any, are propagated across the network.
- New feature added in the Tools menu to allow the correction of the operator for a range of QSO.

Even if this tool is more supposed to be used after a contest, or a DXPed, to correct a wrong or forgotten entry, each correction is broadcasted to the other stns of the network by default. You can disable this broadcasting to save time, if not needed.

The easiest way to correct a range of Q, is to set the cursor log on the first Q to correct and select the menu item. The operator combo will be then already set. Then, adjust the last Q to correct by using the arrow keys (and optionally the band(s) and mode(s)).

Note that corrections are pretty CPU intensive and it may take a certain amount of time for large logs, because each QSO modification requires internal structures to be updated.

Note : Hesitating and wise users are encouraged to perform a backup of their log before proceeding. These corrections can't be cancelled while they are progress, to avoid any log inconsistency... Tnx G3TXF and F6IFY.

## Win-Test Wiki

- WinKey properties : New options to set speed with the WK pot. only, or the WT commands when using the "Sync speed" option.
- User Interface : Following the programming guidelines, all menu items requesting additional information to complete are now ending with an ellipsis.

### Bugfixes

- Several bugfixes and improvements on the WinKey speed. Tasks #122, 162 and various reports. Tnx N6TV, K1EL, F6IFY, OM7ZZ and many others.
- Task #128. CW and RTTY messages dialog now handle the Enter and Esc keys as expected. Tnx N6TV.
- WAE QTC transmitting and receiving messages dialog now handle the Enter and Esc keys as expected.
- QuickQsl dialog : The Enter and Esc keys work as expected while editing the messages.
- Task #173 : The decimal point is now accepted when editing QSO frequency or QSO frequency in the Alt-F dlg. Tnx N6TV
- Task #138 : In S&P, F1 was setting the CQ frequency. Tnx SV3SJ/F5VIH.
- RTTY windows : Under some circumstances, the automatic grabbing with the INSERT key was broken. Tnx W0YK.

### Release information (3.20.0) (May 14, 2008)

- King Of Spain contest : Points per QSO updated following the official URE rules. Tnx EA5FQ.
- RTTY wnds : A new (C) button (stands for "Clear", like on a calculator) added to clear the TX/RX window; Tnx G3SVD and N6TV.
- RTTY wnds : The mouse wheel now acts like in the other Win-Test child windows. It means that you can scroll, or goto the start or the end of the window (by using Shift + Wheel), or change the font size a la Firefox/Mozilla by using Ctrl + Wheel. The small icon to quickly scroll to the end of the window (located in the title bar of the window) is also enabled.
- RTTY wnds : Shift + Click on a message button opens it for edition.
- Log exports : New export LogSearch format to comply with Marios 5B4WN log search php script. In the options dialog, you can specify a range of Q to be exported, and zip the output file (so its name will be "blahblah.LGS.ZIP"). Tnx TX5C and 5B4WN.
- Added a LogSearch export option in the Automatic Backup function. In this case, the entire log will be exported (the range option of the log exports dialog doesn't apply), \*but\* the zip option set is applied.

## Win-Test Wiki

Note: Contrarily to the WTB backup, the LogSearch exports are not done in a separate background thread. Thus, it is not recommended to enable this option on a running station because WT will be unavailable for logging for a while every time an export is in progress. During this period of time, an empty file named "LOCK" is created in the backup directory, and deleted once the export is completed. This ensures file integrity check for a third party application using the export file.

- New report in Tools / Check log menu to display all distinct callsigns of a log, and band(s)/mode(s) worked by each station. You can sort this report by callsign, by number of Q and by country. This report can also be opened in the Windows notepad. Tnx WA1S @ TX5C.
- Keyboard switching for international teams with different keyboards. To help these users, a new switching dialog is added in the Tools | Data entry menu. It is enabled only if several keyboards are installed in your system. You can also access this dialog by entering the text commands KEYBOARD or KEYB for short.

We remind you that you can also switch keyboard by using the text command KEYB/xxx where xxx is the abbreviated language code described here:

<http://www.microsoft.com/globaldev/reference/winxp/langtla.msp>

For example : KEYB/FRA, KEYB/ENU or KEYB/ENG etc.

For convenience, this abbreviation is also mentioned in the keyboard switching dialog.

- Rate wnd (Alt-R) : By default for new logs, the calculated offtime is now based on the contest rule. You can still use a custom setting to check your operating (in)efficiency. If the contest rule is unknown, 15 minutes will be used. Tnx DL6RAI, N6TV and others.
- Interfaces : New option in the MK/MKII/MK2 setting dialog to check if the microHAM router software is running. Tnx F2JD @ FO5A/MM ;-)
- Interfaces : New option in the MK/MKII/MK2 setting dialog to start the microHAM router if it not running yet.
- Interfaces : When a COM port can't be opened, you now have the possibility to retry opening, to continue with this port closed for this session only, or to disable it permanently.
- Log wnd : WT can now display a QSO count over 99999 in DXPed mode. Tnx ES5TV @ VP6DX.
- Packet parser modified to comply with the CWSkimmer telnet pseudo-cluster syntax (the # char is now accepted). Tnx N4ZR.
- Startup : If Win-Test is started with the Ctrl key down, it doesn't automatically load the previous opened log.
- Merge dialog :
  - ◆ In the "Add file" dialog, you can now select multiple files at once. Tnx TX5C.
  - ◆ New button to designate the master file. Tnx TX5C.
  - ◆ New option to load the master file once merging is completed.
- New continent field available in the CSV and TXT export files. Tnx VA7DX @ TX5C.

## Win-Test Wiki

- Callsign checks are now a bit more restrictive to prevent typing errors. Tnx WA1S @ TX5C.
- DXPed mode : You can now specify the duration of the operation (between 1 and 15 days) in the contest settings dialog, to fit the stats wnd horizontal range (Ctrl-F9). You have to enlarge this wnd if needed. Tnx TX5C.
- DXPed mode : Default Insert key msg modified (no more dupe check). F3 default message also modified to "\$LOGGEDCALL ?". Tnx TX5C.

## Bugfixes

- Black Bandmap with FT-847/FT-897. Tks G4FAL.
- ARI DX contest : Typo in the provinces list : FO instead of FC (I4). Tnx G3TXF.
- RTTY wnds : If text was selected and the font size was modified, the selection rectangle wasn't modified, and further selection on received text before the size modification was wrong.
- Task #170. HamCap Propagation forecast now also works with the callsign entered in the secondary radio window. Tnx N6TV.
- Task #192. CheckPartial (F8) and N+1 (F12) wnds : Dupes display failed when callsigns were entered in the secondary radio wnd. Tnx N6TV.
- Task #193. Data files specified in command line launch with no extension generated erroneous extra files names. Tnx N6TV.
- Task #194. CheckCallsign wnd (F9) wasn't working for the ARRL VHF contests (and probably other VHF+ contests). Tnx K1TR.
- Task #191. When using a WinKey, the paddles activation cancels the repeat mode if enabled. Tnx N6TV.
- Radio wnds : Under some specific circonstances, the bandmap view could display garbage.
- The CSV export settings weren't saved. Tnx N6TV.

## Release information (3.19.0) (Jan 24, 2008)

### New Features

- Added IC-7700 and Tentec Orion II in the list of supported radios.
- Basic Operators management

Foreword: This feature is very limited, and will *\*not\** be further extended in this major version of Win-Test (v3). It is mainly added to help DXPeditioners for the web log search scripts, and for various DX or testers challenges (RRDXA etc.)

New text commands : OPON (or LOGIN), OPOFF (or LOGOUT).



## Win-Test Wiki

This feature is only available to multi-op logs.

If you entered a list of operators in the contest settings dialog when creating the log, it will be parsed to init the combo-box. You can also add ops "on the fly" to this combo box.

If you add nicknames to ops of this list (joe, jack, william, averell, josette or whatever - letters and numbers are accepted, allowing exotic nicks like l33t etc.), you can enter them as text commands to quickly change operator, without using the OPON command.

Op. callsigns are limited to 7 chars, while nicks are limited to 13 chars.

The operator changing is propagated across the network, meaning that if you login on a station, you will be automatically logged out of the previous one you were logged on (if any).

The ADIF file export includes the op callsign in the QSO record, if an op. has been defined for that QSO.

The text and CSV export files are also enhanced to allow the inclusion the op. callsign.

- New KEYB text command: Designed for international multi-op teams. You can now switch keyboard to use in WT with a KEYB/xxx text command following the abbreviated language code described there: <http://www.microsoft.com/globaldev/reference/winxp/langtla.msp>. For example : KEYB/FRA, or KEYB/ENG etc. Caution: The keyboards layouts must have been installed in the Windows language bar before using! This portion of code is CERN-approved. Tnx F6IFY, F5VIH/SV3SJ.
- ARRL SS : The licence year log entry field title is now Chk (stands for Check). Tnx N6TV.
- ARRL SS : New \$CHECK variable added to send your licence year. This variable only works for this contest. Tnx N6TV.
- CTY files : To strengthen the parsing of these files, all trailing spaces are now ignored. Tnx W9ZRX and AD1C.
- CTY files : The parser now supports leading equal symbols (=) of the future CTY files. Tnx AD1C.

## Bugfixes

- The "elapsed time since the last QSO" bargraph was not displayed anymore. Fixed.
- Orion II Radios not properly set when grabbing QSX spots from the bandmap. Close bug report #159. Tks K1GQ (KC1XX). Note: still not 100% operational.
- Task #174 of the BTS : Using [Alt-F1/F2] to fix band of already logged QSO entered on the secondary radio was changing the rig, which is not expected. Fixed. Tks N6TV.
- NAQP M/2 (only) : Edit current op. name menu item added. The equivalent text commands are OPNAME or MYNAME. Tnx N4CU.
- Radio Wnd / Bandmap view : Max. zoom extended. Tnx G3RXQ.

## Win-Test Wiki

- ARRL RTTY Round-Up implemented. Tnx F6IFY.
- ARRL 160 : The Cabrillo file now marks empty exchanges (for DX side stations) with "---" to comply with the ARRL robot. Tnx F5IN, N5KO.
- Objectives renamed as Targets. Tnx G3TXF.
- NAQP : Cabrillo file : Op name field was broken in M/2. And Transmitter ID added in M/2 only. Tnx N4CU, N6TV, N5KO.
- CQWW 160 : Default band (160) was broken. Tnx DL6RAI.
- Bugfix : Left-handed users who used the appropriate Windows mouse settings weren't able to move the Clock and SSB bargraph windows. Tnx JQ1BVI.
- ARRL SS : The exchange guessings were not reset when the callsign was modified. Tnx N6TV.
- Tools : Check exchanges : Inconsistent behaviour under certain circumstances.
- When opening or creating an empty log, it was locked from the OS point of view, even after closing it in WT. Tnx N6TV.

## Release information (3.18.0) (Nov 3, 2007)

### General

- Some improvements done in the microHam MKII protocol support. **This version of Win-Test does now request USB device Router v5.0.3 or later.**

### New Features

- MK2R/MK2R: WT does now display the firmware version number of the device in the "detected" message shown at the startup.
- WT can now control the microKeyer through the microHam protocol as well. This is useful to control the USB Device Router DVK which should give better result in audio and radio switching than using the WT integrated Voice Keyer. Tks microHam company.
- < and > key behaviours changed. Regardless the SO2R status,
  - < key will now switch to the previous field of the main log
  - > key will now switch to the next field of the main log

### Bugfixes

- Bugfix: MK2R/MK2R+ was not configurable anymore. Fixed. Tks OH2UA.
- Bugfix: IC-275/475/1275 communication problems fixed. Tks IK2JUB.

- Bugfix: Frequency Offset fixed with IC-735.
- Bugfix: With an FT1000MP and some other rigs, band map follows TX freq instead of RX freq when operating Split. Tks N6TV.
- ARRL SS : Stats are now displayed on 3 days. Tnx N6TV.
- ARRL SS : Every QSO field must be filled to enter it. Tnx N6TV.
- ARRL SS : Dupe warning now indicated the received serial of the former QSO. Tnx N6TV

## Release information (3.17.0) (Oct 21, 2007)

### General

- **CAUTION : New network protocol version 1.21 released. Reminder : If you use WT in a networked environment, you must have the same protocol version on all machines !**

### New Features

- The microHAM micro KEYER II is now supported. WT can control this interface using the microHAM protocol in order to use the DVK.

For that, create/select a free COM port for "Control:" in the "microHAM USB Device Router", then select "microHAM MKII" as a connected device for the corresponding COM port in the "Interface Configuration" window of WT.

Tks microHAM company for great support!

- Asia Pacific Sprint added.
- JARTS WW RTTY Contest added.
- LPT address can be set between 0200 and FFFF (hex). Tnx VE5ZX

### Bugfixes

- Bugfix: Sprint logic feature (CW messages option) was not working for the EU Sprint. Tnx S51DS.
- Bugfix: Under certain circumstances, the correct local help files were not opened. Tnx W9ZRZ.
- Bugfix: CQWW RTTY : Except under certain circumstances, the zone wasn't filled for K/VE when a QSO has been made with the current stn on another band. Tnx DL5AXX, T93Y.
- Bugfix: Task #141 - NA Sprint : Alaska stations (KL) entered in the log are now listed with an AK exchange in the Cabrillo file. This also applies to the NCCC Sprint. Tnx N6TV.
- Bugfix: When entering a QSX freq for a spot, WT was picking up the same transmit freq and re-listed that as the QSX instead of picking the second VFO freq. Tks NQ4I.

- Bugfix: Under some circumstances, the Map (Grayline) Window was not properly opened when opening a new log. Fixed.

## Release information (3.16.0) (Sep 7, 2007)

### New Features

- Intelligent Quick QSL can now be adaptive according to the Instant Rate. See the "Intelligent Quick QSL configuration..." window (in menu "Tools") for details. Tks CT1BOH.
- Added new macro \$QQLRESET. This macro reset the timer or the counter like if the long QSL message were just sent. It makes sense to use this macro in each message you send your callsign in like CQ (F1 key) or MYCALL (F4 key). That way, you won't send a long QSL message after sending your call a few seconds before. Tks CT1BOH.
- Added new macros \$FREQP and \$FREQS - Feature request #8. These new macros send accordingly the frequency of the Primary radio and the frequency of the Secondary radio. Tks OH4JFN.
- New qualifications to the Kenwood Radios (as well as radios based on the same protocol, like SDR-1000, Elecraft):
  - ◇ Under certain circumstances, the mode was not read correctly at the startup of Win-Test
  - ◇ Added the BandMap "Pass to Sub VFO" feature
  - ◇ When entering a frequency in the callsign field, the RIT is cleared (as far as it is enabled).
- Editing of the Frequency of a logged QSO - Feature request #117. In addition to its Date and Time (ALT+F shortcut, or in menu Edit). Tks DL4NER.
- Alt-F9/F10 now always change the CW speed by 2 WPM up or down, regardless of the current CW speed (can be odd or even). Tks N6TV.
- F11 also wipes the time field if done on the last QSO in the log.
- CQIR contest added.

For the IRTS 75-year anniversary, make 75 QSO and you enter a draw to win a week for two in Kinnitty Casle (flights included). For detailed rules, see <http://www.irts.ie/COIR>

- SARTG RTTY contest added.
- LOTW contest added.
- SCC Championship RTTY contest added. Requires CTY\_LUPROV.DAT file.
- CQWW RTTY : When an US/VE stn is worked, entering his state/province is now mandatory. Tnx F6IFY.
- Keyboard mode dialog (Alt-K) revisited. The dlg labels are more descriptive than before, and in RTTY you can chain predefined msgs with keystrokes, as in CW. The only difference is that in RTTY, [Esc] empties the TX buffer, but let the PTT ON, so you can enter keystrokes again, unless

you close the window (which resets the PTT).

- Spots warning : New option to be warned when spotted on the current band/mode only. Tnx I4UFH.
- Radio windows : Markers and segments files can also be set with the bandmap display contextual menu.

## Bugfixes

- Bugfix: SWAPing two radios (in SO2R mode) in a mixed mode contest might get Mode changes hazardous! In addition, VFO-B programming when at least one of the Radio is an Icom gave over. Tks MMOBQI.
- Bugfix: Chaining 1-char long CW messages or using the CW Keyboard Mode with WinKey was sometimes causing speed changes (speed was actually set to the pot speed). Fixed. Tks DL5AXX.
- Bugfix: RTTY was set using the upper side band for frequencies above 10 MHz. Fixed. Tks VE2FWW.
- Bugfix: QTC might be hidden when for portable stations (like N1AA/6). Fixed. Tks DJ0ZY.
- Bugfix: Closing QTC session with "+" causes QSO entry problem if the serial number is not set. Bug report #123. Fixed. Tks DL1IAO.
- Bugfix: Task #137: "PTT to Wrong Radio after sending something to 2nd radio". In SO2R, if using Alternate CQ, the TX focus stays on "wrong radio" when starting QSO. In addition, the TX focus also stays on the secondary radio when one sends something on it. Both fixed. Tks OH2UA.
- Bugfix: Task #130: "Broken TRX-Control with TenTec Orion". After about 30 min, communication with Orion trx was not working anymore. Fixed. Tks DJ0ZY.
- Bugfix : WAEDC contest : In the QTC transmit or receive dialogs, the CR and + keys didn't work as expected in SSB mode. Tnx ES5TV.
- Bugfix : WAEDC contest : The ADIF STX field wasn't set. Tnx F5UKL.
- Bugfix : Stats wnd (Ctrl-F9) : Under certain circonstances, the displayed graph wasn't correct on this window opening. Tnx DJ0ZY.
- Bugfix : Some mixup in the parity labels and abbreviations of the COM properties dialog. It is advisable to check your COM settings, especially if some of your interfaces use Even or Odd parities. Tnx DG7RO.
- Bugfix : Notes are stored in the local .NOT file even if outbound protocol is disabled. Tnx N6TV.
- Bugfix : [Esc] didn't always stop messages keying (CW or RTTY). Bug report #132. Tnx DJ0ZY.
- Bugfix : Under certain circonstances, Cabrillo v3 files import failed. Tnx F5LEN.

## Release information (3.15.0) (Aug 8, 2007)

### New Features

- New set of CW/RTTY variables dedicated to the WAE
  - ◊ Receive QTC window:
    - \$MYCALL: Send my callsign
    - \$VALID: Save everything and close the window
    - \$QTC: Send <group>/<number>
    - \$NEXT: Move focus to the next QTC line
  - ◊ Transmit QTC window:
    - \$MYCALL: Send my callsign
    - \$VALID: Save everything and close the window
    - \$QTC: Send <group>/<number>
    - \$NEXT: Move focus down to the next QTC line
    - \$13: Send carriage return character (specific to RTTY)
    - \$TIME: Send time of the current QTC
    - \$CALLSIGN: Send callsign of the current QTC
    - \$SERIAL: Send serial number of the current QTC
    - \$DONE: If all QTC are sent: mimic the + key
    - \$SERIE: Send the QTC serie (specific to RTTY)
- The CW/RTTY messages specific to the WAE contest (QTC Receive/Transmit) windows can now be redefined in the menu "Options | CW/RTTY | Modify WAE messages...".

It is also possible to modify the label texts of the buttons for both the "QTC Transmit" and the "QTC Receive" windows. The variable \$QTC can be used and will be replaced by the appropriate QTC group/number in the "QTC Transmit" window.

- RTTY leg of the WAE contest now supported in beta test.

QTC groups and series will be highlighted in the RTTY window.

Assuming you receive the following sequence:

```
QTC: 65/2 QTC: 65/2
0917-GI8HXY-146
0918-G8UBJ-068
```

First click on one of the highlighted "QTC: 65/2": this will automatically open the "QTC Receive" window and fill the QTC group field.

Then click on each QTC serie highlighted lines. Again, they will be passed automatically to the "QTC Receive" window.

- Sub VFO programming from the bandmap: added for Tentec Orion, FT-2000, FTDX-9000
- SWAP Radios feature rewritten. To be tested with various rigs!

## Win-Test Wiki

- CW-Reverse mode added for some Radios:

- ◇ Orion
- ◇ All Kenwood Radios supporting CW-Reverse
- ◇ All radios using a Kenwood-based protocol which are supporting CW-Reverse (Elecraft, SDR-1000).
- ◇ All Icom which are supporting CW-Reverse.
- ◇ FT-1000MP/MkV, FT-2000, FTDX-9000

Other rigs can be considered as far as the protocol can handle it.

Please tell us!

There is no setting in WT in order to enable/disable this feature.

Just set the CW Reverse on the radio, WT will remember that setting for the next time the mode must be programmed onto the radio.

- ARRL Field Day: LOG layout reorganized.
- FT-1000MP: RIT is cleared but status is preserved when frequency change. Tks N6TV.
- V/UHF and 50/70/V/UHF contests with gridsquares as mults and one point per QSO. Tnx G4HSU & G4PIQ.

## Bugfixes

- Bugfix: In the WAE contest, opening the QTC Receive/Transmit window was not working as expected. Fixed. Tks IZ3EYZ.
- Bugfix: Polling Rate Combo Box of the "Interface Configuration" window was empty. Fixed.
- Bugfix: Transmitting status in the Secondary Radio fixed in RTTY mode. Tested with no SO2R interface.
- Bugfix: Selecting a single non-alphanumeric in the RTTY windows issued a crash. Fixed. Tks DL6RAI.
- Bugfix: The CQ repeat mode was not activated when clicking on the "F1" button of the RTTY wnd. Fixed. Tks VE2FWW.
- Bugfix: Under certain circumstances, a dupe QSO was not credited to 0 point in both NCCC Sprint and NA RTTY Sprint contests. Tks N6TV.
- Bugfix: FT-2000 / FT-9000, the active VFO in WT was thrall to the RX VFO of the radio. Correct way is to thrall the TX VFO of the radio. Fixed. Tks G4IRN.
- Bugfix: VFO B programming of the Orion fixed. In addition, a timer now ensures to always wait at least 100ms between each commands sending. Tks SM6CNN.
- Bugfix: NAQP, NA Sprint and NCCC: Database Updates was saving the OP Name instead of the State/Province/Country. Fixed. Tks N6TV.

- Bugfix: ARRL Field Day: ARRL/RAC official sections modified according to the rules. Tks VE3SY, 9A5CW, N6TV.
- Bugfix: in RTTY, QSOB4 was not working anymore. Fixed. Tks IN3JJI.
- Bugfix : All V/UHF contests : A QSO with own callsign gave one point.
- Bugfix : CW smartcorrect : Text commands are ignored now. Tnx N6TV.

## Release information (3.14.0) (Jul 25, 2007)

### Features

- Done some improvements and bugfixes in the NAQP contest. It now uses a specific "Equivalent State/Province" file: NAQP.DAT. It also uses the Cabrillo v3 specs for generating logs for the contest sponsor. The RTTY leg also supported.
- Added NCCC Sprint (NS) contest.
- The Run and S&P radio buttons of the Secondary Radio Window are now hidden when S&P mode is not active. Tks CT1BOH.
- New text command "MESSAGES" to open the "Standard CW/RTTY messages configuration" window (menu "Options | CW/RTTY | Modify Standard Messages). Text command "MSGs" is an equivalent. Tks N6TV.
- Elecraft K3 added to the list of supported radios. Tks F6BEE.
- Run/S&P switching capability menu renamed to improve the user interface.

### Bugfixes

- Bugfix : IOTA contest (and several others) : The guessed exchange was not correct. Tnx DL4CF.
- Bugfix: WT Windows of an imported Cabrillo log were not opened at startup. In addition, WT was loosing Focus. Fixed. Tks N6TV, I4UFH.
- Bugfix: Under certain circonstances, the exchange was not filled in for stations previously worked. Fixed. Tks N6TV.

## Release information (3.13.0) (Jul 23, 2007)

### General

**CAUTION : New network protocol version 1.20 released - Reminder : If you use WT in a networked environment, you must have the same WT version on all machines !**



## Features

- The generated CABRILLO files for both CQWW DX and WPX are now in the CABRILLO V3 Format.
  - Cabrillo V3 (in addition to Cabrillo V2) can be imported.
  - NAQP fields reorganized. Unfortunately, this inverted the "OP name" and "State/Province/Country" field in the WTB binary file. It means that if you open an old NAQP file done with Win-Test, the "OP name" and "State/Province/Country" will be on the wrong places. There is a workaround if you want to open an old NAQP file with the latest version of Win-Test: revert to an old WT version and generate a Cabrillo file from it. Then install again the latest Win-Test version, and import the generated Cabrillo. My apologies for these troubles but it was making sense to invert these fields in order to be more efficient with that contest, as well as with NA Sprint, NCCC... which share some of the same code.
  - NA Sprint contest added. Log for the contest sponsor is generated using the CABRILLO V3 specifications. Note that the State/Province will contain DX for non-US/VE stations whatever the operator logged in the field. Tks W0YK, N5KO, K3LR, N6TV and others.
  - Added support of the new TenTec Omni VII radio, which is actually based on the Jupiter command sets.
  - Added a Search & Pounce Operating Mode feature in order to have two different sets of CW/RTTY messages: one when running, and one when searching multipliers.
    - ◇ The Run and S&P sets of messages are editable in the "Messages" Tab of the "Standard CW/RTTY Messages Configuration..." window.
    - ◇ Use CTRL+TAB to switch between RUN and S&P mode on the Primary Radio. The status of this mode is shown in the clock window. To change the mode of the Secondary Radio Window, use either SHIFT+CTRL+TAB or a mouse click on the appropriate control in the Secondary Radio Window.
    - ◇ It is possible to configure WT to automatically wipe the logged QSO or populate the Band Map when the operator changes the radio frequency, as soon as the Search & pounce mode is activated on that radio. This can be configured from the "Band Map Properties" (right click in the Band Map windows).
- NB:** Search & Pounce is not activated by default. This can be done in the menu "Tools | Data Entry | Search and Pounce".
- The \$QSOB4 content macro can be redefined in the "Options" Tab of the "Standard CW/RTTY Messages Configuration..." window. That macro doesn't support any variable in, except \$MYCALL. Tks N6TV.
  - **Sprint Logic** feature added. Applicable in the EU Sprint, NA Sprint and the NCCC Sprint contests. When activated, WT decides which INSERT CW/RTTY Message must be sent according to the "Rcvd QSO Number" field.

## Win-Test Wiki

- ◇ When that field is empty, WT assumes that the operator just called CQ, and then sends the INSERT message of the "RUN" mode.
- ◇ When that field is not empty, WT assumes that the operator just replied to a CQ, and then sends the INSERT message of the "S&P" mode.
- ◇ This feature can be enabled/disabled in the "Options" Tab of the "Standard CW/RTTY Messages Configuration..." window. Other contests are not affected by this option.

Tks N6TV, K3LR, K0XP, N2NL and many others.

- New option to "Stay in Field when moving in the log", in order to avoid having the cursor always back on the callsign field. Option is in menu "Option | Log".
- Summary wnd (Alt-S) : New option to include or not the dupes in the QSO counts and the avg calculations.
- REG1TEST files : The New Country flag in VHF+ contests is now set in an appropriate manner. Tnx HB9DFD.
- QSO deletion : The warning message is now more informative. Tnx N6TV.

## Bugfixes

- Bugfix: In the specific case where one was operating a contest with a separate serial number per band, changing band on the Secondary Radio when the cursor was not in the last position of the log in the Primary Radio, the serial number set for the Secondary Radio might be wrong. Fixed.
- Bugfix: The Precedence field were not corrected in the log when modified in a previous logged QSO. Fixed.
- Bugfix: The Multiplier window was always showing DXCC for all bands, even for a contest which the band doesn't care in for DXCC multipliers. Fixed. Tks N6TV.
- Bugfix : The INVENTORY command was filtered by WtTunnelSrv and could only be used within a LAN. Tnx F6IFY.
- Bugfix : Internal CW generator : Under certain circumstances, the inter characters space was dropped. Tnx TA2RC, OH2UA.
- Bugfix : Log display : When working CW or RTTY, a 5-char received exchange was truncated. Tnx F5HRY/TM0HQ.
- Bugfix : When using Ctrl-K to delete characters behind the cursor in CW, and under other certain circumstances, \$LOGGED was not updated. Tnx N6TV, CT1BOH.
- Bugfix : Under certain circumstances there was no separator space between zones in the Alt-Z wnd, when marks were displayed.

## Release information (3.12.0) (Jul 11, 2007)

### Features

- Frequency Offsets (ie when the rig is used with a transverter) added. Settings can be done in the menu "Options | Frequency Offsets".
- Helvetia VHF/UHF/Microwave contest added. Tnx HB9DFD, HB9DUP, HB9CEX and others...
- IOTA contest : If an IOTA ref is entered in the appropriate field of the log, \*only\* QSOs with this IOTA are displayed in the multipliers wnd (F10). Tnx MM0BQI.
- IOTA contest : If an island reference is entered in the Exchange input field of the contest configuration dialog, the CW messages include it in the predefined messages. Tnx TA2RC.
- The summary file (.sum) now uses the standard CRLF newline characters. Tnx DL6RAI.
- Internal CW generator (LPT and COM outputs) : The PTT hold time is shortened. It is abt one dot long now. Tnx YT1NT.
- DXpedition HD : Dupes count added in the summary wnd, and DUPE indicator added at the end of log lines, if applicable. Tnx G4IRN.

### Bugfixes

- Bugfix : REG1TEST output log was broken.
- Bugfix : CQWW WPX M/2 : Under some conditions, the sent serial number wasn't consistant when a spot was grabbed. Tnx DL6RAI.
- Bugfix : Some english spellings fixed. Tnx G3TXF

## Release information (3.11.0) (May 18, 2007)

### General

**CAUTION : New network protocol version 1.18 released - Reminder : If you use WT in a networked environment, you must have the same WT version on all machines !**

### Features

- Help files : Online help now leads to the Win-Test wiki site. Every dialog and child window has its own help page. Special tnx to the wiki team M0CLW, DL6RAI, DL4NER, I2WIJ.
- VHF+ contests : Distances can be expressed in miles :

New option to display distances in miles in all windows except the stats windows where new items were added (Miles and avg mi/QSO) to ensure compatibility and consistancy. The objectives keywords allowed for distances are now :

Distance in km => KM DISTKM  
Avg distance in km => AVGKM KMAVG  
Distance in miles => MI DISTMI MILES  
Avg distance in miles => AVGMI MIAVG

To avoid any confusion, the DIST and DISTANCE keywords are no more valid. A new field has also been added in the export function to get QSO distance in miles. Tnx K3LR, W9ZRX.

- Gridsquares map (Alt-L) : The current gridsquare (4-chars) is displayed even if the callsign field is empty. Tnx DK5TX.
- Interface setup dialog : The last part of the IP broadcast address can now be different from 255. Tnx SP5ELA.
- Field Day IARU Rgn 1 (RSGB) : CW and SSB legs have now different method of scoring, according to the different RSGB rules. Tnx G3TXF, GM0ELP, G3UFY and others...
- JIDX contest : 160m band added for the CW leg. Tnx F5IN.
- ARI contests : The (IS0) Medio Campidano province abbreviation changed from MD to VS. Tnx ON5GQ.
- RDXC : SH oblast renamed to YA (official abbreviation, according to the RDXC website). The WT\_OBL.DAT and OBLASTS.DAT file are now updated accordingly. Tnx HA1AG.
- New option in the Options / Automatic backup dlg to notify the user when a backup is completed by a warning under the log lines.
- Markers files (.mkr extension) : If the comment includes a valid 4-char or 6-char grid square, the tooltip displays the heading and the distance to this grid square. It also displays the marker label if it is not entirely visible in the bandmap wnd.

## Bugfixes

- Bugfix : Helvetia (H26) contest : Mixed category allows only one QSO per band, whatever mode used. And Cabrillo output log in multi category now mentions the mode category (CW, SSB, or MIXED). Tnx DJ3WE and HB9CZF.
- Bugfix : Spelling and grammar mistakes in menus and dialogs. Tnx ES5TV, DL6RAI.
- Bugfix : WPX contest : Some very long and fake callsigns (like SIROCCO92, EIOLEKUINO, WWWWWWWWWWWWW1 or such) could crash WT. Tnx ES5TV and 9A5CW.

## Release information (3.10.0) (Mar 22, 2007)

### Features

- New tool : Time shifting, in the Tools menu.

## Win-Test Wiki

You can time shift selected Qsos by any amount of time amount in both directions. You can apply the time shift for the entire log, for the Qso entered by your own station, for Qso entered by several stns, or a range of Qsos.

Even if this tool is more supposed to be used after a contest, to correct a wrong clock setting, each time corrections is broadcasted to the other stns of the network by default. You can disable this broadcasting to save time, if not needed.

Note that time shifting is pretty CPU intensive and it may take a certain amount of time for large logs, because each Qso modification requires internal structures (mainly statistics) to be updated.

**Note** : Hesitating and wise users are encouraged to perform a backup of their log before proceeding. Time shifting can't be cancelled while it is in progress, to avoid any log inconsistency..

- Main log window : New option in Options / Log menu to hide the QSO number column. Tnx RW3AH, SM3WMV.
- Main log and secondary radio windows : To ease reading, the received RS(T) and the received exchange are now separated by an half space wide blank area.

Note that it is still \*one unique\* field. It is only a display trick.

- New feature : Band segments for bandmaps

You can now display segments in the bandmap tab of the radio windows. Segments are defined by textual files with a .seg extension located in the Win-Test directory. You can use and display up to 10 files simultaneously, by selecting them in the Options / Data files / Segments files... menu.

Note that, because of the available area constraints, you can't have more than 5 segments displayed per band for a given frequency.

You can display or not the loaded segments by using the contextual menu item Display Options / Segments / Display. This setting can be different for each radio.

The syntax of the segments files is very basic, and are very easy to create with a simple text editor like notepad.

A segment is defined by its minimum frequency (in kHz), its maximum frequency (in kHz) and an optional tooltip (30 chars max.). The two frequencies can be linked by an hyphen.

Two sample files are located in the WT repository: <http://download.win-test.com/files/segments/>

◇ **UsSegmentsDetailed.seg** displays all band segments for every US licence type.

◇ **UsSegments.seg** displays all band segments in which all US licencees are potentially active.

Tnx DL1MGB for inspiration.

- New feature : Markers for bandmaps.

## Win-Test Wiki

You can now display markers in the bandmap tab of the radio windows. Markers are defined by textual files with a .mkr extension located in the Win-Test directory. You can use and display up to 10 files simultaneously, by selecting them in the Options / Data files / Markers files... menu.

You can display or not the loaded markers by using the contextual menu item Display Options / Markers / Display. This setting can be different for each radio.

The syntax of the markers files is very basic, and are very easy to create with a simple text editor like notepad.

As usual, you can double-click on a marker to set the current radio on the freq. of the marker.

A sample file is located in WT repository: <http://download.win-test.com/files/markers/>

◇ **NcdxfBeacons.mkr** it displays markers for each NCDXF beacon.

Tnx DL1MGB for inspiration.

- WPX contest : Mult wnd (Alt-M). Band selection menu item removed. It also applies for the RDAC contest. Tnx I4UFH.

## Bugfixes

- Bugfix: \$TR1 and \$TR2 macros were not working using the microHam MK2R interface. Fixed. Tks OH2UA.

## Release information (3.9.0) (Mar 13, 2007)

### Features

- Added a tool for searching the logged exchanges which are potentially bad according to the database or to the other QSO made with the same station during the contest. Works for CQWW, ARRL DX or any contest in which there is something which apparent to a zone. It also works for the VHF contest when a gridsquare is logged. Look at this tool in menu "Tools | Check Log | Search for possible Bad Exchanges".
- Added a tool for searching N+1 for each unique logged callsign in the log. A unique callsign is considered as this as soon as it appears only one time in the log (contact only on one band and mode, and no dupe).

N+1 can be searched against the log, the callsign database (master database) or both.

It is possible to disable the N+1 search for the unique callsigns which are known in the callsign database. Look at this tool in menu "Tools | Check Log | Show Uniques".

- Coordinates (Long/Lat) expressed as decimal degrees added in the fields list which can be exported in text or CSV format. They are calculated from the country file used when the log was created, or the

gridsquare received, if any (mostly in VHF+ contests).

- QSO time in Unix time stamp format, frequency in MHz and QSX in MHz also added in the fields list which can be exported in text or CSV format.
- RDXC : Summary wnd (Alt-S) : Dupe column added for mixed category, and consistency check between the mixed category and a monomode category:
  - ◊ QSO column : Includes QSOs (even invalid ones) but not the dupes
  - ◊ Dupes column : Includes dupes only
  - ◊ Avg column = Total pts for the band / QSO column (see above).

Tnx I2WIJ

## Bugfixes

- Bugfix: "\$STR1" and "\$STR2" commands were not working in SSB when placed at the end of a scenario. Fixed.

## Release information (3.8.6) (Feb 26, 2007)

### Features

- It is now possible to use any "\$MACROS" (\$F1, \$F2...) in the additional messages as well. Tks N1FIC.
- Child wnds positions, sizes, colors and Z-orders are saved in a "smarter way" than before. Tnx DL6RAI.

### Bugfixes

- Bugfix: Workaround: Reverting back to the old way to ESCape a voice message. This is an emergency fix, just before a major contest. Tks EI3JE and I2WIJ.
- Bugfix: The RTTY additional RTTY message (ALT-C) was producing CW. Tks DL1IAO.
- Bugfix: When Keyboard Mode (ALT-K) is initiated during an F-key message ALT-K will not accept any more input when the type ahead buffer got empty (i.e. when typing too slow). Fixed. Tks DL1IAO.
- Bugfix: When pressing INS in an empty log line, no serial number is sent. Fixed. Tks DL1IAO.
- Bugfix : WPX RTTY : 160m band removed. Tnx F5CQ.
- Bugfix : WPX RTTY : Scoring updated. Tnx F5CQ.
- Bugfix : WPX RTTY : Serial numbering for M/2 category is now compliant with the rules : One

numbering sequence per transmitter.

## Release information (3.8.4) (Feb 8, 2007)

### Features

- New shortcuts introduced in [Spots wnd (Alt-A)] and in [radio Bandmap] --Tnx DL4NER, W9ZRX @ K3LR and G3OZF.
  - ◊ Ctrl + Dbl click on a spot deletes this spot (no warning)
  - ◊ Alt + Dbl click on a spot loads the sub VFO (if applicable)
- Edited spots are now considered as op-entered and are transmitted across the network. Tnx DL6RAI.
- Check partial window contextual menu items regarding the 2-char options re-labelled to improve the user interface. Tnx DL6RAI.
- Data entered in the contest settings dialog are now trimmed. Tnx W9ZRX @ K3LR.
- The CW Narrow Filter is now set on the IC-765. Tks DK4YJ & K8BB. Done also for the IC-756. Tks F5VIH/SV3SJ.

### Bugfixes

- Bugfix: Frequency was not read correctly on a FT-1000 when inserting a spot in the bandmap. The Split mode was not working either. Fixed. Tks N8TR.
- Bugfix: DK4YJ reported that sending mode information to his IC-765 always changes the filter bandwidth to 2.4 KHz in CW. For this reason, ALT+F4 now changes the mode of the radio only when necessary. Tks DK4YJ.
- Bugfix: With the "Independent speed" option in WinKey ticked, using ++ or -- in the message was changing speed to the paddle speed. Tks VE2FU.
- Bugfix: the \* key used to switch radios in SO2R caused an Icom radio that is being switched to always activate the VFO-A as default. Fixed. Tks K8BB.
- Bugfix: Station names containing a space in the first position of the string was misordered in the "Send GAB" window. Fixed. Tnx W9ZRX @ K3LR.
- Bugfix: Tentec Omni VI support is now based on the Generic Icom settings. Tks K7SV, DK4YJ and F6IFY.
- Bugfix: Entering Split on any Icom radios was always setting the mode to SSB, regardless of the current mode. Fixed. Tks K3LR.
- Bugfix: Protocol issue with either the FT-2000 or the FTDX-9000, grabbing a callsign from the bandmap was activating the split on the radio. Tks F8CIL, G4IRN.



## Release information (3.8.0) (Jan 18, 2007)

### Features

- Radio wnd / Bandmap tab : New CQ and QSY cursors to display the last CQ freq and the QSY freq of the band. These cursors can be displayed or not, according to the contextual menu settings (Display options).
- NAQP contest : When entering a NA QSO, WT now ensures all field are filled. Tnx K8BB.
- Summary columns re-order for:
  - ◇ the ARRL DX to BAND/QSO/MULTS/DXCC/DUPES
  - ◇ the CQWW DX to BAND/QSO/CQ/DXCC/DUPES/POINTS/AVGwhich is the usually used order. Tks K3LR.
- MicroHAM MK2R SO2R Protocol is now fully supported. To enable it:
  - ◇ in microHAM USB Device Router, check "microHAM SO2R protocol on COM port" in the "SO2R" tab. You can also specify "SO2R protocol controled" for RADIO 1 and/or RADIO 2 in the "ACC" tab if you want to let Win-Test control the ACC outputs to switch the antennas.
  - ◇ in Win-Test, select "MicroHAM MK2R" on the COM port the USB Device Router is attached to for SO2R control. As it is a virtual COM port, the COM port configuration (bauds, parity...) has no effect: you can choose anything.

The new macro \$MK2R=<cmd> has been added in order to send any protocol to the MK2R from a scenario. This can be usefull to set a specific audio configuration which is not a standard R1R1, R1R2 or R2R2. For example, \$MK2R=FRD100000010000 will configure the headphones audio to "Left=RADIO1,MAIN VFO and Right=Radio1,SUB VFO". Please report to the SO2R protocol specification of the MK2R to get details on the FRDxxxxxxxx command as well as on other ones.

Note that WinKey and PTT/CW events of the Win-Test integrated keyers are not handled by the protocol. It means that if you want to use Win-Key or the WT integrated keyers you must configure them separately. The PTT/CW signals can share the COM port used for the SO2R control. WinKey will require a different COM port in any case.

- In RTTY Configuration Window: Added two options:
  - ◇ MMTTY window stays on top: when enable, the MMTTY window will be always visible
  - ◇ Only show FFT spectrum, waterfall and XY scope: when enable, the MMTTY window is minimized, and does not show the Menu nor the Command Buttons.
- Added a new "RTTY" entry in menu "Options" to allow modifying the standard and additionnal messages. Also allowed to access the messages entry in the menu "Command".

## Bugfixes

- Bugfix: Internal keyer + Winkey. Tks G3SJJ.
- Bugfix: the "Copy-Paste the previous QSO" function is now available only when the cursor is on the last line of the log. Tks DL6RAI.
- Bugfix: TXing in RTTY was not canceled anymore pressing the ESC Key. Fixed. Tks F2JD.
- Bugfix: Focus problem with MMTTY is fixed. Tks DL6RAI.
- Bugfix: using a SO2R interface based on LPT port, in a message like "\$F1 \$TR2 \$MSG1", the \$TR2 macro had no effect. Fixed. Tks S51TA.
- Bugfix: Using WinKey, the CW speed of the paddle was changing under certain circumstances. Fixed. Tks DJ3WE and G3SJJ.
- Bugfix : NAQP contest : Under some circumstances, the SPC field was cleared while editing the QSO. Tnx K8BB.
- Bugfix : PACC contest : From PA side, working PA stns gave credit for province. Now, it only gives credit for PA DXCC country. Tnx PC2A.

## Release information (3.7.0) (Dec 1, 2006)

### General

3.7.0 introduces station profiles to help users who are frequently changing of callsigns / address etc... and an integrated file fixer for corrupted data files.

### Features

- The "Goto QSO" command now checks if the QSO where we want to move from is valid. It also validates that QSO before moving.
- Bandmap properties : You can now set two different lifetimes for DX cluster spots and op-entered callsigns. The maximum DX cluster spots lifetime is 60 minutes, and the op-entered spots lifetime is 120 minutes. Tnx ES5TV.
- Main log wnd : Any entered Q by a MULT stn which is not a mult is tagged with an "!!!!" indicator.
- Radio wnds : The last used tab is saved as default for further reloading or new log creation. Tnx ES5TV.
- Stats wnd : The last used tab is saved as default for further reloading or new log creation.
- The QSX freq of a cross-band spot is now ignored. Tnx DL4NER.
- Corrupted files can now be fixed once an error is detected while loading. The original file is saved

with an "\_err" suffix appended to its name. CAUTION : This fix function doesn't work with corrupted data described here: <http://www.f5mzn.org/pipermail/support/2006-November/072424.html>

- Real-time scoring informations entry fields added in the contest settings dialog : DXCC prefix, WAZ and ITU zones, State/Prov/Other. \*These data are only useful for real-time scoring\* and are not used for other purposes in Win-Test. They are not yet available in the SUMMARY network frames (to come). Tnx 5B4WN/G0WWW.
- The initial CW speed for new files can now be set by using the Options | CW | Initial speed... menu item; Tnx I2WIJ.
- You can now record 5 different station infos (callsign, name, address, etc.) presets (also called station profiles) in the contest settings dialog.

### Bugfixes

- Bugfix: packet cluster window content was lost after any change in the "Interface Configuration" window. Fixed.
- Bugfix: with the "Spot entered or sent by the operator, Log Fields are cleared" activated, sending a spot for the QSO logged above was clearing the line on the screen. Fixed. BTW, WT now takes the last QSO logged on the current station (if any) rather than the last QSO logged on any station of the network.
- Bugfix: REPEAT mode was not working with WinKey, nor the TX LED in the secondary radio window. Fixed. Tks F5JSD.
- Bugfix : When grabbing a spot, the N+1 and checkPartial wnds were not updated. Tnx DL4NER.
- Bugfix : The default "+" CW message wasn't including a trailing space after the \$CORRECT variable. This error led to a bad implementation of the \$CORRECT variable, and an extra space was inserted if the default message wasn't used. Tnx PA2A, DL4NER and others.

### Release information (3.6.2) (Nov 23, 2006)

#### Bugfixes

- Bugfix: in SO2R, repeat mode was not interrupted by a transmission on the secondary radio when using the SHIFT key. Fixed. Tks CT1ILT (CT6A).
- Bugfix: entering a callsign in the bandmap with an SO2R setup using two FT-1000D/MP/MK5 or two FT-100 or two FT-900 was in certain conditions inserting the entry into the wrong bandmap. Tks CT1BOH (CT3NT), CU2/OH2UA.

### Release information (3.6.1) (Nov 21, 2006)

## Bugfixes

- Bugfix: Double click on the WTB file was broken. Fixed. Tks I2WIJ.
- Bugfix: In SO2R Advanced Mode, when the secondary radio was bound with CAPS LOCK, automatic CQ was always stopping as soon as the operator pressed any key. Fixed. Tks CT1ILT (6Y3T, CT6A).

## Release information (3.6.0) (Nov 20, 2006)

### General

**CAUTION : New network protocol version 1.17 released - Reminder : If you use WT in a networked environment, you must have the same WT version on all machines !**

### New Features

- Added command line arguments:

◇ wt.exe [--alternative-inil-i <infile>] [WTB file to load] Tks DL6RAI.

- Added a "Polling Rate" option in the Interface Configuration Windows. Note that it is not exactly the Polling Rate which is defined here, but the delay before polling the radio again after the previous sequence is done. This delay is not so accurate with every radio. Check by yourself to see what is the value which best fits your needs!
- SteppIR controler is now supported with an Y cable. Special thanks to G3BJ.
- Main window : Extra large font added. Tnx W2RU.
- New graphics in the rate wnd (Alt-R) : Instant continents distribution. Uses the same moving parameters as the instant rates chart. Tnx CT1BOH.
- Rate wnd (Alt-R) : New options to display or hide non-essential sections of this wnd.
- New text commands QSX and NOQSX (equivalent to SPLIT and NOSPLIT).
- New text command REMAPKEYS (equivalent to DEFINEKEYS)
- Partner wnd : New real-time feature to display the callsign field of the partner(s) log(s) while he (she) is entering a callsign. See the contextual menu of this window. A runner can have up to three different support partners. To grab the first real-time slot, use Alt-Space. In all cases, you can also double-click on any callsign of this window. Tnx K3LR
- DX cluster (Alt-A) and radio wnds : A "\*" indicator is displayed before the spot callsign when there is a QSX for this spot. Tnx K3LR.

## Win-Test Wiki

- Send spot dlg (Alt-F3) : The log fields clearing after a spot has been sent is applied the same way as the self-entered spots (see the bandmaps properties contextual menu dialog).
- Score sending : "Send now!" menu item added in the summary contextual menu. It is enabled only if the score sending is enabled.
- Commands | Station type : The settings can now be sticked to the computer. If so, it will be used for any newly created logs. Tnx K3LR.
- Stats wnd (Ctrl-F9) : DXPed : Stats period extended to 4 days.
- DXPed HF and VHF+ logs : The ADIF export includes the info field in the NOTES ADIF field. Tnx FY1FL.
- Status wnd (Alt-J) : The list can now be sorted by band and by stations names if several stations are on the same band.

## Bugfixes

- Bugfix : Most of the VHF+ contests didn't have a final score line in the summary window (Alt-S), which prevented any real-time score posting. Tnx F5LEN.
- Bugfix : Alt-F4 set the radio in split (even if it originally wasn't) and a QSX freq in the nirvana ! Tnx DL6RAI, DL4NER and others.
- Bugfix: FT-1000MP in SO2R mode: in Split Mode, swaping radios was inverting TX and RX frequencies on the FT-1000MP/Mk5. Tks EA5BY and F5CWU.
- Bugfix: Could not enter a QSO to the bandmap from 2nd radio window. Everytime a callsign was typed to 2nd radio window and CTRL-Enter was pressed, the QSO was set in main radio band map to the exact QRG of the main radio. Fixed. Tks OH2UA.
- Bugfix: Using WinKey, the \$CORRECT variable was sending the logged callsign in every case, even if the callsign was not changed by the operator. Tks G3BJ (G5W).
- Bugfix: the selection of the active Sound Card when more than one is available was broken. Fixed.
- Bugfix: a short delay might be introduced when ESCaping (stopping) a recorded message played by the Internal Voice Keyer. Tks K3LR.
- Bugfix: stereo signal was not working on LPT port Pin 5. Fixed. Tks 5B4WN/G0WWW & GM0GAV.

## Release information (3.5.0) (Oct 22, 2006)

## General

**CAUTION : New network protocol version 1.16 released - Reminder : If you use WT in a networked environment, you must have the same WT version on all machines !**

## New Features

- Added CTRL+S as a shortcut for the menu "Commands | Swap the frequency on both radios". Tks EA5FV & co.
- CheckPartial and N+1 SCP files : If a DEFAULT.SCP or DEFAULT.DTA is in the WT directory, it will be used as default file for partial and N+1 checks instead of contest-specific default file. Tnx ES5TV.
- When a log is opened in a networked environment, the date of the first QSO must match the others logs date with 20 days tolerance. If not, a warning is issued and the network and the sync are disabled by default on this machine. You can override this behaviour if you really know what you're doing!
- NRAU Activity Contest (NAC) : 50 and 70 MHz added. Tnx SM3PZG.
- TXT and CSV file exports : New fields added : Date (DD-Mmm-YYYY), date (DD-Mmm-YY), Freq in Hz, QSO in kHz and Hz.

## Bugfixes

- Bugfix : RELOAD'ing a file was disabling the integrated keyer (Phone or CW) and could lead to a major crash under some particular circumstances.
- Bugfix : NRAU Activity Contest (NAC) : Bonus points per new gridsquare are now considered in the score. Tnx DL1OJ.
- Bugfix : NRAU Activity Contest (NAC) : The spacebar now loops the cursor between callsign, received RST and gridquare fields. Tnx DL1OJ.
- Bugfix : MMTTY windows were closing themselves after 10s. Fixed. Tks everybody! :)

## Release information (3.4.5) (Oct. 8, 2006)

### New Features

- Added two "Intelligent Quick Qsl" Macros: \$QQSLT and \$QQSLC. When used, these macros send two different confirmation messages, one a short QSL message (like TU or EE) and one long QSL message (like TU F5MZN).
  - ◇ A timer (\$QQSLT macro) or a counter (\$QQSLC macro) are associated with these macros to determine if either a short or a long QSL message is to be transmitted.
  - ◇ That way you can send a most of the time a short QSL message to confirm the QSO in a pileup, sending your full callsign automatically every minute or 5 QSO only.

## Win-Test Wiki

- ◇ You can adapt the counter or timer values as well as the short and long messages in the "Intelligent Quick QSL" configuration window, from the Tools menu.
- ◇ You can use the \$QQSLC and \$QQSLT macros either in the CW/RTTY Messages or in the advanced SO2R scenarios. It is also possible to use the feature in SSB (SO1R and SO2R not advanced) but this needs a specific configuration in the SSB tab of "Intelligent Quick QSL" configuration window.
- Caps Lock can now be used to bind the keyboard to the Secondary Radio Window. This can be enabled or disabled in the Operating menu. Tks SM3WMV.
- Signal "Headphones Control" (called "RX Focus" in the MK2R microHam SO2R interface) is now available on LPT, pin 4. This signal allows to control which radio you want to listen in the Headphones. Must be enabled in the LPT Configuration Window. Low = RADIO 1, High = RADIO 2.
- Signal "Headphones Control" and "Stereo RX Audio" are now available on either DTR or RTS pins of any serial COM ports. That way, the MK2R microHam SO2R interface can be fully controlled through a single USB cable.
- Microham MK2R interface is now supported in SO2R Advanced mode.
- QSY wizard wnd : Ensure that HamCAP is alive and that the chart tab is in the one selected in the Options | HamCAP | Tab menu. If not, the label "Disabled" is displayed in the window. Tnx SM3WMV.
- Worldmap window : New option to display only the terminator of the greyline. If chosen, a small sun symbol also is displayed on the map.
- Secondary radio wnd : When a binding key is used (see Operating menu), the color background of the QSO area is changed. Tnx F6IFY
- Secondary radio wnd : Complete color management, similar to the other child wnds.
- Check Partial files : WT now accepts the master.dta (CT format) or master.scp (textual) files as default check partial files for the HF contests. Note that the scp format is a bit quicker to load than the dta format.
- Ctrl-W in the sent report or exchange fields now resets this field to the default 59 or 599 report (depending on the mode). Tnx LX1NO.
- To enhance the CT compatibility, Ctrl-K now deletes the content of the current field, from the cursor position to the end of the field. It also works for the secondary radio with the Shift key, if this option is engaged in the Operating menu.
- Register dialog : The light-headed licences can now enter their account customer number to recall it when needed.
- New options to start and stop locally wtDxTelnet in the Options / DX cluster menu. wtDxTelnet \*must\* be installed in the same directory as WT (which is its default installation directory).

## Win-Test Wiki

- Macros added in the Packet Dlg window (Alt-T). To edit a macro button Shift-Click on it. Note that the Conn and Bye btns are still disabled for now. This should be improved in the future.
- Numerous new labelling and graphics elements resizing to accomodate with the German language version. Tnx DL6RAI.
- Split freq dlg (Minus key) : The entered freq is checked against the current band. Tnx W9ZRX.
- CheckPartial files : If a general contest-specific file is loaded, no band, mode or band/mode default file is loaded.
- ON Contest 80m, 6m and 2m added. Tnx F5IN.

## Bugfixes

- Bugfix : UBA Spring contests : Small inconstancies in the UBA sections list. Tnx F5IN.
- Bugfix : CQWW RTTY : The guessed zone from a previous entered Q was not filled if using the spacebar guessing. Tnx DJ1OJ and DL6RAI.
- Bugfix : Packet Dlg wnd (Alt-T) : SH/WWV and SH/WCY were sharing the same accelerator key (Alt-W). Now, SH/WCY uses Alt-Y.
- Bugfix : Under some conditions, WWV announcements coming from DXNet packet clusters were not always considered.
- Bugfix : The taskbar was flashing if the Packet Dlg (Alt-T) was in foreground, and a private gab was received.
- Bugfix : The WCY and WWV text commands were closing the solar activity wnd if it was opened, instead of changing data source.
- Bugfix : Packet Dlg (Alt-T). Even when using the macros and shortcuts buttons, the focus is now always set to the entry field.
- Bugfix : CQWW RTTY : When changing band by Alt-F1/F2, the states/provinces window was not updated. Tnx DL6RAI @ DQ4W.
- Bugfix : CQWW RTTY : Under some conditions, the zone and the state/province fields weren't updated after grab. Tnx DL6RAI @ DQ4W.
- Bugfix: Sending a spot with ALT+F3 with split activated was not transmitting the RX frequency correctly. Fixed. Tks W9ZRX & K3LR.
- Bugfix: CTRL + ENTER in split mode fixed. Tks W9ZRX & K3LR.



## Release information (3.3.5) (Sep 20, 2006)

### General

**CAUTION : New network protocol version 1.15 released - Reminder : If you use WT in a networked environment, you must have the same WT version on all machines !**

### New Features

- Added support for the Yaesu FTDX-9000 radio. Tks VE6SH, OM7ZZ.
- Added support for the Yaesu FT-2000 radio.
- Added support for the Yaesu FT-857. Tks M0CRY.
- Icom radios: CI-V mode is back again as an option (you can now decide if you want to poll the radio or use the CI-V mode). This option is available in the "Interface configuration" window. Tks W9ZRX, K3LR.
- Programming an Icom radio is now more reliable (a check is done to ensure that the radio got the protocol) and more faster. Tks W9ZRX, K3LR.
- New option to start (resp. stop) wtDxTelnet when WT is started (resp. stopped) automatically in the Options / DX cluster menu. wtDxTelnet *\*must\** be installed in the same directory as WT (which is its default installation directory).
- New RESTART text command, to (guess what ?) restart Win-Test.
- QSX are now parsed from the packet stream and are handled in the bandmaps and the DX cluster spots wnd (Alt-A). The split freq is also handled when spots are entered by the op with Ctrl-Enter (or Ctrl-J). Tnx K3LR.
- CQWW Contest : RTTY leg implemented. This implementation is not totally complete but is fully usable to take part in the competition. It will be improved later, especially when the new databases designs (including multi-field guessing) will be implemented.
- Child wnds : Font size : New menu items added to get larger and smaller font by one point, and a new "Other..." item to set a non-listed font size. Tnx W9ZRX @ K3LR.
- CheckPartial and N + 1 files can now be different of the "database" DTB file associated with the contest.

◇ WT now accept SCP (stands Super Check Partial) plain text files (one callsign per line - no ordering required), DTA CT files and DTB files for compatibility.

◇ The preferred format is SCP (plain text).

◇ Furthermore, WT now also accepts specialised CheckPartial files by band and by mode for a given contest. This improves log accurancy and QSO rates.

Please, read: [http://download.win-test.com/files/checkPartial/#\\_READ\\_ME#.TXT](http://download.win-test.com/files/checkPartial/#_READ_ME#.TXT) for more informations.

- CheckPartial (F8) and N+1 (F12) wnds : New contextual menu item to list the used files for the searches.
- WAE Contest : EU Side : The new multiplier warning now claims "New multiplier" instead of "New prefix". The multiplier indicator in the bandmap status has also been changed from C (Country) to M (Mult). Tnx DL1MGB.

## Bugfixes

- Bugfix : SAC contest : In M/M category only, the serial numbering is different for each band. Tnx SM6DYK.
- Bugfix : SAC contest : The CW variable \$SERIAL wasn't included in the default messages. Tnx I2WIJ and F5IN.
- Bugfix : Internal CW keyer : If a message was interrupted by ESC while a burst was sent, the speed didn't revert to the original speed. Tnx OH2UA, OH1JT and F6IFY.
- Bugfix: IC-7800 was not controlled as expected. Fixed. Tks W9ZRX, K3LR.
- Bugfix: under CW autosending mode, pressing ESC was disabling this feature in any case which was not always wished. From now, pressing ESC will disable autosending mode as soon as the key is not pressed when the radio is transmitting or if the caret is not in the callsign field. Tks ES5TV, UA6AA.

## Release information (3.2.0) (Aug 30, 2006)

### General

- CIS contest : Adapted to the new rules 2006 (bands : 160m to 10m). The Contests of the month feature is also updated. Tnx F5IN.
- RDA Contest : Cursor positioning after exchange guessing modified, depending on the guessed region or district and the callsign. Tnx HA1AG, UA6AA.
- TOEC contest : It is now held in September instead of August. Thus, the "Contests of the month" checkbox feature is updated. Tnx F5IN.

### New Features

- CheckPartial (F12) and N+1 (F8) windows :  
New option in the contextual menu to limit searches to the available space of these windows. It is only useful for very slow configurations : For a given callsign, once the window is filled, no more search is performed, even if the window is resized.  
By default, this option is disabled, meaning that if more matching callsigns are available (because [+n] is displayed), you can now display them by enlarging these windows on the fly.
- New network protocol advanced settings dlg in the interface settings dlg.

**CAUTION: Modifications of the default settings must be considered with an extreme attention. It is reserved for very particular configurations or purposes, mainly used by expert users. You're on your own!**

We offer some preset example configurations :

- ◇ Silent time master : Can be used if the computer is used to \*only\* distribute an accurate clock. It will not appear in the status wnd of the other networked computers, but it will be listed in an INVENTORY command. Note that NO QSO will be recorded on (and sent from) this machine with this preset.
- ◇ Silent backup : Can be used if the computer is \*only\* used for this purpose : It will not appear

## Win-Test Wiki

in the status window of the other networked computers, but will be listed in a INVENTORY command.

- ◇ Packet sharing : Can be used if different stations are networked with different callsigns, do not want a common log, but want to share a common packet stream. Can be used for several single-ops stations for example.
- ◇ Silent log rebuilding : Can be used if you need to rebuild from scratch a complete log from networked stations, without appearing in the status wnd of the other networked computers, but will be listed in a INVENTORY command.

- User interface : You can now drag any child wnd (except the RTTY windows) by using the Ctrl key (held down) and left-click anywhere in the wnd. It avoids to click strictly in the title bar region.
- New feature : Flexible and powerful bandplans management. See (among others) the Options / Bandplans menu item.
- Partner wnd : You can now enter data from the secondary radio wnd. Tnx OH4JFN.
- Partner wnd : New "No band/mode filtering" contextual option added. Might be useful in some unusual cases.
- New options in the integrated voice keyer settings to mute or not the microphone input.  
Reminder : These settings can be modified on the fly with the following text commands :

- MIC : Enables the mic input when the VK is not playing
- NOMIC : Mutes the mic input when the VK is not playing (\*)
- MICWHENPLAY : Enables the mic input when the VK is playing
- NOMICWHENPLAY : Mutes the mic input when the VK is playing (\*)

(\*) Default settings.

- Band changes Alt-F1/F2 : WT is now compliant with WL and CT :  
ALT-F1 Next lower band 20 -> 40 -> 80 -> 160 -> 10 -> 15 -> 20  
ALT-F2 Next higher band 20 -> 15 -> 10 -> 160 -> 80 -> 40 -> 20  
"Lower" means "Lower frequency"... The menu item labels, and the toolbar tooltips are consistent with this behaviour. Tnx I2WIJ, DL4NER, F6BEE.
- New Options / Windows / Default opened windows feature. This dialog allows you to select the default windows which are opened when a new contest log is created.
- Check partial wnd (F12) and N+1 (F8) wnd : A double click on a callsign inserts it in the callsign field. Tnx F6IRF.
- New extra informations window (Alt-X => Stands for eXtra). This window displays data included in .xdt (eXtra DaTa) files. These files are textual and have a very basic "Callsign Data" syntax. The # TITLE directive is used to display a title in the wnd.  
You can set up to 10 default extra data files by a new menu (Options / Data files / Default data files). : These files will be opened with every log. They must be located in the WT installation directory. You can also add log-specific extra data files by using the "Extra files..." item in the contextual menu of this wnd. There is no limitation to the location and the number of these log-specific files.  
Some usages of this new feature :

- ◇ VHFers can have a database of stations QRV on such or such band, to ask for a QSY.
- ◇ Operators names
- ◇ List of WT users ;-)
- ◇ etc...

This feature is tailored to deal with few thousands of callsigns only. Don't try it with millions of lines !

If you modify an .xdt file while it is in use, you must reload it by using the "Reload files" item menu.

## Win-Test Wiki

The # VARIABLE directive allows you to send the extra information in a CW message by using a variable name. The variable name \*must\* begin with the \$ character.

Example : # VARIABLE \$OPNAME will substitute the \$OPNAME string in the CW messages with the extra info included in this file, if the sent callsign has matching data.

**CAUTION : The variable substitution only works with the internal CW keyer for now.**

- To enhance CT compatibility, Alt-F5 saves the current mode and freq as the Run freq/mode. It means you can use this command to "store" these data without using the F1 key.
- ADIF export : If a power level is set in the contest setup dialog, this string is exported in the TX\_PWR field of every QSO record. Tnx W4TME.
- ADIF export : New option to include the contest name in the NOTES field of every QSO. Tnx W4TME.
- Cabrillo export : New option to exclude modes in the Cabrillo file. Tnx TM0HQ.

## Bugfixes

- Bugfix : CheckPartial wnd (F12) : In some cases, the result list was wrong if the pattern started or ended with a question mark.
- Bugfix : N+1 wnd (F8) : If the wnd width was smaller than one resultcell, WT crashed. Tnx DJ3WE.
- Bugfix : CheckPartial wnd (F12) : In some cases, the result list was truncated, although there was more available empty space.
- Bugfix : Some frequency fields (especially in dialogs) didn't accept the dot character.
- Bugfix : Partner wnd : Ctrl-# (exchange current callsign with line #) was crashing partner WTs.
- Bugfix : WAEDC : After entering the keyboard mode while the QTC window was opened (Alt-L), WT was crashing on the first keypress Tnx DL1MGB.
- Bugfix : Internal CW keyer : Speed modifications by Alt-F9/F10 during the +/- "bursts" \*should\* work now. Tnx OH2UA, OH4JFN, F5VIH and others.
- Bugfix : Check country wnd (F10) : The geographical and timezone exceptions included in the CTY\_WT\_MOD.DAT weren't used in the WAE, RGSB 15/10 and PACC contests. Tnx F5IN.
- Bugfix : After entering a freq, and hitting Alt-Up, the keyer sent the freq instead of the callsign ! Tnx F6BEE.

## Release information (3.1.0) (Jul 27, 2006)

### General

- **CAUTION : New network protocol version 1.14 released. Reminder : If you use WT in a networked environment, you must have the same protocol version on all machines !**

### New features

- Reverse mult check (Shift-F10) : If the mults are mode-dependent, (IOTA contest, ARRL 10 for ex.) worked stations are ordered by band and mode.
- Check mult wnd (F10) : When automatic update is engaged, any modification in the received exchange field updates this wnd accordingly. Tnx OH4JFN.
- Check mult wnd (F10) : New CQWW DX display policy for all displayed bands. Tnx OH4JFN.

1. The exact callsign is searched
  2. If not found, the same country with the same zone is searched
  3. If not found, the same country whatever zone is searched
  4. In all cases a zone indicator is also displayed :
    - ◆ 'Z' means the current zone is already worked in the current country.
    - ◆ 'z' means the current zone is already worked in another country.
- Contest settings dlg : New button to help filling the exchange field.
  - COM properties dlg : New button to set default settings depending on the COM port usage. Must be tested in the real world !
  - New Tools / Data entry / Remap slash to portable in VHF+ and FD option. This only works for callsign field in the log, for all VHF+ (DXPed included) and Field Day contests.
  - Automatic and on-demand backups (Options / Automatic backup) : You can now get one different timestamped file per backup. Tnx DL5MLO @ DA0HQ.
  - Backups : If a backup fails, you are asked if you want to disable the next automatic backups, if any.
  - Partner wnd : When a QSO is entered, or got from the network, the logged callsign is checked against the content of the partner wnd, and accordingly removed from it. Tnx DL1MGB & DL6RAI @ DA0HQ.
  - Partner wnd : When automatic exchange guessing is enabled, any grabbed callsign from the partner wnd is checked and exchange field is filled accordingly. The check partial and N+1 windows are now also updated. Tnx DL1MGB & DL6RAI @ DA0HQ.
  - Sked wnd (Alt-B) : Pops up for a hot sked only if the main WT window is not iconic, to avoid visual annoyance.
  - Commands / Remote command menu item added. Only enabled if there are several stns on the network.
  - Remote command dlg : You can now also locally apply the entered command.
  - Send gab dialog (Alt-G) : If the text starts with "/me", it is replaced with the station name, and the text is emphasized with leading and trailing star character (\*), a la IRC.
  - Status Wnd (Alt-J) : You can now enable (or disable) logging a summary of the network activity. Might be useful for network basic troubleshootings. This log uses the .ntk (stands for NeTwork) file extension.

### Bug fixes

- Bugfix : Under some circumstances, when a sync was in progress, multipliers tables were totally messed up ! Tnx TM0HQ and DA0HQ
- Bugfix : Automatic backup dlg : Setting the backup file path was disabling the automatic backup. Tnx DL5MLO @ DA0HQ.
- Bugfix : Merge progress bar title was corrupted. It now displays the master file name.
- Bugfix : If clocks were not in sync, the offtime timer could display negative time ! Tnx TM0HQ.
- Bugfix : INV (or INVENTORY) command : All networked stations were getting back the status, although only the sender was supposed to.
- Bugfix : Sked wnd (Alt-B) : Under some circumstances, the scrollbar was not initialized as expected.

### Release information (3.0.0) (Jun 22, 2006)

## New features

- RTTY support : Based on the MMTTY package (which must be installed separately), the 2-radios RTTY windows now allow you to take part in the RTTY contests with the same user experience as CW and Phone contests.
- Windows colors customization : Every color in the child windows can now be modified and saved on-the-fly. It means you instantaneously see the window aspect as you modify colors. No "try and see", nor numerous "apply" ! Of course, you can always revert to the factory settings if needed for one or all colors of the considered window.
- Log synchronization : Based on a peer-to-peer model, opened logs can be synchronized between all stations on-the-fly, without need of a central server. If new stations come in the network during a contest, their logs are automatically updated. Of course, you still can run and enter QSOs even if the sync is in progress.
- Partner window : Very useful in multi-op environment, if you have 2 ops (or more) listening the same frequency : The partner(s) can easily help his runner by entering callsigns (or part of callsigns) he hears.
- Remote commands : In a networked environment, you can send text commands to one, several or all connected stations. Every sent command is acknowledged in the Gab window.
- New log binary file format : The v2 binary format of the log files was no more adapted to add new major enhancements. Thus, we decided to expand it to allow more data per recorded QSO. The conversion to this new format is fully automatic. WT 3 will automatically convert your v2 logs to the v3 format, and save the original v2 file with the wt2 extension (mylog.wt2) if you want. This allows you to re-open this file with a WT 2 - just in case !

## Namespaces

- [Page](#)
- [Discussion](#)

## Variants

## Views

- [Read](#)
- [View source](#)
- [View history](#)

## More

- This page was last edited on 3 August 2009, at 08:17.
- [Privacy policy](#)
- [About Win-Test Wiki](#)
- [Disclaimers](#)



# Rotators

From Win-Test Wiki

[Jump to navigation](#) [Jump to search](#)

Automated rotators may be controlled by an external application provided as part of the Win-Test package called **wtRotators**. This program (wtRotators) communicates directly with the rotator hardware via serial ports, **not** Win-Test. Win-Test just sends broadcast messages to wtRotators.

## Contents

- [1 Configuring wtRotators \(single-op environment\)](#)
  - ◆ [1.1 Configuring Win-Test for wtRotators](#)
  - ◆ [1.2 Configuring wtRotators \(single PC, no network\)](#)
    - ◇ [1.2.1 Add your rotators](#)
  - ◆ [1.3 Testing the configuration](#)
  - ◆ [1.4 Editing the rotator configuration](#)
  - ◆ [1.5 Adding additional rotators](#)
  - ◆ [1.6 Initializing rotator communications](#)
- [2 Configuring wtRotators \(multi-op environment\)](#)
  - ◆ [2.1 Obtaining your network broadcast address](#)
  - ◆ [2.2 Configuring wtRotators \(multiple PCs in a network\)](#)
  - ◆ [2.3 Add your rotators](#)
- [3 See Also](#)
  - ◆ [3.1 In the manual](#)

## Configuring wtRotators (single-op environment)

The reasoning behind using a separate program for controlling rotators was to be able to have only one PC per rotator controller in a multi-op environment, rather than having to switch rotator control between different PCs. But, in a single PC environment, no network is required.

Configuration of wtRotators is straightforward, very similar to configuring wtDxTelnet. It only needs to be done once. This section explains how to setup wtRotators and Win-Test for use in a single-op environment, with both wtRotators and Win-Test running on the same computer. There are further instructions below describing what has to be done in a multi-op environment.

## Configuring Win-Test for wtRotators

First, open the [Configure Interfaces window](#) in Win-Test via `Options | Configure interfaces . . .`, or just type the text command **SETUP** and press **[Enter]**. Check the box labeled **Enable local network** and ensure that it looks like the following:



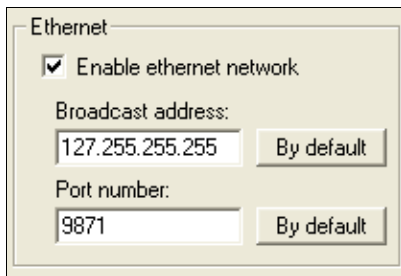

When running both programs on a single PC, use the "loopback" broadcast IP address, **127.255.255.255**. No network connection is required when specifying this special address; it is internal to the machine and always present.

Press **[OK]**. This is the only change of configuration you'll have to make in Win-Test itself. You can also open the rotators window via [Windows | Rotators](#).

## Configuring wtRotators (single PC, no network)

Start wtRotators (in Windows, [Start | Programs | Win-Test | wtRotators](#), or use the pop-up menu in the [Win-Test Rotators Window](#). From the wtRotators menu, select **Options | Win-Test Network Properties**.

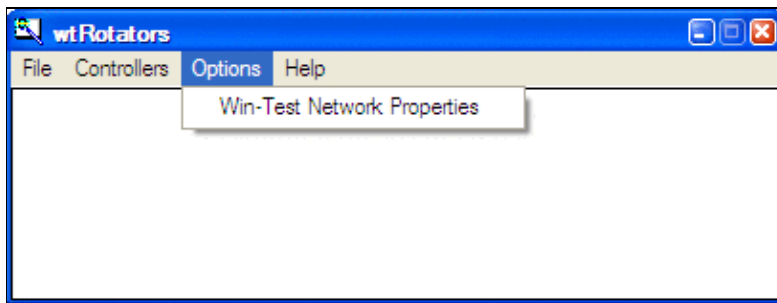

Edit all the values so that they look exactly like this:

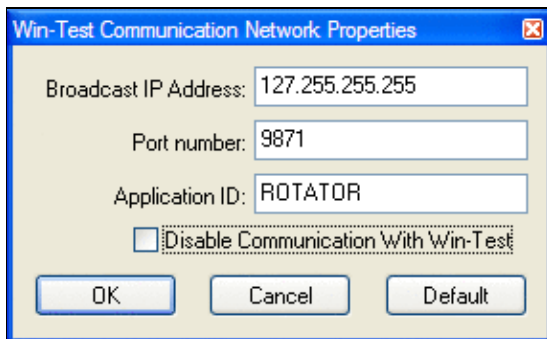

These options may well be greyed out by default, in which case be sure to *uncheck* the box labeled **Disable communication with Win-Test**, and then you will be able to edit everything. Use the same loopback broadcast address and port number that you specified in Win-Test, as shown above.

Press **[OK]**. You may then see a security alert from Windows about wtRotators:

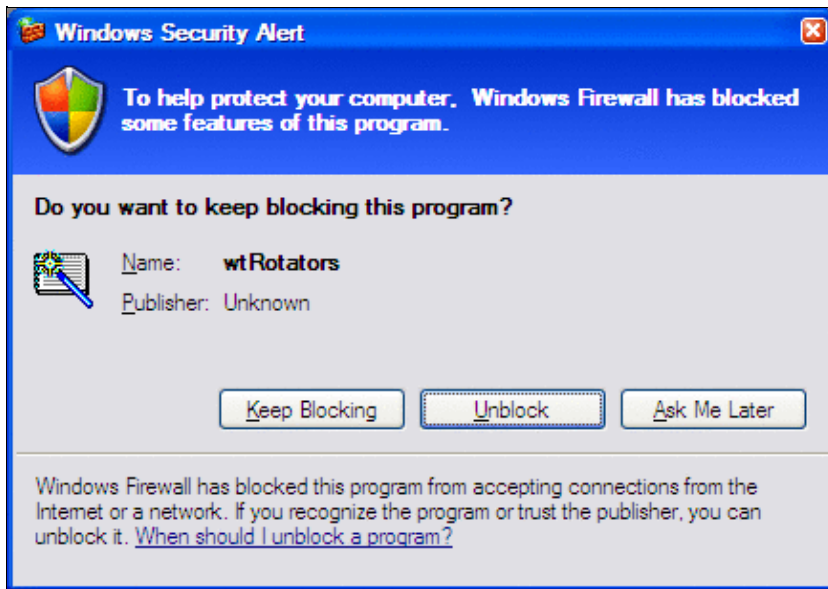

This is normal. Press [Unblock] and you should never see it again.

Note that wtRotators must always be running in the background if you want automated control of your rotators via Win-Test. Like wtDxTelnet, wtRotators can be started and stopped automatically. See [Windows | Rotators](#).

### Add your rotators

From the wtRotators menu, choose **Controllers** | **Add**.

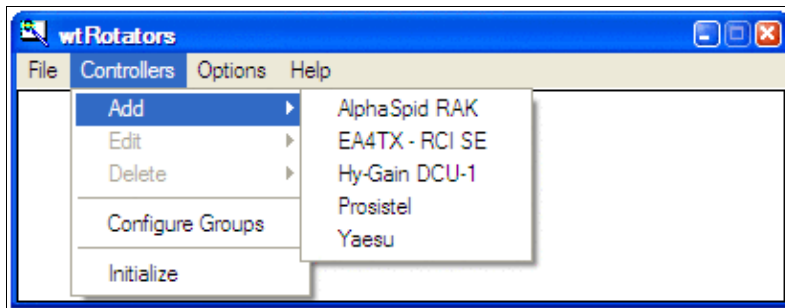

Select a rotator type from the list. If you are using a [Green Heron RT-21](#) control box, select **Hy-Gain DCU-1**.

Next, enter all the values applicable to the antennas turned by that rotator, for example:

Antenna Name	Band	Offset	Heading Range	Bidirect
5 ele 10	10 M			<input type="checkbox"/>
5 ele 15	15 M			<input type="checkbox"/>
5 ele 20	20 M			<input type="checkbox"/>
3 ele 40	40 M			<input type="checkbox"/>
80m Rotary Dipole	80 M	90		<input checked="" type="checkbox"/>

A quick description of the various settings here. Most of the fields in this window have a "tool tip"; just hover the mouse pointer over the field to display quick pop-up help text about the field.

- **Com Port** - Select **COM1**, **COM2**, etc., whatever serial port is connected to the specified rotator. Baud rate and other settings are determined automatically by the previously-selected rotator type. To disable rotator control, select **None**.
- **Rotator Name** - The rotator name you choose will appear in the wtRotators messages window, and at the top of the small controller window.
- **Affected Group** - Select a group name or select **None**. The default group names are **Group #1** to **Group #18**, but you can edit these group names via **Controllers | Configure Groups**. You can put several antennas into a group to turn them all at once. This is useful for stacked antennas which are on separate rotors. In WT, you can then turn the "stack" (all rotors will be turned to the target azimuth), or you can turn them independently (for example, both antennas beamed to two different directions).
- **Show controller** - When this box is checked, wtRotators will launch a small "controller window" (on the PC with the rotator) that displays the same beam heading as displayed by the rotator control box. Arrow buttons at the bottom may be used to manually turn the rotator counter-clockwise [**<**] or clockwise [**>**]. It also has a pop-up menu for quickly selecting beam headings from 0 to 330° in 30° increments or any specific heading (*right click* to view the pop-up).

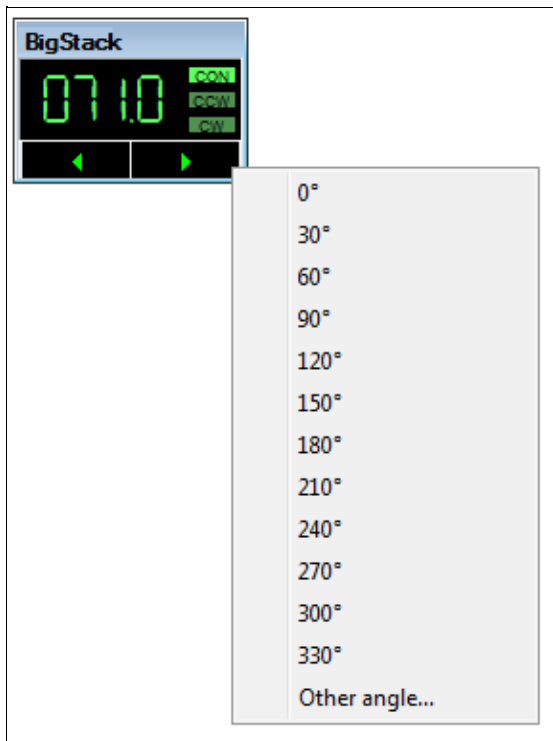

- **Rotation limits** - Click to display pop-up window where you can enter the range of values supported by this rotator. Any heading outside the range will be translated to the nearest limit. [Q: How does one specify that 170 to 190° are "out of range"? --Ed.]

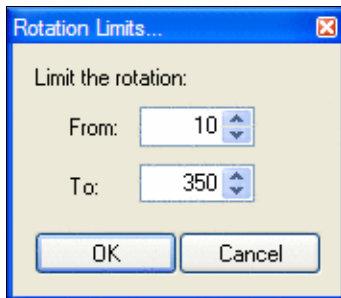

- **Antenna Name** - Choose any name for your antennas. Each antenna must have a unique name.
- **Band** - Operating band. Win-Test turns the proper rotator based on the operating band of the active radio. For multiband antennas, create several entries as shown above. Omitted bands will be ignored by this instance of wtRotators.
- **Offset** - Offset to add if the antenna is skewed from the rotator indication. Click to enter a value between 0 and 360°. For example, if you have a rotary dipole in line with the booms of your Yagis, use 90° as shown in the example. If your antenna is actually pointing at 20° when the rotator indicates 0°, enter 20. Be sure to check **Enable Offset** as shown. For "negative" offsets, like "-25°", use the equivalent value, 335°.

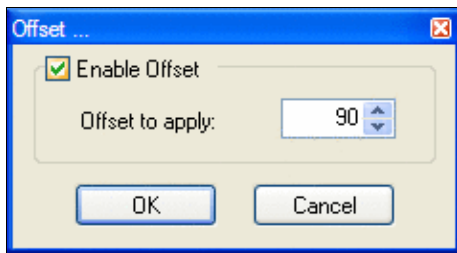

- **Heading Range** - Click to specify a range of beam heading values supported by this antenna. If the antenna is to be used for all directions, leave this column blank by unchecking **Enable a Beaming Range for that Antenna**. [Q: How to specify a range that excludes 170 to 190°? --Ed.]

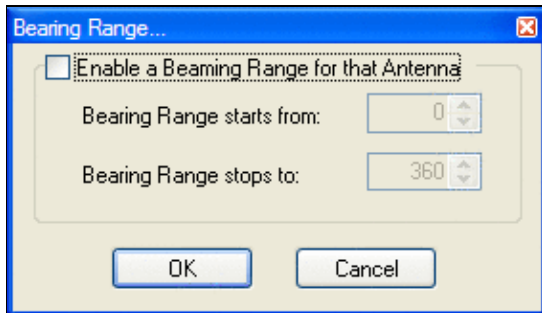

- **Bidirect** - Check this box when using a bi-directional antenna, such as a dipole. Win-Test will automatically move the rotator to the nearest usable beam heading.

Press **[OK]** to save all changes, or **[Cancel]** to start over.

## Testing the configuration

Once you have setup both Win-Test and wtRotators, it is time to verify that you can control the rotator from within Win-Test.

In Win-Test, enter either a **callsign** or a **beam heading** (0 to 360°) on the last line of the log entry window, and press **[Ctrl]+[F12]** to rotate to that heading. When entering a callsign or prefix, use **[Alt]+[F12]** for long (or "alternate") path. You can also move the cursor up to a previous QSO and press either key to rotate to the heading for that callsign. Callsign prefixes within your own country cannot be used to rotate the beam.

You should immediately see a message in the wtRotators window such as the following:

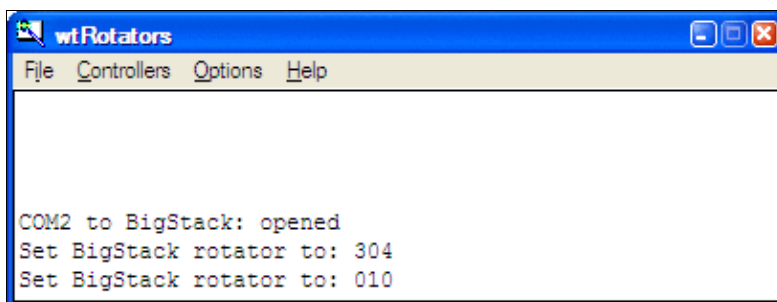

and the rotator should turn to the indicated heading.

**If you see no messages in the wtRotators window**, it means no antenna was named and defined for that band, or it means Win-Test and wtRotators are not communicating properly. Verify that both are using the same broadcast IP address and port number, and that "Disable communications with Win-Test" is *not* checked, and that your firewall is not blocking the port.

## Editing the rotator configuration

From the wtRotators menu, choose **Controllers** | **Edit** or **Controllers** | **Delete**.

## Adding additional rotators

From the wtRotators menu, choose **Controllers** | **Add** and repeat the procedure described above for each rotator that you want to support.

## Initializing rotator communications

wtRotators automatically re-initializes communications with the rotator when any change is made. If the rotator is temporarily disconnected or powered off, or if wtRotators is no longer turning the rotator even though all the normal messages are displayed, from the wtRotators menu, select **Controllers** | **Initialize** and wtRotators will reopen the specified COM port and attempt to re-establish communications with the rotator controller.

## Configuring wtRotators (multi-op environment)

The above guide covers setting up Win-Test and wtRotators in a single-op environment and thankfully the only difference between the two configurations is the networking set-up in wtRotators.

## Obtaining your network broadcast address

In order to configure wtRotators correctly, you need to know the IP broadcast address you have set in Win-Test for the network. Simply open the [Configure Interfaces window](#) in Win-Test via **Options** | **Configure interfaces...**, or just type the text command **SETUP** and press **[Enter]**. Press the **[By default]** button to have Win-Test automatically calculate the broadcast address based on your PC's current IP address.

The broadcast address is found as follows:

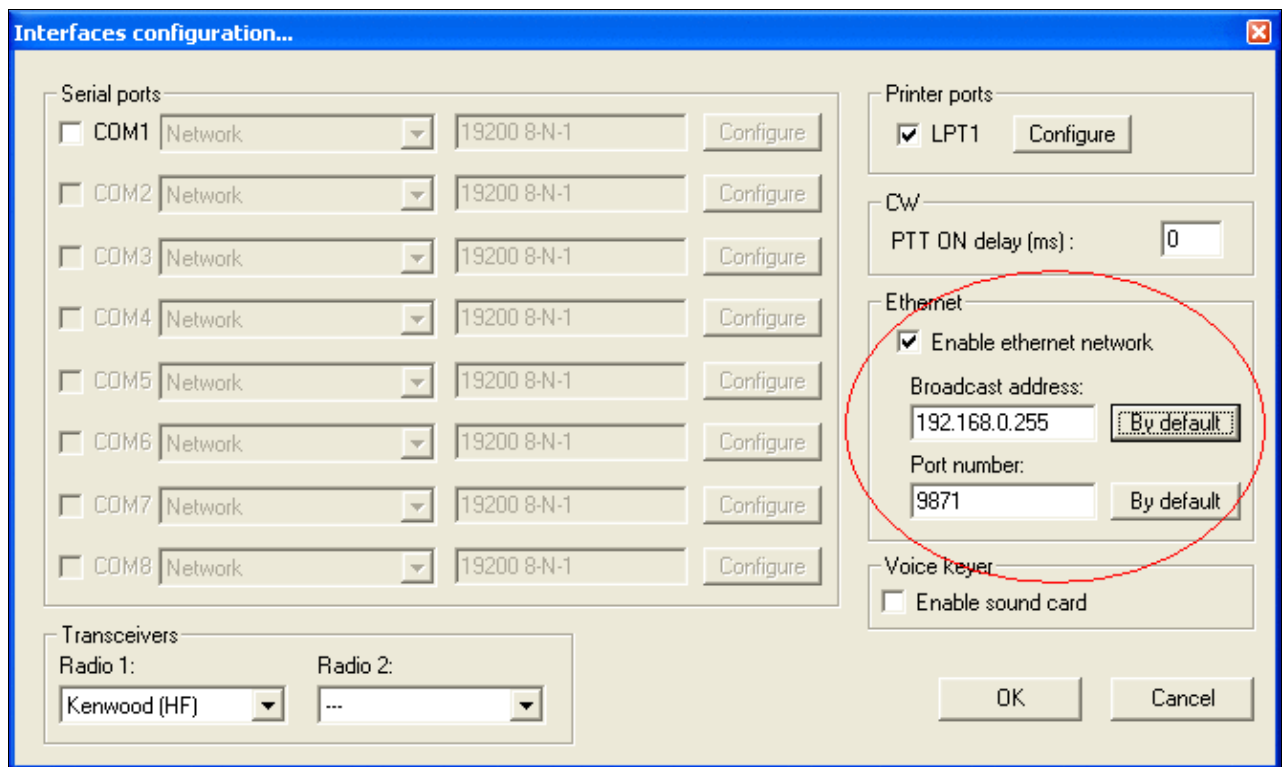

So, in this above example, the broadcast address is **192.168.0.255**. Use this same broadcast address and port number in wtRotators, in wtDxTelnet, and in all networked PCs. Just press the **[Default]** button in wtRotators, and it will calculate the same broadcast value as Win-Test, no need to write anything down.

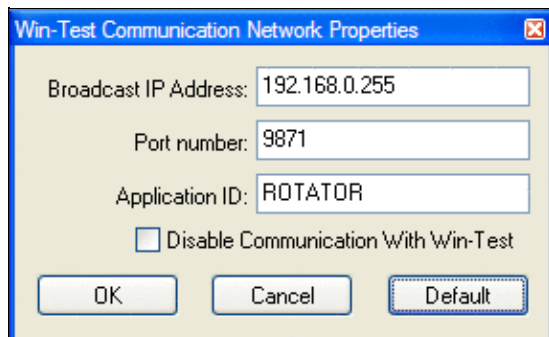

## Configuring wtRotators (multiple PCs in a network)

The advantage of wtRotators in a multi-op environment is that you only require *one* connection to a rotator control box, all networked PCs will be able to control that rotator, based on operating band.

Follow the steps above, for configuring wtRotators in a single-op environment, but the network properties will be different. Go to the **Options | Win-Test Network Properties** menu in wtRotators.

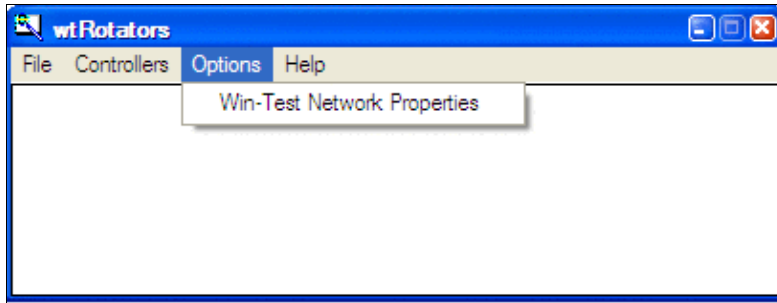

Use the following details:

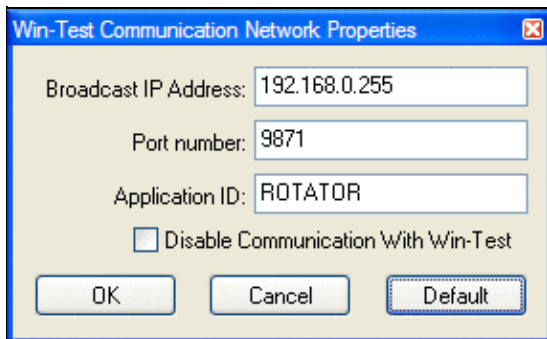

- **Broadcast IP address** - It is *very* important that you get the address absolutely correct for the rotator data to be propagated across the network. It **must** match the broadcast address which you have specified in Win-Test's network properties in the previous step. Using the example above, in this instance, the broadcast IP address would be **192.168.0.255**. Just press the [**Default**] button shown above, and wtRotators will calculate the same default broadcast address as Win-Test's [**By default**] button.
- **Port number** - Can usually be left as-is. Again, it must match what has been specified in Win-Test. The same port number can be used for both wtDxtelnet and wtRotators. The default port number is 9871. Use 9871 unless you have already changed the port number (and thus you should know what you're doing and thus you should know the port number).
- **Application ID** - Can also be left as **ROTATOR**.

Click [**OK**], and you have successfully configured both Win-Test and wtRotators. You should now test the configuration as described above.

## Add your rotators

Add your rotators as described above. Keep in mind that any rotator can be turned by any operator, so take care to limit the bands and beam headings covered by each rotator.

## See Also

### In the manual

- Setting up networking in a multi-op environment
- Windows | Rotators



## Namespaces

- [Page](#)
- [Discussion](#)

## Variants

## Views

- [Read](#)
- [View source](#)
- [View history](#)

## More

- This page was last edited on 30 December 2021, at 10:01.
- [Privacy policy](#)
- [About Win-Test Wiki](#)
- [Disclaimers](#)



# Rotators

From Win-Test Wiki

[Jump to navigation](#) [Jump to search](#)

Automated rotators may be controlled by an external application provided as part of the Win-Test package called **wtRotators**. This program (wtRotators) communicates directly with the rotator hardware via serial ports, **not** Win-Test. Win-Test just sends broadcast messages to wtRotators.

## Contents

- [1 Configuring wtRotators \(single-op environment\)](#)
  - ◆ [1.1 Configuring Win-Test for wtRotators](#)
  - ◆ [1.2 Configuring wtRotators \(single PC, no network\)](#)
    - ◇ [1.2.1 Add your rotators](#)
  - ◆ [1.3 Testing the configuration](#)
  - ◆ [1.4 Editing the rotator configuration](#)
  - ◆ [1.5 Adding additional rotators](#)
  - ◆ [1.6 Initializing rotator communications](#)
- [2 Configuring wtRotators \(multi-op environment\)](#)
  - ◆ [2.1 Obtaining your network broadcast address](#)
  - ◆ [2.2 Configuring wtRotators \(multiple PCs in a network\)](#)
  - ◆ [2.3 Add your rotators](#)
- [3 See Also](#)
  - ◆ [3.1 In the manual](#)

## Configuring wtRotators (single-op environment)

The reasoning behind using a separate program for controlling rotators was to be able to have only one PC per rotator controller in a multi-op environment, rather than having to switch rotator control between different PCs. But, in a single PC environment, no network is required.

Configuration of wtRotators is straightforward, very similar to configuring wtDxTelnet. It only needs to be done once. This section explains how to setup wtRotators and Win-Test for use in a single-op environment, with both wtRotators and Win-Test running on the same computer. There are further instructions below describing what has to be done in a multi-op environment.

## Configuring Win-Test for wtRotators

First, open the [Configure Interfaces window](#) in Win-Test via `Options | Configure interfaces . . .`, or just type the text command **SETUP** and press **[Enter]**. Check the box labeled **Enable local network** and ensure that it looks like the following:

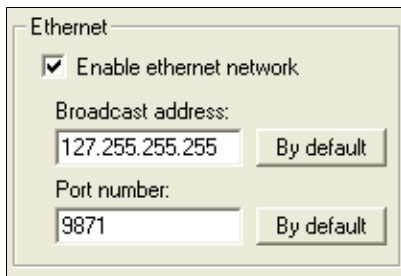

When running both programs on a single PC, use the "loopback" broadcast IP address, **127.255.255.255**. No network connection is required when specifying this special address; it is internal to the machine and always present.

Press **[OK]**. This is the only change of configuration you'll have to make in Win-Test itself. You can also open the rotators window via [Windows | Rotators](#).

## Configuring wtRotators (single PC, no network)

Start wtRotators (in Windows, [Start | Programs | Win-Test | wtRotators](#), or use the pop-up menu in the [Win-Test Rotators Window](#)). From the wtRotators menu, select **Options | Win-Test Network Properties**.

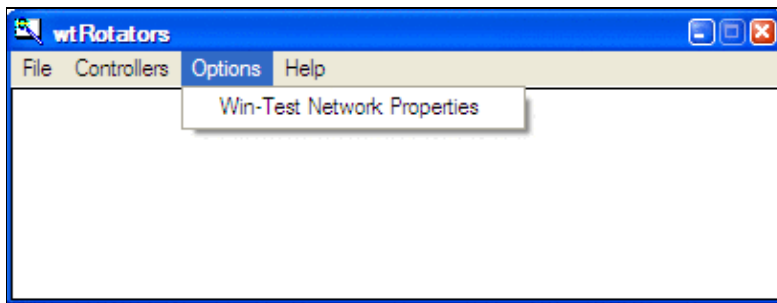

Edit all the values so that they look exactly like this:

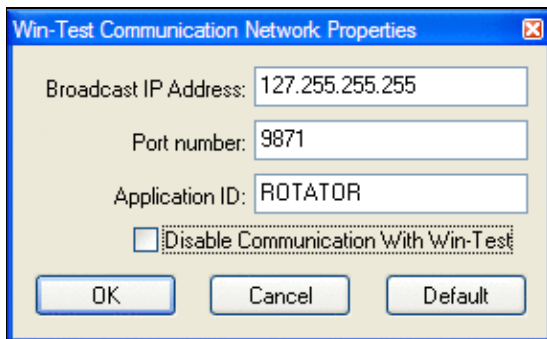

These options may well be greyed out by default, in which case be sure to *uncheck* the box labeled **Disable communication with Win-Test**, and then you will be able to edit everything. Use the same loopback broadcast address and port number that you specified in Win-Test, as shown above.

Press **[OK]**. You may then see a security alert from Windows about wtRotators:

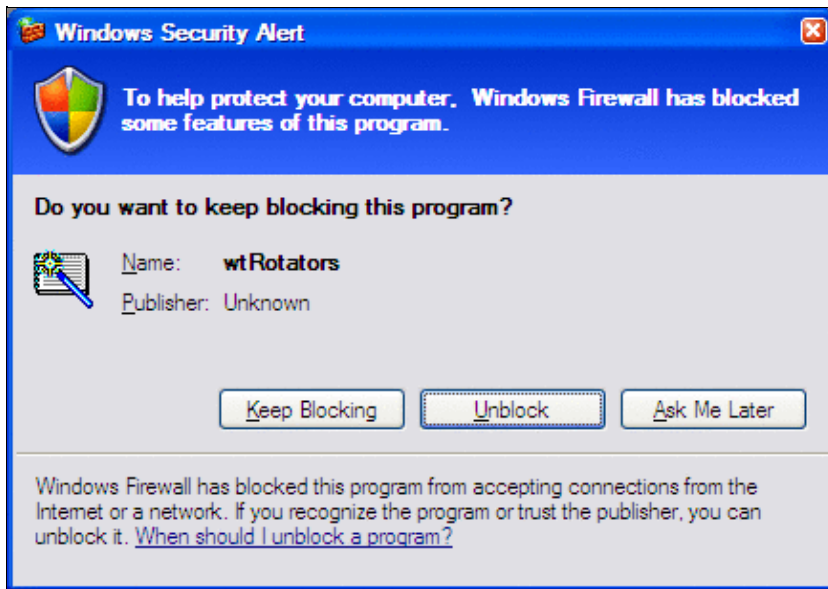

This is normal. Press [**Unblock**] and you should never see it again.

Note that wtRotators must always be running in the background if you want automated control of your rotators via Win-Test. Like wtDxTelnet, wtRotators can be started and stopped automatically. See [Windows | Rotators](#).

### Add your rotators

From the wtRotators menu, choose **Controllers** | **Add**.

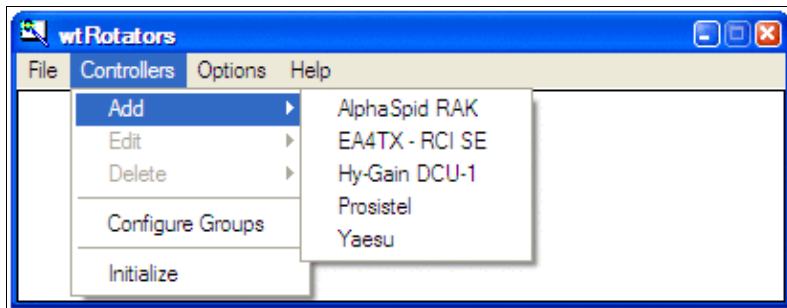

Select a rotator type from the list. If you are using a [Green Heron RT-21](#) control box, select **Hy-Gain DCU-1**.

Next, enter all the values applicable to the antennas turned by that rotator, for example:

Antenna Name	Band	Offset	Heading Range	Bidirect
5 ele 10	10 M			<input type="checkbox"/>
5 ele 15	15 M			<input type="checkbox"/>
5 ele 20	20 M			<input type="checkbox"/>
3 ele 40	40 M			<input type="checkbox"/>
80m Rotary Dipole	80 M	90		<input checked="" type="checkbox"/>

A quick description of the various settings here. Most of the fields in this window have a "tool tip"; just hover the mouse pointer over the field to display quick pop-up help text about the field.

- **Com Port** - Select **COM1**, **COM2**, etc., whatever serial port is connected to the specified rotator. Baud rate and other settings are determined automatically by the previously-selected rotator type. To disable rotator control, select **None**.
- **Rotator Name** - The rotator name you choose will appear in the wtRotators messages window, and at the top of the small controller window.
- **Affected Group** - Select a group name or select **None**. The default group names are **Group #1** to **Group #18**, but you can edit these group names via **Controllers | Configure Groups**. You can put several antennas into a group to turn them all at once. This is useful for stacked antennas which are on separate rotors. In WT, you can then turn the "stack" (all rotors will be turned to the target azimuth), or you can turn them independently (for example, both antennas beamed to two different directions).
- **Show controller** - When this box is checked, wtRotators will launch a small "controller window" (on the PC with the rotator) that displays the same beam heading as displayed by the rotator control box. Arrow buttons at the bottom may be used to manually turn the rotator counter-clockwise [**<**] or clockwise [**>**]. It also has a pop-up menu for quickly selecting beam headings from 0 to 330° in 30° increments or any specific heading (*right click* to view the pop-up).

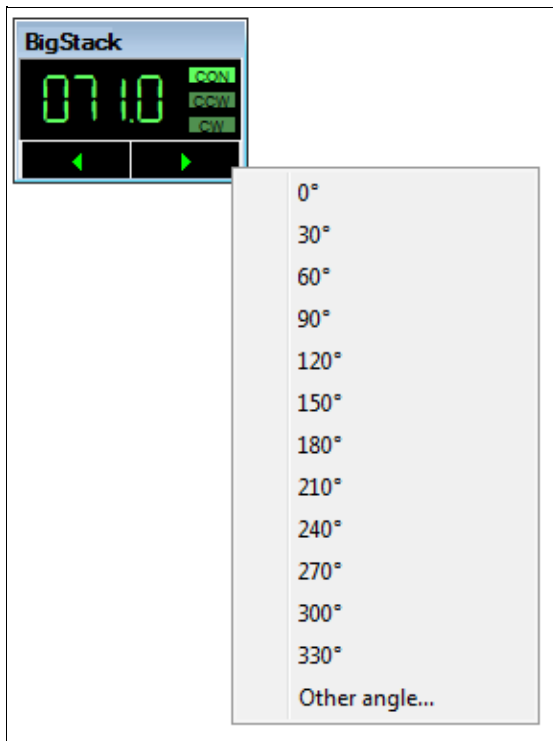

- **Rotation limits** - Click to display pop-up window where you can enter the range of values supported by this rotator. Any heading outside the range will be translated to the nearest limit. [Q: How does one specify that 170 to 190° are "out of range"? --Ed.]

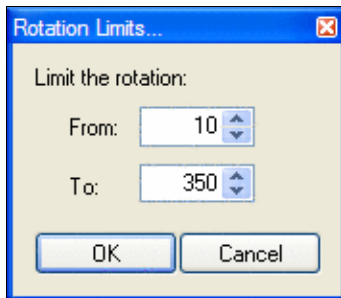

- **Antenna Name** - Choose any name for your antennas. Each antenna must have a unique name.
- **Band** - Operating band. Win-Test turns the proper rotator based on the operating band of the active radio. For multiband antennas, create several entries as shown above. Omitted bands will be ignored by this instance of wtRotators.
- **Offset** - Offset to add if the antenna is skewed from the rotator indication. Click to enter a value between 0 and 360°. For example, if you have a rotary dipole in line with the booms of your Yagis, use 90° as shown in the example. If your antenna is actually pointing at 20° when the rotator indicates 0°, enter 20. Be sure to check **Enable Offset** as shown. For "negative" offsets, like "-25°", use the equivalent value, 335°.

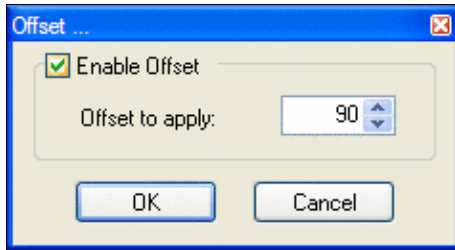

- **Heading Range** - Click to specify a range of beam heading values supported by this antenna. If the antenna is to be used for all directions, leave this column blank by unchecking **Enable a Beaming Range for that Antenna**. [Q: How to specify a range that excludes 170 to 190°? --Ed.]

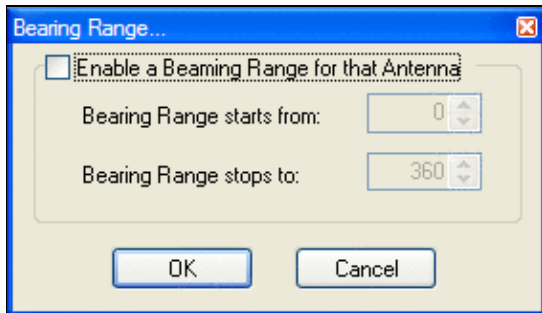

- **Bidirect** - Check this box when using a bi-directional antenna, such as a dipole. Win-Test will automatically move the rotator to the nearest usable beam heading.

Press **[OK]** to save all changes, or **[Cancel]** to start over.

## Testing the configuration

Once you have setup both Win-Test and wtRotators, it is time to verify that you can control the rotator from within Win-Test.

In Win-Test, enter either a **callsign** or a **beam heading** (0 to 360°) on the last line of the log entry window, and press **[Ctrl]+[F12]** to rotate to that heading. When entering a callsign or prefix, use **[Alt]+[F12]** for long (or "alternate") path. You can also move the cursor up to a previous QSO and press either key to rotate to the heading for that callsign. Callsign prefixes within your own country cannot be used to rotate the beam.

You should immediately see a message in the wtRotators window such as the following:

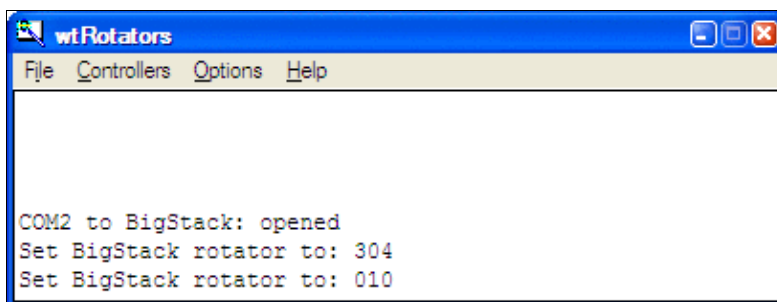

and the rotator should turn to the indicated heading.

**If you see no messages in the wtRotators window**, it means no antenna was named and defined for that band, or it means Win-Test and wtRotators are not communicating properly. Verify that both are using the same broadcast IP address and port number, and that "Disable communications with Win-Test" is *not* checked, and that your firewall is not blocking the port.

## Editing the rotator configuration

From the wtRotators menu, choose **Controllers** | **Edit** or **Controllers** | **Delete**.

## Adding additional rotators

From the wtRotators menu, choose **Controllers** | **Add** and repeat the procedure described above for each rotator that you want to support.

## Initializing rotator communications

wtRotators automatically re-initializes communications with the rotator when any change is made. If the rotator is temporarily disconnected or powered off, or if wtRotators is no longer turning the rotator even though all the normal messages are displayed, from the wtRotators menu, select **Controllers** | **Initialize** and wtRotators will reopen the specified COM port and attempt to re-establish communications with the rotator controller.

## Configuring wtRotators (multi-op environment)

The above guide covers setting up Win-Test and wtRotators in a single-op environment and thankfully the only difference between the two configurations is the networking set-up in wtRotators.

## Obtaining your network broadcast address

In order to configure wtRotators correctly, you need to know the IP broadcast address you have set in Win-Test for the network. Simply open the Configure Interfaces window in Win-Test via **Options** | **Configure interfaces...**, or just type the text command **SETUP** and press **[Enter]**. Press the **[By default]** button to have Win-Test automatically calculate the broadcast address based on your PC's current IP address.

The broadcast address is found as follows:



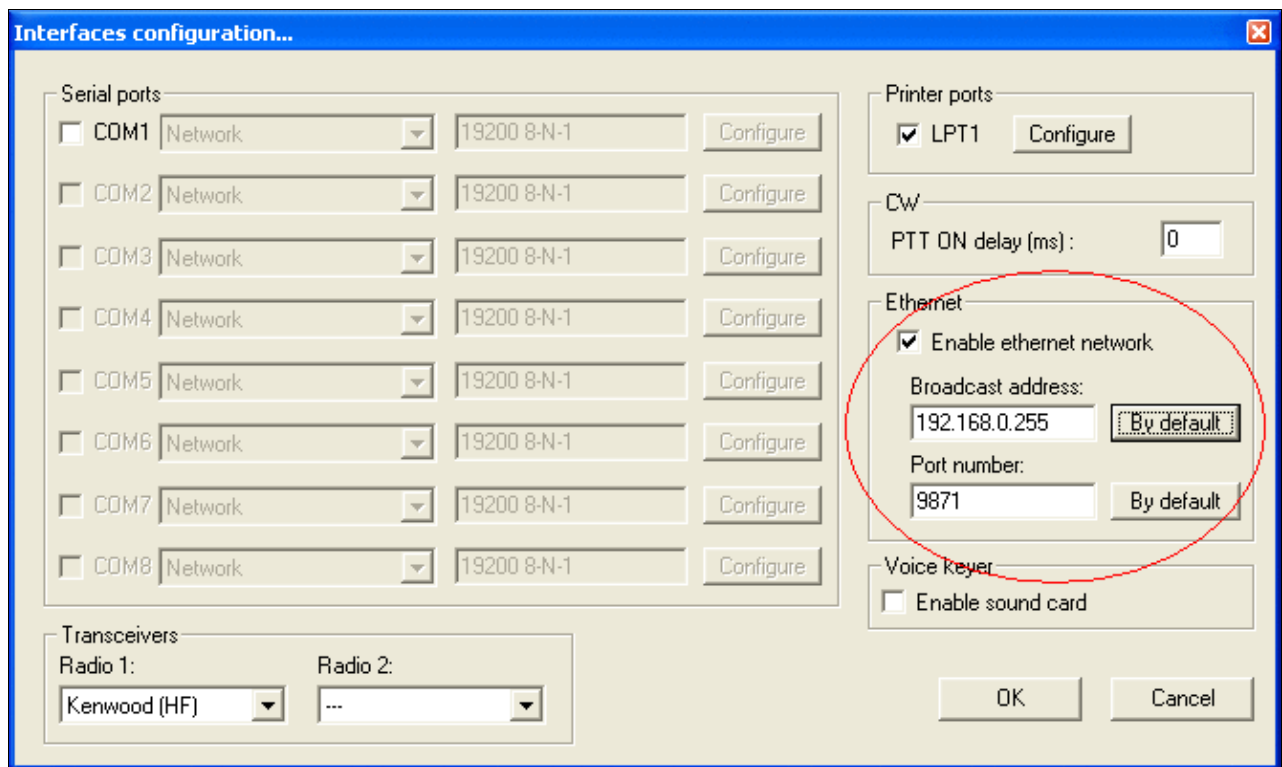

So, in this above example, the broadcast address is **192.168.0.255**. Use this same broadcast address and port number in wtRotators, in wtDxTelnet, and in all networked PCs. Just press the **[Default]** button in wtRotators, and it will calculate the same broadcast value as Win-Test, no need to write anything down.

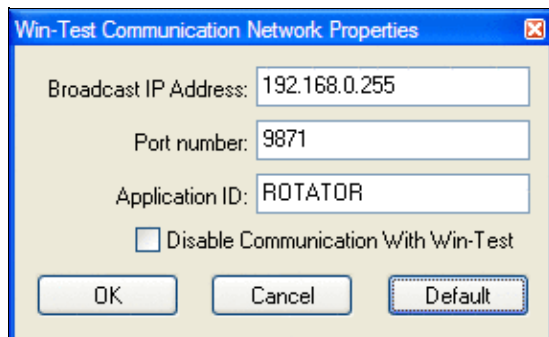

## Configuring wtRotators (multiple PCs in a network)

The advantage of wtRotators in a multi-op environment is that you only require *one* connection to a rotator control box, all networked PCs will be able to control that rotator, based on operating band.

Follow the steps above, for configuring wtRotators in a single-op environment, but the network properties will be different. Go to the **Options | Win-Test Network Properties** menu in wtRotators.

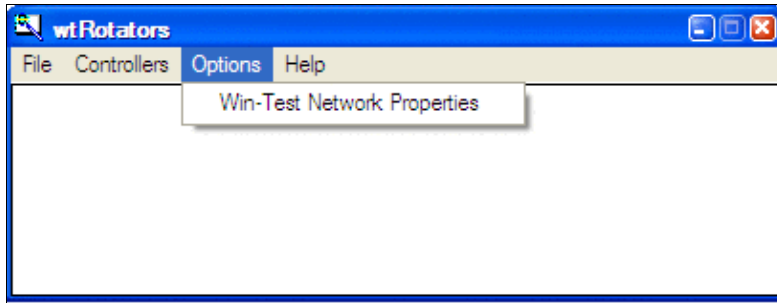

Use the following details:

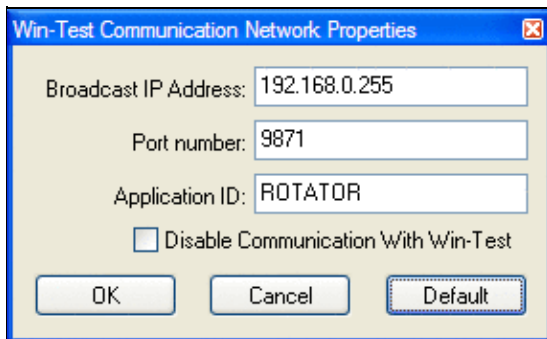

- **Broadcast IP address** - It is *very* important that you get the address absolutely correct for the rotator data to be propagated across the network. It **must** match the broadcast address which you have specified in Win-Test's network properties in the previous step. Using the example above, in this instance, the broadcast IP address would be **192 . 168 . 0 . 255**. Just press the [**Default**] button shown above, and wtRotators will calculate the same default broadcast address as Win-Test's [**By default**] button.
- **Port number** - Can usually be left as-is. Again, it must match what has been specified in Win-Test. The same port number can be used for both wtDxtelnet and wtRotators. The default port number is 9871. Use 9871 unless you have already changed the port number (and thus you should know what you're doing and thus you should know the port number).
- **Application ID** - Can also be left as **ROTATOR**.

Click [**OK**], and you have successfully configured both Win-Test and wtRotators. You should now test the configuration as described above.

## Add your rotators

Add your rotators as described above. Keep in mind that any rotator can be turned by any operator, so take care to limit the bands and beam headings covered by each rotator.

## See Also

### In the manual

- Setting up networking in a multi-op environment
- Windows | Rotators

## Namespaces

- [Page](#)
- [Discussion](#)

## Variants

## Views

- [Read](#)
- [View source](#)
- [View history](#)

## More

- This page was last edited on 30 December 2021, at 10:01.
- [Privacy policy](#)
- [About Win-Test Wiki](#)
- [Disclaimers](#)



# RTTY

From Win-Test Wiki

[Jump to navigation](#) [Jump to search](#)

Win-Test includes support for RTTY contests using the MMTTY engine.

## Contents

- [1 Downloading MMTTY](#)
- [2 Configuring received data logging on MMTTY \(optional\)](#)
- [3 Win-Test RTTY configuration](#)
  - ◆ [3.1 Open the RTTY configuration box](#)
  - ◆ [3.2 Enable MMTTY](#)
  - ◆ [3.3 Set up MMTTY PTT COM Port](#)
  - ◆ [3.4 Testing](#)
    - ◇ [3.4.1 microHAM interfaces](#)
    - ◇ [3.4.2 LPT port](#)
- [4 General usage](#)
  - ◆ [4.1 RTTY window](#)
    - ◇ [4.1.1 Context Menu](#)
    - ◇ [4.1.2 Function Keys](#)
  - ◆ [4.2 Defining messages](#)
  - ◆ [4.3 MMTTY window](#)
- [5 See also](#)

## Downloading MMTTY

**Note:** If you're already using N1MM Logger or WriteLog, you may already have this installed so it's worthwhile checking before-hand.

Win-Test uses MMTTY by JE3HHT, so the first task, before you can start operating RTTY, is to go to the [MMTTY home page](#), scroll to the **Downloads** section, download and run **MMTTY168A.exe**. For SO2R operating, you will need to install MMTTY twice, in two separate directories.

If you do *not* have a microHAM device, and you wish to use FSK instead of AFSK, be sure to download and install the [EXTFSK extension](#), which is a ZIP file named **ExtFSK106.zip** (at bottom of page). Details for setting up EXTFSK can be found at [the MM HAMSOFT site](#) provided by VE5KC, and on AA5AU's extensive [Getting Started on RTTY](#) pages.

EXTFSK is *not* recommended or needed when using most microHAM devices as your RTTY interface. See [this post](#) by W4TV.

We recommend setting up MMTTY as a standalone application first, before integrating it into Win-Test, especially if you wish to get FSK going. Although it's possible to control your radio from MMTTY, PLEASE DO NOT configure this, as it will interfere with Win-Test's rig control. Set up only RTTY decoding, RTTY keying, and PTT through the sound card and/or COM ports.

Now you are ready to set up Win-Test to launch MMTTY.

## Configuring received data logging on MMTTY (optional)

If you want to keep all sent and received RTTY characters in a text file, then you should activate logging in MMTTY, since Win-Test has no option to log all the RTTY data received.

To configure logging, start MMTTY (from the desktop, not from Win-Test!), then select **File (F) | Options of Received-log** to configure the file the information is written to, and enable timestamps. Next select **File (F) | Log Rx file (L)** to activate Logging.

Now close MMTTY and restart it to check whether the options are still set correctly. You might need to save the MMTTY options as a profile. Now check the log file. It should have more than 0 bytes and contain data like this:

```
<071113 17:07:04 MMTTY Startup>
<071113 17:07:07 TX>
TEST TEST TEST
<071113 17:07:10 RX>
DSGFIEUGSLD SFGAF G
<071113 17:07:04 MMTTY Close>
```

If all works properly, shut down MMTTY and go back to Win-Test.

**Note:** MMTTY saves are buffered, so you might not see all the data logged immediately. After you close MMTTY (or Win-Test), the file will be closed, and everything will be saved.

## Win-Test RTTY configuration

Now that you've got the engine downloaded and installed, it's time to fire up Win-Test and get things set up!

### Open the RTTY configuration box

Open a contest file for a RTTY contest. Once it has loaded, right-click on the Win-Test logging window, and select **RTTY configuration...**, or just type the text command **RTTYSETUP** in the logging window, and press [Enter].

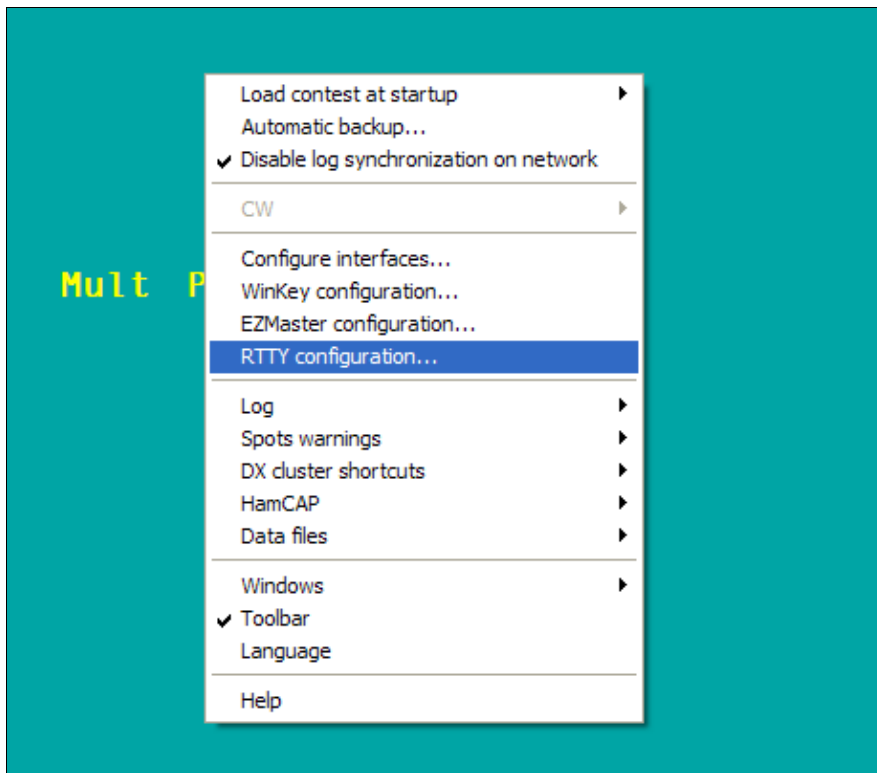

Main screen right click

## Enable MMTTY

After selecting **RTTY configuration**, you will see the dialog below:

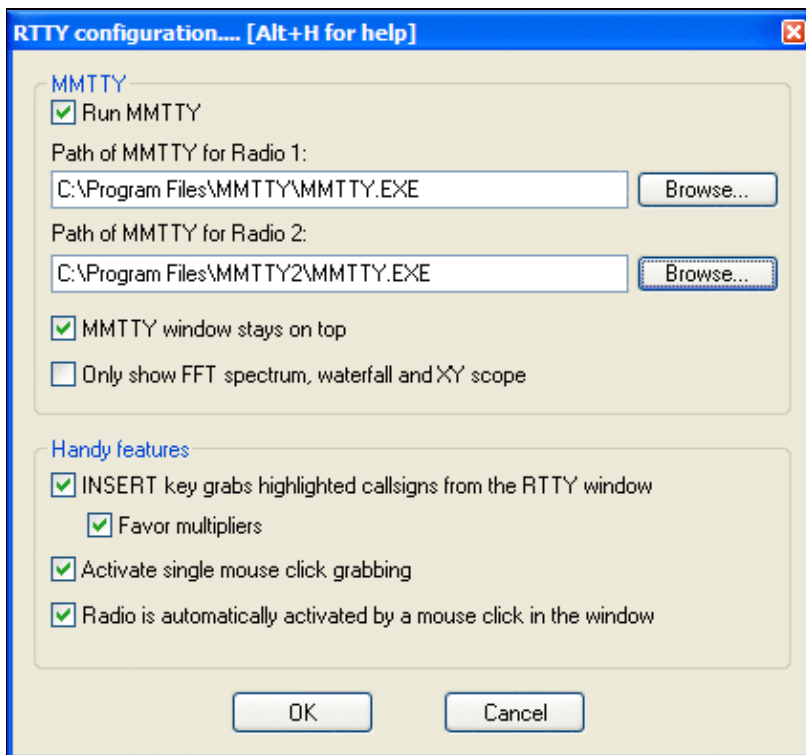

Open the RTTY configuration box

## RTTY Configuration dialog

### Run MMTTY

Check this box and add the path to the MMTTY executable file (.exe). You may use the **Browse** button to navigate to the MMTTY installation directory to highlight MMTTY.EXE, then click **Open** to select the file and fill in the text box.

**Note:** If you want to do SO2R RTTY (with two radios) you need two installations of the MMTTY engine, in separate directories, one for each radio. Add the path to the second copy of MMTTY.exe in the **Path of MMTTY for Radio 2** text box as shown above.

### MMTTY window stays on top

Enable this option to have the MMTTY window painted on top of other windows, which is helpful when tuning in RTTY signals.

### Only show FFT spectrum, waterfall and XY scope

Enable this option to display a smaller MMTTY window without a menu or the other MMTTY controls:

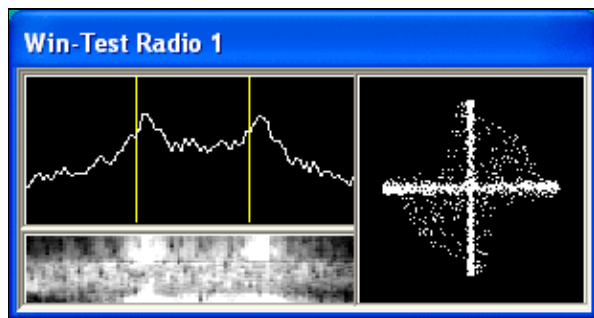

### Reduced MMTTY plugin window

#### INSERT key grabs highlighted callsigns from the RTTY window

Enable this option to load the most recent highlighted callsign into the logging window automatically when you press the [Insert] key, without having to click on it with the mouse.

#### Favor multipliers

Enable this sub-option to have the [Insert] key pick the most recent callsign that is a new multiplier, even if there are more recent highlighted callsigns (that are not new multipliers).

#### Activate single mouse click grabbing

Enable this option to use a single-left-click of the mouse, rather than a double-left-click, to load a callsign into the logging window. Note: use a **middle-click** (press down on scroll wheel) to load a callsign into the Partner window / callsign stack.

#### Radio is automatically activated by a mouse click in the window

Enable this option when using SO2R mode to switch transmitters simply by clicking on the appropriate RTTY window.

Be sure to click **OK** to exit.

If **Run MMTTY** was enabled, the MMTTY window should open automatically after you press **OK**. If you have configured MMTTY to run standalone before, everything should start to work right away.

## Set up MMTTY PTT COM Port

Win-Test and MMTTY run as two separate programs. Only one program can use a COM port at a time. You cannot tell both Win-Test and MMTTY to use the same COM port for PTT. For RTTY mode, only MMTTY should control the COM port used for PTT, not Win-Test:

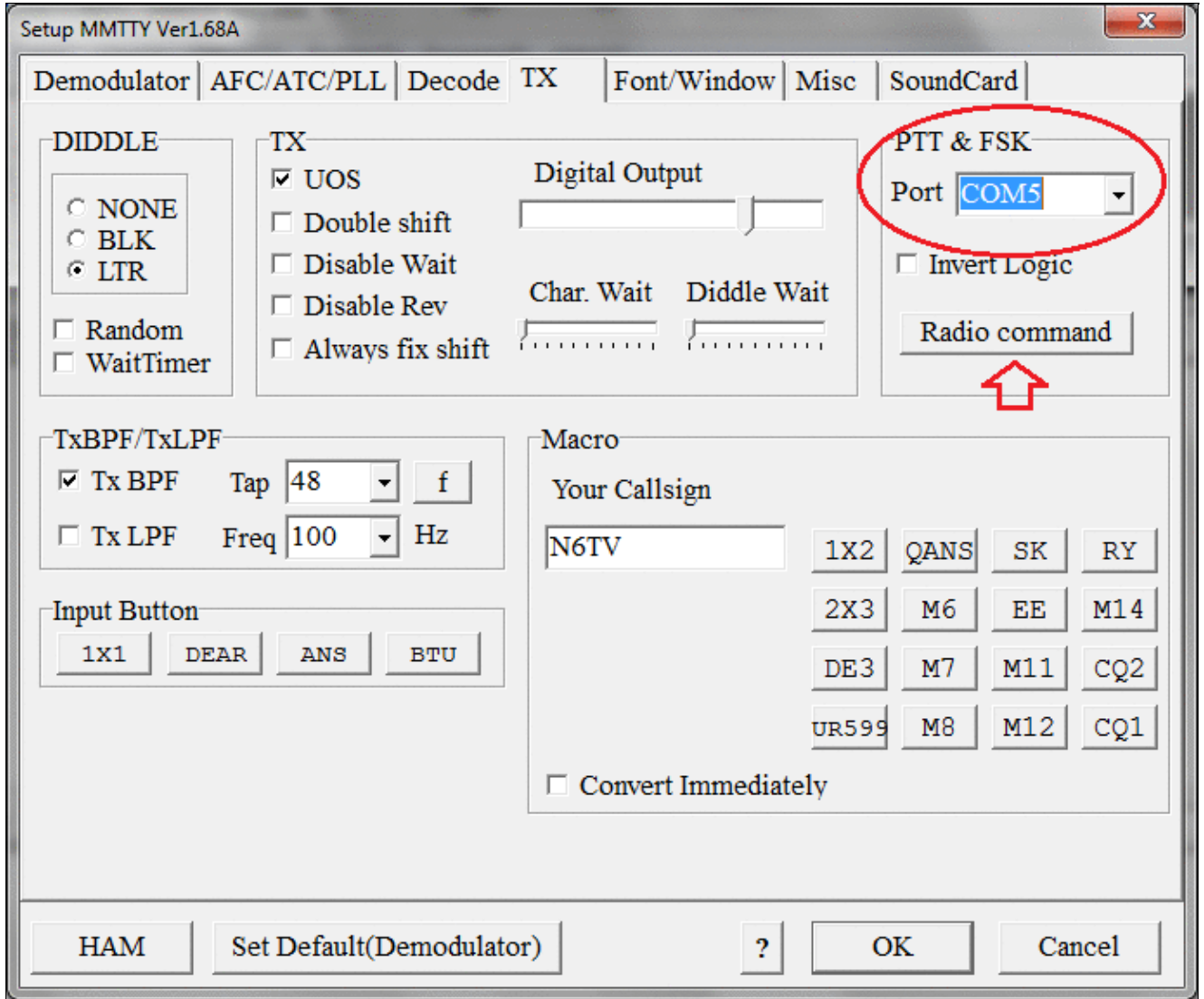



MMTTY PTT and FSK via COM port pins. Click the Radio Command button to set Radio port to NONE. Similarly, only Win-Test should control the COM port used for rig control (CAT commands), not MMTTY. Under the **TX** tab on MMTTY Setup, click the **Radio Command** button and make sure that the **Port** in that sub-dialog is set to **None**:

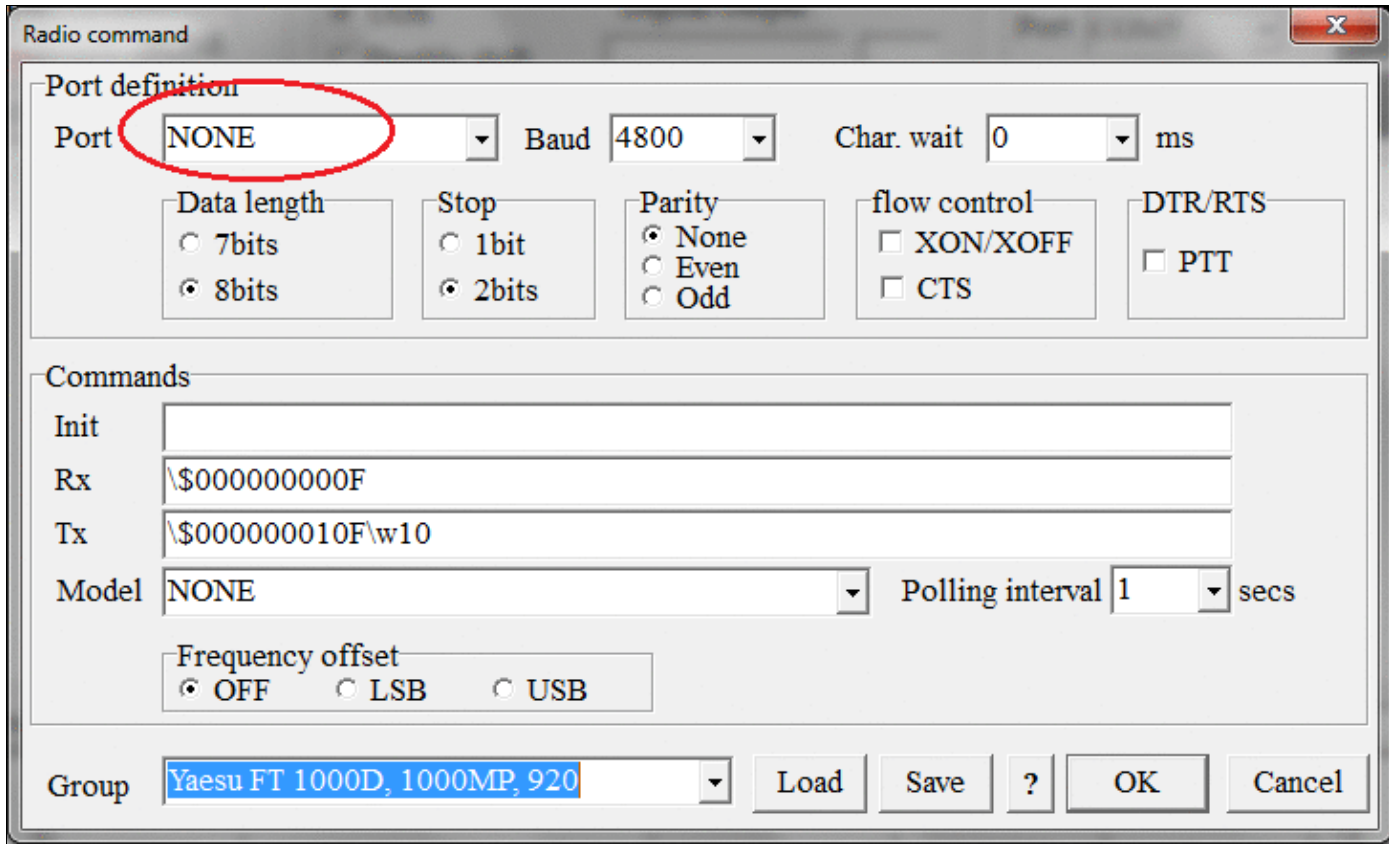

MMTTY Radio Command (CAT) port. Radio port should be set to NONE here because Win-Test needs exclusive access to this port for rig control.

## Testing

Try to receive and decode a RTTY signal. If that works, try to key the transmitter and get on the air by pressing **Alt-K** (keyboard mode), then type some text. Press **Alt-K** again to end transmissions. If you can monitor your signal, you should now hear the typical RTTY diddle.

In case you still need to set up something in MMTTY, you may do so without exiting Win-Test by clicking **Options | Setup** in the MMTTY sub-window (to access the MMTTY menu, you must first disable the **RTTYSETUP** option **Only show FFT spectrum, waterfall and XY scope** if previously enabled).

Note that you might need the EXTFSK extension for MMTTY if you are using MMTTY via an USB-to-serial adapter rather than a "real" (legacy) serial port.

### microHAM interfaces

EXTFSK is *not* recommended or needed when using most microHAM devices as your RTTY interface. See [this post](#) by W4TV.

See the [Logger Setup Guides](#) on the [microHAM Web Site](#) for detailed instructions. Click **Support, Application Notes, Logger Setup Guides**, select your device, then click **Win-Test** for a microHAM PDF document with detailed screen shots showing how to use the device with Win-Test.

For FSK, in the MMTTY **Misc** tab, set **Tx Port** to COM-TxD(FSK). Select the **USB Port** button next to this option, and select option "C" **Limiting speed**, and click **OK**. You can find this setting in the Logger Setup Guides documentation on the microHAM website.

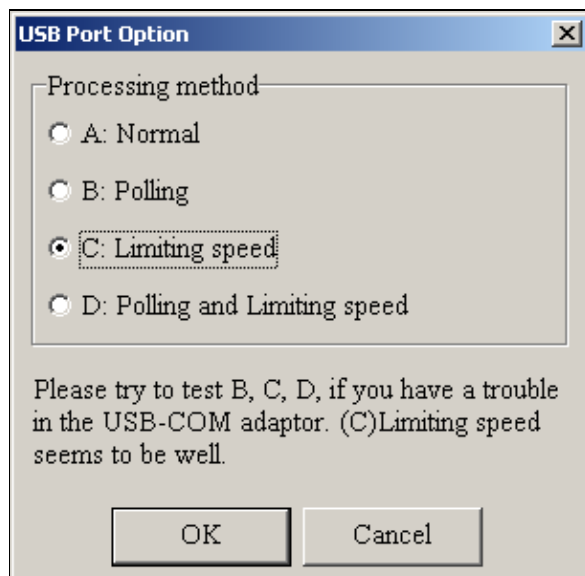

MMTTY USB Port Option - Option C is recommended

## LPT port

According to [this post by IZ4EFN](#), FSK keying is also possible through the LPT port. It involves installing and configuring **TDLPortIO.dll** as well as EXTFSK.

## General usage

Once you have everything set up, here's a basic guide to logging QSOs. Press **[F1]** or click F1 in the RTTY Window to call CQ. Press or click **[Ins]** to load the most recently highlighted callsign into the logging window and send the exchange. Press or click **[+]** to send the TU message and log the QSO. Press or click **[F7]** to send the "?" message.

## RTTY window

By default, Win-Test doesn't open the RTTY window(s) automatically. From the Win-Test menu, select **Windows | RTTY (radio 1)**. This will open the RTTY receive window for Radio 1.

If you're running SO2R RTTY, select **Windows | RTTY (radio 2)**, which will open a second RTTY receive window for Radio 2.

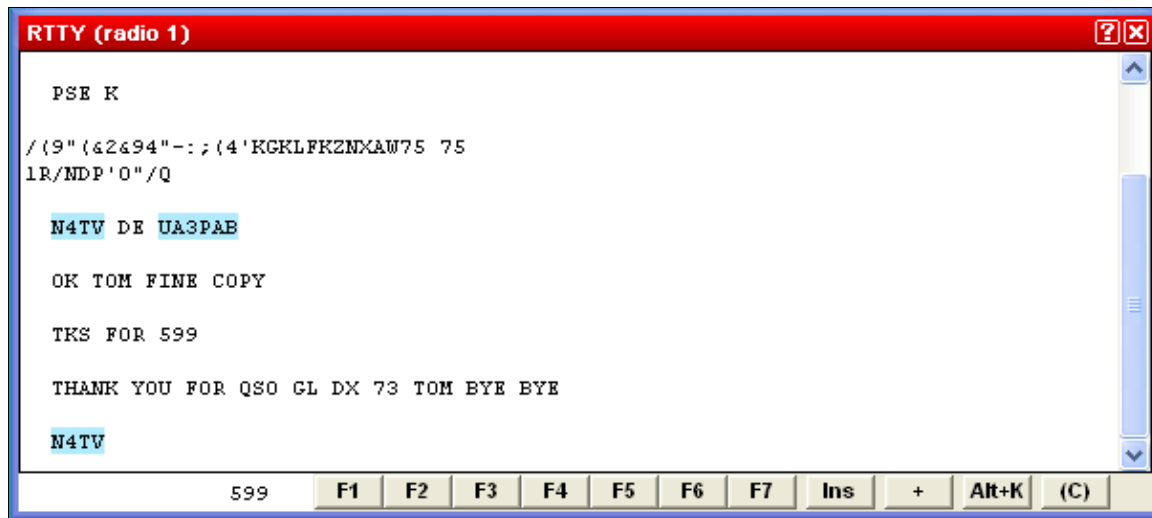

RTTY TX/RX Window. The blue highlighting of the two callsigns UA3PAB and N4TV means: these are new callsigns yet to be worked.

Highlight colors:

- Blue  
    New callsigns
- Yellow  
    New multipliers
- Green  
    New double-multipliers
- Red  
    Duplicate callsigns (dupes)

Your own transmissions will be displayed in blue text.

With the mouse cursor, you can double-click (or single-click, if the option is enabled) on a callsign, and it will be copied to the callsign entry field in the logging window. Remember that pressing [Insert] when the callsign entry field is empty will copy the most recently highlighted callsign into the callsign field. Clicking on a contest exchange will copy it into the received exchange field. **Middle-clicking** on a callsign (click on mouse wheel) will transfer the call to the Partner window / callsign stack.

### Context Menu

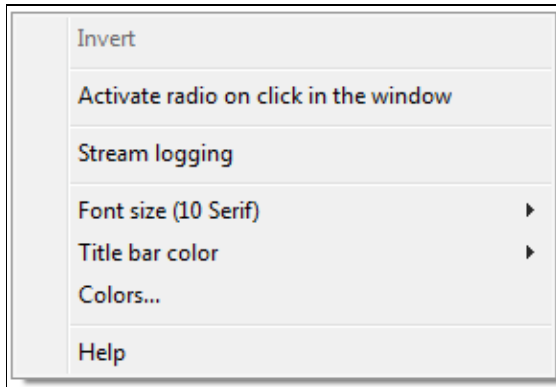

RTTY Context Menu.

Right-click of the mouse brings up a context menu, containing the **INVERT** feature. This feature allows you to invert (change from baudot characters to figures) selected text. First select the text to be inverted with the left mouse button and then hit the right mouse button and **INVERT** the text. Thus **TOO QWE** will become **599 123**.

**Stream Logging** will - when enabled - log all RTTY RX and TX traffic to an ASCII file named {filename}.ry1 for the RTTY Window 1 and {filename}.ry2 for RTTY Window 2. This is usefule for later review of potentially broken QSOs.

### Function Keys

Most of the function keys have a corresponding button at the bottom of the RTTY window which you may click with the mouse to activate instead of using the keyboard. Clicking on a function key button while holding down the [Shift] key will allows you to reprogram the contents of a message button quickly. All RTTY messages may be edited at once via **Options | RTTY | Modify standard messages ...** or the text

command shortcut **MSGS** [Enter].

Pressing the **Alt+K** button toggles in and out of keyboard mode so you can type and transmit any text real-time.

Pressing the **(C)** button clears the TX/RX window.

To scroll text in the RTTY window, drag the scroll bar with the left mouse button, or turn the mouse wheel. **[Shift] + mouse wheel** will jump to the beginning or the end of the RTTY window.

Most routine situations in RTTY contests can be handled with the mouse alone, without pressing any key.

## Defining messages

Most of the RTTY messages are already set up for you to use by default, but often you will want to change them. Use \$13 in a message to send a Carriage Return (CR). See [Message Variables](#) for a complete list.

All RTTY messages may be edited at once via **Options | RTTY | Modify standard messages ...** or the text command shortcut **MSGS** [Enter].

You can also quickly edit a single message. To do this, press **Shift-F1 . . . F7, Shift-[Insert]**, or **Shift-[+]**. Note: if you're operating in SO2R mode with **Shift Binds to Secondary Radio** enabled, you must use the **[AltGr]** (or **[Ctrl]+[Alt]**) keys instead of the **[Shift]** key to reprogram messages.



RTTY Macros

As the **++** and **--** speed accelerators used for CW do not make sense on RTTY, you should remove them.

Once you're done, click **Validate** to close the window.

Please see the [Configuring CW/RTTY messages](#) page for more details.

## MMTTY window

You may occasionally encounter a problem with the cursor disappearing or the application loses focus. To recover, minimize and restore Win-Test using the mouse.

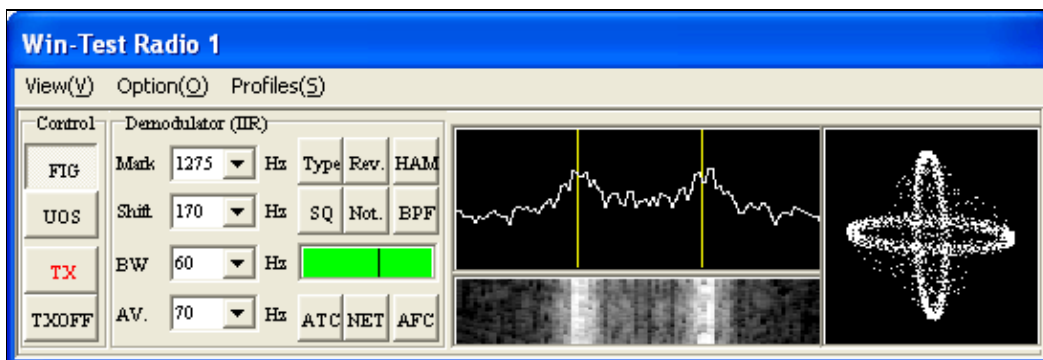

## MMTTY Window

The above screenshot is of the MMTTY window in normal mode when operating RTTY. This is when **Only show FFT spectrum, waterfall and XY scope** is disabled.

This is a minimized version of MMTTY, but it allows you to change most of the settings. For example, to enable the XY scope (the two ellipsoids) go to the **View** menu of MMTTY and tick the **XYScope** option. For the rest of the bells and whistles of MMTTY, please see the online help of that software.

## See also

- [microHAM Logger Setup Guides](#)
- [Getting Started on RTTY](#) - very detailed MMTTY set-up guide by AA5AU
- [Getting ready for a RTTY Contest](#)
- [Setting up an Kenwood TS-850S with the microHAM microKeyer](#)
- [RTTY Contesting.com](#): Great tutorials on how to use MMTTY.

## Namespaces

- [Page](#)
- [Discussion](#)

## Variants

## Views

- [Read](#)
- [View source](#)
- [View history](#)

## More

- This page was last edited on 30 December 2021, at 10:23.

- [Privacy policy](#)
- [About Win-Test Wiki](#)
- [Disclaimers](#)



# RTTY

From Win-Test Wiki

[Jump to navigation](#) [Jump to search](#)

Win-Test includes support for RTTY contests using the MMTTY engine.

## Contents

- [1 Downloading MMTTY](#)
- [2 Configuring received data logging on MMTTY \(optional\)](#)
- [3 Win-Test RTTY configuration](#)
  - ◆ [3.1 Open the RTTY configuration box](#)
  - ◆ [3.2 Enable MMTTY](#)
  - ◆ [3.3 Set up MMTTY PTT COM Port](#)
  - ◆ [3.4 Testing](#)
    - ◇ [3.4.1 microHAM interfaces](#)
    - ◇ [3.4.2 LPT port](#)
- [4 General usage](#)
  - ◆ [4.1 RTTY window](#)
    - ◇ [4.1.1 Context Menu](#)
    - ◇ [4.1.2 Function Keys](#)
  - ◆ [4.2 Defining messages](#)
  - ◆ [4.3 MMTTY window](#)
- [5 See also](#)

## Downloading MMTTY

**Note:** If you're already using N1MM Logger or WriteLog, you may already have this installed so it's worthwhile checking before-hand.

Win-Test uses MMTTY by JE3HHT, so the first task, before you can start operating RTTY, is to go to the [MMTTY home page](#), scroll to the **Downloads** section, download and run **MMTTY168A.exe**. For SO2R operating, you will need to install MMTTY twice, in two separate directories.

If you do *not* have a microHAM device, and you wish to use FSK instead of AFSK, be sure to download and install the [EXTFSK extension](#), which is a ZIP file named **ExtFSK106.zip** (at bottom of page). Details for setting up EXTFSK can be found at [the MM HAMSOFT site](#) provided by VE5KC, and on AA5AU's extensive [Getting Started on RTTY](#) pages.

EXTFSK is *not* recommended or needed when using most microHAM devices as your RTTY interface. See [this post](#) by W4TV.

We recommend setting up MMTTY as a standalone application first, before integrating it into Win-Test, especially if you wish to get FSK going. Although it's possible to control your radio from MMTTY, PLEASE DO NOT configure this, as it will interfere with Win-Test's rig control. Set up only RTTY decoding, RTTY keying, and PTT through the sound card and/or COM ports.

Now you are ready to set up Win-Test to launch MMTTY.

## Configuring received data logging on MMTTY (optional)

If you want to keep all sent and received RTTY characters in a text file, then you should activate logging in MMTTY, since Win-Test has no option to log all the RTTY data received.

To configure logging, start MMTTY (from the desktop, not from Win-Test!), then select **File (F) | Options of Received-log** to configure the file the information is written to, and enable timestamps. Next select **File (F) | Log Rx file (L)** to activate Logging.

Now close MMTTY and restart it to check whether the options are still set correctly. You might need to save the MMTTY options as a profile. Now check the log file. It should have more than 0 bytes and contain data like this:

```
<071113 17:07:04 MMTTY Startup>
<071113 17:07:07 TX>
TEST TEST TEST
<071113 17:07:10 RX>
DSGFIEUGSLD SFGAF G
<071113 17:07:04 MMTTY Close>
```

If all works properly, shut down MMTTY and go back to Win-Test.

**Note:** MMTTY saves are buffered, so you might not see all the data logged immediately. After you close MMTTY (or Win-Test), the file will be closed, and everything will be saved.

## Win-Test RTTY configuration

Now that you've got the engine downloaded and installed, it's time to fire up Win-Test and get things set up!

### Open the RTTY configuration box

Open a contest file for a RTTY contest. Once it has loaded, right-click on the Win-Test logging window, and select **RTTY configuration...**, or just type the text command **RTTYSETUP** in the logging window, and press [Enter].



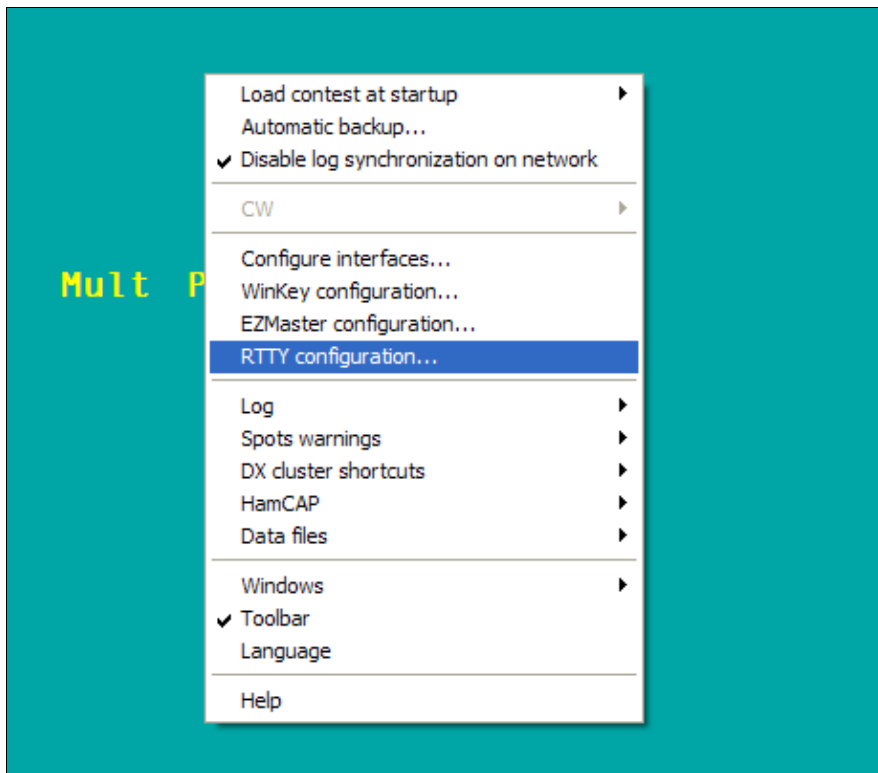

Main screen right click

## Enable MMTTY

After selecting **RTTY configuration**, you will see the dialog below:

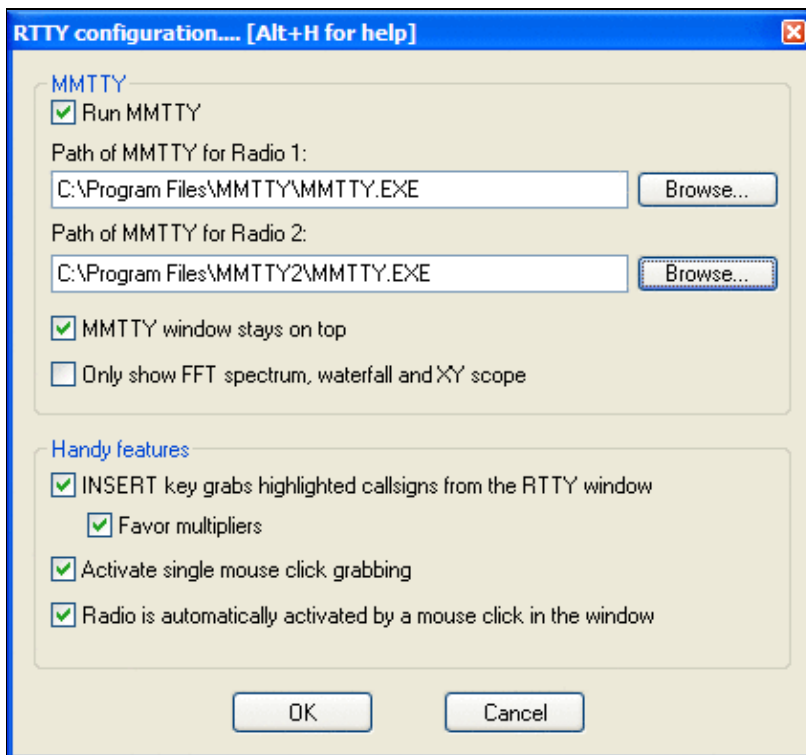

Open the RTTY configuration box

## RTTY Configuration dialog

### Run MMTTY

Check this box and add the path to the MMTTY executable file (.exe). You may use the **Browse** button to navigate to the MMTTY installation directory to highlight MMTTY.EXE, then click **Open** to select the file and fill in the text box.

**Note:** If you want to do SO2R RTTY (with two radios) you need two installations of the MMTTY engine, in separate directories, one for each radio. Add the path to the second copy of MMTTY.exe in the **Path of MMTTY for Radio 2** text box as shown above.

### MMTTY window stays on top

Enable this option to have the MMTTY window painted on top of other windows, which is helpful when tuning in RTTY signals.

### Only show FFT spectrum, waterfall and XY scope

Enable this option to display a smaller MMTTY window without a menu or the other MMTTY controls:

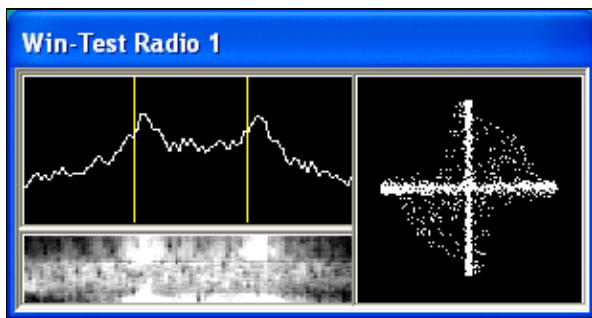

### Reduced MMTTY plugin window

#### INSERT key grabs highlighted callsigns from the RTTY window

Enable this option to load the most recent highlighted callsign into the logging window automatically when you press the [Insert] key, without having to click on it with the mouse.

#### Favor multipliers

Enable this sub-option to have the [Insert] key pick the most recent callsign that is a new multiplier, even if there are more recent highlighted callsigns (that are not new multipliers).

#### Activate single mouse click grabbing

Enable this option to use a single-left-click of the mouse, rather than a double-left-click, to load a callsign into the logging window. Note: use a **middle-click** (press down on scroll wheel) to load a callsign into the Partner window / callsign stack.

#### Radio is automatically activated by a mouse click in the window

Enable this option when using SO2R mode to switch transmitters simply by clicking on the appropriate RTTY window.

Be sure to click **OK** to exit.

If **Run MMTTY** was enabled, the MMTTY window should open automatically after you press **OK**. If you have configured MMTTY to run standalone before, everything should start to work right away.

## Set up MMTTY PTT COM Port

Win-Test and MMTTY run as two separate programs. Only one program can use a COM port at a time. You cannot tell both Win-Test and MMTTY to use the same COM port for PTT. For RTTY mode, only MMTTY should control the COM port used for PTT, not Win-Test:

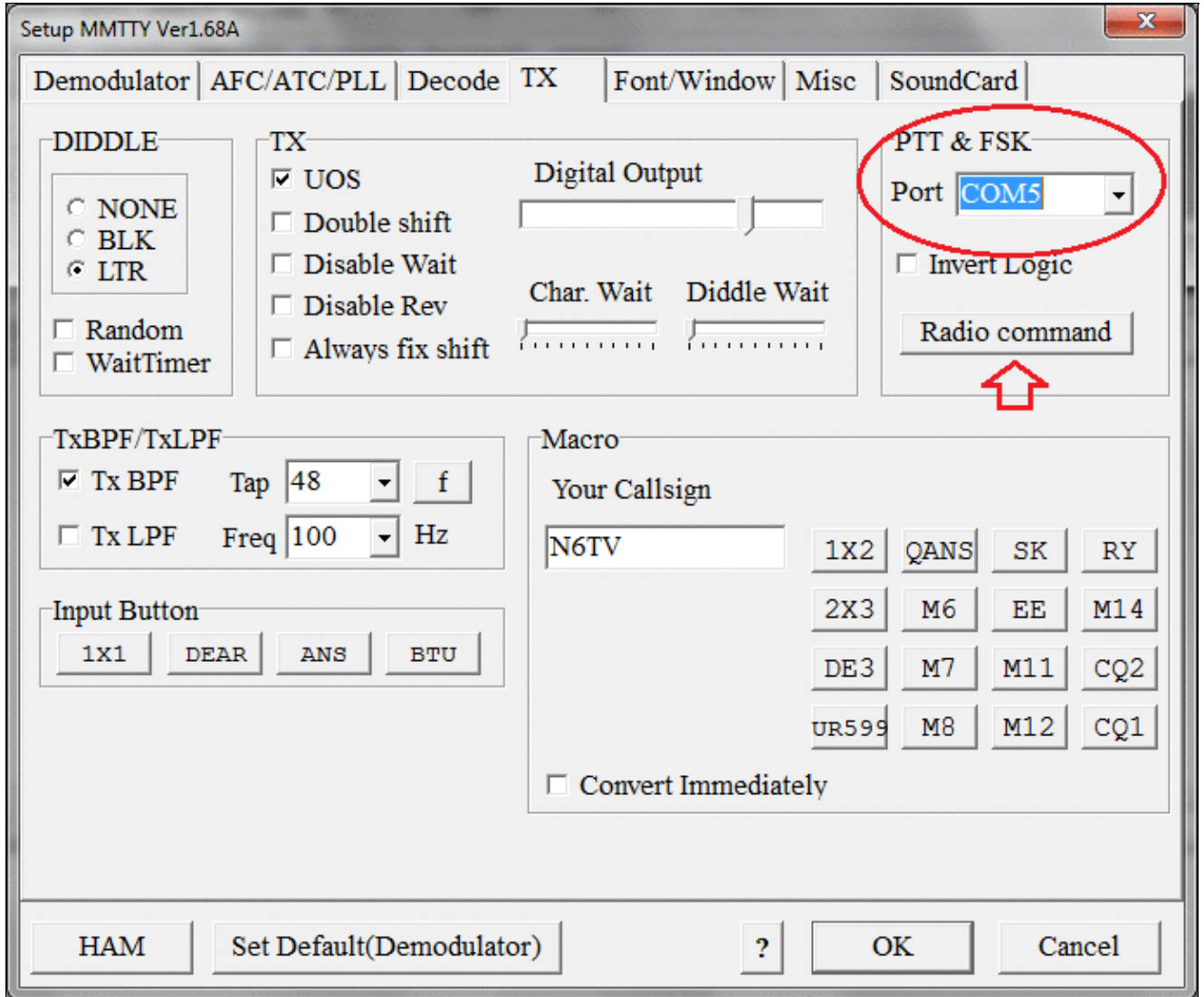

MMTTY PTT and FSK via COM port pins. Click the Radio Command button to set Radio port to NONE. Similarly, only Win-Test should control the COM port used for rig control (CAT commands), not MMTTY. Under the **TX** tab on MMTTY Setup, click the **Radio Command** button and make sure that the **Port** in that sub-dialog is set to **None**:

Radio command

Port definition

Port **NONE** Baud 4800 Char. wait 0 ms

Data length  
 7bits  
 8bits

Stop  
 1bit  
 2bits

Parity  
 None  
 Even  
 Odd

flow control  
 XON/XOFF  
 CTS

DTR/RTS  
 PTT

Commands

Init

Rx \ \$000000000F

Tx \ \$000000010F\w10

Model NONE Polling interval 1 secs

Frequency offset  
 OFF  LSB  USB

Group Yaesu FT 1000D, 1000MP, 920 Load Save ? OK Cancel

MMTTY Radio Command (CAT) port. Radio port should be set to NONE here because Win-Test needs exclusive access to this port for rig control.

## Testing

Try to receive and decode a RTTY signal. If that works, try to key the transmitter and get on the air by pressing **Alt-K** (keyboard mode), then type some text. Press **Alt-K** again to end transmissions. If you can monitor your signal, you should now hear the typical RTTY diddle.

In case you still need to set up something in MMTTY, you may do so without exiting Win-Test by clicking **Options | Setup** in the MMTTY sub-window (to access the MMTTY menu, you must first disable the **RTTYSETUP** option **Only show FFT spectrum, waterfall and XY scope** if previously enabled).

Note that you might need the EXTFSK extension for MMTTY if you are using MMTTY via an USB-to-serial adapter rather than a "real" (legacy) serial port.

### microHAM interfaces

EXTFSK is *not* recommended or needed when using most microHAM devices as your RTTY interface. See [this post](#) by W4TV.

See the [Logger Setup Guides](#) on the [microHAM Web Site](#) for detailed instructions. Click **Support, Application Notes, Logger Setup Guides**, select your device, then click **Win-Test** for a microHAM PDF document with detailed screen shots showing how to use the device with Win-Test.

For FSK, in the MMTTY **Misc** tab, set **Tx Port** to COM-TxD(FSK). Select the **USB Port** button next to this option, and select option "C" **Limiting speed**, and click **OK**. You can find this setting in the Logger Setup Guides documentation on the microHAM website.

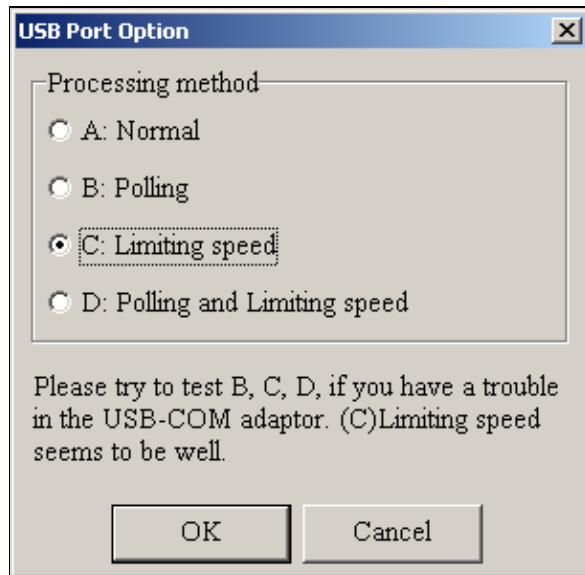

MMTTY USB Port Option - Option C is recommended

## LPT port

According to [this post by IZ4EFN](#), FSK keying is also possible through the LPT port. It involves installing and configuring **TDLPortIO.dll** as well as EXTFSK.

## General usage

Once you have everything set up, here's a basic guide to logging QSOs. Press **[F1]** or click F1 in the RTTY Window to call CQ. Press or click **[Ins]** to load the most recently highlighted callsign into the logging window and send the exchange. Press or click **[+]** to send the TU message and log the QSO. Press or click **[F7]** to send the "?" message.

## RTTY window

By default, Win-Test doesn't open the RTTY window(s) automatically. From the Win-Test menu, select **Windows | RTTY (radio 1)**. This will open the RTTY receive window for Radio 1.

If you're running SO2R RTTY, select **Windows | RTTY (radio 2)**, which will open a second RTTY receive window for Radio 2.

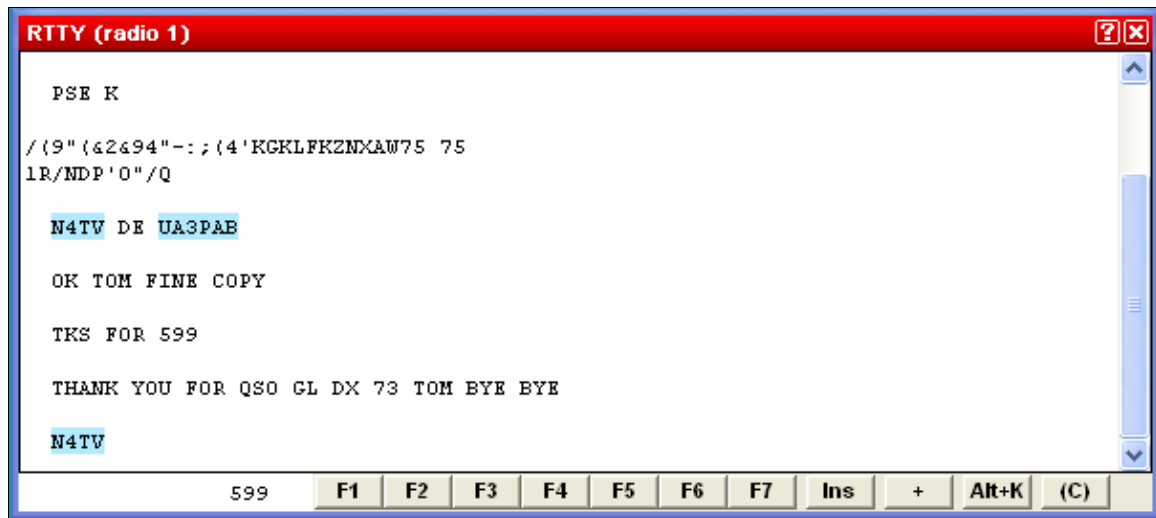

RTTY TX/RX Window. The blue highlighting of the two callsigns UA3PAB and N4TV means: these are new callsigns yet to be worked.

Highlight colors:

- Blue  
    New callsigns
- Yellow  
    New multipliers
- Green  
    New double-multipliers
- Red  
    Duplicate callsigns (dupes)

Your own transmissions will be displayed in blue text.

With the mouse cursor, you can double-click (or single-click, if the option is enabled) on a callsign, and it will be copied to the callsign entry field in the logging window. Remember that pressing [Insert] when the callsign entry field is empty will copy the most recently highlighted callsign into the callsign field. Clicking on a contest exchange will copy it into the received exchange field. **Middle-clicking** on a callsign (click on mouse wheel) will transfer the call to the Partner window / callsign stack.

### Context Menu

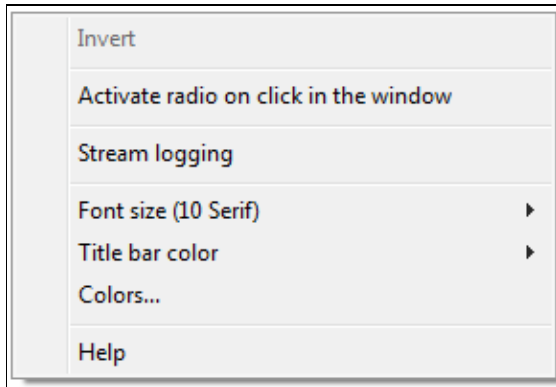

RTTY Context Menu.

Right-click of the mouse brings up a context menu, containing the **INVERT** feature. This feature allows you to invert (change from baudot characters to figures) selected text. First select the text to be inverted with the left mouse button and then hit the right mouse button and **INVERT** the text. Thus **TOO QWE** will become **599 123**.

**Stream Logging** will - when enabled - log all RTTY RX and TX traffic to an ASCII file named {filename}.ry1 for the RTTY Window 1 and {filename}.ry2 for RTTY Window 2. This is usefule for later review of potentially broken QSOs.

### Function Keys

Most of the function keys have a corresponding button at the bottom of the RTTY window which you may click with the mouse to activate instead of using the keyboard. Clicking on a function key button while holding down the [Shift] key will allows you to reprogram the contents of a message button quickly. All RTTY messages may be edited at once via **Options | RTTY | Modify standard messages ...** or the text

command shortcut **MSGS** [Enter].

Pressing the **Alt+K** button toggles in and out of keyboard mode so you can type and transmit any text real-time.

Pressing the **(C)** button clears the TX/RX window.

To scroll text in the RTTY window, drag the scroll bar with the left mouse button, or turn the mouse wheel. **[Shift] + mouse wheel** will jump to the beginning or the end of the RTTY window.

Most routine situations in RTTY contests can be handled with the mouse alone, without pressing any key.

## Defining messages

Most of the RTTY messages are already set up for you to use by default, but often you will want to change them. Use \$13 in a message to send a Carriage Return (CR). See [Message Variables](#) for a complete list.

All RTTY messages may be edited at once via **Options | RTTY | Modify standard messages ...** or the text command shortcut **MSGS** [Enter].

You can also quickly edit a single message. To do this, press **Shift-F1 . . F7, Shift-[Insert]**, or **Shift-[+]**. Note: if you're operating in SO2R mode with **Shift Binds to Secondary Radio** enabled, you must use the **[AltGr]** (or **[Ctrl]+[Alt]**) keys instead of the **[Shift]** key to reprogram messages.



RTTY Macros

As the **++** and **--** speed accelerators used for CW do not make sense on RTTY, you should remove them.

Once you're done, click **Validate** to close the window.

Please see the [Configuring CW/RTTY messages](#) page for more details.

## MMTTY window

You may occasionally encounter a problem with the cursor disappearing or the application loses focus. To recover, minimize and restore Win-Test using the mouse.

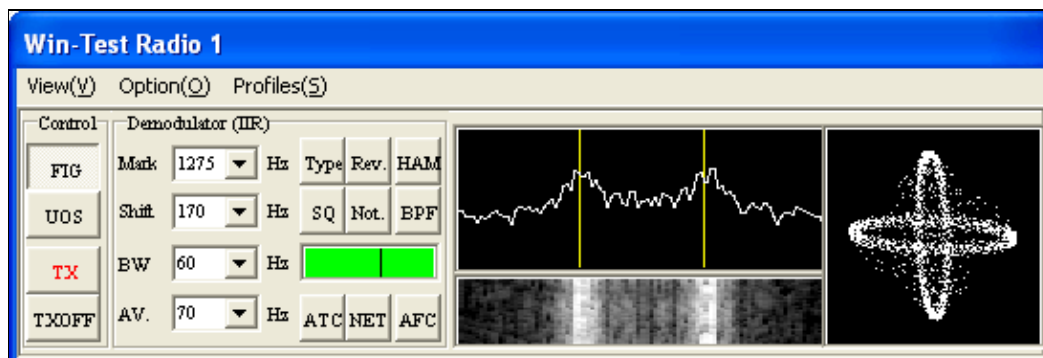



## MMTTY Window

The above screenshot is of the MMTTY window in normal mode when operating RTTY. This is when **Only show FFT spectrum, waterfall and XY scope** is disabled.

This is a minimized version of MMTTY, but it allows you to change most of the settings. For example, to enable the XY scope (the two ellipsoids) go to the **View** menu of MMTTY and tick the **XYScope** option. For the rest of the bells and whistles of MMTTY, please see the online help of that software.

## See also

- [microHAM Logger Setup Guides](#)
- [Getting Started on RTTY](#) - very detailed MMTTY set-up guide by AA5AU
- [Getting ready for a RTTY Contest](#)
- [Setting up an Kenwood TS-850S with the microHAM microKeyer](#)
- [RTTY Contesting.com](#): Great tutorials on how to use MMTTY.

## Namespaces

- [Page](#)
- [Discussion](#)

## Variants

## Views

- [Read](#)
- [View source](#)
- [View history](#)

## More

- This page was last edited on 30 December 2021, at 10:23.

- [Privacy policy](#)
- [About Win-Test Wiki](#)
- [Disclaimers](#)



# Running a contest

From Win-Test Wiki

[Jump to navigation](#) [Jump to search](#)

## Contents

- [1 Logging QSOs](#)
- [2 SO1R specifics](#)
- [3 SO2R specifics](#)
- [4 Multi-op contesting](#)
  - ◆ [4.1 Possible issues](#)
- [5 Contest specific behaviour](#)
- [6 Posting live score on-line](#)
- [7 Post-contest specifics](#)

## Logging QSOs

- [Programming messages](#)
- [Using the log entry window](#)

## SO1R specifics

- [Automated CW generation, RTTY messages and voice keyers](#)
- [Radio Control](#)
- [Use of Cluster spots](#)
- [Taking advantage of the Band Map feature](#)

## SO2R specifics

- [Learning the second radio window](#)
- [Using the 'shift binds second radio' option](#)  
*This feature changes some key assignments in Win-Test*
- [Using the 'caps lock binds to secondary radio' option](#)
- [Using 'advanced SO2R' mode and setting up scenarios](#)
- Win-Test and the SO2R external devices
  - ◆ [Setting up the EZMaster for use with Win-Test](#)
  - ◆ [Setting up the MK2R for use with Win-Test](#)

## Multi-op contesting

- [Setting up station names and time synchronization](#)
- [Using multi-op text commands](#) to designate RUN/MULT, RUN1/RUN2, etc.
- [Using move in my log only](#) to edit QSOs
- [Passing multipliers between stations](#)
- [Understanding the status window](#)
- [If you need to delete a QSO during the contest - DO NOT](#) use the 'delete QSO' feature
- [Clearing all logs before the start](#)

## Possible issues

- [Sequential serial numbers between stations shared between both stations](#)
- [Editing the sequential serial numbering](#)
- [QSOs made by the Mult stations which are not multipliers](#)

## Contest specific behaviour

- Some notes about [contest specific keys and parameters](#), e.g. for [WAEDC](#)

## Posting live score on-line

- In order to post live score on-line to [getscores.org](#) you will need a third party software. Instructions and software to download can be found on the [www.5b4wn.com](#) web site.

## Post-contest specifics

And finally, articles related to Win-Test and post-contest tasks:

- [Extracting log Information](#)
- [Merging](#) logs before exportation (see: [Menu:File\\_new Merge Logs](#) chapter)
- [Cleaning](#) the log (see: [Menu:File\\_new Clean log](#) chapter)
- [Creating](#) the Cabrillo, Reg1Test or ADIF exports
- [Mailing](#) the Cabrillo or Reg1Test log to the contest sponsor

## Namespaces

- [Page](#)
- [Discussion](#)

## Variants

## Views

- [Read](#)
- [View source](#)
- [View history](#)

## More

- This page was last edited on 9 December 2016, at 23:43.

- [Privacy policy](#)
- [About Win-Test Wiki](#)
- [Disclaimers](#)



# running on Linux

From Win-Test Wiki

[Jump to navigation](#) [Jump to search](#)

## Contents

- [1 Introduction](#)
- [2 Installation](#)
- [3 Interfaces](#)
  - ◆ [3.1 Serial and printer ports](#)
    - ◇ [3.1.1 Serial and printer port configuration](#)
    - ◇ [3.1.2 Network](#)
    - ◇ [3.1.3 Packet Radio TNC](#)
    - ◇ [3.1.4 Radio 1/2](#)
    - ◇ [3.1.5 W5XD Multi-Keyer](#)
    - ◇ [3.1.6 WinKey](#)
    - ◇ [3.1.7 EZMaster](#)
    - ◇ [3.1.8 MicroHam MK2R](#)
    - ◇ [3.1.9 AlphaAmp Radio 1/2](#)
  - ◆ [3.2 Transceivers](#)
- [4 Version summary](#)
- [5 Known bugs](#)
- [6 Links](#)

## Introduction

With the Windows emulator *wine* Win-Test runs also on Linux-machines. This article describes installation, which features work and which not.

The screenshot displays the Win-Test software interface with the following components:

- Check partial result:** Shows [UNIQUE] for both R and R+1.
- Check multipliers:**
  - 160
  - 80
  - 511 40 08:55 SN0FWQ 599226
  - 20
  - 15
  - 10
  - SP: Poland 09551
  - Az: 54° Lp: 234° SR: 0225z SS: 1840z
  - 08:56:20 DL5RMH JN68BN SR 0318z SS 1859z
- Radio 1:** Shows VFO A at 70235 and VFO B at 70175. A list of frequencies and call signs is visible, including 7002.5, 7006.9, 7009.2, 7011.7, 7013.2, and 7022.5.
- Rate:**
  - All bands - All modes: 56 Q/h
  - Last hour: 108 Q/h
  - 10 last QSO: 9 Q/h
  - 100 last QSO: 56 QSO
  - Since 0800z: - 15 last minutes -
  - Moving graph computed on 15 mins
  - Continents distribution: EU, NA, SA, AF, AS, OC
  - Elapsed time since the last QSO: 39 Sec
  - Time ON: 11 H 01 Mn
  - Time OFF: 9 H 15 Mn
  - Last bands changes: Radio 1: 32 Mn, Radio 2: -
  - All bands - All modes: Time by mult: 4 Mn 03 Sec
  - 1 QSO counts: 501 Pts
  - 1 mult counts: 856 Pts
  - 1 mult worth: 1.7 QSO
  - CW 32 WPM
- Summary:**

BAND	QSO	DUP	PFX	POINTS	AVG
160	0	0	0	0	0.00
80	71	0	35	153	2.15
40	146	0	78	306	2.10
20	137	1	101	183	1.34
15	82	0	48	128	1.56
10	74	0	37	86	1.16
<b>TOTAL</b>	<b>510</b>	<b>1</b>	<b>299</b>	<b>856</b>	<b>1.68</b>
- QSO Log:**

QSO	Bd	Time	Call sign	Sent N°	Rcvd	Mult	PtsStn
503	40	08:50	OE3JAG	599 503	599 135	OE3	2 R
504	40	08:51	OZ8KD	599 504	599 501		2 R
505	40	08:52	ES1CW	599 505	599 418		2 R
506	40	08:52	DL9NEI	599 506	599 187		1 R
507	40	08:53	OK2KR	599 507	599 453		2 R
508	40	08:53	DK7JZ	599 508	599 011	DK7	1 R
509	40	08:54	DJ4BA	599 509	599 014		1 R
510	40	08:55	SP9KRT	599 510	599 655		2 R
511	40	08:55	SN0FWQ	599 511	599 226	SN0	2 R
512	40	-	-	599 512	599		0 R

# Installation

## Interfaces

### Serial and printer ports

#### Serial and printer port configuration

Serial (and also printer) ports in wine are configured with Symlinks. Each DOS-device (com1, com2, ... lpt1, lpt2) is represented as a symlink to the device in linux.

To make the symlinks like they are shown in the example image, you have to type:

```
ln -s /dev/ttyUSB0 com1
ln -s /dev/ttyUSB1 com2
ln -s /dev/lp0 lpt1
```

in the `.wine/dosdevices` directoy in your home directory. Of course you have to type your own configuration.

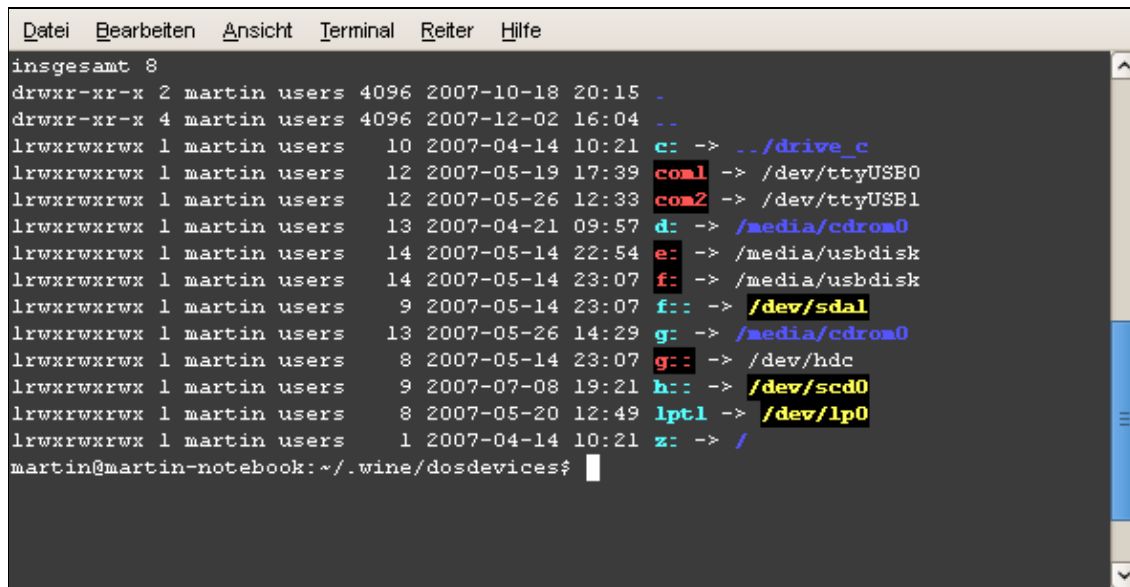

```

Datei Bearbeiten Ansicht Terminal Reiter Hilfe
insgesamt 8
drwxr-xr-x 2 martin users 4096 2007-10-18 20:15 .
drwxr-xr-x 4 martin users 4096 2007-12-02 16:04 ..
lrwxrwxrwx 1 martin users 10 2007-04-14 10:21 c: -> ../drive_c
lrwxrwxrwx 1 martin users 12 2007-05-19 17:39 com1 -> /dev/ttyUSB0
lrwxrwxrwx 1 martin users 12 2007-05-26 12:33 com2 -> /dev/ttyUSB1
lrwxrwxrwx 1 martin users 13 2007-04-21 09:57 d: -> /media/cdrom0
lrwxrwxrwx 1 martin users 14 2007-05-14 22:54 e: -> /media/usbdisk
lrwxrwxrwx 1 martin users 14 2007-05-14 23:07 f: -> /media/usbdisk
lrwxrwxrwx 1 martin users 9 2007-05-14 23:07 f:: -> /dev/sda1
lrwxrwxrwx 1 martin users 13 2007-05-26 14:29 g: -> /media/cdrom0
lrwxrwxrwx 1 martin users 8 2007-05-14 23:07 g:: -> /dev/hdc
lrwxrwxrwx 1 martin users 9 2007-07-08 19:21 h:: -> /dev/scd0
lrwxrwxrwx 1 martin users 8 2007-05-20 12:49 lpt1 -> /dev/lp0
lrwxrwxrwx 1 martin users 1 2007-04-14 10:21 z: -> /
martin@martin-notebook: ~/.wine/dosdevices$

```

Tip: If you use USB-serial-adaptors, take a look at /var/log/syslog while or after you connected the device (Debian/ubuntu). The log will show you where got device is connected (e.g. /dev/ttyUSB0 -> first serial port running via USB).

You can use the definition direct in your Win-Test.

Reference: [Wine HQ documentation: Serial and Parallel Ports](#)

## Network

### Packet Radio TNC

### Radio 1/2

### W5XD Multi-Keyer

### WinKey

Working stable with following configuration:

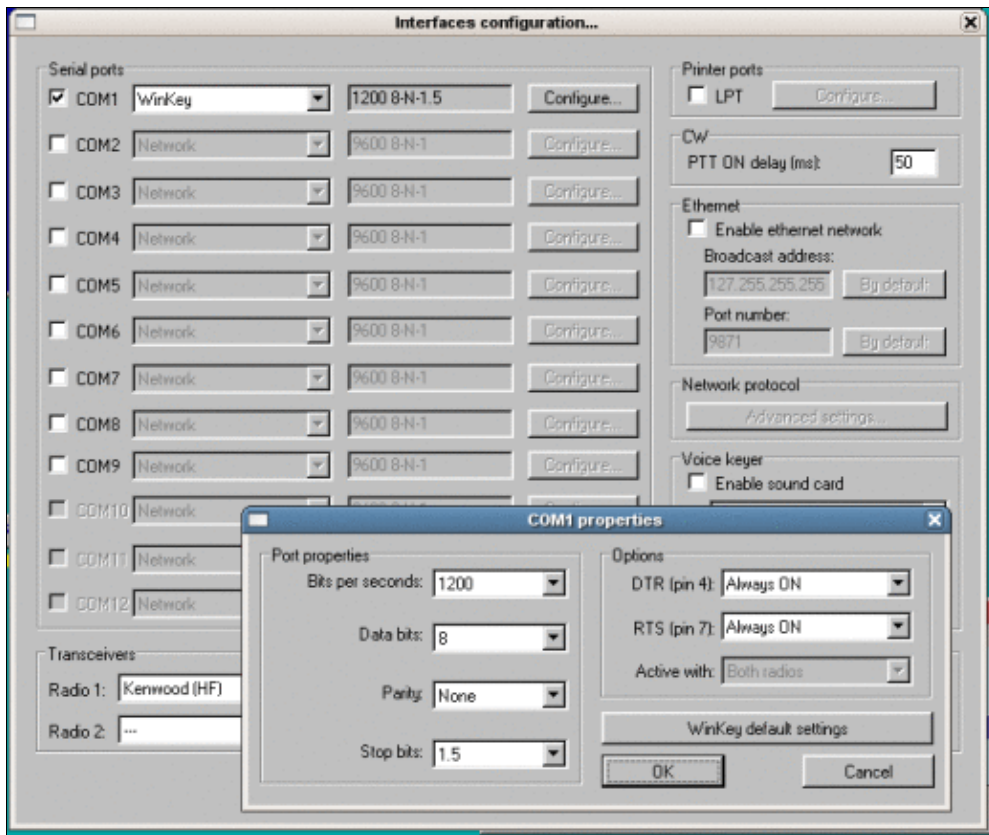

**EZMaster**

**MicroHam MK2R**

**AlphaAmp Radio 1/2**

**Transceivers**

**Version summary**

**Known bugs**

**Links**

- [Wine HQ - Windows emulator](#)
- [Wine online documentation](#)

**Namespaces**

- [Page](#)
- [Discussion](#)

**Variants**

**Views**

- [Read](#)
- [View source](#)
- [View history](#)

**More**

- This page was last edited on 2 October 2010, at 18:54.

- [Privacy policy](#)
- [About Win-Test Wiki](#)
- [Disclaimers](#)





# running on Linux

From Win-Test Wiki

[Jump to navigation](#) [Jump to search](#)

## Contents

- [1 Introduction](#)
- [2 Installation](#)
- [3 Interfaces](#)
  - ◆ [3.1 Serial and printer ports](#)
    - ◇ [3.1.1 Serial and printer port configuration](#)
    - ◇ [3.1.2 Network](#)
    - ◇ [3.1.3 Packet Radio TNC](#)
    - ◇ [3.1.4 Radio 1/2](#)
    - ◇ [3.1.5 W5XD Multi-Keyer](#)
    - ◇ [3.1.6 WinKey](#)
    - ◇ [3.1.7 EZMaster](#)
    - ◇ [3.1.8 MicroHam MK2R](#)
    - ◇ [3.1.9 AlphaAmp Radio 1/2](#)
  - ◆ [3.2 Transceivers](#)
- [4 Version summary](#)
- [5 Known bugs](#)
- [6 Links](#)

## Introduction

With the Windows emulator *wine* Win-Test runs also on Linux-machines. This article describes installation, which features work and which not.

The screenshot displays the Win-Test software interface with the following components:

- Radio 1 Panel:** Shows VFO A at 70235 and VFO B at 70175. A list of frequencies and call signs is visible, including 7002.5 (-DKOED), 7006.9 54\* (-SPLAEN), 7009.2 (-DR0BAMA), 7010.2 141\* (-PA7A), 7013.7 (-DD3D), 7019.2 49\* (-LY6R), and 7023.5 54\* (-SK0PVO).
- Check partial result:** Shows [UNIQUE] for R + 1.
- Check multipliers:**

160
80
511 40 08:55 SN0FWQ 599226
20
15
10

SP: Poland 09551  
 Az: 54° Lp: 234° SR: 0225z SS: 1840z  
 08:56:20 DL5RMH JN68BN SR 0318z SS 1859z
- QSO Log:**

QSO	Bd	Time	Call sign	Sent N°	Rcvd	Mult	PtsStn
503	40	08:50	OE3JAG	599 503	599 135	OE3	2 R
504	40	08:51	OZ8KD	599 504	599 501		2 R
505	40	08:52	ES1CW	599 505	599 418		2 R
506	40	08:52	DL9NEI	599 506	599 187		1 R
507	40	08:53	OK2KR	599 507	599 453		2 R
508	40	08:53	DK7JZ	599 508	599 011	DK7	1 R
509	40	08:54	DJ4BA	599 509	599 014		1 R
510	40	08:55	SP9KRT	599 510	599 655		2 R
511	40	08:55	SN0FWQ	599 511	599 226	SN0	2 R
512	40			599 512	599		0 R
- Rate Panel:**
  - All bands - All modes: 56 Q/h
  - Last hour: 108 Q/h
  - 10 last QSO: 9 Q/h
  - 100 last QSO: 56 QSO
  - Since 0800z: - 15 last minutes -
  - Moving graph computed on 15 mins
  - Continents distribution: EU, NA, SA, AF, AS, OC
  - Elapsed time since the last QSO: 39 Sec
  - Time ON: 11 H 01 Mn
  - Time OFF: 9 H 15 Mn
  - Last bands changes: Radio 1: 32 Mn, Radio 2: -
  - All bands - All modes: Time by mult: 4 Mn 03 Sec
  - 1 QSO counts: 501 Pts
  - 1 mult counts: 856 Pts
  - 1 mult worth: 1.7 QSO
  - CW 32 WPM
- Summary Panel:**

BAND	QSO	DUP	PFX	POINTS	AVG
160	0	0	0	0	0.00
80	71	0	35	153	2.15
40	146	0	78	306	2.10
20	137	1	101	183	1.34
15	82	0	48	128	1.56
10	74	0	37	86	1.16
TOTAL	510	1	299	856	1.68

FINAL SCORE: 255 944

# Installation

## Interfaces

### Serial and printer ports

#### Serial and printer port configuration

Serial (and also printer) ports in wine are configured with Symlinks. Each DOS-device (com1, com2, ... lpt1, lpt2) is represented as a symlink to the device in linux.

To make the symlinks like they are shown in the example image, you have to type:

```
ln -s /dev/ttyUSB0 com1
ln -s /dev/ttyUSB1 com2
ln -s /dev/lp0 lpt1
```

in the `.wine/dosdevices` directory in your home directory. Of course you have to type your own configuration.

```

Datei Bearbeiten Ansicht Terminal Reiter Hilfe
insgesamt 8
drwxr-xr-x 2 martin users 4096 2007-10-18 20:15 .
drwxr-xr-x 4 martin users 4096 2007-12-02 16:04 ..
lrwxrwxrwx 1 martin users 10 2007-04-14 10:21 c: -> ../drive_c
lrwxrwxrwx 1 martin users 12 2007-05-19 17:39 com1 -> /dev/ttyUSB0
lrwxrwxrwx 1 martin users 12 2007-05-26 12:33 com2 -> /dev/ttyUSB1
lrwxrwxrwx 1 martin users 13 2007-04-21 09:57 d: -> /media/cdrom0
lrwxrwxrwx 1 martin users 14 2007-05-14 22:54 e: -> /media/usbdisk
lrwxrwxrwx 1 martin users 14 2007-05-14 23:07 f: -> /media/usbdisk
lrwxrwxrwx 1 martin users 9 2007-05-14 23:07 f: -> /dev/sda1
lrwxrwxrwx 1 martin users 13 2007-05-26 14:29 g: -> /media/cdrom0
lrwxrwxrwx 1 martin users 8 2007-05-14 23:07 g: -> /dev/hdc
lrwxrwxrwx 1 martin users 9 2007-07-08 19:21 h: -> /dev/scd0
lrwxrwxrwx 1 martin users 8 2007-05-20 12:49 lpt1 -> /dev/lp0
lrwxrwxrwx 1 martin users 1 2007-04-14 10:21 z: -> /
martin@martin-notebook: ~/.wine/dosdevices$

```

Tip: If you use USB-serial-adaptors, take a look at /var/log/syslog while or after you connected the device (Debian/ubuntu). The log will show you where got device is connected (e.g. /dev/ttyUSB0 -> first serial port running via USB).

You can use the definition direct in your Win-Test.

Reference: [Wine HQ documentation: Serial and Parallel Ports](#)

## Network

### Packet Radio TNC

### Radio 1/2

### W5XD Multi-Keyer

### WinKey

Working stable with following configuration:

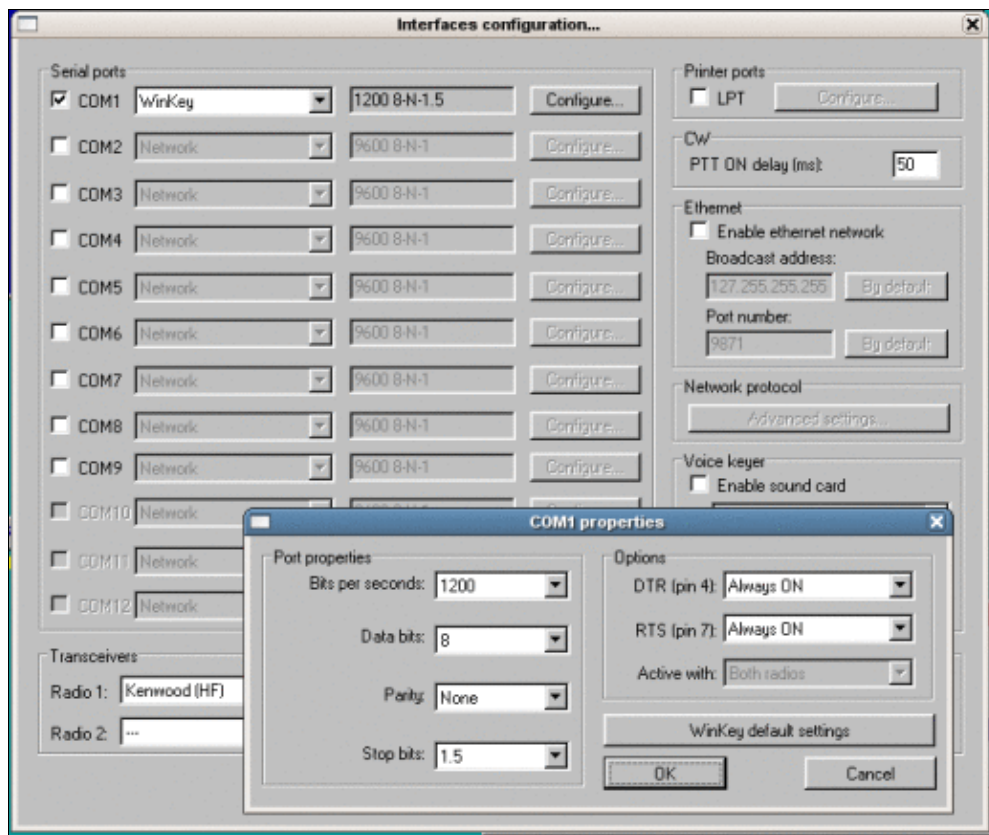

**EZMaster**

**MicroHam MK2R**

**AlphaAmp Radio 1/2**

**Transceivers**

**Version summary**

**Known bugs**

**Links**

- [Wine HQ - Windows emulator](#)
- [Wine online documentation](#)

**Namespaces**

- [Page](#)
- [Discussion](#)

**Variants**

**Views**

- [Read](#)
- [View source](#)
- [View history](#)

**More**

- This page was last edited on 2 October 2010, at 18:54.

- [Privacy policy](#)
- [About Win-Test Wiki](#)
- [Disclaimers](#)



# SO2R/Second radio window

From Win-Test Wiki

[Jump to navigation](#) [Jump to search](#)

The Secondary Radio windows allows the operator in the SO2R category to control the program when using two radios. For this window to be enabled, either the SO2R or the Advanced SO2R option must be checked in the menu `Operating | Technique`. Then you can open this window by selecting `Menu | Windows | Secondary radio`.

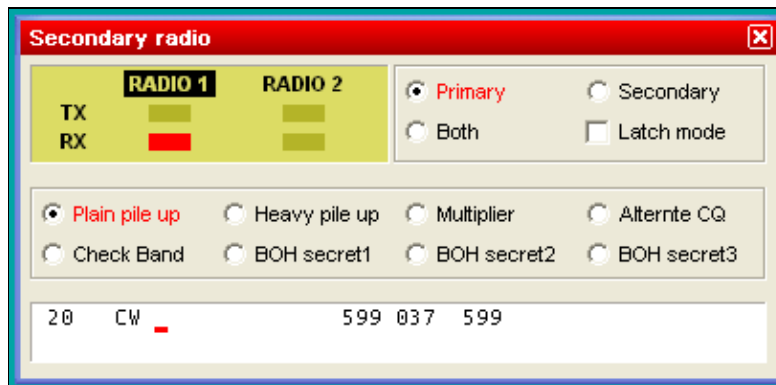

The Secondary radio window

If you select `Tools | Data Entry | Enable Run/S&P switching`, an additional status line is displayed:

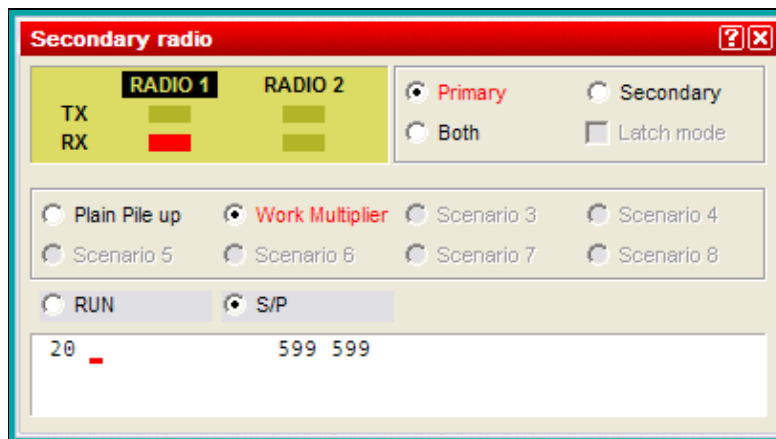

The Secondary radio window with the RUN and S&P radio options visible

The Secondary Radio window has up to five different areas:

## Radio TX/RX information area

If Radio1 TX led is red then radio 1 is transmitting. If Radio2 TX led is red then radio 2 is transmitting. If Radio1 RX led is red then audio from radio 1 is in both ears of headphone. If Radio 2 RX led is red then audio from radio 2 is in both ears of headphone. If both Radio1 and Radio2 RX led are red then audio from radio 1 is in left ear of headphone and audio from radio 2 is in right ear of headphone.

## Headphone audio control area

With a mouse click the operator can control to what radio the headphone is switched to. Clicking the Primary button switches the headphones audio to the primary radio. Clicking the Secondary button switches the headphones audio to the secondary radio. Clicking the Both button switches the headphones audio to both ears (radio 1 in left ear and radio 2 in right ear).

Latch mode switches the headphones to the secondary radio during transmit (sometimes called "headphone latch"). To activate latch mode, check the "Latch mode" box near the top right of the secondary radio window. If this box is disabled (grayed out), it means that your SO2R controller does not support the required commands. Configuring either a microHAM or EZMaster SO2R controller in Win-Test will enable this feature.

### Latch Mode specifics

On SSB, latch mode is needed because audio can be generated manually by the operator using a microphone. In this case the operator is talking and does not push **[F1]–[F7]** keys so he cannot activate the automatic audio/transmission present in the respective scenarios. Audio can also be generated automatically either from the sound card or from an external voice keyer using the **[F1]–[F7]** keys. In this situation scenarios work OK.

On CW, using scenarios, latch mode is not needed, because the scenarios will control audio switching according to the audio variables (**\$R1R1**, **\$R1R2**, **\$R2R2**) and transmission is automatically generated by the **[F1]–[F7]**, **[Insert]** and **[Plus]** keys (CW messages). When using an external CW keyer for quick chat in a contest QSO, usually the operator needs to hear his CW, so audio can be controlled manually either listening just to primary radio or both radios.

## Scenario control area

The operator can select different scenarios to automatically control headphone audio at each step when making a QSO. There are five pre-defined scenarios: Plain pile up, Heavy pile up, Multiplier, Alternate CQ and Check Band. These scenarios can be created or modified by using Operating | Modify the scenarios, or by simply *double-clicking* on the scenario *name*. The user can configure up to eight different scenarios. The scenarios can be simple or complicated, matching the SO2R skills of the operator<sup>[1]</sup>.

To select and activate a scenario, click the corresponding radio button, or use **[AltGr-1] ... [AltGr-8]**. On a U.S. keyboard, use **[Ctrl-Alt-1] ... [Ctrl-Alt-8]**.

To *edit* any of the listed scenarios, *double-click* on the scenario *name*.

## RUN or S/P area

You can toggle the secondary radio between RUN and S/P (Search and pounce) modes by selecting a mode with the mouse. The RUN/S&P mode affects which set of messages are sent when the secondary radio window is activated.

## Secondary radio log fields area

This area shows the callsign, RST sent, RST received and zone received of the secondary radio prior to insert the callsign in the log. In order to write calls in the callsign field of the secondary radio tick first in the menu Operating | Shift binds to the secondary radio and/or Operating | Caps Lock binds to the secondary radio.

Imagine Radio1 is the primary radio being used to RUN and Radio2 is secondary radio being used to S&P. The operator spots a new multiplier on Radio2. In order to put the call in the callsign field, the operator must press the [**Shift**] key while typing the call. If the operator does not press the [**Shift**] key then the call will go into the primary radio callsign field. Another way is to activate the [**Caps Lock**] key. While activated what you write in the keyboard goes to the secondary radio.

### Namespaces

- [Page](#)
- [Discussion](#)

### Variants

### Views

- [Read](#)
- [View source](#)
- [View history](#)

### More

- This page was last edited on 1 October 2010, at 22:56.

- [Privacy policy](#)
- [About Win-Test Wiki](#)
- [Disclaimers](#)





# SO2R/Second radio window

From Win-Test Wiki

[Jump to navigation](#) [Jump to search](#)

The Secondary Radio windows allows the operator in the SO2R category to control the program when using two radios. For this window to be enabled, either the SO2R or the Advanced SO2R option must be checked in the menu `Operating | Technique`. Then you can open this window by selecting `Menu | Windows | Secondary radio`.



The Secondary radio window

If you select `Tools | Data Entry | Enable Run/S&P switching`, an additional status line is displayed:

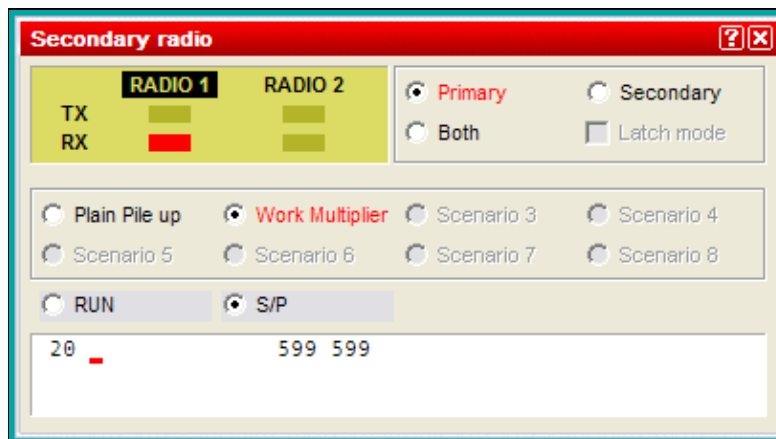

The Secondary radio window with the RUN and S&P radio options visible

The Secondary Radio window has up to five different areas:

## Radio TX/RX information area

If Radio1 TX led is red then radio 1 is transmitting. If Radio2 TX led is red then radio 2 is transmitting. If Radio1 RX led is red then audio from radio 1 is in both ears of headphone. If Radio 2 RX led is red then audio from radio 2 is in both ears of headphone. If both Radio1 and Radio2 RX led are red then audio from radio 1 is in left ear of headphone and audio from radio 2 is in right ear of headphone.

## Headphone audio control area

With a mouse click the operator can control to what radio the headphone is switched to. Clicking the Primary button switches the headphones audio to the primary radio. Clicking the Secondary button switches the headphones audio to the secondary radio. Clicking the Both button switches the headphones audio to both ears (radio 1 in left ear and radio 2 in right ear).

Latch mode switches the headphones to the secondary radio during transmit (sometimes called "headphone latch"). To activate latch mode, check the "Latch mode" box near the top right of the secondary radio window. If this box is disabled (grayed out), it means that your SO2R controller does not support the required commands. Configuring either a microHAM or EZMaster SO2R controller in Win-Test will enable this feature.

### Latch Mode specifics

On SSB, latch mode is needed because audio can be generated manually by the operator using a microphone. In this case the operator is talking and does not push **[F1]–[F7]** keys so he cannot activate the automatic audio/transmission present in the respective scenarios. Audio can also be generated automatically either from the sound card or from an external voice keyer using the **[F1]–[F7]** keys. In this situation scenarios work OK.

On CW, using scenarios, latch mode is not needed, because the scenarios will control audio switching according to the audio variables (**\$R1R1**, **\$R1R2**, **\$R2R2**) and transmission is automatically generated by the **[F1]–[F7]**, **[Insert]** and **[Plus]** keys (CW messages). When using an external CW keyer for quick chat in a contest QSO, usually the operator needs to hear his CW, so audio can be controlled manually either listening just to primary radio or both radios.

## Scenario control area

The operator can select different scenarios to automatically control headphone audio at each step when making a QSO. There are five pre-defined scenarios: Plain pile up, Heavy pile up, Multiplier, Alternate CQ and Check Band. These scenarios can be created or modified by using Operating | Modify the scenarios, or by simply *double-clicking* on the scenario *name*. The user can configure up to eight different scenarios. The scenarios can be simple or complicated, matching the SO2R skills of the operator<sup>[1]</sup>.

To select and activate a scenario, click the corresponding radio button, or use **[AltGr-1] ... [AltGr-8]**. On a U.S. keyboard, use **[Ctrl-Alt-1] ... [Ctrl-Alt-8]**.

To *edit* any of the listed scenarios, *double-click* on the scenario *name*.

## RUN or S/P area

You can toggle the secondary radio between RUN and S/P (Search and pounce) modes by selecting a mode with the mouse. The RUN/S&P mode affects which set of messages are sent when the secondary radio window is activated.

## Secondary radio log fields area

This area shows the callsign, RST sent, RST received and zone received of the secondary radio prior to insert the callsign in the log. In order to write calls in the callsign field of the secondary radio tick first in the menu Operating | Shift binds to the secondary radio and/or Operating | Caps Lock binds to the secondary radio.

Imagine Radio1 is the primary radio being used to RUN and Radio2 is secondary radio being used to S&P. The operator spots a new multiplier on Radio2. In order to put the call in the callsign field, the operator must press the [**Shift**] key while typing the call. If the operator does not press the [**Shift**] key then the call will go into the primary radio callsign field. Another way is to activate the [**Caps Lock**] key. While activated what you write in the keyboard goes to the secondary radio.

### Namespaces

- [Page](#)
- [Discussion](#)

### Variants

### Views

- [Read](#)
- [View source](#)
- [View history](#)

### More

- This page was last edited on 1 October 2010, at 22:56.

- [Privacy policy](#)
- [About Win-Test Wiki](#)
- [Disclaimers](#)



# Multi-op/Issues/Sequential serials

From Win-Test Wiki

[Jump to navigation](#) [Jump to search](#)

## Sequential Serials

In some contests it is necessary to maintain sequential serial numbers for **both** stations (not per station/band) in the multi/single category. If you are not careful you may give out a serial number that is taken by the other station(s) if you do not enter the QSO quick enough!

To overcome this, it is recommended on the mult station(s) to type the call/double-click the spot of the station you are trying to work, and as soon as you hear him come back to you, enter the QSO **immediately** by entering serial number 0 (zero). Then simply press the up arrow on the keyboard to the QSO and use the spacebar to move across to the serial number field and enter the correct serial number given by the other party.

If you were not quick enough to press the enter key and that number was taken by someone else, make sure the other station gets the information right and tell him the new, correct serial number.

This is a practical solution that has been in use for years, also during MS-DOS and CT times. Win-Test does not have a number reserve feature because it (intentionally) lacks a central data master.

To avoid confusing QSO number with sent serial number, it is a really good idea to hide the QSO number column (see [Menu:Options#Hide\\_QSO\\_numbers](#)). Now your eye will only look at the **Sent No.** column when giving out serial numbers.

## Namespaces

- [Page](#)
- [Discussion](#)

## Variants

## Views

- [Read](#)
- [View source](#)
- [View history](#)

## More

- This page was last edited on 16 July 2009, at 20:51.
- [Privacy policy](#)
- [About Win-Test Wiki](#)
- [Disclaimers](#)



# SO2R/EZMaster

From Win-Test Wiki

(Redirected from [SO2R/EZMaster/Setup](#))

[Jump to navigation](#) [Jump to search](#)

## Contents

- [1 Setting up the EZMaster for use with Win-Test](#)
  - ◆ [1.1 Setting up the technique](#)
  - ◆ [1.2 Setting up the \[Shift\] key for secondary radio](#)
  - ◆ [1.3 Setting up the \[Caps Lock\] key for secondary radio](#)
  - ◆ [1.4 Setting the SO2R Control box](#)
- [2 See also](#)
  - ◆ [2.1 External sources](#)

## Setting up the EZMaster for use with Win-Test

Advanced SO2R mode and setting up scenarios requires external SO2R control equipment of the last generation, communicating with Win-Test via a USB port. EZMaster from HamRadioSolutions has this possibility.

### Setting up the technique

The user must check in the menu `Operating | Technique | Advanced SO2R`.

### Setting up the [Shift] key for secondary radio

The user must check in the menu `Operating | Shift binds to the secondary radio`.

### Setting up the [Caps Lock] key for secondary radio

The user must check in the menu `Operating | Caps Lock binds to the secondary radio`.

### Setting the SO2R Control box

The control SO2R box must be configured in the menu `Options | Configure interfaces`, select a virtual COM port and - if using an EZMaster - choose for settings 19200 bits per second, 8 data bits, no parity, and 1 stop bit, CW for DTR, PTT for RTS and Both Radios active.

Finally the user must set in the case of an EZMaster control box in the menu `Options | EZMaster configuration`, and choose the radios communication data. For example, for two FT1000MPs, the settings are port **rs232** and **com** (cable connecting radios to EZMaster), a speed of 4800 baud, 8 data bits, no parity, 2 stop bits.

## See also

## External sources

- [HamRadioSolutions web site](#)

## Namespaces

- [Page](#)
- [Discussion](#)

## Variants

## Views

- [Read](#)
- [View source](#)
- [View history](#)

## More

- This page was last edited on 12 September 2013, at 14:23.

- [Privacy policy](#)
- [About Win-Test Wiki](#)
- [Disclaimers](#)



# SO2R/EZMaster

From Win-Test Wiki

(Redirected from [SO2R/EZMaster/Setup](#))

[Jump to navigation](#) [Jump to search](#)

## Contents

- [1 Setting up the EZMaster for use with Win-Test](#)
  - ◆ [1.1 Setting up the technique](#)
  - ◆ [1.2 Setting up the \[Shift\] key for secondary radio](#)
  - ◆ [1.3 Setting up the \[Caps Lock\] key for secondary radio](#)
  - ◆ [1.4 Setting the SO2R Control box](#)
- [2 See also](#)
  - ◆ [2.1 External sources](#)

## Setting up the EZMaster for use with Win-Test

Advanced SO2R mode and setting up scenarios requires external SO2R control equipment of the last generation, communicating with Win-Test via a USB port. EZMaster from HamRadioSolutions has this possibility.

### Setting up the technique

The user must check in the menu `Operating | Technique | Advanced SO2R`.

### Setting up the [Shift] key for secondary radio

The user must check in the menu `Operating | Shift binds to the secondary radio`.

### Setting up the [Caps Lock] key for secondary radio

The user must check in the menu `Operating | Caps Lock binds to the secondary radio`.

### Setting the SO2R Control box

The control SO2R box must be configured in the menu `Options | Configure interfaces`, select a virtual COM port and - if using an EZMaster - choose for settings 19200 bits per second, 8 data bits, no parity, and 1 stop bit, CW for DTR, PTT for RTS and Both Radios active.

Finally the user must set in the case of an EZMaster control box in the menu `Options | EZMaster configuration`, and choose the radios communication data. For example, for two FT1000MPs, the settings are port **rs232** and **com** (cable connecting radios to EZMaster), a speed of 4800 baud, 8 data bits, no parity, 2 stop bits.

## See also

## External sources

- [HamRadioSolutions web site](#)

## Namespaces

- [Page](#)
- [Discussion](#)

## Variants

## Views

- [Read](#)
- [View source](#)
- [View history](#)

## More

- This page was last edited on 12 September 2013, at 14:23.

- [Privacy policy](#)
- [About Win-Test Wiki](#)
- [Disclaimers](#)





# SO2R/MK2R

From Win-Test Wiki

(Redirected from [SO2R/MK2R/Setup](#))

[Jump to navigation](#) [Jump to search](#)

## Contents

- [1 Setting up the MK2R for use with Win-Test](#)
  - ◆ [1.1 Setting up the technique](#)
  - ◆ [1.2 Setting up the \[Shift\] key for secondary radio](#)
  - ◆ [1.3 Setting up the \[Caps Lock\] key for secondary radio](#)
  - ◆ [1.4 Setting the SO2R Control box](#)
    - ◇ [1.4.1 Device Router COM ports creation](#)
    - ◇ [1.4.2 Device Router COM ports setting](#)
    - ◇ [1.4.3 Device Router Audio Switching setting](#)
    - ◇ [1.4.4 Device Router Audio Mixer volume setting](#)
    - ◇ [1.4.5 Device Router PTT and FSK setting](#)
    - ◇ [1.4.6 Device Router Internal CW Keyer setting](#)
    - ◇ [1.4.7 Device Router CW Messages setting](#)
    - ◇ [1.4.8 Device Router FSK Messages setting](#)
    - ◇ [1.4.9 Device Router DVK Voice Messages setting](#)
    - ◇ [1.4.10 Device Router Keyboard setting](#)
    - ◇ [1.4.11 Device Router SO2R Behaviour setting](#)
    - ◇ [1.4.12 Device Router ACC port setting](#)
    - ◇ [1.4.13 Device Router SO2R Audio switching setting](#)
    - ◇ [1.4.14 Device Router SAVE your setting](#)
    - ◇ [1.4.15 Device Router Overall Device setting view](#)
    - ◇ [1.4.16 Device Router set Win-Test Interfaces configuration](#)
- [2 See also](#)
  - ◆ [2.1 External sources](#)

## Setting up the MK2R for use with Win-Test

Advanced SO2R mode and setting up scenarios requires external SO2R control equipment of the last generation, communicating with Win-Test via a USB port. MK2R from MicroHAM has this possibility.

### Setting up the technique

The user must check in the menu `Operating | Technique | Advanced SO2R`.

### Setting up the [Shift] key for secondary radio

The user must check in the menu `Operating | Shift binds to the secondary radio`.

### Setting up the [Caps Lock] key for secondary radio

The user must check in the menu `Operating | Caps Lock binds to the secondary radio`.

## Setting the SO2R Control box

Shown below are screen shots of a step-by-step setup procedure.

### Device Router COM ports creation

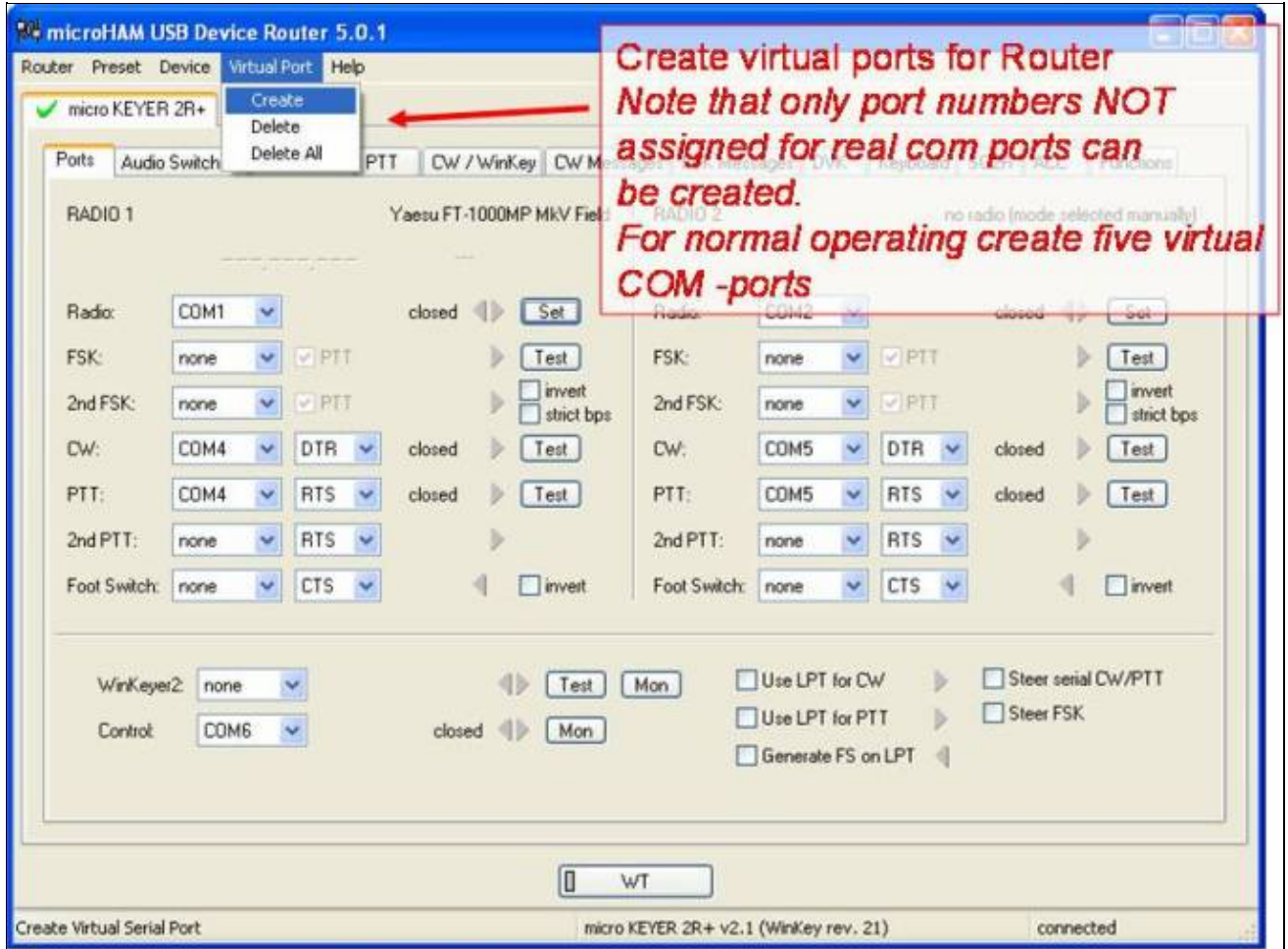

COM ports creation

**Device Router COM ports setting**

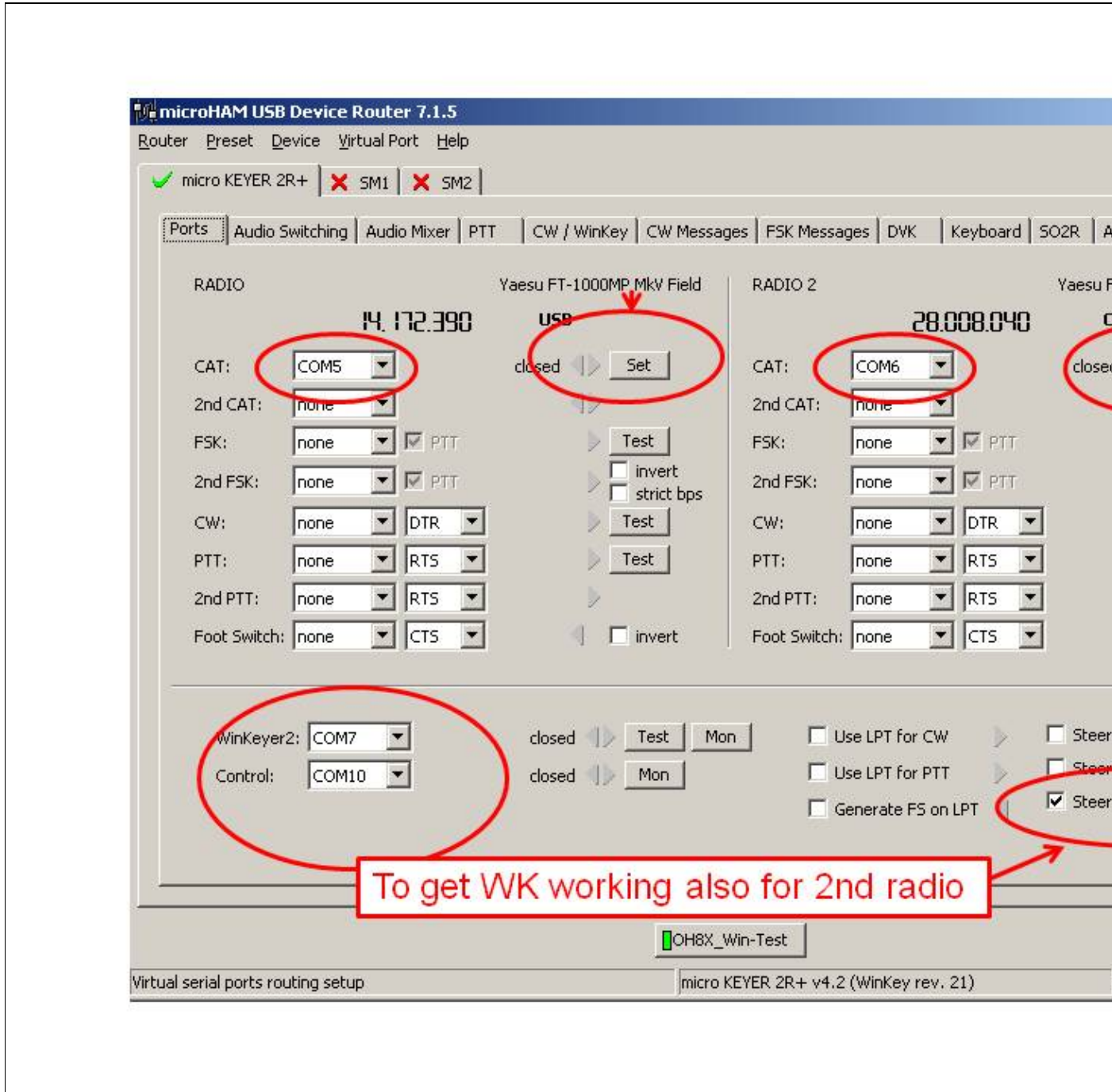

COM port setting

Device Router Audio Switching setting

The screenshot shows the 'microHAM USB Device Router 7.1.5' software interface. At the top, there are menu options: Router, Preset, Device, Virtual Port, and Help. Below the menu, there are status indicators for 'micro KEYER 2R+' (checked), 'SM1' (unchecked), and 'SM2' (unchecked). The main interface is divided into sections for 'Radio 1' and 'Radio 2'. Each radio section has a 'VOICE CODEC (SC1)' and a 'RADIO' section. The 'VOICE CODEC (SC1)' section includes 'OUTPUT' and 'MIC INPUT' labels with red arrows indicating signal flow. The 'RADIO' section includes 'REAR AUDIO' and 'FRONT MIC' labels, a radio icon, and a 'VOX or command PTT' checkbox. To the right of the radio sections, there are radio buttons labeled 'A', 'B', and 'C'. Below the radio sections, there is a 'VOICE CODEC (SC1)' section with 'OUTPUT' and 'MIC INPUT' labels. A red box with white text is overlaid on the interface, containing the text: 'May be problem on 40M SSB, Either select voice settings or modify digital band map for SSB contests'. To the right of the interface, there is an 'Audio switching' section with a 'CW' dropdown menu set to 'AAA, voice', a 'VOICE' dropdown menu set to 'CmCmA, v', and an 'FSK/DIGITAL' dropdown menu set to 'BBB, audio'. Below this, there is a 'VOICE/DIGITAL:' dropdown menu set to 'Select by f', and a 'Digital' button. At the bottom of the interface, there is a status bar with 'OH8X\_Win-Test' and 'Microphone, sound card & Radio routing setup'.

audio switching setting

**Device Router Audio Mixer volume setting**

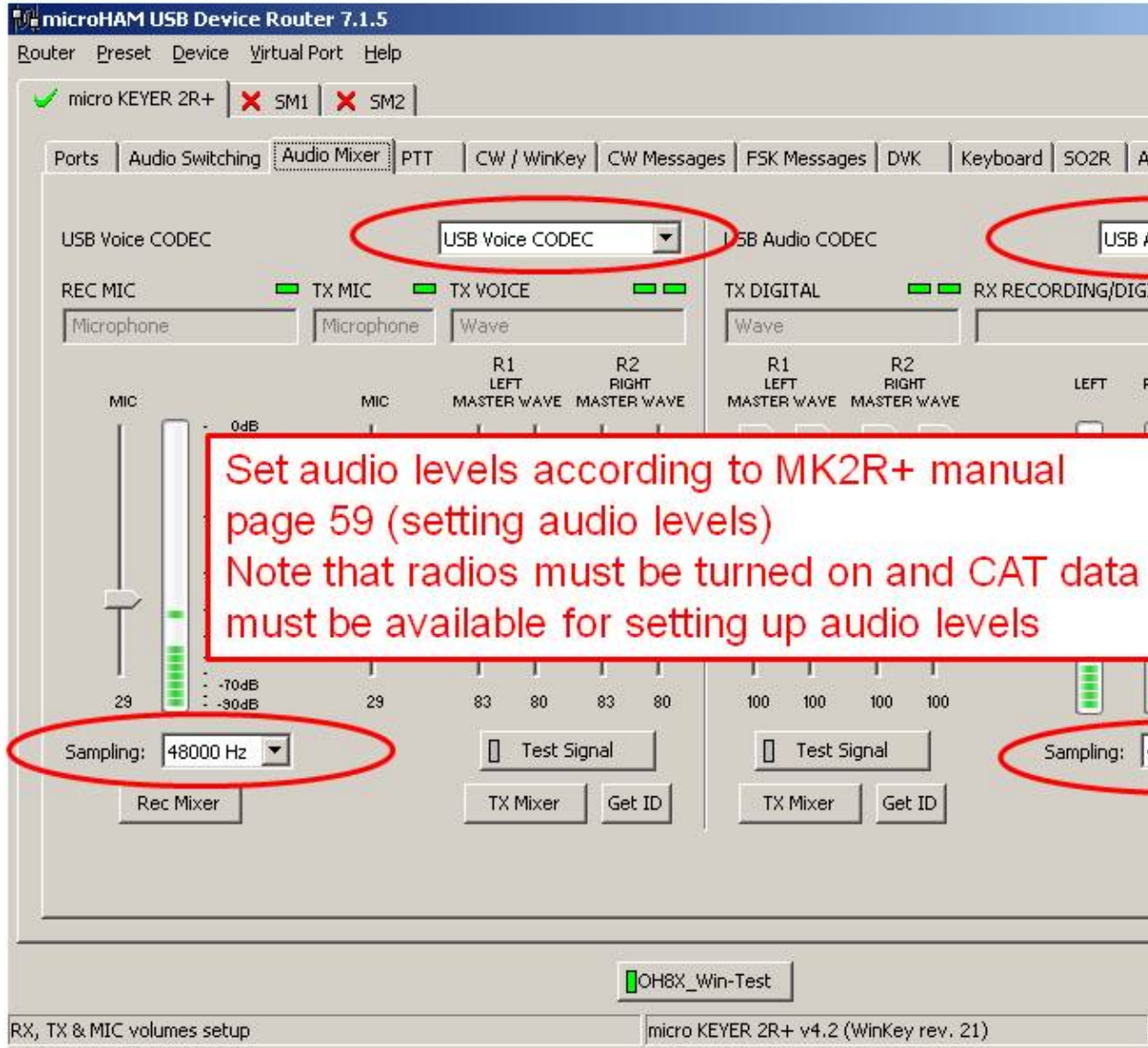

Audio Mixer volume setting

### Device Router PTT and FSK setting

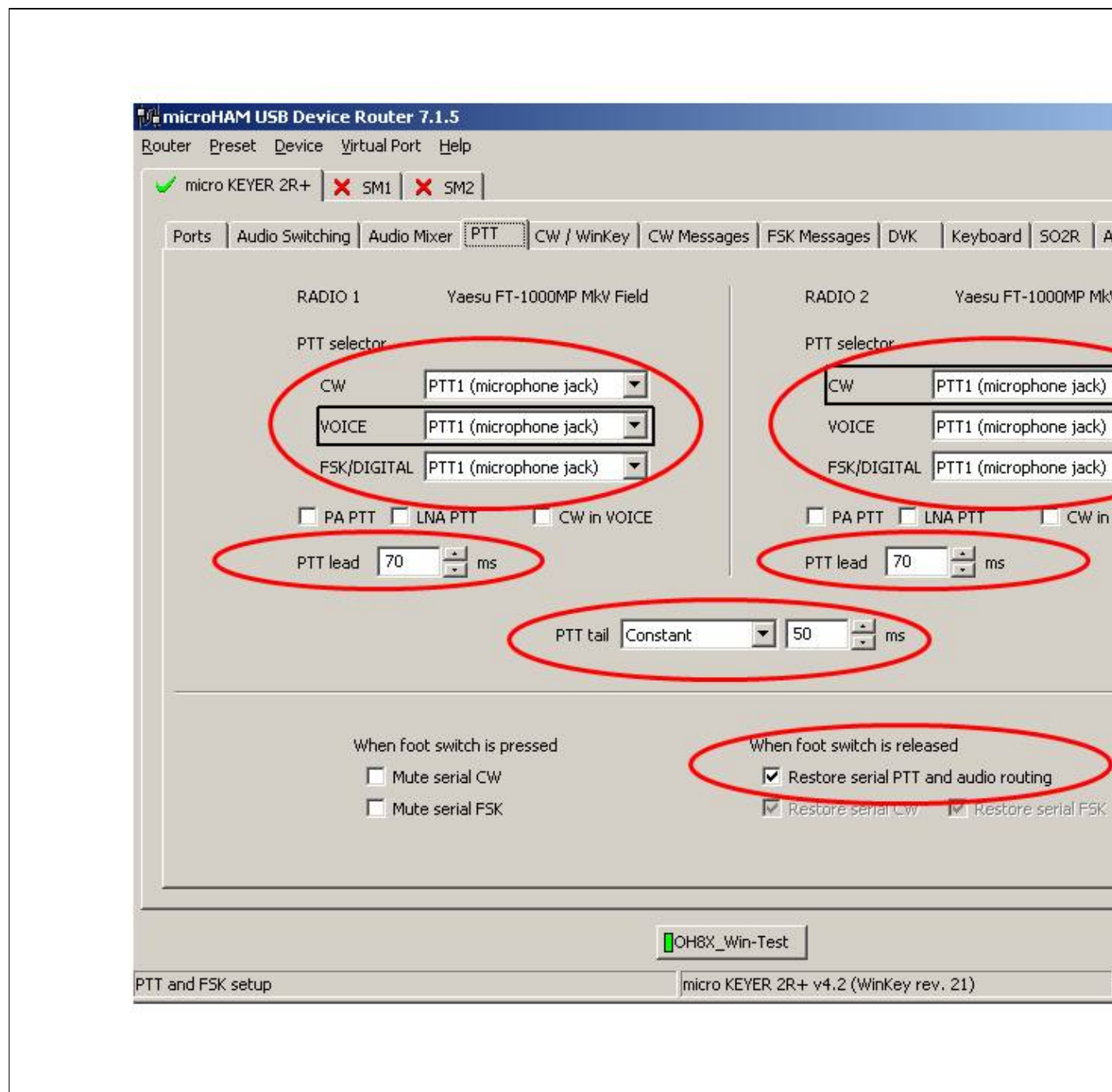

PTT and FSK setting

### Device Router Internal CW Keyer setting

microHAM USB Device Router 7.1.5

Router Preset Device Virtual Port Help

micro KEYER 2R+ SM1 SM2

Ports Audio Switching Audio Mixer PTT CW / WinKey CW Messages FSK Messages DVK Keyboard SO2R A

Paddle mode  
Iambic B (Accu-keyer)

Priority  dit  dah

Speed pot min 20 WPM  
Speed pot max 40 WPM  
Farnsworth speed 0 WPM

To sync WK and WT keyers use these values

Swap paddles  
 Auto space  
 CT space

1st extension 0 ms  
Keying compensation 0 ms (QSK only)

WK Echo

Current speed: 30 WPM Speed pot: 30 Next number: 001

OH8X\_Win-Test

Internal CW keyer (WinKey) setup micro KEYER 2R+ v4.2 (WinKey rev. 21)

Internal CW Keyer setting

### Device Router CW Messages setting

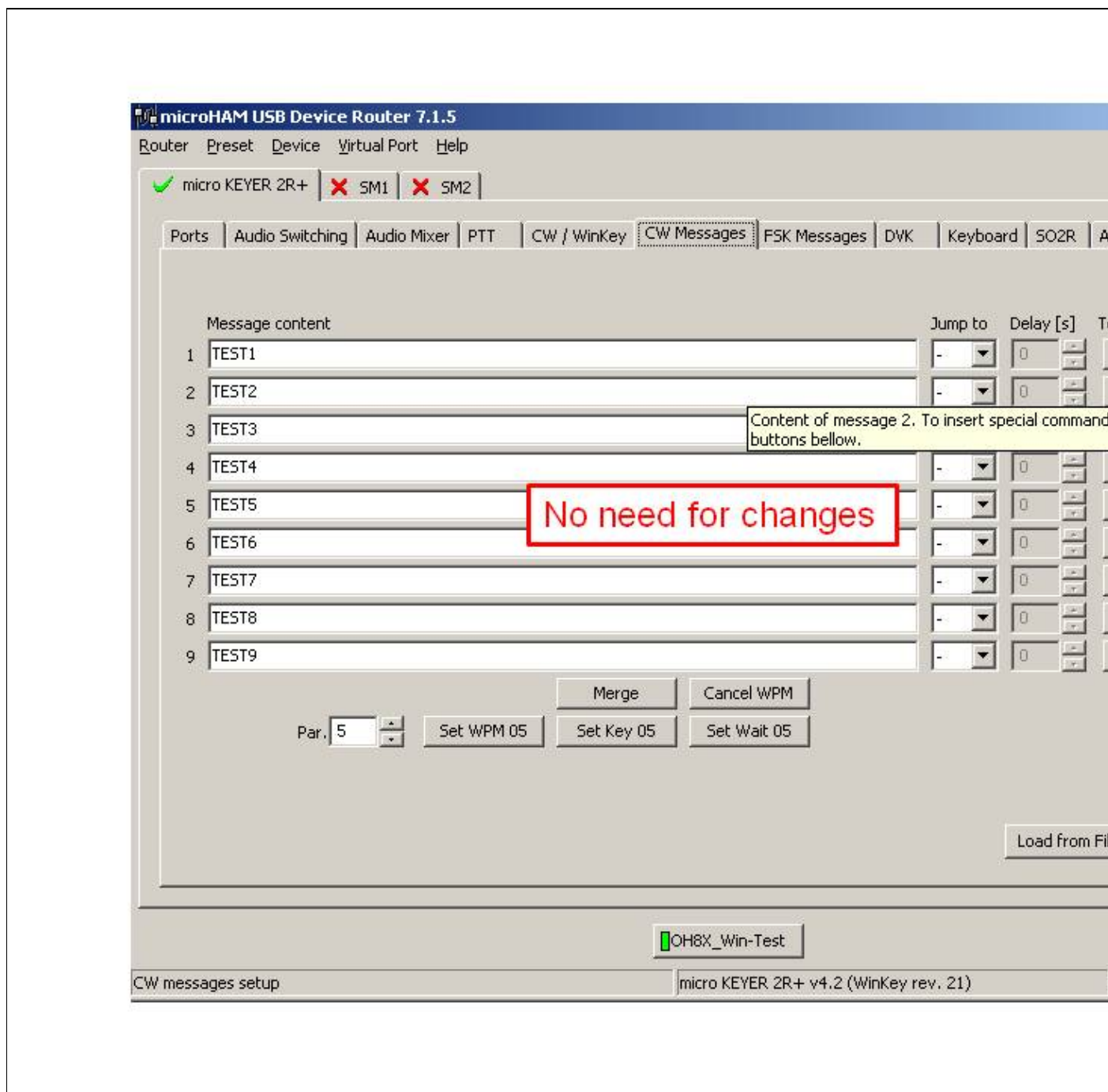



CW Messages setting

### Device Router FSK Messages setting

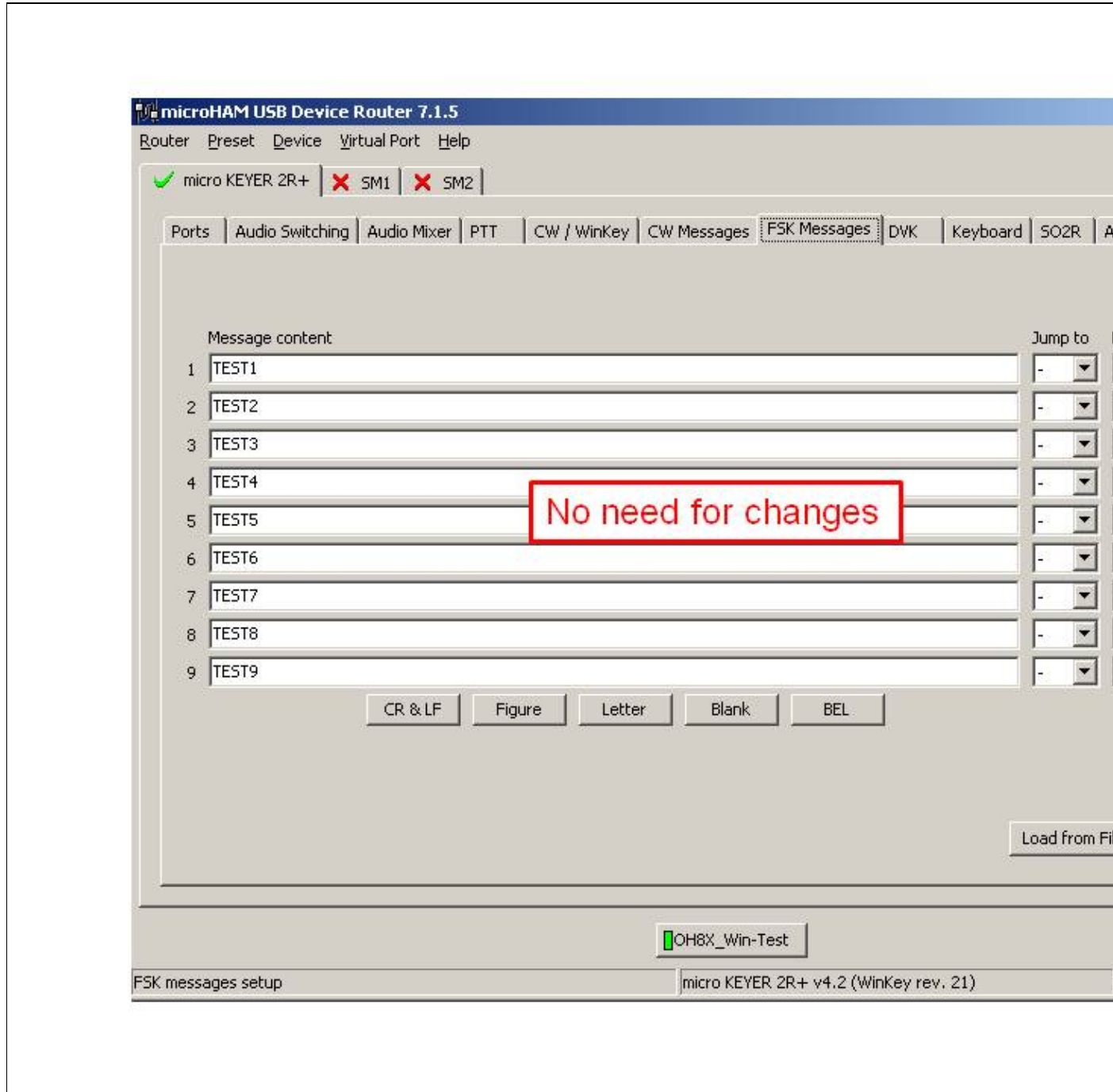

FSK Messages setting

**Device Router DVK Voice Messages setting**

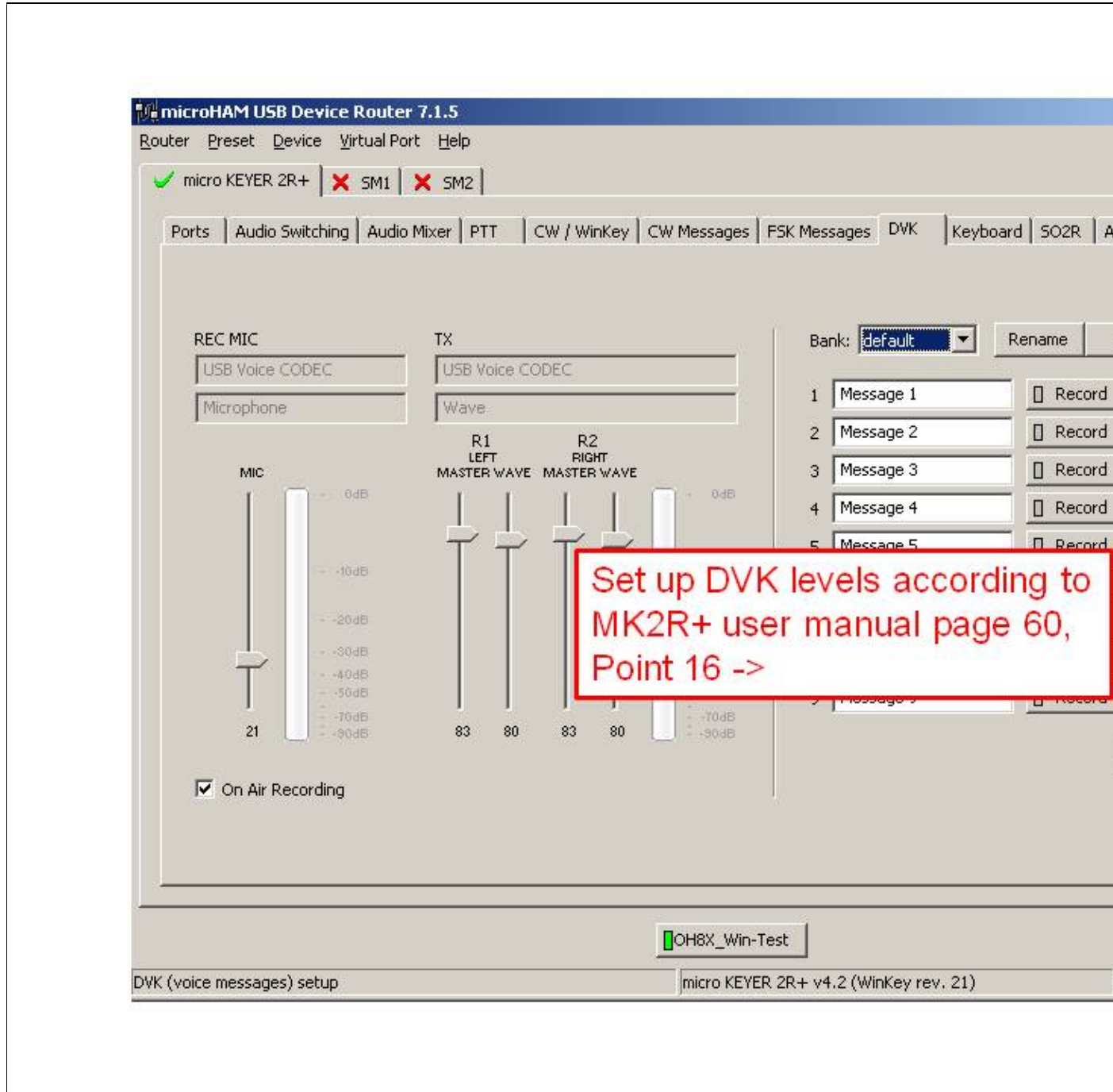

DVK Voice Messages setting  
**Device Router Keyboard setting**

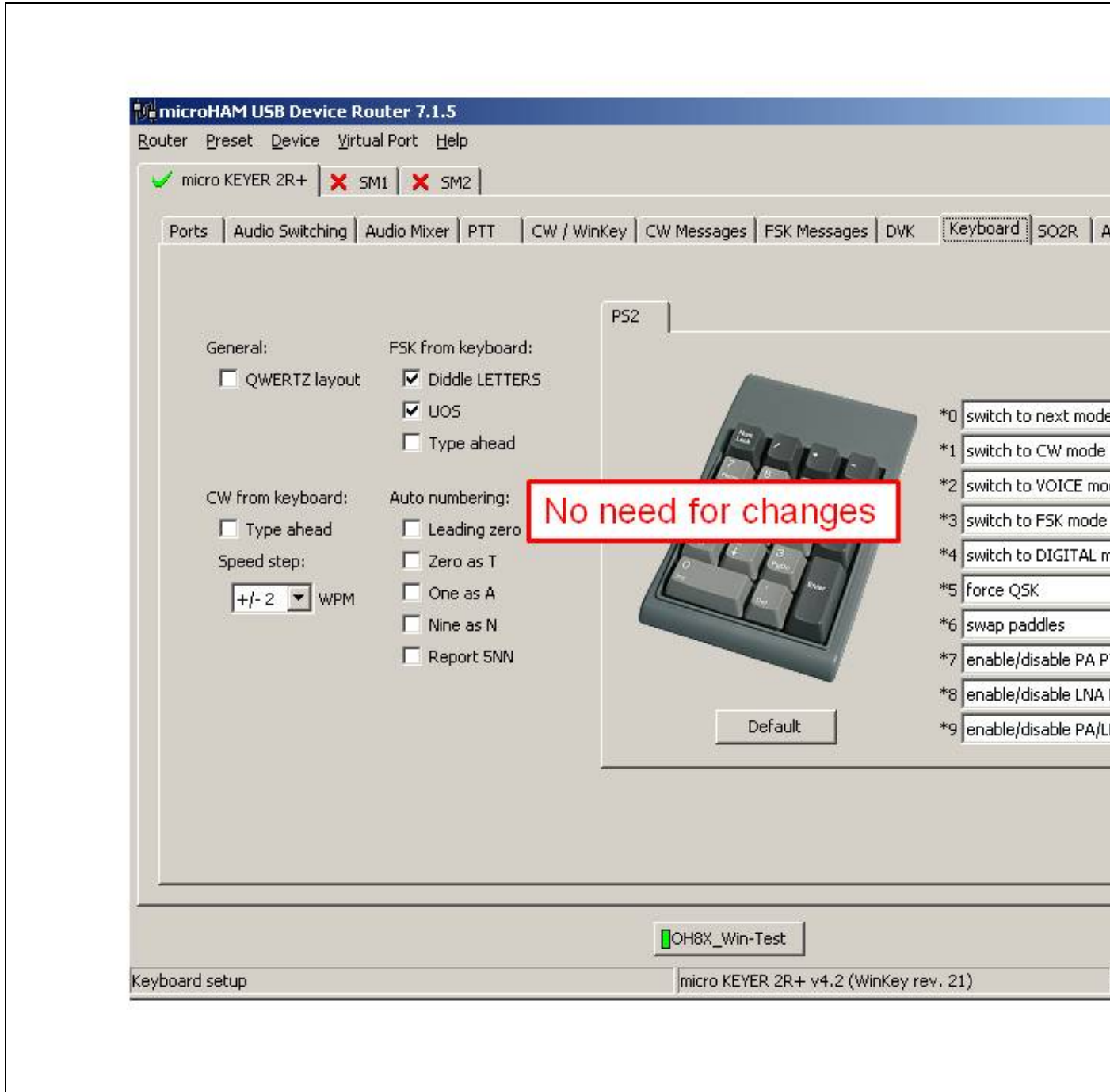

Keyboard setting

**Device Router SO2R Behaviour setting**

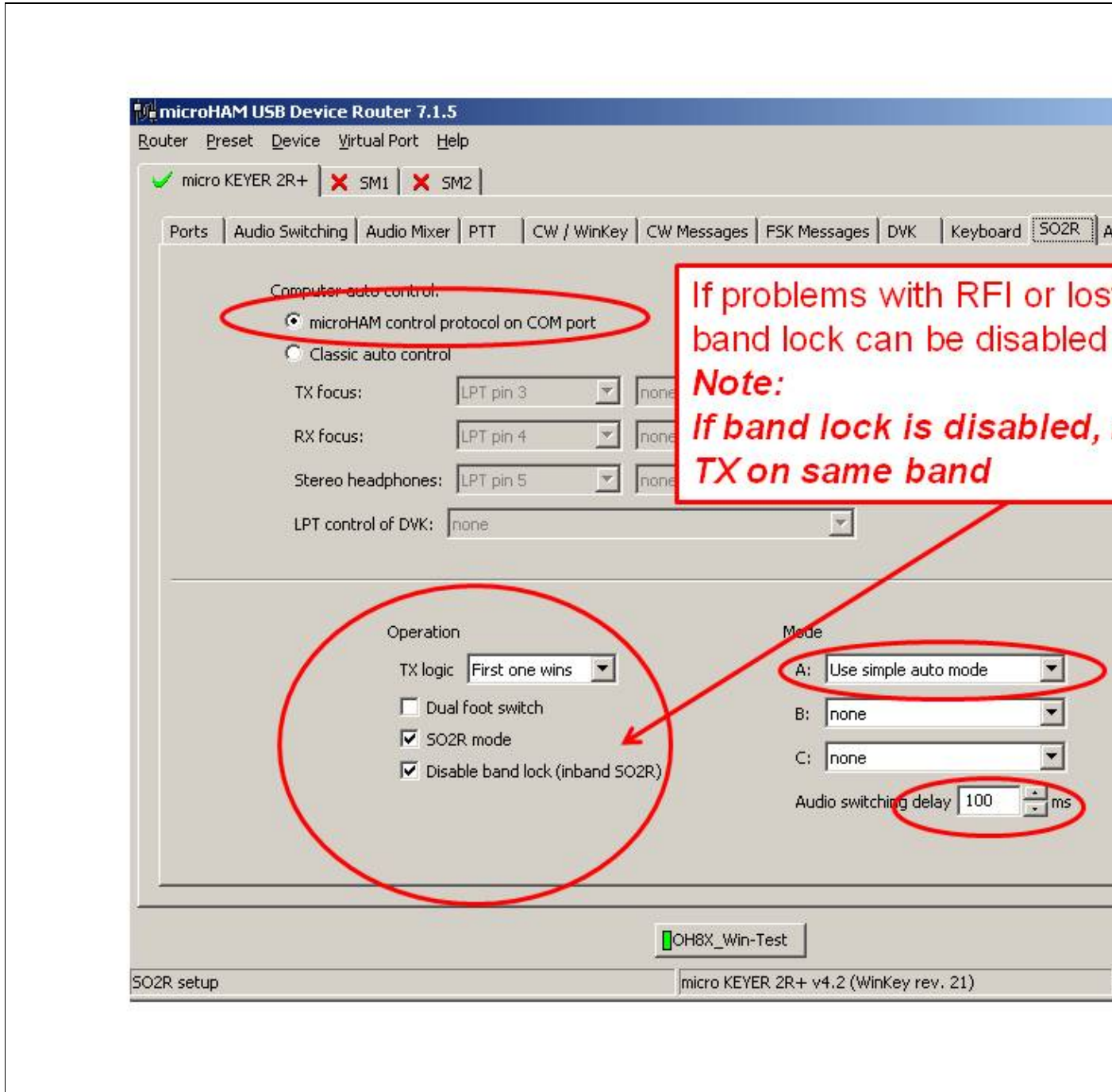

SO2R Behaviour setting

**Device Router ACC port setting**

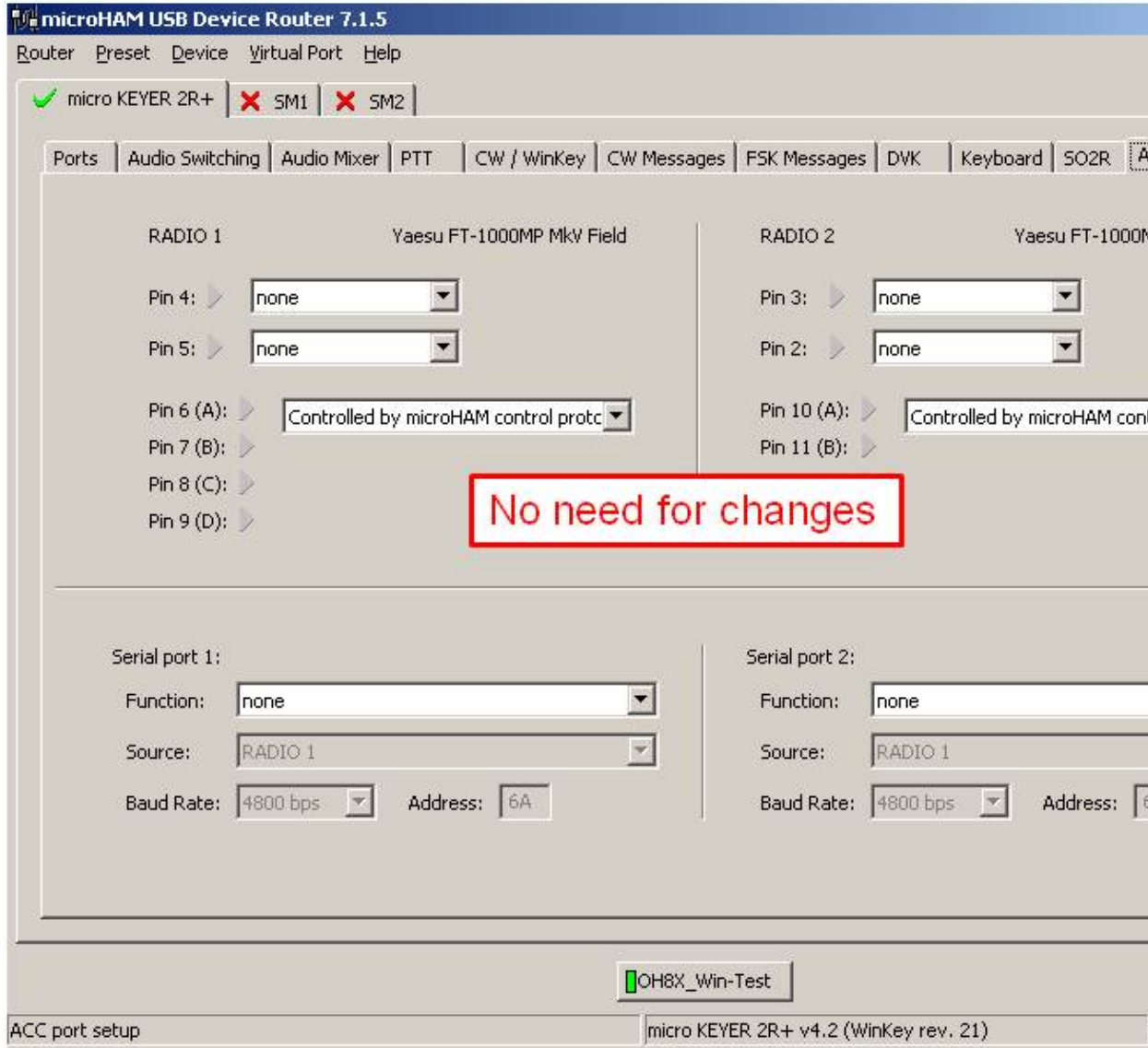

ACC port setting

### Device Router SO2R Audio switching setting

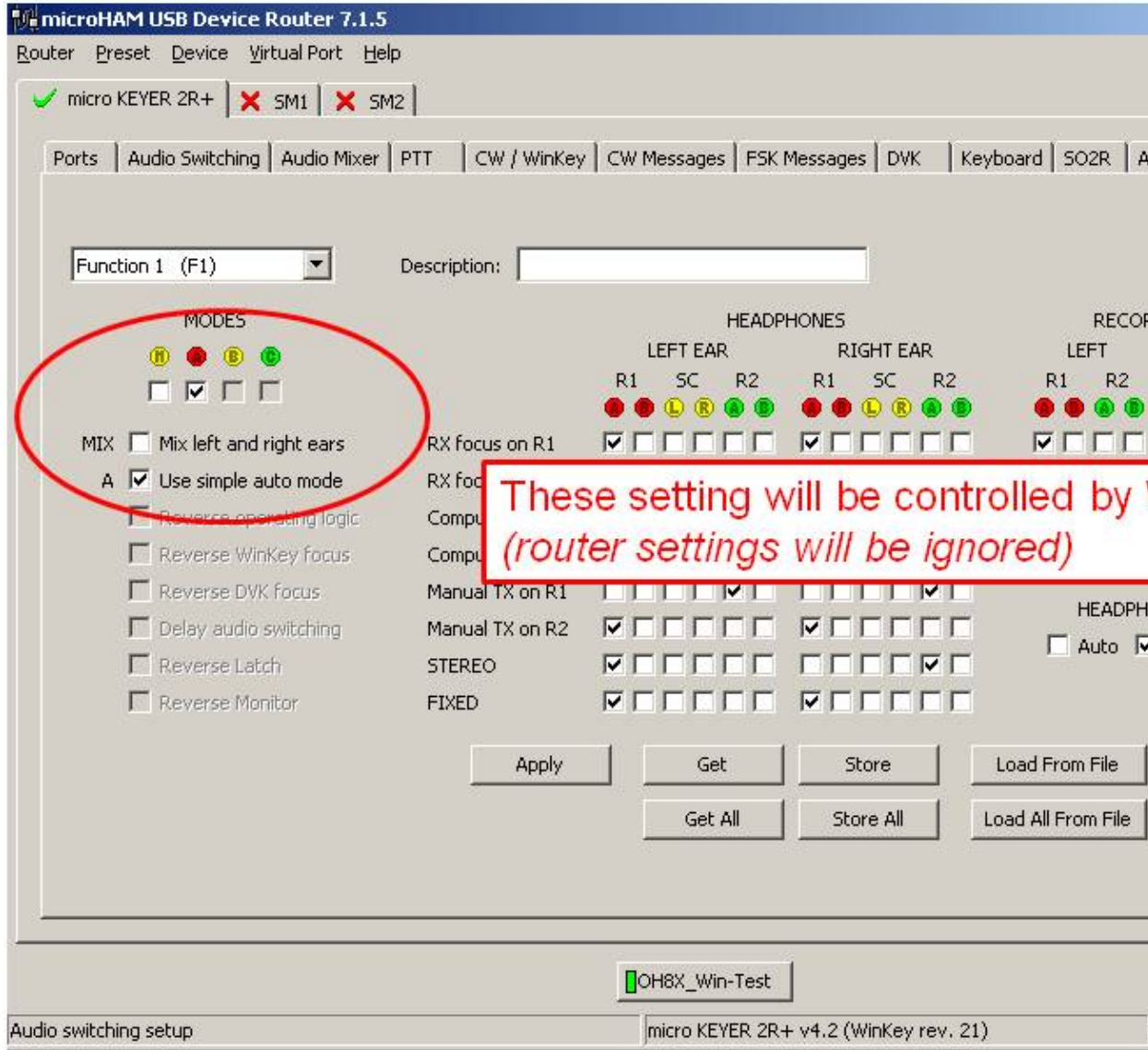

SO2R Audio switching setting

### Device Router **SAVE** your setting

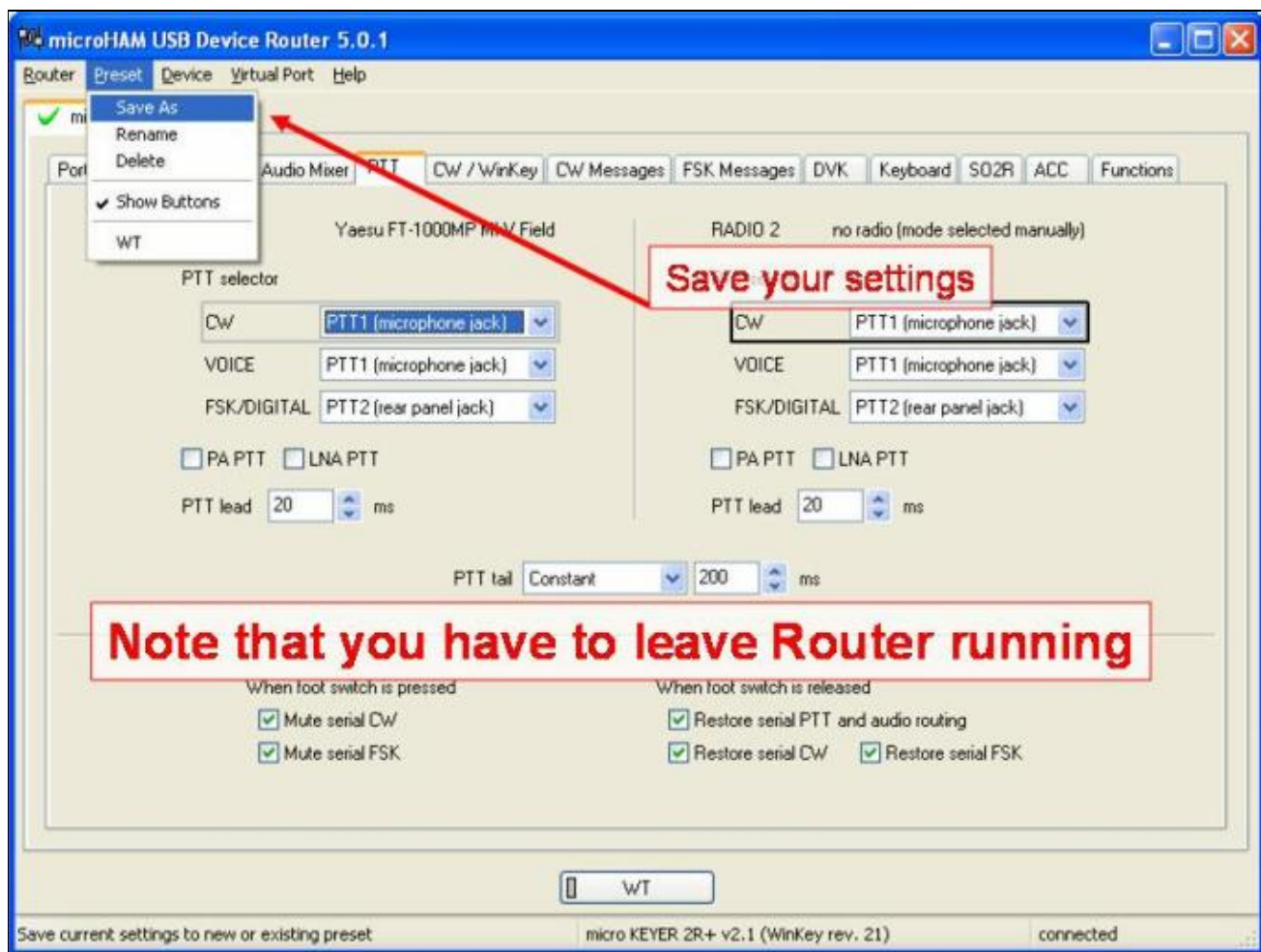

SAVE your setting

### Device Router Overall Device setting view

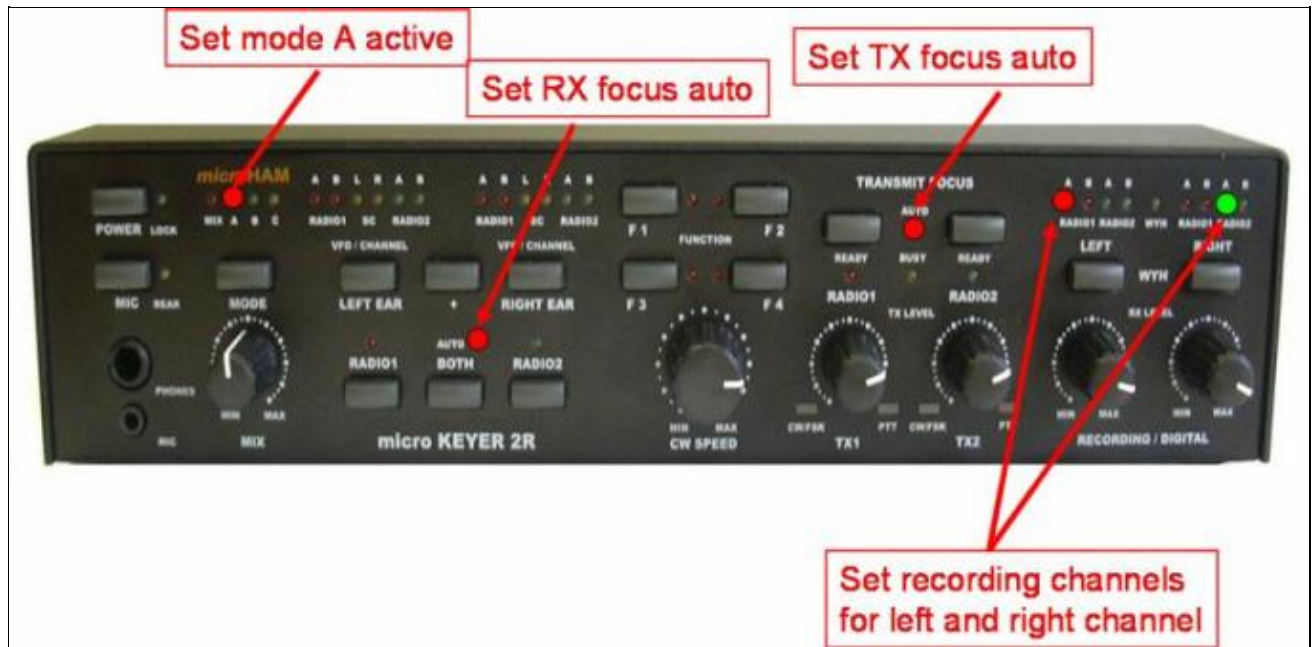

Overall Device setting view

### Device Router set Win-Test Interfaces configuration



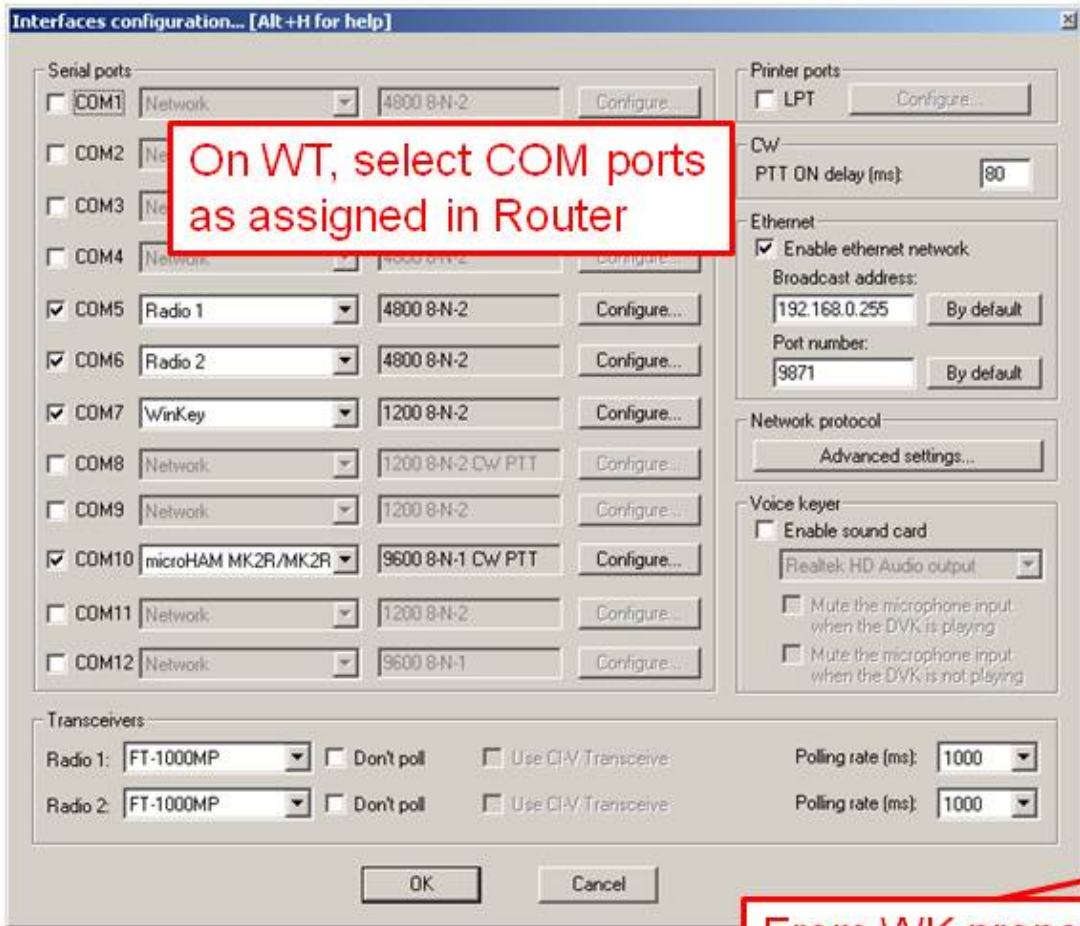

On WT, select COM ports as assigned in Router

From WK properties select indendent speed to keep WT and WK in sync.

Win-Test Interfaces configuration

## See also

### External sources

- [microHAM MK2R/MK2R+ and Win-Test setup guide](#) - PDF document
- [microHAM logger integration page](#)
- [microHAM web site](#)

### Namespaces

- [Page](#)
- [Discussion](#)

### Variants

### Views

- [Read](#)
- [View source](#)
- [View history](#)

### More

- This page was last edited on 12 September 2013, at 14:24.

- [Privacy policy](#)
- [About Win-Test Wiki](#)
- [Disclaimers](#)



# SO2R/MK2R

From Win-Test Wiki

(Redirected from [SO2R/MK2R/Setup](#))

[Jump to navigation](#) [Jump to search](#)

## Contents

- [1 Setting up the MK2R for use with Win-Test](#)
  - ◆ [1.1 Setting up the technique](#)
  - ◆ [1.2 Setting up the \[Shift\] key for secondary radio](#)
  - ◆ [1.3 Setting up the \[Caps Lock\] key for secondary radio](#)
  - ◆ [1.4 Setting the SO2R Control box](#)
    - ◇ [1.4.1 Device Router COM ports creation](#)
    - ◇ [1.4.2 Device Router COM ports setting](#)
    - ◇ [1.4.3 Device Router Audio Switching setting](#)
    - ◇ [1.4.4 Device Router Audio Mixer volume setting](#)
    - ◇ [1.4.5 Device Router PTT and FSK setting](#)
    - ◇ [1.4.6 Device Router Internal CW Keyer setting](#)
    - ◇ [1.4.7 Device Router CW Messages setting](#)
    - ◇ [1.4.8 Device Router FSK Messages setting](#)
    - ◇ [1.4.9 Device Router DVK Voice Messages setting](#)
    - ◇ [1.4.10 Device Router Keyboard setting](#)
    - ◇ [1.4.11 Device Router SO2R Behaviour setting](#)
    - ◇ [1.4.12 Device Router ACC port setting](#)
    - ◇ [1.4.13 Device Router SO2R Audio switching setting](#)
    - ◇ [1.4.14 Device Router SAVE your setting](#)
    - ◇ [1.4.15 Device Router Overall Device setting view](#)
    - ◇ [1.4.16 Device Router set Win-Test Interfaces configuration](#)
- [2 See also](#)
  - ◆ [2.1 External sources](#)

## Setting up the MK2R for use with Win-Test

Advanced SO2R mode and setting up scenarios requires external SO2R control equipment of the last generation, communicating with Win-Test via a USB port. MK2R from MicroHAM has this possibility.

### Setting up the technique

The user must check in the menu `Operating | Technique | Advanced SO2R`.

### Setting up the [Shift] key for secondary radio

The user must check in the menu `Operating | Shift binds to the secondary radio`.

### Setting up the [Caps Lock] key for secondary radio

The user must check in the menu `Operating | Caps Lock binds to the secondary radio`.

## Setting the SO2R Control box

Shown below are screen shots of a step-by-step setup procedure.

### Device Router COM ports creation

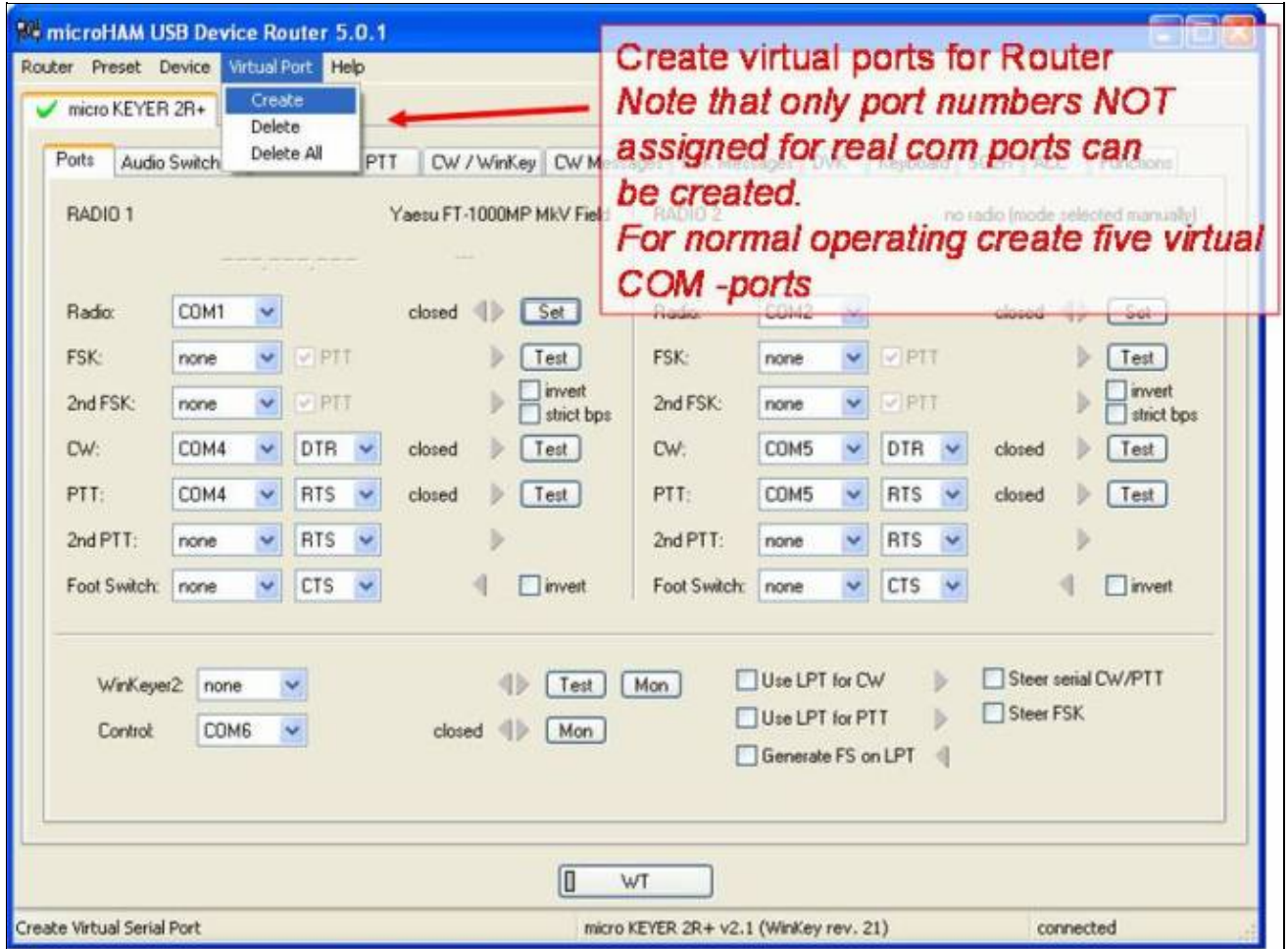

COM ports creation

**Device Router COM ports setting**

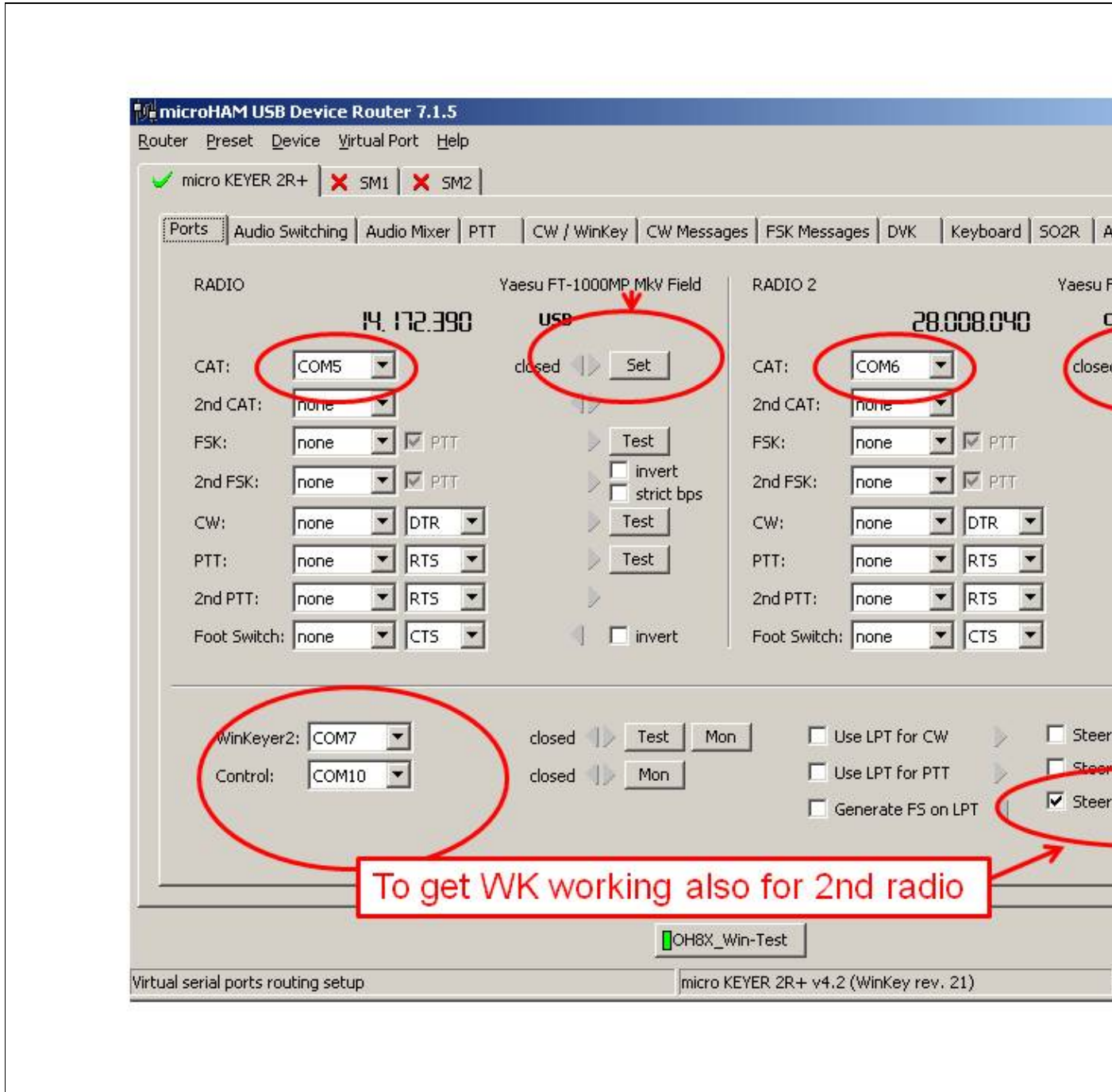

COM port setting

Device Router Audio Switching setting

The screenshot shows the 'microHAM USB Device Router 7.1.5' software interface. At the top, there are menu options: Router, Preset, Device, Virtual Port, and Help. Below the menu, there are status indicators for 'micro KEYER 2R+' (checked), 'SM1' (unchecked), and 'SM2' (unchecked). The main interface is divided into sections for 'Radio 1' and 'Radio 2'. Each radio section has a 'VOICE CODEC (SC1)' and a 'RADIO' section. The 'VOICE CODEC (SC1)' section includes 'OUTPUT' and 'MIC INPUT' labels with red arrows indicating signal flow. The 'RADIO' section includes 'REAR AUDIO' and 'FRONT MIC' labels, a radio icon, and a 'VOX or command PTT' checkbox. To the right of the radio sections, there are radio buttons labeled 'A', 'B', and 'C'. Below the radio sections, there is a 'Digital' section with a 'VOICE/DIGITAL' dropdown menu set to 'Select by f...'. A red box with white text is overlaid on the interface, containing the text: 'May be problem on 40M SSB, Either select voice settings or modify digital band map for SSB contests'. At the bottom of the interface, there is a status bar with 'OH8X\_Win-Test' and 'Microphone, sound card & Radio routing setup'.

microHAM USB Device Router 7.1.5

Router Preset Device Virtual Port Help

micro KEYER 2R+ SM1 SM2

Ports Audio Switching Audio Mixer PTT CW / WinKey CW Messages FSK Messages DVK Keyboard SO2R A

Radio 1 Radio 2

**VOICE CODEC (SC1)** **RADIO**

OUTPUT REAR AUDIO

MIC INPUT FRONT MIC

VOX or command PTT

**VOICE CODEC (SC1)** **RADIO**

OUTPUT REAR AUDIO

MIC INPUT FRONT MIC

COM port or WinKey PTT

Audio switching

CW AAA, voice

VOICE CmCmA, v

FSK/DIGITAL BBB, audio

VOICE/DIGITAL: Select by f

Digital

Use line out c

Left

e tone: none

OH8X\_Win-Test

Microphone, sound card & Radio routing setup

micro KEYER 2R+ v4.2 (WinKey rev. 21)

May be problem on 40M SSB,  
Either select voice settings or modify  
digital band map for SSB contests

audio switching setting

### Device Router Audio Mixer volume setting

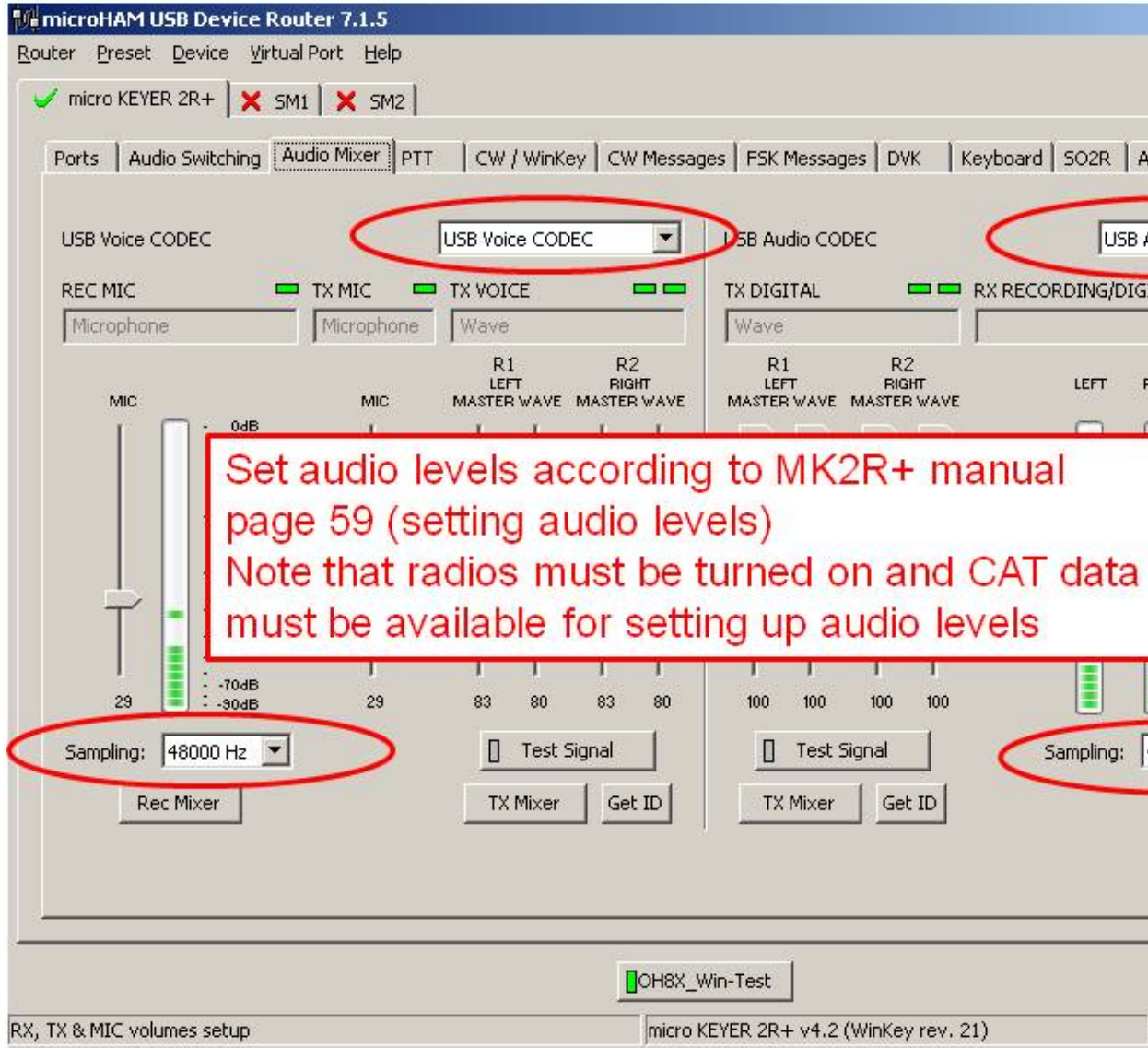

Audio Mixer volume setting

### Device Router PTT and FSK setting

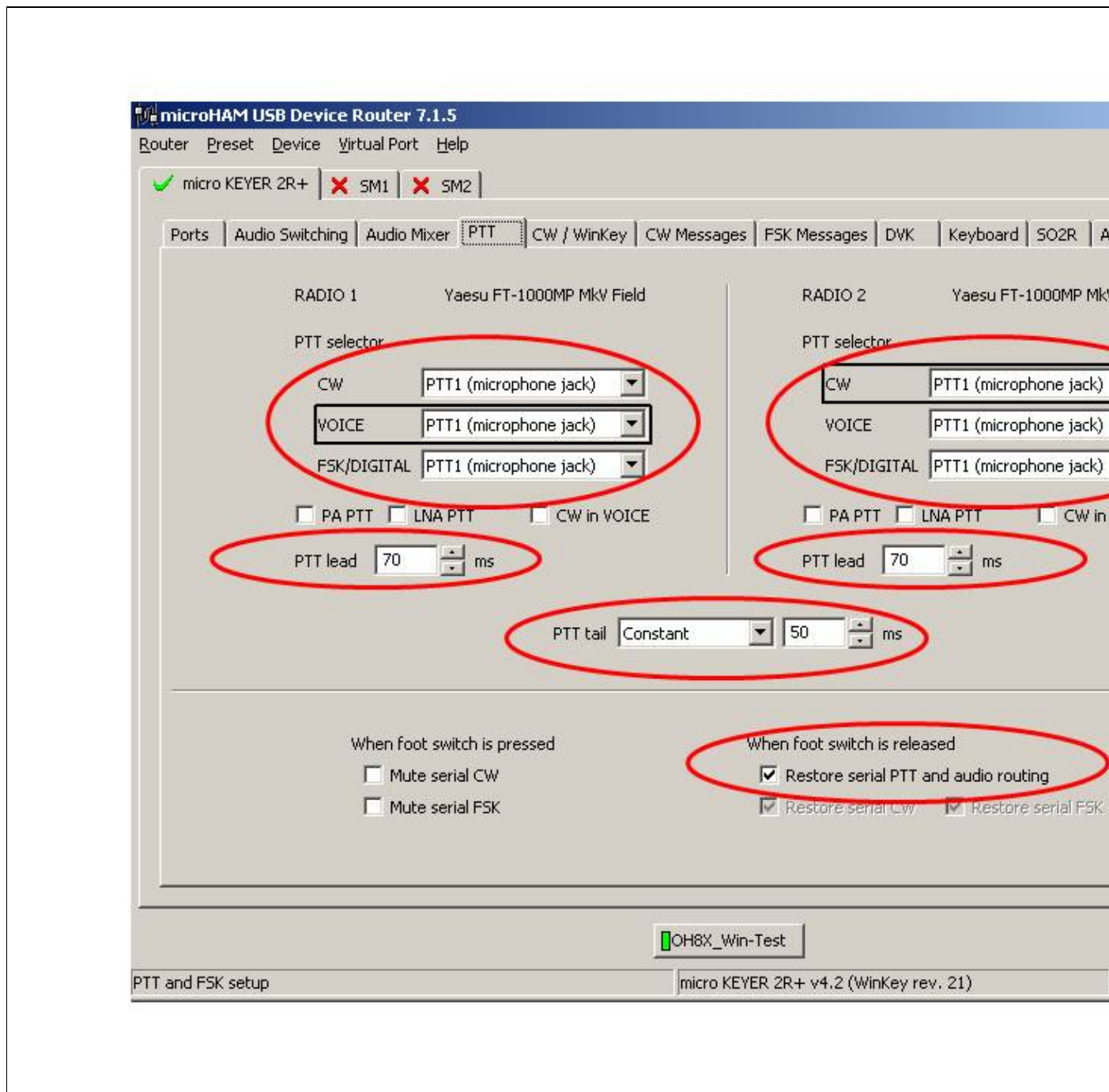



PTT and FSK setting

### Device Router Internal CW Keyer setting

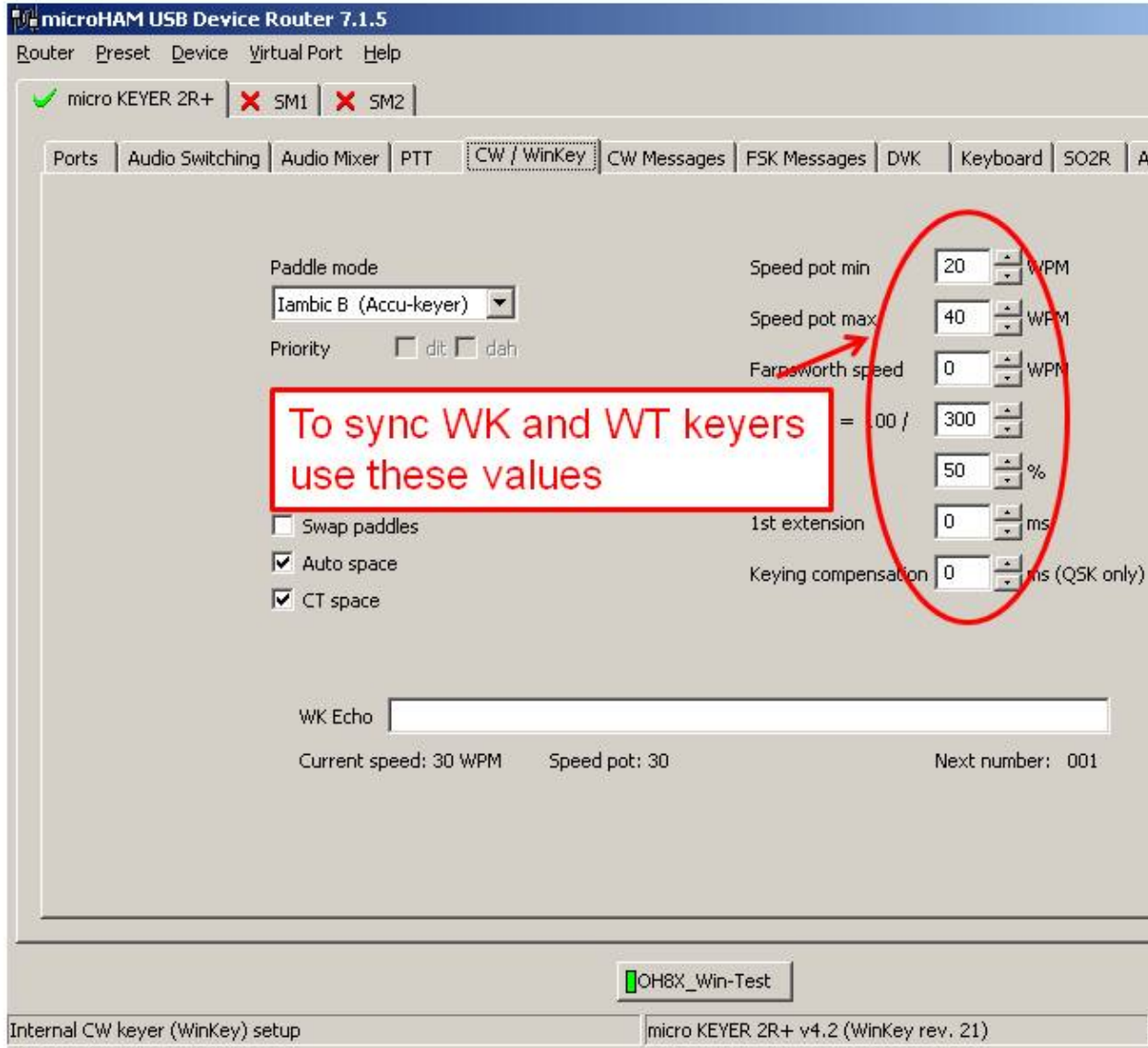

Internal CW Keyer setting

### Device Router CW Messages setting

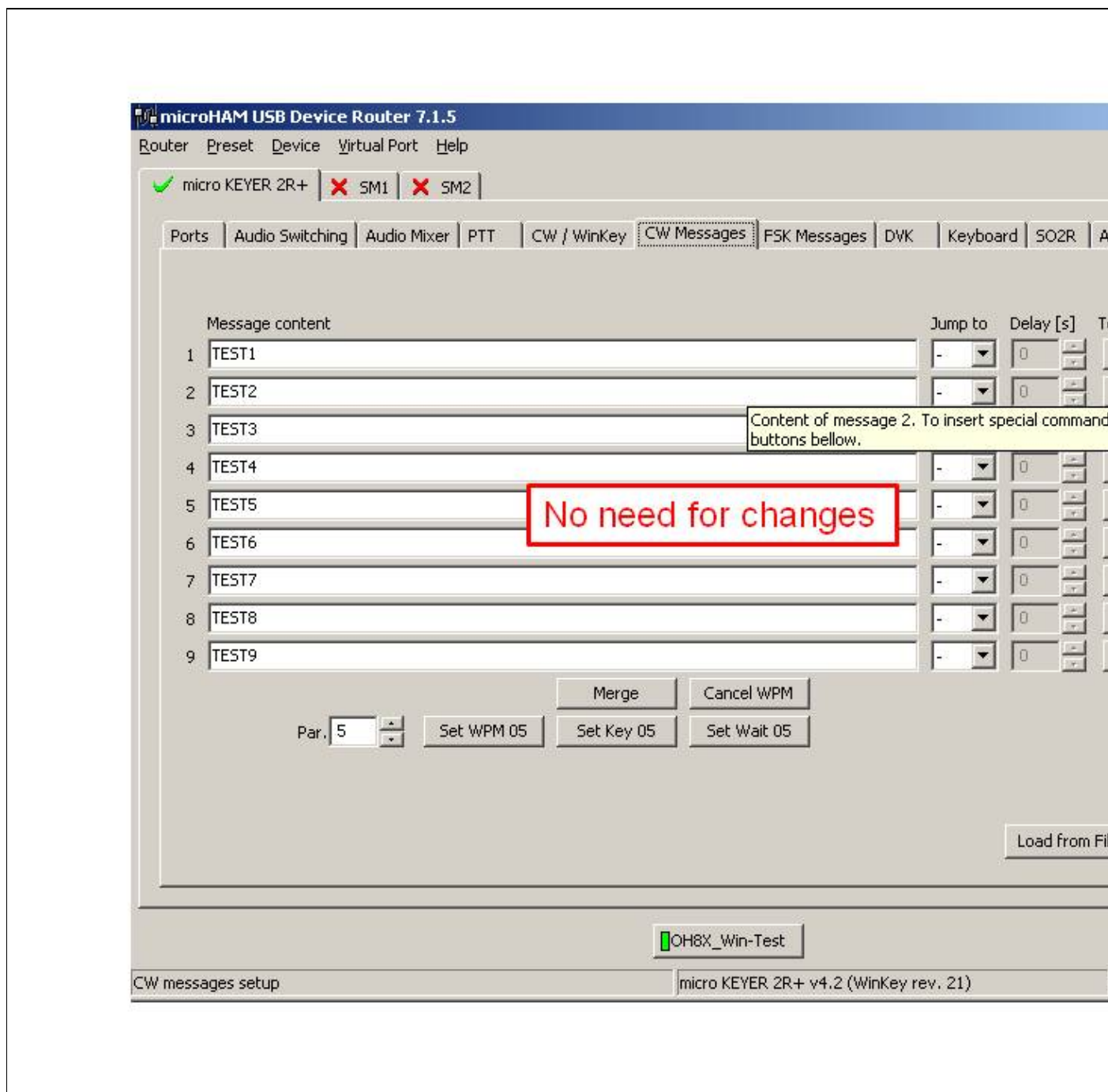

CW Messages setting

**Device Router FSK Messages setting**

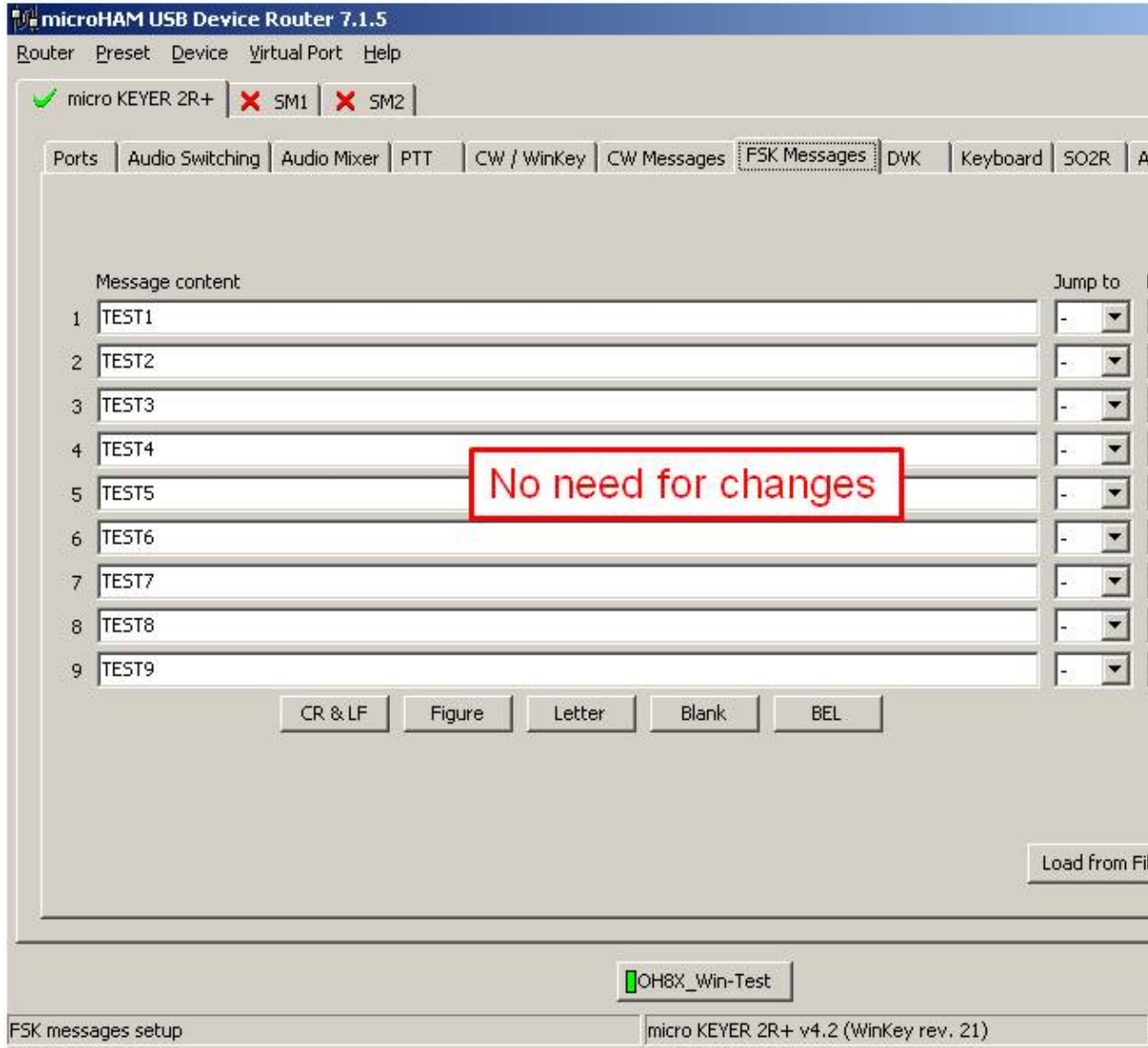

FSK Messages setting

**Device Router DVK Voice Messages setting**



DVK Voice Messages setting  
**Device Router Keyboard setting**

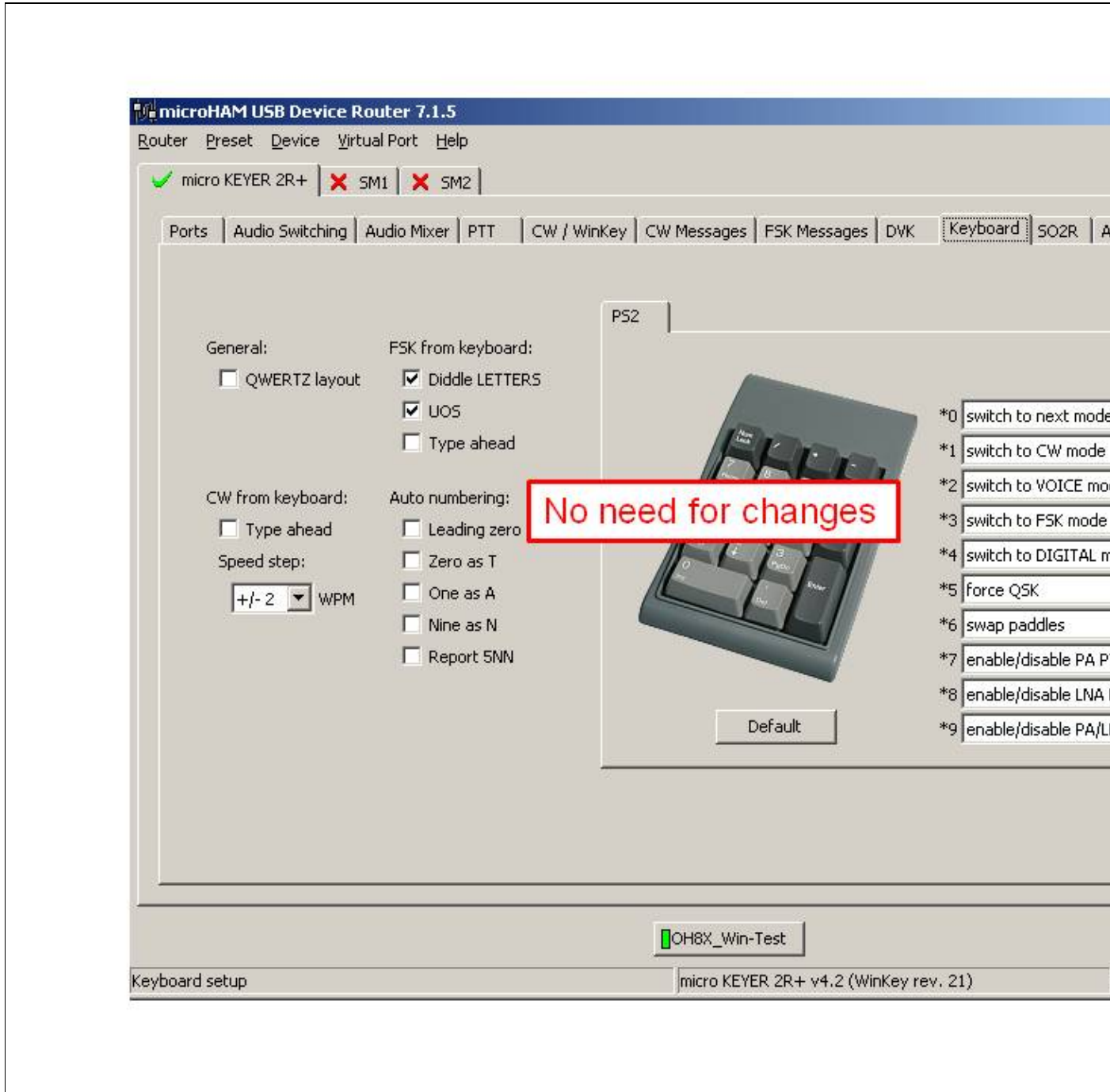

Keyboard setting

**Device Router SO2R Behaviour setting**

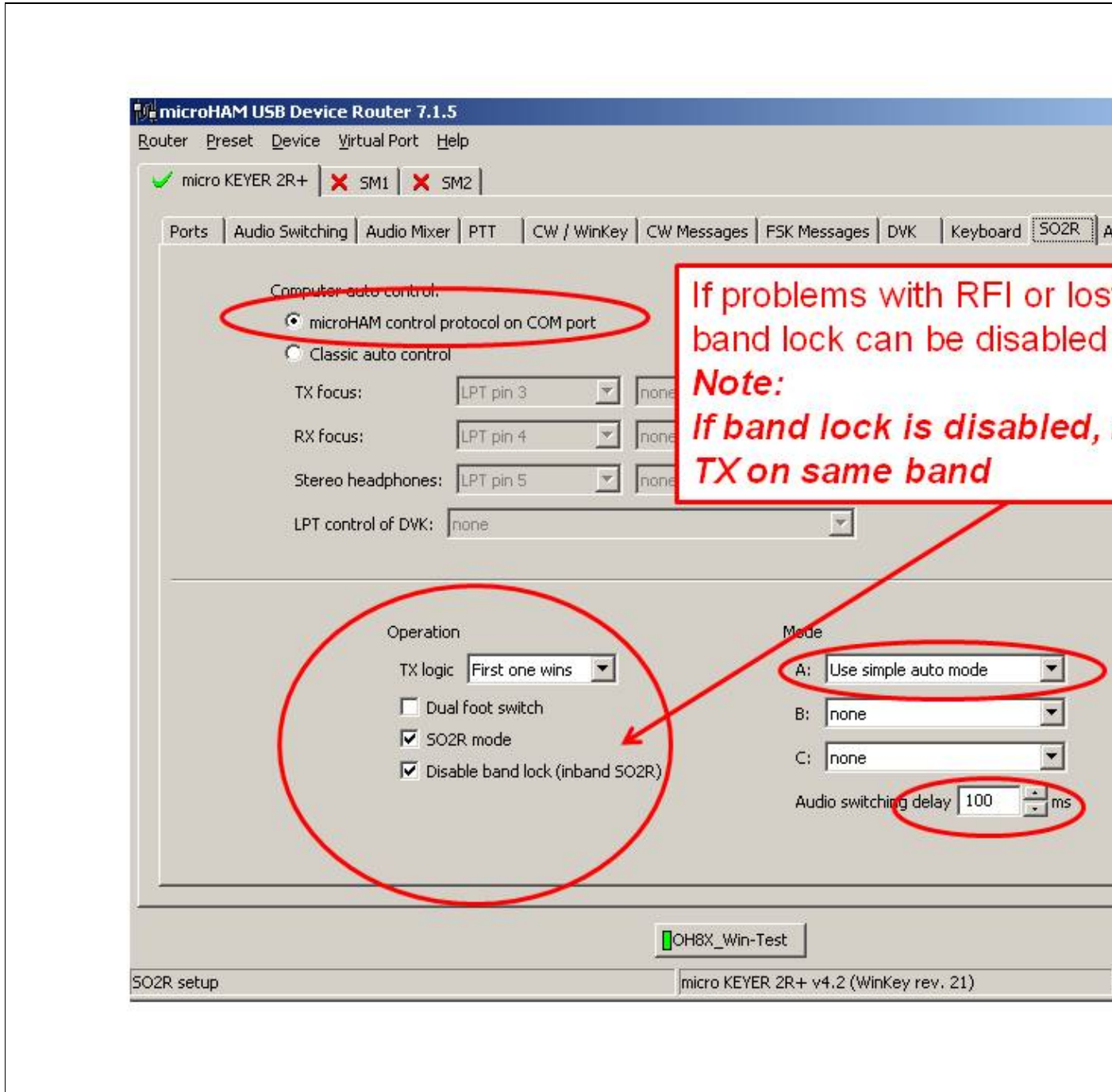

SO2R Behaviour setting

**Device Router ACC port setting**

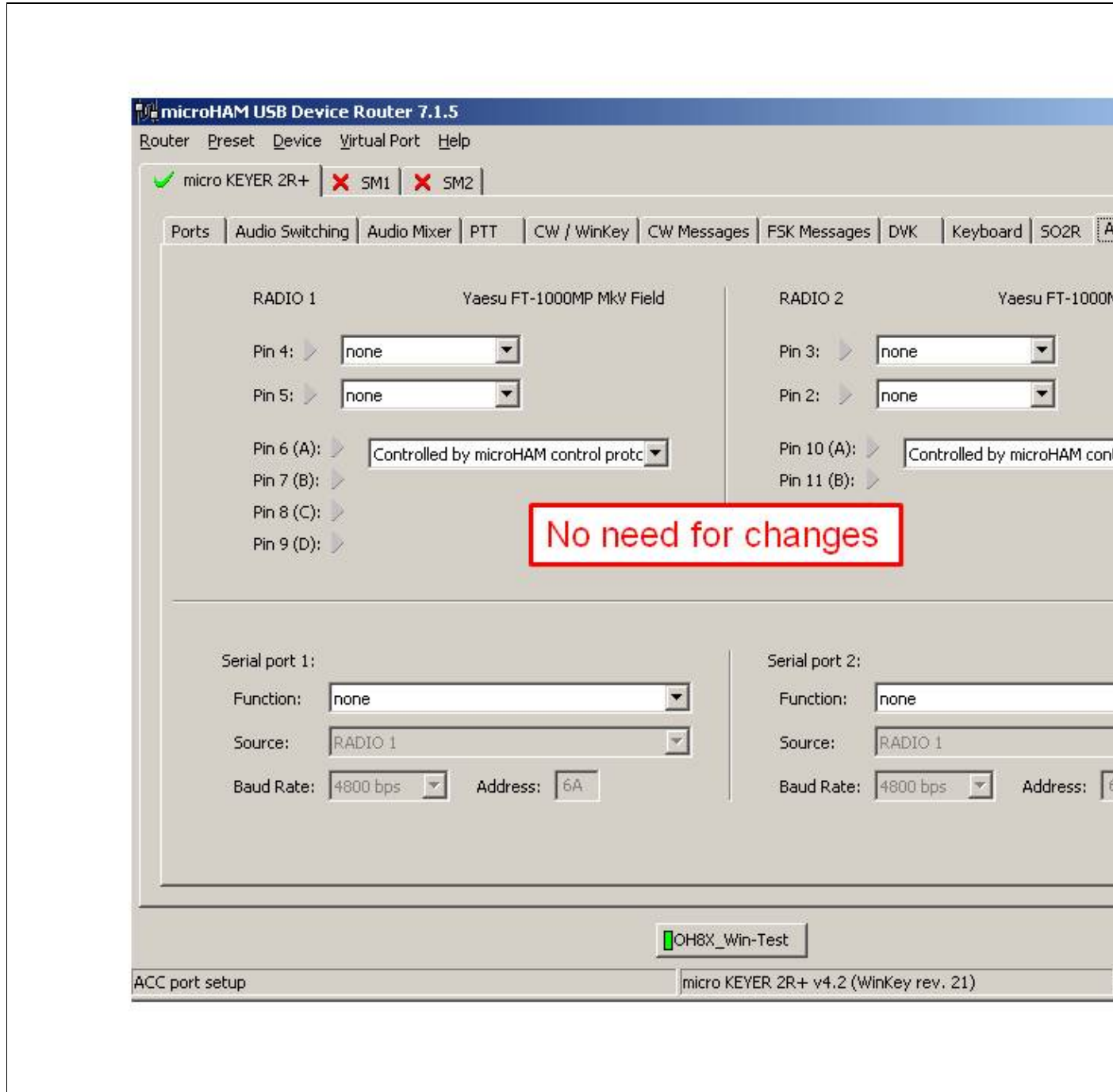

ACC port setting

### Device Router SO2R Audio switching setting

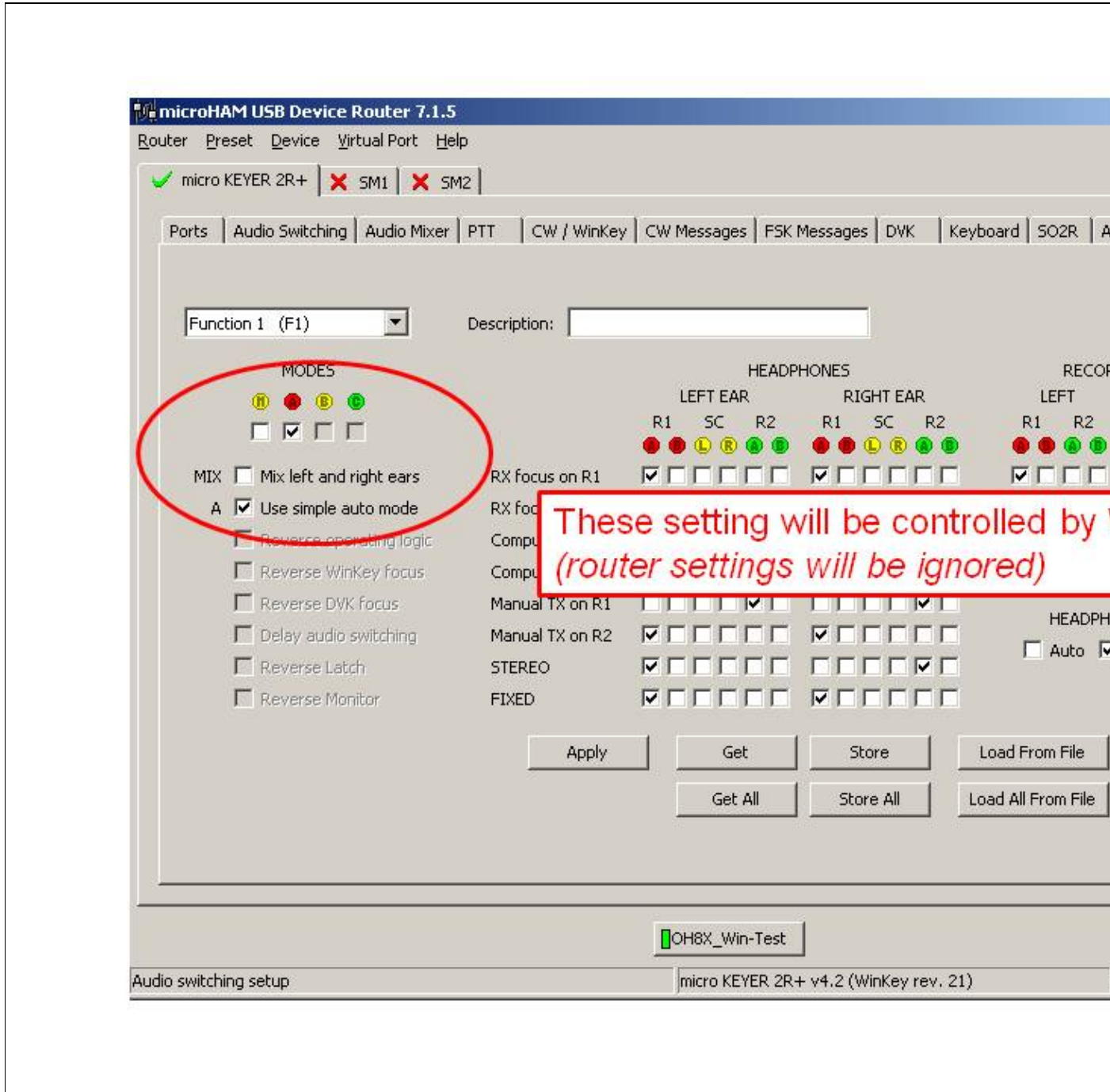



SO2R Audio switching setting

**Device Router SAVE your setting**

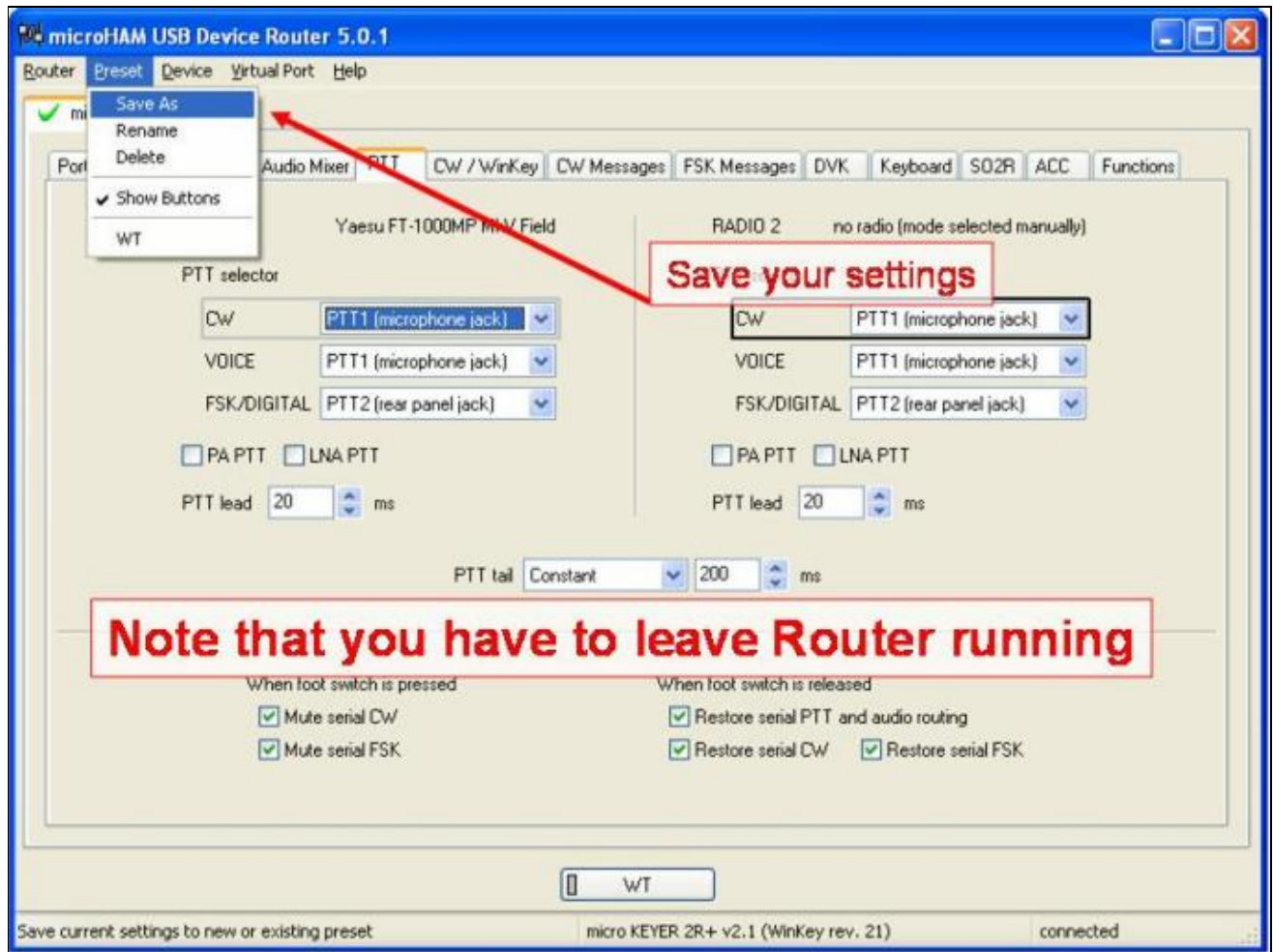

SAVE your setting

### Device Router Overall Device setting view

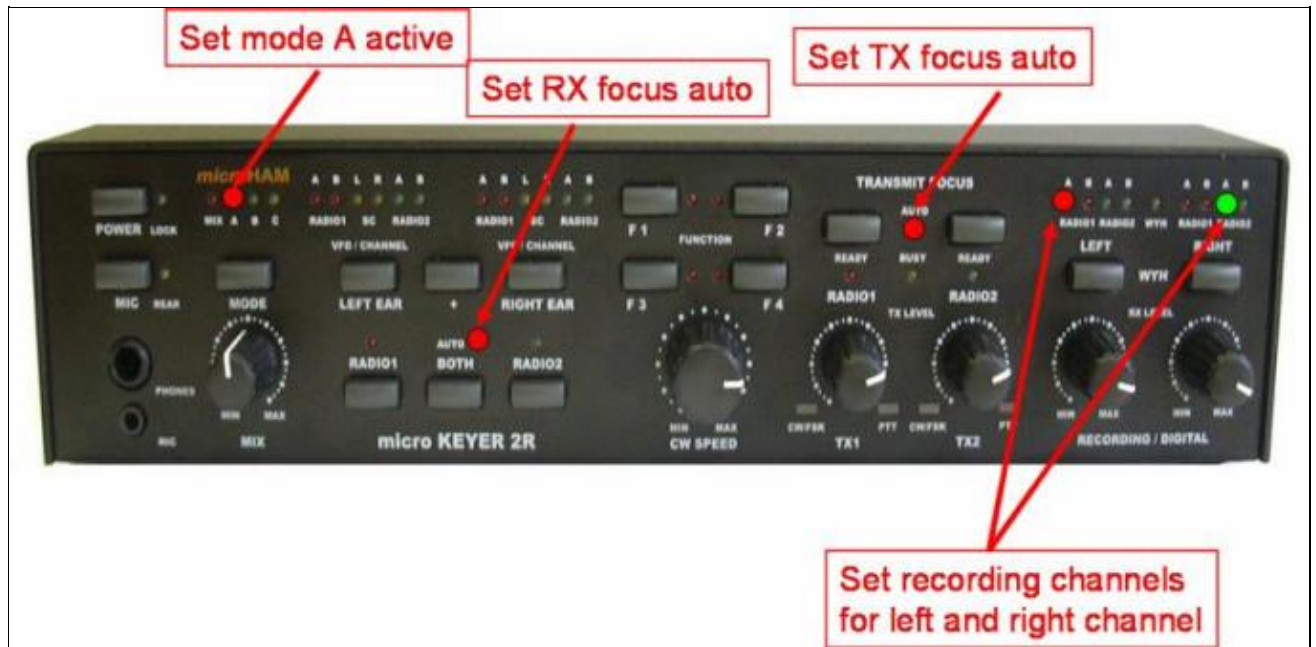

Overall Device setting view

### Device Router set Win-Test Interfaces configuration

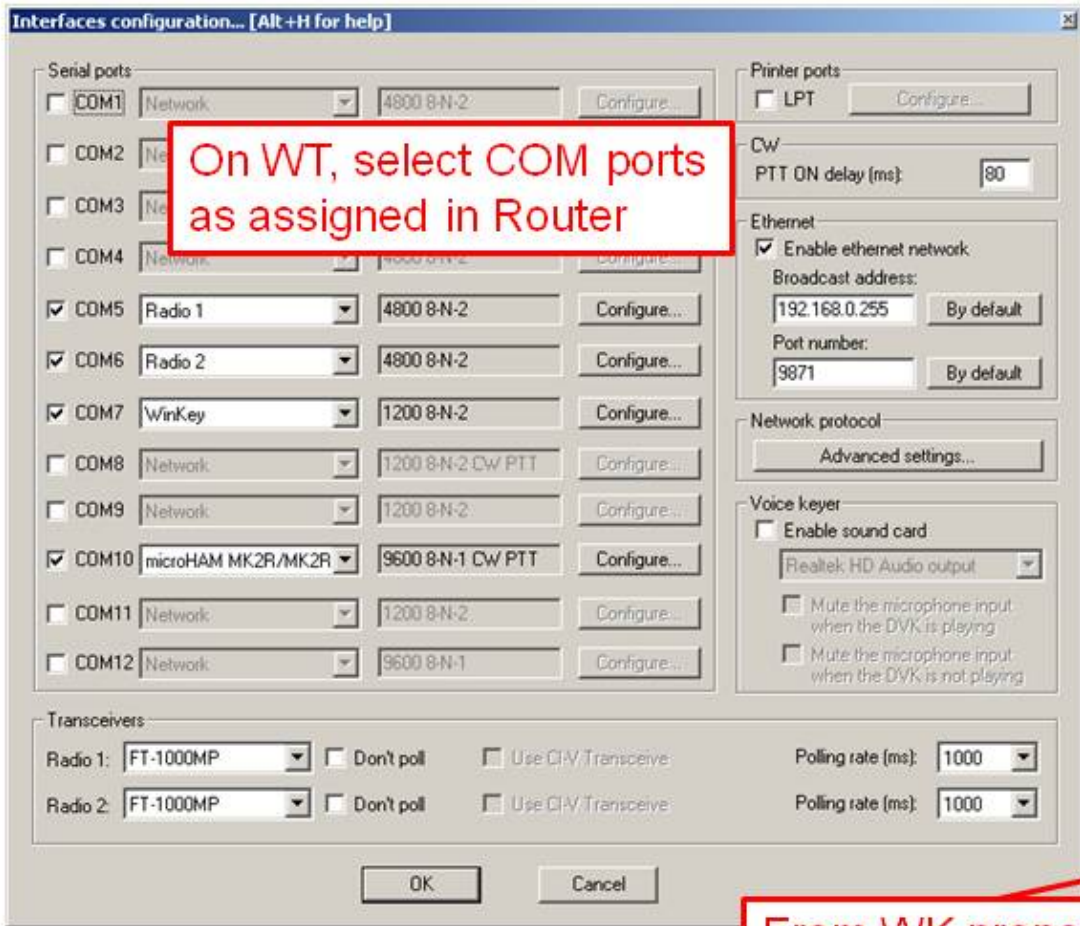

On WT, select COM ports as assigned in Router

From WK properties select indendent speed to keep WT and WK in sync.

Win-Test Interfaces configuration

## See also

### External sources

- [microHAM MK2R/MK2R+ and Win-Test setup guide](#) - PDF document
- [microHAM logger integration page](#)
- [microHAM web site](#)

### Namespaces

- [Page](#)
- [Discussion](#)

### Variants

### Views

- [Read](#)
- [View source](#)
- [View history](#)

### More

- This page was last edited on 12 September 2013, at 14:24.

- [Privacy policy](#)
- [About Win-Test Wiki](#)
- [Disclaimers](#)



# SO2R/Shift binds second radio

From Win-Test Wiki

[Jump to navigation](#) [Jump to search](#)

When operating SO2R the contester has two radios, two amplifiers, two sets of antennas, but only one computer to log all the QSOs. How to tell the program when typing a call that it belongs to radio1 or to radio2 is the question. Win-Test uses the **[Shift]** key to signal to what radio the callsign belongs to. This is a clever way for the operator on the fly put callsigns into the primary radio or the secondary radio.

In order to write calls in the callsign field of the secondary radio tick first in the menu `Operating | Shift binds to the secondary radio.`

Imagine radio 1 is the primary radio being used to RUN and radio 2 is secondary radio being used to S&P. The operator spots a new multiplier on radio 2. In order to put the call in the callsign field, the operator must press the **[Shift]** key while typing the call. If the operator does not press the **[Shift]** key then the call will go into the primary radio callsign field.

It should be noted that the operator must redefine the number keys (1, 2, ..., 0) above the letters in the keyboard for correct behaviour with the **[Shift]** key. On a standard QWERTY keyboard, ! must be redefined as 1, " must be redefined as 2, # must be redefined as 3, \$ must be defined as 4, etc.

In order to redefine the numbers 1, 2, ..., 0 to work while pushing the **[Shift]** key, go to menu `Tools | Redefine keyboards keys` and click **Add**. When the program asks "type on the key to redefine" push **[Shift]** and number 1 together, when the program asks "type on the new key", push number 1. Do the same procedure for all the numbers above the letters in the keyboard.

## Special issues

Pay attention when the / key becomes redefined as 7. In this case the user should find another unused key to redefine it as /, or to use the / key in the numeric keypad, in order to be able to type the / key on either the Primary or the Secondary Radio log entry window!

Please also note that, for some SO2R configurations, when the "Shift binds to the secondary radio" is active, you have to use **[AltGr+Fx]** or **[Ctrl-Alt-Fx]** to edit the CW/RTTY standard messages, since the **[Shift-Fx]** will send (transmit) the characters associated with the **[Fx]** key to the Secondary radio instead.

Note that this feature is only available while selecting the SO2R operating technique.

## Namespaces

- [Page](#)
- [Discussion](#)

## Variants

## Views

- [Read](#)
- [View source](#)
- [View history](#)

## More

- This page was last edited on 15 August 2008, at 12:58.

- [Privacy policy](#)
- [About Win-Test Wiki](#)
- [Disclaimers](#)



# SO2R/Shift binds second radio

From Win-Test Wiki

[Jump to navigation](#) [Jump to search](#)

When operating SO2R the contester has two radios, two amplifiers, two sets of antennas, but only one computer to log all the QSOs. How to tell the program when typing a call that it belongs to radio1 or to radio2 is the question. Win-Test uses the **[Shift]** key to signal to what radio the callsign belongs to. This is a clever way for the operator on the fly put callsigns into the primary radio or the secondary radio.

In order to write calls in the callsign field of the secondary radio tick first in the menu `Operating | Shift binds to the secondary radio.`

Imagine radio 1 is the primary radio being used to RUN and radio 2 is secondary radio being used to S&P. The operator spots a new multiplier on radio 2. In order to put the call in the callsign field, the operator must press the **[Shift]** key while typing the call. If the operator does not press the **[Shift]** key then the call will go into the primary radio callsign field.

It should be noted that the operator must redefine the number keys (1, 2, ..., 0) above the letters in the keyboard for correct behaviour with the **[Shift]** key. On a standard QWERTY keyboard, ! must be redefined as 1, " must be redefined as 2, # must be redefined as 3, \$ must be defined as 4, etc.

In order to redefine the numbers 1, 2, ..., 0 to work while pushing the **[Shift]** key, go to menu `Tools | Redefine keyboards keys` and click **Add**. When the program asks "type on the key to redefine" push **[Shift]** and number 1 together, when the program asks "type on the new key", push number 1. Do the same procedure for all the numbers above the letters in the keyboard.

## Special issues

Pay attention when the / key becomes redefined as 7. In this case the user should find another unused key to redefine it as /, or to use the / key in the numeric keypad, in order to be able to type the / key on either the Primary or the Secondary Radio log entry window!

Please also note that, for some SO2R configurations, when the "Shift binds to the secondary radio" is active, you have to use **[AltGr+Fx]** or **[Ctrl-Alt-Fx]** to edit the CW/RTTY standard messages, since the **[Shift-Fx]** will send (transmit) the characters associated with the **[Fx]** key to the Secondary radio instead.

Note that this feature is only available while selecting the SO2R operating technique.

## Namespaces

- [Page](#)
- [Discussion](#)

## Variants

## Views

- [Read](#)
- [View source](#)
- [View history](#)

## More

- This page was last edited on 15 August 2008, at 12:58.

- [Privacy policy](#)
- [About Win-Test Wiki](#)
- [Disclaimers](#)





# Multi-op/Status window

From Win-Test Wiki

[Jump to navigation](#) [Jump to search](#)

The status window is very important in a multi-op situation. It shows the frequencies of all stations on the network.

## Understanding the status window

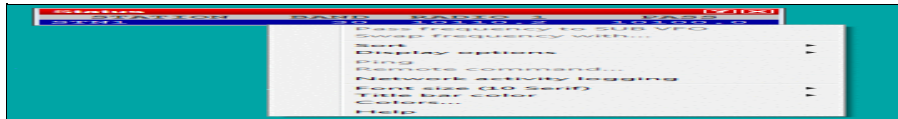

There are various important information shown in the status window:

- STATION shows the unique identifier for each station (set when you [create/open a log](#))
- BAND is a 'at a glance' display of the frequency/mode of the station (e.g. 20 CW)
- TYPE is the station type - i.e. Run, Support, Mult 1, Mult 2 etc... (See the [Commands | Station type](#) menu option for the Type values and how to set them)
- QSY FREQ is the frequency set for [passing multipliers](#)
- RADIO 1 is the current frequency of the radio
- QSY informs you whether a QSY is acceptable or whether you must stay on the current band (e.g. 10-minute rule)

A double-click on a station name opens a private gab window to send a message to the operator of this station only. A double-click on any frequency tunes your radio (assuming it is controlled by CAT) to this frequency.

## Observing the 10-minute rule

### QSY Timers

To cope with the 10-minute rule, Win-Test has a countdown timer, which is started when each station makes the first contact on a new band. The time will start at **10:00** and will count down to zero after which **QSY ok** will be displayed in the status window. The image below demonstrates this.

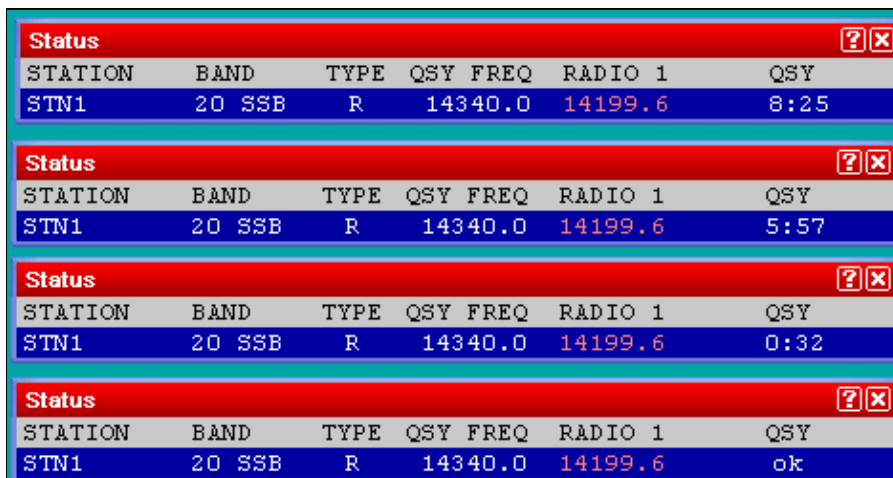

QSY countdown timer sequence for the runner

When **QSY ok** is displayed for your station, you are free to work a QSO on a new band.

QSOs with own callsign are ignored in the timer calculation to allow efficient blanking out of any invalid QSOs.

## Hiding unnecessary information in the status window

You can hide unnecessary information in the status window (e.g. **RADIO 2** etc.) by right-clicking in the status window to open the context menu. By selecting **Display options** you can choose whether to show support stations in the status window list and also whether to show or hide the QSY freq. and the Radio 2 frequency (often not necessary).

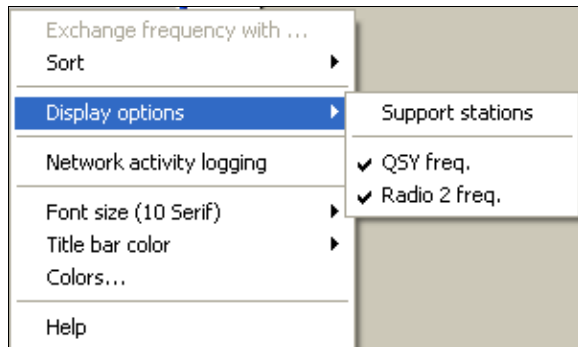

Status window context menu

## See also

- [Passing multipliers in a multi-op situation](#)

## Namespaces

- [Page](#)
- [Discussion](#)

## Variants

## Views

- [Read](#)
- [View source](#)
- [View history](#)

## More

- This page was last edited on 17 December 2016, at 17:29.
- [Privacy policy](#)
- [About Win-Test Wiki](#)
- [Disclaimers](#)



# StyleSheet

From Win-Test Wiki

[Jump to navigation](#) [Jump to search](#)

This article is designed to be a guideline for authors to accomplish reasonable consistency when editing articles featured on the Wiki-based Win-Test documentation.

The project was originally started by Simon Pearson, M0CLW, as an additional source of information for Win-Test users. As time progressed, more users began contributing, each of them with slightly different ideas and editing know-how. So we found it's time for a style guide as this documentation will finally grow into a complete reference manual that will - hopefully - be included with the Win-Test software distribution in the near future, thus replacing the slightly outdated reference manual.

The guideline itself is an example how to format text, commands, function keys, screenshots and how to structure information described in this manual. The current version was agreed among M0CLW, DL4NER and DL6RAI on July 31, 2006. New articles should be formatted accordingly, existing articles should be re-formatted as time permits or whenever they are being worked on.

Note you can click on the 'edit' button at the top of each article/page to view the source code to give you an idea on how things are done.

## Contents

- [1 Language](#)
- [2 Structuring of articles](#)
  - ◆ [2.1 Previewing and summarising your edits](#)
- [3 Menu items](#)
- [4 Text commands](#)
- [5 Keys](#)
- [6 Images](#)
- [7 References](#)
- [8 Notes and Tips](#)

## Language

- Use proper English.
- What's proper should be defined by native speakers.

## Structuring of articles

- Start with a short introduction before starting with the meat of the article.
- The first structure level (i.e. major headings) should use == (i.e. double equal signs). Do **not** use a single equal sign.
- Try to group information into subchapters and subsections so that the reader can easily find what they are looking for, courtesy of the automatically generated table of contents.
- Add a "**See also**" section at the end of the article if you have references.
- At the bottom of the page add a link to the next level up Wiki page. If there is none, there is always the [Main Page](#).

- Do not put pictures on top of the page. The upper part of the page containing the "Table Of Content" will be stripped when generating the pdf manual.

## Previewing and summarising your edits

- It is always recommended you click on the "Show preview" button after making any changes to ensure everything is formatted as expected.
- After you have edited a page, please type a brief summary of your changes in the summary field before clicking on "save page". This helps when looking through the history of a page (by clicking on the "History" button at the top of a page) and when viewing the [recent changes](#).

## Menu items

- Put menu items into `<code></code>` statements.
- If you have a sequence of Menu actions, use the vertical bar "|" to separate these, like this:

```
Options | Load contest at startup | Enabled.
```

The above was created using the following statement:

```
<code>Options | Load contest at startup | Enabled </code>
```

## Text commands

- Use Bold typewriter font and Capitals for all Text commands like **NOSOUND**, **QUIT** and for message variables like **\$MYCALL** and **\$SERIAL**.

## Keys

Most keys should be **bold typewriter text**.

- Type F-keys as **F1**, **F2**
- Control keys: **ctrl-A**
- Alt keys: **Alt-C**, **Alt-W**
- Shift keys: **Shift-F1**, **Shift-F7**
- Editing keys: **[Shift]**, **[Enter]**, **[Insert]**, **[Plus]** or **[+]**, **[Minus]** , **[Backspace]**, **[Delete]**.

## Images

- The windows should come with English titles except for operating system based windows (like the file open dialog).
- Use PNG or GIF format for the pictures. JPEG is normally not suitable for screen captures.
- Center any images and use a frame around every image to include a caption, like this:



N + 1 window (Captured call : W5TQ)

The above was created using the following statement:

```
[[Image:WindowsNp1_1.gif|center|frame|N + 1 window (Captured call : W5TQ)]]
```

## References

- Try to avoid duplicate information spread all over the Wiki. Use cross-references where applicable like [Menu:Edit](#).
- Keep a focus - do not try to explain topics beyond the Win-Test application. Use external references where applicable like [Cabrillo Specs](#).

## Notes and Tips

Be consistent throughout the text and use the **wbox** macro for Notes and Tips.

```
{{wbox|Note|This search only works for contests where ... }}
```

The result will be indented and displayed in a nicely formatted box which catches the eye of the reader:

**Note:** This search only works for contests where ...

[Back to Main Page](#)

## Namespaces

- [Page](#)
- [Discussion](#)

## Variants

## Views

- [Read](#)
- [View source](#)
- [View history](#)

## More

- This page was last edited on 19 December 2009, at 18:40.

- [Privacy policy](#)
- [About Win-Test Wiki](#)
- [Disclaimers](#)



# StyleSheet

From Win-Test Wiki

[Jump to navigation](#) [Jump to search](#)

This article is designed to be a guideline for authors to accomplish reasonable consistency when editing articles featured on the Wiki-based Win-Test documentation.

The project was originally started by Simon Pearson, M0CLW, as an additional source of information for Win-Test users. As time progressed, more users began contributing, each of them with slightly different ideas and editing know-how. So we found it's time for a style guide as this documentation will finally grow into a complete reference manual that will - hopefully - be included with the Win-Test software distribution in the near future, thus replacing the slightly outdated reference manual.

The guideline itself is an example how to format text, commands, function keys, screenshots and how to structure information described in this manual. The current version was agreed among M0CLW, DL4NER and DL6RAI on July 31, 2006. New articles should be formatted accordingly, existing articles should be re-formatted as time permits or whenever they are being worked on.

Note you can click on the 'edit' button at the top of each article/page to view the source code to give you an idea on how things are done.

## Contents

- [1 Language](#)
- [2 Structuring of articles](#)
  - ◆ [2.1 Previewing and summarising your edits](#)
- [3 Menu items](#)
- [4 Text commands](#)
- [5 Keys](#)
- [6 Images](#)
- [7 References](#)
- [8 Notes and Tips](#)

## Language

- Use proper English.
- What's proper should be defined by native speakers.

## Structuring of articles

- Start with a short introduction before starting with the meat of the article.
- The first structure level (i.e. major headings) should use == (i.e. double equal signs). Do **not** use a single equal sign.
- Try to group information into subchapters and subsections so that the reader can easily find what they are looking for, courtesy of the automatically generated table of contents.
- Add a "**See also**" section at the end of the article if you have references.
- At the bottom of the page add a link to the next level up Wiki page. If there is none, there is always the [Main Page](#).



- Do not put pictures on top of the page. The upper part of the page containing the "Table Of Content" will be stripped when generating the pdf manual.

## Previewing and summarising your edits

- It is always recommended you click on the "Show preview" button after making any changes to ensure everything is formatted as expected.
- After you have edited a page, please type a brief summary of your changes in the summary field before clicking on "save page". This helps when looking through the history of a page (by clicking on the "History" button at the top of a page) and when viewing the recent changes.

## Menu items

- Put menu items into `<code></code>` statements.
- If you have a sequence of Menu actions, use the vertical bar "|" to separate these, like this:

Options | Load contest at startup | Enabled.

The above was created using the following statement:

```
<code>Options | Load contest at startup | Enabled </code>
```

## Text commands

- Use Bold typewriter font and Capitals for all Text commands like **NOSOUND**, **QUIT** and for message variables like **\$MYCALL** and **\$SERIAL**.

## Keys

Most keys should be **bold typewriter text**.

- Type F-keys as **F1**, **F2**
- Control keys: **ctrl-A**
- Alt keys: **Alt-C**, **Alt-W**
- Shift keys: **Shift-F1**, **Shift-F7**
- Editing keys: **[Shift]**, **[Enter]**, **[Insert]**, **[Plus]** or **[+]**, **[Minus]** , **[Backspace]**, **[Delete]**.

## Images

- The windows should come with English titles except for operating system based windows (like the file open dialog).
- Use PNG or GIF format for the pictures. JPEG is normally not suitable for screen captures.
- Center any images and use a frame around every image to include a caption, like this:



N + 1 window (Captured call : W5TQ)

The above was created using the following statement:

```
[[Image:WindowsNp1_1.gif|center|frame|N + 1 window (Captured call : W5TQ)]]
```

## References

- Try to avoid duplicate information spread all over the Wiki. Use cross-references where applicable like [Menu:Edit](#).
- Keep a focus - do not try to explain topics beyond the Win-Test application. Use external references where applicable like [Cabrillo Specs](#).

## Notes and Tips

Be consistent throughout the text and use the **wbox** macro for Notes and Tips.

```
{{wbox|Note|This search only works for contests where ... }}
```

The result will be indented and displayed in a nicely formatted box which catches the eye of the reader:

**Note:** This search only works for contests where ...

[Back to Main Page](#)

## Namespaces

- [Page](#)
- [Discussion](#)

## Variants

## Views

- [Read](#)
- [View source](#)
- [View history](#)

## More

- This page was last edited on 19 December 2009, at 18:40.

- [Privacy policy](#)
- [About Win-Test Wiki](#)
- [Disclaimers](#)



# Supported Accessories

From Win-Test Wiki

[Jump to navigation](#) [Jump to search](#)

## Contents

- [1 CW and/or voice keyers](#)
- [2 Band decoders](#)
- [3 CAT interfaces](#)
- [4 Integrated SO2R boxes](#)
  - ◆ [4.1 microHAM MK2R/MK2R+/micro2R](#)
  - ◆ [4.2 YCCC SO2R Box](#)
  - ◆ [4.3 Top Ten Devices DX Doubler](#)
  - ◆ [4.4 Ham Radio Solutions EZMaster](#)
  - ◆ [4.5 W5XD Multi-Keyer](#)

## CW and/or voice keyers

- MFJ: MFJ-432 voice keyer (deprecated)
- MFJ: [MFJ-434 voice keyer](#)  
Needs an interface similar to [this one](#), but doesn't handle the STOP LPT pin (#2). To circumvent this, you can redefine the Escape key to F4 and record a tiny empty message in message associated with the F4 key.
- K1EL: WinKey and WinKey2, standalone or inside an SO2R box. See [Integrated SO2R boxes](#) below for additional notes on using the WinKey inside an MK2R.

## Band decoders

- microHAM: [micro BAND DECODER](#) 

## CAT interfaces

- microHAM: USB II Interface. For some practical examples:
  - ◆ Setting up an Icom IC-746 and a microHAM USB II Interface for contest operation see [BestPractice2](#) chapter.
  - ◆ Setting up a Kenwood TS-850, microHAM USB II Interface, microHAM USB Device Router, MMTTY, ExtFSK and Win-Test to run a RTTY contest see [BestPractice1](#) chapter.
  - ◆ Setting up an Icom IC-275 and a microHAM USB IC Interface for contest operation see [BestPractice3](#) chapter.
  - ◆ Setting up an FT-1000D and a microHAM USB IC Interface for contest operation see [BestPractice6](#) chapter.
- microHam: micro KEYER (MK) and micro KEYER II (MKII).
  - ◆ Setting up a Kenwood TS-850, microHAM microKeyer , microHAM USB Device Router, MMTTY, ExtFSK and Win-Test to run a RTTY contest see [BestPractice4](#) chapter. The same with a MKII, see [BestPractice5](#).
  - ◆ Setting up an ICOM IC-7410 and a microHAM microKeyer II for contest operation see [BestPractice8](#).

- microHAM: USB micro2R (u2R).

## Integrated SO2R boxes

### microHAM MK2R/MK2R+/micro2R

For detailed configuration examples, see [SO2R/MK2R/Setup](#) as well as:

- [MK2R/MK2R+ and Win-Test Setup - "USB only" SO2R](#)
- [MK2R/MK2R+ and Win-Test Setup - "Classic" SO2R](#)
- [micro2R and Win-Test Setup - "USB only" SO2R](#)
- [micro2R Win-Test Setup - "Classic" SO2R"](#)

In the microHAM Router software SO2R tab, select **microHAM control protocol on COM port**. If that doesn't work reliably, you may instead select **Classic auto control**, and use LPT pins or virtual COM port pins to control TX/RX focus and Stereo mode.

When using the microHAM control protocol, select **Options | Configure interfaces** (text command shortcut: **SETUP**), then select **MicroHAM MK2R/MK2R+/u2R** next to the COM port specified as the **Control** port in the microHAM Router software. Win-Test may also start the microHAM Router software automatically, use the microHAM DVK, and control the ACC port. Select **Options | MK/MKII/MK2R/u2R configuration ...** (text command shortcut: **MKSETUP**) to open the [MK/MKII/MK2R Properties](#) dialog.

When using classic auto control, *uncheck* the control port so that it will not be used. Use microHAM virtual COM port DTR/RTS pins or LPT pins for PTT/CW/TX/RX and Stereo control.

A new macro **\$MK2R=<cmd>** supports sending any microHAM protocol command to the MK2R from a Win-Test Advanced SO2R scenario. This can be useful to set a specific audio configuration which is not one of the standard ones (\$R1R1, \$R1R2 or \$R2R2). For example, using **\$MK2R=FRD100000010000** in a CW message will configure the headphones audio to "Left=RADIO1,MAIN VFO" and "Right=RADIO1,SUB VFO". Please refer to the SO2R protocol specification in Appendix B of the [MK2R manual](#) to get details on the FRDxxxxxxxx command as well as other commands.

Win-Test may use the WinKey inside the MK2R/micro2R, or you can use classic COM port of LPT port ON/OFF CW keying and PTT.

The signals *Headphones Control*, *Stereo RX Audio*, *CW*, and *LPT* are available on either DTR or RTS pins of any virtual COM port. The MK2R microHAM SO2R interface can be fully controlled through a single USB cable, and some functions may also be controlled through an LPT cable if your computer has a printer port.

### YCCC SO2R Box

See [Configuring Win-Test for the SO2R Box](#) by W1UE.

In Win-Test Interface Configuration, select **OTRSP Compatible device** for the virtual COM port used to control the SO2R box.

## Top Ten Devices DX Doubler

If a real LPT port is available, set the internal jumpers of the DX Doubler, and the Win-Test LPT port configuration, as shown:

**DXD is shipped configured for operation with CT, TRLog and WriteLog. To configure the DXD for use with NA (or back to CT/TR/WriteLog from NA) follow the steps:**

Remove the top cover by removing all the screws in the black cover itself only. Locate the programming header P1, which is close to the 25 pin computer connector. Note that this is a standard computer-style programming header, with a single row of ten pins. Adjacent pins are either shorted together or open, depending upon the location of three supplied push-on shorting jumpers. Pin 1 of P1 is closest to the rear of the DXD.

Place the jumpers on P1 depending upon the driving software as follows:

Software	Jumper 1	Jumper 2	Jumper 3
CT, TR, WriteLog	1-2	4-5	8-9
NA	2-3	5-6	9-10

Replace the top cover of the DXD.

**For Win-Test, place Jumper 1 & 2 in NA mode, Jumper in 3 CT mode, as shown above.**

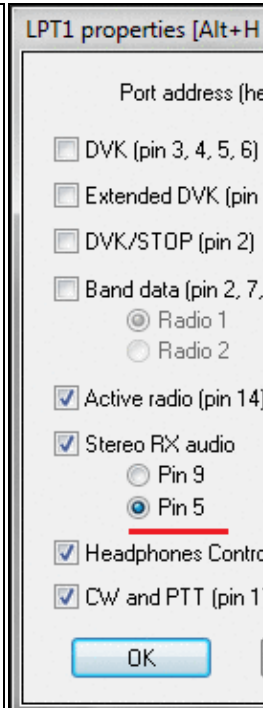

Win-Test LPT configuration with DX Doubler

bler jumper settings for use with Win-Test

If no LPT port is available to control the DX Doubler, you may use the [PIEXX SO2Rxlat USB to LPT translator](#) using a combination of OTRSP and virtual COM port settings, as described in the [NCJ article written by K0DQ](#) (starting at page 12).

## Ham Radio Solutions EZMaster

Refer to [SO2R/EZMaster/Setup](#). Use **Options | EZMaster configuration...** (text command shortcut: **EZSETUP**) to open the [EZMaster Properties dialog](#).

## W5XD Multi-Keyer

There are some limitations with this box, especially there are known problems with the writeahead. Sorry, there is no support from W5XD for Win-Test, and the box is not documented at all.

## Namespaces

- [Page](#)
- [Discussion](#)

## Variants

## Views

- [Read](#)
- [View source](#)
- [View history](#)

## More

- This page was last edited on 31 March 2020, at 15:58.

- [Privacy policy](#)
- [About Win-Test Wiki](#)
- [Disclaimers](#)



# Supported Accessories

From Win-Test Wiki

[Jump to navigation](#) [Jump to search](#)

## Contents

- [1 CW and/or voice keyers](#)
- [2 Band decoders](#)
- [3 CAT interfaces](#)
- [4 Integrated SO2R boxes](#)
  - ◆ [4.1 microHAM MK2R/MK2R+/micro2R](#)
  - ◆ [4.2 YCCC SO2R Box](#)
  - ◆ [4.3 Top Ten Devices DX Doubler](#)
  - ◆ [4.4 Ham Radio Solutions EZMaster](#)
  - ◆ [4.5 W5XD Multi-Keyer](#)

## CW and/or voice keyers

- MFJ: MFJ-432 voice keyer (deprecated)
- MFJ: [MFJ-434 voice keyer](#)  
Needs an interface similar to [this one](#), but doesn't handle the STOP LPT pin (#2). To circumvent this, you can redefine the Escape key to F4 and record a tiny empty message in message associated with the F4 key.
- K1EL: WinKey and WinKey2, standalone or inside an SO2R box. See [Integrated SO2R boxes](#) below for additional notes on using the WinKey inside an MK2R.

## Band decoders

- microHAM: [micro BAND DECODER](#) *¢*

## CAT interfaces

- microHAM: USB II Interface. For some practical examples:
  - ◆ Setting up an Icom IC-746 and a microHAM USB II Interface for contest operation see [BestPractice2](#) chapter.
  - ◆ Setting up a Kenwood TS-850, microHAM USB II Interface, microHAM USB Device Router, MMTTY, ExtFSK and Win-Test to run a RTTY contest see [BestPractice1](#) chapter.
  - ◆ Setting up an Icom IC-275 and a microHAM USB IC Interface for contest operation see [BestPractice3](#) chapter.
  - ◆ Setting up an FT-1000D and a microHAM USB IC Interface for contest operation see [BestPractice6](#) chapter.
- microHam: micro KEYER (MK) and micro KEYER II (MKII).
  - ◆ Setting up a Kenwood TS-850, microHAM microKeyer , microHAM USB Device Router, MMTTY, ExtFSK and Win-Test to run a RTTY contest see [BestPractice4](#) chapter. The same with a MKII, see [BestPractice5](#).
  - ◆ Setting up an ICOM IC-7410 and a microHAM microKeyer II for contest operation see [BestPractice8](#).



- microHAM: USB micro2R (u2R).

## Integrated SO2R boxes

### microHAM MK2R/MK2R+/micro2R

For detailed configuration examples, see [SO2R/MK2R/Setup](#) as well as:

- [MK2R/MK2R+ and Win-Test Setup - "USB only" SO2R](#)
- [MK2R/MK2R+ and Win-Test Setup - "Classic" SO2R](#)
- [micro2R and Win-Test Setup - "USB only" SO2R](#)
- [micro2R Win-Test Setup - "Classic" SO2R"](#)

In the microHAM Router software SO2R tab, select **microHAM control protocol on COM port**. If that doesn't work reliably, you may instead select **Classic auto control**, and use LPT pins or virtual COM port pins to control TX/RX focus and Stereo mode.

When using the microHAM control protocol, select **Options | Configure interfaces** (text command shortcut: **SETUP**), then select **MicroHAM MK2R/MK2R+/u2R** next to the COM port specified as the **Control** port in the microHAM Router software. Win-Test may also start the microHAM Router software automatically, use the microHAM DVK, and control the ACC port. Select **Options | MK/MKII/MK2R/u2R configuration ...** (text command shortcut: **MKSETUP**) to open the [MK/MKII/MK2R Properties](#) dialog.

When using classic auto control, *uncheck* the control port so that it will not be used. Use microHAM virtual COM port DTR/RTS pins or LPT pins for PTT/CW/TX/RX and Stereo control.

A new macro **\$MK2R=<cmd>** supports sending any microHAM protocol command to the MK2R from a Win-Test Advanced SO2R scenario. This can be useful to set a specific audio configuration which is not one of the standard ones (\$R1R1, \$R1R2 or \$R2R2). For example, using **\$MK2R=FRD100000010000** in a CW message will configure the headphones audio to "Left=RADIO1,MAIN VFO" and "Right=RADIO1,SUB VFO". Please refer to the SO2R protocol specification in Appendix B of the [MK2R manual](#) to get details on the FRDxxxxxxxx command as well as other commands.

Win-Test may use the WinKey inside the MK2R/micro2R, or you can use classic COM port of LPT port ON/OFF CW keying and PTT.

The signals *Headphones Control*, *Stereo RX Audio*, *CW*, and *LPT* are available on either DTR or RTS pins of any virtual COM port. The MK2R microHAM SO2R interface can be fully controlled through a single USB cable, and some functions may also be controlled through an LPT cable if your computer has a printer port.

### YCCC SO2R Box

See [Configuring Win-Test for the SO2R Box](#) by W1UE.

In Win-Test Interface Configuration, select **OTRSP Compatible device** for the virtual COM port used to control the SO2R box.

## Top Ten Devices DX Doubler

If a real LPT port is available, set the internal jumpers of the DX Doubler, and the Win-Test LPT port configuration, as shown:

**DXD is shipped configured for operation with CT, TRLog and WriteLog. To configure the DXD for use with NA (or back to CT/TR/WriteLog from NA) follow these steps:**

Remove the top cover by removing all the screws in the black cover itself only. Locate the programming header P1, which is close to the 25 pin computer connector. Note that this is a standard computer-style programming header, with a single row of ten pins. Adjacent pins are either shorted together or open, depending upon the location of three supplied push-on shorting jumpers. Pin 1 of P1 is closest to the rear of the DXD.

Place the jumpers on P1 depending upon the driving software as follows:

Software	Jumper 1	Jumper 2	Jumper 3
CT, TR, WriteLog	1-2	4-5	8-9
NA	2-3	5-6	9-10

Replace the top cover of the DXD.

**For Win-Test, place Jumper 1 & 2 in NA mode, Jumper in 3 CT mode, as shown above.**

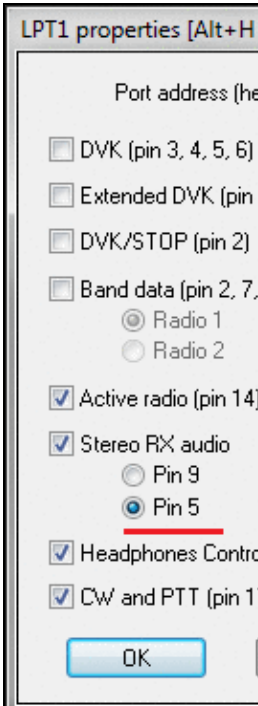

Win-Test LPT configuration with DX Doubler

bler jumper settings for use with Win-Test

If no LPT port is available to control the DX Doubler, you may use the [PIEXX SO2Rxlat USB to LPT translator](#) using a combination of OTRSP and virtual COM port settings, as described in the [NCJ article written by K0DQ](#) (starting at page 12).

## Ham Radio Solutions EZMaster

Refer to [SO2R/EZMaster/Setup](#). Use **Options | EZMaster configuration...** (text command shortcut: **EZSETUP**) to open the [EZMaster Properties dialog](#).

## W5XD Multi-Keyer

There are some limitations with this box, especially there are known problems with the writeahead. Sorry, there is no support from W5XD for Win-Test, and the box is not documented at all.

## Namespaces

- [Page](#)
- [Discussion](#)

## Variants

## Views

- [Read](#)
- [View source](#)
- [View history](#)

## More

- This page was last edited on 31 March 2020, at 15:58.

- [Privacy policy](#)
- [About Win-Test Wiki](#)
- [Disclaimers](#)



# Supported Contests

From Win-Test Wiki

[Jump to navigation](#) [Jump to search](#)

This is the list of the supported contests (as per version 4.34)

## HF Contests

- [AGCW Happy New Year \[1\]](#)
- [AGCW German Telegraphy Contest \[2\]](#)
- [All Asian DX \(Asian side and DX side\) \[3\]](#)
- [ARI International DX \(I side and DX side\) \[4\]](#)
- [ARI Sezioni \[5\]](#)
- [ARI 40/80 meters \[6\]](#)
- [ARRL International DX \(K/VE side and DX side\) \[7\]](#)
- [ARRL Field day \[8\]](#)
- [ARRL Sweepstakes \[9\]](#)
- [ARRL RTTY Roundup \[10\]](#)
- [ARRL 10 meters \[11\]](#)
- [ARRL 160 meters \[12\]](#)
- [Asia-Pacific Sprint \[13\]](#)
- [Baltic \[14\]](#)
- [CQ-M International DX \[15\]](#)
- [CQMM DX Contest \[16\]](#)
- [CQWW DX \[17\]](#)
- [CQWW WPX \[18\]](#)
- [CQWW 160 meters \[19\]](#)
- [Croatian CW \[20\]](#)
- [DARC 10 meters \[21\]](#)
- [DARC Xmas \[22\]](#)
- [EU-DX Contest \[23\]](#)
- [EU-HF Championship \[24\]](#)
- ~~[EU Sprint \[25\]](#)~~
- [FOC Marathon \[26\]](#)
- [GACW WWSA DX \[27\]](#)
- [HA DX \(HA side and DX side\) \[28\]](#)
- [Helvetia \(HB side and DX side\) \[29\]](#)
- [IARU Field Day Rgn 1 \(generic, DARC and RSGB scorings\) \[30\] \[31\] \[32\] \[33\]](#)
- [IARU HF World Championship \[34\]](#)
- [IOTA \[35\]](#)
- [JARTS WW RTTY Contest \[36\]](#)
- [Japan International DX \(JA side and DX side\) \[37\]](#)
- [KCJ \[38\]](#)
- [KCJ TopBand \[39\]](#)
- [King of Spain \(EA side and DX side\) \[40\]](#)
- [LZ DX \(LZ side and DX side\) \[41\]](#)
- [NRAU Baltic \(Scandinavian/Baltic side and DX side\) \[42\]](#)
- [NAQP \[43\]](#)
- [NA Sprint \[44\]](#)

- NCCC Sprint (NS) [\[45\]](#)
- Oceania DX (OC side and DX side) [\[46\]](#)
- OK1WC Memorial [\[47\]](#)
- OK/OM DX (OK/OM side and DX side) [\[48\]](#)
- ON contest 80, 6 and 2 meters (ON side and DX side) [\[49\]](#)
- PACC (PA side and DX side) [\[50\]](#)
- QSO Party Texas [\[51\]](#)
- RAC Canada Day [\[52\]](#)
- RAC Canada Winter [\[53\]](#)
- RAEM Contest [\[54\]](#)
- RDA [\[55\]](#)
- REF Championship HF (F/TK/DOM-TOM side and DX side) [\[56\]](#)
- REF 160 meters [\[57\]](#)
- Russian DX [\[58\]](#)
- Russian 160 meters [\[59\]](#)
- RRTC Russian Radio Sport Team [\[60\]](#)
- RSGB 160 meters [\[61\]](#)
- RSGB 80 meters Club Championship [\[62\]](#)
- RSGB 21/28 MHz [\[63\]](#)
- RSGB Affiliated Societies Team (AFS) [\[64\]](#)
- RSGB Commonwealth (BERU) [\[65\]](#)
- SAC (Scandinavian side and DX side) [\[66\]](#)
- SARTG RTTY [\[67\]](#)
- SCC Championship RTTY [\[68\]](#)
- SP DX (SP side and DX side) [\[69\]](#)
- Stew Perry Topband Challenge [\[70\]](#)
- TOEC WW Grid [\[71\]](#)
- UBA DX (ON side and DX side) [\[72\]](#)
- UBA Spring 80, 6 and 2 meters (ON side and DX side) [\[73\]](#)
- UFT-HF
- Ukrainian DX (UR side and DX side) [\[74\]](#)
- Worked All Europe DX (EU side and DX side) [\[75\]](#)
- Worked All Germany (DL side and DX side) [\[76\]](#)
- YOTA Contest [\[77\]](#)
- YO DX (YO side and DX side) [\[78\]](#)
- YU DX (YU side and DX side) [\[79\]](#)

## VHF and above Contests

- ARRL August UHF Contest
- ARRL January VHF Sweepstakes
- ARRL June VHF QSO Party
- ARRL September VHF QSO Party
- CQWW VHF
- Helvetia VHF/UHF/Microwave Contest
- IARU Region 1 VHF
- IARU Region 1 UHF
- IARU Region 1 CW (aka Samuel MORSE)
- IARU Region 1 50 MHz Contest
- NRAU Activity Contest

- REF DDFM 50 MHz
- REF Championship THF
- UBA Spring Contest 6m & 2m
- ON Contest 6m & 2m
- Generic European V/UHF - No mults
- Generic European 50/70/V/UHF - No mults
- Generic European V/UHF - Mults = Gridsquares
- Generic European 50/70/V/UHF - Mults = Gridsquares
- Generic European V/UHF - Mults = Gridsquares - 1 pt/Q
- Generic European 50/70/V/UHF - Mults = Gridsquares - 1 pt/Q

## Special for DxPeditions

Moreover to the Contest list, there is also an **HF DXpedition** option (160 m to 6 m), and a **VHF+ DXpedition** option, including all the operating modes, like RTTY, PSK, HELL and PKT.

## Namespaces

- [Page](#)
- [Discussion](#)

## Variants

## Views

- [Read](#)
- [View source](#)
- [View history](#)

## More

- This page was last edited on 30 December 2021, at 11:09.

- [Privacy policy](#)
- [About Win-Test Wiki](#)
- [Disclaimers](#)



# Supported Contests

From Win-Test Wiki

[Jump to navigation](#) [Jump to search](#)

This is the list of the supported contests (as per version 4.34)

## HF Contests

- [AGCW Happy New Year \[1\]](#)
- [AGCW German Telegraphy Contest \[2\]](#)
- [All Asian DX \(Asian side and DX side\) \[3\]](#)
- [ARI International DX \(I side and DX side\) \[4\]](#)
- [ARI Sezioni \[5\]](#)
- [ARI 40/80 meters \[6\]](#)
- [ARRL International DX \(K/VE side and DX side\) \[7\]](#)
- [ARRL Field day \[8\]](#)
- [ARRL Sweepstakes \[9\]](#)
- [ARRL RTTY Roundup \[10\]](#)
- [ARRL 10 meters \[11\]](#)
- [ARRL 160 meters \[12\]](#)
- [Asia-Pacific Sprint \[13\]](#)
- [Baltic \[14\]](#)
- [CQ-M International DX \[15\]](#)
- [CQMM DX Contest \[16\]](#)
- [CQWW DX \[17\]](#)
- [CQWW WPX \[18\]](#)
- [CQWW 160 meters \[19\]](#)
- [Croatian CW \[20\]](#)
- [DARC 10 meters \[21\]](#)
- [DARC Xmas \[22\]](#)
- [EU-DX Contest \[23\]](#)
- [EU-HF Championship \[24\]](#)
- ~~[EU Sprint \[25\]](#)~~
- [FOC Marathon \[26\]](#)
- [GACW WWSA DX \[27\]](#)
- [HA DX \(HA side and DX side\) \[28\]](#)
- [Helvetia \(HB side and DX side\) \[29\]](#)
- [IARU Field Day Rgn 1 \(generic, DARC and RSGB scorings\) \[30\] \[31\] \[32\] \[33\]](#)
- [IARU HF World Championship \[34\]](#)
- [IOTA \[35\]](#)
- [JARTS WW RTTY Contest \[36\]](#)
- [Japan International DX \(JA side and DX side\) \[37\]](#)
- [KCJ \[38\]](#)
- [KCJ TopBand \[39\]](#)
- [King of Spain \(EA side and DX side\) \[40\]](#)
- [LZ DX \(LZ side and DX side\) \[41\]](#)
- [NRAU Baltic \(Scandinavian/Baltic side and DX side\) \[42\]](#)
- [NAQP \[43\]](#)
- [NA Sprint \[44\]](#)

- NCCC Sprint (NS) [\[45\]](#)
- Oceania DX (OC side and DX side) [\[46\]](#)
- OK1WC Memorial [\[47\]](#)
- OK/OM DX (OK/OM side and DX side) [\[48\]](#)
- ON contest 80, 6 and 2 meters (ON side and DX side) [\[49\]](#)
- PACC (PA side and DX side) [\[50\]](#)
- QSO Party Texas [\[51\]](#)
- RAC Canada Day [\[52\]](#)
- RAC Canada Winter [\[53\]](#)
- RAEM Contest [\[54\]](#)
- RDA [\[55\]](#)
- REF Championship HF (F/TK/DOM-TOM side and DX side) [\[56\]](#)
- REF 160 meters [\[57\]](#)
- Russian DX [\[58\]](#)
- Russian 160 meters [\[59\]](#)
- RRTC Russian Radio Sport Team [\[60\]](#)
- RSGB 160 meters [\[61\]](#)
- RSGB 80 meters Club Championship [\[62\]](#)
- RSGB 21/28 MHz [\[63\]](#)
- RSGB Affiliated Societies Team (AFS) [\[64\]](#)
- RSGB Commonwealth (BERU) [\[65\]](#)
- SAC (Scandinavian side and DX side) [\[66\]](#)
- SARTG RTTY [\[67\]](#)
- SCC Championship RTTY [\[68\]](#)
- SP DX (SP side and DX side) [\[69\]](#)
- Stew Perry Topband Challenge [\[70\]](#)
- TOEC WW Grid [\[71\]](#)
- UBA DX (ON side and DX side) [\[72\]](#)
- UBA Spring 80, 6 and 2 meters (ON side and DX side) [\[73\]](#)
- UFT-HF
- Ukrainian DX (UR side and DX side) [\[74\]](#)
- Worked All Europe DX (EU side and DX side) [\[75\]](#)
- Worked All Germany (DL side and DX side) [\[76\]](#)
- YOTA Contest [\[77\]](#)
- YO DX (YO side and DX side) [\[78\]](#)
- YU DX (YU side and DX side) [\[79\]](#)

## VHF and above Contests

- ARRL August UHF Contest
- ARRL January VHF Sweepstakes
- ARRL June VHF QSO Party
- ARRL September VHF QSO Party
- CQWW VHF
- Helvetia VHF/UHF/Microwave Contest
- IARU Region 1 VHF
- IARU Region 1 UHF
- IARU Region 1 CW (aka Samuel MORSE)
- IARU Region 1 50 MHz Contest
- NRAU Activity Contest



- REF DDFM 50 MHz
- REF Championship THF
- UBA Spring Contest 6m & 2m
- ON Contest 6m & 2m
- Generic European V/UHF - No mults
- Generic European 50/70/V/UHF - No mults
- Generic European V/UHF - Mults = Gridsquares
- Generic European 50/70/V/UHF - Mults = Gridsquares
- Generic European V/UHF - Mults = Gridsquares - 1 pt/Q
- Generic European 50/70/V/UHF - Mults = Gridsquares - 1 pt/Q

## Special for DxPeditions

Moreover to the Contest list, there is also an **HF DXpedition** option (160 m to 6 m), and a **VHF+ DXpedition** option, including all the operating modes, like RTTY, PSK, HELL and PKT.

## Namespaces

- [Page](#)
- [Discussion](#)

## Variants

## Views

- [Read](#)
- [View source](#)
- [View history](#)

## More

- This page was last edited on 30 December 2021, at 11:09.

- [Privacy policy](#)
- [About Win-Test Wiki](#)
- [Disclaimers](#)



# Supported rigs

From Win-Test Wiki

[Jump to navigation](#) [Jump to search](#)

Win-Test supports most rigs of today's amateur radio market. The radio or radios (if you use two) and their communication parameters are to be configured in the [Options Menu](#) of Win-Test. Typically, you don't even have to guess specific baud rates or parity settings as Win-Test knows most of the default settings.

## Contents

- [1 Kenwood](#)
- [2 Icom](#)
  - ◆ [2.1 Other Icom radios](#)
- [3 Yaesu](#)
- [4 Ten-Tec](#)
- [5 Elecraft](#)
- [6 Others](#)

## Kenwood

Virtually all Kenwood rigs are supported by Win-Test. They all use the same CAT command subset needed by Win-Test.

**Note:** Additional function for modern Kenwood rigs is supported by LUA scripts by N6TV that you may download from <https://bit.ly/wtscripts> in file **TS590scripts.zip**.

Older Kenwood rigs use by default:

- Speed: 4800 baud
- Data bits: 8
- Parity: None
- Stop bits: 2
- DTR: Always OFF
- RTS: Handshake

Newer Kenwood rigs use by default:

- Speed: 9600 baud
- Data bits: 8
- Parity: None
- Stop bits: 1
- DTR: Always OFF
- RTS: Handshake

Exception: TS-590S uses two stop bits *only* for 4800 baud. For all other baud rates, use only 1 stop bit.

Models successfully tested:

- TS-480SAT

## Win-Test Wiki

- TS-480HX
- TS-590S, TS-590SG

USB connection default is 115200 baud. COM port connection default is 9600 baud. Be sure to set RTS=Handshake. USB requires installation of the Silicon Labs Virtual COM port (VCP) driver. For VCP installation instructions, see this page on the Kenwood web site).

- TS-850S
- TS-930S PIEXX (Tnx FM5BH)
- TS-940S
- TS-950S
- TS-570DGE
- TS-990S – Same as TS-590S, see above.
- TS-2000 – COM port default is 9600 baud, 1 stop bit, RTS=Handshake
- (others are known to work, but not fully tested, e.g. TS-690, TS-450, TS-950SD, etc.)

## Icom

Virtually, all Icom rigs are supported by Win-Test. They all use the same CAT command subset.

**Note:** Additional function for modern Icom rigs is supported by LUA scripts by N6TV that you may download from <https://bit.ly/wtscripts> in file **IcomScripts.zip**.

**Note:** The VFO-B windows with ICOM is almost always grey on older Icom radios [\[1\]](#).

Best results for Icom radios are usually achieved by checking *both* the **Don't poll** and the **Use CI-V-Transceiver** options. The band map then moves very smoothly while turning the VFO. Another choice is to *remove* the check mark from both of these options.

- IC-275  
COM port set to 1200 baud, 8 data bits, no parity and 1 stop bit. Tnx MM0GPZ.  
See also Setting up an Icom IC-275H with the microHAM USB Interface IC.
- IC-475
- IC-703
- IC-706  
COM port set to 9600 baud, 8 data bits, no parity and 1 stop bit. Tnx F6IFY
- IC-706 Mk II
- IC-706 Mk II G
- IC-718
- IC-725
- IC-728
- IC-729
- IC-735
- IC-736
- IC-737
- IC-738
- IC-746
- IC-746 Pro
- IC-751
- IC-756

- IC-756 Pro
- IC-756 Pro II
- IC-756 Pro III
- IC-761
- IC-765
- IC-775 (or IC 775 DSP)  
COM port set to 1200 baud, 8 data bits, no parity and 1 stop bit. Tnx EA3IN. (also succesfully tested up to 9600 baud. I2WIJ)
- IC-781
- IC-910
- IC-970
- IC-1275
- IC-7000
- IC-7100
- IC-7200
- IC-7300
- IC-7400 - not listed, but you may select IC-746 Pro, which uses the same hex address: 66h
- IC-7410
- IC-7600
- IC-7610
- IC-7700
- IC-7800
- IC-7850
- IC-7851
- IC-7900
- IC-9100

## Other Icom radios

- Icom generic: This setting can be used to connect an Icom rig not listed. You need to set the Icom rig's address (found in the rig manual) in the wt.ini file in the [Interfaces] section. Please see WT.INI for more details.
- IC-728  
Use the Icom generic setting with hex address 38h and set COM port to 1200 baud, 8 data bits, no parity, 1 stop bit. Tnx VK6NU
- IC-746 PRO  
In fact, the IC 7400 (below) is the European version of the IC 746 PRO. It uses the same hex address and should work with the same settings. Tnx F8CRH
- IC-910H  
Use the Icom generic setting with hex address 60h and set COM port to 4800 baud, 8 data bits, no parity, 1 stop bit. Works on all 3 bands (2m, 70 and 23 cm). Tnx F6BEE
- IC-7400  
Use the Icom generic setting with hex address 66h and set COM port to 9600 baud (also successfully tested with 1200 and 19200 baud and TRX set accordingly), 8 data bits, no parity, 2 stop bits. Tnx F8CRH

## Yaesu

**Note:** Additional function for modern Yaesu rigs is supported by LUA scripts by N6TV that you may download from <https://bit.ly/wtscripts> in file **YaesuScripts.zip**.

- FT-100
- FT-450
- FT-757GX II
- FT-817
- FT-847
- FT-857
- FT-891
- FT-897
- FT-900
- FT-920
- FT-950
- FT-990

COM port set to 4800 bauds, 8 data bits, no parity, no flow control and 2 stop bits.

For DTR and RTS, see FT-1000D below. Tnx F6GOX, NX5M.

- FT-991

Use the Yaesu USB driver. See screen shots of recommended menu settings well-documented by HB9AMO at <http://www.hb9amo.net/wt-ft991.php>

- FT-1000D

COM port set to 4800 bauds, 8 data bits, no parity, no flow control and 2 stop bits.

When using a powered CAT interface such as the Yaesu FIF-232C CAT interface box and CT-62 cable, set DTR and RTS to **Always OFF**.

When using a "passive" (not powered) interface cable such as the K1NU CAT Control Cable, set DTR to **Always OFF**, RTS to **Always ON**. Tnx F5FLN, NX5M, NQ4I.

- FT-1000MP (including Mark V)

COM port set to 4800 bauds, 8 data bits, no parity, no flow control and 2 stop bits. Tnx FM5BH and F8CRH.

- FT-2000
- FTdx-101
- FTdx-1200
- FTdx-3000
- FTdx-5000
- FTdx-9000
- FTDX-10

**Note:** Sub-VFO programming from within the band map is available for the FT-1000MP, FT-2000 and FTdx-9000 only

## Ten-Tec

- Jupiter
- Orion (aka Orion I)
- Orion II
- Omni VI

Use the Icom generic setting, with 04h hex address, and set COM port to 9600 baud (can be modified in TRX if needed), 8 data bits, no parity, 1 stop bit. Tnx F6IFY

- Omni VII

**Note:** Sub-VFO programming from within the band map is available for the Orion only.

## Elecraft

**Note:** Additional function for Elecraft rigs is supported by LUA scripts by N6TV that you may download from <https://bit.ly/wtscripts> in file **K3scripts.zip**, **KX3Scripts.zip**, and **P3scripts.zip**.

- Elecraft K2
- Elecraft K3
- Elecraft K3S
- Elecraft KX3 (see [Setting up the KX3 only with KXUSB cable](#))

## Others

- FlexRadio SDR-1000
- Flex 6000 series (now has its own driver, apart from Kenwood)
- [OmniRig](#) - Setting radio type to OmniRig will allow the radio's COM port to be shared with other applications such as [Winrad](#) and [HDSDR](#).

## Namespaces

- [Page](#)
- [Discussion](#)

## Variants

## Views

- [Read](#)
- [View source](#)
- [View history](#)

## More

- This page was last edited on 10 April 2023, at 06:25.
- [Privacy policy](#)
- [About Win-Test Wiki](#)
- [Disclaimers](#)



# Supported rigs

From Win-Test Wiki

[Jump to navigation](#) [Jump to search](#)

Win-Test supports most rigs of today's amateur radio market. The radio or radios (if you use two) and their communication parameters are to be configured in the [Options Menu](#) of Win-Test. Typically, you don't even have to guess specific baud rates or parity settings as Win-Test knows most of the default settings.

## Contents

- [1 Kenwood](#)
- [2 Icom](#)
  - ◆ [2.1 Other Icom radios](#)
- [3 Yaesu](#)
- [4 Ten-Tec](#)
- [5 Elecraft](#)
- [6 Others](#)

## Kenwood

Virtually all Kenwood rigs are supported by Win-Test. They all use the same CAT command subset needed by Win-Test.

**Note:** Additional function for modern Kenwood rigs is supported by LUA scripts by N6TV that you may download from <https://bit.ly/wtscripts> in file **TS590scripts.zip**.

Older Kenwood rigs use by default:

- Speed: 4800 baud
- Data bits: 8
- Parity: None
- Stop bits: 2
- DTR: Always OFF
- RTS: Handshake

Newer Kenwood rigs use by default:

- Speed: 9600 baud
- Data bits: 8
- Parity: None
- Stop bits: 1
- DTR: Always OFF
- RTS: Handshake

Exception: TS-590S uses two stop bits *only* for 4800 baud. For all other baud rates, use only 1 stop bit.

Models successfully tested:

- TS-480SAT

## Win-Test Wiki

- TS-480HX
- TS-590S, TS-590SG

USB connection default is 115200 baud. COM port connection default is 9600 baud. Be sure to set RTS=Handshake. USB requires installation of the Silicon Labs Virtual COM port (VCP) driver. For VCP installation instructions, see this page on the Kenwood web site).

- TS-850S
- TS-930S PIEXX (Tnx FM5BH)
- TS-940S
- TS-950S
- TS-570DGE
- TS-990S – Same as TS-590S, see above.
- TS-2000 – COM port default is 9600 baud, 1 stop bit, RTS=Handshake
- (others are known to work, but not fully tested, e.g. TS-690, TS-450, TS-950SD, etc.)

## Icom

Virtually, all Icom rigs are supported by Win-Test. They all use the same CAT command subset.

**Note:** Additional function for modern Icom rigs is supported by LUA scripts by N6TV that you may download from <https://bit.ly/wtscripts> in file **IcomScripts.zip**.

**Note:** The VFO-B windows with ICOM is almost always grey on older Icom radios [1].

Best results for Icom radios are usually achieved by checking *both* the **Don't poll** and the **Use CI-V-Transceiver** options. The band map then moves very smoothly while turning the VFO. Another choice is to *remove* the check mark from both of these options.

- IC-275  
COM port set to 1200 baud, 8 data bits, no parity and 1 stop bit. Tnx MM0GPZ.  
See also Setting up an Icom IC-275H with the microHAM USB Interface IC.
- IC-475
- IC-703
- IC-706  
COM port set to 9600 baud, 8 data bits, no parity and 1 stop bit. Tnx F6IFY
- IC-706 Mk II
- IC-706 Mk II G
- IC-718
- IC-725
- IC-728
- IC-729
- IC-735
- IC-736
- IC-737
- IC-738
- IC-746
- IC-746 Pro
- IC-751
- IC-756



- IC-756 Pro
- IC-756 Pro II
- IC-756 Pro III
- IC-761
- IC-765
- IC-775 (or IC 775 DSP)  
COM port set to 1200 baud, 8 data bits, no parity and 1 stop bit. Tnx EA3IN. (also succesfully tested up to 9600 baud. I2WIJ)
- IC-781
- IC-910
- IC-970
- IC-1275
- IC-7000
- IC-7100
- IC-7200
- IC-7300
- IC-7400 - not listed, but you may select IC-746 Pro, which uses the same hex address: 66h
- IC-7410
- IC-7600
- IC-7610
- IC-7700
- IC-7800
- IC-7850
- IC-7851
- IC-7900
- IC-9100

## Other Icom radios

- Icom generic: This setting can be used to connect an Icom rig not listed. You need to set the Icom rig's address (found in the rig manual) in the wt.ini file in the [Interfaces] section. Please see WT.INI for more details.
- IC-728  
Use the Icom generic setting with hex address 38h and set COM port to 1200 baud, 8 data bits, no parity, 1 stop bit. Tnx VK6NU
- IC-746 PRO  
In fact, the IC 7400 (below) is the European version of the IC 746 PRO. It uses the same hex address and should work with the same settings. Tnx F8CRH
- IC-910H  
Use the Icom generic setting with hex address 60h and set COM port to 4800 baud, 8 data bits, no parity, 1 stop bit. Works on all 3 bands (2m, 70 and 23 cm). Tnx F6BEE
- IC-7400  
Use the Icom generic setting with hex address 66h and set COM port to 9600 baud (also successfully tested with 1200 and 19200 baud and TRX set accordingly), 8 data bits, no parity, 2 stop bits. Tnx F8CRH

## Yaesu

**Note:** Additional function for modern Yaesu rigs is supported by LUA scripts by N6TV that you may download from <https://bit.ly/wtscripts> in file **YaesuScripts.zip**.

- FT-100
- FT-450
- FT-757GX II
- FT-817
- FT-847
- FT-857
- FT-891
- FT-897
- FT-900
- FT-920
- FT-950
- FT-990

COM port set to 4800 bauds, 8 data bits, no parity, no flow control and 2 stop bits.

For DTR and RTS, see FT-1000D below. Tnx F6GOX, NX5M.

- FT-991

Use the Yaesu USB driver. See screen shots of recommended menu settings well-documented by HB9AMO at <http://www.hb9amo.net/wt-ft991.php>

- FT-1000D

COM port set to 4800 bauds, 8 data bits, no parity, no flow control and 2 stop bits.

When using a powered CAT interface such as the Yaesu FIF-232C CAT interface box and CT-62 cable, set DTR and RTS to **Always OFF**.

When using a "passive" (not powered) interface cable such as the K1NU CAT Control Cable, set DTR to **Always OFF**, RTS to **Always ON**. Tnx F5FLN, NX5M, NQ4I.

- FT-1000MP (including Mark V)

COM port set to 4800 bauds, 8 data bits, no parity, no flow control and 2 stop bits. Tnx FM5BH and F8CRH.

- FT-2000
- FTdx-101
- FTdx-1200
- FTdx-3000
- FTdx-5000
- FTdx-9000
- FTDX-10

**Note:** Sub-VFO programming from within the band map is available for the FT-1000MP, FT-2000 and FTdx-9000 only

## Ten-Tec

- Jupiter
- Orion (aka Orion I)
- Orion II
- Omni VI

Use the Icom generic setting, with 04h hex address, and set COM port to 9600 baud (can be modified in TRX if needed), 8 data bits, no parity, 1 stop bit. Tnx F6IFY

- Omni VII

**Note:** Sub-VFO programming from within the band map is available for the Orion only.

## Elecraft

**Note:** Additional function for Elecraft rigs is supported by LUA scripts by N6TV that you may download from <https://bit.ly/wtscripts> in file **K3scripts.zip**, **KX3Scripts.zip**, and **P3scripts.zip**.

- Elecraft K2
- Elecraft K3
- Elecraft K3S
- Elecraft KX3 (see [Setting up the KX3 only with KXUSB cable](#))

## Others

- FlexRadio SDR-1000
- Flex 6000 series (now has its own driver, apart from Kenwood)
- [OmniRig](#) - Setting radio type to OmniRig will allow the radio's COM port to be shared with other applications such as [Winrad](#) and [HDSDR](#).

## Namespaces

- [Page](#)
- [Discussion](#)

## Variants

## Views

- [Read](#)
- [View source](#)
- [View history](#)

## More

- This page was last edited on 10 April 2023, at 06:25.
- [Privacy policy](#)
- [About Win-Test Wiki](#)
- [Disclaimers](#)



# Sweepstakes

From Win-Test Wiki

[Jump to navigation](#) [Jump to search](#)

To use Win-Test in the ARRL Sweepstakes contest, use the following as a guide.

## Contents

- [1 Define your ARRL Section, Check, and Precedence](#)
- [2 Program your CW Messages](#)
- [3 ARRL Section "equivalence" file](#)
- [4 Super Check Partial file for ARRL Sweepstakes](#)
- [5 Logging QSOs](#)
- [6 Displaying Sections worked](#)
- [7 Check your log after the contest](#)

## Define your ARRL Section, Check, and Precedence

Specify your ARRL section, entry class, power level, and year first licensed (two digits only) on the contest configuration screen as shown:

# Win-Test Wiki

**Contest configuration**

**Station**

Callsign: N6TV Grid Square: CM97CF Exchange (zone, ...): SCV ?

DXCC Prefix: W WAZ zone: 03 ITU zone: 06 State/Province/Other: CA

Name: Robert A. Wilson

Address: 51 Cheltenham Way

Address: San Jose, CA 95139-1257

Address: USA

Club: Northern California Contest Club

**Load**

N6TV WRTC R3/N6TV R39WRTC WK5T

**Save as**

N6TV WRTC R3/N6TV R39WRTC WK5T

**Contest**

Contest: ARRL Sweepstakes Days...  This month only

Category: Single operator Mode: CW

Overlay: --- Band plan: Default Setup...

Class: High power License year: 72

Operators:

**Network**

Station: STN1  Enable time distribution across the network

OK Cancel

Specify your entry class, power and year first licensed.

## Program your CW Messages

Specify your ARRL Sweepstakes CW messages using the appropriate message variables. Note that the **precedence** must be entered manually (there is no \$PREC variable yet):

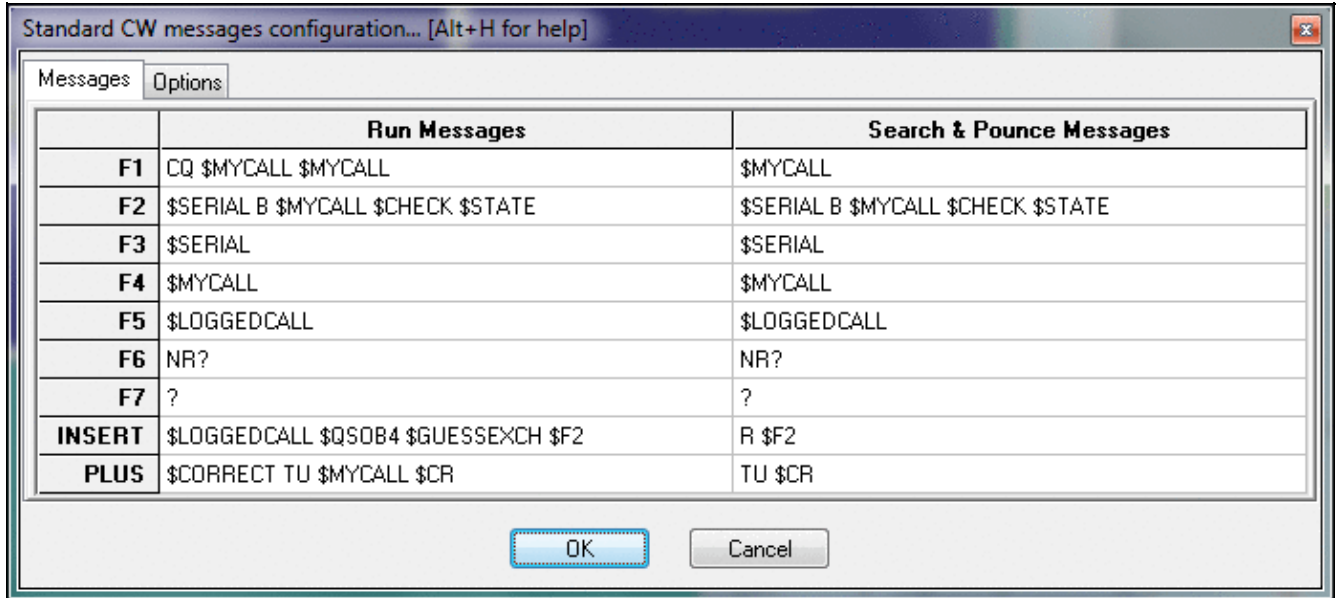

Specify your CW message. Precedence must be entered manually.

## ARRL Section "equivalence" file

Download the latest **ARRLSEC.DAT** file from

<http://download.win-test.com/files/equivalence/ARRLSEC.DAT> and save it in the Win-Test countryFiles directory (do **File | Explore | /countryFiles** directory).

This is not the official ARRL Section List, but the list of "alternate spellings" of the official ARRL sections.

## Super Check Partial file for ARRL Sweepstakes

Download the latest **MASTERSS.DTA** file from <http://www.supercheckpartial.com> and save it in the Win-Test databases directory (do **File | Explore | /databases** directory).

To ensure that it will be used, you *must* save the file with a *new name*, **DEFAULT.DTA**, not **MASTERSS.DTA**.

To verify that the **DEFAULT.DTA** file is being used, right click on the Check Partial window, as shown below:

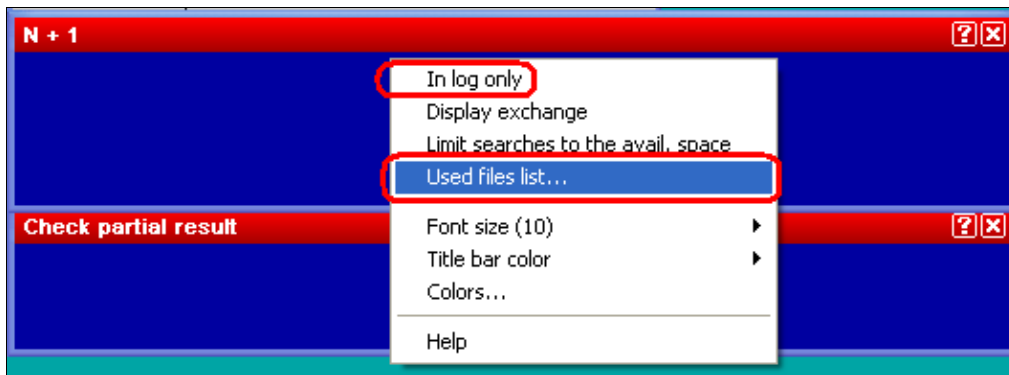

Click **Used files list** to display the name of the Super Check Partial file that is being used. Make sure **In log only** is *not* checked.

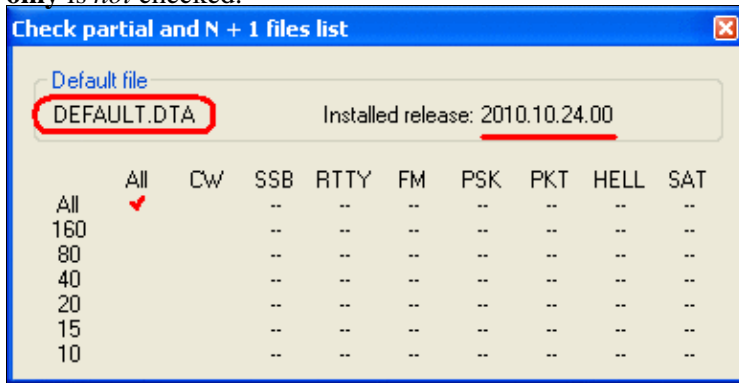

Note that **DEFAULT.DTA** is being used, and that it is current.

## Logging QSOs

Spacebar jumps between fields in exchange order: Callsign, number received, precedence, callsign (again), check, and section.

Use the [**<**] (less than) key, and the [**>**] (greater than) key to move the cursor left or right one field.

Use the indicated options to hide the redundant QSO number in the first column, and make the up and down arrow keys stay in the same column to make it easier to edit exchange data entered on a previous line:

The screenshot shows the Win-Test application interface. The 'Log' menu is open, and its sub-menu is also open. The 'Log' menu item is highlighted with a red box. The sub-menu is also open, and the 'Hide QSO numbers' and 'Stay in field when moving up and down in the log' options are checked with blue checkmarks and highlighted by a red box. Below the menu is a table of logged QSOs.

Bd	Time	N°	N°	P	Callsign	Chk	Rcvd	Mult	Pts
80	02:05	1271	134	A	KK0HF	85	KS		2
80	02:08	1272	119	A	NG6E	62	LAX		2
80	02:09	1273	150	A	NR7T	75	UT		2
80	02:09	1274	851	U	W6PZ	56	SF		2
80	02:12	1275	288	B	K7MI	72	OR		2
80	02:13	1276	720	A	WN6K	75	SDG		2
40	02:17	1277	124	A	K7RR	69	WWA		2
40	02:21	1278	471	B	K2KQ	47	ENY		2
40	02:30	1279	196	B	KW8N	69	OH		2
80		1280							0



Log entry for ARRL Sweepstakes. Right click on the logging window to change the Log options to those indicated.

### Displaying Sections worked

Press **[Alt-Z]** to display the worked sections list. Right click and check **Marks** to order sections by call district:

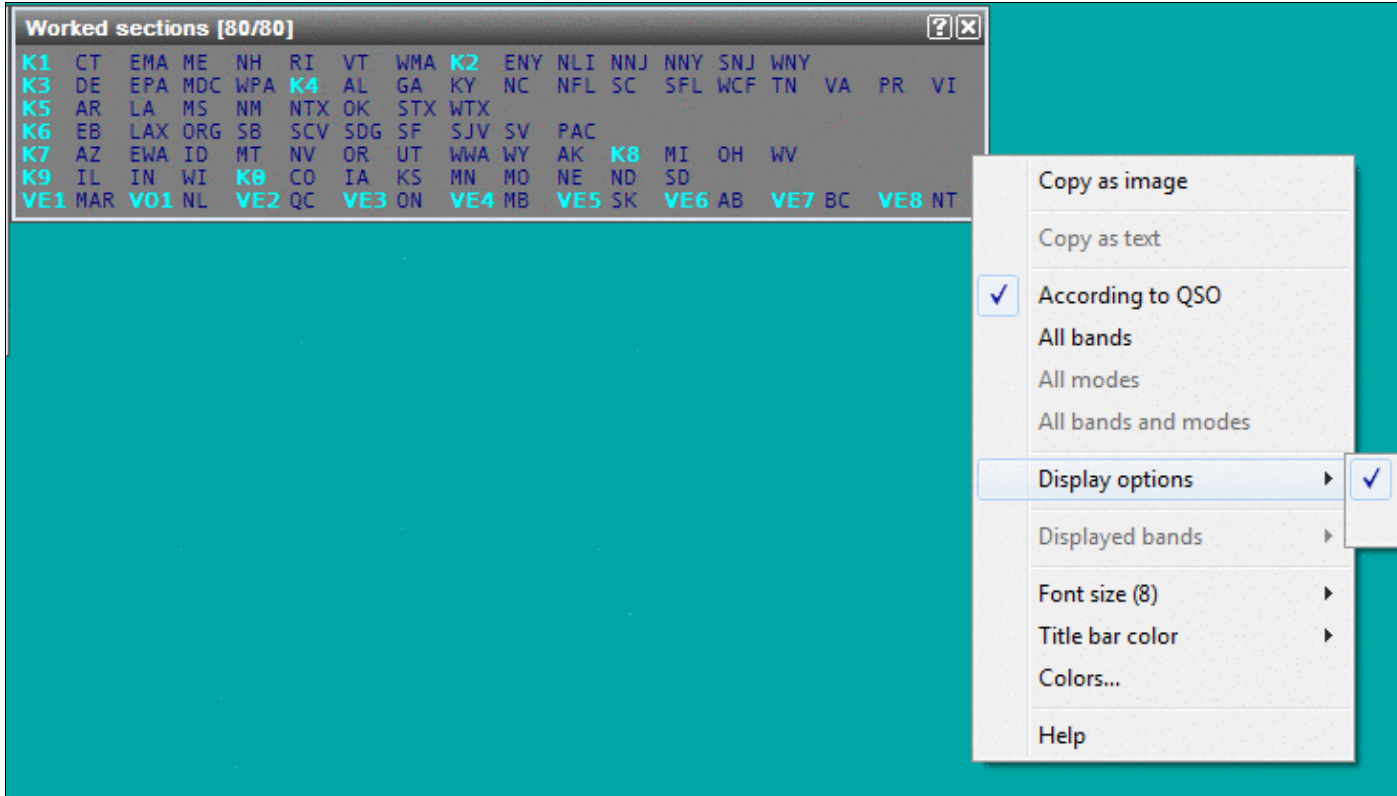

Ordering ARRL section list by call district  
**Check your log after the contest**

During the contest, Win-Test allows you to log just about anything in any column, including invalid QSO numbers like "1A" and invalid Precedences and non-numeric Check values. The **Search for possible bad exchanges** tool can be used to find and correct these.

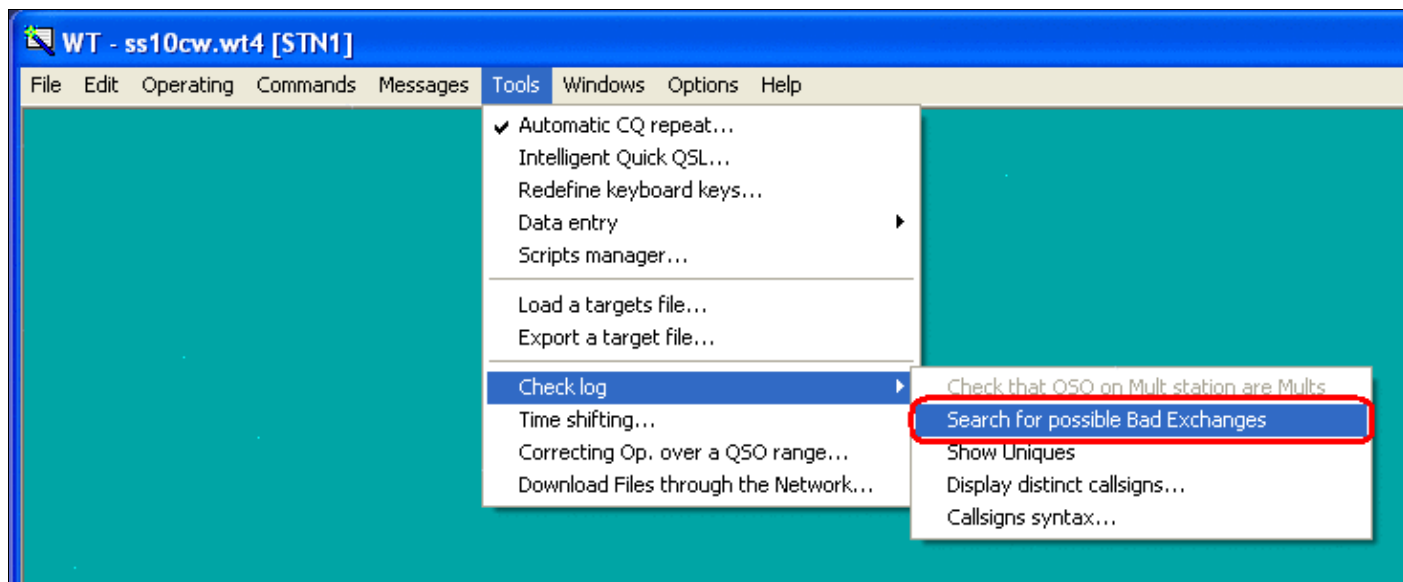

How to search for possible bad exchanges anywhere in your log  
 The report indicates all QSOs with a problem:

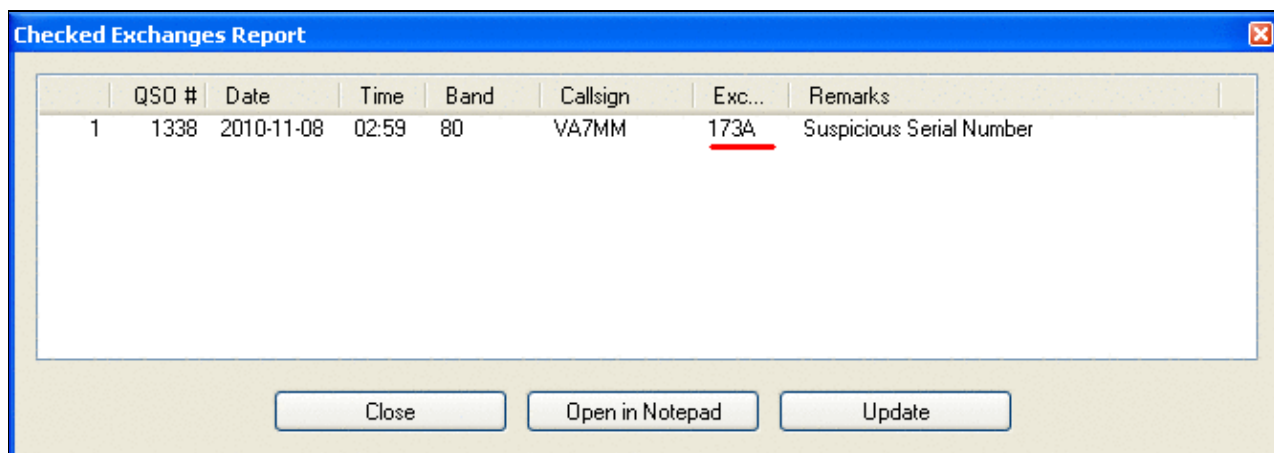

Report showing a bad QSO number received column  
To edit the bad QSOs:

1. Click **Open in Notepad** to view the report in a new window
2. Press the **Close** button to return to the logging window
3. Press [**Ctrl-G**] to open a pop-up window
4. Enter the QSO number that you want to edit, and press [**Enter**]
5. Update the QSO fields (use [**Spacebar**] to jump between them)
6. Press [**Enter**] to **save the updates on that QSO**, or press [**Ctrl-Z**] to "undo" all changes made to that line.
7. Repeat steps 3 to 6 for all bad exchanges
8. When you are finished making updates, create a new updated Cabrillo file by selecting **File | Create log files...** from the menu.

You can return to the last line in the log by pressing [**Ctrl-G**] and [**Enter**] without entering a QSO number.

## Namespaces

- [Page](#)
- [Discussion](#)

## Variants

## Views

- [Read](#)
- [View source](#)
- [View history](#)

## More

- This page was last edited on 9 November 2010, at 21:06.

- [Privacy policy](#)
- [About Win-Test Wiki](#)
- [Disclaimers](#)



# Sweepstakes

From Win-Test Wiki

[Jump to navigation](#) [Jump to search](#)

To use Win-Test in the ARRL Sweepstakes contest, use the following as a guide.

## Contents

- [1 Define your ARRL Section, Check, and Precedence](#)
- [2 Program your CW Messages](#)
- [3 ARRL Section "equivalence" file](#)
- [4 Super Check Partial file for ARRL Sweepstakes](#)
- [5 Logging QSOs](#)
- [6 Displaying Sections worked](#)
- [7 Check your log after the contest](#)

## Define your ARRL Section, Check, and Precedence

Specify your ARRL section, entry class, power level, and year first licensed (two digits only) on the contest configuration screen as shown:

# Win-Test Wiki

**Contest configuration**

**Station**

Callsign: N6TV    Grid Square: CM97CF    Exchange (zone, ...): SCV    ?

DXCC Prefix: W    WAZ zone: 03    ITU zone: 06    State/Province/Other: CA

Name: Robert A. Wilson

Address: 51 Cheltenham Way

Address: San Jose, CA 95139-1257

Address: USA

Club: Northern California Contest Club

**Load**

N6TV    WRTC    R3/N6TV    R39WRTC    WK5T

**Save as**

N6TV    WRTC    R3/N6TV    R39WRTC    WK5T

**Contest**

Contest: ARRL Sweepstakes    Days...     This month only

Category: Single operator    Mode: CW

Overlay: ---    Band plan: Default    Setup...

Class: High power    License year: 72

Operators:

**Network**

Station: STN1     Enable time distribution across the network

OK    Cancel

Specify your entry class, power and year first licensed.

## Program your CW Messages

Specify your ARRL Sweepstakes CW messages using the appropriate message variables. Note that the **precedence** must be entered manually (there is no \$PREC variable yet):

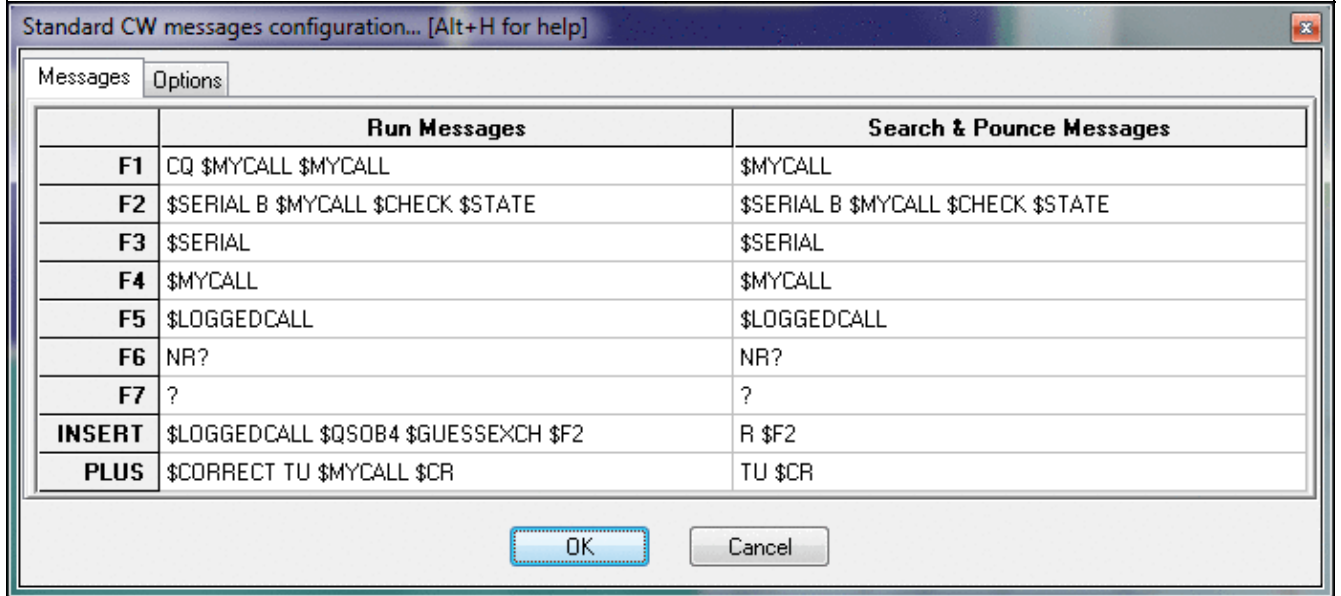

Specify your CW message. Precedence must be entered manually.

## ARRL Section "equivalence" file

Download the latest **ARRLSEC.DAT** file from

<http://download.win-test.com/files/equivalence/ARRLSEC.DAT> and save it in the Win-Test countryFiles directory (do **File | Explore | /countryFiles** directory).

This is not the official ARRL Section List, but the list of "alternate spellings" of the official ARRL sections.

## Super Check Partial file for ARRL Sweepstakes

Download the latest **MASTERSS.DTA** file from <http://www.supercheckpartial.com> and save it in the Win-Test databases directory (do **File | Explore | /databases** directory).

To ensure that it will be used, you *must* save the file with a *new name*, **DEFAULT.DTA**, not **MASTERSS.DTA**.

To verify that the **DEFAULT.DTA** file is being used, right click on the Check Partial window, as shown below:

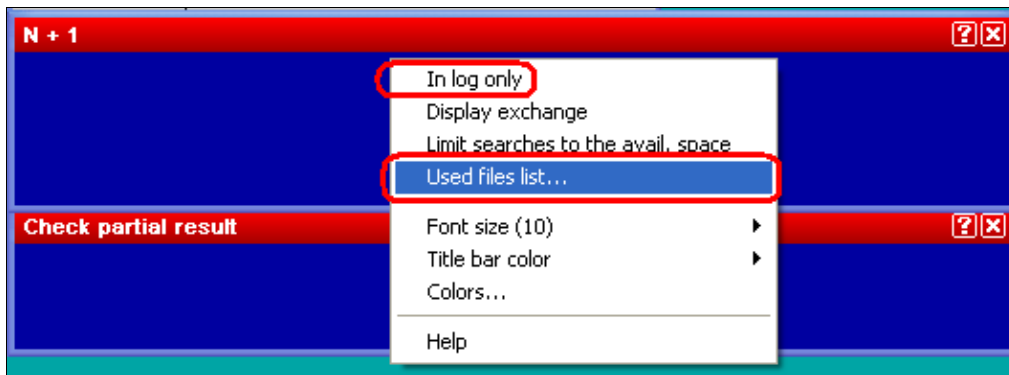

Click **Used files list** to display the name of the Super Check Partial file that is being used. Make sure **In log only** is *not* checked.

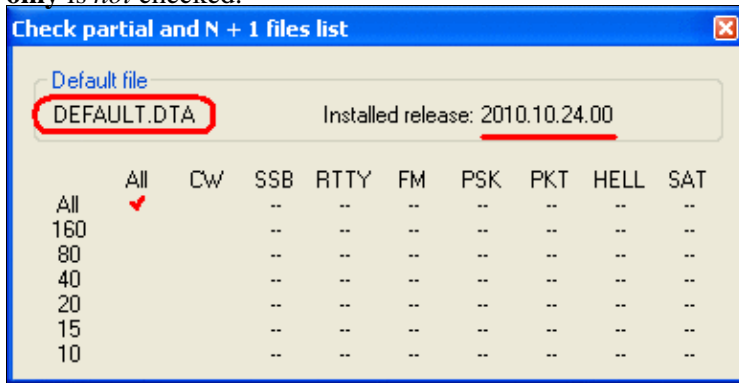

Note that **DEFAULT.DTA** is being used, and that it is current.

## Logging QSOs

Spacebar jumps between fields in exchange order: Callsign, number received, precedence, callsign (again), check, and section.

Use the [**<**] (less than) key, and the [**>**] (greater than) key to move the cursor left or right one field.

Use the indicated options to hide the redundant QSO number in the first column, and make the up and down arrow keys stay in the same column to make it easier to edit exchange data entered on a previous line:

The screenshot shows the Win-Test application interface. The 'Log' menu is open, and the 'Stay in field when moving up and down in the log' option is checked. Below the menu is a table of QSO logs.

Bd	Time	N°	N°	P	Callsign	Chk	Rcvd	Mult	Pts
80	02:05	1271	134	A	KK0HF	85	KS		2
80	02:08	1272	119	A	NG6E	62	LAX		2
80	02:09	1273	150	A	NR7T	75	UT		2
80	02:09	1274	851	U	W6PZ	56	SF		2
80	02:12	1275	288	B	K7MI	72	OR		2
80	02:13	1276	720	A	WN6K	75	SDG		2
40	02:17	1277	124	A	K7RR	69	WWA		2
40	02:21	1278	471	B	K2KQ	47	ENY		2
40	02:30	1279	196	B	KW8N	69	OH		2
80		1280							0



Log entry for ARRL Sweepstakes. Right click on the logging window to change the Log options to those indicated.

### Displaying Sections worked

Press [Alt-Z] to display the worked sections list. Right click and check **Marks** to order sections by call district:

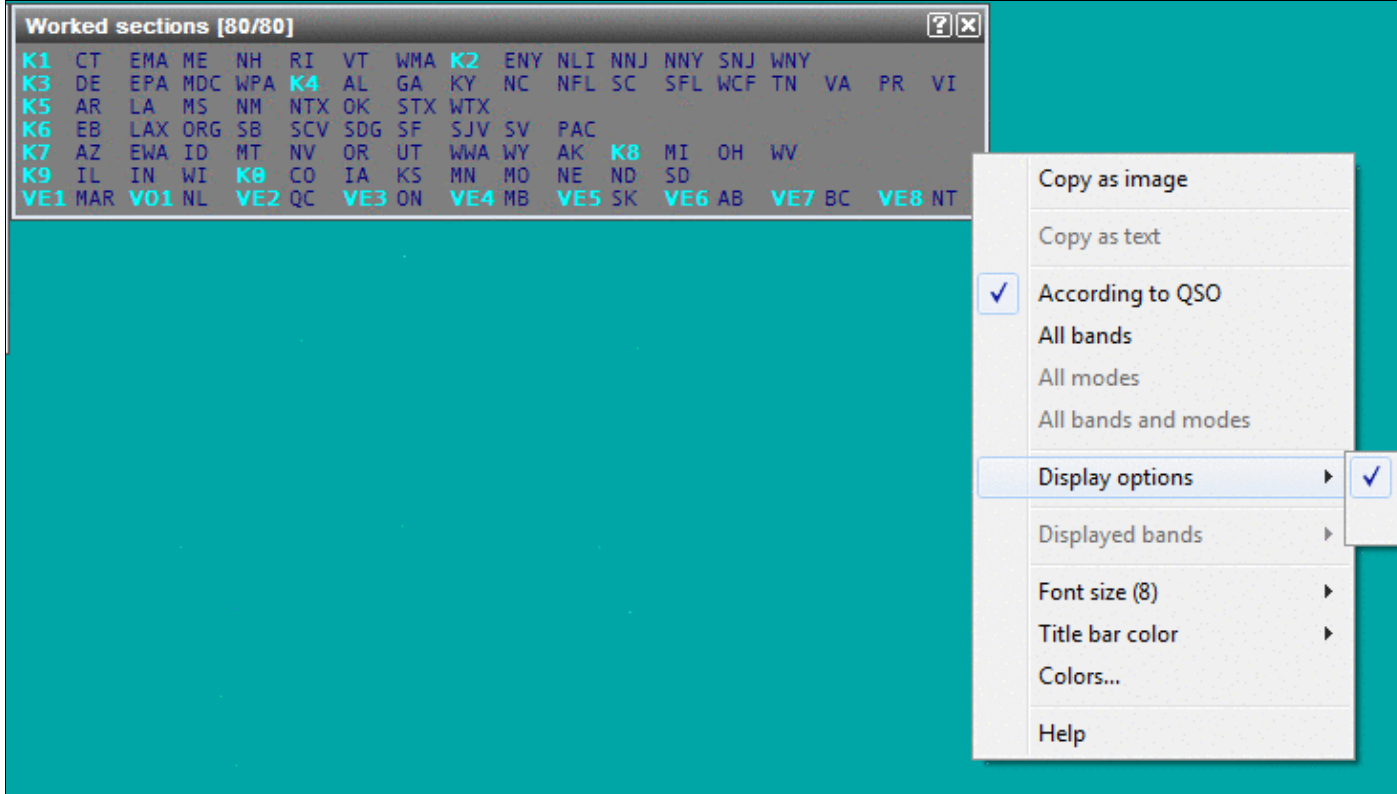

Ordering ARRL section list by call district

## Check your log after the contest

During the contest, Win-Test allows you to log just about anything in any column, including invalid QSO numbers like "1A" and invalid Precedences and non-numeric Check values. The **Search for possible bad exchanges** tool can be used to find and correct these.

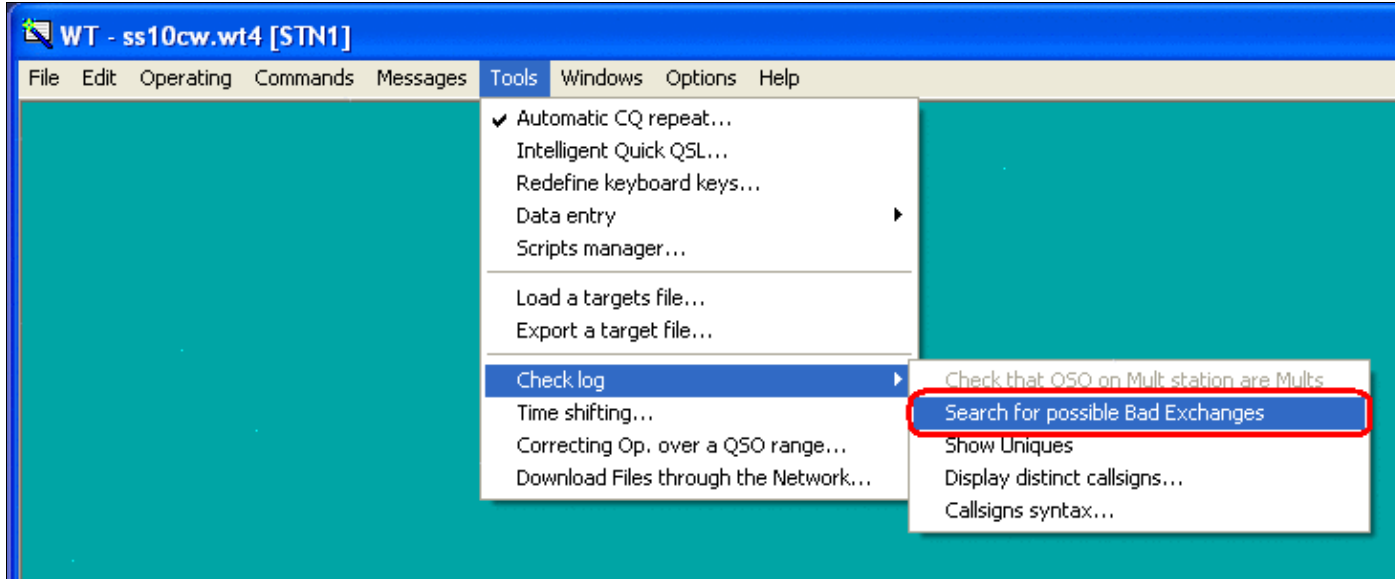

How to search for possible bad exchanges anywhere in your log

The report indicates all QSOs with a problem:

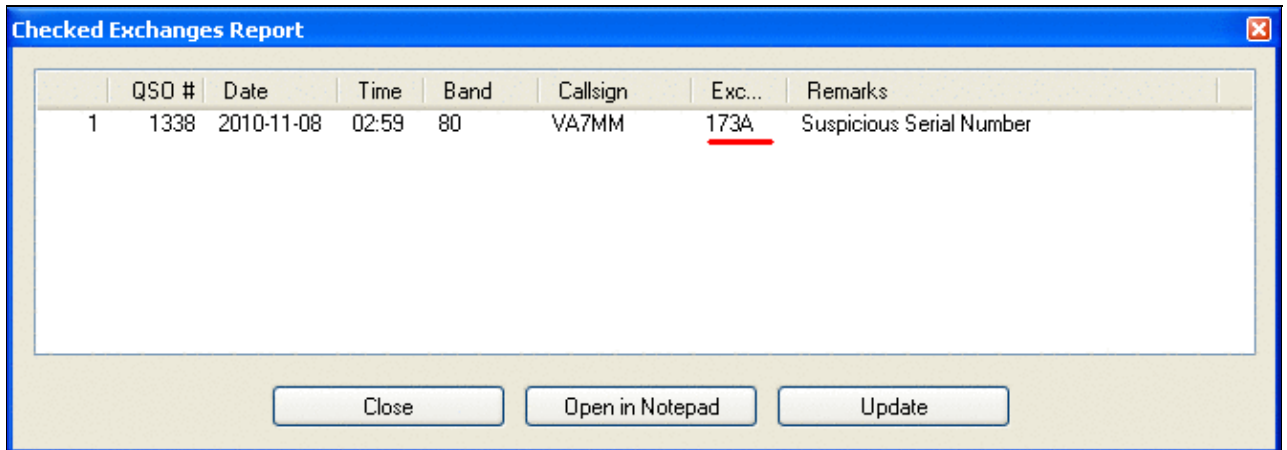

Report showing a bad QSO number received column  
To edit the bad QSOs:

1. Click **Open in Notepad** to view the report in a new window
2. Press the **Close** button to return to the logging window
3. Press [**Ctrl-G**] to open a pop-up window
4. Enter the QSO number that you want to edit, and press [**Enter**]
5. Update the QSO fields (use [**Spacebar**] to jump between them)
6. Press [**Enter**] to **save the updates on that QSO**, or press [**Ctrl-Z**] to "undo" all changes made to that line.
7. Repeat steps 3 to 6 for all bad exchanges
8. When you are finished making updates, create a new updated Cabrillo file by selecting **File | Create log files...** from the menu.

You can return to the last line in the log by pressing [**Ctrl-G**] and [**Enter**] without entering a QSO number.

## Namespaces

- [Page](#)
- [Discussion](#)

## Variants

## Views

- [Read](#)
- [View source](#)
- [View history](#)

## More

- This page was last edited on 9 November 2010, at 21:06.

- [Privacy policy](#)
- [About Win-Test Wiki](#)
- [Disclaimers](#)



# Talk:Mailing List

From Win-Test Wiki

[Jump to navigation](#) [Jump to search](#)

Hi there guys I am Juan EA5BM new wintest user. For now I am playing with this soft and I will test in proper contest.

I have a few problems with this soft I can expose. I have installed the registered version into a new laptop running winXP without serial and paralell ports (db9 and db25), all the conectors are USB :-((((.

The first problem is how to transmit cw thourgh a usb port. DLPORTIO.SYS and .DLL have been installed, I have purchased an usb to db25 printer port adaptor, but wintest seems do not recognize.

This usb adapter is recognized in control panel/system/hardware as a Universal Serial Bus controller/ USB printing Suport but not as LPT or emulled LPT.

¿What can I do?

The second problem (not sure if consequence of the first) is that I can not hear de cw I transmit running WT. The laptop speaker runs OK in many programs but not in WT. (f.e. pushing F1 CQ is not heard on laptop)

¿ Any idea about what is happening?

As you can deduce I am not computer techincal.

Any answer and help will be appreciated. Juan, EA5BM

## Namespaces

- [Page](#)
- [Discussion](#)

## Variants

## Views

- [Read](#)
- [View source](#)
- [View history](#)

## More

- This page was last edited on 5 January 2007, at 22:10.
- [Privacy policy](#)
- [About Win-Test Wiki](#)
- [Disclaimers](#)



# Talk:StyleSheet

From Win-Test Wiki

[Jump to navigation](#) [Jump to search](#)

## Punctuation

- There is no space character before a full stop, exclamation mark or a colon.

## Screenshots

- Currently, the text reads, "Use PNG or GIF format for the pictures. JPEG is normally not suitable for screen captures." Any particular reason for that comment? --[M0CLW](#) 15:56, 5 August 2006 (BST)
  - ◆ If you don't select the correct JPEG variant, pictures will interpolate and so the edges and corners of windows look

soft and tend to break up. There is a JPEG variant that will do (lossless) - but then file sizes tend to become rather large. JPEG was made for natural pictures not for graphics, GIF and PNG are better suited for screenshots. --[Ben](#) 17:12, 5 August 2006 (BST)

## Namespaces

- [Page](#)
- [Discussion](#)

## Variants

## Views

- [Read](#)
- [View source](#)
- [View history](#)

## More

- This page was last edited on 5 August 2006, at 16:13.
- [Privacy policy](#)
- [About Win-Test Wiki](#)
- [Disclaimers](#)



# DX Cluster/Telnet

From Win-Test Wiki

< [DX Cluster](#)

[Jump to navigation](#) [Jump to search](#)

Connecting to a telnet cluster is the work of an external application provided as part of the Win-Test package called 'wtDxTelnet'.

*This program maintains the connection to the cluster, **NOT** Win-Test itself!*

This is a commonly asked question on the support reflector, hence the emphasis!

## Contents

- [1 Configuring wtDxTelnet \(single-op environment\)](#)
  - ◆ [1.1 Configuring Win-Test for wtDxTelnet](#)
  - ◆ [1.2 Configuring wtDxTelnet](#)
  - ◆ [1.3 Testing the configuration](#)
- [2 Configuring wtDxTelnet \(multi-op environment\)](#)
  - ◆ [2.1 Obtaining your network broadcast address](#)
  - ◆ [2.2 Configuring wtDxTelnet](#)
- [3 See Also](#)
  - ◆ [3.1 In the manual](#)

## Configuring wtDxTelnet (single-op environment)

The reasoning behind using a separate program for maintaining a telnet connection was to be able to have only one connection in a multi-op environment, rather than having to connect every time on each individual machine in the shack!

Configuration of wtDxTelnet is not a hard process, and like everything else configuration-based in Win-Test, needs only to be done once. This section explains how to setup wtDxTelnet and Win-Test for use in a single-op environment (with wtDxTelnet and Win-Test applications both running on the same computer). There are further instructions on what has to be done in a multi-op environment below.

## Configuring Win-Test for wtDxTelnet

First, open the [Configure Interfaces](#) dialog in Win-Test via `Options | Configure interfaces...`, or type **SETUP [Enter]**. Check the box labeled **Enable local network** and ensure it looks like the following:

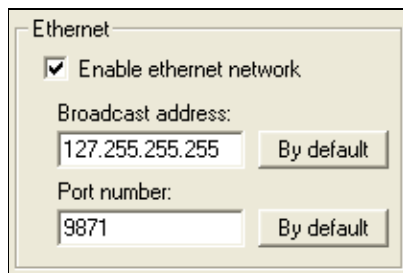

Enter the "loopback" broadcast IP address **127.255.255.255**.

Pres **[OK]** and that is the only change of configuration you'll have to make to Win-Test itself.

## Configuring wtDxTelnet

Now start wtDxTelnet (in Windows, Start | Programs | Win-Test | wtDxTelnet). From the menu select Options | Win-Test network properties and the screen should look like the following:

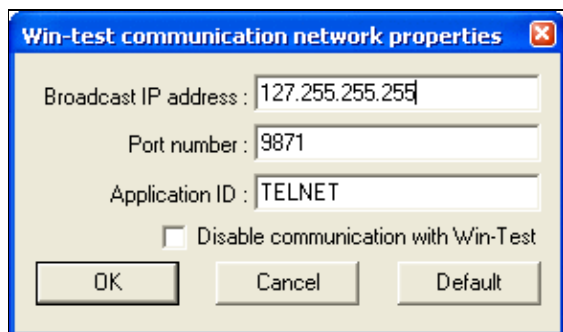

Use the same **Broadcast address** and **Port number** that you specified in Win-Test above.

These options may be greyed out by default, in which case be sure to *uncheck* the box labeled **Disable communication with Win-Test**, and then you can edit the values.

Next from the same menu choose **Options | DxCluster properties**. The screen should look something like this:

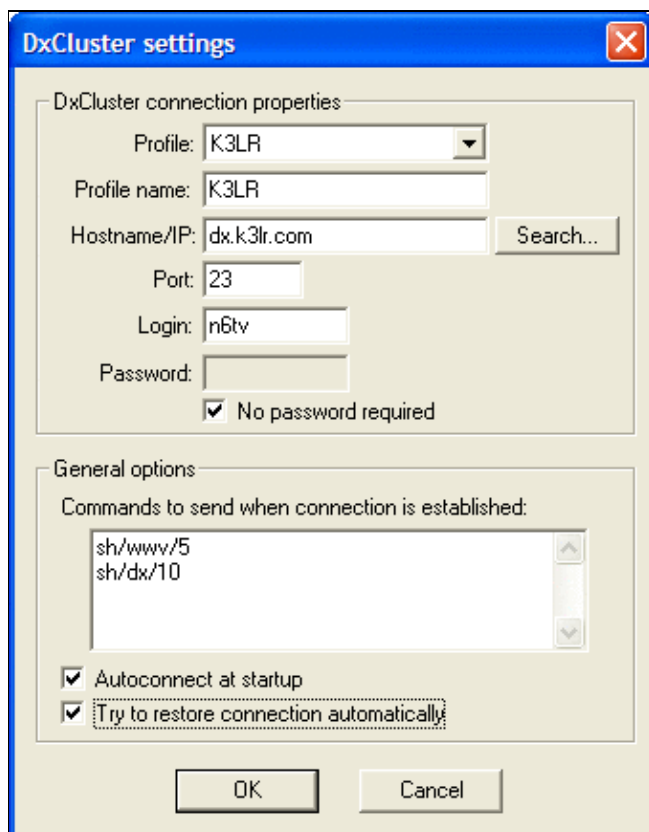



A quick description of the various settings here:

- **Profile** - Select `profile-1` to `profile-10` from the drop-down list to save settings for up to ten different DX Clusters
- **Profile name** - You may change a profile name from the default name "`profile-1`" to something that is easier to remember, such as the node's callsign, by entering a new name here
- **Hostname/IP** - The host name (e.g. `dx.k3lr.com`, `gb7djk.dxcluster.org`, etc.) or the IP address of the DX cluster that you want to connect to. Press [**Search . . .**] to select from an alphabetical list of commonly-used DX Cluster nodes
- **Port** - The port number used by the DX cluster you wish to connect to. For an ordinary TELNET node, use 23. For DX Spider clusters (quite common nowadays), use 7300 or 8000. Be sure to select the same syntax in Win-Test using [Menu:Options#DX Cluster window shortcuts](#).
- **Login** - This is your callsign (what you would enter at the DX Cluster's **Login:** prompt)
- **Password** - There is a password (if required) to allow you to login to the cluster. Most do not require one, so just check the box labeled **No password required**
- **Commands to send at connection** - Use this to send commands such as `sh/wwv/5` and `sh/dx/10` when you first connect
- **Autoconnect at startup** - Check this to connect to the cluster automatically whenever you start `wtDxTelnet`
- **Try to restore connection automatically** - Check this to have `wtDxTelnet` restore this connection automatically if it detects that you have been disconnected (for whatever reason)

Press [**OK**] to save all changes.

**Note that `wtDxTelnet` must always be running in the background if you want to stay connected to the cluster.** To have `wtDxTelnet` started automatically by Win-Test, use [Start/stop wtDxTelnet automatically](#), under `Options | DX cluster` in Win-Test.

## Testing the configuration

Now you have setup both Win-Test and `wtDxTelnet`, it is time to ensure you can connect to the cluster, login fine and see spots coming through in Win-Test. Ensure that `wtDxTelnet` is connected to the cluster (you can see that in the main `wtDxTelnet` window) and if not, use the `DxCluster|Connect` menu option.

In Win-Test, open the DX cluster monitor window by going to the `Windows|Dx-Cluster monitor` menu option or using the `Alt+O` keyboard shortcut. You should immediately start seeing data coming through. Send a command to the cluster *from* Win-Test to ensure it is working - use the `Commands|Dx-Cluster` menu option or the `Alt+T` keyboard shortcut. Now send something like `sh/dx/1` to get the most recent spot sent through. All being well, you should see the data in the cluster monitor window in Win-Test (and also in the `wtDxTelnet` window).

If you can see data coming through in the `wtDxTelnet` window, but *not* in Win-Test, please check the network settings in both Win-Test and `wtDxTelnet` (see above).

## Configuring `wtDxTelnet` (multi-op environment)

The above guide covers setting up Win-Test and `wtDxTelnet` in a single-op environment and thankfully the only difference between the two configurations is the networking set-up in `wtDxTelnet`.

## Obtaining your network broadcast address

In order to configure wtDxTelnet correctly, you need to know the IP broadcast address you have set in Win-Test for the network. Simply open the `Options|Configure interfaces` dialog within Win-Test (or type **SETUP [Enter]**). Press the **[By default]** button to have Win-Test automatically calculate the broadcast address based on your PC's current IP address.

The broadcast address is found as follows:

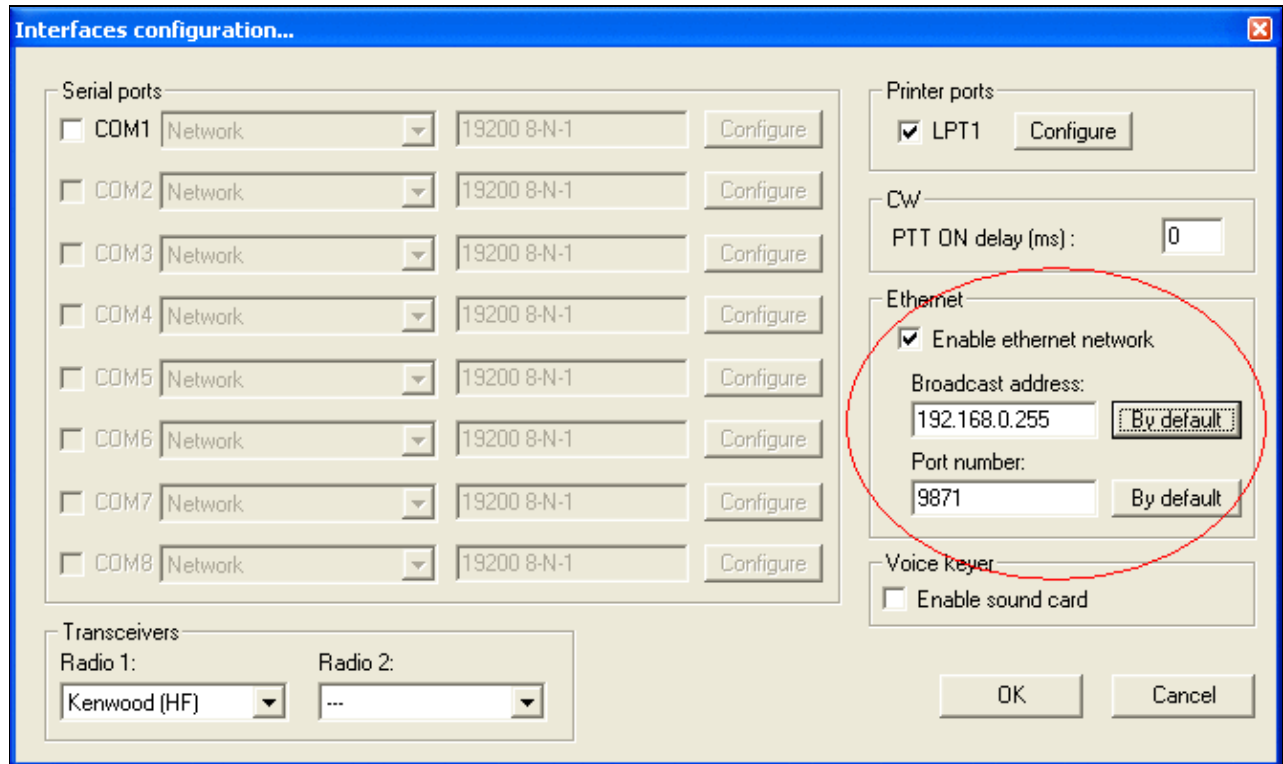

So, in this above example, the broadcast address is 192.168.0.255. Use this same broadcast address and port number in wtDxTelnet and in other networked PCs.

## Configuring wtDxTelnet

The advantage of wtDxTelnet in a multi-op environment is that you only require *one* connection to a DX cluster and the spots/data will be propagated across the entire network to **all** networked machines.

You can follow the steps above, for configuring wtDxTelnet in a single-op environment, but the network properties will be different. Goto the Options | Win-Test network properties menu in wtDxTelnet, and this time, use the following details:

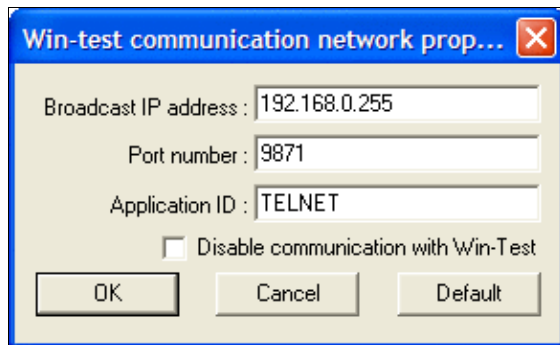

- **Broadcast IP address** - it is **very** important that you get the address absolutely correct for the DX cluster data to be propagated across the network. It **must** match the broadcast address which you have specified in Win-Test's network properties in the step above. Using our above example, in this instance, the broadcast IP address would be 192.168.0.255. Just press the **[Default]** button shown above, and wtDxTelnet will calculate the same default broadcast address as Win-Test's **[By default]** button.
- **Port number** can usually be left as-is. Again, it must match what has been specified in Win-Test. The default port number is 9871, and use 9871 unless you have already changed the port number (and thus you should know what you're doing and thus you should know the port number).
- **Application ID** can also be left as TELNET.

Press **[OK]** and you have successfully configured both Win-Test and wtDxTelnet. You should now test the configuration.

**Note that wtDxTelnet must always be running in the background if you want to stay connected to the cluster.** To have wtDxTelnet started automatically by Win-Test, use Start/stop wtDxTelnet automatically, under Options | DX cluster in Win-Test.

## See Also

### In the manual

- Setting up networking in a multi-op environment

## Namespaces

- [Page](#)
- [Discussion](#)

## Variants

## Views

- [Read](#)
- [View source](#)
- [View history](#)

## More

- This page was last edited on 30 December 2021, at 10:00.

- [Privacy policy](#)
- [About Win-Test Wiki](#)
- [Disclaimers](#)



# Talk:DX Cluster/Telnet

From Win-Test Wiki

[Jump to navigation](#) [Jump to search](#)

## Namespaces

- [Page](#)
- [Discussion](#)

## Variants

## Views

- [Read](#)
- [View source](#)
- [View history](#)

## More

- This page was last edited on 18 March 2011, at 11:42.

- [Privacy policy](#)
- [About Win-Test Wiki](#)
- [Disclaimers](#)

- The logo consists of a small yellow sun icon on the left, followed by the text "Powered By" in a small font, and "MediaWiki" in a larger font below it, all contained within a thin black rectangular border.

# Talk:DX Cluster/Telnet

From Win-Test Wiki

[Jump to navigation](#) [Jump to search](#)

## Namespaces

- [Page](#)
- [Discussion](#)

## Variants

## Views

- [Read](#)
- [View source](#)
- [View history](#)

## More

- This page was last edited on 18 March 2011, at 11:42.

- [Privacy policy](#)
- [About Win-Test Wiki](#)
- [Disclaimers](#)

-  The logo consists of a small yellow sun icon to the left of the text "Powered By MediaWiki".

# DX Cluster/Telnet

From Win-Test Wiki

< [DX Cluster](#)

[Jump to navigation](#) [Jump to search](#)

Connecting to a telnet cluster is the work of an external application provided as part of the Win-Test package called 'wtDxTelnet'.

*This program maintains the connection to the cluster, **NOT** Win-Test itself!*

This is a commonly asked question on the support reflector, hence the emphasis!

## Contents

- [1 Configuring wtDxTelnet \(single-op environment\)](#)
  - ◆ [1.1 Configuring Win-Test for wtDxTelnet](#)
  - ◆ [1.2 Configuring wtDxTelnet](#)
  - ◆ [1.3 Testing the configuration](#)
- [2 Configuring wtDxTelnet \(multi-op environment\)](#)
  - ◆ [2.1 Obtaining your network broadcast address](#)
  - ◆ [2.2 Configuring wtDxTelnet](#)
- [3 See Also](#)
  - ◆ [3.1 In the manual](#)

## Configuring wtDxTelnet (single-op environment)

The reasoning behind using a separate program for maintaining a telnet connection was to be able to have only one connection in a multi-op environment, rather than having to connect every time on each individual machine in the shack!

Configuration of wtDxTelnet is not a hard process, and like everything else configuration-based in Win-Test, needs only to be done once. This section explains how to setup wtDxTelnet and Win-Test for use in a single-op environment (with wtDxTelnet and Win-Test applications both running on the same computer). There are further instructions on what has to be done in a multi-op environment below.

## Configuring Win-Test for wtDxTelnet

First, open the [Configure Interfaces](#) dialog in Win-Test via `Options | Configure interfaces...`, or type **SETUP [Enter]**. Check the box labeled **Enable local network** and ensure it looks like the following:

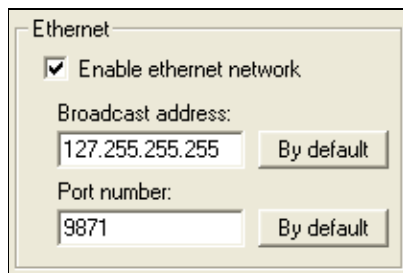

Enter the "loopback" broadcast IP address **127.255.255.255**.

Pres **[OK]** and that is the only change of configuration you'll have to make to Win-Test itself.

## Configuring wtDxTelnet

Now start wtDxTelnet (in Windows, Start | Programs | Win-Test | wtDxTelnet). From the menu select Options | Win-Test network properties and the screen should look like the following:

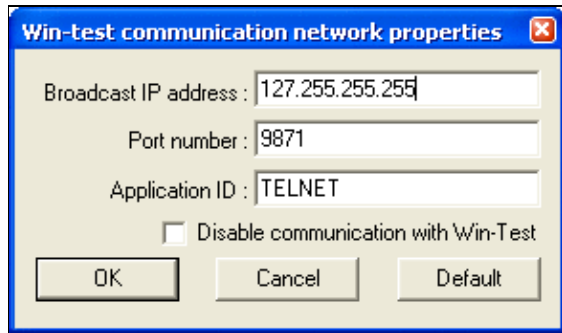

Use the same **Broadcast address** and **Port number** that you specified in Win-Test above.

These options may be greyed out by default, in which case be sure to *uncheck* the box labeled **Disable communication with Win-Test**, and then you can edit the values.

Next from the same menu choose **Options | DxCluster properties**. The screen should look something like this:

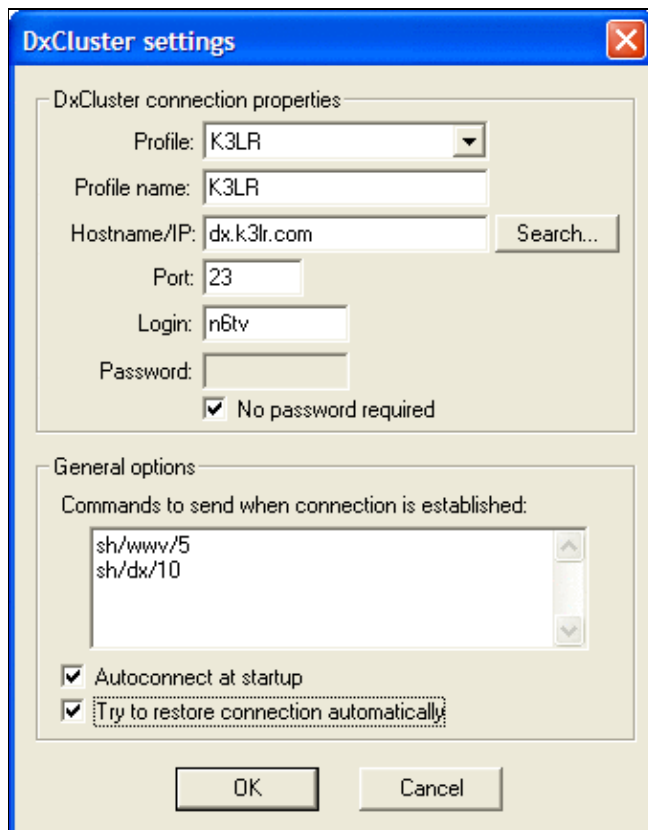



A quick description of the various settings here:

- **Profile** - Select `profile-1` to `profile-10` from the drop-down list to save settings for up to ten different DX Clusters
- **Profile name** - You may change a profile name from the default name "`profile-1`" to something that is easier to remember, such as the node's callsign, by entering a new name here
- **Hostname/IP** - The host name (e.g. `dx.k3lr.com`, `gb7djk.dxcluster.org`, etc.) or the IP address of the DX cluster that you want to connect to. Press [**Search . . .**] to select from an alphabetical list of commonly-used DX Cluster nodes
- **Port** - The port number used by the DX cluster you wish to connect to. For an ordinary TELNET node, use 23. For DX Spider clusters (quite common nowadays), use 7300 or 8000. Be sure to select the same syntax in Win-Test using [Menu:Options#DX Cluster window shortcuts](#).
- **Login** - This is your callsign (what you would enter at the DX Cluster's **Login:** prompt)
- **Password** - There is a password (if required) to allow you to login to the cluster. Most do not require one, so just check the box labeled **No password required**
- **Commands to send at connection** - Use this to send commands such as `sh/wwv/5` and `sh/dx/10` when you first connect
- **Autoconnect at startup** - Check this to connect to the cluster automatically whenever you start `wtDxTelnet`
- **Try to restore connection automatically** - Check this to have `wtDxTelnet` restore this connection automatically if it detects that you have been disconnected (for whatever reason)

Press [**OK**] to save all changes.

**Note that `wtDxTelnet` must always be running in the background if you want to stay connected to the cluster.** To have `wtDxTelnet` started automatically by Win-Test, use [Start/stop wtDxTelnet automatically](#), under `Options | DX cluster` in Win-Test.

## Testing the configuration

Now you have setup both Win-Test and `wtDxTelnet`, it is time to ensure you can connect to the cluster, login fine and see spots coming through in Win-Test. Ensure that `wtDxTelnet` is connected to the cluster (you can see that in the main `wtDxTelnet` window) and if not, use the `DxCluster|Connect` menu option.

In Win-Test, open the DX cluster monitor window by going to the `Windows|Dx-Cluster monitor` menu option or using the `Alt+O` keyboard shortcut. You should immediately start seeing data coming through. Send a command to the cluster *from* Win-Test to ensure it is working - use the `Commands|Dx-Cluster` menu option or the `Alt+T` keyboard shortcut. Now send something like `sh/dx/1` to get the most recent spot sent through. All being well, you should see the data in the cluster monitor window in Win-Test (and also in the `wtDxTelnet` window).

If you can see data coming through in the `wtDxTelnet` window, but *not* in Win-Test, please check the network settings in both Win-Test and `wtDxTelnet` (see above).

## Configuring `wtDxTelnet` (multi-op environment)

The above guide covers setting up Win-Test and `wtDxTelnet` in a single-op environment and thankfully the only difference between the two configurations is the networking set-up in `wtDxTelnet`.

## Obtaining your network broadcast address

In order to configure wtDxTelnet correctly, you need to know the IP broadcast address you have set in Win-Test for the network. Simply open the `Options | Configure interfaces` dialog within Win-Test (or type **SETUP [Enter]**). Press the **[By default]** button to have Win-Test automatically calculate the broadcast address based on your PC's current IP address.

The broadcast address is found as follows:

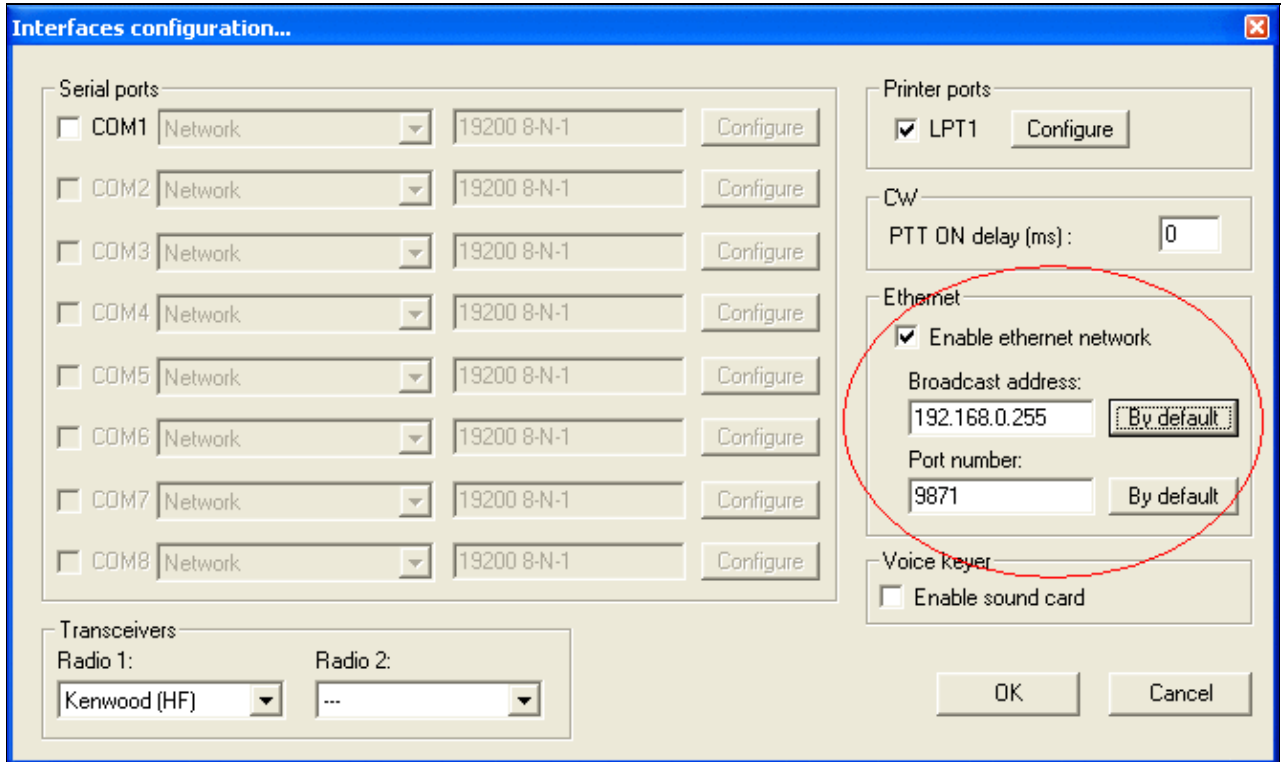

So, in this above example, the broadcast address is 192.168.0.255. Use this same broadcast address and port number in wtDxTelnet and in other networked PCs.

## Configuring wtDxTelnet

The advantage of wtDxTelnet in a multi-op environment is that you only require *one* connection to a DX cluster and the spots/data will be propagated across the entire network to **all** networked machines.

You can follow the steps above, for configuring wtDxTelnet in a single-op environment, but the network properties will be different. Goto the Options | Win-Test network properties menu in wtDxTelnet, and this time, use the following details:

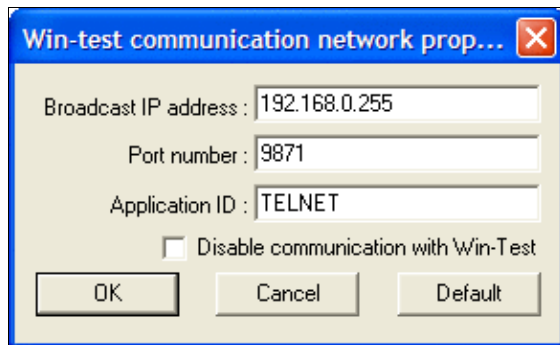

- **Broadcast IP address** - it is **very** important that you get the address absolutely correct for the DX cluster data to be propagated across the network. It **must** match the broadcast address which you have specified in Win-Test's network properties in the step above. Using our above example, in this instance, the broadcast IP address would be 192.168.0.255. Just press the **[Default]** button shown above, and wtDxTelnet will calculate the same default broadcast address as Win-Test's **[By default]** button.
- **Port number** can usually be left as-is. Again, it must match what has been specified in Win-Test. The default port number is 9871, and use 9871 unless you have already changed the port number (and thus you should know what you're doing and thus you should know the port number).
- **Application ID** can also be left as TELNET.

Press **[OK]** and you have successfully configured both Win-Test and wtDxTelnet. You should now test the configuration.

**Note that wtDxTelnet must always be running in the background if you want to stay connected to the cluster.** To have wtDxTelnet started automatically by Win-Test, use Start/stop wtDxTelnet automatically, under Options | DX cluster in Win-Test.

## See Also

### In the manual

- Setting up networking in a multi-op environment

## Namespaces

- [Page](#)
- [Discussion](#)

## Variants

## Views

- [Read](#)
- [View source](#)
- [View history](#)

## More

- This page was last edited on 30 December 2021, at 10:00.

- [Privacy policy](#)
- [About Win-Test Wiki](#)
- [Disclaimers](#)



# Text commands

From Win-Test Wiki

[Jump to navigation](#) [Jump to search](#)

## Text Commands

Text commands are a comfortable and fast way to access different functions of the Win-Test software. These commands have to be typed right into the callsign field of the [Log entry window](#). They will be executed after pressing [**Enter**]. If the command was executed successfully, the command text will be deleted from the callsign field.

## Contents

- [1 Changing Bands or Jumping to a Frequency](#)
- [2 Changing Mode](#)
- [3 List of Text Commands](#)
  - ◆ [3.1 CW Functions](#)
  - ◆ [3.2 Voice Keyer Control Functions](#)
  - ◆ [3.3 Multi Operating](#)
  - ◆ [3.4 Open/Close/Database Functions](#)
  - ◆ [3.5 Frequency Control Functions](#)
  - ◆ [3.6 Log synchronisation](#)
  - ◆ [3.7 WinKey](#)
  - ◆ [3.8 Other Functions](#)

## Changing Bands or Jumping to a Frequency

You can directly enter the band to which you want to QSY (if permitted for the current contest): **160**, **80**, **40**, **144**, **432**, **241G**, etc.

For frequencies below 30 MHz, enter the wavelength in meters (**80** for 3.8 MHz, not **75**). For frequencies above 30 MHz and below 10 GHz, enter the frequency in MHz. Above (and including) 10 GHz, enter **10G** (or **24G**, etc.). This behaviour may depend on the [Tools | Data Entry | Priority](#) setting.

You can also directly type a frequency (in kHz): for example **14234.4**, **1843**, **144300**, etc. If a radio is connected to your computer, it will jump to the desired frequency. You can also just enter the kHz part of the frequency of the current band (e.g. while on 20m, entering **035.5** will tune your radio on 14035.5). Finally, you can also enter the frequency by omitting the decimal point (CT style) (e.g. **18404** will tune your radio on 1840.4).

Of course, all the Win-Test windows will be updated according to the new frequency or band.

To return to your last CQ frequency, press [**Alt-F4**].

## Changing Mode

You can directly change the operating mode by typing **CW**, **SSB** etc. The mode will be switched as soon as you press Enter.

There are also shortcuts for changing the mode: **Ctrl-F1** or **Ctrl-F2** will cycle through all the available modes.

Of course, the chosen mode will have to be compatible with the rules of the chosen contest, otherwise Win-Test will ignore this command (error detection in the field).

## List of Text Commands

These text commands provide fast access to many of the functions listed in the Win-Test menus. Just type the text command in the callsign field, and press **[Enter]**.

### CW Functions

- **BURSTS**: Enable CW speed bursts (controlled with ++/-- in macros), equivalent to Options | CW | Speed Bursts enabled
- **NOBURSTS**: Disable CW speed bursts (controlled with ++/-- in macros), equivalent to Options | CW | Speed Bursts disabled
- **CORRECT**: Equivalent to Options | CW | Correction | Enabled
- **NOCORRECT**: Equivalent to Options | CW | Correction | Disabled
- **CTSPACE**: Equivalent to Options | CW | Shortened spaces (CT spaces) enabled
- **NOCTSPACE**: Equivalent to Options | CW | Shortened spaces (CT spaces) disabled
- **CUTON**: Enable cut numbers translation
- **CUTOFF**: Disable cut numbers translation
- **CWAUTO**: Enable CW Auto Sending Mode
- **CWAUTO3**: Start CW Auto Sending after 3 characters in the callsign field
- **CWAUTO4**: Start CW Auto Sending after 4 characters in the callsign field
- **CWAUTOOFF** (or **NOCWAUTO**): Disable CW Auto Sending Mode
- **CWFULLABBREV** (or **FULLABBREV**): Equivalent to Options | CW | Serial number | Abbreviated
- **CWPROABBREV** (or **PROABBREV**): Equivalent to Options | CW | Serial number | Pro
- **CWSEMIABBREV** (or **SEMIABBREV**): Equivalent to Options | CW | Serial number | Half abbreviated
- **NOCWABBREV** (or **NOABBREV**): Equivalent to Options | CW | Serial number | Not abbreviated
- **ESM** (or **NOESM**): Enable/disable Enter Sends Message Mode; equivalent to Tools | Data Entry | Enable ESM [checked]
- **LEADINGZEROS** (or **LZ**): Equivalent to Options | CW | Serial number | Leading zeros [checked]
- **LOADMSGS**: Open the current op. directory and load CW or RTTY messages from there
- **NOLEADINGZEROS** (or **NOLZ**): Equivalent to Options | CW | Serial number | Leading zeros [unchecked]
- **MESSAGES** (or **MSGS**): Equivalent to Options | CW | Modify standard messages...
- **REPEAT** (or **RPT**): Equivalent to Options | Automatic CQ repeat mode [checked]
- **RPTDELAY**: Equivalent to Tools / Automatic CQ repeat, with the focus set to the repeat interval field
- **NOREPEAT** (or **NORPT**): Equivalent to Options | Automatic CQ repeat mode [unchecked]

- **SMARTCORRECT** (or **SMART**): Equivalent to Options | CW | Correction | Smart Correction enabled
- **NOSMARTCORREC** (or **NOSMART**): Equivalent to Options | CW | Correction | Smart Correction disabled
- **SOUND**: Equivalent to Options | CW | No sound [unchecked]
- **NOSOUND**: Equivalent to Options | CW | No sound [checked]
- **SPEED** (or **CWSPEED**) Equivalent to Commands | CW speed
- **TUNE**: Equivalent to Commands | Carrier
- **VARIABLES**: Equivalent to Options | CW | Custom variables...
- **WEIGHT** (or **CWWEIGHT**): Equivalent to Commands | CW weight
- **WORKDUPE** (or **WORKDUPEON**): Equivalent to Options | CW | Work dupes (checked). The normal exchange will be sent to all dupes; the \$QSOB4 message variable will be ignored.
- **NOWORKDUPE** (or **WORKDUPEOFF**): Equivalent to Options | CW | Work dupes (unchecked). Causes the \$QSOB4 message to be sent to all dupes instead of the exchange, for example, when the [Insert] key is programmed as \$LOGGEDCALL \$QSOB4 \$GUESSEXCH \$F2

## Voice Keyer Control Functions

- **MIC**: Enables the mic input when the Voice Keyer (VK) is not playing
- **NOMIC**: Mutes the mic input when the VK is not playing (default)
- **MICWHENPLAY**: Enables the mic input when the VK is playing
- **NOMICWHENPLAY**: Mutes the mic input when the VK is playing (default)

## Multi Operating

- **BRIDGEHEAD**: Make the current station a Bridgehead station
- **INVENTORY** (or **INV**): Requests all connected Stations to send their version number and status information.
  - ◆ Time Master stations are indicated by a capital **M** character (else **m**)
  - ◆ Bridgeheads by the capital character **B** (else **b**)
  - ◆ stations which have enabled log synching are marked with a capital **S**, while **s** means log sync is disabled
- **MOVEINMYLOG**: Equivalent to tag Edit | Move in my log only
- **MULT**: Equivalent to Commands | Station type | Mult
- **NOBRIDGEHEAD**: Make the current station a non Bridgehead station
- **NOMOVEINMYLOG**: Equivalent to untag Edit | Move in my log only
- **NOSCROLLMYLOG**: Equivalent to untag Edit | Move in my log only
- **NOSUPPORT** (or **NOPARTNER**): Equivalent to Commands | Station type | Support [unchecked]
- **OPNAME** (or **MYNAME**): Edit current operator name (used in NAQP M/2 only)
- **OPON** (or **LOGIN**): Log in as an operator
- **OPOFF** (or **LOGOUT**): Log out as an operator
- **RUN1**: Equivalent to Commands | Station type | Run 1
- **RUN2**: Equivalent to Commands | Station type | Run 2
- **RUN**: Equivalent to Commands | Station type | Run
- **SUPPORT** (or **PARTNER**): Equivalent to Commands | Station type | Support [checked]
- **SCROLLMYLOG**: Equivalent to tag Edit | Move in my log only

## Open/Close/Database Functions

- **ARCHIVE**: Equivalent to File | Archive
- **AUTORELOAD** or **NOAUTORELOAD**: Equivalent to Options | Load contest at startup | Enabled
- **BYE**: Equivalent to File | Quit
- **CLEARLOG**: Equivalent to Edit | Delete all QSO
- **CLEARLOGNOW**: Equivalent to CLEARLOG, but doesn't ask for confirmation. **Use with caution!**
- **CLOSE**: Equivalent to File | Close
- **COPYLOG**: Save a copy of the current log file (.wt4) in the current log directory with a timestamp (to the nearest second) added to its name
- **COPYLOGCLEAR**: Equivalent to the COPYLOG command immediately followed by a CLEARLOG command
- **NEW**: Equivalent to File | New
- **NOTES**: Open the notes file attached to the current log
- **OPEN**: Equivalent to File | Open
- **QUIT** (or **EXIT**): Equivalent to File | Quit
- **RELOAD** (or **REOPEN**): Reopens the current opened file
- **RELOADNOW** (or **REOPENNOW**): Reopens the current opened file, but does not display the contest configuration dialog.
- **RESTART**: Restarts Win-Test
- **SAVELOG**: Equivalent to File | Backup contest
- **WRITEDB**: Equivalent to File | Update database
- **WRITELOG** (or **MAKELOG**): Equivalent to File | Creating log files

## Frequency Control Functions

- **PASSFREQ** (or **QSYFREQ**): Equivalent to Commands | QSY frequency
- **QSX**: Equivalent to Commands | Split frequency
- **NCDXF**: Put Radio on NCDXF frequency of current band
- **NOQSX** (or **SPLITOFF**): turns split operation off
- **RUNFREQ**: Moves to last Run frequency, equivalent to **Alt-F4**
- **SPLITFREQ**: Equivalent to Commands | Split frequency
- **NOSPLIT** (or **SPLITOFF**): turns split operation off
- **SWAP**: Equivalent to Commands | Swap the frequency on both radios

## Log synchronisation

- **SYNC** (or **SYNLOGS**): Equivalent to Options | Disable log synchronization on network (unchecked)
- **NOSYNC** (or **NOSYNLOGS**): Equivalent to Options | Disable log synchronization on network (checked)

## WinKey

- **WKSETUP**: Equivalent to Options | WinKey configuration...
- **WKSAP** (or **WKREVERSE**): Equivalent to Options | WinKey configuration... | Swap paddles. Reverse the paddles attached to your WinKey. This is a toggle; paddles change every time this command is run.



## Other Functions

- **AUTOCQ** or **CQAUTO**: Enable automatic CQ Repeat mode
- **AUTOCW** or **CWAUTO**: Enable CW Auto Send
- **BLOCKCARET**: Change line cursor to block cursor
- **BLOCKCURSOR**: Change line cursor to block cursor
- **CLEARGAB**: Clear Gab window (Alt-I)
- **CLOSEALL**: Equivalent to Windows | Close all
- **CTYFILES** or **COUNTRYFILES**: Eq. to Options | Data files | Country files...
- **DEFINEKEYS**: Equivalent to Options | Redefine keyboard keys
- **EZSETUP**: Equivalent to Options / EZMaster configuration...
- **HEADERS**: Equivalent to Options | Log display | Hide headers disabled
- **NOHEADERS**: Equivalent to Options | Log display | Hide headers enabled
- **HELP**: Open reference manual
- **KEYB**: Change keyboard layout, append layout designator with slash, like **KEYB/FRA,KEYB/DEU,KEYB/ENU**; see [1] for details.
- **MKSETUP**: Equivalent to Options / MK/MKII/MK2R configuration...
- **MP3SETUP**: Equivalent to Options / MP3 configuration...
- **NOAUTOCQ** or **NOCQAUTO**: Disable automatic CQ Repeat mode
- **NOAUTOCW** or **NOCWAUTO**: Disable CW Auto Send
- **NOBLOCKCURSOR**: Change block cursor to line cursor
- **NOBLOCKCARET**: Change block cursor to line cursor
- **NOOFFSET** (or **NOOFFSETS** or **OFFSETOFF** or **OFFSETSOFF**): Disable frequency offset
- **NORECORD**: Stop contest recording
- **NOQQL** (or **QOSLOFF**): Disable Quick QSL Feature
- **NORPTESCONLY**: Stop AutoCQ by any keyboard activity
- **NORUNSP** (or **RUNSPOFF**): Disable RUN/S&P-Switching
- **NOTEXTCMDTIP** (or **NOTXTCMDTIP**): Don't display tooltips in Menu operations
- **OFFSET** (or **OFFSETS** or **OFFSETON** or **OFFSETSON**): Enable frequency offset
- **OFFSETSETUP**: To start frequency offset dialogue
- **OFFSETSSETUP**: To start frequency offset dialogue
- **QQL** (or **QOSLON**): Enable Quick QSL Feature
- **QUICKQSL**: Enable intelligent Quick QSL feature, bring up configuration menu
- **RECORD**: Start contest recording
- **REMAPKEYS**: Equivalent to Options | Redefine keyboard keys
- **REMOTE**: Equivalent to Commands | Remote commands... Opens the Remote Commands Dialog
- **RPTESCONLY**: Stop AutoCQ by pressing the Escape key only
- **RTTYSETUP**: Equivalent to Options | RTTY Configuration...
- **RUNSP** (or **RUNSPON**): Enable RUN/S&P-Switching
- **SCRIPTS**: Equivalent to Tools | Scripts Manager
- **SETUP**: Equivalent to Options | Configure Interfaces
- **STARTRECORD**: Start contest recording
- **STOPRECORD**: Stop contest recording
- **TEXTCMDTIP** (or **TXTCMDTIP**): Display tooltips in Menu operations
- **VERSION**: Equivalent to Help | About
- **WCY**: Equivalent to Windows | Solar Activity | Displayed data | WCY
- **WWV**: Equivalent to Windows | Solar Activity | Displayed data | WWV

## Namespaces

- [Page](#)
- [Discussion](#)

## Variants

## Views

- [Read](#)
- [View source](#)
- [View history](#)

## More

- This page was last edited on 10 April 2023, at 07:21.

- [Privacy policy](#)
- [About Win-Test Wiki](#)
- [Disclaimers](#)



# Text commands

From Win-Test Wiki

[Jump to navigation](#) [Jump to search](#)

## Text Commands

Text commands are a comfortable and fast way to access different functions of the Win-Test software. These commands have to be typed right into the callsign field of the [Log entry window](#). They will be executed after pressing [**Enter**]. If the command was executed successfully, the command text will be deleted from the callsign field.

## Contents

- [1 Changing Bands or Jumping to a Frequency](#)
- [2 Changing Mode](#)
- [3 List of Text Commands](#)
  - ◆ [3.1 CW Functions](#)
  - ◆ [3.2 Voice Keyer Control Functions](#)
  - ◆ [3.3 Multi Operating](#)
  - ◆ [3.4 Open/Close/Database Functions](#)
  - ◆ [3.5 Frequency Control Functions](#)
  - ◆ [3.6 Log synchronisation](#)
  - ◆ [3.7 WinKey](#)
  - ◆ [3.8 Other Functions](#)

## Changing Bands or Jumping to a Frequency

You can directly enter the band to which you want to QSY (if permitted for the current contest): **160**, **80**, **40**, **144**, **432**, **241G**, etc.

For frequencies below 30 MHz, enter the wavelength in meters (**80** for 3.8 MHz, not **75**). For frequencies above 30 MHz and below 10 GHz, enter the frequency in MHz. Above (and including) 10 GHz, enter **10G** (or **24G**, etc.). This behaviour may depend on the [Tools | Data Entry | Priority](#) setting.

You can also directly type a frequency (in kHz): for example **14234.4**, **1843**, **144300**, etc. If a radio is connected to your computer, it will jump to the desired frequency. You can also just enter the kHz part of the frequency of the current band (e.g. while on 20m, entering **035.5** will tune your radio on 14035.5). Finally, you can also enter the frequency by omitting the decimal point (CT style) (e.g. **18404** will tune your radio on 1840.4).

Of course, all the Win-Test windows will be updated according to the new frequency or band.

To return to your last CQ frequency, press [**Alt-F4**].

## Changing Mode

You can directly change the operating mode by typing **CW**, **SSB** etc. The mode will be switched as soon as you press Enter.

There are also shortcuts for changing the mode: **Ctrl-F1** or **Ctrl-F2** will cycle through all the available modes.

Of course, the chosen mode will have to be compatible with the rules of the chosen contest, otherwise Win-Test will ignore this command (error detection in the field).

## List of Text Commands

These text commands provide fast access to many of the functions listed in the Win-Test menus. Just type the text command in the callsign field, and press **[Enter]**.

### CW Functions

- **BURSTS**: Enable CW speed bursts (controlled with ++/-- in macros), equivalent to Options | CW | Speed Bursts enabled
- **NOBURSTS**: Disable CW speed bursts (controlled with ++/-- in macros), equivalent to Options | CW | Speed Bursts disabled
- **CORRECT**: Equivalent to Options | CW | Correction | Enabled
- **NOCORRECT**: Equivalent to Options | CW | Correction | Disabled
- **CTSPACE**: Equivalent to Options | CW | Shortened spaces (CT spaces) enabled
- **NOCTSPACE**: Equivalent to Options | CW | Shortened spaces (CT spaces) disabled
- **CUTON**: Enable cut numbers translation
- **CUTOFF**: Disable cut numbers translation
- **CWAUTO**: Enable CW Auto Sending Mode
- **CWAUTO3**: Start CW Auto Sending after 3 characters in the callsign field
- **CWAUTO4**: Start CW Auto Sending after 4 characters in the callsign field
- **CWAUTOOFF** (or **NOCWAUTO**): Disable CW Auto Sending Mode
- **CWFULLABBREV** (or **FULLABBREV**): Equivalent to Options | CW | Serial number | Abbreviated
- **CWPROABBREV** (or **PROABBREV**): Equivalent to Options | CW | Serial number | Pro
- **CWSEMIABBREV** (or **SEMIABBREV**): Equivalent to Options | CW | Serial number | Half abbreviated
- **NOCWABBREV** (or **NOABBREV**): Equivalent to Options | CW | Serial number | Not abbreviated
- **ESM** (or **NOESM**): Enable/disable Enter Sends Message Mode; equivalent to Tools | Data Entry | Enable ESM [checked]
- **LEADINGZEROS** (or **LZ**): Equivalent to Options | CW | Serial number | Leading zeros [checked]
- **LOADMSGS**: Open the current op. directory and load CW or RTTY messages from there
- **NOLEADINGZEROS** (or **NOLZ**): Equivalent to Options | CW | Serial number | Leading zeros [unchecked]
- **MESSAGES** (or **MSGS**): Equivalent to Options | CW | Modify standard messages...
- **REPEAT** (or **RPT**): Equivalent to Options | Automatic CQ repeat mode [checked]
- **RPTDELAY**: Equivalent to Tools / Automatic CQ repeat, with the focus set to the repeat interval field
- **NOREPEAT** (or **NORPT**): Equivalent to Options | Automatic CQ repeat mode [unchecked]

- **SMARTCORRECT** (or **SMART**): Equivalent to Options | CW | Correction | Smart Correction enabled
- **NOSMARTCORREC** (or **NOSMART**): Equivalent to Options | CW | Correction | Smart Correction disabled
- **SOUND**: Equivalent to Options | CW | No sound [unchecked]
- **NOSOUND**: Equivalent to Options | CW | No sound [checked]
- **SPEED** (or **CWSPEED**) Equivalent to Commands | CW speed
- **TUNE**: Equivalent to Commands | Carrier
- **VARIABLES**: Equivalent to Options | CW | Custom variables...
- **WEIGHT** (or **CWWEIGHT**): Equivalent to Commands | CW weight
- **WORKDUPE** (or **WORKDUPEON**): Equivalent to Options | CW | Work dupes (checked). The normal exchange will be sent to all dupes; the \$QSOB4 message variable will be ignored.
- **NOWORKDUPE** (or **WORKDUPEOFF**): Equivalent to Options | CW | Work dupes (unchecked). Causes the \$QSOB4 message to be sent to all dupes instead of the exchange, for example, when the [Insert] key is programmed as \$LOGGEDCALL \$QSOB4 \$GUESSEXCH \$F2

## Voice Keyer Control Functions

- **MIC**: Enables the mic input when the Voice Keyer (VK) is not playing
- **NOMIC**: Mutes the mic input when the VK is not playing (default)
- **MICWHENPLAY**: Enables the mic input when the VK is playing
- **NOMICWHENPLAY**: Mutes the mic input when the VK is playing (default)

## Multi Operating

- **BRIDGEHEAD**: Make the current station a Bridgehead station
- **INVENTORY** (or **INV**): Requests all connected Stations to send their version number and status information.
  - ◆ Time Master stations are indicated by a capital **M** character (else **m**)
  - ◆ Bridgeheads by the capital character **B** (else **b**)
  - ◆ stations which have enabled log synchronizing are marked with a capital **S**, while **s** means log sync is disabled
- **MOVEINMYLOG**: Equivalent to tag Edit | Move in my log only
- **MULT**: Equivalent to Commands | Station type | Mult
- **NOBRIDGEHEAD**: Make the current station a non Bridgehead station
- **NOMOVEINMYLOG**: Equivalent to untag Edit | Move in my log only
- **NOSCROLLMYLOG**: Equivalent to untag Edit | Move in my log only
- **NOSUPPORT** (or **NOPARTNER**): Equivalent to Commands | Station type | Support [unchecked]
- **OPNAME** (or **MYNAME**): Edit current operator name (used in NAQP M/2 only)
- **OPON** (or **LOGIN**): Log in as an operator
- **OPOFF** (or **LOGOUT**): Log out as an operator
- **RUN1**: Equivalent to Commands | Station type | Run 1
- **RUN2**: Equivalent to Commands | Station type | Run 2
- **RUN**: Equivalent to Commands | Station type | Run
- **SUPPORT** (or **PARTNER**): Equivalent to Commands | Station type | Support [checked]
- **SCROLLMYLOG**: Equivalent to tag Edit | Move in my log only

## Open/Close/Database Functions

- **ARCHIVE**: Equivalent to File | Archive
- **AUTORELOAD** or **NOAUTORELOAD**: Equivalent to Options | Load contest at startup | Enabled
- **BYE**: Equivalent to File | Quit
- **CLEARLOG**: Equivalent to Edit | Delete all QSO
- **CLEARLOGNOW**: Equivalent to CLEARLOG, but doesn't ask for confirmation. **Use with caution!**
- **CLOSE**: Equivalent to File | Close
- **COPYLOG**: Save a copy of the current log file (.wt4) in the current log directory with a timestamp (to the nearest second) added to its name
- **COPYLOGCLEAR**: Equivalent to the COPYLOG command immediately followed by a CLEARLOG command
- **NEW**: Equivalent to File | New
- **NOTES**: Open the notes file attached to the current log
- **OPEN**: Equivalent to File | Open
- **QUIT** (or **EXIT**): Equivalent to File | Quit
- **RELOAD** (or **REOPEN**): Reopens the current opened file
- **RELOADNOW** (or **REOPENNOW**): Reopens the current opened file, but does not display the contest configuration dialog.
- **RESTART**: Restarts Win-Test
- **SAVELOG**: Equivalent to File | Backup contest
- **WRITEDB**: Equivalent to File | Update database
- **WRITELOG** (or **MAKELOG**): Equivalent to File | Creating log files

## Frequency Control Functions

- **PASSFREQ** (or **QSYFREQ**): Equivalent to Commands | QSY frequency
- **QSX**: Equivalent to Commands | Split frequency
- **NCDXF**: Put Radio on NCDXF frequency of current band
- **NOQSX** (or **SPLITOFF**): turns split operation off
- **RUNFREQ**: Moves to last Run frequency, equivalent to **Alt-F4**
- **SPLITFREQ**: Equivalent to Commands | Split frequency
- **NOSPLIT** (or **SPLITOFF**): turns split operation off
- **SWAP**: Equivalent to Commands | Swap the frequency on both radios

## Log synchronisation

- **SYNC** (or **SYNLOGS**): Equivalent to Options | Disable log synchronization on network (unchecked)
- **NOSYNC** (or **NOSYNLOGS**): Equivalent to Options | Disable log synchronization on network (checked)

## WinKey

- **WKSETUP**: Equivalent to Options | WinKey configuration...
- **WKSAP** (or **WKREVERSE**): Equivalent to Options | WinKey configuration... | Swap paddles. Reverse the paddles attached to your WinKey. This is a toggle; paddles change every time this command is run.

## Other Functions

- **AUTOCQ** or **CQAUTO**: Enable automatic CQ Repeat mode
- **AUTOCW** or **CWAUTO**: Enable CW Auto Send
- **BLOCKCARET**: Change line cursor to block cursor
- **BLOCKCURSOR**: Change line cursor to block cursor
- **CLEARGAB**: Clear Gab window (Alt-I)
- **CLOSEALL**: Equivalent to Windows | Close all
- **CTYFILES** or **COUNTRYFILES**: Eq. to Options | Data files | Country files...
- **DEFINEKEYS**: Equivalent to Options | Redefine keyboard keys
- **EZSETUP**: Equivalent to Options / EZMaster configuration...
- **HEADERS**: Equivalent to Options | Log display | Hide headers disabled
- **NOHEADERS**: Equivalent to Options | Log display | Hide headers enabled
- **HELP**: Open reference manual
- **KEYB**: Change keyboard layout, append layout designator with slash, like **KEYB/FRA,KEYB/DEU,KEYB/ENU**; see [1] for details.
- **MKSETUP**: Equivalent to Options / MK/MKII/MK2R configuration...
- **MP3SETUP**: Equivalent to Options / MP3 configuration...
- **NOAUTOCQ** or **NOCQAUTO**: Disable automatic CQ Repeat mode
- **NOAUTOCW** or **NOCWAUTO**: Disable CW Auto Send
- **NOBLOCKCURSOR**: Change block cursor to line cursor
- **NOBLOCKCARET**: Change block cursor to line cursor
- **NOOFFSET** (or **NOOFFSETS** or **OFFSETOFF** or **OFFSETSOFF**): Disable frequency offset
- **NORECORD**: Stop contest recording
- **NOQQL** (or **QOSLOFF**): Disable Quick QSL Feature
- **NORPTESCONLY**: Stop AutoCQ by any keyboard activity
- **NORUNSP** (or **RUNSPOFF**): Disable RUN/S&P-Switching
- **NOTEXTCMDTIP** (or **NOTXTCMDTIP**): Don't display tooltips in Menu operations
- **OFFSET** (or **OFFSETS** or **OFFSETON** or **OFFSETSON**): Enable frequency offset
- **OFFSETSETUP**: To start frequency offset dialogue
- **OFFSETSSETUP**: To start frequency offset dialogue
- **QQL** (or **QOSLON**): Enable Quick QSL Feature
- **QUICKQSL**: Enable intelligent Quick QSL feature, bring up configuration menu
- **RECORD**: Start contest recording
- **REMAPKEYS**: Equivalent to Options | Redefine keyboard keys
- **REMOTE**: Equivalent to Commands | Remote commands... Opens the Remote Commands Dialog
- **RPTESCONLY**: Stop AutoCQ by pressing the Escape key only
- **RTTYSETUP**: Equivalent to Options | RTTY Configuration...
- **RUNSP** (or **RUNSPON**): Enable RUN/S&P-Switching
- **SCRIPTS**: Equivalent to Tools | Scripts Manager
- **SETUP**: Equivalent to Options | Configure Interfaces
- **STARTRECORD**: Start contest recording
- **STOPRECORD**: Stop contest recording
- **TEXTCMDTIP** (or **TXTCMDTIP**): Display tooltips in Menu operations
- **VERSION**: Equivalent to Help | About
- **WCY**: Equivalent to Windows | Solar Activity | Displayed data | WCY
- **WWV**: Equivalent to Windows | Solar Activity | Displayed data | WWV

## Namespaces

- [Page](#)
- [Discussion](#)

## Variants

## Views

- [Read](#)
- [View source](#)
- [View history](#)

## More

- This page was last edited on 10 April 2023, at 07:21.

- [Privacy policy](#)
- [About Win-Test Wiki](#)
- [Disclaimers](#)





# Main Page

From Win-Test Wiki

[Jump to navigation](#) [Jump to search](#)

## Win-Test Documentation

- This documentation is current to version 4.47
- This documentation can be [downloaded in PDF format](#).

### I. **Preface**

1. [Authors and contributors](#)

### II. **Installation**

1. [Download the software](#)
2. [Install the software](#)
3. [Registering the software](#)

### III. **Configuration**

1. [One-time configuration](#)
  - ◇ [Interface configuration](#)
  - ◇ [DX Cluster configuration](#)
  - ◇ [Rotator configuration](#)
  - ◇ [RTTY configuration](#)
  - ◇ [Setting up networking](#)
  - ◇ [Category:BestPractice](#)
2. [Pre-contest configuration](#)

### IV. **Running a contest**

1. [Logging OSOs](#)
2. [SO1R](#)
3. [SO2R](#)
4. [Multi-op](#)
5. [Contest-specific behaviour](#)
6. [Posting live score on-line](#)
7. [Post-contest specifics](#)

### V. **Menus**

1. [File \(without a Win-Test file opened\)](#)
2. [File \(with a Win-Test file opened\)](#)
3. [Edit](#)
4. [Operating](#)
5. [Commands](#)
6. [Messages](#)
7. [Tools](#)
8. [Windows](#)
9. [Options](#)
10. [Help](#)

### VI. **More...**

1. [Icon bar](#)
2. [Text commands](#)
3. [Keys](#)
4. [Message variables \(aka macros\)](#)
5. [Supported contests](#)
6. [Supported rigs](#)

7. [Supported accessories](#)
8. [Check Partial and N+1 Files](#)
9. [Database files](#)
10. [Other files...](#)
11. [Release notes](#)
12. [Release notes \(old version 3 archive\)](#)

#### VII. **Frequently Asked Questions (FAQ)**

1. [Problems registering and running](#)
2. [DX Cluster and wtDxTelnet](#)
3. [Rotator control and wtRotators](#)
4. [User interface](#)
5. [Networking](#)
6. [Licensing issues](#)

#### VIII. **See also**

- ◆ [Win-Test installation, registration and configuration guide](#)
- ◆ [Win-Test quick start manual](#) — for Win-Test 3.11.0 (slightly outdated)
- ◆ [Win-Test mailing list](#)

## Namespaces

- [Main page](#)
- [Discussion](#)

## Variants

## Views

- [Read](#)
- [View source](#)
- [View history](#)

## More

- This page was last edited on 5 April 2020, at 16:54.

- [Privacy policy](#)
- [About Win-Test Wiki](#)
- [Disclaimers](#)



# WAEDC

From Win-Test Wiki

[Jump to navigation](#) [Jump to search](#)

## Contents

- [1 WAEDC - Worked All Europe DX Contest](#)
- [2 General](#)
- [3 Setup](#)
- [4 Receiving QTCs](#)
  - ◆ [4.1 Editing QTCs at a later time](#)
- [5 Transmitting QTCs](#)
- [6 RTTY](#)
  - ◆ [6.1 General](#)
  - ◆ [6.2 Transmitting QTCs](#)
  - ◆ [6.3 Receiving QTCs](#)

## WAEDC - Worked All Europe DX Contest

### General

The specific part on the WAE Contest is to SEND or RECEIVE QTCs.

For more information about QTCs see the [WAEDC Contest Rules](#)

### Setup

You may find the following special setups useful for the WAE:

- right-click on the Main-Window to get the context menu and set

```
WAEDC | Show additional information on qtc traffic
```

# Win-Test Wiki

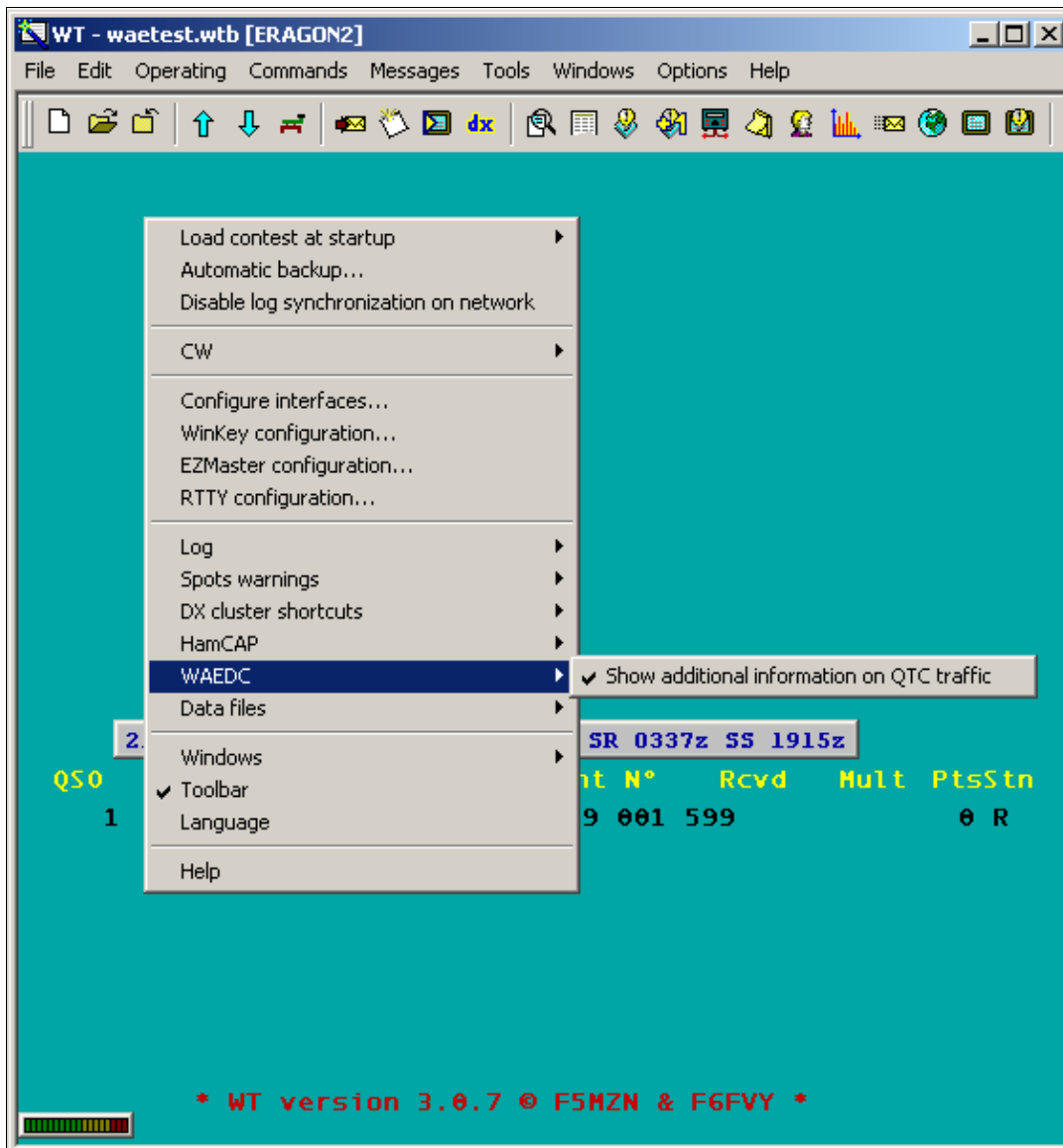

context menu WAEDC

You should get QTC infos after pressing space to enter the RST like this:

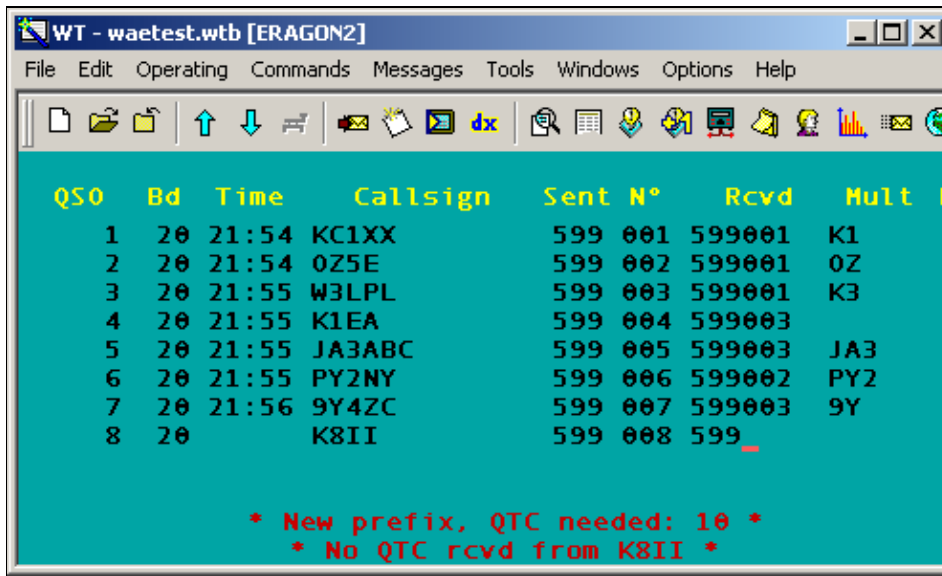

QTC information in main window

- right-click on the radio-windows to get the context menu and set

Display Options | Potential QTC

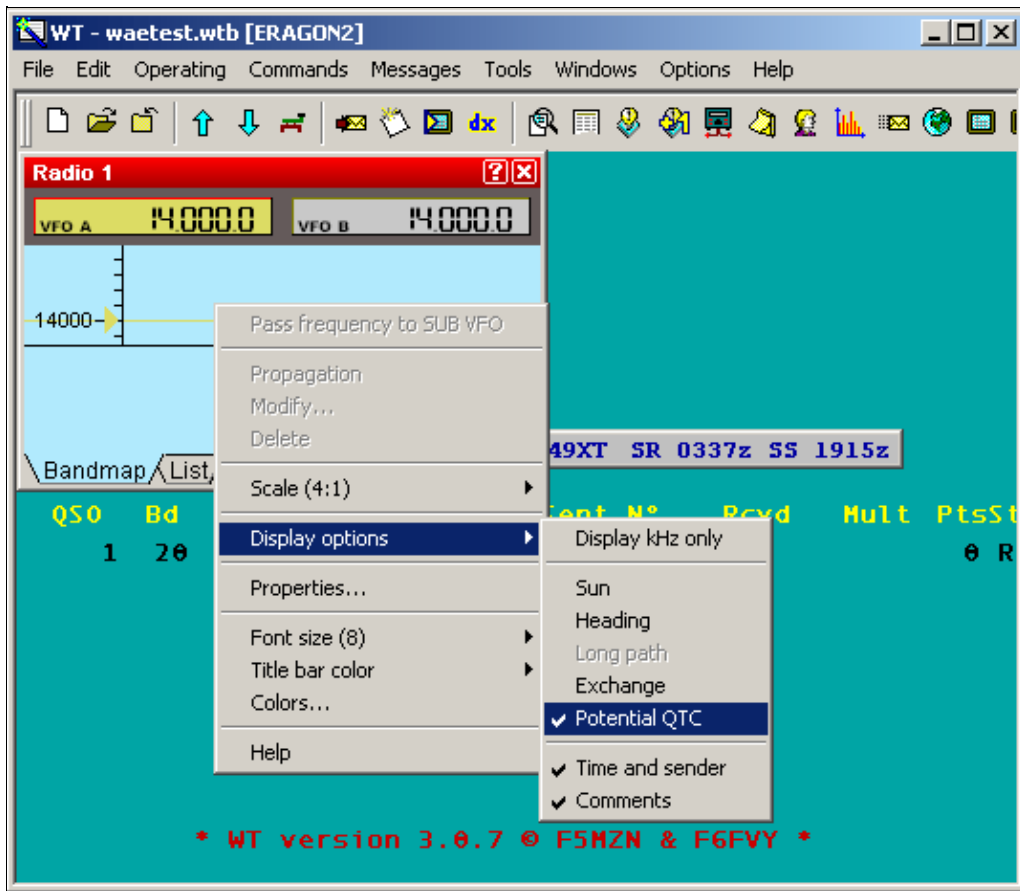

context menu display options

You then will find QTC information in the bandmap, similar to this:

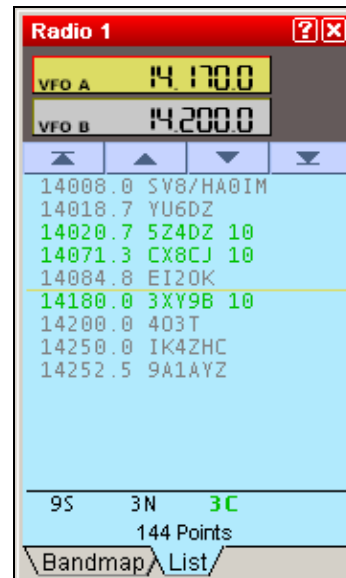
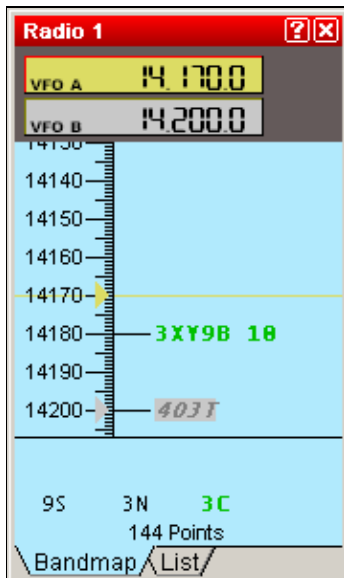

Radio1 Bandmap  
showing QTC infos:  
3XY9B 10 QTCs possible

Radio1 List  
showing QTC infos:  
3x 10 QTCs possible

**Note:** The band map potential QTC figure will not automatically update after QTCs were received/sent. However, you can force the update by manually overwriting the call in the band map by using **Ctrl-Enter**.

## Receiving QTCs

Type **Alt-L** for QTC RX.

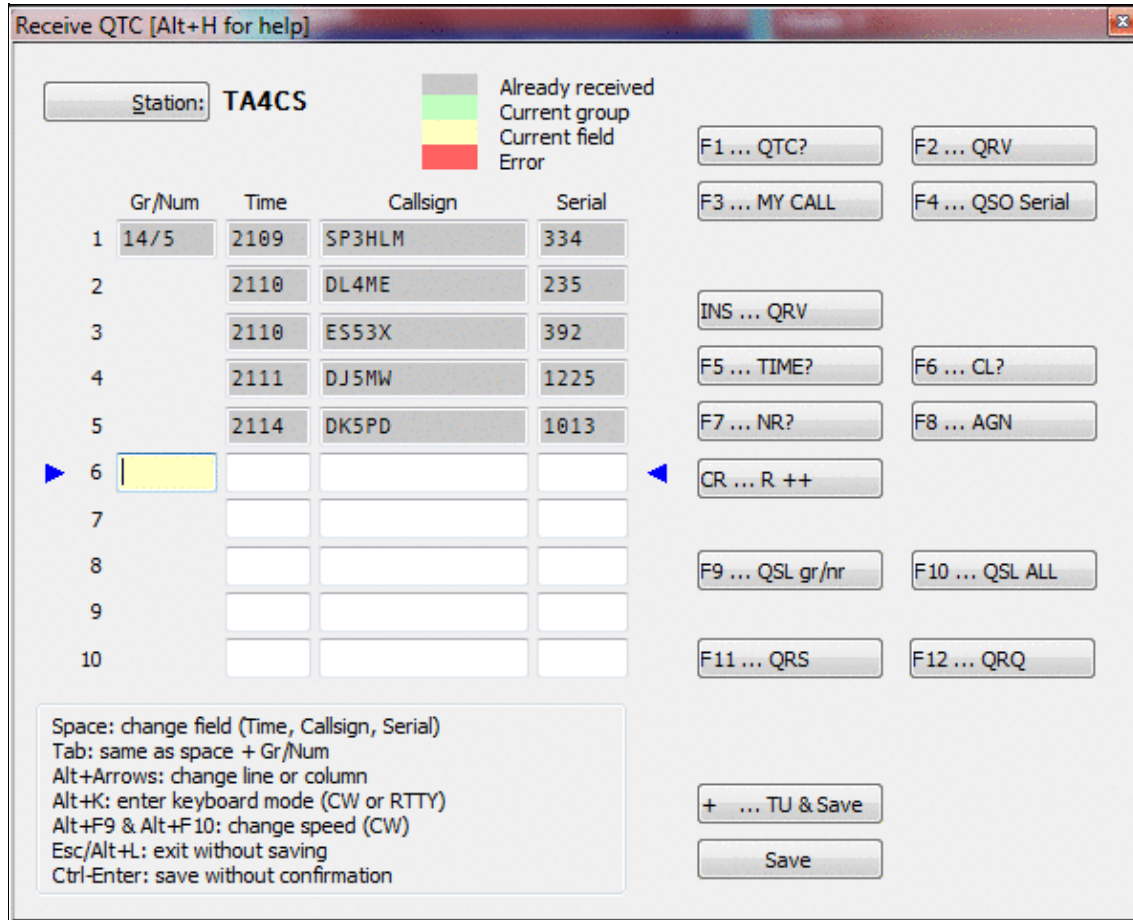

### QTC receiving dialog

Since time and band information will be automatically saved, it is a good idea to enter QTCs on-line, during the contest. Don't be shy, as Win-Test supports you with many little features to make life easier.

- **[Tab]** or **[Spacebar]** will allow you to travel between Time Call and Serial fields and additionally to the QTC number field.
- At any time, you can use the mouse to move the cursor.
- Note the two arrows to the left and right of the current QTC line. These allow you to spot the cursor more easily.
- On CW, when you press the **[Enter]** key, an "R" will be transmitted automatically. Move from line to line, pressing **[Enter]** and everything happens automatically.
- Other F-keys are available to handle different situations during the QTC traffic like asking for a repeat or completing the message and saving the information. These can be configured in the Options Menu.
- Missing figures in the Time field will be automatically computed from data of the previous QSO. So if time in QTC 1 was 1245 and you enter 7 in QTC 2, this will be updated to 1247.
- Pressing the **[+]** key will terminate the QTC traffic, save the QTC data and close the window.

### Editing QTCs at a later time

You may want to re-open the QTC window to do some editing at a later point in time. Go to the QSO when you received the QTCs or enter the callsign in the callsign field and press **Alt-L**. Now do your corrections and later close the window by clicking on the "Validate" button. Correcting QTCs will not change other information in your log like when and on what band the QTC was received.

### Transmitting QTCs

Type **Ctrl-L** for QTC TX

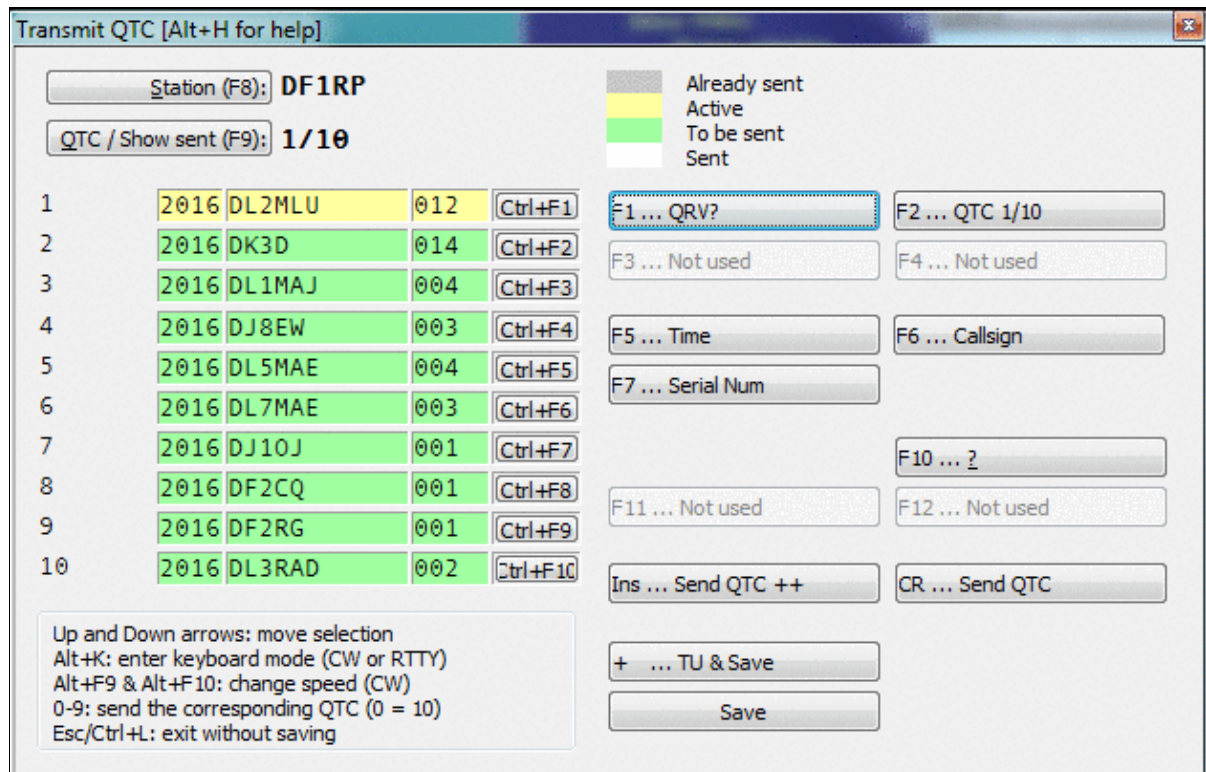



## Transmitting QTCs

On CW press **INS** to send QTCs one by one. If the recipient asks for a full repeat of the QTC just sent, simply press **ENTER**. If he requests an individual field, use the appropriate Fx key or button. You may also use the numeric keypad, 0 corresponds to QTC nr. 10. If the QTC is ack'ed, use **INS** to send the next one.

On RTTY press **INS** or hit the **Send QTC++** button to start transmitting all QTCs at once.

# RTTY

## General

It is a good idea to log the complete WAE Contest to disk, so you can control the QTCs afterwards. See [Configuring Logging on MMTTY](#) for more.

Special support for copying QTC traffic in the RTTY leg of the WAEDC is available. First of all, QTC groups and series will be highlighted in the RTTY window.

Keep in mind that you are able to change most messages (even the QTC dialog messages) with

Options | RTTY | Modify WAE messages

## Transmitting QTCs

Use **Ctrl-L** to start the QTC-TX-dialog. Transmitting QTCs is similar to CW, except that all QTCs are sent in a single transmission by using the **INS** key - contrary to CW and SSB where a confirmation is requested after each QTC.

It's a good advice to use **INS** at the beginning to send the complete QTC group with grp/nr and all QTCs. Then all QTCs will be sent at once, and will have a correct format that other RTTY programs can recognize.

If you use the Keys **F2** to send the grp/nr and **Ctrl-F1 ... Ctrl-F10** for the individual QTCs manually, there will be a break in the FSK stream and PTT and thus the format might be destroyed by noise characters in between. These keys should only be used when particular information is requested by the DX station.

## Receiving QTCs

Use **ALT-L** to start the QTC-RX-dialog. Receiving QTCs is supported by clicking on the appropriate text in the RTTY received window. Assuming you receive the following sequence:

```
QTC: 65/2 QTC: 65/2
0917-GI8HXY-146
0918-G8UBJ-068
```

First click on one of the highlighted "QTC: 65/2": this will automatically open the "QTC Receive" window and fill the QTC group field. Then click on each QTC serie highlighted lines. Again, they will be passed automatically to the "QTC Receive" window.

If You receive some incomplete QTCs like that:

```
QTC: 14/4 QTC: 14/4
```

## Win-Test Wiki

0917-GI8HXY-146  
X919-DR! XT-06-  
0918-G8UBJ-068  
QD18-DP4N-0JSA

you should click on the first QTC, then click in the QTC-Receive-Dialog into the time field of QTC #3, click on QTC nr 3. That way you see which QTCs are missing and you can ask the DX station to repeat these, typical one QTC each:

PSE AGN QTC NR 2 2 2 2 2

0919-DR1A-478  
0919-DR1A-478

NW NR 4 4 4 4 4

0918-DP4N-078  
0918-DP4N-078

After collecting these QTCs you should send a QSL all like that:

QSL 14/4 QSL ALL TU

You can also collect individual calls, times or serials by clicking on these, assuming that the cursor is already in the corresponding input field of the QTC RX dialog (**\$QTCROW**, see [Message\\_variables#WAEDC\\_QTC\\_related](#)). And, of course, you also can type in those data manually.

## Namespaces

- [Page](#)
- [Discussion](#)

## Variants

## Views

- [Read](#)
- [View source](#)
- [View history](#)

## More

- This page was last edited on 30 December 2021, at 11:37.

- [Privacy policy](#)
- [About Win-Test Wiki](#)
- [Disclaimers](#)



# WAEDC

From Win-Test Wiki

[Jump to navigation](#) [Jump to search](#)

## Contents

- [1 WAEDC - Worked All Europe DX Contest](#)
- [2 General](#)
- [3 Setup](#)
- [4 Receiving QTCs](#)
  - ◆ [4.1 Editing QTCs at a later time](#)
- [5 Transmitting QTCs](#)
- [6 RTTY](#)
  - ◆ [6.1 General](#)
  - ◆ [6.2 Transmitting QTCs](#)
  - ◆ [6.3 Receiving QTCs](#)

## WAEDC - Worked All Europe DX Contest

### General

The specific part on the WAE Contest is to SEND or RECEIVE QTCs.

For more information about QTCs see the [WAEDC Contest Rules](#)

### Setup

You may find the following special setups useful for the WAE:

- right-click on the Main-Window to get the context menu and set

```
WAEDC | Show additional information on qtc traffic
```

# Win-Test Wiki

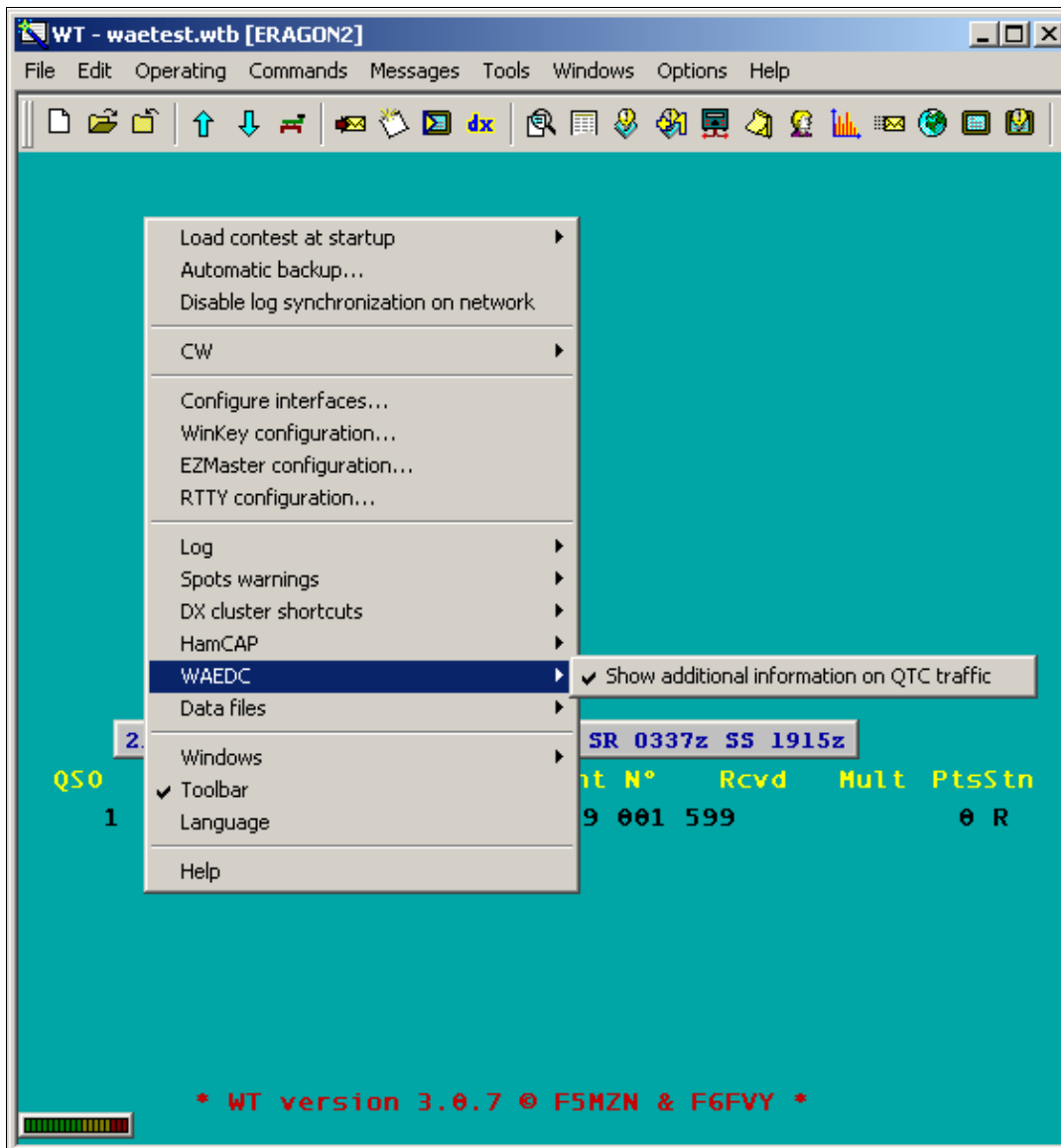

context menu WAEDC

You should get QTC infos after pressing space to enter the RST like this:

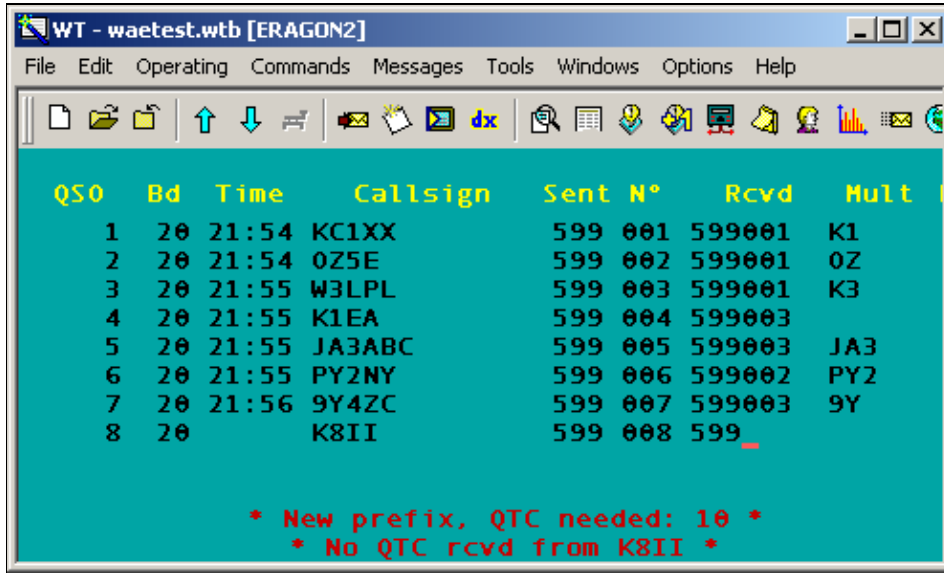

QTC information in main window

- right-click on the radio-windows to get the context menu and set

Display Options | Potential QTC

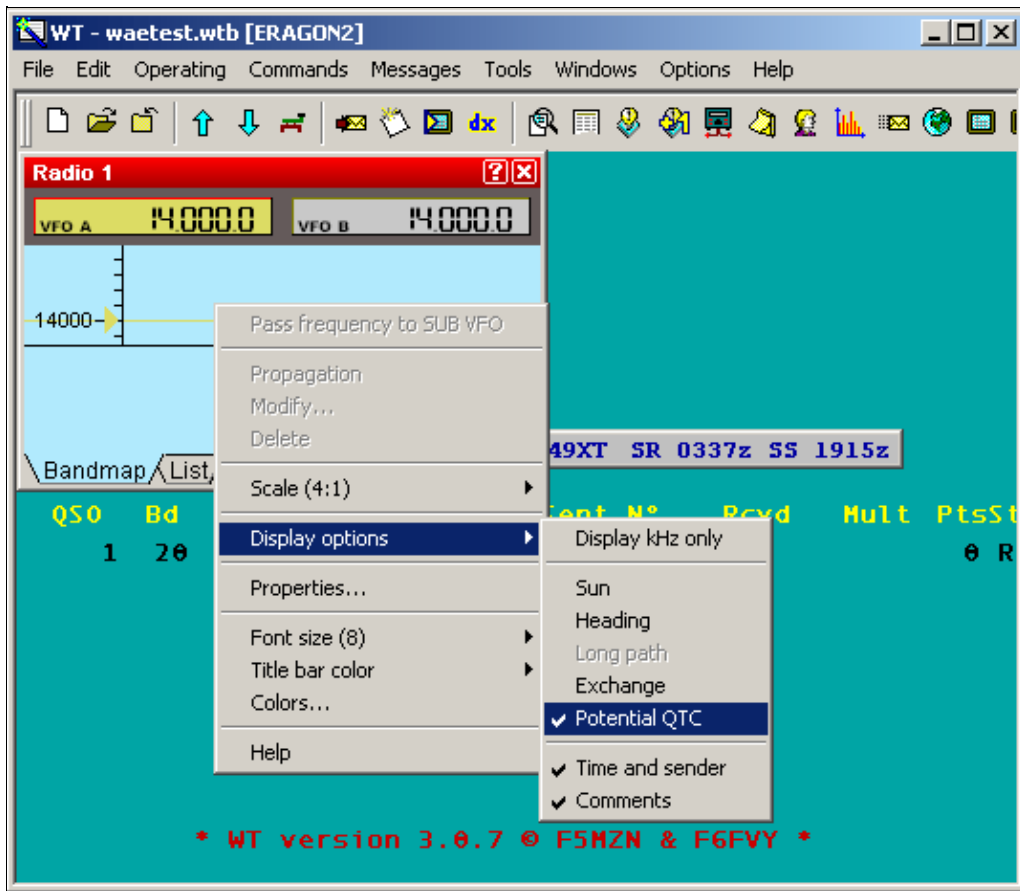

context menu display options

You then will find QTC information in the bandmap, similar to this:

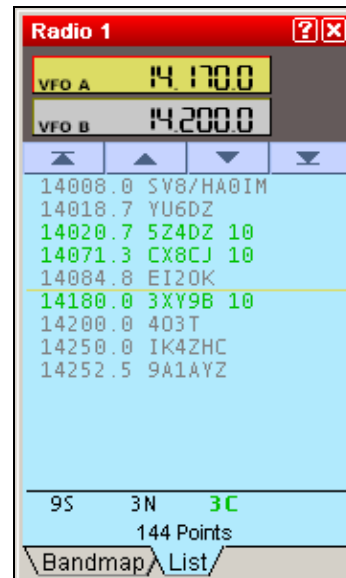
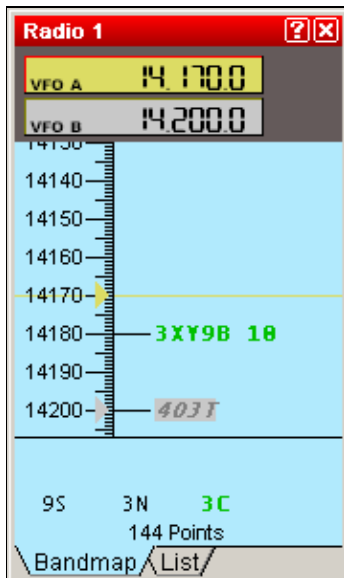

Radio1 Bandmap  
 showing QTC infos:  
 3XY9B 10 QTCs possible

Radio1 List  
 showing QTC infos:  
 3x 10 QTCs possible

**Note:** The band map potential QTC figure will not automatically update after QTCs were received/sent. However, you can force the update by manually overwriting the call in the band map by using **Ctrl-Enter**.

## Receiving QTCs

Type **Alt-L** for QTC RX.

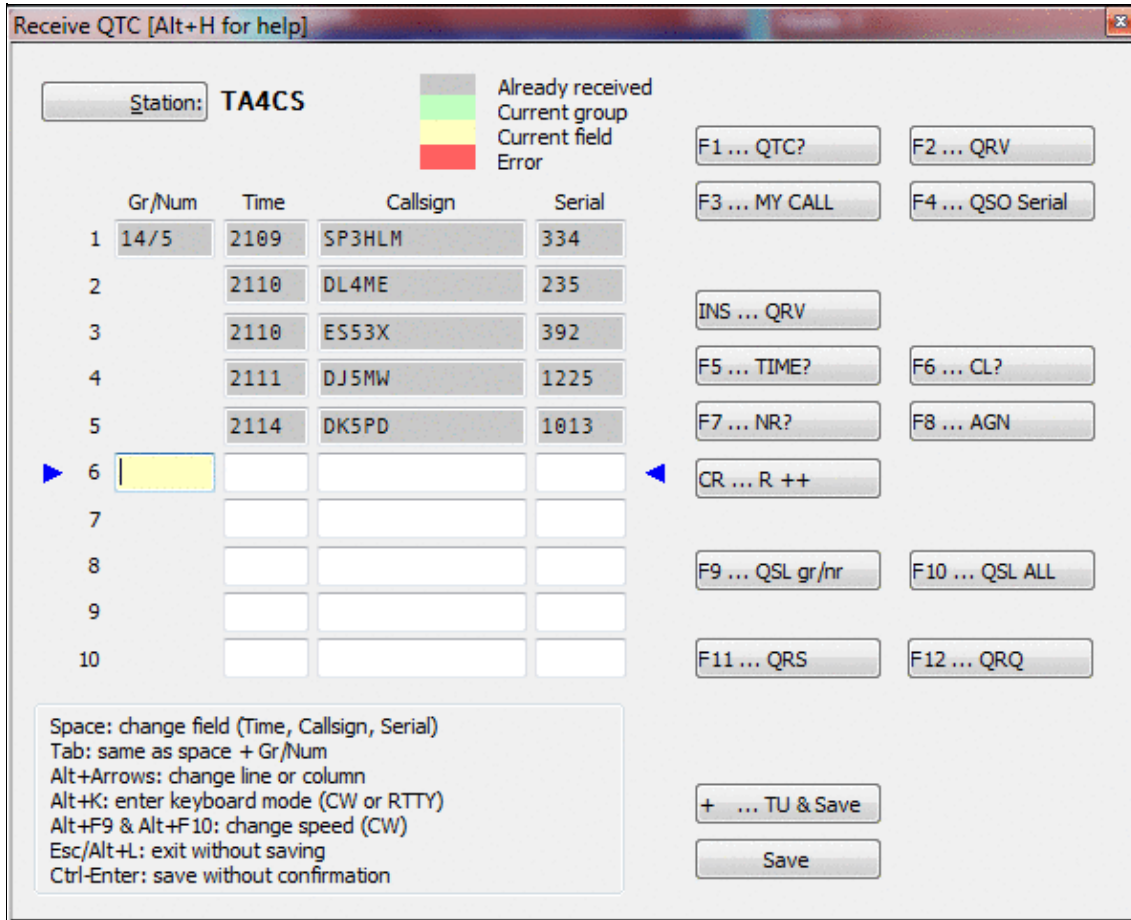

### QTC receiving dialog

Since time and band information will be automatically saved, it is a good idea to enter QTCs on-line, during the contest. Don't be shy, as Win-Test supports you with many little features to make life easier.

- **[Tab]** or **[Spacebar]** will allow you to travel between Time Call and Serial fields and additionally to the QTC number field.
- At any time, you can use the mouse to move the cursor.
- Note the two arrows to the left and right of the current QTC line. These allow you to spot the cursor more easily.
- On CW, when you press the **[Enter]** key, an "R" will be transmitted automatically. Move from line to line, pressing **[Enter]** and everything happens automatically.
- Other F-keys are available to handle different situations during the QTC traffic like asking for a repeat or completing the message and saving the information. These can be configured in the Options Menu.
- Missing figures in the Time field will be automatically computed from data of the previous QSO. So if time in QTC 1 was 1245 and you enter 7 in QTC 2, this will be updated to 1247.
- Pressing the **[+]** key will terminate the QTC traffic, save the QTC data and close the window.

### Editing QTCs at a later time

You may want to re-open the QTC window to do some editing at a later point in time. Go to the QSO when you received the QTCs or enter the callsign in the callsign field and press **Alt-L**. Now do your corrections and later close the window by clicking on the "Validate" button. Correcting QTCs will not change other information in your log like when and on what band the QTC was received.

### Transmitting QTCs

Type **Ctrl-L** for QTC TX

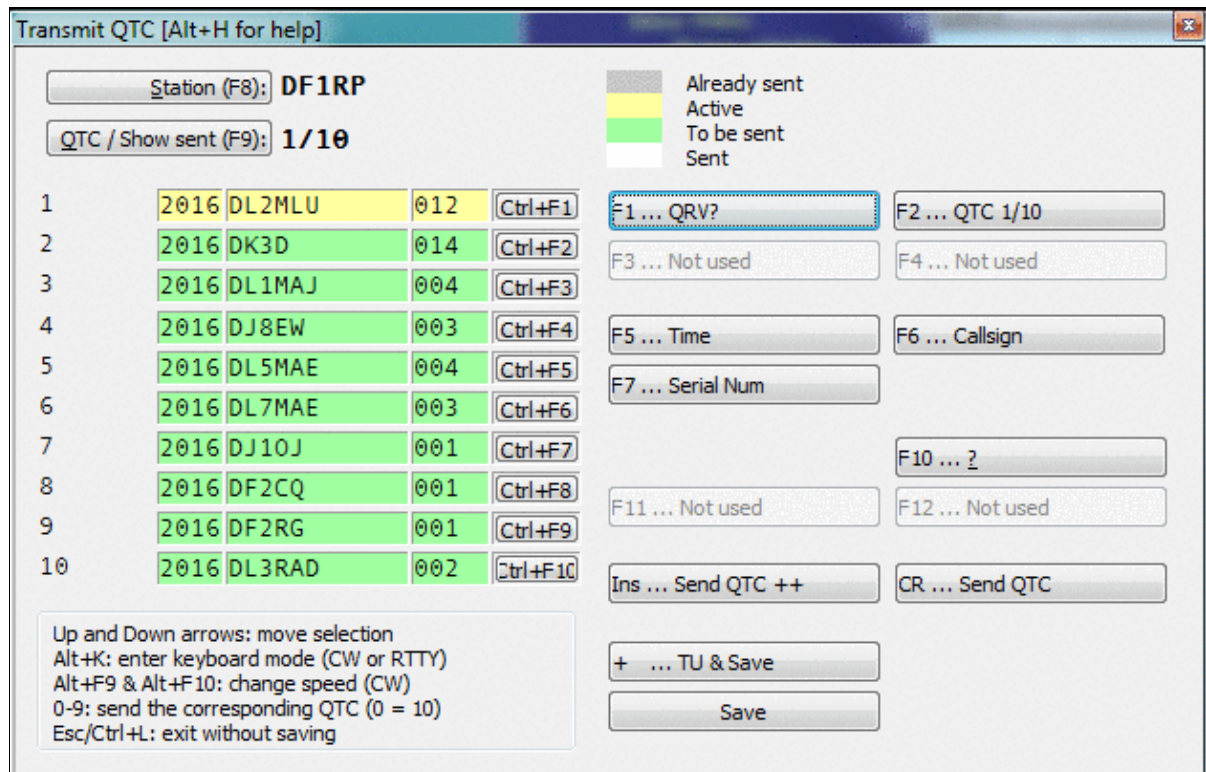



## Transmitting QTCs

On CW press **INS** to send QTCs one by one. If the recipient asks for a full repeat of the QTC just sent, simply press **ENTER**. If he requests an individual field, use the appropriate Fx key or button. You may also use the numeric keypad, 0 corresponds to QTC nr. 10. If the QTC is ack'ed, use **INS** to send the next one.

On RTTY press **INS** or hit the **Send QTC++** button to start transmitting all QTCs at once.

# RTTY

## General

It is a good idea to log the complete WAE Contest to disk, so you can control the QTCs afterwards. See [Configuring Logging on MMTTY](#) for more.

Special support for copying QTC traffic in the RTTY leg of the WAEDC is available. First of all, QTC groups and series will be highlighted in the RTTY window.

Keep in mind that you are able to change most messages (even the QTC dialog messages) with

Options | RTTY | Modify WAE messages

## Transmitting QTCs

Use **Ctrl-L** to start the QTC-TX-dialog. Transmitting QTCs is similar to CW, except that all QTCs are sent in a single transmission by using the **INS** key - contrary to CW and SSB where a confirmation is requested after each QTC.

It's a good advice to use **INS** at the beginning to send the complete QTC group with grp/nr and all QTCs. Then all QTCs will be sent at once, and will have a correct format that other RTTY programs can recognize.

If you use the Keys **F2** to send the grp/nr and **Ctrl-F1 ... Ctrl-F10** for the individual QTCs manually, there will be a break in the FSK stream and PTT and thus the format might be destroyed by noise characters in between. These keys should only be used when particular information is requested by the DX station.

## Receiving QTCs

Use **ALT-L** to start the QTC-RX-dialog. Receiving QTCs is supported by clicking on the appropriate text in the RTTY received window. Assuming you receive the following sequence:

```
QTC: 65/2 QTC: 65/2
0917-GI8HXY-146
0918-G8UBJ-068
```

First click on one of the highlighted "QTC: 65/2": this will automatically open the "QTC Receive" window and fill the QTC group field. Then click on each QTC serie highlighted lines. Again, they will be passed automatically to the "QTC Receive" window.

If You receive some incomplete QTCs like that:

```
QTC: 14/4 QTC: 14/4
```

## Win-Test Wiki

0917-GI8HXY-146  
X919-DR! XT-06-  
0918-G8UBJ-068  
QD18-DP4N-0JSA

you should click on the first QTC, then click in the QTC-Receive-Dialog into the time field of QTC #3, click on QTC nr 3. That way you see which QTCs are missing and you can ask the DX station to repeat these, typical one QTC each:

PSE AGN QTC NR 2 2 2 2 2

0919-DR1A-478  
0919-DR1A-478

NW NR 4 4 4 4 4

0918-DP4N-078  
0918-DP4N-078

After collecting these QTCs you should send a QSL all like that:

QSL 14/4 QSL ALL TU

You can also collect individual calls, times or serials by clicking on these, assuming that the cursor is already in the corresponding input field of the QTC RX dialog (**\$QTCROW**, see [Message\\_variables#WAEDC\\_QTC\\_related](#)). And, of course, you also can type in those data manually.

## Namespaces

- [Page](#)
- [Discussion](#)

## Variants

## Views

- [Read](#)
- [View source](#)
- [View history](#)

## More

- This page was last edited on 30 December 2021, at 11:37.

- [Privacy policy](#)
- [About Win-Test Wiki](#)
- [Disclaimers](#)



# Main Page

From Win-Test Wiki

[Jump to navigation](#) [Jump to search](#)

## Win-Test Documentation

- This documentation is current to version 4.47
- This documentation can be [downloaded in PDF format](#).

### I. **Preface**

1. [Authors and contributors](#)

### II. **Installation**

1. [Download the software](#)
2. [Install the software](#)
3. [Registering the software](#)

### III. **Configuration**

1. [One-time configuration](#)
  - ◇ [Interface configuration](#)
  - ◇ [DX Cluster configuration](#)
  - ◇ [Rotator configuration](#)
  - ◇ [RTTY configuration](#)
  - ◇ [Setting up networking](#)
  - ◇ [Category:BestPractice](#)
2. [Pre-contest configuration](#)

### IV. **Running a contest**

1. [Logging OSOs](#)
2. [SO1R](#)
3. [SO2R](#)
4. [Multi-op](#)
5. [Contest-specific behaviour](#)
6. [Posting live score on-line](#)
7. [Post-contest specifics](#)

### V. **Menus**

1. [File \(without a Win-Test file opened\)](#)
2. [File \(with a Win-Test file opened\)](#)
3. [Edit](#)
4. [Operating](#)
5. [Commands](#)
6. [Messages](#)
7. [Tools](#)
8. [Windows](#)
9. [Options](#)
10. [Help](#)

### VI. **More...**

1. [Icon bar](#)
2. [Text commands](#)
3. [Keys](#)
4. [Message variables \(aka macros\)](#)
5. [Supported contests](#)
6. [Supported rigs](#)

7. [Supported accessories](#)
8. [Check Partial and N+1 Files](#)
9. [Database files](#)
10. [Other files...](#)
11. [Release notes](#)
12. [Release notes \(old version 3 archive\)](#)

#### VII. **Frequently Asked Questions (FAQ)**

1. [Problems registering and running](#)
2. [DX Cluster and wtDxTelnet](#)
3. [Rotator control and wtRotators](#)
4. [User interface](#)
5. [Networking](#)
6. [Licensing issues](#)

#### VIII. **See also**

- ◆ [Win-Test installation, registration and configuration guide](#)
- ◆ [Win-Test quick start manual](#) — for Win-Test 3.11.0 (slightly outdated)
- ◆ [Win-Test mailing list](#)

## Namespaces

- [Main page](#)
- [Discussion](#)

## Variants

## Views

- [Read](#)
- [View source](#)
- [View history](#)

## More

- This page was last edited on 5 April 2020, at 16:54.

- [Privacy policy](#)
- [About Win-Test Wiki](#)
- [Disclaimers](#)



# Preface

From Win-Test Wiki

(Redirected from [Win-Test Wiki:About](#))

[Jump to navigation](#) [Jump to search](#)

The Win-Test wiki documentation project was originally started as an additional source of information for Win-Test users. As time progressed, more and more Win-Test users assisted and the wiki as seen now is the culmination of many people's contributions to the project. A big thank you to everyone who has helped!

## Mailing list

An email-based [mailing list](#) exists for Win-Test users. This is the **primary source** for support. The Win-Test community are very helpful and the Win-Test developers are also very active on the reflector. It is highly recommended all Win-Test users subscribe. Please do not contact the Win-Test developers directly - they have private lives and your email may well be overlooked, missed or ignored if you do so.

## Namespaces

- [Page](#)
- [Discussion](#)

## Variants

## Views

- [Read](#)
- [View source](#)
- [View history](#)

## More

- This page was last edited on 27 December 2023, at 01:15.

- [Privacy policy](#)
- [About Win-Test Wiki](#)
- [Disclaimers](#)



# Win-Test Wiki:Sandbox

From Win-Test Wiki

[Jump to navigation](#) [Jump to search](#)

Use this to test wiki syntax etc.

Test saving works ok...

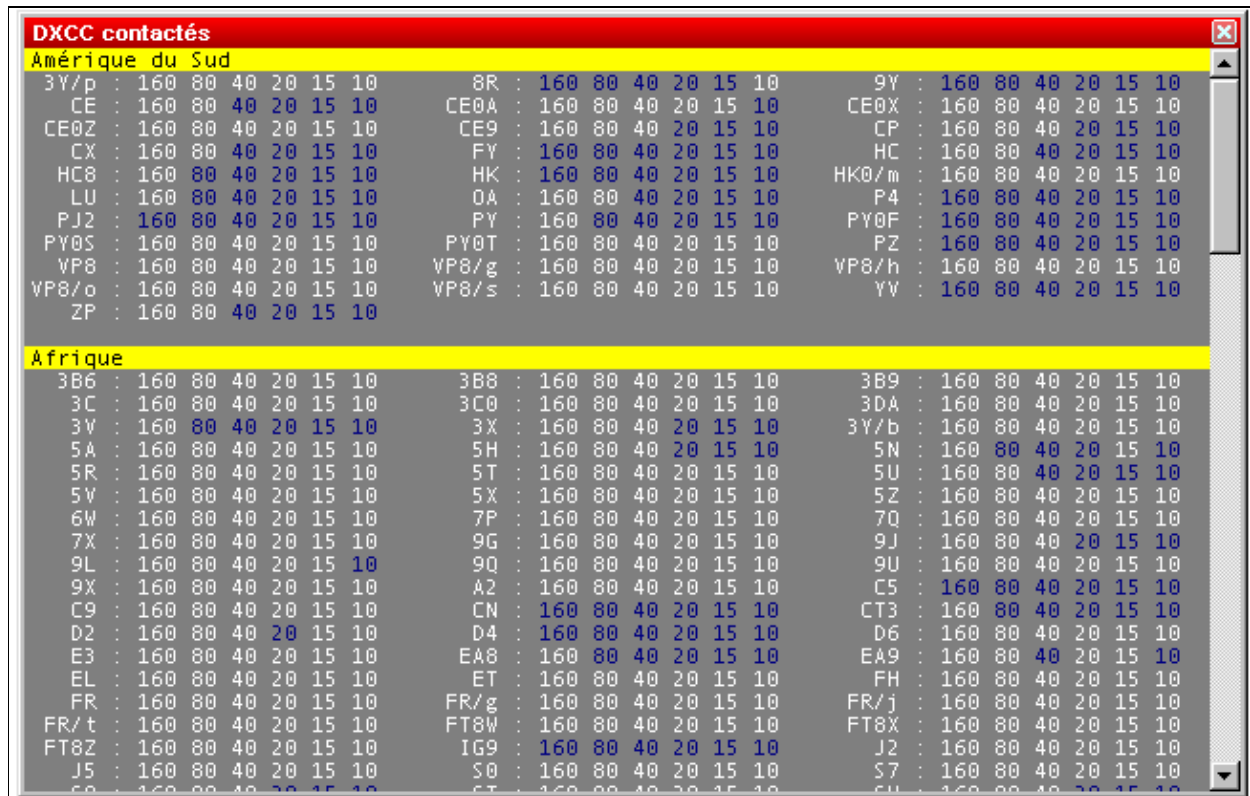

DXCC contactés																							
<b>Amérique du Sud</b>																							
3Y/p	:	160	80	40	20	15	10	8R	:	160	80	40	20	15	10	9Y	:	160	80	40	20	15	10
CE	:	160	80	40	20	15	10	CE0A	:	160	80	40	20	15	10	CE0X	:	160	80	40	20	15	10
CE0Z	:	160	80	40	20	15	10	CE9	:	160	80	40	20	15	10	CP	:	160	80	40	20	15	10
CX	:	160	80	40	20	15	10	FY	:	160	80	40	20	15	10	HC	:	160	80	40	20	15	10
HC8	:	160	80	40	20	15	10	HK	:	160	80	40	20	15	10	HK0/m	:	160	80	40	20	15	10
LU	:	160	80	40	20	15	10	OA	:	160	80	40	20	15	10	P4	:	160	80	40	20	15	10
PJ2	:	160	80	40	20	15	10	PY	:	160	80	40	20	15	10	PY0F	:	160	80	40	20	15	10
PY0S	:	160	80	40	20	15	10	PY0T	:	160	80	40	20	15	10	PZ	:	160	80	40	20	15	10
VP8	:	160	80	40	20	15	10	VP8/g	:	160	80	40	20	15	10	VP8/h	:	160	80	40	20	15	10
VP8/o	:	160	80	40	20	15	10	VP8/s	:	160	80	40	20	15	10	YV	:	160	80	40	20	15	10
ZP	:	160	80	40	20	15	10																
<b>Afrique</b>																							
3B6	:	160	80	40	20	15	10	3B8	:	160	80	40	20	15	10	3B9	:	160	80	40	20	15	10
3C	:	160	80	40	20	15	10	3C0	:	160	80	40	20	15	10	3DA	:	160	80	40	20	15	10
3V	:	160	80	40	20	15	10	3X	:	160	80	40	20	15	10	3Y/b	:	160	80	40	20	15	10
5A	:	160	80	40	20	15	10	5H	:	160	80	40	20	15	10	5N	:	160	80	40	20	15	10
5R	:	160	80	40	20	15	10	5T	:	160	80	40	20	15	10	5U	:	160	80	40	20	15	10
5V	:	160	80	40	20	15	10	5X	:	160	80	40	20	15	10	5Z	:	160	80	40	20	15	10
6W	:	160	80	40	20	15	10	7P	:	160	80	40	20	15	10	7Q	:	160	80	40	20	15	10
7X	:	160	80	40	20	15	10	9G	:	160	80	40	20	15	10	9J	:	160	80	40	20	15	10
9L	:	160	80	40	20	15	10	9Q	:	160	80	40	20	15	10	9U	:	160	80	40	20	15	10
9X	:	160	80	40	20	15	10	A2	:	160	80	40	20	15	10	C5	:	160	80	40	20	15	10
C9	:	160	80	40	20	15	10	CN	:	160	80	40	20	15	10	CT3	:	160	80	40	20	15	10
D2	:	160	80	40	20	15	10	D4	:	160	80	40	20	15	10	D6	:	160	80	40	20	15	10
E3	:	160	80	40	20	15	10	EA8	:	160	80	40	20	15	10	EA9	:	160	80	40	20	15	10
EL	:	160	80	40	20	15	10	ET	:	160	80	40	20	15	10	FH	:	160	80	40	20	15	10
FR	:	160	80	40	20	15	10	FR/g	:	160	80	40	20	15	10	FR/j	:	160	80	40	20	15	10
FR/t	:	160	80	40	20	15	10	FT8W	:	160	80	40	20	15	10	FT8X	:	160	80	40	20	15	10
FT8Z	:	160	80	40	20	15	10	IG9	:	160	80	40	20	15	10	J2	:	160	80	40	20	15	10
J5	:	160	80	40	20	15	10	S0	:	160	80	40	20	15	10	S7	:	160	80	40	20	15	10
CO	:	160	80	40	20	15	10	CT	:	160	80	40	20	15	10	CU	:	160	80	40	20	15	10

blah blah

## Namespaces

- [Project page](#)
- [Discussion](#)

## Variants

## Views

- [Read](#)
- [View source](#)
- [View history](#)

## More

- This page was last edited on 27 July 2006, at 21:21.

- [Privacy policy](#)
- [About Win-Test Wiki](#)
- [Disclaimers](#)



# WT.INI

From Win-Test Wiki

[Jump to navigation](#) [Jump to search](#)

Several default parameters can be set up in the Win-Test initialization file WT.INI which is an ASCII file located as follows:

For Win-Test version 4:

- Windows XP: **C:\Documents and Settings\All Users\Application Data\Win-Test\cfg\wt.ini**
- Windows Vista: **C:\ProgramData\Win-Test\cfg\wt.ini**

For Win-Test version 3:

- **C:\Program Files\Win-Test\wt.ini**

Changes in this file are necessary only in a specific situation and require a considerable amount of know-how, like using an ASCII editor. Note, that you can change the WT.INI file only when Win-Test is not alive. If you edit the file, while Win-Test runs, you will probably find all of your changes gone once you finish the program.

## Generic ICOM radio

ICOM radio types are identified by a specific address for each model. A list of such addresses may be found [here](#). So for example, the popular IC-735 has the address 04h (h stands for hex), while the IC-756pro II has 72h and the IC-729 has 3Ah. This address can be changed in the radio, which makes sense, for example, when you run two identical radios and wish to control them from Win-Test. Then you have no other choice but give the second radio a different address.

To be able to use a different address, in the interfaces setup section of Win-Test, select **IC-Generic** as your radio instead of a specific ICOM radio model.

Doing this, in the [Interfaces] section of WT.INI, there will be the possibility to specify the right address:

```
[Interfaces]
....
IcomGenericRadio1=<n>h
IcomGenericRadio2=<n>h
```

where <n> is the hex address of the radio.

For example, the setting IcomGenericRadio2=48h will use address 48h for Radio 2.

## See Also

### In the manual

- [Some ICOM addresses given on K1EA's Web Site](#)
- [More ICOM addresses from www.DockSideRadio.com](#)



- Loading a different WT.INI file at startup

## Namespaces

- Page
- Discussion

## Variants

## Views

- Read
- View source
- View history

## More

- This page was last edited on 20 October 2009, at 09:21.

- Privacy policy
- About Win-Test Wiki
- Disclaimers



# WT.INI

From Win-Test Wiki

[Jump to navigation](#) [Jump to search](#)

Several default parameters can be set up in the Win-Test initialization file WT.INI which is an ASCII file located as follows:

For Win-Test version 4:

- Windows XP: **C:\Documents and Settings\All Users\Application Data\Win-Test\cfg\wt.ini**
- Windows Vista: **C:\ProgramData\Win-Test\cfg\wt.ini**

For Win-Test version 3:

- **C:\Program Files\Win-Test\wt.ini**

Changes in this file are necessary only in a specific situation and require a considerable amount of know-how, like using an ASCII editor. Note, that you can change the WT.INI file only when Win-Test is not alive. If you edit the file, while Win-Test runs, you will probably find all of your changes gone once you finish the program.

## Generic ICOM radio

ICOM radio types are identified by a specific address for each model. A list of such addresses may be found [here](#). So for example, the popular IC-735 has the address 04h (h stands for hex), while the IC-756pro II has 72h and the IC-729 has 3Ah. This address can be changed in the radio, which makes sense, for example, when you run two identical radios and wish to control them from Win-Test. Then you have no other choice but give the second radio a different address.

To be able to use a different address, in the interfaces setup section of Win-Test, select **IC-Generic** as your radio instead of a specific ICOM radio model.

Doing this, in the [Interfaces] section of WT.INI, there will be the possibility to specify the right address:

```
[Interfaces]
....
IcomGenericRadio1=<n>h
IcomGenericRadio2=<n>h
```

where <n> is the hex address of the radio.

For example, the setting IcomGenericRadio2=48h will use address 48h for Radio 2.

## See Also

### In the manual

- [Some ICOM addresses given on K1EA's Web Site](#)
- [More ICOM addresses from www.DockSideRadio.com](#)

- Loading a different [WT.INI](#) file at startup

## Namespaces

- [Page](#)
- [Discussion](#)

## Variants

## Views

- [Read](#)
- [View source](#)
- [View history](#)

## More

- This page was last edited on 20 October 2009, at 09:21.

- [Privacy policy](#)
- [About Win-Test Wiki](#)
- [Disclaimers](#)



# Running a contest

From Win-Test Wiki

[Jump to navigation](#) [Jump to search](#)

## Contents

- [1 Logging QSOs](#)
- [2 SO1R specifics](#)
- [3 SO2R specifics](#)
- [4 Multi-op contesting](#)
  - ◆ [4.1 Possible issues](#)
- [5 Contest specific behaviour](#)
- [6 Posting live score on-line](#)
- [7 Post-contest specifics](#)

## Logging QSOs

- [Programming messages](#)
- [Using the log entry window](#)

## SO1R specifics

- [Automated CW generation, RTTY messages and voice keyers](#)
- [Radio Control](#)
- [Use of Cluster spots](#)
- [Taking advantage of the Band Map feature](#)

## SO2R specifics

- [Learning the second radio window](#)
- [Using the 'shift binds second radio' option](#)  
*This feature changes some key assignments in Win-Test*
- [Using the 'caps lock binds to secondary radio' option](#)
- [Using 'advanced SO2R' mode and setting up scenarios](#)
- Win-Test and the SO2R external devices
  - ◆ [Setting up the EZMaster for use with Win-Test](#)
  - ◆ [Setting up the MK2R for use with Win-Test](#)

## Multi-op contesting

- [Setting up station names and time synchronization](#)
- [Using multi-op text commands](#) to designate RUN/MULT, RUN1/RUN2, etc.
- [Using move in my log only](#) to edit QSOs
- [Passing multipliers between stations](#)
- [Understanding the status window](#)
- [If you need to delete a QSO during the contest - DO NOT](#) use the 'delete QSO' feature
- [Clearing all logs before the start](#)

## Possible issues

- [Sequential serial numbers between stations shared between both stations](#)
- [Editing the sequential serial numbering](#)
- [QSOs made by the Mult stations which are not multipliers](#)

## Contest specific behaviour

- Some notes about [contest specific keys and parameters](#), e.g. for [WAEDC](#)

## Posting live score on-line

- In order to post live score on-line to [getscores.org](#) you will need a third party software. Instructions and software to download can be found on the [www.5b4wn.com](#) web site.

## Post-contest specifics

And finally, articles related to Win-Test and post-contest tasks:

- [Extracting log Information](#)
- [Merging](#) logs before exportation (see: [Menu:File new Merge Logs](#) chapter)
- [Cleaning](#) the log (see: [Menu:File new Clean log](#) chapter)
- [Creating](#) the Cabrillo, Reg1Test or ADIF exports
- [Mailing](#) the Cabrillo or Reg1Test log to the contest sponsor

## Namespaces

- [Page](#)
- [Discussion](#)

## Variants

## Views

- [Read](#)
- [View source](#)
- [View history](#)

## More

- This page was last edited on 9 December 2016, at 23:43.

- [Privacy policy](#)
- [About Win-Test Wiki](#)
- [Disclaimers](#)



# Multi-op/Gabbing

From Win-Test Wiki

[Jump to navigation](#) [Jump to search](#)

Messaging gabbing in Win-Test allows stations in a multi-op situation to send messages to one another, for example to alert an operator of another station that a multiplier has been moved from one band to another, etc.

## Sending a message to another station

Sending a message to a specific station (or all stations) on the network is simply a case of using **Alt+G** and typing the text you wish to send. You will notice a drop-down list just to the left of the text entry field which is where you choose which station you wish to send the message to - by default, this is set to 'all' to send the message network-wide.

By default, the message gab (**Alt+G**) window will look like this:

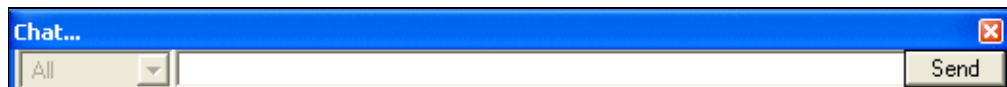

After you have typed your message, simply press **ENTER** (or click the 'send' button).

## Receiving gab messages

Using **Alt+I** or using the Windows | Gab menu option will open a separate window within Win-Test that shows all recent gab messages that have arrived at your operating position. Please note that you do **not** need this window open constantly to receive gab messages from other stations on the network - it shall open automatically when a message is received and close again automatically after a short period of time.

**Alt+I** can be useful to see a message that might have been sent earlier, or perhaps if you somehow missed the last message sent to your operating position you can use **Alt+I** to view the message.

## See also

- [Passing multipliers between stations](#)

## Namespaces

- [Page](#)
- [Discussion](#)

## Variants

## Views

- [Read](#)
- [View source](#)
- [View history](#)

## More

- This page was last edited on 26 March 2011, at 04:54.

- [Privacy policy](#)
- [About Win-Test Wiki](#)
- [Disclaimers](#)



# Multi-op/Passing

From Win-Test Wiki

[Jump to navigation](#) [Jump to search](#)

Passing multipliers between stations in a multi-op environment is key to success. Win-Test naturally handles multiplier passing very efficiently.

## Contents

- [1 Checking if a multiplier is required on another band](#)
- [2 Passing the multiplier itself](#)
- [3 Alerting the other operator\(s\) about the mult](#)
- [4 Working the passed station](#)
- [5 See also](#)

## Checking if a multiplier is required on another band

The first step to realise whether to pass a multiplier or not is to use the 'check multiplier' window (Windows | Check multiplier menu option, or **F10** keyboard shortcut). In conjunction with the status window (at your station) which tells you the frequency the other station(s) are on, you can see if you need and if you can to pass a multiplier or not.

For example, MULT1 station is on 21291, tuning up the band. RUN station works D4X which, according to the check multiplier window is a mult on 15m! So, the RUN operator should pass this station to 15m...

## Passing the multiplier itself

The frequency you pass the station to is very important but it is up to your team decide how to organise this. In the status windows you will notice a *QSY Freq* which should be the frequency the operator passes the mult to. However, it is up to your team members to ensure this frequency is kept up-to-date and clear of QRM (so it should usually be away from the centre of contest activity). The QSY frequency can be changed at any time by going to the Commands | QSY Frequency menu option. Simply enter the frequency or tune the rig to the frequency you want to set the QSY frequency to and click the button displaying the frequency (just to the right of the text entry field). Click OK and the change is made.

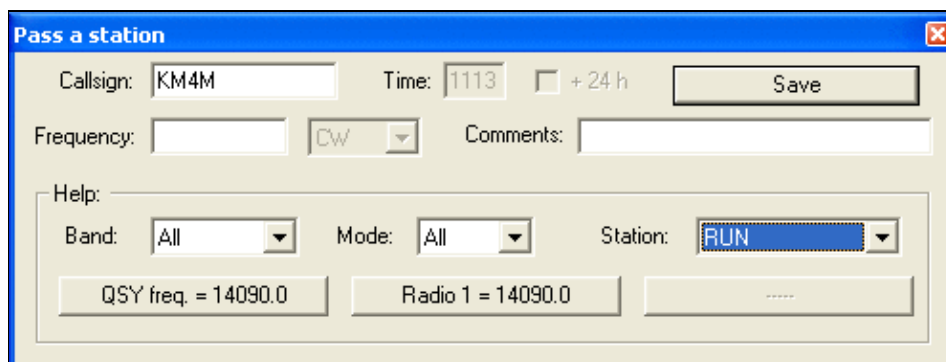



Use the **Alt+D** keyboard shortcut to open the 'Pass a station' window. Many entry fields within this window are automatically filled for ease of use (and to save time!).

The callsign will be the most recent entered in the log at your operating position. If the station is moving instantly, you can leave the time too (which will be the current time by default). You can choose to either manually enter the frequency, or alternatively, you could use one of the 'Help' drop-down boxes (as shown above). The easiest way is to use the 'station' drop-down, which shows all stations on the network.

Let's imagine there's a MULT1 on the network, and we know he's on 15m. Choose 'MULT1' from the drop-down list, and you'll now notice the three buttons just beneath the drop-down lists now have different text - the QSY frequency and current radio 1 frequency as seen on the status window and at the MULT1 operating position. Remember earlier we discussed that you should always be passing stations to the QSY freq if at all possible.

You now simply have to click one of these buttons (e.g. QSY freq, radio 1, ...) and then type a comment if you wish (often not necessary). Click the 'save' button and the sked is saved.

## Alerting the other operator(s) about the mult

So now we've saved the sked (and thus effectively 'passed' the mult to the other operating position) but how is the other operator informed of the move? Well, we have the beauty of the 'skeds' window, which is found by going to the `Windows | Skeds` menu (or using the **Alt+B** keyboard shortcut):

# Win-Test Wiki

Skeds				
12:59	21129.0	SSB	ZS6UN	[38]
13:14	14138.0	SSB	Z31CZ	[15]
13:18	14138.0	SSB	T94B	[15]
13:23	14138.0	SSB	MMOBRG	[14]
13:38	14138.0	SSB	EW1GA	[16]
19:14	21205.0	SSB	KHOAA	[27]
19:16	14138.0	SSB	KHOAA	[27]
19:21	14155.0	SSB	KHOAA	[26]
19:23	14247.0	SSB	AH2R	[27]
19:38	14138.0	SSB	VE8JL	[01]
21:25	14138.0	SSB	YS1JBL	[07]
21:35	14138.0	SSB	YS1JBL	[04]
23:41	7015.0	SSB	HSOZAA	[26]
23:43	7015.0	SSB	VP2MEG	[08]
23:49	7015.0	SSB	J69EN	08
23:55	21130.0	SSB	VP2MEG	[08]
00:43	7015.0	SSB	KL7HBK	[01]
01:34	7015.0	SSB	6Y4Y	[08]
01:37	7015.0	SSB	HK1JMF	[09]
02:39	3795.0	SSB	LW7DX	[13]
04:22	3751.0	SSB	5J0X	[07]
04:24	3730.0	SSB	LZ9W	[20]
06:03	1825.0	SSB	VE3BW/HR9	[07]
06:13	3775.0	SSB	TU2CI	[14]
06:17	1825.0	SSB	GMOB	[14]
06:26	3775.0	SSB	TG9AVV	[07]
06:27	3775.0	SSB	TG9AVV	[07]
06:34	1826.0	SSB	GI3NVW	[14]
06:42	1826.0	SSB	TI8M	[07]
06:45	3775.0	SSB	KH7X	[31] dans 8 min il nous entend !!!
06:59	3675.0	SSB	EA9PY	[33]

The above screenshot shows the three colours which you will experience in this window. Basically, those stations with a grey background have been 'missed', i.e. the sked is more than 10 minutes old; those with a yellow background are imminent, i.e. within a 10-minute window; those with a turquoise (light blue) background are more than 10 minutes away.

The skeds window, like the [gab messaging](#) window, does **not** need to be open all the time for you to keep track of skeds. When a sked is imminent (i.e. those with a yellow background), the skeds window will open automatically!

In the example we used above, where we were passing KM4M, the sked window would pop-up on the MULT1 operating position and would look something like this:

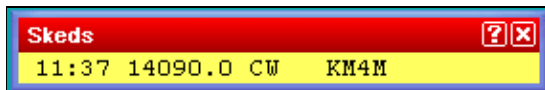

You could also use a [gab message](#) just to ensure the other op knows the mult is coming!

## Working the passed station

Working a station which has been passed to you is a simple case of double-clicking the callsign in the sked window. Double-clicking KM4M in the example above would tune to the radio to 14090.0 and also fill in the callsign entry field in the log so all you need to do is call the station and await their response! : )

After that, switching back to the RUN frequency can be accomplished by just pressing **Alt-F4** or selecting

Commands | QSY to run frequency

Simple, eh?

## See also

- [Message gabbing](#)
- [Understanding the status window](#)
- ...

## Namespaces

- [Page](#)
- [Discussion](#)

## Variants

## Views

- [Read](#)
- [View source](#)
- [View history](#)

## More

- This page was last edited on 13 April 2007, at 12:09.

- [Privacy policy](#)
- [About Win-Test Wiki](#)
- [Disclaimers](#)



# Multi-op/Status window

From Win-Test Wiki

[Jump to navigation](#) [Jump to search](#)

The status window is very important in a multi-op situation. It shows the frequencies of all stations on the network.

## Understanding the status window

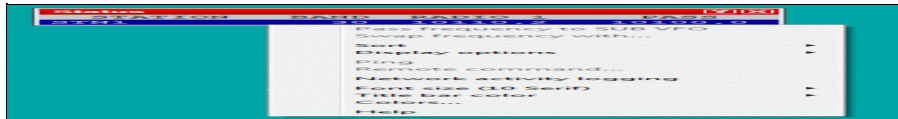

There are various important information shown in the status window:

- STATION shows the unique identifier for each station (set when you create/open a log)
- BAND is a 'at a glance' display of the frequency/mode of the station (e.g. 20 CW)
- TYPE is the station type - i.e. Run, Support, Mult 1, Mult 2 etc... (See the Commands | Station type menu option for the Type values and how to set them)
- QSY FREQ is the frequency set for passing multipliers
- RADIO 1 is the current frequency of the radio
- QSY informs you whether a QSY is acceptable or whether you must stay on the current band (e.g. 10-minute rule)

A double-click on a station name opens a private gab window to send a message to the operator of this station only. A double-click on any frequency tunes your radio (assuming it is controlled by CAT) to this frequency.

## Observing the 10-minute rule

### QSY Timers

To cope with the 10-minute rule, Win-Test has a countdown timer, which is started when each station makes the first contact on a new band. The time will start at **10:00** and will count down to zero after which **QSY ok** will be displayed in the status window. The image below demonstrates this.

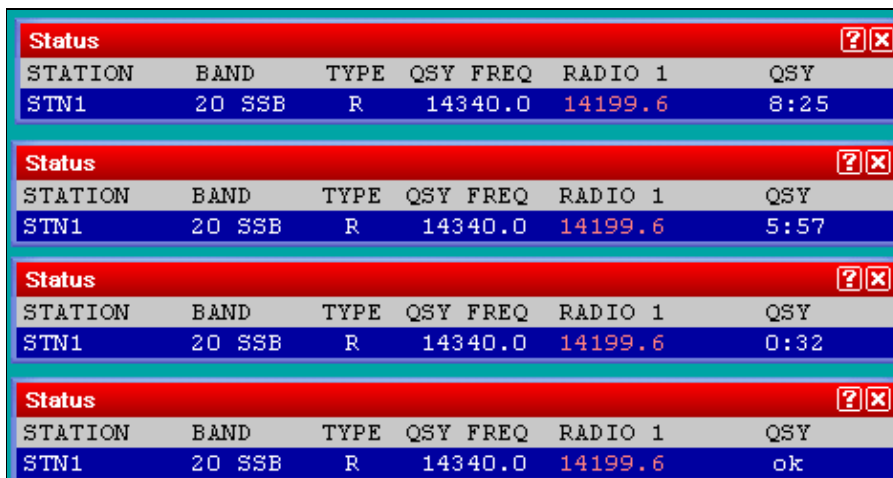

QSY countdown timer sequence for the runner

When **QSY ok** is displayed for your station, you are free to work a QSO on a new band.

QSOs with own callsign are ignored in the timer calculation to allow efficient blanking out of any invalid QSOs.

## Hiding unnecessary information in the status window

You can hide unnecessary information in the status window (e.g. **RADIO 2** etc.) by right-clicking in the status window to open the context menu. By selecting **Display options** you can choose whether to show support stations in the status window list and also whether to show or hide the QSY freq. and the Radio 2 frequency (often not necessary).

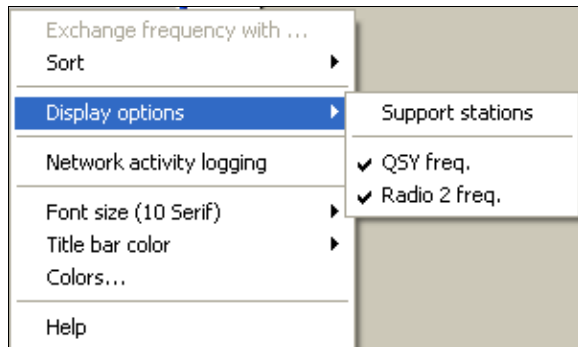

Status window context menu

## See also

- [Passing multipliers in a multi-op situation](#)

## Namespaces

- [Page](#)
- [Discussion](#)

## Variants

## Views

- [Read](#)
- [View source](#)
- [View history](#)

## More

- This page was last edited on 17 December 2016, at 17:29.
- [Privacy policy](#)
- [About Win-Test Wiki](#)
- [Disclaimers](#)



# Multi-op/Deleting QSO

From Win-Test Wiki

[Jump to navigation](#) [Jump to search](#)

## Deleting a QSO mid-contest in a multi-op situation

If you need to delete a QSO during a contest it is recommended you do **NOT** use the menu option [Edit | Delete QSO](#) as this will have the consequence of deleting the QSO in the log at your operating position *only* but **not** network-wide.

Instead, replace the callsign of the QSO you wish to delete with *your* callsign (specified when you created your log). For example, if you are using the callsign G6PZ and you wish to remove the QSO with CE1ABC, replace the CE1ABC callsign with G6PZ. Later, when it comes to [merging and exporting the logs](#), there is an option to delete all QSOs with yourself from the log.

In a Multi-Multi environment the QSO rate can be very high, therefore it can be useful to check [Menu | Edit | Move in my log only](#). Please refer to the [Menu:Edit Move in my log only](#) chapter in this manual for a full description of this option.

## Namespaces

- [Page](#)
- [Discussion](#)

## Variants

## Views

- [Read](#)
- [View source](#)
- [View history](#)

## More

- This page was last edited on 9 December 2016, at 23:29.
- [Privacy policy](#)
- [About Win-Test Wiki](#)
- [Disclaimers](#)





# Multi-op/Issues/Sequential serials

From Win-Test Wiki

[Jump to navigation](#) [Jump to search](#)

## Sequential Serials

In some contests it is necessary to maintain sequential serial numbers for **both** stations (not per station/band) in the multi/single category. If you are not careful you may give out a serial number that is taken by the other station(s) if you do not enter the QSO quick enough!

To overcome this, it is recommended on the mult station(s) to type the call/double-click the spot of the station you are trying to work, and as soon as you hear him come back to you, enter the QSO **immediately** by entering serial number 0 (zero). Then simply press the up arrow on the keyboard to the QSO and use the spacebar to move across to the serial number field and enter the correct serial number given by the other party.

If you were not quick enough to press the enter key and that number was taken by someone else, make sure the other station gets the information right and tell him the new, correct serial number.

This is a practical solution that has been in use for years, also during MS-DOS and CT times. Win-Test does not have a number reserve feature because it (intentionally) lacks a central data master.

To avoid confusing QSO number with sent serial number, it is a really good idea to hide the QSO number column (see [Menu:Options#Hide\\_QSO\\_numbers](#)). Now your eye will only look at the **Sent No.** column when giving out serial numbers.

## Namespaces

- [Page](#)
- [Discussion](#)

## Variants

## Views

- [Read](#)
- [View source](#)
- [View history](#)

## More

- This page was last edited on 16 July 2009, at 20:51.

- [Privacy policy](#)
- [About Win-Test Wiki](#)
- [Disclaimers](#)



# Multi-op/Issues/Editing serials

From Win-Test Wiki

[Jump to navigation](#) [Jump to search](#)

If, by remote chance, you should experience a machine crash on the network during the contest, and other stations continue making QSOs, the log at your operating position will be out of sync. The danger, with such a scenario, is that you may mistakenly work what you *thought* was a mult but may actually have been worked by another station on the network during the crash. Another problem is that serial numbers might be out of sync at the various operating positions.

**RELAX: all this was possibly true before the LOG SYNCHRONIZATION era!!**

With Log Synchronization introduced in version 3.0.0 (see [Release Notes](#)), this should not happen anymore.

Log synchronization is turned on by default. The menu option [Disable log synchronization on network](#) will let the user turn off synchronization.

## Overcoming out-of-sync scenarios

As said before, this should not happen anymore, apart some smart Mr. Murphy unpredictable interventions.....

Just in that case, and for whatever other reason you may have to change the sequential serial numbering, the old option has been left in place and is still available.

## Editing serial numbers

Through the menu `Edit | Edit serial number...` a new window will open up, where the serial number can be changed. Use this option with care, however.

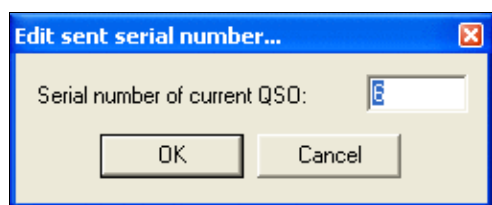

## Preventing crashes mid-contest

Win-Test is a very stable contest logging application and it was built with **stability** in mind because, let's face it, everybody **hates** logging program crashes midway through a contest.

As a result, a crash is *most likely* to be a result of a conflicting program on the operating system (of course there are exceptions, but very rare). It is *highly* recommended that you close all unnecessary programs.

Common programs left running (which, nonetheless, are still totally unnecessary) include instant messaging programs (e.g. Windows/MSN Messenger, ICQ, Skype etc), audio program 'agents' (e.g. Winamp agent, RealPlayer agent, ...) etc. Please close **everything** is not required for your contest operation.

## Namespaces

- [Page](#)
- [Discussion](#)

## Variants

## Views

- [Read](#)
- [View source](#)
- [View history](#)

## More

- This page was last edited on 31 March 2007, at 20:11.
- [Privacy policy](#)
- [About Win-Test Wiki](#)
- [Disclaimers](#)



# Mailing List

From Win-Test Wiki

[Jump to navigation](#) [Jump to search](#)

## Contents

- [1 Knowledge needs to be shared](#)
- [2 Subscribing to the mailing list](#)
- [3 Unsubscribing to the mailing list](#)
- [4 Searching and browsing the archive](#)

## Knowledge needs to be shared

A Win-Test mailing list does exist for mutual assistance between Win-Test users. It is a public list.

## Subscribing to the mailing list

You can easily subscribe to this list by sending a mail to [support-request@win-test.com](mailto:support-request@win-test.com) while indicating "subscribe" (without the quotation marks) in the subject.

You must be a subscriber to this list before sending a post. If not, your message will be rejected. Nevertheless, you can freely browse the archives (see below) without subscribing.

To post to the mailing list you must use [support@win-test.com](mailto:support@win-test.com)

## Unsubscribing to the mailing list

You can easily unsubscribe from this list by sending a mail to [support-request@win-test.com](mailto:support-request@win-test.com) while indicating "unsubscribe" (without the quotation marks) in the subject.

## Searching and browsing the archive

Before sending a post, we advise you to have a look in the [public archives of the list](#) in order to see whether your problem has already been mentioned, and possibly solved, by other users.

You can also [search this archive](#), as it is indexed by Google. For example, to search for **QTCs** you'd use the following keywords in Google's search box:

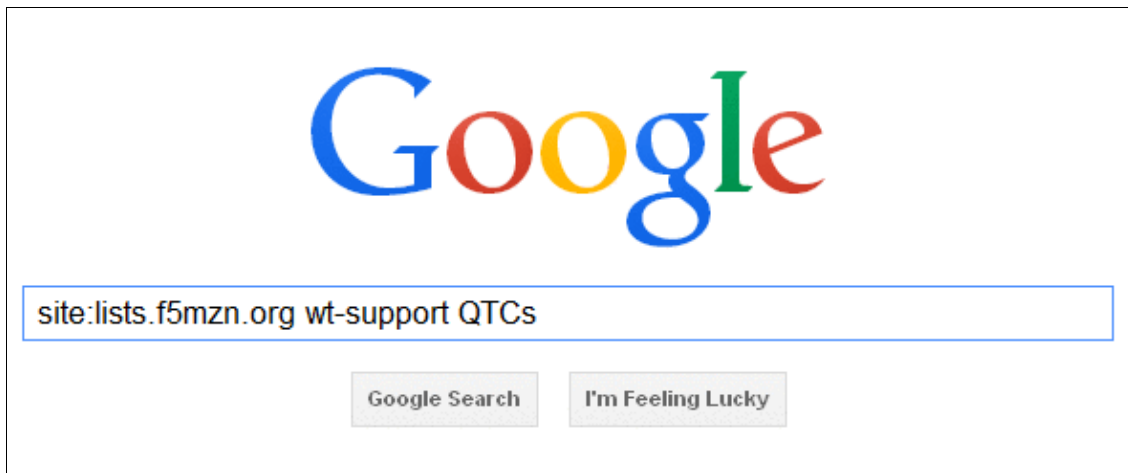

How to search the Win-Test Mailing List Archive

## Namespaces

- [Page](#)
- [Discussion](#)

## Variants

## Views

- [Read](#)
- [View source](#)
- [View history](#)

## More

- This page was last edited on 5 March 2023, at 17:28.

- [Privacy policy](#)
- [About Win-Test Wiki](#)
- [Disclaimers](#)



# Release Notes

From Win-Test Wiki

[Jump to navigation](#) [Jump to search](#)

## Contents

- [1 Release information 4.47.0 \(to be released\)](#)
  - ◆ [1.1 Bugfixes](#)
  - ◆ [1.2 New features](#)
- [2 Release information 4.46.0 \(January 17th, 2023\)](#)
  - ◆ [2.1 Bugfixes](#)
  - ◆ [2.2 New features](#)
- [3 Release information 4.45.0 \(October 18th, 2022\)](#)
  - ◆ [3.1 Bugfixes](#)
  - ◆ [3.2 New features](#)
- [4 Release information 4.44.0 \(July 22nd, 2022\)](#)
  - ◆ [4.1 Bugfixes](#)
  - ◆ [4.2 New features](#)
- [5 Release information 4.43.0 \(July 1st, 2022\)](#)
  - ◆ [5.1 Bugfixes](#)
  - ◆ [5.2 New features](#)
- [6 Release information 4.42.0 \(May 20, 2022\)](#)
  - ◆ [6.1 Bugfixes](#)
  - ◆ [6.2 New features](#)
- [7 Release information 4.41.0 \(Feb 15, 2022\)](#)
  - ◆ [7.1 Bugfixes](#)
  - ◆ [7.2 New features](#)
- [8 Release information 4.40.0 \(Jan 18, 2022\)](#)
  - ◆ [8.1 Bugfixes](#)
  - ◆ [8.2 New features](#)
- [9 Release information 4.39.0 \(Dec 6, 2021\)](#)
  - ◆ [9.1 Bugfixes](#)
  - ◆ [9.2 New features](#)
- [10 Release information 4.38.1 \(Oct 25, 2021\)](#)
  - ◆ [10.1 Bugfixes](#)
- [11 Release information 4.38.0 \(Oct 25, 2021\)](#)
  - ◆ [11.1 Bugfixes](#)
  - ◆ [11.2 New features](#)
- [12 Release information 4.37 \(June 29, 2021\)](#)
  - ◆ [12.1 Bugfixes](#)
  - ◆ [12.2 New features](#)
- [13 Release information 4.36 \(May 19, 2021\)](#)
  - ◆ [13.1 Bugfixes](#)
  - ◆ [13.2 New features](#)
- [14 Release information 4.35 \(Apr. 9, 2021\)](#)
  - ◆ [14.1 Bugfixes](#)
  - ◆ [14.2 New features](#)
- [15 Release information 4.34.1 \(Feb. 5, 2021\)](#)
  - ◆ [15.1 Bugfixes](#)

- [16 Release information 4.34.0 \(Jan. 25, 2021\)](#)
  - ◆ [16.1 New features](#)
  - ◆ [16.2 Bugfixes](#)
- [17 Release information 4.33.0 \(October 14, 2020\)](#)
  - ◆ [17.1 New features](#)
  - ◆ [17.2 Bugfixes](#)
- [18 Release information 4.32.0 \(September 1, 2020\)](#)
  - ◆ [18.1 New Features](#)
  - ◆ [18.2 Bugfixes](#)
- [19 Release information 4.31.0 \(June 28, 2020\)](#)
  - ◆ [19.1 New Features](#)
- [20 Release information 4.30.0 \(Jan 16, 2020\)](#)
  - ◆ [20.1 Bugfixes](#)
  - ◆ [20.2 New Features](#)
- [21 Release information 4.29.0 \(July 5, 2019\)](#)
  - ◆ [21.1 Bugfixes](#)
  - ◆ [21.2 New Features](#)
- [22 Release information 4.28.0 \(June 15, 2018\)](#)
  - ◆ [22.1 Bugfixes](#)
  - ◆ [22.2 New Features](#)
- [23 Release information 4.27.0 \(Jan 4, 2018\)](#)
  - ◆ [23.1 Bugfixes](#)
  - ◆ [23.2 New Features](#)
- [24 Release information 4.26.0 \(Nov 19, 2017\)](#)
  - ◆ [24.1 Bugfixes](#)
  - ◆ [24.2 New Features](#)
- [25 Release information \(4.25.0\) \(June 28, 2017\)](#)
  - ◆ [25.1 Bugfixes](#)
  - ◆ [25.2 New Features](#)
- [26 Release information \(4.24.0\) \(January 20, 2017\)](#)
  - ◆ [26.1 Bugfixes](#)
  - ◆ [26.2 New Features](#)
- [27 Release information \(4.23.0\) \(October 21, 2016\)](#)
  - ◆ [27.1 Bugfixes](#)
  - ◆ [27.2 New Features](#)
- [28 Release information \(4.22.0\) \(August 26, 2016\)](#)
  - ◆ [28.1 Bugfixes](#)
  - ◆ [28.2 New Features](#)
- [29 Release information \(4.21.0\) \(June 27, 2016\)](#)
  - ◆ [29.1 Bugfixes](#)
  - ◆ [29.2 New Features](#)
- [30 Release information \(4.20.0\) \(January 17, 2016\)](#)
  - ◆ [30.1 Bugfixes](#)
  - ◆ [30.2 New Features](#)
- [31 Release information \(4.19.0\) \(October 15, 2015\)](#)
  - ◆ [31.1 Bugfixes](#)
  - ◆ [31.2 New Features](#)
- [32 Release information \(4.18.0\) \(September 25, 2015\)](#)
  - ◆ [32.1 Bugfixes](#)
  - ◆ [32.2 New Features](#)
- [33 Release information \(4.17.0\) \(June 30, 2015\)](#)

- ◆ [33.1 Bugfixes](#)
- ◆ [33.2 New Features](#)
- [34 Release information \(4.16.0\) \(Mar 17, 2015\)](#)
  - ◆ [34.1 Bugfixes](#)
  - ◆ [34.2 New Features](#)
- [35 Release information \(4.15.0\) \(Nov 22, 2014\)](#)
  - ◆ [35.1 Bugfixes](#)
  - ◆ [35.2 New Features](#)
- [36 Release information \(4.14.0\) \(Oct 19, 2014\)](#)
  - ◆ [36.1 Bugfixes](#)
  - ◆ [36.2 New Features](#)
- [37 Release information \(4.13.0\) \(Jun 30, 2014\)](#)
  - ◆ [37.1 Bugfixes](#)
  - ◆ [37.2 New Features](#)
- [38 Release information \(4.12.0\) \(February 10, 2014\)](#)
  - ◆ [38.1 Bugfixes](#)
  - ◆ [38.2 New Features](#)
- [39 Release information \(4.11.0\) \(October 20, 2013\)](#)
  - ◆ [39.1 Bugfixes](#)
  - ◆ [39.2 New Features](#)
- [40 Release information \(4.10.0\) \(October 23, 2012\)](#)
  - ◆ [40.1 Bugfixes](#)
  - ◆ [40.2 New Features](#)
- [41 Release information \(4.9.1\) \(October 27, 2011\)](#)
  - ◆ [41.1 Bugfixes](#)
- [42 Release information \(4.9.0\) \(October 26, 2011\)](#)
  - ◆ [42.1 Bugfixes](#)
  - ◆ [42.2 New Features](#)
- [43 Release information \(4.8.0\) \(June 26, 2011\)](#)
  - ◆ [43.1 Bugfixes](#)
  - ◆ [43.2 New Features](#)
- [44 Release information \(4.7.0\) \(December 2, 2010\)](#)
  - ◆ [44.1 Bugfixes](#)
  - ◆ [44.2 New Features](#)
- [45 Release information \(4.6.1\) \(Released only for demo and DxPed versions\)](#)
  - ◆ [45.1 Bugfixes](#)
  - ◆ [45.2 New Features](#)
- [46 Release information \(4.6.0\) \(October 24, 2010\)](#)
  - ◆ [46.1 Bugfixes](#)
  - ◆ [46.2 New Features](#)
- [47 Release information \(4.5.2\) \(July 3, 2010\)](#)
  - ◆ [47.1 Bugfixes](#)
- [48 Release information \(4.5.1\) \(June 27, 2010\)](#)
  - ◆ [48.1 Bugfixes](#)
- [49 Release information \(4.5.0\) \(June 5, 2010\)](#)
  - ◆ [49.1 New Features](#)
  - ◆ [49.2 Bugfixes](#)
- [50 Release information \(4.4.0\) \(January 17, 2010\)](#)
  - ◆ [50.1 Bugfixes](#)
  - ◆ [50.2 New Features](#)
- [51 Release information \(4.3.0\) \(November 23, 2009\)](#)



- ◆ [51.1 Bugfixes](#)
- ◆ [51.2 New Features](#)
- [52 Release information \(4.2.0\) \(October 21, 2009\)](#)
  - ◆ [52.1 Bugfixes](#)
  - ◆ [52.2 New Features](#)
- [53 Release information \(4.1.0\) \(August 8, 2009\)](#)
  - ◆ [53.1 New Features](#)
  - ◆ [53.2 Bugfixes](#)
- [54 Release information \(4.0.1\) \(June 30, 2009\)](#)
  - ◆ [54.1 Bugfixes](#)
- [55 Release information \(4.0.0\) \(June 26, 2009\)](#)
  - ◆ [55.1 New Features](#)

## Release information 4.47.0 (to be released)

### Bugfixes

- When hovering an hyperlink, the hand cursor was not always displayed.
- HA DX contest : It was not possible to edit the serial sent (for non-HA stns). Tnx DJ8EW, DL6RAI.
- DARC Easter : The worked mults wnd (Alt-M) didn't display the correct data. Tnx DL7YS.
- F10 window : Under some circumstances and for specific contests, it could crash the program. Tnx PA2A.

### New features

- Lua API version string is 1.10.0
- Yuri Gagarin International DX Contest disabled because of the new rules where the same exchange can be counted differently (per band, or per band and mode) depending on its nature. The code can't cope with that.
- New text command : LOADMSGs to open the current op. directory and allow loading CW or RTTY messages.
- Lua : wtQso:SetSentSerial(nSerial) : If applicable, set the serial of the current QSO.
- Self-spot allowed for the ARRL DX, ARRL Sweepstakes and Russian DX. Complain to the ARRL and SRR if you want to stop this madness. Tnx N6TV.
- Lua : wtGab:Send now accepts a third optional boolean parameter to \*not\* log the sent gab. New API syntax : wtGab:Send(strText[, strToStation [, bDontLog]]). Tnx KD4D. Ex : wtGab:Send("Hello world!", "STN45", true) will send "Hello world!" as a gab to STN45, but won't log/display it in the sender Gab window.
- Lua : onBandChange event : If the radio is out of bands, the value of wtArg when onBandChange is called is set to "0/RadioId". Tnx TK5EP.
- Lua : New wtApp:Timeout(nDuration) added. Similar to wtApp:Sleep except Win-Test is not blocked while it is executed. nDuration expressed in ms.
- Lua : New wtApp:TimeoutBox(nDuration, [strText, [bAbortEnabled]]) API added. Displays a modal dialog box with a timeout progress bar, an optional centered text and an (optionally enabled) abort button. The duration is expressed in milliseconds (min 100). Win-Test is not blocked while it is executed.
- File / Explore now only copies the path if the Shift key is held.
- Fix bug : The NA Sprint LCR parser failed under some circumstances. Tnx N6TV.
- All CQ Contests : Restrictions regarding Russia and Belarus are now lifted. Tnx PA2A.
- CQWW RTTY : LCR parser added. Tnx F5UII.

- Option added in the World Map display to the differentiate skimmers spots from the human spots.

## Release information 4.46.0 (January 17th, 2023)

### Bugfixes

- ARRL RTTY Roundup : The Check Mult window (F10) was not filled properly. Tnx PA2A.
- When entering your own callsign in the log (to cancel a QSO), your own location was displayed on the spots map (if enabled).
- FT-891 : Code totally rewritten and it now works as expected. Tnx RX3APM for report, and DK5MR for testing.

### New features

- Lua API version string is 1.9.0
- Lua : wtApp:TextCommand now accepts "\*" as strStn to send to all stations of the network.
- Lua : New local variable wtFrom. Set to nil by default. Contains the name of the station that sent the text command thru network to run a local script. Can be useful when two (or more) stations exchange data with scripts.
- Lua : New onBandChange event when there is a band change. wtArg includes the band name and the radio as strings (ex : "10/0" for 10m on radio1). Reminder : The band name can have letters in it (2KM, 10G etc.) onBandChange.wts example : \_, \_, band, radio = string.find(wtArg, "(%d+[GKM]\*)/(%d+)") wtApp:AlertBox("RadioID: " .. radio .. " Band: " .. band). Tnx TK5EP.
- WAG : LCR parser added.
- Cabrillo import : When the Cabrillo contest identifier is unknown, Win-Test now offers the possibility to choose the contest the log is referring to.
- Radio wnd / List view : When possible, set an inactive VFO indicator. Tnx DJ0ZY.
- Carrier / Tune timer : The remaining time is now displayed in the Stop button caption.
- Explore Current op. directory added to the File menu. Two (similar) Lua API added to get this path : - wtApp:GetCurrentOpPath() - wtOp:GetPath()
- Lua : New wtKeyer:Load(strFileName) API to load messages from a .smsgs file. If no path is specified, the current op. directory is used. Tnx F6IFY.
- The default directory to save or load CW/RTTY messages is now set to the current op. directory.
- The QTC transmit and receive dialogs are checked to be always visible even if their positions were saved with a different monitors configuration. Tnx F5UII.
- The WAE messages can now be saved and loaded.
- Partner Wnd : After a Q is entered and the window is cleaned, the remaining content stays in place to not mess up the \$GRABn variables. Tnx FY5KE.
- Scripts manager : Refresh button added. Useful if you alter directly the scripts directory.
- Ctrl-X now prompts for a text command to be executed on the current QSO if it applies.
- The log caret / cursor can now be displayed as a solid block (Options / Log). Text commands : BLOCKCARET / NOBLOCKCARET or BLOCKCURSOR / NOBLOCKCURSOR. Tnx DL6RAI.
- When archiving, the full path of the generated zip file is copied to the clipboard.
- When using RUN vs S&P, Alt-F4 (return to the last RUN CQ freq) switches automatically to RUN. Tnx F5UII.
- WAE : Following the rules, if the received serial is set to 000, points are credited only if it is a new mult. Tnx F5UII.
- Text commands : "NOTES" added as a text command to open the notes file attached to the current log.

- Partner window : Partial callsigns or callsigns with wildcard character(s) '?' are now removed if they match the callsign entered in the log. Tnx FY5KE.
- Checkmark added to the freq offsets menu item if they're enabled.
- The summary data broadcast is now allowed for single-ops, independently of the Master setting in the contest configuration dialog. Tnx K2RET.

## Release information 4.45.0 (October 18th, 2022)

### Bugfixes

- Flex 6000 series added. Fixes the RTTY filter selection bug with the Kenwood interface. Only one slice is displayed, unless the split is selected. Tnx DL6DH, DL8OH, DL6RAI.
- IARU FD R1 : /MM stations do not count as mult. Tnx DL6RAI.
- WAEDC : When the Alt-M window was copied, the numerical call areas of the countries that apply weren't used. Tnx DL6RAI.
- OK1WC Challenge : When the callsign length was over 8 chars, the mult extraction (last char of the suffix) wasn't working correctly. Tnx DJ0ZY/DD5M.
- IOTA contest : In Multi-1 category, the QSO numbering was wrong. Tnx DL6RAI and others.

### New features

- Outbound RadioInfo external UDP messages capability added in the interfaces settings dialog (network advanced settings), to make easier to use additional programs or devices. Already tested with the rf-kit.de RF2K-S SSPA. Tnx F5HRY.
- Freq offsets : New text commands to access the setup : OFFSETSETUP (or OFFSETSSETUP). New text commands to enable/disable the freq offsets: OFFSET/NOOFFSET, OFFSETS/NOOFFSETS, OFFSETON/OFFSETOFF, OFFSETSON/OFFSETSOFF. Tnx F5UII.
- OCDX : /M, /MM and /P do not count as prefix multipliers.
- New setting dialog (Commands / Carrier timer...) to enable or not the carrier/tune (Ctrl-T) timer and set its duration. Tnx F5HRY.
- The /LH callsign extension (LightHouse) doesn't interfere anymore in the DXCC entity resolution. Tnx F5UII.
- DXPed HF : Distance added to the geographical data of the F10 wnd. Tnx F5UII.
- Yaesu Band data code for 60m added on the LPT output. As the default code (identical to 40m) can interfere with other bands, the user can choose to use the 50 MHz (6m) band code or an unused code. Tnx FY5FY.
- Text and CSV export : The format YYMMDD is added to the fields list. Tnx F6AJA.
- IOTA contest : Cabrillo updated to v3.
- IOTA contest : Rules 2022 : The Q with Russian and Belarus stations count 0 point and don't count as multipliers. See <https://www.rsgbcc.org/hf/rules/2022/riota.shtml> (RSGB IOTA Contest website) for details.

## Release information 4.44.0 (July 22nd, 2022)

### Bugfixes

- REG1TEST files : The QSO points and the claimed score were always set to 0 by default. Tnx F1EZG @ TM5R.

## New features

- When applying exchange(s) to entered QSOs (Ctrl-F10), the numbers of found QSO and updated QSO are notified.

## Release information 4.43.0 (July 1st, 2022)

### Bugfixes

- Bugfix : The CW default messages for the REF DDFM 50 MHz were wrong.
- Bugfix : The title of the LPT port properties dialog was incorrect.
- Bugfix : When using markers in the bandmap and if the marker text was totally visible, the first line of the tooltip was empty. Tnx F6BGC.

## New features

- All Asian DX : Cabrillo updated to v3.
- Generic VHF+ contests have been extended to accommodate contests where a fixed exchange is sent instead of a serial number. Just enter this exchange in the "Exchange" field of the contest configuration dialog. If this entry field remains empty, the usual serial numbers are used. Tnx DL6RAI, DJ0ZY.
- All VHF+ generic contests are no more limited to 6-char grids (locators) and now accept 4-char grids (locators) exchanges as well.
- New option in the Cabrillo options dialog and the REG1TEST options dialog to set the claimed score to 0 point. Useful if you are using a contest template that is not fully adapted to the scoring method, and you don't want to mess up the claimed scores (if any).
- The names of two microwaves bands over 76 GHz were wrong. They are now correctly labelled 122G and 134G, instead of 119G and 142G. Tnx F4CWN.
- New band data code available on the LPT output, designed for VHF+ bands, from 50 MHz to 122 GHz. Tnx F4CWN.
- Band plans : New option to reject (automatic) spots outside the defined segments for a given mode, acting as filters. Tnx DL3DXX. Reminder : By default, the band plans are used to determine the mode of the (non-automatic) spots. They don't act as freq filters.
- Merge Logs : When sorting logs and if the timestamps of two (or more) QSO are identical (can happen if logs were imported from Cabrillo files), Win-Test now relies on the serial sent (if any) to order these QSO. Tnx N6TV.
- Yaesu FTDX-10 added. Tnx DL4LAM.

## Release information 4.42.0 (May 20, 2022)

### Bugfixes

- The display options of the zones window(s) (Alt+Z) were not always correctly retained between sessions. Tnx F5LIW.
- Notes report dlg : After editing a note, the log caret (cursor) wasn't restored.

## New features

- When creating your Cabrillo log, you can now also submit it in one click to the Super Check Partial Database. This feature requires wtScpSubmit.dll which is included in the latest Win-Test installers. If needed, this dll is also available at <http://download.win-test.com/utls/wtScpSubmit.dll>. It must be placed in the Win-Test installation directory. Under some circumstances (especially with oldest OS), you may need MSVCP140.dll and/or others to be installed on your system. The easiest way is to install the latest Microsoft Visual C++ Redistributable packages for Visual Studio X86 available here: [https://aka.ms/vs/17/release/vc\\_redist.x86.exe](https://aka.ms/vs/17/release/vc_redist.x86.exe). Finally, on Win7, to ensure TLS 1.1 and 1.2 are enabled, apply this easy fix <https://is.gd/QlOgBg>
- CQ-M : 10-minute rule for MOST (M/S) entries removed (rules 2022).
- Add LCR parsers to the CQ-M, RAEM, and Yuri Gagarin DX contests.
- Add the Out Of Band sections to the CQ WW and CQ WPX LCR parsers. Tnx F6KOP.
- OK/OM : Rules 2022 : The Q with Russian and Belarus stations count 0 point and don't count as multipliers. See <http://www.okomdx.crk.cz/> (OK-OM DX contest website) for details.
- Interfaces Setup dialog : The keying compensation can now be negative (in the case where the TRX extends the keying). Tnx N6TV.
- CQWPX : Rules 2022 : The Q with Russian and Belarus stations count 0 point and don't count as multipliers. See <https://is.gd/HIMOLP> (CQWPX blog) for details.
- Lua : It's now possible to attach Lua scripts to text commands that are identical to mode names ("SSB", "CW", "RTTY", etc.). In these cases, the script will be called \*after\* the command is processed normally by Win-Test. Tnx TK5EP.
- The DX spots window (Alt+A) display options are now interactive.
- World Map : Options : The colors of the paths can now be the same as the markers.

## Release information 4.41.0 (Feb 15, 2022)

### Bugfixes

- REG1TEST / EDI : Under some circumstances, the output file wasn't created. Tnx OZ1ZAA.
- \$MSG10 was actually sending the additional MSG1 instead of MSG10. A 20-year old typo in the code ! Tnx SP5KP.

### New features

- Lua API version string is 1.8.0
- Op-entered spots are now protected from spots of the same DX on a freq inside the mode bandwidth window. Tnx DL6RAI.
- NA Sprint : LCR parser updated. Tnx N6TV.
- New countdown timer added (Tools menu or TIMER text command), especially for the single-ops. It indicates exactly when they can operate again after a pause. It's based on the time of the last QSO entered in the log, truncated to the minute. You can also use the text command TIMER/nnHmM or TIMER/nnHm (meaning nn hours and mm minutes), or TIMER/xxH (nn hours) or TIMER/nnM (nn minutes) to set and start the timer automatically. Tnx F5NZY.
- Shortcuts added to some of the reports buttons.
- QSO times are now by default considered as truncated to the minute for Time ON / Time OFF calculations and the QSY rules. Tnx F5NKX.
- Contest Recorder : AltGr+O, and text commands RECORD/NORECORD (and STARTRECORD/STOPRECORD) added to Start/Stop recording.

- UBA DX : Updated to comply with the rules 2022. Tnx F5LIW.
- World Map : "Copy content as image" menu item added.
- RTTY windows : Esc button added. Tnx PA2A.
- Notes report dialog. It's now possible to edit a note by selecting it and use Alt-N to modify the comment. Tnx F4CWN.
- REF HF : For M/S entrants, the compliance of the 10-min rule can be checked by using the appropriate item in the Tools / Check log menu.
- REF HF : Timer added in the Alt-J wnd for the M/S entrants.
- Lua : New wtRadio\* API : wtRadio\*:GetBand(), wtRadio\*:GetMode() and wtRadio\*:GetCqData() added. GetBand() and GetMode() return the current band and mode of the radio. GetCqData() return a Lua table with various data on the last sent CQ (that are stored for Alt-F4) : "freq", "qsx", "band", "mode" and "wpm" (for CW).
- World Map : New options to display short and longs paths for "my spotters" and the NCDXF beacons.
- New "NCDXF" text command to set the active radio on the NCDXF beacons frequency (if it applies).
- New option in the world map display option to show the NCDXF beacon that currently transmits if the radio is on the NCDXF frequency (+/- 100 Hz).
- The world map display options are now interactive. Different styles and a night opacity slider are also added.
- The "copy as image" feature now also copies the image in PNG format, to extend the paste scope (mail, twitter etc.).
- The RBN nodes and frequent spotters databases can be directly updated with the contextual menu of the map wnd (Display options).

## Release information 4.40.0 (Jan 18, 2022)

### Bugfixes

- Automatic op-entered spots during QSOs (especially in S&P) were not replaced by DX-cluster / external spots.
- When sending a gab composed of CAPITAL letters, do not shake our own gab window.

### New features

- Interface dialog : The usable COM ports are now extended up to COM32. The parameters list now also displays the Handshake (HS), Always ON (ON) and Always OFF (OFF) settings, and are ordered by Pin (DTR then RTS). Tnx DL5XJ, DL6RAI.
- New NCDXF/IBP Beacons window : Displays the transmission schedule of the NCDXF / IBP (International Beacons Project) beacons. A double click on a line gets the radio on the beacon freq. An "i" (stands for "info") in the status column indicates a comment you can read by hovering the mouse over it. Tnx VE3SUN.
- LCR : Croatian CW contest LCR parser added.
- LCR : Parser for CQ WW LCR updated. Works for preview and final reports.
- New feature : You can now grab a spot from the visible spots in the Radio windows or in the DX-cluster window by entering the callsign (or some letters of it) and Ctrl-Space.
- REF HF and REF 160m : LCR process updated. Tnx F4CWN.
- French (and some Belgian) users : Button added in the keys redefinitions dialog to load AZERTY redefinitions that allow the AZERTY keyboards users to access the numbers located on the top row without using the Shift or Shift Lock keys. They allow direct access to the ?, . and / keys of the

bottom row as well. This button is displayed only when the language is set to French.

## Release information 4.39.0 (Dec 6, 2021)

### Bugfixes

- Bugfix : For several contests, the columns headers were overlapping. Tnx F5HRY.
- WinKey : When using +/- in messages, the speed was randomly not reset to its initial value and the next message was sent with an incorrect greater speed. Tnx NN7CW and DL6RAI for their detailed reports and numerous tests to fix this long-standing bug.
- OK/OM CW DX-side : The district information display in the Mult window (F10) was broken.
- When Win-Test was started from the command line with an alternate application data directory (-a switch), the directory name wasn't unquoted. Tnx F1HAR.

### New features

- DX cluster (Alt-A) and Radio windows : The CT1BOH spot quality tags can now be displayed if they're sent by the skimmer. You can also filter the displayed spots by tag when applicable. Unless it's disabled by the user, in the list tab of the Radio window, the displayed spots are grouped by quality before being sorted. Tnx ES5TV.
- Script Manager : Hyperlink to the Lua API reference web page added.
- Op-entered spots are kept until worked or deleted on purpose, even if other stations are externally spotted on their frequencies. Tnx DL6RAI.
- Radio wnd : List tab : When spots are sorted by points or mult type, the second sorting criteria is now the beam heading rather than the spot frequency. Tnx DL6RAI.
- Gab : To draw attention, any gab text containing only CAPITAL letters now shakes the recipients gab window.
- SCP files : Defensive coding to attempt to prevent at best against crashes under some circumstances with badly-formatted or corrupted SCP or MASTER files. Tnx SP5KP.
- RDA Contest : LCR view added.
- OK/OM CW : 10 mins timer enabled for M/S category. RUN stations only.
- Larger log font sizes available for short-sighted ;-) Tnx TA2SE, W1NN.
- DX Spots window (Alt-A) : New option to pin the op-entered spots to the bottom of the window so you can always see them. Tnx DL6RAI.
- WAG : The output Cabrillo file is now following the v3 specs. Tnx DL1RTL.
- EU-DX : Multipliers list updated. Tnx IK6QON.

## Release information 4.38.1 (Oct 25, 2021)

### Bugfixes

- After importing a Cabrillo file, the resulting wt4 file couldn't be opened by Win-Test 4.38.0. Tnx F5LIW.

## Release information 4.38.0 (Oct 25, 2021)

## Bugfixes

- LCR parser fixed for the CQ WPX reports.
- CW : The spaced digits option was not read when starting Win-Test. Despite the checked option in the menu item, it was not enabled.
- CQWW VHF : When using the default CW messages, the sent grid was 6-char instead of 4-char. Tnx F5HRY.
- IARU HF : There are cases where different DXCC entities have the same Society (ex OH and OH0) and were counted as different mults.
- The "Dupes included or not in QSO counts and avg calculations" string in the summary text was always in local language even if summary in English was selected.

## New features

- Lua API version string is 1.7.0
- Defensive coding to check the log file when opening to prevent file corruptions. Tnx DL1DAW.
- Workaround for the USBSER.SYS bug that doesn't update the RTS line until DTR is accessed. Tnx R2AXZ (author of the Blue Pill Serial Monster).
- RDA Contest : Cabrillo updated to v3.
- WAE Transmit and Receive windows : New messages available.
- WAE : New CW variable \$RAWTIME to send the QTC time with cut numbers disabled.
- WAE : Transmit QTC window : A QTC line can now be directly sent by using the corresponding numeric key (0 sends the line labelled 10).
- Lua : New wtContest API : wtContest:GetCategoryId(), wtContest:GetModeCategoryId(), wtContest:GetPowerClassId() and wtContest:GetOverlayId() added.
- Lua : For standardization purposes, the microHam and OTRSP events scripts are now renamed :

```
microhamFsOn -> onMicrohamFsOn
microhamFsOff -> onMicrohamFsOff
otrspCrOn -> onOtrspCrOn
otrspCrOff -> onOtrspCrOff
otrspCrEvent -> onOtrspCrEvent
```

For now, to maintain compatibility, the script legacy names are still executed.

- Lua : New scripts called on log opening (onFileOpen) and on log closing (onFileClose).
- EU HF : The Cabrillo header is updated (EUHFC instead of EU-HF). Tnx DL6RAI.
- CQWW DX : The Youth overlay is added to the Overlay drop-down list.
- CQWW DX : The Explorer category is added to the Category drop-down list (Single-Op Explorer and Multi-Op Explorer).
- In the contest settings dlg, you can now set the default power class to use when creating new logs. Tnx DL6RAI.
- New archiving feature : File / Archive... (or ARCHIVE text command). It creates a timestamped zipped file in the log directory of the files related to the current log that are selected. Warning : Archiving audio recordings file that are usually pretty large can take a while... Be patient.
- For standardization purposes, all timestamped files are now timestamped to the nearest second.
- Time Shifting : The selection of the QSO and the stations are now independent. And a backup of the log is automatically performed before proceeding. Tnx EA7X/EF4HQ.
- Marconi Memorial HF : Points per QSO updated.



## Release information 4.37 (June 29, 2021)

### Bugfixes

- VHF+ contests : Sorting the Spots list by QSO points (related to distance if it can be computed) wasn't working.
- When copying the Summary wnd as text, the "Generated by Win-Test" line was missing. Tnx DL6RAI.
- Summary wnd : When using a language different from English, some column titles were incorrectly truncated.

### New features

- WAE : Rules 2021 : BY is added to the call area multipliers (so Chinese stations with different digits in their prefix count as different mults). Tnx DL7YS.
- ARRL FD : The "Covid" rule (Home stations can work home stations) is extended to 2021. Tnx VE2FWW.
- KCJ and KCJ Top Band contests rules updated. Tnx JI1RXQ.
- VHF+ contests : Discrepancies between gridsquares in the log for different bands weren't displayed in the Bad Exchanges check report. Tnx F4CWN.
- ARRL 10m : LCR viewer updated to fit to the new LCR format.
- The question mark character is now enabled in all QSO input fields, and the cursor is positioned on it when cycling the fields. Tnx N6TV.
- CW : New option for spaced digits in serials : When enabled, a half-space (^) is inserted between each digits of the serial, making it more readable at high speed.
- F10 Wnd : In DXPed HF or VHF, the date of the QSO is now displayed.

## Release information 4.36 (May 19, 2021)

### Bugfixes

- In Phone, when entering a (very) long exchange, the cursor might insert a ghost space character at the end of the field.
- VHF+ contests : Under some circumstances, when the automatic exchange (grid) guessing was set, the Check Partial wnd wasn't updated anymore after the field was automatically filled.

### New features

- CQ-M : Scoring is now updated and follows the rules 2021.
- IARU HF : In M/S (Mixed only) category, the 10-min status timer now takes into account mode changes. Tnx HA6OI.
- HA DX : The Cabrillo output file now includes the RUN/MULT indicator for the M/S entrants. Tnx HA6OI.
- YOTA (Youngsters On The Air) contest implemented.
- ARI DX / ARI 40-80 : Provinces list and exchange equivalence file (ARIPROV.DAT) updated. Tnx HB9AMO, DL6RAI.
- City, State/Prov, Postal Code and Country separate fields added to the contest settings dialog to improve the compatibility with the Cabrillo v3 header fields. These fields are assembled together to maintain the back compatibility with the Cabrillo v2 format if needed. It is highly recommended to

edit your saved profiles (if any) by loading, editing and saving them one by one in the dialog.

- CQMM DX implemented.
- All file dialogs are now resizable.
- YUDX : LCR view added.
- LCR viewer : Column order unified.
- OK/OM Contest SSB : This contest was not listed when the contests of the month checkbox (in April) was selected. Tnx F1HAR.
- OK/OM contest : You can now directly download your LCR in Win-Test from the "rejected" link in the final results and preliminary results page.

## Release information 4.35 (Apr. 9, 2021)

### Bugfixes

- OK/OM Contest SSB : When entering as non OK/OM, the points credit was wrong when working an OK/OM stn. Tnx F1HAR.
- When parsing the DX cluster stream, lines were discarded if the callsign of the spotter was longer than 9 characters (ex : 3V/KF5EYY-#, K4VET-1-# or JR1BFZ/2-#) and the freq higher than 9999.9 MHz. Tnx DL6RAI.
- RSGB Commonwealth Contest : The off-time value wasn't specified for this contest (60 mins) and the default value (15 mins) was used instead. Tnx M0UNN.
- Tools / Automatic CQ Repeat : The delay between CQ was not saved between sessions. Tnx F4CWN.
- Tools / Search for possible bad exchanges : If there was no log discrepancies and a check against the database was requested, it was not displayed. Tnx F4CWN.
- Lua : wtQso:IsModeCw() was always returning false.

### New features

- King Of Spain : The 10 min rule for the multi-op entrants is now removed.
- Radio Wnd : Ctrl+R shortcut added to allow cycle the view tabs without using your mouse.
- Option added in the dialog to replace op in batch, to match any operator already entered.
- LZ DX contest : LCR view added.
- SPDX : The limitation on the number of band/mode changes during a clock hour in all categories is now removed.
- RTTY windows : It's now possible to log the data stream to files created with the .ry1 and .ry2 extensions. Tnx DL6RAI.
- The default off-time when not specified in the rules is now set to 30 minutes instead of 15.
- WAEDC : LCR review added. Tnx DL7YS, DL6RAI.
- DX Cluster Announces (Alt+A) : Exchanges can now be displayed (if it applies). Tnx F4CWN.
- DX Cluster announces (Alt+A) : New dialog to facilitate the choice of bands to be displayed, replacing the sub-menus. Tnx F5HRY.
- Alt+F4 / Alt+F5 : When running in CW, the current CW speed is saved when CQ'ing (or using Alt+F5), and is restored when QSYing back to the saved run frequency.
- UI : All textual child windows that can be resized with the mouse (Check Partial (F12), N + 1 (F8), Skeds (Alt+B), Gab (Alt+I), Stats (Ctrl+F9), Radios, RTTY, DX Cluster monitor (Alt+O) and announces (Alt+A)) are now resized according to the size of the font used. To remove this constraint and resize freely, keep the Shift key down while resizing.
- Cabrillo output : The @ character is now allowed in the operators list. Tnx N6TV.
- ARRL DX : Band changes restrictions set to 10 for the M/S category, according to the new rules. Tnx N1PSE.

- Check Partial (F12) : In some cases, when multiple wildcard characters (?) were used, no search was performed. It's no longer the case as soon as there are at least 2 characters that are not wildcards in the pattern to search. Tnx F4CWN.
- PACC : Cabrillo v3 output implemented.
- Summary wnd : For the Instagrammers and such, your callsign is now added to the window title. Tnx F6BGC.
- Multi-Distributed category introduced.
- More restrictive checks applied to the exchanges database to dump malformed callsigns or exchanges.
- New Exchanges Database information dialog : Options / Data files / Exchanges database... Text commands : EXCHDB, EXCHDATABASE, EXCHFILE or EXCHFILES. Tnx N6TV, DL5YM.
- LCR : Add instructions if Win-Test can't directly download and/or process LCR for some contests.
- RDXC : MOST indicators (0 and 1 for RUN and MULT) added to the Cabrillo output file. The 6-char grid square is now also required for all entrants. Tnx UA9QCQ.
- The callsign exceptions (callsigns that don't follow the usual rules, like RAEM, 5VDE, 7QAA, etc.) are no more hardcoded and are now grouped in the exceptions.dat file (in the /extras directory) for easy updating.
- CQWW 160m : Cabrillo v3 output implemented. Tnx N6TV.
- ADIF output : QSO with my own callsign are always discarded. Tnx N6TV.

## Release information 4.34.1 (Feb. 5, 2021)

### Bugfixes

- EU-DX Contest : The 10m band was missing in the summary. Tnx F1DUZ.
- EU-DX Contest : CW and SSB columns added for the Mixed category.
- Italian translation DLL updated.

## Release information 4.34.0 (Jan. 25, 2021)

### New features

- Lua API version string is 1.6.0
- QQSLON / QQSLOFF or QQSL / NOQQSL text commands to enable (or disable) the Quick QSL feature. QUICKQSL still opens the Quick QSL settings dialog. Tnx F6IFY.
- EU-DX Contest added. Requires EU.DAT countries file. Tnx IK6QON.
- Lua : wtRadio\*:SetFreq(fFreq) and wtRadio\*:SetFreq(fFreq, nVfo) now ignore the freq if it's outside of any band, and return with no error message. Tnx F6IFY.
- Lua : wtQso:IsModeDigital() and wtQso:IsModeCw() added.
- Lua : nQsoNum (optional) added as argument to wtQso:GetData([nQsoNum]) function.
- LCR : IARU HF LCR processing rules updated.
- 5VDE added as an exception callsign.
- LCR : If Win-Test supports LCR review and the contest has been entered in a multi-op category, an Operator column is added in the review dialog. Tnx F5HRY.
- OK/OM contest : LCR processing added. Requires to save the "rejected QSO" page as an html file and to load it in Win-Test. Tnx F8BXI.
- CQWW DX : LCR processing rules updated to fit the new CQWW LCR format.
- ARRL Contests : The ARRL has finally unified the US States and VE provinces and territories lists, and the Prince Edward Island abbreviation is now PE for the ARRL DX, ARRL 10 and ARRL roundup RTTY contests.

- NAQP : The Prince Edward Island abbreviation is now PE. Tnx N6TV and AC0W.
- NA Sprints : The Prince Edward Island abbreviation is now PE.
- NRAU contest : New abbreviations for some Fylke / Lan / Province / Region updated. Tnx ES7GM.
- Script manager : The minus key located in the numpad is now considered different from the key located in the character keys. To be consistent, the same rule applies when redefining keys. Tnx F5HRY.
- JIDX : 160m added to the SSB leg. Tnx N6TV and N6KI.
- Icom IC-705 added. Tnx OH1MA.
- "Ethernet network" reworded as "Local Network" to prevent confusion. Tnx FY5FY.

## Bugfixes

- CQWW 160m : The exchange database file ARRL-USVE.DTB wasn't loaded. Tnx DL4MM.
- UK/EI : If the district field was manually filled before the serial number, that field was emptied when the cursor got back to the callsign. Tnx PA2A.
- RAEM Contest : The polar circle location (giving extra bonus points) was slightly wrong.
- The IC-9100 couldn't work... Because of a stupid typo ! Tnx DL2AKT and N6TV.
- WAE RTTY : When the log was reopened, the next sent QTC group number was wrong. Tnx DL6RAI, DJ9MH and DJ4MZ.

## Release information 4.33.0 (October 14, 2020)

### New features

- ARRL SS, ARRL 160, ARRL FD : PE (Prince Edward Island) section added. Tnx W1NN.
- MicroHAM MKIII interface added. Tnx G0HSA, OM7ZZ.
- When a file error occurs when saving DX-cluster data, the user can now Cancel to abort further writing attempts. Tnx DL5MLO.
- Exchanges Databases (.DTB files) : Defensive coding to attempt to prevent at best against crashes under some circumstances with badly-formatted or corrupted databases files. Tnx OK1DSZ @ OK4C.

### Bugfixes

- AGCW-DTC : 2 points Club stations list updated. Tnx DL6RAI.
- WAG : The Exchanges file (WAG\_DL.DTB) wasn't correctly loaded for DL entrants. Tnx DL4NAC and DL6RAI.
- All Asian DX contest : Cabrillo CONTEST: line text fixed. Tnx VA2EW.

## Release information 4.32.0 (September 1, 2020)

### New Features

- YO DX HF : Contest rules updated (160m added + points for /MM stations).
- WAE DX side : QTC line numbers displayed for easy retrieval in case of repeat request.
- All reports dialogs can now be vertically resized to display more or less list rows. The window placements are also globally saved.
- File / Update Exch Database : A confirmation dialog is now displayed and a backup of the current DTB file is done, before proceeding.
- New Check Partial search processing for VHF+ logs :

In VHF+ contests logs, you can now enter a partial callsign (in the callsign field) and/or a partial locator / grid (in the grid square field) to refine searches in the Check Partial wnd (F12).

The minimum number of chars to start the search for the callsign field is set by the contextual menu (3 by default), and set to 2 characters for the locator.

Finally, in both fields you can also use wildcards characters '?' to represent a character. Ex: "JN?8EQ" will search for all callsigns with locator JN08EQ, JN18EQ, JN28EQ, ... JN98EQ.

Inspired by DL2NBU DOS software. Tnx DL6RAI.

## Bugfixes

- callsign.pat updated. Tnx DL6RAI.
- RDAC : RDA.DAT (district list) updated.
- The audio record button is now disabled when recorded audio is playing.
- IOTA Mixed : Summary columns weren't consistent with the rest of them, and created a bug when used with Unipost (cqcontest.net). Tnx DL6RAI.
- When the same callsign was spotted on both sides of a sub-band limit (so, it was considered spotted in both modes), Ctrl-Up/Down kept grabbing these two callsigns alternately. Tnx F5UTN @ TM0HQ.
- ARI Sezioni : Rules and mult list updated. Tnx IV3IYH. Mult List : <http://download.win-test.com/databases/ARISEC.DAT>
- EU HF Championship : The content of the EU\_HF.DTB database was ignored. Tnx EW2AA.
- MMC HF wasn't showing up in the contests of the month in July. Tnx DL6RAI.
- LCR review added for ARRL 160, NA Sprint, ARRL Sweepstakes. Tnx N6TV.
- Elecraft K4 added. Tnx N6TV.

## Release information 4.31.0 (June 28, 2020)

### New Features

- Lua API version string is 1.5.0
- Lua : wtApp:PostMessage, wtApp:SendMessage and wtApp:GetLastError added. Tnx F6BEE for inspiration. See description and syntax in <http://download.win-test.com/v4/lua/LuaApiDoc.txt>
- ARRL FD : Covid-19 rule exception : Class D stations may work all other Field Day stations, including other Class D stations, for points. Tnx K6ZB.
- Log Checking Report (LCR) review added in the Tools / Check log menu. For now, only the following LCR are processed :
  - ◆ CQWW DX
  - ◆ CQWW WPX
  - ◆ ARRL DX
  - ◆ ARRL 10m
  - ◆ IARU HF
  - ◆ EU HF
  - ◆ SAC
  - ◆ KOS
  - ◆ REF HF
  - ◆ VHF+ contests if adjudicated with LX

Mainly, because these LCR are public, or because I had one ;-). Any textual (or html) LCR can theoretically be implemented, as long as I have access to a sample.

## Win-Test Wiki

For various reasons, sometimes the "Download LCR" may not work. In that case, try to download the LCR with your browser and save it in a convenient location (the log directory is the best choice). You can "attach" it to your log by using the "Save" button in the report dialog.

- Dx-Cluster window (Alt-T) : Number of Macros increased to 8. Tnx PA2A.
- Dx-Cluster macro editor : Window enlarged, and the edit field now wraps to improve readability. Tnx PA2A.
- The merge dialog now displays "compact paths".
- NRAU Baltic mults list updated. Tnx LB3RE.
- Review of the exchanges databases files to prevent mixing different exchanges between contests. Also, if a contest uses only a part of a database file, the rest is kept untouched if the database is updated with Win-Test.
- Depending on the contest and, if it applies, whose side you're on (DX side or domestic), the callsigns from the master file (namely MASTER.SCP/DTA or .DTB/SCP) are filtered to display only relevant results in the Check Partial and N+1 windows.
- The master file in use can now be directly updated from the Internet (like the CTY files) by using the Options / Data files / Master file menu, or by using the "Used File list" item in the contextual menu of the Check Partial or N+1 windows.

Note : The recommended default master file to use is MASTER.SCP, maintained by Stu K6TU (<http://http://supercheckpartial.com/>).

Reminder : You can also use contest-specific master files (recommended only for minor national or regional contests) named after the list located at

[http://download.win-test.com/files/checkPartial/%23\\_READ\\_ME\\_%23.TXT](http://download.win-test.com/files/checkPartial/%23_READ_ME_%23.TXT) These files do not replace the default master file, but complement it at runtime.

- In the contest settings dialog, contests no longer taking place have been removed from the list.
- New REBOOT (or RESTARTPC) text command added. It closes the current log and restarts the host PC. Tnx F8CRH, F6BEE.
- When the exchanges database is updated, a notification message is displayed at the bottom of log. Tnx DL6RAI.

## Release information 4.30.0 (Jan 16, 2020)

### Bugfixes

- If the backup volume was unmounted, disabling the next backups was failing. Tnx F6HJO. (Task #388)
- Under some specific circumstances, the Single-Op Assisted category wasn't taken into account when importing such a Cabrillo file. Tnx TO1A.
- With multi monitors systems and under some specific circumstances, choosing colors with mouse was impossible. Tnx KL0R.
- The headers row was always included in the CSV output file, whatever the setting was. Tnx F5LIW.
- The LCD display of the contest recorder wnd wasn't always properly updated when using a language different from English.

### New Features

- HA DX contest rules updated. Tnx HA6OI, HA1AG, F5LIW and others.
- UFT contest rules updated. Tnx F6CEL.

- Yaesu FTDX101 added. Tnx RA1ANY, RA3AUU.
- Icom IC-9700 added. Tnx F1ULQ.
- WAEDC : Cabrillo output file upgraded to v3 specs.
- WAEDC DX side : Send QTC dialog (Ctrl-L) now displays the maximum available QTC to send (if any). You can modify the number of QTC to send, or only display the already sent QTC, with F9 (or the "QTC / Show sent" button). F8 allows to modify the recipient callsign.
- QSO and distinct callsigns counts added in the distinct callsigns report when sorted by country.
- "Copy" button added to the log check dialogs, allowing to easily paste reports in a spreadsheet.

## Release information 4.29.0 (July 5, 2019)

### Bugfixes

- When a exception callsign and a prefix were identical in the CTY file, and under some specific circumstances, the DXCC lookup function could fail. Tnx F5LIW.
- FOC Marathon : Stats are now displayed on 3 days. Tnx F5NZY.
- RSGB AFS : Dupe count on 40m was wrong. Tnx G0HSA.
- REF 160m : The total and final score lines weren't displayed in the summary window.
- RTTY : Messages with embedded scripts were hanging Win-Test. Tnx N6TV.

### New Features

- YU DX Contest rules updated. Tnx F5IN.
- Spot Warnings : When you're spotted, the spot comment, if any, is now displayed.
- RSGB HF contests : District Code for Norwich has been changed from "NR" to "NK". Tnx F1ICS.
- ADIF export : Output fields reordered and STATION\_CALLSIGN field added. Tnx YT9TP.
- IARU HF : Cabrillo v3 output file implemented. Fixes also task #384. Tnx OH6XX, N6TV and others.

## Release information 4.28.0 (June 15, 2018)

### Bugfixes

- When no MP3 CODEC were detected, start recording was displaying the MP3 settings dialog in an endless loop. Tnx N6TV.
- ARI Contest : Serial numbers for DX stations have separate numbering per band. Tnx ES5TV.
- Validation controls of the split freq edit field strengthened.

### New Features

- Single-click actions option added to all windows where it makes sense. Tnx K5WQG, N6TV.
- The callsign "6OX" is accepted despite its exotic syntax.
- CQWW RTTY : DC mult added according to the 2018 rules. Tnx W0YK.
- Internal CW keyer (LPT and serial outputs) : Keying compensation added (0 to 20 ms) in the Interfaces setup dlg. Tnx N6TV.
- Icom IC-7610 added. Tnx N6TV.
- REF contest : Off-time periods dialog removed. Tnx F5LEN.
- CW / RTTY : Work dupes by default. Tnx F6IRA.

## Release information 4.27.0 (Jan 4, 2018)

### Bugfixes

- RAC contest : Despite the rules indicate MIXED (CW + SSB) category only entries, the F10 wnd wasn't correctly scaled when using a single-mode category. Tnx SP5KP.
- Statistics Wnd (Ctrl-F9) : Under some specific circumstances, the log data weren't correctly displayed in the targets tab. Tnx F5LIW.
- Auto-repeat mode was broken (silly me !). Tnx VE2FWW, N6TV, W4DD and many others.

### New Features

- DARC XMAS : Sprint logic exchange now applicable for this contest. Tnx K3LR and N6TV.

## Release information 4.26.0 (Nov 19, 2017)

### Bugfixes

- When prefixes or callareas are mults, some special callsigns weren't correctly taken into account. Tnx OF100FI/O.
- Status wnd (Alt-J) : Under some specific circumstances, the stations count displayed in the title bar was wrong.

### New Features

- LZ DX : QSO and DUPES columns were inverted in the summary window in single-mode categories, and CW and SSB columns were swapped in Mixed category. Tnx W3SE / ZL3TE.
- SAC : Wire-Only overlay category added. Tnx OH1RX.
- CSV and text exports : Serial sent text format is identical to the format used in the log. Tnx F5LIW.
- Gab wnd (Alt-I) : Can be cleared now with a CLEARGAB text command.

## Release information (4.25.0) (June 28, 2017)

### Bugfixes

- VHF+ contest : The ODX was broken under some specific circumstances. Tnx F5HRY/P.
- SPDX Contest : The summary window was broken. Tnx SP5KP, F5LIW and others. (Task #380)
- Asia-Pacific sprint : Win-Test was unable to write the output Cabrillo file. Tnx UA9YE.
- Some AltGr (Ctrl + Alt) keys were not correctly displayed when defined in the script manager or the DEFINEKEYS command.
- Under some very specific circumstances of networking connection / disconnection and sync enabling / disabling, the log file could be corrupted. Tnx PA2A @ PI4CC.

### New Features

- Helvetia contest : New rules 2017 implemented. Tnx HB9AMO and others.
- ARI DX : Allowed bands and 10-minute rule adapted to the rules 2017. Tnx IZ1LBG. (Task #379)



- RSGB AFS : 40m added. Tnx G3RTE.
- The displayed bands selection for the Check Callsign (F9), Check DXCC (Alt-M), Check Mult (F10) and Check Zone (Alt-Z) windows is now done in a dialog box instead of menu items. Tnx F5LIW.
- NA Sprint SSB : The Multipliers list is updated and is now similar to the mult list of the CW/RTTY legs . Also, the equivalence is now NA\_SPRINT.DAT for all legs, and has been updated on the repository. Tnx KA9FOX.

## Release information (4.24.0) (January 20, 2017)

### Bugfixes

- Under some circumstances, the rotators wnd was flickering.
- NA Sprint CW/RTTY : Multipliers list updated. Tnx N6TV, N6TR. Note : You must update your NA\_CW\_RTTY\_SPRINT.DAT equivalence file if you use it, to get credit for the new mults.
- DXPed HF logs : The country list used is now the DXCC one, not the "CQWW" one.
- FT1000 : VFO-B frequency setting enabled. Tnx DL6RAI.
- FT1000 : When setting a split freq, the filter setting wasn't retained. Tnx DL6RAI.
- Typo in a menu item. Tnx DL6RAI.
- When a callsign was grabbed, the realtime slot of the partners windows were not updated.
- Cabrillo : The alternate frequency option wasn't working for multi-ops logs.
- Under some OS display settings, the Alt-F dialog was truncated. Tnx HA3LN.
- After editing logged QSO, the Alt-J QSY timers were not always accurate.

### New Features

- New network protocol version 1.30 released. Reminder: If you use WT in a networked environment, you must have the same WT version on all machines!
- Lua API version string is 1.4.0
- To make the 3830scores.com reporting easier, the summary columns of the mixed mode contests are reordered.
- DXPed logs (HF and VHF) : The reports entry fields ignore keys which are not digits. Tnx DL6RAI.
- Summary wnd (Alt-S) : Displayed bands can be selected. This selection is in sync with the Check Callsign (F9), the Check DXCC (Alt-M), the Check Mult (F10) and the Check Zone (Alt-Z) windows. Note: It's only a display selection to save space : You can still QSY and enter Q on the hidden bands. And all bands are taken into account in the summary totals.
- 60m band added for the DXPed HF logs. NOTES:

1) Considering the various freq allocations depending on the country, a minimal band plan has been implemented in the Default band plan. You can modify it, according to your needs. Your custom band plans (if any) must be updated as well.

2) DXPed log files containing 60m QSO can't be read with previous versions of Win-Test.  
Tnx DL6RAI for testing.

- NAQP : Mult list and various other things updated according to the new rules. Tnx KL9A.
- ARRL 10m contest : Following the new rules, the multiplier "DF" is changed to "CMX". Tnx N6TV, N5KO.
- Lua : wtQso:GetData API : Gridsquare added in the table returned. Tnx N6TV.
- If a station type is sticked, its type is checked against the rules of a newly created contest file, and can be forced to the default Run type if needed. Tnx N6KI and N6TV.

## Release information (4.23.0) (October 21, 2016)

### Bugfixes

- WAG DX side : The NM exchange (Non Member) was considered as a N multiplier.
- Alt-F4 : The the CAT activity has now decreased , and the function was broken for mixed-mode logs. Tnx N6TV.
- Entering any text command in Secondary Radio Window moved it to the wrong band. Tnx N6TV. (Task #370/373)
- WAE : Under some circumstances, the log and QTC backup files were corrupted. Tnx F5LIW.
- VHF+ contests : When a gridsquare of a logged QSO was modified, the points weren't correctly computed on the other networked computers, leading to a score difference between them. Tnx DL8AAU.
- Under some circumstances of simultaneous log openings on different machines in a network, Win-Test could crash. Tnx W9PA @ K3LR.

### New Features

- Split Freq dlg : Now accepts offsets from the current frequency. E.g.: If your freq is 7020 and you enter +1.1, the split freq will be adjusted to 7021.1. Negative values (-1.1 for ex.) also work.
- UK/EI DX contest added. Tnx SQ8N.
- Secondary Radio wnd : Columns headings added. The color can be adjusted with the Colors (contextual) menu. Tnx N6TV.
- Radios : FT891, FTDX1200, FTDX3000 and FTDX5000 added. Tnx N6TV.
- WAE Phone : DX side : The INS and CR keys and buttons are now enabled in the transmit QTC dialog. The CR button tags the current QTC as sent. The INS button does the same, and makes the next QTC as the current one. It clearly makes the QTC transmission much easier to follow. Tnx F1HAR.

## Release information (4.22.0) (August 26, 2016)

### Bugfixes

- WAEDC : DX side CW / SSB : The potential QTC weren't displayed in the radio wnd (bandmap or list) despite the option was checked.
- WAEDC : The left and right arrows now work correctly in the dialog to chose the number of QTC to send.
- QTC transmit dlg : The active QTC wasn't correctly highlighted when using the Ctrl-Fx buttons.
- The default Check Partial / N + 1 file for VHF contests was HF.DTB instead of VHF.DTB. Tnx DK5KMA.
- When 4.20 and 4.21 were on the same LAN (not recommended), with sync enabled, 4.21 was hanging. Tnx N6TV.
- IARU HF : If an HQ was only 2 characters long, it was ignored.

### New Features

- WAE CW : DX side : The CW speed used when sending the QTC is now preserved between sessions, and the Rate wnd is updated accordingly. No need to juggle with Alt-F9/F10 anymore.
- Callsign Wnd (F9) : Tooltip more readable.

- New behaviour of the \$NEXT variable in the QTC transmit messages to make life much easier (and less confusing) for the DX stations in the WAEDC CW contest.
  - ◆ \$NEXT must be the first variable in the Ins message. The default message is now: \$NEXT \$DONE \$TIME \$CALLSIGN \$SERIAL
  - ◆ Update your current message if it is not up to date
  - ◆ When \$NEXT is executed, the active QTC jumps to the next one ONLY if the current QTC has been already sent.
  - ◆ With this new behaviour, the usual QTC transmission sequence is now:
    - ◇ Ctrl-L / Enter (or 1 to 9) to chose the number of QTC to send (usually 10).
    - ◇ After the QTC dlg shows up, exchange the QRV? and the QTC series number with the recipient.
    - ◇ From now, hit Ins for every QTC to send, one after the other.
    - ◇ If the receipient requests a full resend of the QTC just sent, use CR. If he requests an individual field, use the appropriate Fx key or button. If the QTC is ack'ed, use Ins to send the next one.
    - ◇ When all QTC of the series have been sent (and acknowledged), use Ins one last time (or Plus) to thank and save the QTC series.
  - ◆ In these conditions, you normally shouldn't need to use the Up/Down arrows anymore unless exceptional circumstances.
- CW and RTTY : New \$RAWSERIAL variable. Sends the serial number of the QSO with leading zeros and without any abbreviation. Now used in the default F3 msg (if it applies) to repeat the serial in a more traditional way. It also works in the QTC messages.
- Script manager dialog : Ctrl + Double click on a script brings up the properties dialog.
- IOTA contest
  - ◆ If the IOTA ref is pre-filled from the callsign field content, the new IOTA warning is now displayed if applicable. Tnx F5LIW.
  - ◆ EXPERIMENTAL : Separate numbering for Multi-One and Multi-Two categories : The RUN or RUN1 stations use a sequence of odd numbers (starting at 1), and the MULT or RUN2 stations use a sequence of even numbers (starting at 2).
  - ◆ Multi-Two category added. Tnx G3WVG.
  - ◆ The WAE entities list is now used to prefill the island reference more accurately (ex GM/s stations). Tnx N6TV.
- The DVK bargraph can now be horizontal (default) or vertical.
- Internal DVK : The first and last 100 ms of the messages are now truncated to prevent the keys and mouse clicks to be heard. Tnx SM5AJV and N6TV.
- RTTY shortcuts buttons are now a bit thicker to accommodate older eyes. Tnx SP5GRM.
- Additional CW and RTTY variables :
  - ◆ \$LOC4 and \$GRID4 are equivalent to \$GRIDFIELD.
  - ◆ \$LOC6 and \$GRID6 are equivalent to \$GRIDSQUARE or \$LOCATOR.

## Release information (4.21.0) (June 27, 2016)

### Bugfixes

- The CW "No sound" menu item state wasn't consistent with the CW sound status.
- The check mark on Options / Disable Log Sync wasn't consistent when no log was opened.
- The station name displayed in the network error dlg when several masters were on the same LAN wasn't correct.
- Gridsquares map window (Alt-L) : Mouse wheel actions were broken since version 4.7.0 !
- Stew Perry contest was using VHF.DTB instead of DEFAULT.SCP. Tnx N6TV. (Task #184).

- Serial communications : Under some circumstances, especially with some USB drivers under Windows 10, the inbound stream was not correctly processed. Tnx Jan @ remoterig.com
- Voice keyer (DVK) : Under some circumstances, some audio output devices may miss in the Interfaces settings dialog.
- French Championship : QSO with FT entities are now credited with 15 pts instead of 6. Tnx F4SGU.
- Remote dlg : The text command is now limited to 13 chars, to comply with the log entry field. Tnx N6TV. (Task #368)

## New Features

- Lua API version string is 1.3.0
- IARU HF : Duplicate HQ abbreviations are now managed. (Task #350)
- The login / logout protocols can be now disabled as the other ones in the advanced network settings.
- Log Sync : Better overall performance. Tnx DJ7TO, DL5MLO and the DA0HQ team.
- Cabrillo Options : New options similar to the File / Clean file options, but the QSO exclusions (or editions) are \*only\* temporary for the Cabrillo file output.
- ADIF Options : QSO range added.
- Mult Wnd (Alt-M) : The "hide clean sweeps" and "hide never worked" options are maintained during the text / SYLK copy. Tnx ES5TV.
- Tune dlg : For safety, added a 30-second timeout to automatically stop tuning no matter what.
- Stew Perry Challenge : Added for March, June and October.
- Lua : wtQso:GetData API : stnName and stnFlags added in the table returned. Tnx N6TV.
- CW Auto Send : Updated to allow its use when both radios are in RUN mode. Tnx SM5AJV, N6TV.
- Lua : wtApp:TextCommand updated to add strStation and nNotificationID arguments. Tnx N6TV.
- Standard and additional messages : New import / export features. Tnx N6TV.
- Clean log dlg : New option to remove 0 points QSO from the log. Tnx K3LR, N6TV.
- Radios : IC-7300 added. Tnx N6TV.
- CQ WPX RTTY : M/S entrants are now allowed to 10 band changes. Tnx EC1KR.

## Release information (4.20.0) (January 17, 2016)

### Bugfixes

- ARRL 10m : Tools / Check Bad Exchanges was broken.
- Under some circumstances, the default contest log names were broken.
- ARRL SS : Correct label for the sections field.

### New Features

- Radios : IC-7600, IC-7800, IC-7850, IC-7851 : New code for a better management of these radios. It requires the latest firmwares. Tnx N6TV, K3LR, K9LA (Icom America), ICOM France, HRO Sunnyvale (CA), AA6W and K6SSJ.
- Radios : FT-991 added. Tnx N6TV, SP5IOU.
- Radio Wnd : New option to enable / disable the RIT display, when applicable. Tnx F5LIW, K3LR.
- PACC contest : Rules 2016. Dutch provinces (for non-PA) and DXCC and call areas (for PA) now count as mult per band and per mode when taking part in Mixed category. Tnx PA5M.
- French Championship : Rules 2016 applied. Tnx F5LEN.
- Radio Wnd : Ctrl-Up / Ctrl-Down in the list view doesn't lose cursor when a Q is entered. Tnx K5KG. (Task #364).

- LZ DX Contest : New rules 2015 for LZ stations applied. The only limitation is the 10-min rule for the M/S station, which is always applied for band \*or mode\* change, independently of the status of the station (RUN or MULT). Tnx LZ2CJ.
- ARRL SS : Default CW msgs updated. Tnx W2GD, N6TV.
- ARRL SS : Added new message variable \$PREC (precedence) for the ARRL Sweepstakes, automatically determined from entry class and power level. Tnx N6TV.
- Log check reports : QSO with own callsign are now ignored. Tnx FY5KE.
- Status wnd (Alt-J) : X-min rule timers now ignore QSO with own callsign. Tnx FY5KE.
- Check country wnd (F10) : QSO with own callsign are now ignored. Tnx FY5KE.

## Release information (4.19.0) (October 15, 2015)

### Bugfixes

- SAC contest : This contest wasn't displayed in October if the "This month only" checkbox was enabled despite the SSB leg takes place in October. Tnx F5LIW.
- Rate Wnd (Alt-R). Various QSO rate statistics were wrong. Tnx CT1BOH.
- FT1000 : The TRX was switched to RTTY-USB for high bands instead of RTTY-LSB. Tnx DL6RAI @ P49V.

### New Features

- CAUTION: New network protocol version 1.29 released. Reminder: If you use WT in a networked environment, you must have the same WT version on all machines!
- Status Wnd (Alt-J) : Best effort to display the TX freq of the radios. Radio brand and model dependent. Tnx N6TV. Note : Icom users will need the latest Icom firmware, and the latest OmniRig rig definition files (check the N6TV files) to get chances to see VFO B displayed for Icom radios, especially if they want to use split mode.
- Experimental : VHF+ spots : When the comment is using the "Locator<Prop>Locator" format, the second locator is now considered as the DX locator. Tnx G3ZAY, F5HRY.
- Radio Wnd : Spot mode (according to the used band plan) added in the tooltip text.

## Release information (4.18.0) (September 25, 2015)

### Bugfixes

- NA Sprint : Tools / Check log / Search for possible bad exchanges was broken. Tnx N6TV.
- Rate Wnd (Alt-R). Various QSO and Mult statistics were wrong. Tnx CT1BOH.
- REG1TEST : The mode code is now output in the QSO records. It can be optionally omitted for contests where the mode is not stated in the rules, in accordance to the REG1TEST format specifications.
- WAEDC : The 10-min violations check was performed on the RUN and MULT stations, while this rule only applies to the RUN stations. Tnx DL1EKC.
- Partial (F12) and NP1 (F8) windows : While modifying an already entered QSO, the callsign of the original QSO wasn't correctly ignored during the searches. Tnx FY5FY.
- WAE : Receiving QTC : If the callsign of the QTC sender was modified, and the receiving dialog was cancelled, the modification remained.
- The Win-Test version number is no more extracted from the language file DLL, but rather from the exe itself, to get the correct string when having multiple Win-Test versions in the same directory. Tnx

F5TTU, F6BGC.

- When used in a network environment, a QSO entered on the secondary radio had a wrong serial number on the other machines of the network. Tnx DL5AOJ.
- Radio wnd : Under some circumstances, when your own callsign was entered in the bandmap (Ctrl-Enter), it was displayed as a new mult. Tnx TM0HQ.
- The action on Options / Disable Log Sync wasn't consistent when no log was opened.
- Toolbar : The tooltip text for the summary icon was missing since the very first version of Win-Test ! ;-)
- Bugfix : Alt-F dlg : Under some circumstances, the QSO op. was not specified.

## New Features

- WAE : Receive QTC dlg : Received serials are now formatted with leading zeroes if needed. Tnx F5LIW.
- WAE : Receive QTC dlg : Received times with 2 numbers (minutes) are now set to the correct hour according to the received time of the previous QTC. Tnx F5LIW.
- Radios : IC-7100 and IC-7200 added. Tnx N6TV.
- Cabrillo output file (v3) : eMail address tag added.
- Cabrillo output file (v3) : New option to indicate if you wish to receive, if eligible, a paper certificate sent via postal mail by the contest sponsor. The contest sponsor may or may not honor this tag, and if so may or may not use opt-in or opt-out as the default.
- Cabrillo output file : New option to output the "alternate" frequency for split QSO. May be useful if the available CAT data for your radio can't be used to determine accurately the TX freq vs the RX freq.
- Several specific installers lacked the installation of the msflxgrd.ocx library. Tnx F5UPO.
- CW : SOUND/NOSOUND and associated menu items : This option is now always disabled when Win-Test runs under an operating system after Vista included. It means that it will not work for those OS, and \*may\* work on previous OS, depending on the hardware. In all cases, it is very recommended to rely on the TRX internal sidetone instead.
- WAEDC : The SAVELOG, COPYLOG commands and the automatic backups now include the QTC files. Tnx GW3SQX @ GW7O.
- ARRL DX, ARRL 10m and ARRL 160m contests : The Cabrillo output files are now compliant with the v3 specs. Tnx F5PHW.
- Edit menu : New item : Apply exchange to every QSO with...(Ctrl-F10) When applicable, it allows to update exchanges of every Q whose the callsign is identical to the callsign of the current Q, with the exchange(s) of this Q.
- Gab Wnd (Alt-I) : New contextual menu item to clear the content of the window.
- Cabrillo file : Win-Test now ensures the operators list is correctly space-delimited.
- The protocol version is now displayed in the Advanced Settings dlg of the network.
- Status Wnd (Alt-J) : When using a multi-op network, you can now send a remote command to a specific station by opening the context menu on this station name and use "Send remote command to XXX...".
- COPYLOG command : Notification added. Tnx TM0HQ.
- Ctrl + PageUp / PageDown now browses the log by 12h steps instead of 24h initially. This makes it usable for 24h long contests.
- Status Wnd (Alt-J) : When using a multi-op network, you can now ping a specific station by opening the context menu on this station name and use "Ping XXX". The Win-Test version, the Master, Bridgehead, Sync indicators and the propagation time are returned in the Gab window (Alt-I).  
Reminder : You can use the INV (stands for Inventory) text command to get a summary of the complete network.

- Enhanced replies to the inventory command (INV) with a log sync enabled indicator (S vs s).
- IARU HF : Mult wnd (F10) : AC, R1, R2 and R3 labels updated.
- Contest settings dialog : To prevent any side effect (especially with the network), the syntax of the station name is checked, and 'exotic' characters are replaced by an underscore if needed. Tnx F1UVN @ TM0HQ.
- Alt-F dlg : The read-only station name field is now disabled.

## Release information (4.17.0) (June 30, 2015)

### Bugfixes

- The ODX per band were sometimes wrong after band modifications of specific QSO. Tnx F1PKY @ F5KMB.
- IARU 50 MHz (and higher) contests : The Psect field of the output files are now in accordance to the REG1TEST specs. Tnx F2DX, OK2ZI.
- MP3 configuration dialog : Under some circumstances, an error loop could occur. Tnx DL6RAI. (Task #363)
- FT2000 : Under some circumstances, read frequencies were not consistent. Tnx F8DBF, F4DXW.
- For some contests, a QSO entered with your own callsign didn't count 0 points. Tnx N6TV. (Task #362)
- MP3 QSO extract : There was a few seconds offset in the recording.
- SP DX contest : When provinces were displayed with the "all bands" option \*and\* alphabetically, the "Z" province was missing. Tnx DL6RAI. (Task #360).

### New Features

- CAUTION: New network protocol version 1.28 released. Reminder: If you use WT in a networked environment, you must have the same WT version on all machines!
- Status Wnd (Alt-J) : New column for the current op. added. Cf OPON/OPOFF or LOGIN/LOGOUT commands or use nicknames. Tnx ES5TV.
- Set QSO freq dlg (Alt-F): Swap main / QSX freq button added.
- Rate Wnd (Alt-R) : When entering in a category where modes can be mixed, the elapsed time between band changes now takes account of modes as well.
- CQ-M contest : To be compliant with the new rules 2015, there is no more multiplier station, even in M/S. Tnx RU3DNN.
- ARI contest : A station can now be set as a MULT station. The 10 min timer in the Alt-J wnd considers band and mode changes. Tnx ES5TV.
- OK OM DX : Win-Test is now adapted to comply to the new SSB rules. To make things easier, the CW leg is kept unchanged ! Read carefully the rules before entering. Tnx ON5GQ.
- Contest recorder : QSO extraction to a mp3 file : The QSO extraction parameters are now (1) the time before the QSO was `_STARTED_` (0 sec by default - it means the clip starts at the same time when you listen to the QSO with AltGr-Enter) and (2) the time after the QSO was `_ENTERED_` (10 sec by default). Tnx ES5TV.
- ARRL DX and ARRL 10 : When exporting logs in ADIF, the DC "state" is replaced by MD. Tnx F8ATS.
- Lua : `wtScript:AssignArgument` now takes the strings "true" and "false" as boolean arguments. Numeric values do not require double quotes. Tnx N6TV.
- Script manager : Properties dlg : Now accepts a default argument even if no key is defined for the script. But, in any case, a key or a text command must be defined to allow a default argument. Tnx N6TV.

## Release information (4.16.0) (Mar 17, 2015)

### Bugfixes

- REF HF : FS now does count for a French dept instead of a DXCC entity. The final scores were not affected by this bug. Tnx F4EJL.
- If the default directory at launch time wasn't the app directory, the automatic starts of wtDxTelnet and wtRotators were failing. Tnx F5LIW.
- Ctrl-Del (delete spot from bandmap) was broken. Tnx N6TV. (Task #354)
- Network advanced settings dialog : The last outbound protocol was always enabled, despite its setting. Tnx F1HAR.
- Common prefixes to GM and GM/s were considered as GM even if the WAE list was used. Tnx N6TV. (Task #355)

### New Features

- Spanish and German translations updated. Tnx EB2RA and DL6RAI.
- LUA : Because of a conflict name with the wtScript class, the wtScript variable (name of the Topmost script) is now replaced with wtRootScript. Tnx N6TV.
- RDXC : R7K - Crimea (RK) and R7R - Sevastopol (SE) added to the mults list. Use the latest CTY\_OBL.DAT accordingly. Tnx RU3DNN.
- Lua : wtContest:GetMyCallsign() and wtStatus:GetMyStation() added. Tnx N6TV.
- Registration dialog : The QR codes of the registration URL are enlarged.
- ICOM radios : IC-970, IC-9100 and IC-7850 added. Tnx OK8WW, EA8RM and K3LR.
- ARRL DX (DX side) : To strictly comply with the current rules (section 5.2.2), the PEI multiplier (VY2) is now labelled PE. The STATES.DAT is also accordingly updated on the usual repository <http://download.win-test.com/files/equivalence/> .
- NA Sprint : Because of the different multipliers per leg, the equivalence files must now be NA\_SSB\_SPRINT.DAT and NA\_CW\_RTTY\_SPRINT.DAT. They are available on the usual repository <http://download.win-test.com/files/equivalence/> . Tnx KD4D and N6TV.
- NA Sprint : DC and the usual 14 Canadian provinces and territories are now considered as multipliers for the Phone leg (the MAR mult. is no longer used). Tnx KW8N.
- UBA DX : Mult stations are now allowed for Multi-Op (Single TX) entries. Also, the 10-min timer for RUN stations is now displayed in the status window (Alt-J). Tnx RU3DNN.
- NA Sprint : KL stations are now considered as US stations and their state (AK) is now in the states list. KH6 stations are also considered as US stations for the Phone leg, and their state (HI) is now in the states list. During the CW / RTTY legs, KH6 stations are considered as DX stations (not NA). Tnx N6TV.
- ARRL 10m : Mixed mode category forced in the Cabrillo output for the M/S entries.
- Script properties : Tooltip added over the key edit field with the key code and modifiers values. It can help for the wtScript:AssignKeyCode function. Tnx N6TV.
- Scripts manager : Run button added. The selected script is run the same way as if it were run by the assigned key (if any), and with the argument set in the properties dialog (if any). Tnx N6TV.
- Lua : wtScript:AssignFKKey and wtScript:AssignKeyCode functions added. Tnx N6TV.
- Script Manager : Error message added when the SciTE or the script editor weren't correctly installed or configured. Tnx DL6RAI.
- New CW and RTTY variables introduced : \$GRAB1 to \$GRAB9 to grab from the partner stack slots, and \$GRABRT1 to GRABRT3 to grab from the partner realtime slots.



## Release information (4.15.0) (Nov 22, 2014)

### Bugfixes

- When a voice message contained several script calls in a row, only one out of two was executed. Tnx N6TV.
- ARRL SS : When a callsign is grabbed, the cursor is now set to the serial field. Tnx AC6T, N6TV. (Task #353)
- When not using advanced SO2R with Shift bound to the secondary radio, Shift-Enter now has no action. Tnx N6TV.
- Partner window: The SUPPORT / NOSUPPORT (or PARTNER / NOPARTNER) commands didn't resize the window properly.
- Partner window context menu: The "Remove" item was enabled for empty slots while it was supposed to be grayed.
- Partner stack: If the same callsign was in two adjacent slots in the Partner stack, only one of them was cleared when the callsign was entered in the log.

### New Features

- CAUTION: New network protocol version 1.27 released. Reminder: If you use WT in a networked environment, you must have the same WT version on all machines!
- Contest recorder : AltGr+E shortcut added as "Extract and Save QSO". Tnx N6TV.
- LZ-DX contest : 10 min. CQWW DX rule applied to the M/S entrants, but currently limited to the band changes (the mode changes are ignored). Tnx RU3DNN.
- Partner : There are now two different colors for data entered as Run or as Support. Useful when there are several partner positions for one run. Tnx F5HRY@TM0HQ.

## Release information (4.14.0) (Oct 19, 2014)

### Bugfixes

- When several mp3 record files from different stations for a given contest were used, the rewind and forward functions led to a crash. Tnx DL8AAU@DR9A.
- Radio wnd: When using a Windows font size option different from 100%, the VFO displays didn't scale up well. Tnx N6XI, N6TV.
- Lua: An error occurred when calling a script with the double-quote key. Tnx N6TV.
- RDAC: The Tools / Check log / Search for bad exchanges function was not working for the RDAC contest. Tnx SP5KP
- In the Alt-M wnd, when data were ordered by number of worked bands/modes, and never worked mults were hidden, the sweep clean mults were always displayed, despite this option was set or not. Tnx CT1BOH.

### New Features

- CAUTION: New network protocol version 1.26 released. Reminder: If you use WT in a networked environment, you must have the same WT version on all machines!
- New notes file format and network protocol to ease log corrections within Win-Test. Check the new last items of the Tools / Check log menu.

- Partner: New properties dialog to set the various options. By default, the realtime keystrokes network transmission is disabled when switched to the S&P mode. It can be enabled by choice in this properties dialog. Tnx TM0HQ & N6TV.
- IARU HF: A '?' indicator is now displayed when the received exchange is not an ITU zone, AC, R1, R2 or R3, or not composed of letters only.
- New option in Tools / Check log / Search for bad exchanges, to detect exchanges discrepancies in the log only.
- Merge report redesigned: All conflicts are ordered by time and also by station name.
- The Date/Time dialog (Alt-F) now indicates the station who entered the QSO. Not editable. Tnx F8CRH@TM0HQ.
- New Goto Callsign edit menu (Shortcut Shift+Ctrl+G) to set the cursor on a QSO with a given callsign. By default, the callsign of the current QSO is searched. If it is empty (i.e. if the cursor is set to the last (empty) line of the log), a dialog is opened. The search is done backwards.
- New CW option to enable/disable the speed bursts (+/-) without modifying the messages. Text commands are BURSTS / NOBURSTS. Useful to defeat CW skimmers on-demand.
- Interfaces setup dialog: The lists for each COM port are now reordered to comply with the most current needs.

## Release information (4.13.0) (Jun 30, 2014)

### Bugfixes

- REF DDFM 50 MHz contest : Default CW msgs were using \$GRIDSQUARE (6-char locator) instead of \$GRIDFIELD (4-char locator). Tnx F2DX.
- Gab window (Alt-I) : If the content was scrolled back, a double-click on a line set an incorrect default recipient in the opened Gab/Talk dialog. Tnx F8CRH@F6KRK.
- REF VHF contest : Win-Test was asking for the "departement" in the contest settings dialog (was useless), and the help dialog was inappropriate. Tnx F5HRY.
- CQ-M contest : Contest identifier for the Cabrillo and ADIF output files were misspelled. Tnx RU3RQ. (Task #348).
- WPX : The prefix of VY2MGY/3 now resolved as VY3. Tnx N6TV. (Task #347).
- Bugfix : Lua : wtApp:CallScript(name, arg) was always casting arg to a string. Tnx N6TV.

### New Features

- EF6 added as a valid exception callsign. Tnx F6FDR.
- Radio windows - List view : In the "Sort by Mult Type" view, the non-mults stations are now sorted by QSO points in descending order. Tnx G3WW.
- Radio windows - List view : New sorting option by QSO points in descending order, irrelevant of mults, added. Tnx G3WW.
- WRTC 2014 and IARU HF : Check multiplier wnd (F10) : New label for HQs "entities" to prevent confusion with DXCC entities. Tnx CT1BOH.
- Log : The column header of the serial sent (if any) is now correctly labeled ("No."). Tnx N6TV.
- Options / Log / Align exchanges : New option to line up received exchanges in mixed mode. Tnx N6TV.
- WRTC 2014 : Worked Mults wnd (Alt-M). The "copy as text" menu item is now enabled. Tnx CT1BOH.
- WRTC 2014 : /MM stations are not counting for DXCC entity, and are credited depending on their ITU zone. Tnx KM3T.
- WRTC 2014 : The country list used is DXCC (not WAE). Tnx KM3T.

- WRTC 2014 : In the contest configuration dialog, the zone is set to 8, the Gridsquare is set to FN42fg and can't be modified.
- The very singular 7QNL (and future 7QAA) callsigns are now accepted. Their prefixes are also resolved as 7Q0. Tnx PA3FYM.
- Lookup function for the DXCC entities resolver refactored to allow easier extension for cases like the newly introduced 4Y1A and C7A, when callsigns are assigned to two entities.
- RTTY : Fields assignments updated for the NCCC Sprint. Tnx AA2MF.
- King Of Spain contest : SMR multiplier added. Tnx EA4TX.
- Marconi HF : New points rules applied. Tnx IK6BAK.
- Lua : In CW, when chaining wtKeyer:Play() instructions, the word space between the string arguments will be omitted if they end with a "~". Example :

```
wtKeyer:Play(string1)
wtKeyer:Play(string2)
```

Will omit the word space between string1 and string2 if string1 ends with a "~". Tnx N6TV.

## Release information (4.12.0) (February 10, 2014)

### Bugfixes

- UBA DX : The format of the output cabrillo file didn't stick to the required specs. Tnx ON5GQ.
- DARC 10 : Under some circumstances, the DOK field was cleared while it wasn't necessary. Tnx DJ4MZ.
- Lua : The wtApp:CallScript function was always returning a nil value when used with two parameters. Tnx N6TV.
- The log sync enables / disabled setting was not correctly saved between logs openings. Tnx DK9TN@ED6A.

### New Features

- DARC 10 : The NM exchange (Non Member) is no more considered as a multiplier. Tnx DJ4MZ.
- Radios : IC-7410 added. Tnx DL6RAI.
- Script Manager : Various UI enhancements and API bugfixes. Tnx N6TV.
- Clear Log : The station type (RUN, MULT, etc.) setting is now preserved when this function is performed. Tnx DK9TN@TK4W.
- Network : Time distribution : A warning now pops up when time sync frames are received, and the Windows user who started Win-Test hasn't enough privilege to modify the system clock. Tnx P40L, N6TV.
- Lua : wtQso:GetData() returned table updated for the specific ARRL Sweepstakes contest. The QSO# received is in the "rstReceived" index, and the Precedence letter is in the "miscInfo2Received" index. Tnx N6TV. (Task #338).
- Mult Window (Alt-M) : New "Hide never worked" option added. Pretty experimental for now, depending on the contest. Tnx CT1BOH.
- Radio windows : The spot selected by a right click is now highlighted to prevent confusion. The highlight color calculation now also works for dark hues. Tnx AD1C@K0RF.
- Stats window : In CQWW DX, the zones / overall display was clipped to the last hour when a new zone was worked.
- Radio windows : Time / Spotter and Comments display options added in the list view. These settings are common to both views. Tnx CT1BOH.

## Release information (4.11.0) (October 20, 2013)

### Bugfixes

- CQWW RTTY : The check log tool for the number of allowed QSY per hour in M/S was broken. Tnx DL9YAJ @ DR5N.
- Frequency offsets weren't always correctly processed, especially on the secondary radio. Tnx DL5AOJ.
- Extra Data files : Depending on the newline character(s) and other various parameters, the displayed data could be incorrect. Tnx IK0HBN, N6TV.
- When a log was entirely entered manually, the date of QSO wasn't correctly set when using the "<" or ">" keys to access and fill the time field. Tnx F5LEN.
- Under some circumstances of startup order and various settings, a "20 days older or newer log" false alert might be triggered. Tnx F6BGC @ TM0HQ.
- RDAC Contest : Exchanges for callsigns ending with /x (x = 0 to 9) are now searched in the database and the log. Tnx SP5KP.
- AGCW HNY : The (optional) AGCW membership number entry field was emptied when it was not supposed to be ! Tnx DJ0ZY.
- Displayed ODX inconstancy under some circumstances when a QSO was deleted. Tnx DL6RAI.
- RAEM : The coordinates entry field was emptied when it was not supposed to be ! Tnx DJ0ZY.
- When using the GOTO function by entering a QSO number and Ctrl-G, the pattern analyser warning message (if any) is now cleared.
- The modifications entered into the Freq Offsets dialog are now taken into account immediately. No need to reload the current log. Tnx YL2GD.
- When using a K3, changing band by entering its wavelength was sometimes setting the wrong LSB/USB mode. Tnx M0VFC (Task #326)
- Under some circumstances, a random character could be entered in the Info field in a DXPed log, when using the Up/Down arrows in this field.

### New Features

- Networking : Sockets initializations updated to comply with the usage of Win-Test in a Linux / Wine environment. The wtCom.dll must be updated (v2.0.4 or better) as well for this usage if needed. Tnx AA6KJ.
- ADIF
  - ◆ output : Addition of the CREATED\_TIMESTAMP field in the header, and the CONTEST\_ID field in every QSO record, when applicable.
  - ◆ Export : The ADIF country code is now added to the QSO record. Requires using the latest CTY\_WT.DAT or CTY\_WT\_MOD.DAT country files (02 August 2013 or later). Tnx AD1C.
- CQWW DX Contest
  - ◆ The overlay "Classic" category has been added in the contest configuration dialog. It only adds the appropriate line in the Cabrillo output file.
  - ◆ The overlay category Xtreme is added in the contest configuration dialog, and in the Cabrillo file output as well. Tnx KL1A.
- WAE Contest
  - ◆ The special calculation for the creation of the offtime section in the Cabrillo file has been removed, being now obsolete. Tnx DL6RAI.
  - ◆ Offtime threshold is now set to one hour.
- Lua

- ◆ wtQso:GetData() function added. Returns a table with fields of the current Qso. The current available keys are "time", "band", "mode", "freq", "callsign", "rstSent", "serialSent", "rstReceived", "exchReceived", "miscInfoReceived", "miscInfo2Received".
- ◆ wtApp:GetLogFileName() and wtApp:GetIniFileName() functions added. Tnx N6TV.
- UFT contest : Win-Test is now adapted to the new rules 2013. Tnx F6CEL.
- YU DX contest : Totally rewritten because of the new rules 2013 (see <http://yudx.yu1srs.org.rs/2013/rules.html>). Tnx YU0W and F5IN.
- SPDX Contest : The "12 band or mode changes per one clock hour" rule is now implemented. A simultaneous change of band \*and\* mode (Ex: 80m CW -> 40m SSB) counts as 2 changes. Tnx SQ2GXO.
- New Tools / Data entry / Priority / Callsign option to ignore any freq or band changes when entering digits only in the callsign field. Tnx P40L, N6TV.
- RAC Winter and Canada Day Contests : The 10-minute rule for the multi-single entrants is now implemented. Tnx VE3JM and N6TV.
- Russian 160 meter : New rules implemented.  
<http://www.radio.ru/cq/contest/rule-results/index2012.shtml>. Tnx RZ3DX.
- QR Code added in the registration dialog to help mobile phones users.

## Release information (4.10.0) (October 23, 2012)

### Bugfixes

- YO DX Contest : The child and log windows are now compliant with the chosen mode category (CW, SSB or MIXED). Previously, the mixed mode only was assumed.
- NAQP : The K8 mark for "zones window" (Alt-Z) was labeled K81 instead. Tnx NX5M.
- Text and CSV files options dialogs : The Del key was acting as "Remove all" instead of "Remove".  
Reminder : Shift-Del acts now as "Remove all", Del acts as "Remove", Shift-Ins acts as "Add all" and Ins acts as "Add". Tnx TM0HQ.
- In the logfile fixing process, the backed up file had a wrong file extension (it was always .wtb). Tnx TM0HQ.
- Status wnd (Alt-J) : Not always correctly ordered when sorted by freq/name. Tnx TM0HQ.
- CQ VHF and CQ 160 : ARRL Section added in the Cabrillo output file for US/VE entrants (Task #323). Tnx W9ZRX & N6TV.
- FT1000(D) : The IF filter setting is retained per mode when grabbing a spot. Tnx DL6FBL @ DR1A.
- Under some concurrency circumstances in a multi-op environment, Win-Test could crash when deleting or modifying spots in the Alt-A or the radio wnds (Task #318). Tnx N6TV.

### New Features

- ARRL Sweepstakes, ARRL FD and ARRL 160 meter contests : ARRL/RAC sections list updated to comply with the four new RAC administrative sections (ONN, ONS, ONE, GTA), replacing the split Ontario Section. (Task #321)
- Auto CQ : New option in the appropriate dialog to halt the auto CQ with the Esc key only. Equivalent text commands are RPTESCONLY and NORPTESCONLY. Tnx N6TV.

- ARI Sezioni: Cabrillo output compliant with rules 2012. Tnx I2WIJ.
- ARI DX : Cabrillo output compliant with rules 2012. Tnx I2WIJ.
- IOTA : New rules 2012 implemented :
  - ◆ For multi-op (island) stations, display of Band/Mode changes in the rate window (Alt-R).
  - ◆ Cabrillo file : QSO lines now include RUN or MULT identifiers.
  - ◆ The score for World to World QSOs is reduced from 3 points to 2 points.
  - ◆ Island Stations now receive 5 points for World Station QSOs.
  - ◆ Island Stations now receive also 5 points when working their own Island.
- RDXC : Oblasts window (Alt-Z) updated following the new list 2012. Tnx HA1AG, SP5KP, F5IN.
- Check partial (F12) and NP1 (F8) wnds : The [UNIQUE] word has now its own background and text colors to draw the attention of the operator. Tnx CT1BOH.
- JIDX : Cabrillo file : QSO lines format updated to comply with the new format specifications for the multi-op category. (See task #317). Tnx N6TV.

## Release information (4.9.1) (October 27, 2011)

### Bugfixes

- Fix an issue with missing resources which might make WT to crash.

## Release information (4.9.0) (October 26, 2011)

### Bugfixes

- Problem in Spanish language file fixed. Tks N6TV.
- The exceptions callsigns of the CTY\*.DAT files were wrongly parsed when operated from another DXCC entity (ex. W6HGF/KH0). Tnx JE2UFF.
- During a Cabrillo import, if the format of the QSO line wasn't correct, the error message was off one on the QSO number. Tnx W6IZT.
- IARU HF contest : The mode entry was empty in the output Cabrillo file for multi-op categories. It is now set to mixed. Tnx F1HAR @ TM0HQ.
- The Kenwood radio protocol was broken when sending CAT commands with frequencies above the 3420 MHz band. Tnx W8ZN.
- Task #310 : IARU HF contest : For US/VE stations, the ARRL section is now required, instead of the state or the province. Tnx N6TV.
- Entering your own callsign in the bandmap (Ctrl-Enter) was displaying a "spotted by..." alert. Tnx F5JSD @ TM0HQ.

### New Features

- When a new file is created, the usage of a network drive is checked and strongly discouraged to prevent log inconstancy. Tnx VK8DX @ 4W6A
- WAEDC : Time shift can now be applied to the QTC. Tnx DL8RDL.
- NCCC Sprint : New rule 2011 : 15m QSO are now permitted. (See task #312). Tnx N6TV.

## Release information (4.8.0) (June 26, 2011)

### Bugfixes

- Task #308 : JIDX : 160m QSO points counted 1 pt instead of 4. Tnx N6KI and N6TV.
- Under some circumstances, DXped audio recordings were not correctly tagged, the file information dialog was incomplete, and the QSO playbacks failed. Tnx VE3EY @ TO3A.

### New Features

- ADIF : PROGRAMID and PROGRAMVERSION fields added in the file header. Tnx IZ8MBW.
- LPT Interface : 50 MHz, 144 MHz and 432 (440) MHz band data outputs added. Tnx W8ZN and N6TV.
- Callsign check rules : The pathetic 9HOHSJ callsign is now added as an exception (like RAEM, JY1 and TX9). Tnx OH2OT, F5HRY.
- PACC contest : New rule 2011 : QSO are now allowed in each mode for mixed categories. Tnx PA2A.
- RSGB 160m contest : Single-mode CW-only restriction removed to comply with the new rules 2011. QSO and bonuses are now allowed for each mode. Tnx G3XSV.
- NAQP : Cabrillo output : The DXCC prefix is now indicated instead of "DX" for North American stations outside of K/VE. Tnx WA7BNM.
- DARC XMas contest : New rules 2010 : "NM" is allowed as a exchange from the German stations, but is no more credited as a mult. Tnx DJ3WE.
- DX Spots window (Alt-A) : New option to enable/disable logging of the incoming spots in the .dxc file. It is enabled by default. Under some circumstances (slow antivirus inspection, slow HDD, etc.), saving every spot (especially when using the RBN) was making Win-Test less responsive. The op-entered spots are always saved to allow their restoration on log startup. Tnx HA1AG @ ED9M.
- Packet window (Alt-O) : New option to enable/disable logging of the packet stream in the .pkt file. It is enabled by default. Under some circumstances (slow antivirus inspection, slow HDD, etc.), saving the packet data stream (especially when using the RBN) was making Win-Test less responsive. Tnx HA1AG @ ED9M.

## Release information (4.7.0) (December 2, 2010)

### Bugfixes

- Task #300 : WAEDC RTTY : The sent QTC group number was not taken into account by the other connected machines, and therefore the QTC numbering was garbled in M/\* environment. Tnx

DL6RAI.

- Task #266 : WAEDC RTTY : No \*New Mult\* warning. Tnx DL6RAI.
- WAEDC : Number of QTC to send dialog : Even if some buttons were disabled, their associated "number keys" were still active.
- WAEDC : Sending QTC dialog (Ctrl-L) : In "show" context, and if messages were sent under some circumstances, Win-Test could crash. Tnx IW1QN.
- WAEDC : Under some circumstances, sent QTC were not always correctly saved.
- WAEDC : When the number of QTC to be sent is 0 (no more QTC available), all "number keys" and Enter are now ignored in the appropriate dialog.
- Task #298 : Spacebar key didn't always work properly in the ARRL Sweepstakes contest. Tnx N6TV.
- Task #297 : Double-click on Check Multipliers window (F10) didn't work in ARRL Sweepstakes. Tnx N6TV
- Under some circumstances, if data entered in the time field didn't follow the HH:MM or HHMM format, it could lead to a crash. Tnx N6TV.
- WinKey : Speed bursts were not executed if located just before the \$LOGGED variable. Tnx ES5TV.

## New Features

- CW Autosend : Feature temporarily disabled when Alt-Space (grab from the RT partner slot), Alt-1..9 (grab from the partner stack) and Ctrl-1..9 (exchange with the partner stack) are used. Tnx ES5TV, N6TV.
- ARRL 10m contest : New Mexican multipliers added. The name of the database (which is now different from the other ARRL contests) is now ARRL\_10M.DTB. Several XE stations (around 300) have been added in the current file: [http://download.win-test.com/databases/ARRL\\_10M.DTB](http://download.win-test.com/databases/ARRL_10M.DTB)
- MouseWheel actions are now compatible with HiRes optical mice like the Microsoft Wireless LASER Mouse 8000. Tnx W9ZRX, N6TV.
- Bandmap properties : The minimum spot bandwidth is now 0 Hz (!). Tnx SM2WMV.
- IC775 : Force narrow IF filters when grabbing callsigns in CW. Tnx YL2GD.

## Release information (4.6.1) (Released only for demo and DxPed versions)

### Bugfixes

- The default directory name for a "DX expedition (VHF and above)" log was wrong. Tnx DJ4MZ.



- When a callsign was entered by a dbl-click in the N+1 or the partials wnd, and if this feature was set to automatic, the callsign check status wasn't updated. Tnx ES5TV.

## New Features

- COPYLOGCLEAR text command added. Equivalent to the COPYLOG command immediately followed by a CLEARLOG command. Tnx CT1BOH.
- QTC receive dlg : New variable \$QTCROW introduced indicating the QTC line number where the cursor is located. Mainly used in RTTY for asking a resent of a specific line. The default F8 button message is now "AGN QTC \$QTCROW?" in this mode. Tnx DK4WA.

## Release information (4.6.0) (October 24, 2010)

### Bugfixes

- Task #296 : Check mult window (F10) was not updated properly when using in ESM mode with S&P mode selected. Tnx N6TV.
- Under some circumstances, the default filename of a contest log could contain invalid characters. Tnx G0ORH.
- Second zones window : The labels display option was not restored.
- When grabbing a callsign in the RTTY window, the realtime partner window field wasn't updated. Tnx ES5TV.
- Task #290 : On restart, Win-Test didn't remember the last SO2R scenario that was selected. Tnx N6TV.
- WAEDC : QTC receive dialog (Alt-L). Using the INSERT key in this dlg was crashing Win-Test.
- Task #291 : RadioWnd : Ctrl-Up/Down weren't working properly in list mode. Tnx ES5TV.
- Under some circonstances, Win-Test could crash when started with the CapsLock key engaged.
- Advanced SO2R CW messages dialog : The Esc and Enter keys now work.
- WAEDC : Clock wnd : QTC in stock was always displayed for M/S entrants regardless of their location (EU or DX).
- WAEDC : Clock wnd : QTC in stock value was not immediately updated after a Q was received thru the network.
- EZMaster, MK/MKII/... and OTRSP setup dialogs : The Esc and Enter keys were not correctly handled.
- Transmit QTC window (Ctrl-L) : Under some circonstances, the context-oriented background colors were not correctly updated.

## Win-Test Wiki

- WAEDC : After receiving QTC, the potential QTC counts in the bandmaps were not always updated. Tnx DF9LJ.
- WAEDC : Every time a Cabrillo file or a summary file was written, the QTC counts were increased. Tnx DF9LJ, DL6RAI, and several others.
- KCJ : TG (Tochigi) and NR (Nara) multipliers were missing in the Alt-Z window. Tnx F5IN.
- NAC 10 : Exchange sent are now 6-positions gridsquares. Tnx SM6FKF.
- Task #284. Your own call incorrectly counted one HQ if such an exchange was entered. Tnx TM0HQ, N6TV.
- DX cluster (Alt-A) and radio wnds : If the SP or the LP value of the spot was 0Â°, heading was not displayed. Tnx SM5AJV/SE5E.
- Task #282: Under some circumstances the QSO number displayed in the report for possible bad exchanges was wrong. Tnx DF1DX.

## New Features

- CAUTION: New network protocol version 1.25 released. Reminder: If you use WT in a networked environment, you must have the same WT version on all machines!
- The wtArg (and wtArgument) variables are now local to the called script.
- For phone contesting, scripts can be called from the Advanced SO2R scenarios with the #SCRIPT or #@SCRIPT notation.
- Lua scripting: New input API:
  - ◇ wtApp:InputUpperText(Prompt, Title, Default) If Title or Prompt is empty, a default text is used. Typed letters are automatically upper-cased while entering.
- Lua scripting: New wtGab API introduced:
  - ◇ wtGab:Send(strText[, strToStation]) sends a gab strText to strToStation. If strToStation is omitted, the text is sent to the whole network.
- NCCC Sprint : New rules implemented. Tnx K9MMS, N6TV.
- CQWW RTTY : In M/S category, the band changes counts are now displayed for the RUN and the MULT stations in the rate window (Alt-R). Tnx ES5TV.
- Edition keys : To improve the compatibility with CT, Ctrl-B, Ctrl-D and Ctrl-F keys are now processed in the log fields. Tnx N5KO, N6TV.
- WAEDC : QTC receive dialog (Alt-L) : New \$FIELD variable introduced. This variable takes the value "GROUP", "TIME", "CL" or "NR", depending on the kind of QTC field where the insertion point is located.

## Win-Test Wiki

- New CW and RTTY options to work dupes or not. If dupes are worked, the \$QSOB4 variable is ignored. The equivalent text commands are WORKDUPE/NOWORKDUPE or WORKDUPEON/WORKDUPEOFF. There is a different setting available per mode (CW or RTTY).
- Task #205 : The \$RxRy variables located in the end of a CW message, if any, are automatically appended to the content of the \$QSOB4 message if played. Tnx N6TV.
- The \$QSOB4 variable can now include scripts calls.
- The scripts calls in the CW or RTTY messages are now synchronous to the CW or the RTTY streams. To execute them asynchronously, they can be called with the #@ notation. Example :

```
-- script.wts
wtApp:AlertBox("Hello World!");
```

and the CW/RTTY message content is :

```
AAA #SCRIPT BBB
```

The keyer sends AAA, then "waits" until the user hits the OK button in the "Hello World!" alert box to send BBB.

If the CW/RTTY message content is:

```
AAA #@SCRIPT BBB
```

The keyer sends AAA and starts the script (and the alert box is open), \*but\* it continues to key the rest of the message ("BBB") without waiting the user intervention. This is the asynchronous mode.

- Lua scripting : One new wtKeyer API introduced :
  - ◇ wtKeyer:Insert(strMessage) : Works for the CW and RTTY keyers. When used in a synchronous script, it gives the possibility to "fill-in" data into the CW/RTTY message. It is recommended to use it only in the synchronous mode (see above) to ensure data are inserted in the right place. WARNING : strMessage can only contain textual data (no variable or script call). It is \*not\* interpreted by the CW/RTTY parser (except the +/- speed bursts).
- Lua scripting : New wtStatus API introduced :
  - ◇ wtStatus:GetList() returns a table with names of the stations in the network.
  - ◇ wtStatus:GetStatus(strStation) returns a table with fields of the status of a given station. Returns nil if this station doesn't exist. The table keys are "band" "mode" "currentRadio" "radio1Freq" "radio2Freq" "radio1IsManual" "radio2IsManual" "passFreq" "type" and "qsyStatusId".
  - ◇ wtStatus:GetFreq(strBand[, strMode]) returns the "best" pass freq for a given band and mode. To determine this frequency, it uses the same algorithm as the \$FREQnn variable.
- Lua scripting : New wtOtrsp API introduced :
  - ◇ wtOtrsp:GetDeviceName() returns the name of the OTRSP attached device.
  - ◇ wtOtrsp:GetFirmwareVersion() returns the firmware version of the OTRSP attached device.

## Win-Test Wiki

NOTE : Some devices do not support this API, and return an empty string.

◇ wtOtrsp:Send(strCommand) sends a command string to the OTRSP attached device. The trailing <CR> character is optional, and is appended if needed.

- Scripts manager dialog usability improved. Tnx N6TV.
- OTRSP : If the OTRSP device has controls and if they can generate events, dedicated Lua scripts are called when events occur :
  - ◇ otrspCrOn.wts and otrspCrOff.wts (not case-sensitive) are called when such a control has values 1 and 0 respectively. wtArg is set to the control number (0 to 9).
  - ◇ otrspCrEvent.wts (not case-sensitive) is called for all states of the events. wtArg is set to (256 \* cr) + state (cr = control number - 1 to 9, and state = value of the state when the event occurred - 0 to 255).

WARNING : If the PTT events are used, the control 0 is restricted to this usage, and doesn't fire the otrspCrOn/Off/Event.wts scripts. If the PTT events are not used, otrspCrEvent is not called when an event on this control occurred. Only the otrspCrOn/Off scripts are executed.

- microHAM devices : When an attached footswitch is used, two dedicated Lua scripts named microhamFsOn.wts and microhamFsOff.wts (not case-sensitive) are called. wtArg is set the radio number of the footswitch (0 for MK/MKII - 0 or 1 for MK2R/MK2R+/u2R depending

on the footswitch that generated the event).

- Elecraft K3 : To circumvent erratic loss of control when used with various other devices, CAT stacked commands are now sent in a delayed sequence. Tnx N6TV, N6XI, and others.
- Lua Scripting : New wtMicroham API introduced :
  - ◇ wtMicroham:GetDeviceId() returns the ID of the microHAM attached device. Check the Lua constants for interpretation.
  - ◇ wtMicroham:GetFirmwareVersion() returns the firmware version string of the microHAM attached device.
  - ◇ wtMicroham:Send(strCommand) sends a command string to the microHAM attached device . The trailing <CR> character is optional, and is appended if needed.

Tnx ES5TV, N6TV, OM7ZZ.

- Contest settings dialog: The contest combo box is now divided in sections.
- Status Wnd (Alt-J) : Code rewritten to adapt the window columns to the contest in progress : The band is displayed if the current contest is multi-band. The mode is displayed if the current contest is multi-mode, and the type (R, M, etc.) is only displayed for Multi-Op HF contests. Also, when the CQWW M/S multiplier rule is used, new indicators are displayed in the QSY column.
- Status Wnd (Alt-J) : Rewording of "QSY Freq" to "Pass Freq". Menu items adapted too.
- Status Wnd (Alt-J) : When operating in SO1R/Multi-Op technique, the Radio 2 freq is automatically hidden, and the Radio 1 freq is now using the same color as the other items of the line.

## Win-Test Wiki

- RDA Contest : All DXCC entities are taken into account for multipliers, even the Russian ones. Tnx UA2FF and RX3RC.
- COPYLOG text command added : Duplicate the current log file (.wt4) in the current log directory with a timestamp added in its name. Useful to quickly save the current log right after a contest warm-up, just before clearing it (CLEARLOG) and start the contest. Tnx DL6RAI for inspiration.
- MP3 Contest Player : You can now select which channel(s) - Left, Right or Stereo - to listen to. When Left or Right is selected, this channel is sent to both outputs for a more pleasant listening. Useful to listen to true SO2R stereo recordings. The shortcuts (AltGr+C for Left / AltGr+V for Stereo / AltGr+B for Right) have been chosen for their location on the keyboard.
- WAEDC : Received QTC window (Alt-L) : The contest recorder keys are now active also in this window.
- RDA contest : ADIF export : The first two chars of received district (if applicable) are saved as STATE field and the district (reformatted as XX-dd) is saved as CNTY. Tnx UA2FF.
- RDA contest : For Russian entrants, a QSO with a /P Russian station (assumed to be a C1 or C2 stations) is now credited with 10 pts. Note that using /P for C1 or C2 stations is *\*not\** mandatory (Check the note 5.2 of the English rules). Tnx UA6AA.
- WAEDC : Received QTC window (Alt-L) : The ESC key only works if no field have been edited (and closes the dialog). If a field has been edited, the ESC has no action (except interrupting CW etc.). Tnx F5VIH/SV3SJ.
- WAEDC : Transmit and Receive QTC windows (Ctrl-L and Alt-L): Modified wordings for some buttons, and easier usability for users, especially when using Esc and Ctrl-L/Alt-L to close these windows. Tnx DL6RAI, DF9LF, G3TXF.
- WAEDC : Transmit QTC window (Ctrl-L) : In CW or RTTY, if no QTC is sent, the Ctrl-L and Esc keys close the dialog with no confirmation asked. Tnx DL6RAI.
- WAEDC : Receive QTC window (Alt-L) : If no field is edited, the Alt-L and Esc keys close the dialog with no confirmation asked. Tnx DL6RAI.
- WAEDC : Receive QTC window (Alt-L) : To improve consistency with the log edition keys, a new key set is introduced :

```
Alt-Arrows : Moving from one field to another (replace Ctrl-Arrows)
Shift-Backspace: Delete all the characters left of the cursor
Shift-Del: Delete all characters under and right of the cursor
Ctrl-A: Like [Home]
Ctrl-E: Like [End]
Ctrl-W: Clear the current field
Ctrl-K: Like [Shift-Del]
Ctrl-Z: Undo field edition
Ctrl-Left arrow: Like [Home]
Ctrl-Right arrow: Like [End]
```

Tnx F5VIH/SV3SJ

## Win-Test Wiki

- WAEDC : If the "Show additional information on QTC traffic" option is enabled, the callsign syntax check status messages are no more displayed, to free the message line for the QTC status. Only applies to the WAEDC. Tnx DJ0ZY.
- LUA scripting : Two new global variables wtScript and wtCurrentScript introduced. wtScript contains the name of the top-most called script, with no extension, and wtCurrentScript contains the script name currently executed (no extension). For example :

```
-- foo.wts
wtApp:AlertBox(wtScript .. " / " .. wtCurrentScript);
wtApp:CallScript("bar");
return -1;
--

-- bar.wts
wtApp:AlertBox(wtScript .. " / " .. wtCurrentScript);
--
```

When foo is executed, the first alert box will display "foo / foo" and the next one will display "foo / bar". Tnx N6TV.

- Check country wnd (F10) : New option to display (or not) the sun charts. Tnx N6TV.
- ESM embedded script : When using the SO2R advanced technique, the scenarios messages are used instead of the standard ones. Tnx SM2WMV, N6TV and F6IFY.
- Remote commands dialog : Various different options for the notification are now allowed.
- Script manager : Added the possibility to attach a text command to a script. You can even pass a argument with the SCRIPT/ARGUMENT syntax (ex : SCRIPT/5 will call script.wts and the wtArg value is set to the string "5" - Caution : The argument is *\*always\** passed as a string when the script is called from a text command). If no argument is specified, the default argument defined in the script manager will be used (if any). Tnx N6TV.
- IARU HF : Mult wnd (Alt-M) can now be copied as text (and pasted as text or directly in a spreadsheet program). Does not apply for the WRTC version that has a different multiplier rule.
- IOTA : Even if IOTA.DAT is not installed, IOTA references that are syntactically valid are now taken into account for points credits and are written in the Cabrillo file. Tnx SM3CER.
- IOTA : Mult wnd (Alt-M) can now be copied as text (and pasted as text or directly in a spreadsheet program). Tnx G3TXF.
- The check logs tools reports are now adapted to the mixed contests.
- Enhanced replies to the inventory command (INV) with bridgehead and time masters indicators (B vs b and T vs t).
- BRIDGEHEAD/NOBRIDGEHEAD text commands added.
- IARU HF : "BA" added to the exception list of the cut numbers translation, despite this abbreviation is not listed as the official one of the E7HQ Society. Cf <http://www.iaru.org/iaru-soc.html> Tnx

UA6AA and many others.

## Release information (4.5.2) (July 3, 2010)

### Bugfixes

- Bugfix : Fixed a problem with registration in some versions.

## Release information (4.5.1) (June 27, 2010)

### Bugfixes

- Bugfix : MP3 information files dialog could lead to a crash if no mp3 file were present in the current log directory.
- Bugfix : ARI Sezioni - RTTY : Only valid 4 digits codes can be now grabbed from the RTTY wnd as an exchange. Tnx IKOCHU.

## Release information (4.5.0) (June 5, 2010)

### New Features

CAUTION: New network protocol version 1.24 released

Reminder: If you use WT in a networked environment, you must have the same WT version on all machines!

These network modifications only affect the use of Win-Test in a WAN environment, and requires wtTunnel 1.12 (to be released) to be effective.

- Workaround: YCCC SO2R Box outputs were not working as expected. At this time, AUX1 and AUX3 are assigned to Radio1, and AUX2 and AUX4 to Radio2. This will be customizable in the future.
- Added a Extraction Feature in Contest Recorder (right-click in the Contest Recorder Window, and chose the "Extract and Save QSO" menu).
- Text commands : MP3SETUP and SCRIPTS commands added. Tnx N6TV.
- Scripts manager dlg : The delete key now acts like clicking on the Delete button.
- New microHam device "USB micro2R" supported. Tks OM7ZZ.
- Radio Wnd and DX Cluster Wnd (Alt-A) : New leading indicator (#) introduced to tag spots coming from a CW Skimmer (aka the spotter callsign ends with "-#").
- CW cut numbers translation : New option in Tools / Data entry to disable the automatic translation. Note that this translation is performed on a contest and worked station contextual basis. The equivalent text commands are CUTTON and CUTOFF. Do not use CUT/NO CUT that are reserved for

CW cut numbers generation ! Tnx N6TV.

- EXPERIMENTAL : New "Always On Top" option in the Options / Windows menu. Can also be (re)set with text commands. Tnx N6TV.

## Bugfixes

- Bugfix : IC-7600 : Split was broken. Tnx N3MX, I2WIJ.
- Bugfix : In M/\* configuration, and under certain circumstances, the mp3 files list associated with a station in the MP3 file information dialog could be wrong.
- ARRL DX : CW cut numbers are translated for DXCC stations worked from the US/VE side.
- MP3 setup : Only the CBR codecs are now displayed in the setup dialogs. The usage of the ABR codecs (most of the LAME ACM ones) is too erratic to be trusted in. Tnx N6TV.
- Bugfix : REF HF : Cut numbers were translated for TK stations (2A). Tnx F5CQ.
- Bugfix : Additional CW messages (Alt-C) : When no log is opened, the function keys are now disabled.
- Bugfix : Recorder wnd : Under certain circumstances, the buttons tooltips were not always displayed.
- Bugfix : HA DX contest : When working contest from the HA side, cut numbers were always translated, whereas it had to be so for non-HA callsigns only. Tnx HA3LN.
- Contest Recorder: the "rotate file" option were disabling the AutoStart one. Fixed. Thanks IK2JUB.

## Release information (4.4.0) (January 17, 2010)

### Bugfixes

- Bugfix (#255): K1EL WinKey USB CW timing becomes very poor (Farnsworth style) when PTT delay is default 50 ms. This was caused by too low hardcoded value (80ms) of the PTT Tail delay. This delay is now configurable in the Winkey Properties Dialog Box. Tks F5JSD, SM5AJV, KL7RA and N6TV.
- Bugfix (#253): Input Wave Device was not properly selected in the Contest Recorder Module. Tks N6TV, NR5M.
- MP3 files information dialog : Under certain circumstances, the displayed stop time and duration of the selected file were wrong. Tnx N6TV.
- Bugfix (#271) : Packet window (Alt-T) was losing focus when the gab window was automatically closed. Tnx DL6RAI.
- Bugfix (#272) : Under certain circumstances, pattern checking flags were not updated if an entered callsign was modified. Tnx DL6RAI.



## Win-Test Wiki

- DARC 10 : Leading zeros addition for serial received was broken. Tnx DK1AX.
- Bugfix : MP3 files recorded in 2009 couldn't be listened to anymore in Win-Test in 2010 ;-) ! Tnx DL6RAI.
- Bugfix : Stew Perry : Under certain circumstances, an overflow error could happen in distance calculations for Q inside the same GridSquare as the entrant. Tnx VE3TA.
- Bugfix (Task #270) : ARRL 10 : When running the contest from the DX side, the serial sent was not editable. Tnx CX6VM.
- Bugfix : RTTY wnds : Left-click to activate (and right-click to open the contextual menu) in the text area were broken. Also, the possibility to Ctrl-Drag these windows has been added.
- Bugfix : ARI 40/80 contest in RTTY : The provinces can now be grabbed in the RTTY wnd. Also fixed for the ARI International Contest. Tnx IK0CHU.
- Bugfix : The Inventory and Score broadcast network frames could have bad data. Tnx SV3SJ/F5VIH.
- Bugfix : After opening a non-empty log, the first PgUp press was not updating the child windows.

## New Features

- Added some new features of the WK2 (WKUSB) for the PTT Tail. Tks F5JSD, K1EL.
- OmniRig supported as an alternative to the WT build-in Radio Control. Right-click on the Radio Window then choose "OmniRig Settings" in order to properly configure OmniRig for your Radio.
- IC-703 rig added.
- First attempt in OTRSP (Open Two Radio Switching Protocol) protocol support. Tested with the YCCC SO2R Box but not in real conditions. Tks K1XM.
- Log output : Progress bar implemented. Tnx TF3CW.
- Edit / Move in my log menu item has now text commands equivalents: MOVEINMYLOG (or SCROLLMYLOG) and NOMOVEINMYLOG (or NOSROLLMYLOG). Tnx 5B4WN.
- Rate wnd (Alt-R) : Two methods are now available to display the elapsed time since the last band changes. Tnx F1NGP and TK5EP.
- MRU (Most Recently Used) file list added in the File menu.
- IC-7600 rig added.
- ICOM rigs : Radio list rearranged alphabetically in the Interface Setup dialog.
- Bugfix : RTTY wnds : The invert function was also inverting the character next to the selection.
- RTTY wnds : Mirror zone enlarged to allow 4-figures serials.

## Win-Test Wiki

- RTTY wnds : Callsigns found in the database or in the log are now displayed in bold.
- RTTY wnds : Colors management added.
- Grid Squares wnd : It can now be enlarged to the entire world. Tnx F8BBL.
- Grid Squares wnd : New options in the contextual menu to display fields only, and to center the map on a specific point more easily (it requires the map is NOT centered on the Home QTH in the properties dialog).
- Grid Squares wnd : The resolution (low or high) chosen in the properties dialog wasn't properly saved.
- CQWW WPX Contests (Task #269) : Various updates to comply with the new rules introduced in 2010. Tnx K5ZD, W0YK.
- ARRL Contests : Default Off-time period set to 30 mins. Tnx CX6VM and DL6RAI.
- New "-n" or "--noautoload" switch allowed in the command line to disable the autoload log feature. Tnx N6TV (The only Win-Test user who runs it from the command line ;-)).
- Startup time reduced.
- CSV and Text exports : HF logs can now export distance and heading. CAUTION : To ensure consistency with the VHF logs exports (and many geographical processing softwares or online apps), the longitude is now positive for East, and negative for West.
- Tools / Check log / Callsigns syntax check added. Uses the pattern callsigns rules file (callsign.pat).
- LUA : wtArg can now be used to get the optional argument set in the Script Manager or in a #SCRIPT(argument) call. To ensure compatibility, wtArgument remains usable.
- Bugfix : Under some circumstances, some key assignments to scripts were not working properly. Tnx DJ0ZY.
- Script key assignment dialog : If no key is assigned, the argument field is now automatically cleared and disabled.
- Lua : New API to get the type and the manufacturer of the radios: wtRadio\*:GetTypeId() and wtRadio\*:GetManufacturerId(). Reminder : wtRadio\* applies to wtRadio, wtRadioInactive, wtRadioPrimary, wtRadioSecondary, wtRadio1 or wtRadio2. New Lua WT constants are introduced for this purpose. A new directory on our download repository has been created to gather the API and the constants lists : <http://download.win-test.com/v4/lua/>
- REF 160 : As non-domestic stations can send non-numeric exchanges the CW cut numbers translation is now disabled. Tnx F5IN.

## Release information (4.3.0) (November 23, 2009)

## Bugfixes

- Bugfix: playing back MP3s recorded on different stations was broken. Tks FY5KE.
- Contest Recorder (#253): USB Voice Codec was not detected due to a trailing space in the Codec Name. Fixed. Tks N6TV.
- Bugfix (#182): Wrong QSX Frequency in Self-generated Spots. Tks K1GQ.
- Bugfix (#262): CQ Repeat doesn't stop for Secondary Radio. Tks DJ0ZY.
- Bugfix (#259): Pressing Alt-1 in Secondary Radio window moves QSO to wrong band. Alt-1/2/3/... are now active only with the Primary radio and when the Partner Wnd is open. Tks N6TV.
- Bugfix (#251): NA Sprint - LOCATION record not written to Cabrillo file header. Done also for IARU HF, NAQP and NCCC Sprints. Tks N6TV.
- Bugfix (#243): WPX contest now requires LOCATION in Cabrillo. Done also for CQWW even if it doesn't seem required yet. Tks N6TV.
- Bugfix : Ukrainian DX contest and RDXC : Cut numbers were translated even for Oblasts. Tnx F5IN and RK1AA.
- UFT HF : Under some circonstances, the received report was not correctly translated with cut numbers. Tnx F5IN.
- CQWW M/S : The 10-minute mult timer in the status window (Alt-J) was broken. Tnx FY5KE.

## New Features

- Italian translation added. Tks IV3IYH!
- Search for Possible Bad Exchanges against bad formatted serial number implemented. Tks N6TV.
- Added some basic checks for ARRL SS in the "Search for Possible Bad Exchanges" tool. Tks N6TV.
- The '<' and '>' keys are now interpreted by the Secondary Radio Window as well, as far as the SHIFT key is not used for binding to the Secondary Radio Window (task #216). Tks N6TV.
- WAE : When using the keyboard mode in the QTC transmitting and receiving dialogs, the Enter key was mis-interpreted. And now, in CW, the "what you type" field is also updated. Tnx DL6RAI and DJ4MZ.
- Lua : New API to play the additional CW/RTTY messages (Alt-C set)

```
wtKeyer:PlayAdditionalMsg(AdditionalMsgIndex)
```

AdditionalMsgIndex is the index of the Alt-C messages set (1 to 12). Others are ignored. This API is useful when these messages contains variables. If not, you can still use wtKeyer:Play("\$MSGx").

## Win-Test Wiki

- Lua: New API introduced to get various interesting directories paths:

wtApp:GetLogPath()	Current log directory path
wtApp:GetAppPath()	Win-Test installation directory path
wtApp:GetCfgPath()	\cfg directory path
wtApp:GetCtyPath()	\countryFiles directory path
wtApp:GetDatabasePath()	\databases directory path
wtApp:GetOpPath()	\ops directory path
wtApp:GetScriptPath()	\scripts directory path
wtApp:GetExtraPath()	\extras directory path

- WAE : Transmit and Receive QTC windows : Scripts are now allowed in the predefined CW/RTTY messages (use the #SCRIPT notation as usual). Tnx DL6RAI.
- Ukrainian DX contest : Rules 2009 now accept single mode entries for DX : Cabrillo file output updated. Tnx F5IN.

## Release information (4.2.0) (October 21, 2009)

### Bugfixes

- Bugfix: Conversion of binary file containing QTC from v3 to v4. Tks DJ4MZ.
- Better support of Win7 and Wine/Linux.
- Bugfix (#258): Failure of swap radio key to switch rx focus for the MK2R+ as long as one not manually changed the rx focus to stereo or transmitted anything in CW. Tks GW3NJW, OH1JT, OM7ZZ, W4TV.
- Cosmetic: avoid rx focus leds flickering when switching tx focus. Tks OM7ZZ.
- Bugfix (#187): Ctrl-Shift-Tab doesn't appear to toggle RUN / S&P in Secondary radio window. Tks N6TV, GW3NJW.
- Bugfix : K3 serial port default setup modified : The number of stop bits was wrong - It is now set to one stop bit, according to the K3 users manual. Tnx N6TV.
- ON Winter and Spring contests : Sections list updated. Tnx F5IN and ON5GQ.
- Bugfix (#257) : CQWW DX RTTY : Cabrillo template modified to match the specs. Tnx N6TV.
- Bugfix : CQWW DX RTTY : Allowed band changes modified to 8 in MS and M2 categories (rules 2009). Tnx F5JY.
- Bugfix (#164): TI5/NP3D is now parsed as TI. Tnx JE2UFF/W2UFF.
- CTY files : 4U30VIC now considered as 4U1V in an appropriate way. Tnx DL6LAU.
- Bugfix : After reloading a WAE log, the QTC count in the Summary window was wrong. Tnx DK1AX.

## New Features

- Scripting: wtQso:GetModeId() and wtKeyer:GrabHighlightedCallsign() function added. Note that wtKeyer:GrabHighlightedCallsign() works only in RTTY, and relies on the INSERT key option set in the RTTY setup dialog.
- New option in the Clock wnd to "wizz" this window a la MSN at rounded hours, to draw attention of the op (useful in multi-op configurations).
- New feature in Tools / Scripts manager... : Allows to edit, create, delete or rename scripts. It's also used to assign a key and/or an argument to a script (its value will be available in the wtArgument global variable).
- Scripts called by an assigned key can return +1 to be called again *after* the WT key processing occurred. A new API wtApp:IsPostKeyProcess() is introduced to distinguish the "pre"- process from the "post"-process.

Example:

RunSPSwitch.wts (assigned to Ctrl-Tab) :

```
if (wtApp:IsPostKeyProcess()) then
  if (wtQso:IsOperatingModeRun()) then
    wtApp:SetWindowColor(-1, 0, 165, 165);
  else
    wtApp:SetWindowColor(-1, 128,128,128);
  end;
else
  return 1; -- Triggers a post key process call
end;
```

Note : This feature works only for users scripts called with an assigned key (and *not* with embedded overridden scripts).

- Scripts can now be called from a CW or a RTTY message. You must use the #SCRIPTNAME(ARGUMENT) notation. The argument (and parenthesis) are optional. The script will be called synchronously, but is executed in the main thread, meaning that it is not blocking the CW/RTTY stream.
- New feature in Options / Script Editor configuration : Allows to use any external text editor to edit scripts. The default text editor is a custom package of SciTE (Scintilla Text Editor - free and open source) available on our repository

[http://download.win-test.com/utls/SciTE\\_for\\_Win-Test.zip](http://download.win-test.com/utls/SciTE_for_Win-Test.zip)

Unzip the package and move the entire SciTE folder in the Win-Test installation directory.

- YO DX Contest : Rules 2009 : In mixed mode, a station can be worked in both modes. Tnx N2YO.
- Tools / Check log for possible bad exchanges : When the contest do not use serial numbers, use the QSO index in the report remarks. Tnx F1HAR @ TM0HQ.

- Keys redefinitions : The Pause and Scroll-Lock keys can now be used. Be warned that Ctrl-Scroll-Lock and Ctrl-Pause (that are considered as "identical" by the system) are used by Windows to cancel dialogs. Thus, it is advisable to not use them for key redefinition.

## Release information (4.1.0) (August 8, 2009)

### New Features

- IOTA contest: "Search for possible bad exchanges" (tools menu) implemented.
- Rotator Azimuth orders are now based on the locator instead of the DXCC on 50 MHz and above. On 50 MHz and 70 MHz, if the locator field is empty in the log, then the azimuth is computed against the DXCC prefix.
- New text commands RUNSP/NORUNSP and RUNSPON/RUNSPOFF to enable or not the RUN/S&P switching. Tnx N6TV.
- New contest files : You can now customize the file name and sub dir formats. See Options / Log / New contest files properties... Tnx N6TV.
- IOTA contest : Default IOTA reference is now guessed, according to the new CTY\_IOTA.DAT file (must be in the countryFiles directory). This file is based on DXCC countries, callsign prefixes, call areas and oblasts.
- IOTA contest : Check mult wnd (F10) : IOTA references are now autocompleted for check during QSO entry.
- New File menu items to explore more easily several WT-related directories. Tnx F5VIH/SV3SJ and N6TV.
- DX Window (Alt-A) : Spot can be now passed to the secondary radio or the non-active radio. Tnx DL8WAA.
- M2/Orion rotators added in wtRotators. Tks IK0HBN.
- The RRTC Cabrillo files are now following the version 3 specs. And the contest name is modified as "OZCHR". Tnx F5VIH/SV3SJ.
- CW and RTTY msgs enlarged to 120 characters.
- Extra information files : Multiple spaces or tabs can now separate the callsign from the data. Tnx G0ORH.
- New File dialog : Ensures the validity of the entered file name. Tnx DJ7MGQ.
- ESM : S&P : When the entered callsign is a dupe, WT now blocks call. To override this behaviour, use F4 to call and F2 to send exchange (by default). Tnx GW3NJW.

- VHF+ contests : Mode is now displayed in the main log wnd if the contest has been set to handle several modes (Mixed or All modes). Tnx DK2ZF and DL5NAH.

## Bugfixes

- The displayed azimuth in the Rotator Window could be wrong in the "Stacks" and "Rotors" tabs.
- EUHF : Statistics window (Ctrl-F9) limited to one day. Tnx F5VIH/SV3SJ.
- IOTA contest : When an invalid IOTA was entered, clearing the field afterwards wasn't clearing the '?' flag.
- Contest Recorder:
  - ◆ Infinite loop in MP3 file rotations. Tks DD5FZ.
  - ◆ Memory Leak using LAME encoder.
  - ◆ MP3 Codec enumeration in the player. WT was not always detecting the appropriate Codec.
  - ◆ Playback with Windows VISTA. Note that the LAME Codec is an Encoder Codec only.
- When radios were swapped (\*), the ESM QSO status was somewhat messy.
- For some contests, the letters for cut numbers were inappropriately translated.
- After a WT v3 file conversion, the main window caption was not updated.
- MP3 files information : The file date was off by one month. Tnx F5VIH/SV3SJ.
- Cabrillo Import : The station name for all worked QSO was CABRILLO. Now, it uses the name entered in the Contest Settings dialog. Tnx F5VIH/SV3SJ.
- Callsign text color wasn't reset after F11 or empty callsign if the callsign check wasn't automatic. Tnx DJ0ZY.
- Delete QSO : Several structures inconsistencies fixed when a Q was deleted in the middle of the log.
- In REG1TEST exports (European Standard File for V/UHF Contests), QSO logged in mode different than CW or SSB was not well formatted. Tks DL5NAH.
- Options / Log / Colors... menu was broken. Tnx F5LIW.
- Check Country wnd (F10) : Sun status bars now display "NO DATA" when SS and SR are not computed (JW, JX etc.). Tnx DJ0ZY.
- (Task #245) Network advanced settings : The Bridgehead setting was not saved. Tnx KL7RA and N6TV.
- Opening a .wtb file in the command line, by drag'n'drop or a double-click on it was starting an infinite loop. Tnx N6TV.

## Release information (4.0.1) (June 30, 2009)

### Bugfixes

- Options / Toolbar setting was ignored on startup. Tnx N6TV.
- ESM was broken. Tnx F1HAR.
- Registration Key was broken.

## Release information (4.0.0) (June 26, 2009)

First release of Win-Test version 4

Minimum requirements : WinXP (2k not tested but may work - feedbacks welcome). PIII 500 MHz - 64 MB RAM - 800 x 600 screen res.

### New Features

Summary of the new features:

- Rotators Controls
- Integrated MP3 contest recorder and player: Use the Options / MP3 configuration to set the audio device that will record and play the file, the various sampling and bit rate settings. You can also set a maximum filesize. Over this limit, additional files will be automatically created. To start recording click on the record button of the window (a blinking red square will be displayed in the clock window too). Once the contest is over, click on the record button again to stop recording. Now, you can browse your log with usual arrow keys and to listen to a specific Q but clicking the Play button or use the AltGr-Enter combination (some keyboard do not have an AltGr key, so use Ctrl+Alt instead). You can also go back and forward with the adapted buttons or use AltGr-Left and Right. To pause/play, you can use the AltGr-Space combination.
- ESM (Enter Sends Message): Enabled/Disabled by the Tools/Data entry/ESM Enabled menu. You can also use the ESM/NOESM or ESMON/ESMOFF text commands. It relies on the following messages assignation :

```
F1 : CQ
F2 : Sent report
F4 : Mycall
F5 : Logged callsign ($LOGGED)
F7 : ? (or "Again ?" in phone)
INSERT : Callsign + sent report
PLUS : TU + enter Q
```

When the ESM is enabled, as the return key \*can't\* be used anymore to log silently a QSO, the key combination Ctrl+Plus has been introduced and added for this purpose.

- Variable speed for the integrated voice keyer : An exclusive Win-Test feature! You can play your voice files at a different speed (between -20% and +70%) from the original recording speed. Record



## Win-Test Wiki

your voice files at normal speed, and use Alt-F9/F10 (as in CW mode) to play them at a different speed. The speed is displayed at the bottom of the (Rate) Alt-R window.

- On the fly callsign pattern check based on the K1TTT callsign.pat file (over 400 rules applied today). Use the Tools / Data entry / Callsign check menu option. You are encouraged to report the author any mistakes or improvements of this file (k1ttt@arrl.net). The file is located in the cfg directory (see below).
- Improved F10 window with graphical indication of the sun status on both sides of the QSO.
- Keyboard mode (Alt-K) enhanced. The backspace is not supported yet and replaced by "E E " like you do when you use a regular key.
- Data (.wt4) and notes (.not) files can be transferred thru the WT network without needing any file or directory sharing. Very convenient to gather all logs in a multi-stations environment once the contest is over. Use the Tools / Download thru the network... menu.
- Enhanced compatibility with Vista and Seven (Auxiliary and ini files are now stored in directories these OS accept with no additional rights:

```
Windows XP : Documents and Settings\All users\Application Data\Win-Test\  
Windows Vista : ProgramData\Win-Test\
```

Note that these directories may be hidden by Windows Explorer. Check the Folders Options of Windows Explorer.

Several sub-directories are created and used by Win-Test. Their names are self-explanatory.

## Namespaces

- [Page](#)
- [Discussion](#)

## Variants

## Views

- [Read](#)
- [View source](#)
- [View history](#)

## More

- This page was last edited on 12 April 2023, at 16:55.
- [Privacy policy](#)
- [About Win-Test Wiki](#)
- [Disclaimers](#)



# FAQ:Networking

From Win-Test Wiki

[Jump to navigation](#) [Jump to search](#)

## Contents

- [1 What is the Win-Test network protocol?](#)
- [2 In a networked environment, can we mix different versions of Win-Test?](#)
- [3 UDP error opening socket #10013 and #10038 Errors](#)
- [4 See also](#)

## What is the Win-Test network protocol?

The Win-Test network protocol is used for communication between the computers running Win-Test. It is based on UDP broadcasts ([Wikipedia:User Datagram Protocol](#)). Please see [Networking](#) for information on how to configure networking in Win-Test.

## In a networked environment, can we mix different versions of Win-Test?

No. As usual, you must have the same WT version on every connected computer.

**It is important that ALL computers on the network are running the SAME Win-Test version!** (For example do **not** run version 4.0.7 on one computer and version 4.1.0 on another.)

## UDP error opening socket #10013 and #10038 Errors

Installation of some HUAWEI HSDPA USB MODEM drivers is known to cause these error messages to appear whenever you try to use Win-Test networking. Please try the following:

- Disconnect the Huawei USB modem
- Uninstall the Huawei modem drivers via Control Panel, Add/Remove programs or the icon supplied with the software, if any
- Delete or rename the **Huawei** sub-directory, if any, found under **C:\Program Files**
- Test Win-test networking
- Reinstall the Huawei modem drivers, but use a [newer software driver](#).

There are reports that a newer driver for the Huawei USB modem may fix the problem. But if you no longer need to use the Huawei device on the Win-Test machine, do not install a new driver.

Please check the value of the following registry key using **Start | Run | regedit** in Windows:

```
HKEY_LOCAL_MACHINE\SYSTEM\CurrentControlSet\Services\AFD\Parameters\DisableAddressSharing  
(REG_DWORD, Value 0,1, Default=0)
```

If it is set to 1, set the value to 0.

Reference: [http://technet.microsoft.com/en-us/library/cc781532\(WS.10\).aspx](http://technet.microsoft.com/en-us/library/cc781532(WS.10).aspx)

See also: <http://lists.f5mzn.org/pipermail/support/2009-December/079147.html>

(thanks DL2ALF)

## See also

- [Networking](#)

## Namespaces

- [Page](#)
- [Discussion](#)

## Variants

## Views

- [Read](#)
- [View source](#)
- [View history](#)

## More

- This page was last edited on 10 December 2016, at 16:06.

- [Privacy policy](#)
- [About Win-Test Wiki](#)
- [Disclaimers](#)



# FAQ:User Interface

From Win-Test Wiki

[Jump to navigation](#) [Jump to search](#)

## Contents

- [1 How can I change the default window layout so that it is the same as it was in the last contest?](#)
- [2 How can I save my CW messages so that they are the same ones I used the last time I entered this contest?](#)
- [3 How do I get the S&P Messages to Work?](#)
- [4 Can I use "Insert Mode" in a serial number or exchange field?](#)
- [5 How can I change the font and background colors?](#)
- [6 How can I change threshold for off-time calculation?](#)
- [7 Is a log transfer between Win-Test and XXX \(put your favorite logging software here\) possible?](#)
- [8 Do I have to set my machine in UTC?](#)
- [9 I want to enter a post-contest log in Win-Test. How can I enter the date and the time of OSO?](#)
- [10 When I try to use the Parallel Port \(LPT1\), I get a message DLPortIO.DLL not loaded or DLPORPIO.SYS not not found](#)
  - ◆ [10.1 Windows NT, Windows 2000, Windows/XP](#)
  - ◆ [10.2 32-bit Windows Vista or Windows 7](#)
  - ◆ [10.3 64-bit Windows Vista, Windows 7, or Windows 8](#)
- [11 There are no messages, but the parallel port still doesn't work](#)
- [12 When using CW with WT, it sometimes chokes. What can I do?](#)
- [13 Can I define a new contest in Win-Test?](#)
- [14 During a contest, can I change a DXCC country "on the fly", like in CT where you say TO5X=FG?](#)
- [15 I have a question. What should I do?](#)
- [16 I asked a question directly to the author and I did not have an answer!](#)
- [17 I would like such and such features!](#)
- [18 Where can I read the archives of this mailing list you do not stop talking about?](#)

## How can I change the default window layout so that it is the same as it was in the last contest?

Win-Test automatically saves the current window layout in the Win-Test binary log file (.wtb or .wt4) whenever you exit. So, each log file can have a different window layout depending on the contest.

To change the *default* window layout used for new logs, see [Options | Windows](#).

To use a different window layout for each contest, copy the old binary file to a new file, e.g.

```
copy wpx07cw.wtb wpx08cw.wtb (for WT version 3)
```

```
copy wpx09cw.wt4 wpx10cw.wt4 (for WT version 4)
```

Then open the new file and use the [CLEARLOG](#) text command to remove all the QSOs.

## How can I save my CW messages so that they are the same ones I used the last time I entered this contest?

Win-Test automatically saves the current CW messages in the Win-Test binary log file (.wtb or .wt4) whenever you exit. So, each log file can have a different set of CW messages depending on the contest.

But the *default* CW messages used for new logs are hard coded and cannot be changed.

However, once you have the messages set for a particular contest, copy the old binary file to a new file, e.g.

```
copy wpx07cw.wtb wpx08cw.wtb (for WT version 3)
```

```
copy wpx09cw.wtb wpx10cw.wtb (for WT version 4)
```

Then open the new file and use the CLEARLOG text command to remove all the QSOs. The programmed CW messages are retained and will be the same as the ones you had in the original file.

## How do I get the S&P Messages to Work?

First, from the menu select Tools | Data Entry | Enable Run/S&P Switching.

Then press [**Ctrl-Tab**] to toggle between RUN and S&P modes. The current mode is displayed in the Clock Window.

## Can I use "Insert Mode" in a serial number or exchange field?

No, insert mode only works in the callsign field.

This part of Win-Test data entry works exactly the same as CT. There is no command or option to change it. Note that the [**Insert**] key is dedicated to another function (send callsign + exchange).

In the callsign field, where one is often missing part of the prefix or suffix, Win-Test accepts input in "insert mode", so that you can easily insert missing characters with minimal typing (and use the [**Home**] and [**End**] keys as well).

But in all the exchange fields, where it is more common to just need to correct a single digit or letter, Win-test accepts characters in "overtyp mode". Overall this means less typing than if data entry was done the same way in both fields.

Workaround: just type "?" for the missing number or exchange, e.g. **12?2**. Then when you press the space bar (twice of course), the cursor will jump right to the "?" and you'll be able to type over the "?" to insert the missing digit.

## How can I change the font and background colors?

Use the context menu (right-click) for each window. It also works for the main log window (but you have to

select the Log item first). You can also use your mouse wheel while holding the **Ctrl** key to modify the font size on the fly (a la Mozilla/Firefox).

## How can I change threshold for off-time calculation?

Open the rate Window (**Alt-R**), open the context menu (right-click on the rate window), there is a menu point `Offtime | calculation threshold`. The threshold can be set to 10, 20, 30, 40, 50, 60 or a custom value between 1 and 120 minutes.

## Is a log transfer between Win-Test and XXX (put your favorite logging software here) possible?

If your logging software allows imports from ADIF (Amateur Data Interchange Format) files, there should be no problem. If it does not manage it, ask the author of YOUR favorite logging software to support it, or use another software.

If you wish to go from XXX to Win-Test, use the Cabrillo import function.

## Do I have to set my machine in UTC?

No, Win-Test perfectly manages to calculate UTC time from the time settings in Windows. Make sure, however, that you have set the correct time zone for your location.

In a networked environment, one of the computers should be the assigned time master and each of the connected machines will be synchronized with that computer. This sync feature helps to avoid irritations during the operation.

If you inadvertently had your computer set to an incorrect time or date, you have a chance to correct this after the contest. Please see [Time Shift](#) for further details.

## I want to enter a post-contest log in Win-Test. How can I enter the date and the time of QSO?

Win-Test is not really adapted to that. You should try to type while contesting. You should make it very quickly. However, it is possible to use the `Edit | Date and time of the QSO` menu (**Alt-F** shortcut).

## When I try to use the Parallel Port (LPT1), I get a message DLPortIO.DLL not loaded or DLPORTIO.SYS not not found

### Windows NT, Windows 2000, Windows/XP

If you use Windows NT/2000/XP, check to see if the following files are present:

```
C:\Windows\System32\DLPortIO.dll  
C:\Windows\System32\drivers\dlportio.sys
```

If not,

Download and run <http://download.win-test.com/port95nt.exe>

to install them.

## 32-bit Windows Vista or Windows 7

If you use **32-bit** Windows Vista or Windows 7, see above, but do the following *before* running port95nt.exe:

1. In Windows Explorer, right-click on **port95nt.exe**
2. Click **Properties**
3. In the popup, click the **Compatibility** tab
4. Check the box next to **Run this program in compatibility mode for**
5. In the drop-down list, select **Windows XP Service Pack 3**
6. Check the box next to **Run as administrator**
7. Click **OK**

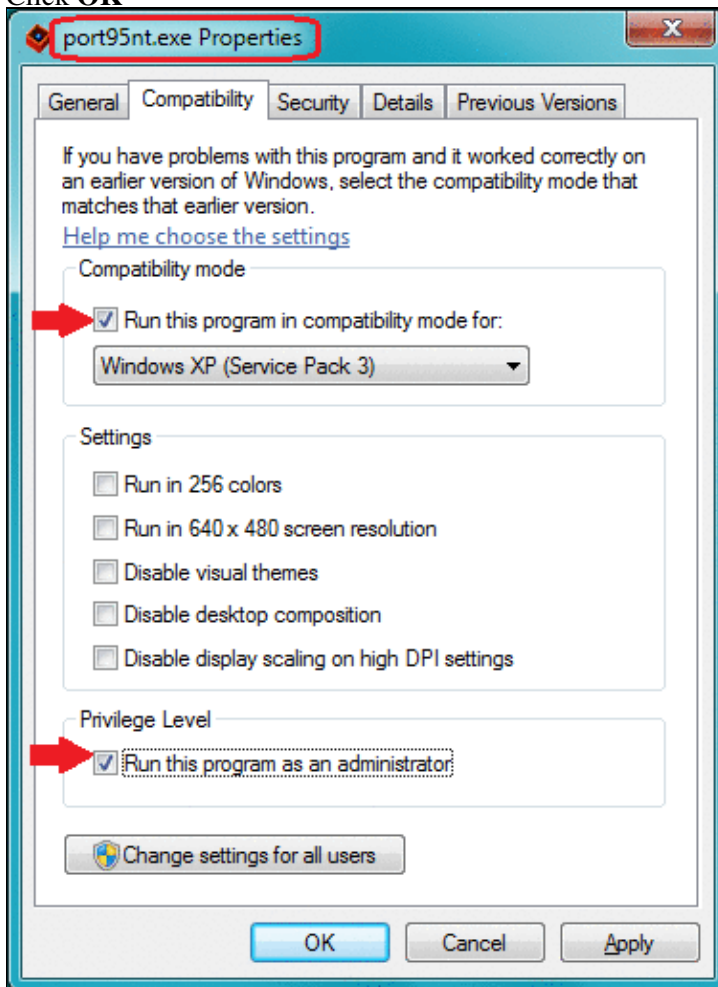



## 64-bit Windows Vista, Windows 7, or Windows 8

If you use **64-bit** Windows Vista, Windows 7, or Windows 8, do *not* use port95nt.exe. Instead,

Download InpOutBinaries\_1500.zip from <http://www.highrez.co.uk/scripts/download.asp?packag>

1. Unzip **InpOutBinaries\_1500.zip** to a temporary directory like C:\temp.
2. Run C:\temp\Win32\InstallDriver.exe to install C:\Windows\System32\drivers\inpoutx64.sys
3. Manually copy **C:\temp\Win32\inpout32.dll** to your Win-Test installation directory, but rename it to DLPortIO.dll, e.g. from a Windows command prompt

```
cd "\Program Files (x86)\Win-Test\"
copy \temp\Win32\inpout32.dll DLPortIO.dll
```

## There are no messages, but the parallel port still doesn't work

Use [Options | Configure Interfaces ...](#). Make sure that the **LPT** check box is checked. Press the **[Configure...]** button next to the LPT check box. Verify that the parallel port hex address is set correctly for your system. See the [Printer Ports](#) for information on how to determine the hex address being used by your computer.

Note: USB-to-Parallel adapters will not work. Some PCI parallel adapters may also not work.

## When using CW with WT, it sometimes chokes. What can I do?

It is advised in this case to stop the execution of some programs which are not essential to you during the contest. In particular antivirus software. Furthermore, under some OS (WinNT, Win2K or WinXP), logging with an administrator account is advised.

## Can I define a new contest in Win-Test?

Currently, it is not possible. Win-Test is designed to fit contests to the closest. Each competition has its specifics, and rather than to make an universal tool, the author prefers WT to support fewer contests, but better than the other existing software.

## During a contest, can I change a DXCC country "on the fly", like in CT where you say TO5X=FG?

This feature is not available in Win-Test at this time. However, if you are on-line, you may download a new version of the country file from within Win-Test with a single mouse click. Please see the [Menu:Options#Data\\_files](#) chapter for further details.

## I have a question. What should I do?

Use the [mailing list](#).

## I asked a question directly to the author and I did not have an answer!

Bad choice. Use the [mailing list](#) instead.

## I would like such and such features!

Suggest them! Use the [mailing list](#). We will then see what we can do...

## Where can I read the archives of this mailing list you do not stop talking about?

You can view the public archives of the [mailing list](#) at the following URL:  
<http://www.f5mzn.org/pipermail/support/>.

To search the archives, do a Google search like this:

```
site:lists.f5mzn.org wt-support search-argument
```

where *search-argument* describes what you are searching for, or just [click here](#).

See [Mailing List](#) for more info on searching and subscribing.

## Namespaces

- [Page](#)
- [Discussion](#)

## Variants

## Views

- [Read](#)
- [View source](#)
- [View history](#)

## More

- This page was last edited on 9 December 2016, at 23:34.
- [Privacy policy](#)
- [About Win-Test Wiki](#)
- [Disclaimers](#)



# FAQ:Licensing

From Win-Test Wiki

[Jump to navigation](#) [Jump to search](#)

## Contents

- [1 I bought Win-Test on the web with my PayPal account since several days, but I haven't received any CD-ROM ! What's wrong ?](#)
- [2 I bought Win-Test on the web with my PayPal account since several days, but I haven't received my registration key ! What's wrong ?](#)
- [3 I received your automatic email, but my registration key is not in ! What's wrong ?](#)
- [4 I went to your registration page but the form requires a computer code. I totally dismantled my computer and I can't find it. Where is it located ?](#)
- [5 I am hosting a multi-op station with several machines. Do I need to buy a licence for each of them ?](#)
- [6 I personally own a Win-Test licence. Can I install Win-Test using my identifiers on the computer of my local radio club ?](#)
- [7 I personally own a Win-Test licence. Can I install Win-Test using my identifiers on the computer brought by my mates who come home for a multi-op effort ?](#)
- [8 I have registered the Win-Test licence to my personal call. Can I use it with a different callsign, like a vanity one?](#)
- [9 My local radio-club owns a Win-Test licence. As a member of this club, can I use its identifiers to install and register Win-Test on my own computer?](#)
- [10 I have registered Win-Test on my desktop computer. Can I register it on my notebook \(or my other computer\), and if so, how to do it?](#)
- [11 I just upgraded to Win-Test V3. But my license is gone?](#)
- [12 Can I have a registered WT2 and a registered WT3 in the same installation directory?](#)
- [13 I asked a question directly to the author and I did not have an answer !](#)
- [14 Where can I read the archives of this mailing list you do not stop talking about ?](#)
- [15 See also](#)

## **I bought Win-Test on the web with my PayPal account since several days, but I haven't received any CD-ROM ! What's wrong ?**

Actually, you will **never** receive any CD-ROM. Win-Test is **only** downloadable on our web site. Win-Test is not available on CD-ROM or any other media.

## **I bought Win-Test on the web with my PayPal account since several days, but I haven't received my registration key ! What's wrong ?**

Once our server has received your payment, it automatically sends an email with instructions to register your copy of Win-Test. This email is sent to the email address you provided on our purchase form. First, check you have received this email, by checking your inbox and your junk/spam box (if any). Some antispam software discard this email because it is written in three different languages. Secondly, read it carefully. It explains how to register your copy of Win-Test.

## **I received your automatic email, but my registration key is not in ! What's wrong ?**

You should have carefully read this email. It explains that you have to go to the [registration page](#) on our website, and fulfill this form to request a key. Our server will then send you a personalized registration key to the email address you provided when you bought Win-Test.

## **I went to your registration page but the form requires a computer code. I totally dismantled my computer and I can't find it. Where is it located ?**

Actually, you can re-assemble it now. As the instructions email and the registration page clearly indicate, this computer code is located in the registration dialog you will find in the [Help | Register software...](#) menu of Win-Test. Save the planet, always read the instructions !

## **I am hosting a multi-op station with several machines. Do I need to buy a licence for each of them ?**

No. One licence is enough. The purchase of Win-Test authorizes his owner to use it on every machine he owns. But you will have to request a registration key for each computer.

## **I personally own a Win-Test licence. Can I install Win-Test using my identifiers on the computer of my local radio club ?**

No. You can bring your own computer (laptop) if you wish to operate from the radio club, even using the radio club's callsign, but you cannot install Win-Test on a computer belonging to the radio club, using your personal Win-Test account (licence). To install Win-Test on the (or one of the) computer(s) of the radio club, the radio club itself must have its own licence.

## **I personally own a Win-Test licence. Can I install Win-Test using my identifiers on the computer brought by my mates who come home for a multi-op effort ?**

No. You are only allowed to install and register Win-Test on your own computer(s). Your mates need a personal licence to install and use Win-Test on their own computers.

## **I have registered the Win-Test licence to my personal call. Can I use it with a different callsign, like a vanity one?**

Yes. The operating callsign can be different to the registered callsign. When you set up your contest, you can choose here any callsign you will operate with.

## **My local radio-club owns a Win-Test licence. As a member of this club, can I use its identifiers to install and register Win-Test on my own computer?**

No. The radio-club licence allows to register Win-Test on the computers owned by this club only. If you need to register Win-Test on your own computer, you must buy a personal licence.

## **I have registered Win-Test on my desktop computer. Can I register it on my notebook (or my other computer), and if so, how to do it?**

As you own both computers, you are allowed to install Win-Test and register it. Just request another key for your notebook on our website. Obviously, as the computer code are different for each computer, the registration key you will receive will be different.

## **I just upgraded to Win-Test V3. But my license is gone?**

You have to enter a new registration Key for Win-Test V3. If you would like to have Win-Test V2 installed at the same time, You must install V3 into a different directory so you can have both registration keys installed.

## **Can I have a registered WT2 and a registered WT3 in the same installation directory?**

We totally discourage it. If you want to keep and use a v2, and also use a v3, it is mandatory to install each of them in a different directory. If not, after registering the v3, your v2 will be automatically un-registered. Of course, if you decide not to keep a v2, you can install your v3, and register it, in the same existing directory.

## **I asked a question directly to the author and I did not have an answer !**

Bad choice. Use the mailing list instead.

## **Where can I read the archives of this mailing list you do not stop talking about ?**

You can read the public archives of the mailing list here: <http://www.f5mzn.org/pipermail/support/>

## **See also**

- [Win-Test licensing on http://www.win-test.com](http://www.win-test.com)

[Back to Main Page](#)

## Namespaces

- [Page](#)
- [Discussion](#)

## Variants

## Views

- [Read](#)
- [View source](#)
- [View history](#)

## More

- This page was last edited on 18 November 2007, at 17:26.
- [Privacy policy](#)
- [About Win-Test Wiki](#)
- [Disclaimers](#)

